

Fisher-Price®

Kick & Play Bouncer



Model Number: B8865

IMPORTANT! KEEP FOR FUTURE REFERENCE.

Please read these instructions before assembly and use of this product.

Adult assembly is required.

Tool required for assembly: Phillips screwdriver (not included).

Requires one LR20 ("D") **alkaline** battery (not included) in the soothing unit.

Requires three LR6 ("AA") **alkaline** batteries (not included) in the toy bar.

www.fisher-price.com

Warning



WARNING

To prevent serious injury or death:

- It is dangerous to use this reclined cradle on an elevated surface.
- Never use on a soft surface (bed, sofa, cushion) since bouncer can tip over and cause suffocation in soft surfaces.
- Never use as a carrier or lift while child is seated.
- Always use the restraint system.
- Never leave child unattended.
- Never use as a car seat.
- Not recommended for children who can sit up by themselves (6 months approximately, until 9 kg/20 lb).

Consumer Information

Occasionally a consumer may experience a problem with one of our products. If this should happen, please call us, rather than return this product to the store. Usually, we can solve the problem over the telephone or send you replacement parts. Please call 01628 500303

or write to: Mattel UK Limited
Mattel House
Vanwall Business Park,
Vanwall Road
Maidenhead, Berkshire SL6 4UB

Parts

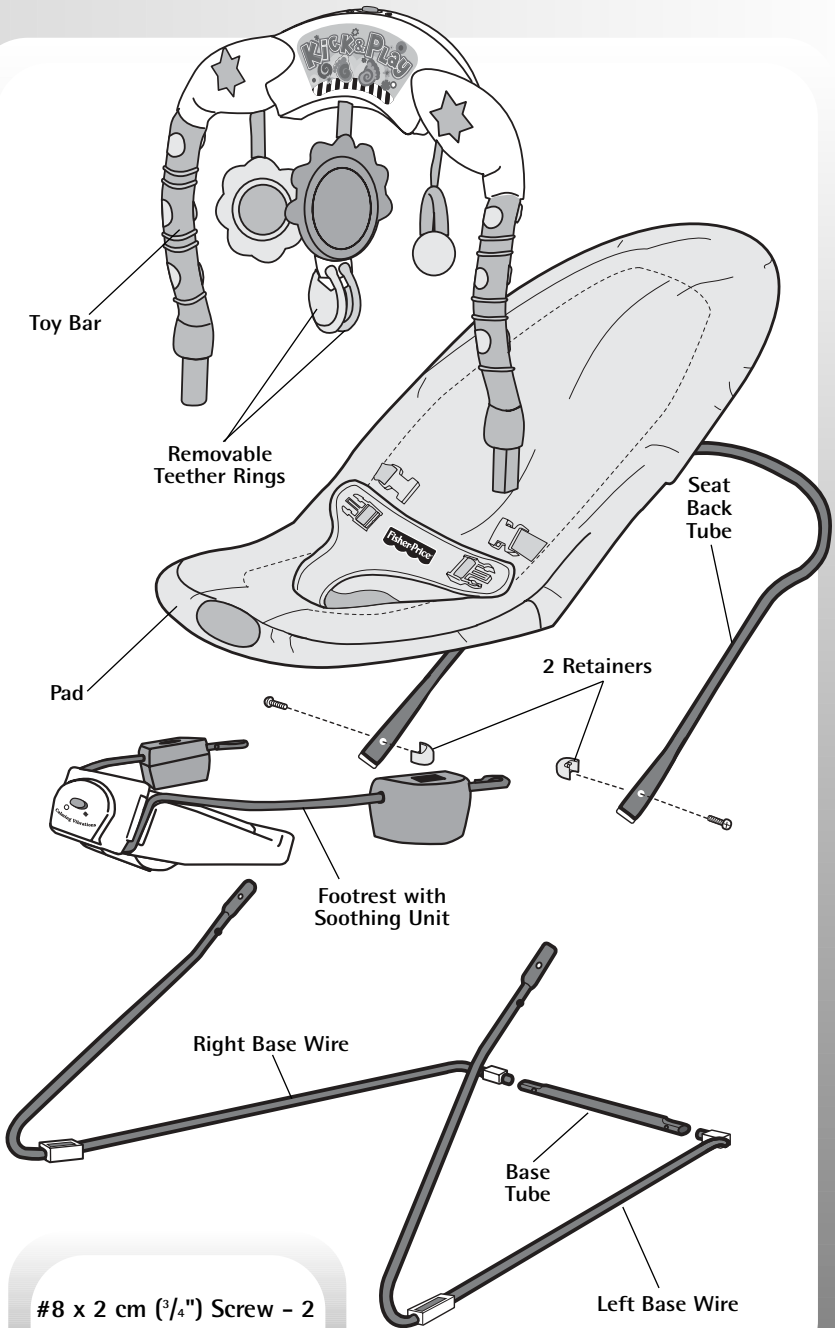

#8 x 2 cm (3/4") Screw - 2



Shown Actual Size

Battery Installation

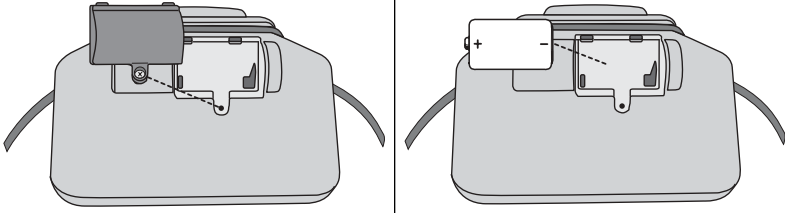

Soothing Unit

- Loosen the screw in the soothing unit battery compartment door with a Phillips screwdriver. Remove the battery compartment door.
- Insert one LR20 ("D") **alkaline** battery.
- Replace the battery compartment door. Tighten the screw with a Phillips screwdriver. Do not over-tighten.

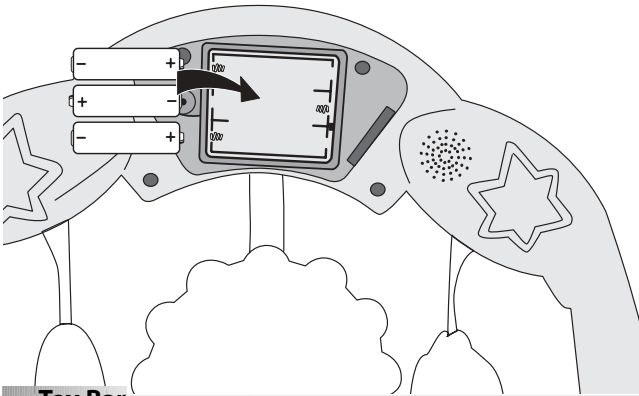

Toy Bar

- Loosen the screw in the toy bar battery compartment door with a Phillips screwdriver. Remove the battery compartment door.
- Insert three LR6 ("AA") **alkaline** batteries.
- Replace the battery compartment door. Tighten the screw with a Phillips screwdriver. Do not over-tighten.

Battery Safety Information

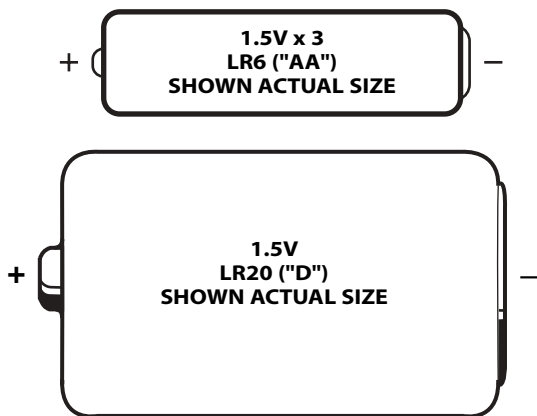

Batteries may leak fluids that can cause a chemical burn injury or ruin your product. To avoid battery leakage:

- Do not mix old and new batteries or batteries of different types: alkaline, standard (carbon-zinc) or rechargeable (nickel-cadmium).
- Insert batteries as indicated inside the battery compartment.
- Remove batteries during long periods of non-use. Always remove exhausted batteries from the product. Dispose of batteries safely. Do not dispose of batteries in a fire. The batteries may explode or leak.
- Never short-circuit the battery terminals.
- Use only batteries of the same or equivalent type, as recommended.
- Do not charge non-rechargeable batteries.
- Remove rechargeable batteries from the product before charging.
- If removable, rechargeable batteries are used, they are only to be charged under adult supervision.

Assembly

IMPORTANT! Before assembly or each use, inspect this product for damaged hardware, loose joints, missing parts or sharp edges. DO NOT use if any parts are missing, damaged or broken. Contact Mattel for replacement parts and instructions if needed. Never substitute parts.



CAUTION

This package contains small parts
in its unassembled state.
Adult assembly is required.

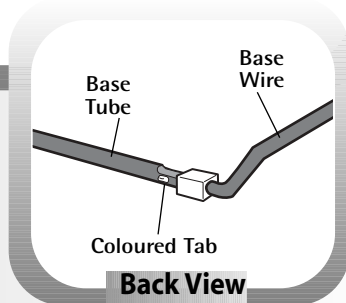
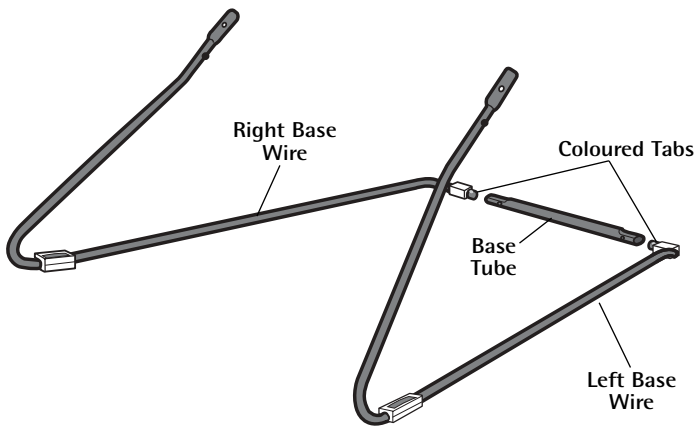

- 1
- Place the base tube on a flat surface as shown.
 - Position the left and right base wires as shown. Note the locations of the coloured tab on the left and right base wires.
 - Fit the left base wire into the base tube.
 - Fit the right base wire into the base tube.
 - **Make sure both coloured tabs on the base wires are visible through the holes in base tube.**

Assembly

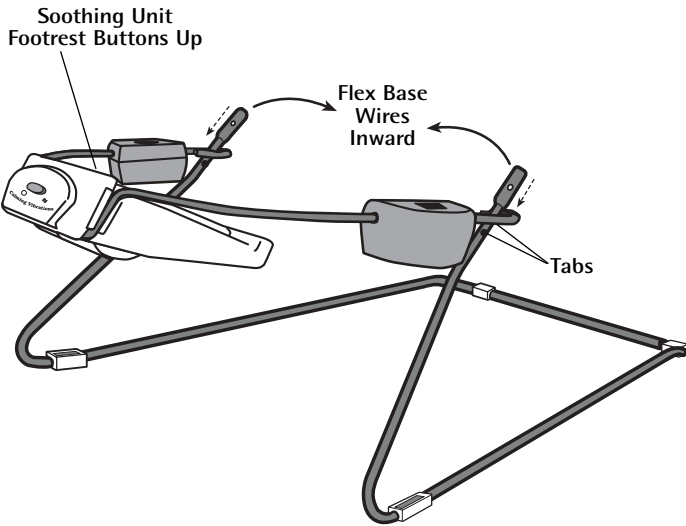

- Position the footrest so that the soothing unit buttons are upright.
- While flexing the base wires toward each other, hook the footrest onto the ends of the base wires.
- Push the footrest **down completely to the tabs** on the base wires.

Assembly

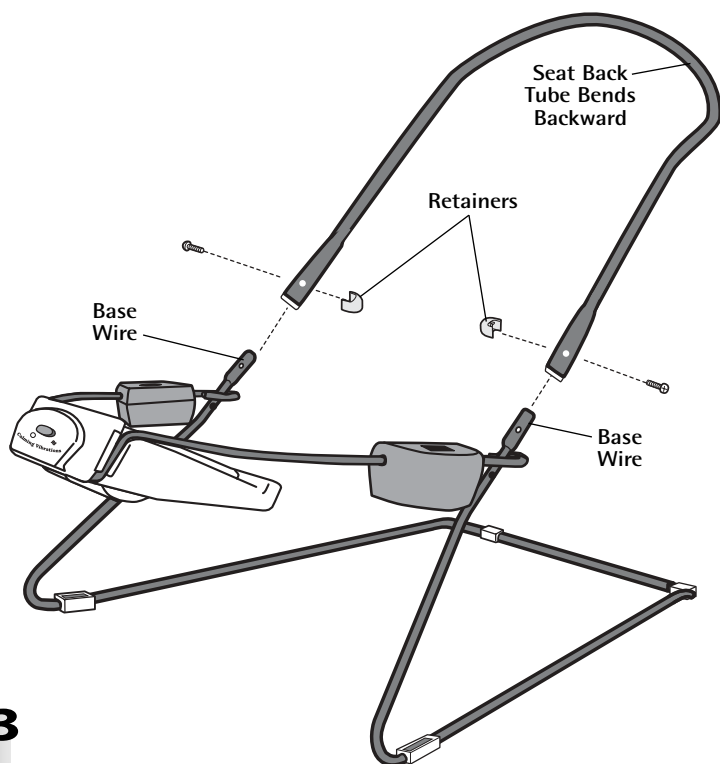

3

- Position the seat back tube so that it bends backward.
- Fit the seat back tube completely onto the base wires. Make sure the hole in each end of the seat back tube aligns with the hole in each base wire.
- Fit a retainer (rounded side inward) to one end of the seat back tube.
- Insert a screw through the **outside** hole in the seat back tube and into the retainer.
- While holding the retainer in place, tighten the screw with a Phillips screwdriver. Do not over-tighten.
- Repeat this procedure to secure the other side of the seat back tube to the base assembly using the remaining retainer and screw.

Assembly

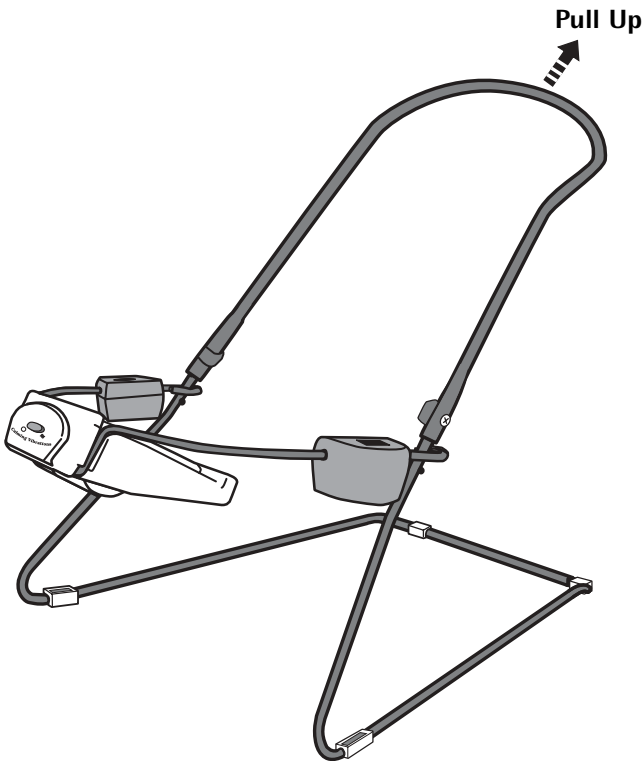

4

- Pull up on the seat back tube to be sure it is secure. If you can remove either end of the seat back tube, you have not assembled it correctly. Remove the screws and retainers. Re-read and repeat Assembly steps 3 and 4.

Assembly

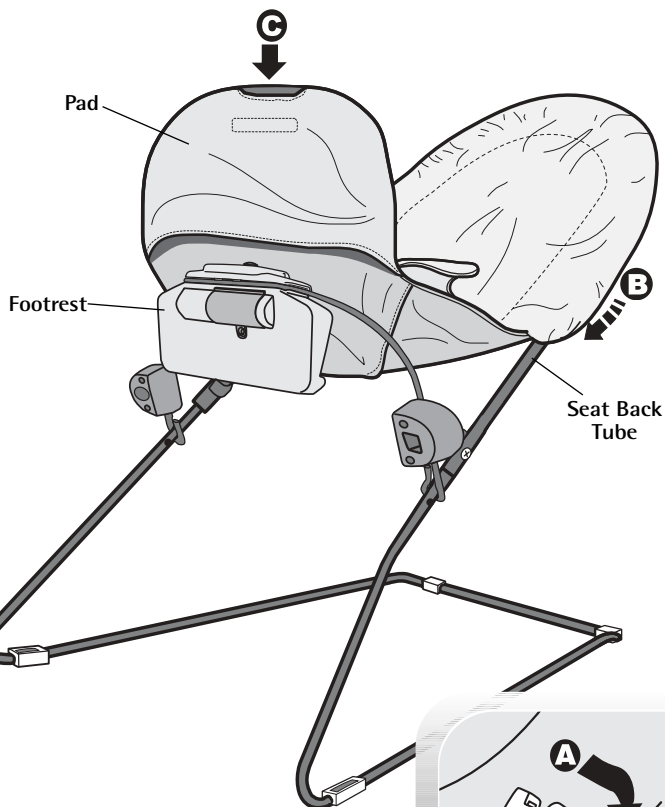

5

- Unbuckle the restraint belts from the restraint pad. Push the restraint belts back through the slots in the pad **A**.
- Fit the pad upper pocket onto the seat back tube **B**.
- Lift the footrest. Fit the pad lower pocket onto the footrest **C**. Lower the footrest.

Assembly

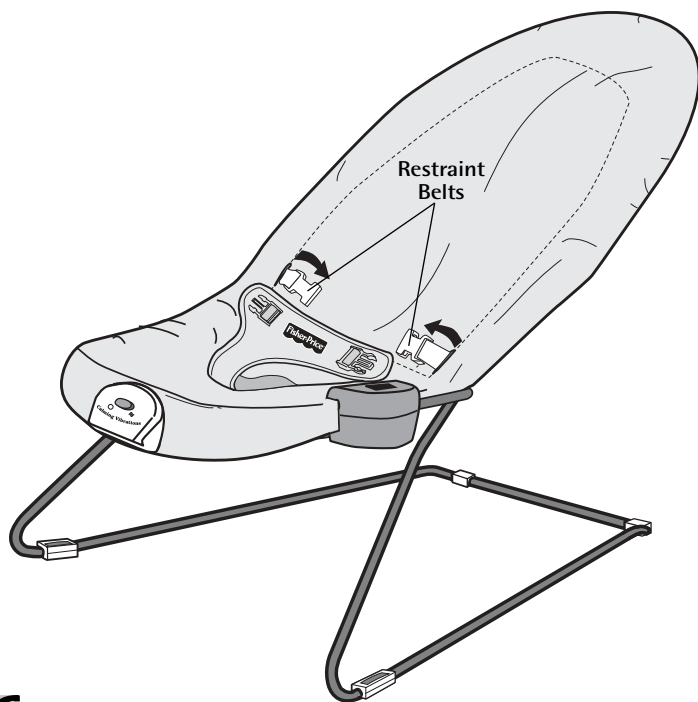

6

- Fit both restraint belts back through the pad slots, as shown.

Assembly

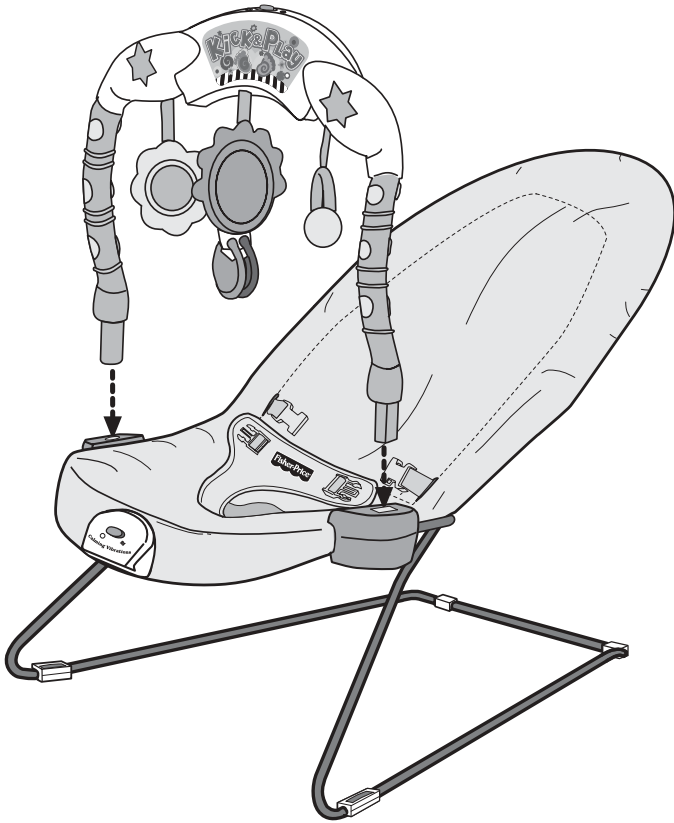

7

- Fit the ends of the toy bar into the sockets in the footrest.

Hint: The square end of the toy bar fits into the square socket and the circular end of the toy bar fits into the circular socket.

Assembly is now complete.

- The toy bar is removable. Simply lift up to remove.

Set-Up & Use

WARNING

To prevent serious injury or death:

- It is dangerous to use this reclined cradle on an elevated surface.
- Never use on a soft surface (bed, sofa, cushion) since bouncer can tip over and cause suffocation in soft surfaces.
- Never use as a carrier or lift while child is seated.
- Always use the restraint system.
- Never leave child unattended.
- Never use as a car seat.
- Not recommended for children who can sit up by themselves (6 months approximately, until 9 kg/20 lb).

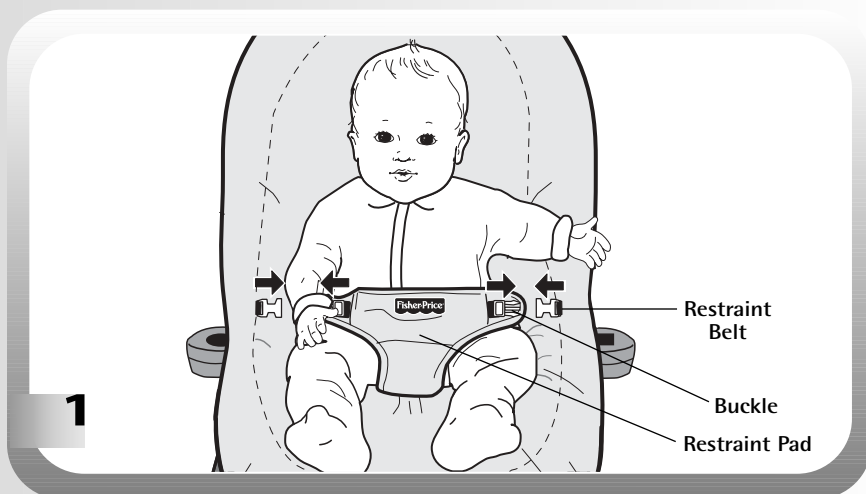

Securing Your Child

- If the toy bar is attached, remove it before placing your child in the seat.
- Place your child in the seat. Position the restraint between your child's legs.
- Fasten both restraint belts to the buckles on each side of the restraint pad.
Make sure you hear a "click" on both sides.
- Check to be sure the restraint is securely attached by pulling it away from your child. The restraint should remain attached.
- Attach the toy bar, if desired (see Assembly step 7).

Set-Up & Use

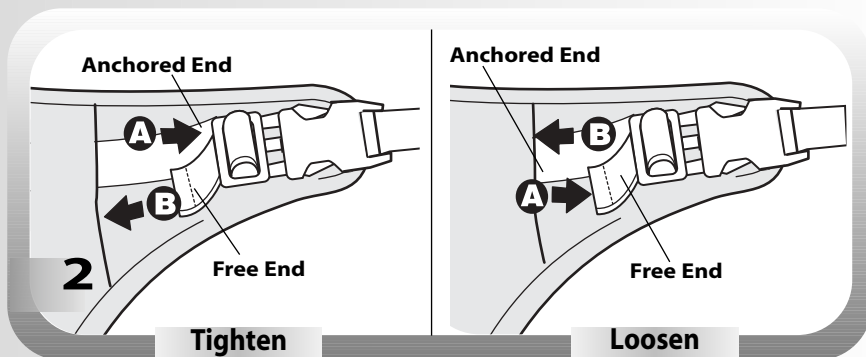

To tighten the belts:

- Feed the anchored end of the belt up through the buckle to form a loop **A**.
- Pull the free end of the belt **B**.
- Repeat this procedure to tighten the other belt.

To loosen the belts:

- Feed the free end of the belt up through the buckle to form a loop **A**. Enlarge the loop by pulling on the end of the loop toward the buckle.
- Pull the anchored end of the belt to shorten the free end of the belt **B**.
- Repeat this procedure to loosen the other belt.

Please Note: After adjusting the belts to fit your child, make sure you pull on them to be sure they are securely fastened.

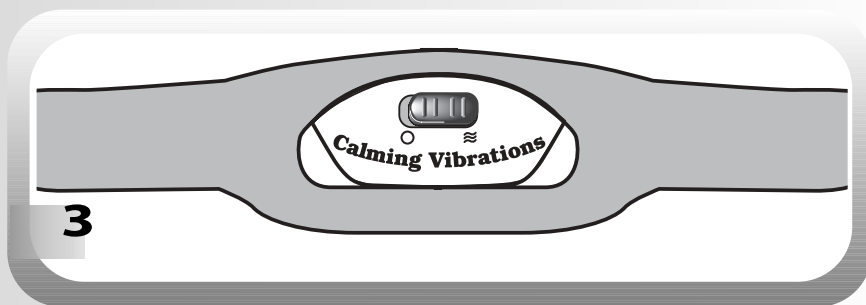

Calming Vibrations

- Make sure your child is properly secured in the seat.
- To turn vibrations on, slide the power switch on the soothing unit to the **on** position \approx .
- To turn vibrations off, slide the power switch on the soothing unit to the **off** position \circ .

IMPORTANT! If vibrations from the soothing unit become faint, or if there are no vibrations, remove the battery from the soothing unit and dispose of it properly. Replace the battery with a new LR20 ("D") **alkaline** battery.

Set-Up & Use

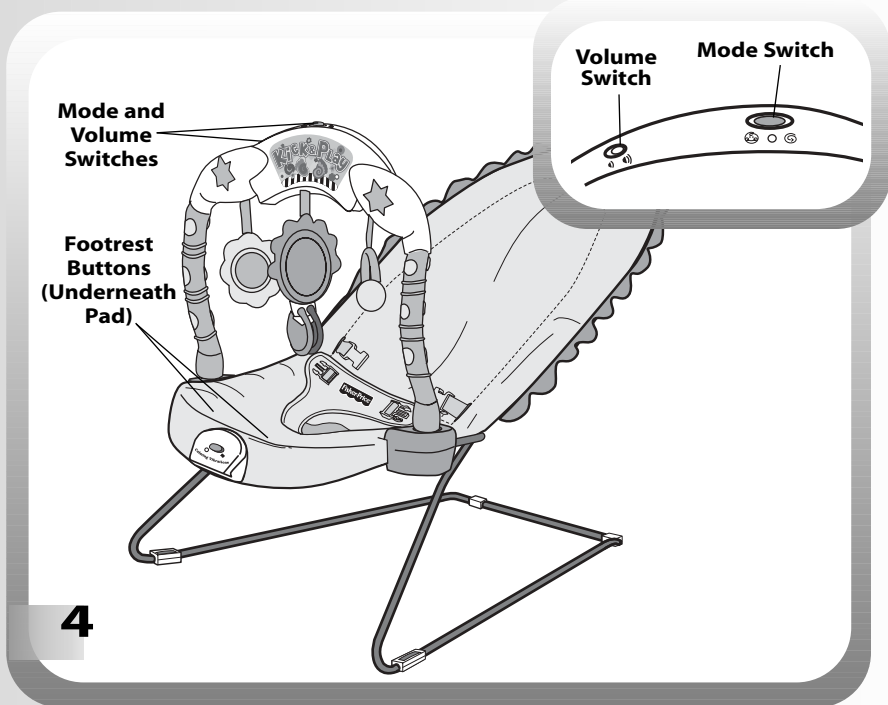

4

Sounds and Lights

👶 Baby Activated

- Slide the **mode switch** to 🧒 for **baby activated** mode.
- When baby **kicks a footrest button**, baby is rewarded with sound effects and chasing lights. After baby kicks the buttons several times in a row, baby enjoys a musical tune and twinkling lights.

👤 Parent Activated

- Slide the **mode switch** to 👤 for **parent activated** mode. Baby enjoys 10 minutes of music and a light show.

○ Off

- Slide the toy bar switch to ○ to turn off sounds and lights.
- Slide the **volume switch** to 🔊 for low volume; 🔊) for high volume.

IMPORTANT! If lights become dim or sound becomes faint, remove the batteries from the toy bar and dispose of properly. Replace the batteries with three, new LR6 ("AA") **alkaline** batteries.

Set-Up & Use

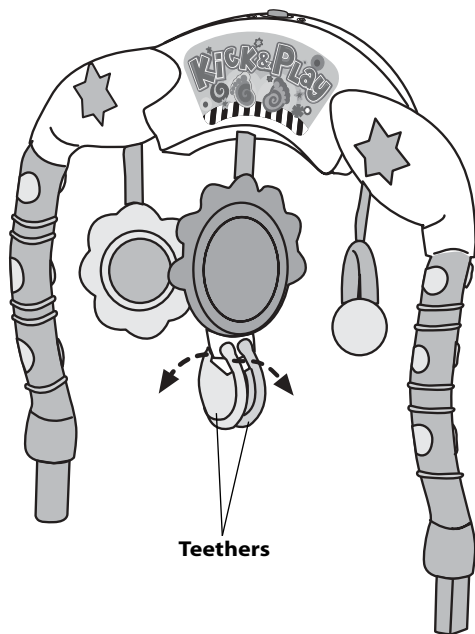

5

- The teethers are removable from the toy on the toy bar. Simply twist the ends of each teether slightly to remove them from the centre toy.

Care

The pad is machine washable. Wash the pad separately in cold water on the gentle cycle. Do not use bleach. Line dry only. The frame and toy bar and teethers can be wiped clean using a mild cleaning solution and a damp cloth. Do not immerse the soothing unit or toy bar.

To remove the pad:

- Lift the footrest and remove the pad lower pocket
- Push the restraint belts back through the pad.
- Slide the pad upper pocket off the seat back tube.

To re-assemble the pad:

- Refer to assembly steps 5 and 6.