

## User's Manual

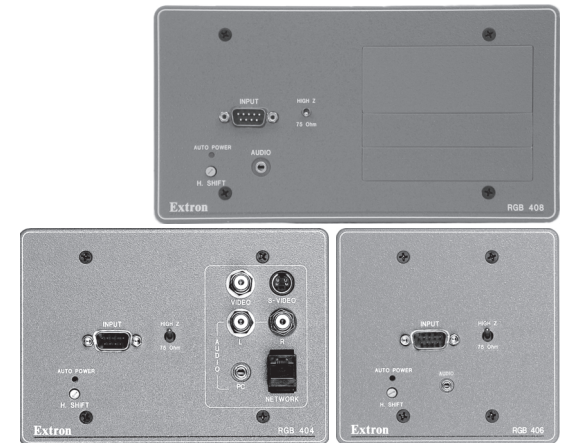

## RGB 400 Series Mountable Interfaces



**Extron Electronics, USA**  
1230 South Lewis Street, Anaheim, CA 92805  
800.633.9876 714.491.1500 FAX 714.491.1517  
USA

**Extron Electronics, Europe**  
Beeldschermweg 6C, 3821 AH Amersfoort  
+31.33.453.4040 FAX +31.33.453.4050  
The Netherlands

**Extron Electronics, Asia**  
135 Joo Seng Rd. #04-01, PM Industrial Bldg.  
+65.383.4400 FAX +65.383.4664  
Singapore 368363

**Extron Electronics Information**  
ExtronWEB™: [www.extron.com](http://www.extron.com)  
ExtronFAX™: 714.491.0192  
24-hour access—worldwide!

# Precautions

## Safety Instructions • English



This symbol is intended to alert the user of important operating and maintenance (servicing) instructions in the literature provided with the equipment.



This symbol is intended to alert the user of the presence of uninsulated dangerous voltage within the product's enclosure that may present a risk of electric shock.

## Caution

**Read Instructions** • Read and understand all safety and operating instructions before using the equipment.

**Retain Instructions** • The safety instructions should be kept for future reference.

**Follow Warnings** • Follow all warnings and instructions marked on the equipment or in the user information.

**Avoid Attachments** • Do not use tools or attachments that are not recommended by the equipment manufacturer because they may be hazardous.

## Consignes de Sécurité • Français



Ce symbole sert à avertir l'utilisateur que la documentation fournie avec le matériel contient des instructions importantes concernant l'exploitation et la maintenance (réparation).



Ce symbole sert à avertir l'utilisateur de la présence dans le boîtier de l'appareil de tensions dangereuses non isolées posant des risques d'électrocution.

## Attention

**Lire les instructions** • Prendre connaissance de toutes les consignes de sécurité et d'exploitation avant d'utiliser le matériel.

**Conservser les instructions** • Ranger les consignes de sécurité afin de pouvoir les consulter à l'avenir.

**Respecter les avertissements** • Observer tous les avertissements et consignes marqués sur le matériel ou présentés dans la documentation utilisateur.

**Eviter les pièces de fixation** • Ne pas utiliser de pièces de fixation ni d'outils non recommandés par le fabricant du matériel car cela risquerait de poser certains dangers.

## Sicherheitsanleitungen • Deutsch



Dieses Symbol soll dem Benutzer in der im Lieferumfang enthaltenen Dokumentation besonders wichtige Hinweise zur Bedienung und Wartung (Instandhaltung) geben.



Dieses Symbol soll den Benutzer darauf aufmerksam machen, daß im Inneren des Gehäuses dieses Produktes gefährliche Spannungen, die nicht isoliert sind und die einen elektrischen Schock verursachen können, herrschen.

## Achtung

**Lesen der Anleitungen** • Bevor Sie das Gerät zum ersten Mal verwenden, sollten Sie alle Sicherheits- und Bedienungsanleitungen genau durchlesen und verstehen.

**Aufbewahren der Anleitungen** • Die Hinweise zur elektrischen Sicherheit des Produktes sollten Sie aufbewahren, damit Sie im Bedarfsfall darauf zurückgreifen können.

**Befolgen der Warnhinweise** • Befolgen Sie alle Warnhinweise und Anleitungen auf dem Gerät oder in der Benutzerdokumentation.

**Keine Zusatzgeräte** • Verwenden Sie keine Werkzeuge oder Zusatzgeräte, die nicht ausdrücklich vom Hersteller empfohlen wurden, da diese eine Gefahrenquelle darstellen können.

## Instrucciones de seguridad • Español



Este símbolo se utiliza para advertir al usuario sobre instrucciones importantes de operación y mantenimiento (o cambio de partes) que se desean destacar en el contenido de la documentación suministrada con los equipos.



Este símbolo se utiliza para advertir al usuario sobre la presencia de elementos con voltaje peligroso sin protección aislante, que puedan encontrarse dentro de la caja o alojamiento del producto, y que puedan representar riesgo de electrocución.

## Precaución

**Leer las instrucciones** • Leer y analizar todas las instrucciones de operación y seguridad, antes de usar el equipo.

**Conservar las instrucciones** • Conservar las instrucciones de seguridad para futura consulta.

**Obedecer las advertencias** • Todas las advertencias e instrucciones marcadas en el equipo o en la documentación del usuario, deben ser obedecidas.

**Evitar el uso de accesorios** • No usar herramientas o accesorios que no sean específicamente recomendados por el fabricante, ya que podrían implicar riesgos.

## Warning

**Power sources** • This equipment should be operated only from the power source indicated on the product. This equipment is intended to be used with a main power system with a grounded (neutral) conductor. The third (grounding) pin is a safety feature, do not attempt to bypass or disable it.

**Power disconnection** • To remove power from the equipment safely, remove all power cords from the rear of the equipment, or the desktop power module (if detachable), or from the power source receptacle (wall plug).

**Power cord protection** • Power cords should be routed so that they are not likely to be stepped on or pinched by items placed upon or against them.

**Servicing** • Refer all servicing to qualified service personnel. There are no user-serviceable parts inside. To prevent the risk of shock, do not attempt to service this equipment yourself because opening or removing covers may expose you to dangerous voltage or other hazards.

**Slots and openings** • If the equipment has slots or holes in the enclosure, these are provided to prevent overheating of sensitive components inside. These openings must never be blocked by other objects.

**Lithium battery** • There is a danger of explosion if battery is incorrectly replaced. Replace it only with the same or equivalent type recommended by the manufacturer. Dispose of used batteries according to the manufacturer's instructions.

## Avertissement

**Alimentations** • Ne faire fonctionner ce matériel qu'avec la source d'alimentation indiquée sur l'appareil. Ce matériel doit être utilisé avec une alimentation principale comportant un fil de terre (neutre). Le troisième contact (de mise à la terre) constitue un dispositif de sécurité: n'essayez pas de le contourner ni de la désactiver.

**Déconnexion de l'alimentation** • Pour mettre le matériel hors tension sans danger, déconnectez tous les cordons d'alimentation de l'arrière de l'appareil ou du module d'alimentation de bureau (s'il est amovible) ou encore de la prise secteur.

**Protection du cordon d'alimentation** • Acheminer les cordons d'alimentation de manière à ce que personne ne risque de marcher dessus et à ce qu'ils ne soient pas écrasés ou pincés par des objets.

**Réparation-maintenance** • Faire exécuter toutes les interventions de réparation-maintenance par un technicien qualifié. Aucun des éléments internes ne peut être réparé par l'utilisateur. Afin d'éviter tout danger d'électrocution, l'utilisateur ne doit pas essayer de procéder lui-même à des opérations car l'ouverture ou le retrait des couvercles risquent de l'exposer à de hautes tensions et autres dangers.

**Fentes et orifices** • Si le boîtier de l'appareil comporte des fentes ou des orifices, ceux-ci servent à empêcher les composants internes sensibles de surchauffer. Ces ouvertures ne doivent jamais être bloquées par des objets.

**Lithium Batterie** • Il a danger d'explosion s'il y a remplacement incorrect de la batterie. Remplacer uniquement avec une batterie du meme type ou d'un type equivalent recommande par le constructeur. Mettre au reut les batteries usagées conformément aux instructions du fabricant.

## Vorsicht

**Stromquellen** • Dieses Gerät sollte nur über die auf dem Produkt angegebene Stromquelle betrieben werden. Dieses Gerät wurde für eine Verwendung mit einer Hauptstromleitung mit einem geerdeten (neutralen) Leiter konzipiert. Der dritte Kontakt ist für einen Erdschluss, und stellt eine Sicherheitsfunktion dar. Diese sollte nicht umgangen oder außer Betrieb gesetzt werden.

**Stromunterbrechung** • Um das Gerät auf sichere Weise vom Netz zu trennen, sollten Sie alle Netzkabel aus der Rückseite des Gerätes, aus der externen Stromversorgung (falls dies möglich ist) oder aus der Wandsteckdose ziehen.

**Schutz des Netzkabels** • Netzkabel sollten stets so verlegt werden, daß sie nicht im Weg liegen und niemand darauf treten kann oder Objekte darauf- oder unmittelbar dagegestellt werden können.

**Wartung** • Alle Wartungsmaßnahmen sollten nur von qualifiziertem Servicepersonal durchgeführt werden. Die internen Komponenten des Gerätes sind wartungsfrei. Zur Vermeidung eines elektrischen Schocks versuchen Sie in keinem Fall, dieses Gerät selbst öffnen, da beim Entfernen der Abdeckungen die Gefahr eines elektrischen Schlags und/oder andere Gefahren bestehen.

**Schlitze und Öffnungen** • Wenn das Gerät Schlitze oder Löcher im Gehäuse aufweist, dienen diese zur Vermeidung einer Überhitzung der empfindlichen Teile im Inneren. Diese Öffnungen dürfen niemals von anderen Objekten blockiert werden.

**Litium-Batterie** • Explosionsgefahr, falls die Batterie nicht richtig ersetzt wird. Ersetzen Sie verbrauchte Batterien nur durch den gleichen oder einen vergleichbaren Batterietyp, der auch vom Hersteller empfohlen wird. Entsorgen Sie verbrauchte Batterien bitte gemäß den Herstelleranweisungen.

## Advertencia

**Alimentación eléctrica** • Este equipo debe conectarse únicamente a la fuente/tipo de alimentación eléctrica al equipo, desenchufar todos los cables de este equipo debe provenir de un sistema de distribución general con conductor neutro a tierra. La tercera pata (puesta a tierra) es una medida de seguridad, no puentearla ni eliminarla.

**Desconexión de alimentación eléctrica** • Para desconectar con seguridad la acometida de alimentación eléctrica al equipo, desenchufar todos los cables de alimentación en el panel trasero del equipo, o desenchufar el módulo de alimentación (si fuera independiente), o desenchufar el cable del receptáculo de la pared.

**Protección del cables de alimentación** • Los cables de alimentación eléctrica se deben instalar en lugares donde no sean pisados ni apretados por objetos que se puedan apoyar sobre ellos.

**Reparaciones/mantenimiento** • Solicitar siempre los servicios técnicos de personal calificado. En el interior no hay partes a las que el usuario deba acceder. Para evitar riesgo de electrocución, no intentar personalmente la reparación/ mantenimiento de este equipo, ya que al abrirlo o extraer las tapas puede quedar expuesto a voltajes peligrosos u otros riesgos.

**Ranuras y aberturas** • Si el equipo posee ranuras o orificios en su caja/alojamiento, es para evitar el sobrecalentamiento de componentes internos sensibles. Estas aberturas nunca se deben obstruir con otros objetos.

**Batería de litio** • Existe riesgo de explosión si esta batería se coloca en la posición incorrecta. Cambiar esta batería únicamente con el mismo tipo (o su equivalente) recomendado por el fabricante. Desachar las baterías usadas siguiendo las instrucciones del fabricante.

# FCC Class A Notice

Note: This equipment has been tested and found to comply with the limits for a Class A digital device, pursuant to part 15 of the FCC Rules. These limits are designed to provide reasonable protection against harmful interference when the equipment is operated in a commercial environment. This equipment generates, uses and can radiate radio frequency energy and, if not installed and used in accordance with the instruction manual, may cause harmful interference to radio communications. Operation of this equipment in a residential area is likely to cause harmful interference, in which case the user will be required to correct the interference at his own expense.

Note: This unit was tested with shielded cables on the peripheral devices. Shielded cables must be used with the unit to ensure compliance.

# Extron's Warranty

Extron Electronics warrants this product against defects in materials and workmanship for a period of two years from the date of purchase. In the event of malfunction during the warranty period attributable directly to faulty workmanship and/or materials, Extron Electronics will, at its option, repair or replace said products or components, to whatever extent it shall deem necessary to restore said product to proper operating condition, provided that it is returned within the warranty period, with proof of purchase and description of malfunction to:

**USA, Canada, South America, and Central America:**

Extron Electronics  
1230 South Lewis Street  
Anaheim, CA 92805, USA

**Europe, Africa, and the Middle East:**

Extron Electronics, Europe  
Beeldschermweg 6C  
3821 AH Amersfoort  
The Netherlands

**Asia:**

Extron Electronics, Asia  
135 Joo Seng Road, #04-01  
PM Industrial Bldg.  
Singapore 368363

This Limited Warranty does not apply if the fault has been caused by misuse, improper handling care, electrical or mechanical abuse, abnormal operating conditions or non-Extron authorized modification to the product.

*If it has been determined that the product is defective, please call Extron and ask for an Applications Engineer at (714) 491-1500 (USA), 31.33.453.4040 (Europe), or 65.383.4400 (Asia) to receive an RA# (Return Authorization number). This will begin the repair process as quickly as possible.*

Units must be returned insured, with shipping charges prepaid. If not insured, you assume the risk of loss or damage during shipment. Returned units must include the serial number and a description of the problem, as well as the name of the person to contact in case there are any questions.

Extron Electronics makes no further warranties either expressed or implied with respect to the product and its quality, performance, merchantability, or fitness for any particular use. In no event will Extron Electronics be liable for direct, indirect, or consequential damages resulting from any defect in this product even if Extron Electronics has been advised of such damage.

Please note that laws vary from state to state and country to country, and that some provisions of this warranty may not apply to you.

# Table of Contents

---

<b>Chapter 1 • Introduction</b> .....	1-1
<b>About this Manual</b> .....	1-2
<b>About the RGB 400 Series Interfaces</b> .....	1-2
<b>Features</b> .....	1-2
RGB 400 Series features .....	1-2
Additional RGB 404 features .....	1-2
Additional RGB 406 and RGB 408 features .....	1-2
<b>Chapter 2 • Installation and Operation</b> .....	2-1
<b>Installation Overview</b> .....	2-2
<b>Installation and Operation Instructions</b> .....	2-3
Determining installation location .....	2-3
Preparing the installation site, installing the wall box .....	2-4
Front and rear panel (circuit board) features .....	2-6
RGB 404 front and rear features .....	2-6
RGB 406 front and rear features .....	2-8
RGB 408 front and rear features .....	2-12
Setting DIP switches and jumpers .....	2-12
DIP switches .....	2-12
Jumpers .....	2-12
Attaching adapter plates (RGB 408) .....	2-13
Cabling and connections .....	2-14
Attaching cables to pass-through connectors .....	2-14
Connecting shields .....	2-15
Connecting audio cables — RGB 404 .....	2-16
Connecting audio cables — RGB 406, RGB 408 .....	2-18
Connecting input cables and video output cables .....	2-18
Attaching power cables .....	2-18
Using installation cable .....	2-19
Pre-installation testing/troubleshooting .....	2-19
Mounting the interface to the wall box .....	2-21
Application diagrams .....	2-23
<b>Appendix A • Specifications</b> .....	A-1
<b>Appendix B • Templates</b> .....	B-1
<b>RGB 406 Cut-out Template</b> .....	B-2
<b>RGB 404 Cut-out Template</b> .....	B-3
<b>RGB 408 Cut-out Template</b> .....	B-4

## Table of Contents, cont'd

---

<b>Appendix C • Dimensions</b> .....	C-1
<b>RGB 404 Panel Dimensions</b> .....	C-2
<b>RGB 406 Panel Dimensions</b> .....	C-5
<b>RGB 408 Panel Dimensions</b> .....	C-6
<b>RGB 408 Panel Dimension Details</b> .....	C-7
<b>Appendix D • Accessories and Part Numbers</b> .....	D-1
<b>Interfaces and Included Parts</b> .....	D-2
<b>Accessories and Connectors</b> .....	D-2
<b>Cables</b> .....	D-3
<b>Optional Adapter Plates</b> .....	D-4



## RGB 400 Series

# Chapter One

## Introduction

About this Manual

About The RGB 400 Series Interfaces

Features

68-364-01 D  
Printed in the USA  
07 00

### About this Manual

This manual contains information about the RGB 400 Series interfaces and on how to operate and configure them.

### About The RGB 400 Series Interfaces

The RGB 400 Series are 300 MHz (-3dB) bandwidth, analog computer-video interfaces that can be mounted in walls or furniture. The RGB 406 is two-gang wall plate size, the RGB 404 is three-gang size, and the RGB 408 is four-gang size. All are available with black, white, or gray panels.

### Features

#### RGB 400 Series features

**Horizontal centering control** — Shifts the image horizontally.

**Level control** — Adjusts the image brightness.

**Peaking control** — Adjusts the image sharpness.

**Sync output options** — Six BNC connectors allow separate horizontal, vertical and composite sync outputs.

Sync-on-green (SOG) is output only if SOG is input.

**Digital Display Sync Processing™ (DDSP™)** — Sync is output in its original state to ensure compatibility with digital display products.

**75 ohm video termination switch** — For applications where a local computer monitor is not being used.

#### Additional RGB 404 features

The RGB 404 offers the following features in addition to the RGB 400 Series features listed above:

**Composite video pass-through** RCA connector

**S-video pass-through** 4-pin mini DIN connector

**Network pass-through** (RJ-45 connector)

**Two 2-channel audio outputs** (unbalanced in, balanced out) on RCA and PC stereo connectors

#### Additional RGB 406 and RGB 408 features

The RGB 406 and RGB 408 offer these features in addition to the RGB 400 Series features listed above:

**Two channels of audio** (unbalanced in, balanced out)

**Optional pass-through adapter plates** (RGB 408 only)



## RGB 400 Series

# Chapter Two

## Installation and Operation

Installation Overview

Installation and Operation Instructions

## Installation Overview

To install and set up an RGB 400 Series interface, follow these basic steps:

- 1 Determine the installation location.
- 2 Prepare the site for installation. Use the supplied template to mark the rough-in cutout, then cut out the wallboard or wood.
- 3 Set the DIP (dual in-line package) switches and jumpers. **These items will be inaccessible after installation.**
- 4 For the RGB 408, attach optional adapter plates, and attach output cables to the back sides of the adapter plates.
- 5 For all models, connect the wires and cables for power, audio output and pass-through signals. **These items will be inaccessible after installation.**
- 6 For all models, set the front panel High Z/75 Ohm video termination toggle switch.
- 7 Temporarily connect the input cables. Connect any cables whose signals will be routed through the optional adaptor pass-through plates.
- 8 Connect power cables to the input and output devices. Turn on the input and output devices.
- 9 The image should now display on screen. If it does not display, or if the picture displays incorrectly, double check and make adjustments to cables, DIP switches and jumpers as needed. Refer to the "Pre-installation testing/troubleshooting" section in this chapter.
- 10 Temporarily disconnect the input cables from the front panel of the interface, and disconnect the power from the interface.
- 11 Mount the interface in the wall or furniture.
- 12 Reconnect the computer video and audio input cables to the interface, apply power, and readjust horizontal centering as needed via the front panel control.

## Installation and Operation Instructions

### Determining installation location

Take cabling and power availability and the location of wall studs into consideration when selecting an installation site. You may need to install the cables in the wall, furniture or conduits before installing the interface. Choose a location that will allow cable runs without interference, preferably next to a 2" x 4" wall stud.

The RGB 400 Series interfaces each consist of a front panel with an attached circuit board. They are typically installed in standard 2-, 3- or 4-gang, 2.5-inch deep electrical wall boxes. A metal wall box (provided by Extron) is preferred, but a plastic box (or no wall box at all) can be used as long as it conforms to local code restrictions and the interface's size requirements. If a wall box is used, it must be attached to wall studs within the wall.

The drawing below illustrates the typical depth required to accommodate the maximum bend of high resolution (SHR) coaxial and miniature coaxial cables inside a wall box.

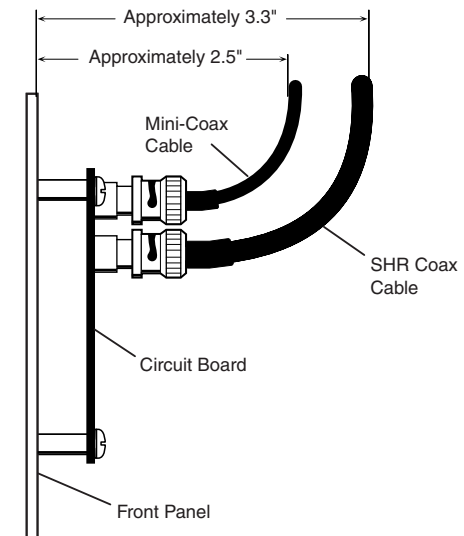

### **Minimum installation depth needed for maximum coaxial cable bend**

Cut-out (rough-in) templates and dimensional drawings are provided in the appendices of this manual.

### Preparing the installation site and installing the wall box

Actual-size rough-in templates for each model are provided in Appendix B. If needed, make a 100% size photocopy of the appropriate template to use for installation. Compare the photocopy with the faceplate and wall box to make sure the photocopy size is the same as the equipment.

Use the template as a guide to mark and cut the hole in the wall or furniture through which the interface will be installed. The innermost line represents the opening where material will be removed and the wall box will be installed.

1. Cut out the center portion (up to the guidelines) of the cut-out (rough-in) template.
2. Place the template on the surface where the interface will be installed. Use a soft pencil to mark the guidelines for the opening on the wall/furniture.
3. Cut out the material from the cut-out area with a jigsaw or small hand saw.
4. Check the opening size by inserting the wall box (if used) or the interface (if no wall box is used) into the opening. The wall box will be mounted flush with the outer wall or furniture surface. The box and/or interface should fit easily into the opening.
5. If needed, use a saw, file or sandpaper to enlarge the hole. Smooth the edges of the opening to avoid damage or injury to yourself or the cables during installation.
6. Attach the wall box to the wall stud (2" x 4") with nails or screws, leaving the front edge flush with the wall surface, as shown in the following illustration.

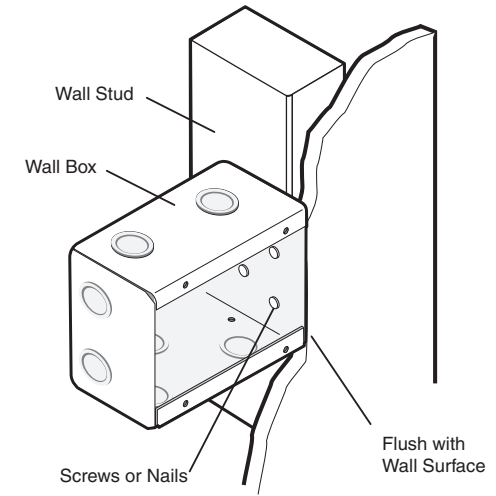

### Attaching the wall box to wall studs

To attach the wall box to wood, use four #8 to #10 wood or sheet metal screws. A minimum of 1/2 inch (1.25 cm) of screw threads must penetrate the wood. If the wood is a 2 x 4, such as a wall stud, 10-penny or larger nails can be used.

To attach the electrical wall box to metal, use four #8 or #10 sheet metal screws (self-tapping) or #8 or #10 machine bolts with matching nuts.

7. Output cables will usually be out of sight inside a wall, for example. Feed the cables through the wall box "punch-out" holes for connection to the interface. Cable clamps should be used to hold the cables in place for strain relief.
8. Exposed cable shields (braids or foil) are potential sources of short circuits. Trim back and/or insulate shields with heat shrink. Details for typical maximum coaxial cable bend inside a wall box are given on page 2-3.
9. Configure, cable and test the interface before securing the interface to the wall box. Configuration consists of setting circuit board DIP switches and jumpers based on installation requirements. See page 2-14 for more information.

## Front and rear panel (circuit board) features

### RGB 404 front and rear features

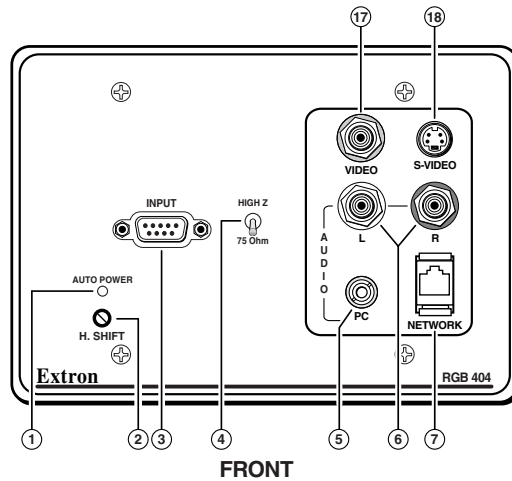

- ① **Auto power LED** — If active sync pulses are present, power and this LED turn on. If not, power and this LED turn off.
- ② **H. Shift (horizontal shift) control** — This controls the horizontal centering. If output is SOG or if DIP SW1-2 (DDSP) is set to On, the horizontal shift control is disabled.
- ③ **Input** — This 9-pin D-sub male connector is for RGB input.
- ④ **High Z/75 Ohm switch** — For proper video termination, set this switch to 75 Ohms if no local monitor will be connected.

- ⑤ **PC type 3.5 mm stereo audio input connector** — This connector is for unbalanced input to audio channel 2. Wire the input plug as shown here.

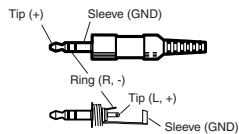

- ⑥ **Left and right audio channel RCA connectors** — These connectors are for unbalanced input to audio channel 1. Wire the input plugs as shown below.

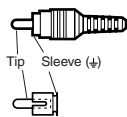

- ⑦ **Network pass-through RJ-45 connector**

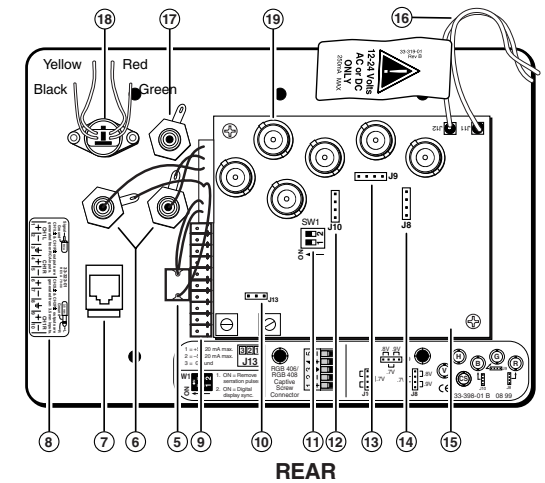

- ⑧ **Pin assignment label for the audio output captive screw connector (item 9)** — Audio output wiring is discussed in the cabling section of this chapter.
- ⑨ **Audio output captive screw connector** — Use this connector for the balanced output from both audio channels (1 and 2). See the wiring diagram label (item 8) and the cabling section in this manual for wiring instructions.
- ⑩ **J13 jumper** — Pin 1 = +5V, pin 2 = -5V, pin 3 = ground.
- ⑪ **SW1 DIP switches** — 1. On = Removes serration pulses. 2. On = Enables Digital Display Sync Processing (DDSP).
- ⑫ **J10 blue gain/peaking jumper** — Settings are shown on the label located below the circuit board.
- ⑬ **J9 green gain/peaking jumper**
- ⑭ **J8 red gain/peaking jumper**
- ⑮ **Circuit board** — Only key components are shown here.
- ⑯ **Twisted-pair wires** — Splice these wires to a 12 to 24VAC or VDC power source.
- ⑰ **Composite video pass-through RCA connector**—If unused, this connector can be replaced with a 0.31" diam. plug.
- ⑱ **S-video pass-through 4-pin mini DIN connector** — This connector can be replaced with a 0.50" diam. plug.
- ⑲ **BNC output connectors** — These 6 connectors are for video and sync output. Connect the coax cables' BNC connectors as shown here for red, green and blue video output, and either separate horizontal and vertical sync or composite sync.





## RGB 406 front and rear features

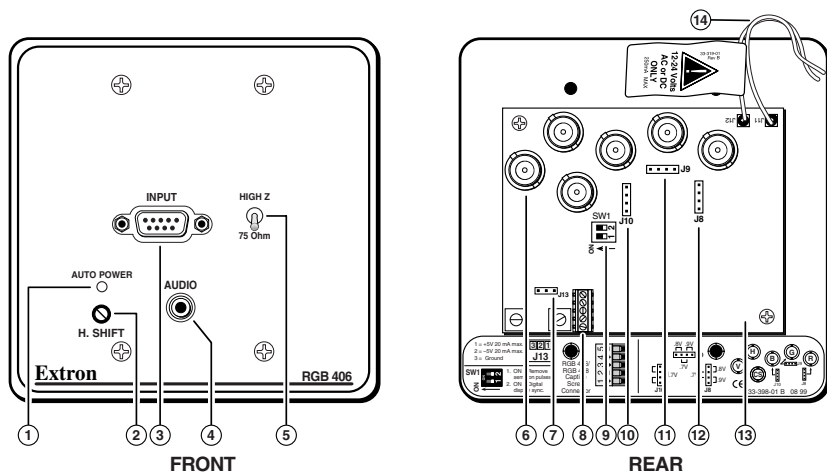

- ① **Auto power LED** — If this LED is on, power and sync pulses are present. If no sync is present, power and this LED turn off.
- ② **H. Shift (horizontal shift) control** — This controls horizontal centering. If output is SOG or if DIP SW1-2 (DDSP) is set to On, the horizontal shift control is disabled.
- ③ **Input** — This 9-pin D-sub male connector is for RGB analog input.
- ④ **Audio 3.5 mm stereo PC-type connector** for unbalanced input — See page 2-12 for an input plug wiring diagram.
- ⑤ **High Z/75 Ohm switch** — For proper video termination, set this switch to 75 Ohms if no local monitor will be connected.
- ⑥ **BNC output connectors** — These 6 connectors are for video and sync output. Connect the coaxial cables' BNC connectors as shown here for red, green and blue video output, and either separate horizontal and vertical sync or composite sync.
 

(H)
(B)
(G)
(R)
(V)
(CS)
- ⑦ **J13 jumper** — Pin 1 = +5V, pin 2 = -5V, pin 3 = ground.
- ⑧ **Audio output 3.5 mm, 5-pole captive screw connector** — The label below this connector provides a wiring diagram for balanced audio output.

- ⑨ **SW1 DIP switches** —
  1. On = Removes serration pulses.
  2. On = Enables Digital Display Sync Processing (DDSP).
- ⑩ **J10 blue gain/peaking jumper** — Settings are shown on the label located below the circuit board.
- ⑪ **J9 green gain/peaking jumper**
- ⑫ **J8 red gain/peaking jumper**
- ⑬ **Circuit board** — Only key components are shown here.
- ⑭ **Twisted-pair wires** — Splice these wires to a 12 to 24VAC or VDC power source.

# Installation and Operation, cont'd

## RGB 408 front and rear features

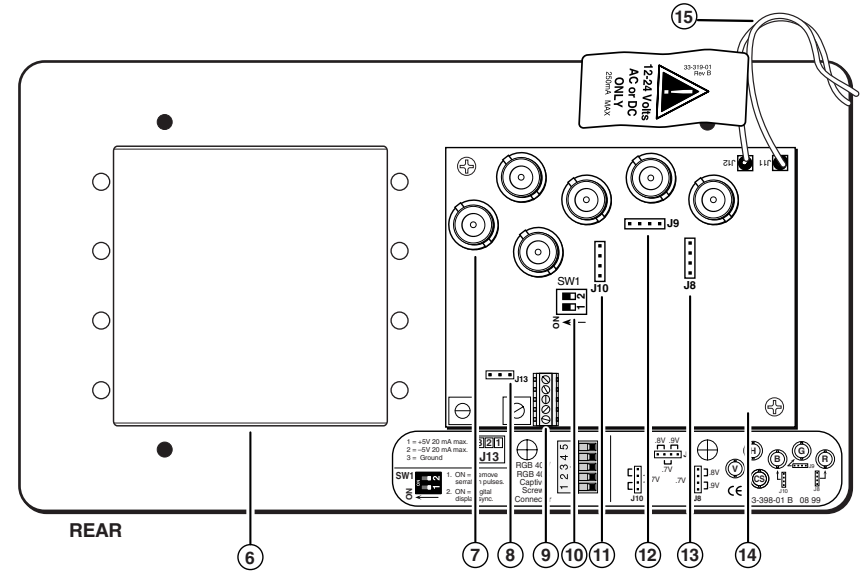
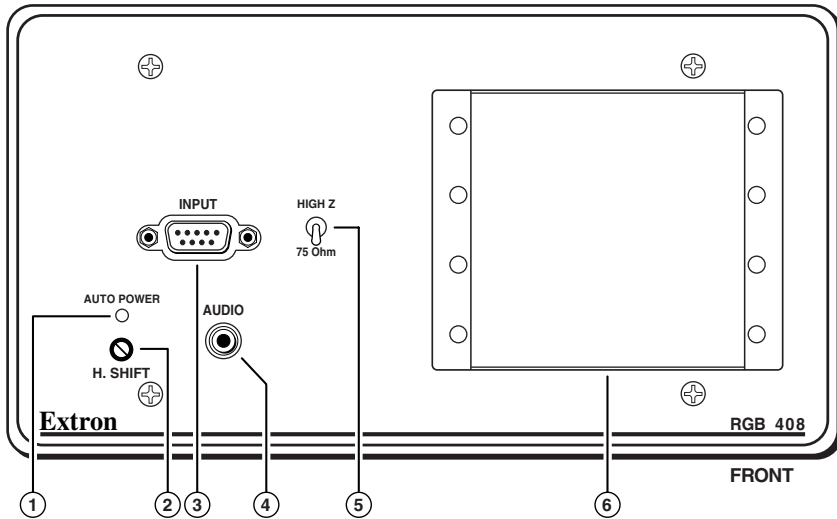

- ① **Auto power LED** — If this LED is on, power and video sync pulses are present. If no sync is present, power and this LED turn off.
- ② **H. Shift (horizontal shift) control** — This controls horizontal centering. If output is SOG or if DIP SW1-2 (DDSP) is set to On, the horizontal shift control is disabled.
- ③ **Input** — This 9-pin D-sub male connector is for RGB analog input.
- ④ **Audio input 3.5 mm stereo PC-type connector** for unbalanced input — Wire the PC audio input plug as shown here.

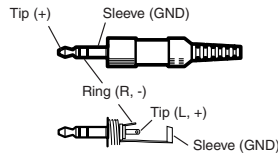

- ⑤ **High Z/75 Ohm switch** — For proper video termination, set this switch to 75 Ohms if no local monitor will be connected.
- ⑥ **Architectural adapter plates installation bay** — Up to four adapter plates for pass-through audio/video connections can be attached at one time to the interface. See the "Attaching adapter plates" section in this chapter for installation instructions.

- ⑦ **BNC output connectors** — These 6 connectors are for video and sync output. Connect the coaxial cables' BNC connectors as shown here for red, green and blue video output, and either separate horizontal and vertical sync or composite sync.
- ⑧ **J13 jumper** — Pin 1 = +5V, pin 2 = -5V, pin 3 = ground.
- ⑨ **Audio output 3.5 mm, 5-pole captive screw connector** — The label below this connector provides a wiring diagram for balanced audio output.
- ⑩ **SW1 DIP switches** —
  1. On = Remove serration pulses.
  2. On = Enable Digital Display Sync Processing (DDSP).
- ⑪ **J10 blue gain/peaking jumper** — Settings are shown on the label located below the circuit board.
- ⑫ **J9 green gain/peaking jumper**
- ⑬ **J8 red gain/peaking jumper**
- ⑭ **Circuit board** — Only key components are shown here.
- ⑮ **Twisted-pair wire** — Splice these wires to a 12 to 24VAC or VDC power source.

### Setting DIP switches and jumpers

DIP switches and jumpers must be set and tested before the interface is secured into the wall box, wall or furniture.

#### DIP switches

DIP switch module SW1 contains two DIP switches (SW1-1 and SW1-2). The module is located on the circuit board on the back of the interface, as shown on pages 2-6, 2-7, 2-9, 2-11 and 2-13. In these illustrations, the ON position is to the left.



Different video projectors may have slightly different sync requirements. Use the DIP switches on the interface to make the interface's output compatible with the projector.

#### DIP switch 1 (SW1-1) controls serration pulse output.

ON = No serration pulses will be output in the composite sync signal.

OFF = Serration pulses will be output.

#### DIP switch 2 (SW1-2) controls sync processing.

ON = Digital Display Sync Processing (DDSP) will be used. This may be required in order to obtain a stable picture on some digital display devices. When DDSP is on, horizontal shift (centering) is disabled.

OFF = DDSP will not be used.

#### Jumpers

Video signals passing through long cable runs (over 125 feet) or through poor quality cables can decrease in strength, creating signal loss. The longer the cable, the higher the video level and the greater the peaking that will be needed to compensate for the loss.

The gain/peaking adjustment jumpers are located on the circuit board on the back of the interface, as shown in the rear features sections of this manual. To configure the jumpers, use pliers to pull the jumper shunt off the pins, then place the jumper on the appropriate pins.

**WARNING** Make sure the interface is disconnected from the power source before configuring jumpers.

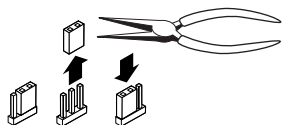

#### Changing jumper settings

Each red (J8), green (J9) and blue (J10) jumper can be set to one of three positions to provide unity gain (0.7 volts p-p), 0.8 volts p-p, or 0.9 volts p-p output. Select the setting that yields the best image display. Use the diagram on the product label (shown below) as a guide to setting the output gain/peaking for each color.

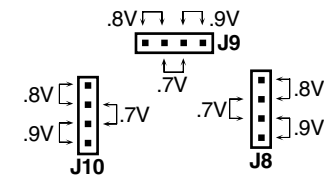

#### RGB 400 Series gain/peaking jumpers

- 0.7V — Use this for short cable runs (under 125 feet).
- 0.8V — Use this for long cable runs for all frequencies.
- 0.9V — Use this setting for long cable runs and high frequency video signals.

### Attaching adapter plates (RGB 408)

The RGB 408 can have up to 4 optional adapter plates. The adapter plates allow for a variety of types of pass-through audio and/or video connectors to be added to the interface's front panel faceplate.

Blank plates (two single-height and one double-height plate) are included with the RGB 408 to cover unused spaces. Other adapter plates must be ordered separately. They also must be attached to the faceplate and cabled before the interface is installed in the wall or furniture. The screws needed for installing the adapter plates are built into the plates, so no additional screws will be needed.

1. Remove the blank plates from the interface by unscrewing the nuts that fasten the plates to the faceplate.
2. Insert the adapter plate screws through the holes in the faceplate. Attach the adapter plates to the faceplate with the provided captive washers and #4-40 nuts. See the illustration "Installing optional adapter plates" on the next page.
3. Attach the output cables to the connectors on the back side of the adapter plates. Several adapter plates require conductors to be soldered to the connectors. Attach foil and braided shields to ground connections.

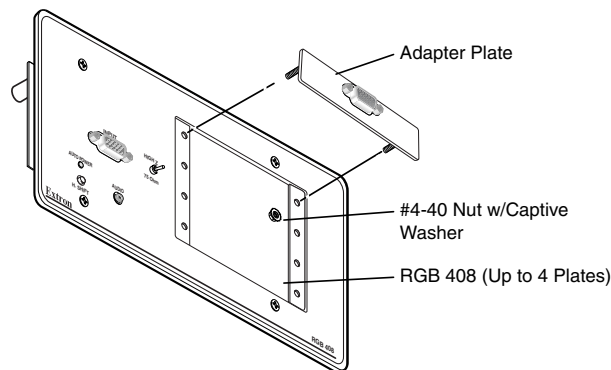

**Installing optional adapter plates**

## Cablings and connections

### Attaching cables to pass-through connectors

The RGB 404 provides pass-through connectors for composite video, S-video, RJ-45 network. These connectors are mounted on the faceplate. The RJ-45 cable can be plugged in from the back. Coaxial cables and/or twisted pair wires must be soldered to the back side of the S-video and RCA connectors, as described in this section.

Optional adapter plates with various types and combinations of pass-through audio and video connectors are available for the RGB 408. Many adapter plates also require cables and wires to be soldered to the rear connectors.

### Cablings S-video connectors

The illustration below identifies the S-video connector signal leads. For the RGB 404, splice and solder the four wires from this connector to user-supplied coaxial cables. Insulate the soldered connections to prevent shorts. You can also use the connector's shield tabs for chrominance and luminance ground tie points.

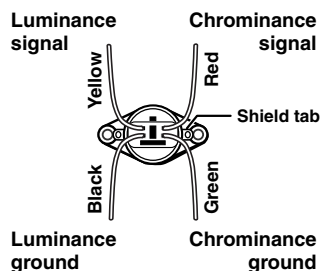

**S-video connector wiring diagram**

### Cablings RCA connectors

For composite video, solder the center conductor of a coaxial cable to the central solder cup of the RCA connector. Solder the cable's shield to the grounded grounding tab. See the leftmost and center illustrations below.

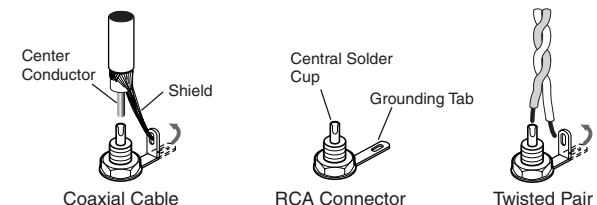

### Attaching coaxial and twisted-pair cables to RCA connectors

For audio, solder the signal wire of a shielded twisted-pair cable to the central solder cup of the RCA connector. Solder the ground wire to the grounded tab, as shown above at right.

### Connecting shields

Multiconductor cables such as Extron's Install Plenum bulk cable contain several braided and foil shields. At the interface end of the cable, the **outer braided and foil shields** should be connected to the grounded metal wall box (or to a grounding wire if a metal wall box is not used). The wires that make up the braided shield can be unbraided, then twisted together to form a large, multi-strand wire that can be folded back under the wall box cable clamp or attached to the metal wall box with a screw. See the illustration below.

**WARNING** To prevent short circuits, the outer foil shield can be cut back to the point where the cable exits the cable clamp. Both the braided and foil shields should be connected to an equipment ground at the other end of the cable.

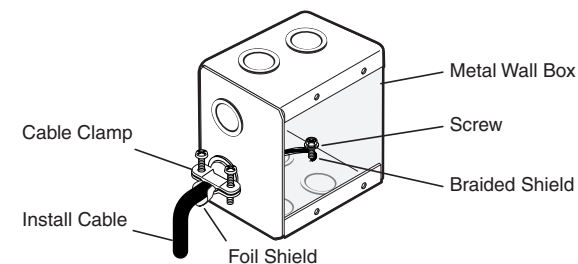

### Grounding outer braided and foil shields

## Installation and Operation, cont'd

If **shielded twisted-pair** wires are used for audio output for the RGB 404, RGB 406 or RGB 408, the shields should be connected to either pin 3 (RGB 406/408) or pins 3 and 8 (RGB 404) of the audio output captive screw connector. Twist the wires from the braided shield together to form a multi-strand wire, then insert it into the receptacle side of the captive screw connector. See the "Wiring audio output captive screw connectors" illustration on the next page.

Twisted-pair shields are not used for most other RGB 400 Series applications, even when twisted-pair wires are used. For those other applications, twist the shields together, and fold them back under the wall box cable clamp or attach them to the grounded wall box with a screw.

**WARNING** To prevent short circuits, unused shielded twisted-pair wires and exposed cable shields (braided or foil) must be insulated with electrical tape or heat shrink, and secured.

Connect **coaxial cables' shields** to a ground through the individual connectors (BNC, S-video or RCA).

### Connecting audio cables — RGB 404

The RGB 404 creates two 2-channel, balanced audio outputs from two unbalanced inputs.

- **Audio channel one (CH1)** consists of unbalanced input on two RCA input connectors (one each for left and right input), and balanced output on pins 1 – 5 of the 10-pole audio captive screw connector on the rear of the circuit board. Wire the RCA input plugs as shown at left.

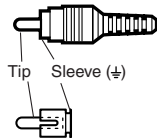

- **Audio channel two (CH2)** consists of unbalanced left and right input from the single PC-type 3.5 mm audio plug, and balanced output on pins 6 – 10 of the 10-pole captive screw connector on the rear of the circuit board. Wire the stereo PC input plug as shown here:

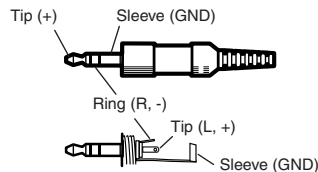

The audio signals are converted from unbalanced to balanced signals as they pass through the RGB 404. As a result, two output signals are produced for each input

signal. For example, the input signals from the left side of channel one (CH1L) are output as CH1L+ and CH1L-. The following illustration shows the audio inputs and outputs and how to wire the audio connectors.

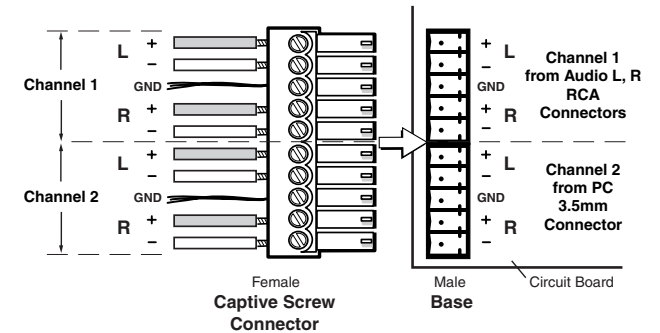

### Wiring RGB 404 audio connectors

To wire the audio output captive screw connector, follow these steps:

1. Prepare the wires for insertion into the connector by trimming off 3/16 inch of insulation.
2. Following the wiring diagram found on the label on the back of the faceplate or in this manual, insert the wires one at a time into the connector.
3. Tighten the wire clamp in the connector by turning the appropriate screw clockwise. Do not overtighten the screw. Avoid touching circuit board components with the ends of the wires. See the illustration below.

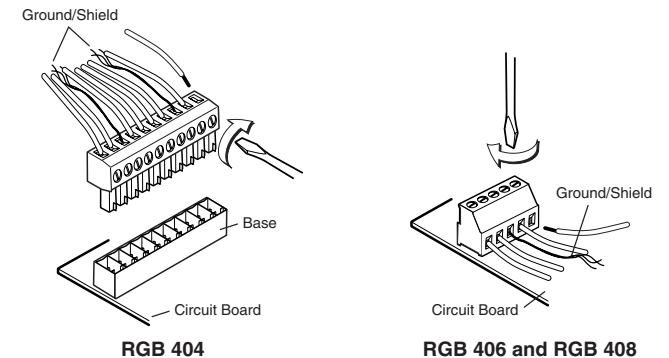

### Wiring audio output captive screw connectors

4. The cable shields should be connected to either pins 3 and 8 (RGB 404) or pin 3 (RGB 406/408) of the audio

output captive screw connector. See "Connecting shields" earlier in this chapter for details.

### Connecting audio cables — RGB 406, RGB 408

Each RGB 406 or RGB 408 accepts an unbalanced audio input from a front panel 3.5 mm PC-type stereo connector, and it outputs two channels of balanced audio on a 3.5 mm, 5-pole captive screw connector on the rear of the circuit board. Follow the steps listed for the RGB 404 for inserting wires into captive screw connectors. Use the label on the rear of the faceplate (excerpted here) as a wiring guide.

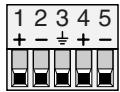

### Connecting input cables and video output cables

With appropriate cables, connect the computer and audio device(s) to the interface via the front panel input connectors. Connect all the devices for pass-through input (network, composite video, S-video and/or other inputs) via front panel or front adapter plate connectors.

Determine what computer-video format the display device requires: separate horizontal and vertical sync (RGBHV), composite sync (RGSB), or sync on green (RGSB or SOG). No matter what format the computer outputs to the interface, the output from the interface to the display device can be RGBHV or RGSB. If the video format input to the interface is RGSB (SOG), RGSB can be output to the display device; otherwise only RGBHV and RGSB are available as output options.

Connect the display device to the interface using coaxial cables. Attach the cable's BNC connectors to the appropriate rear panel BNC connectors on the interface based on the video format required by the display device.

### Attaching power cables

Each RGB 400 Series interface requires an external voltage source of 12 to 24 volts AC or DC (250 mA maximum, 5 W). The interfaces are supplied with a power cord of twisted-pair wire soldered to the circuit board.

1. Splice these wires to the cord of a user-supplied power source. Polarity is not important, even if the power source supplies DC voltage. Extron offers an optional external power supply. See Appendix D for the part number.
2. Solder and insulate the connections.

### Using installation cable

Extron's Install Plenum bulk cable (shown here) is ideal for mountable interfaces such as the RGB 400 Series models.

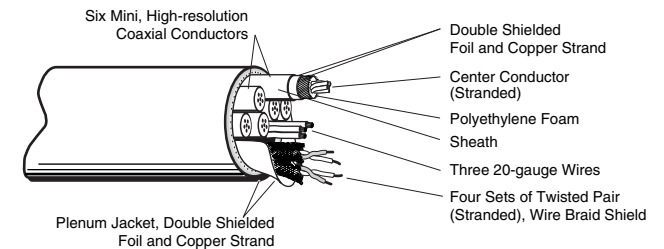

17-Conductor Install Plenum Cable

Below is an example of how the cable can be used.

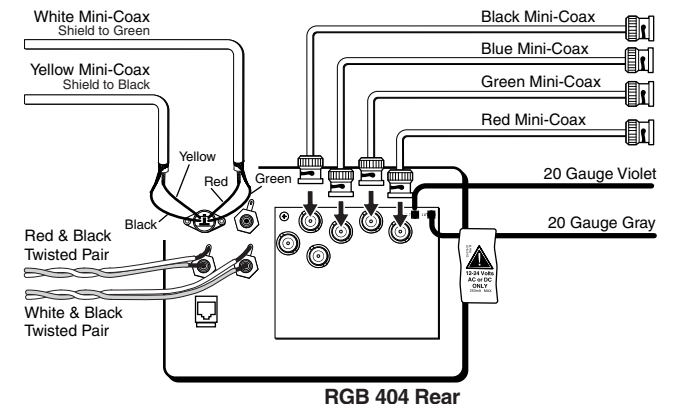

### Using installation cable with an RGB 404

### Pre-installation testing/troubleshooting

Before installing the interface into the wall or furniture, test the system to make sure that the connections and interface settings are correct.

Turn on the input device(s) (computer, audio device) and output device(s) (projector and/or monitor, speakers). The image should now appear on the screen, and sound should be audible.

### If the image does not appear or there is no sound

1. Ensure that all devices are plugged in.
2. Make sure that each device is receiving power. The interface's Auto power indicator LED will light if the interface is receiving power and an active sync signal.

## Installation and Operation, cont'd

3. Check the cabling and the audio connector wiring, and make adjustments as needed.
4. Verify that the High Z/75 Ohm video input termination toggle switch on the front panel has been set correctly.
5. For digital display devices (including LCD, DLP and plasma devices), try turning DDSP on or off using the rear panel SW1-2 DIP switch.
6. Call Extron's customer support hotline if needed.

### If the image does not display correctly

1. If the output image looks too green, the computer may be sending video with sync on green (SOG), and the display device may not be configured to handle SOG signals. The RGB 400 Series interfaces do not strip sync from the video input signals.
2. If the picture bends or flags at the top of the screen, set the serration pulse DIP switch (SW1-1) to Off.
3. For a display device that experiences intermittent glitches, try turning DDSP on or off using the rear panel SW1-2 DIP switch.
4. If the picture "hangs off" the edges of the screen, adjust the H. Shift horizontal centering control.
5. If the edges of the image seem to exceed their boundaries or if thin lines and sharp edges look thick and fuzzy, try changing the gain/peaking jumper (J10, J9, J8) settings. If the image is too bright, decrease the gain/peaking level.
6. If the image appears and is stable, but it has ghosting or blooming, check the High Z/75 Ohm video input termination. If changing the termination doesn't solve the problem, try using a different input cable.
7. If the image still does not display correctly, call Extron's customer support hotline.

### If no image or sound results from pass-through connections

1. Make sure each input device is connected to the correct pass-through connector, which in turn is connected to the appropriate output device.
2. Ensure that each connector is properly wired and grounded, and that each device is powered on.
3. If there still is no image or sound, try cabling the input device directly to the output device. If that resolves

the situation, either the pass-through connector or any cable that was part of the installation but not used for this test may be the source of the problem. If this test does not produce an image or sound, the problem may lie with an input device or an output device.

## Mounting the interface to the wall box

Once the system has been cabled and tested, the interface can be installed in the wall or furniture.

1. Remove power from the interface and input and output devices by disconnecting the power cords from the power supply.
2. Detach the input cables from the front panel.
3. For the RGB 408 only, install the EMI strips.

To maintain proper grounding connections between the interface faceplate and the wall box, adequate contact between the faceplate and wall box must be ensured. Installing the supplied EMI (electromagnetic interference) strips will ensure the proper contact and maintain the ground. To install the strips, do the following:

- a. Peel off the protective, papery coating from the back of an EMI strip.
- b. Apply the EMI strip to the center of the upper lip of the 4-gang wall box, pressing firmly to ensure contact. See the illustration below.
- c. Repeat steps 1 and 2 to install the other EMI conductive strip onto the lower lip of the wall box.

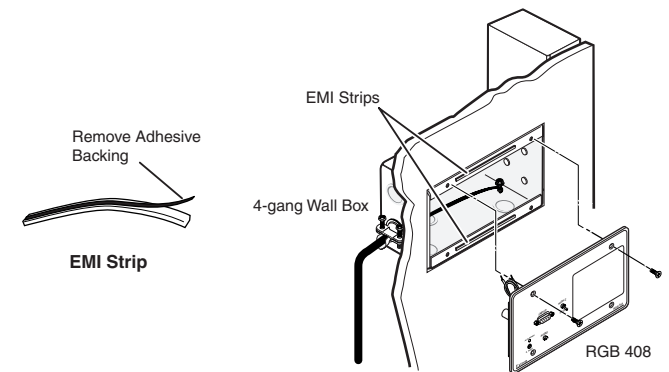

### Installing EMI strips on the wall box

## Installation and Operation, cont'd

- For all models, carefully place the interface through the opening in the wall or furniture and into the wall box (if one is used). Take care not to damage the cables.
- Mount the interface faceplate to the wall box with the provided machine screws (as shown below), or attach the interface directly to the furniture with wood or metal screws.

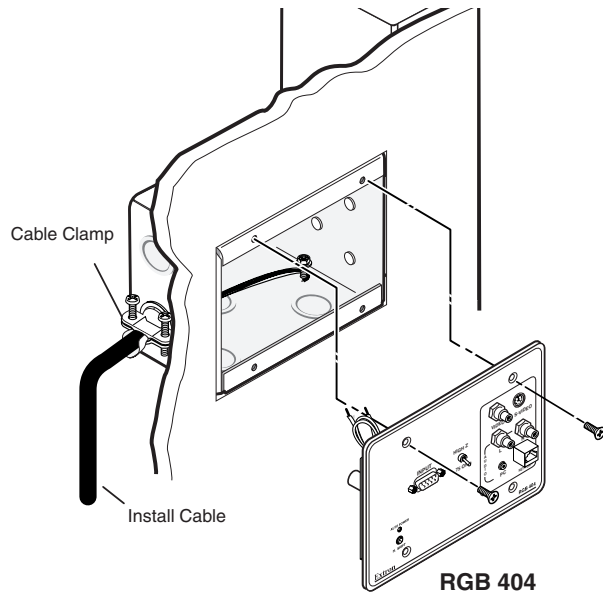

### Mounting the interface to the wall box

- Reconnect the input cables to the interface via the front panel connectors.
- Reconnect the power cables and restore power to the equipment.

## Application diagrams

Below are examples of typical system installations that incorporate RGB 400 series interfaces. Many other configurations are possible. Extron offers a variety of laptop and monitor breakout cables for easy connection of PCs, Macintosh, Sun or SGI computers.

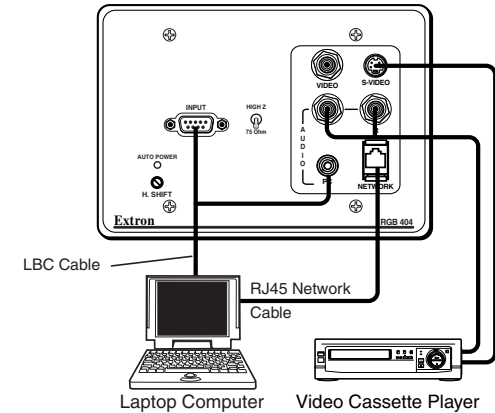

**An RGB 404 application featuring a laptop and network and S-video pass-through connections**

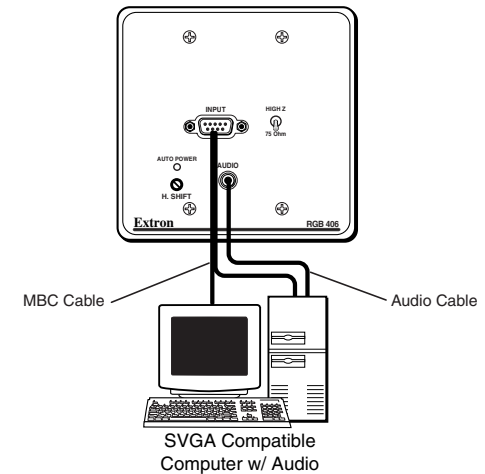

**A typical RGB 406 application**





# A

## **Appendix A**

### **Specifications**

Specifications

# Specifications

These specifications apply to all models unless otherwise noted.

## Video input

Number/type	1 analog RGBHV, RGBS, RGsB
Connectors	1 9-pin male D connector for MBC/LBC cable or buffer
Nominal level(s)	Analog ..... 0.3V to 1.45V p-p
Impedance	75 ohms or Hi Z, switchable (set to 75 ohms if no local monitor is connected)
Horizontal frequency	15 kHz to 150 kHz (optimum 15 kHz to 62 kHz)
Vertical frequency	30 Hz to 170 Hz
Return loss	-30dB @ 5 MHz

## Video throughput

Gain	Unity (0.7V), 15% with 3dB peaking (0.8V), 30% with 6dB peaking (0.9V)
Bandwidth	300 MHz (-3dB)

## Video output

Number/type/format	1 analog RGBHV, RGBS, RGsB
Connectors	6 BNC female
Nominal level	Analog ..... 0.7V p-p, 0.8V p-p, or 0.9V p-p (internal jumper-selectable) w/peaking
Impedance	75 ohms
Return loss	-30dB @ 5 MHz

## Sync

Input type	Autodetect RGBHV, RGBS, RGsB (accepts RGsB but does not strip from video)
Output type	RGBHV ..... at all times RGBS ..... at all times RGsB ..... only when input is RGsB
Input level	2.0V to 5.5V p-p with $\pm 0.2$ VDC offset max.
Output level	4.0V to 5.0V p-p
Input impedance	10 kohms
Output impedance	75 ohms
Max propagation delay	50 nS
Max rise/fall time	2.5 nS
Polarity	Positive or negative

## Audio input — RGB 404

Number/type	2 stereo, unbalanced; 1.0Vrms (+4dBu), 20 Hz to 20 kHz
Connectors	Ch. 1 ..... 2 RCA female jacks Ch. 2 ..... 3.5 mm stereo female jack (2 channel), unbalanced; tip (L), ring (R), sleeve (gnd)
Impedance	10 kohms, DC coupled
Minimum level	100mV
Maximum level	+8.5dBu

## Audio input — RGB 406 and RGB 408

Number/type	1 stereo, unbalanced; 1.0Vrms (+4dBu), 20 Hz to 20 kHz
Connectors	3.5 mm stereo female jack (2 channel), unbalanced; tip (L), ring (R), sleeve (gnd)
Impedance	10 kohms, DC coupled
Minimum level	100mV
Maximum level	+8.5dBu

## Audio throughput — RGB 404 (channels 1 and 2), RGB 406 and RGB 408

Gain	Unbalanced 0dB, balanced +6dB
Response	$\pm 0.5$ dB @ 20 Hz to 20 kHz
THD + Noise	0.03% @1 kHz, 0.3% @ 20 kHz at rated maximum output drive
S/N	>90dB, output 14dBu, balanced
Stereo channel separation	>95dB @ 1 kHz to 20 kHz

## Audio output — RGB 404 (channels 1 and 2)

Number/type	2 buffered, stereo (2 channel), balanced/unbalanced
Connectors	3.5 mm captive screw terminal, 5 conductor
Impedance	50 ohms unbalanced, 100 ohms balanced
Gain error	$\pm 0.1$ dB channel to channel
Drive (600 ohm)	+14dBu, balanced at stated %THD+N

## Audio output — RGB 406 and RGB 408

Number/type	1 buffered, stereo (2 channel), balanced/unbalanced
Connectors	3.5 mm captive screw terminal, 5 conductor

## Specifications, cont'd

---

Impedance .....	50 ohms, unbalanced, 100 ohms balanced
Gain error .....	±0.1dB channel to channel
Drive (600 ohm) .....	+14dBu, balanced at stated %THD+N

### General

Power .....	12 to 24VAC or VDC, 0.25 A, 5 watts, external (Order the power supply separately.)
Temperature/humidity .....	Storage -40° to +158°F (-40° to +70°C) / 10% to 90%, non condensing Operating +32° to +122°F (0° to +50°C) / 10% to 90%, non condensing
Rack mount .....	No, but wall or furniture mountable
Enclosure type .....	Metal
Enclosure dimensions <b>(RGB RGB 404)</b>	
Plate .....	4.50" H x 6.40" W (11.43 cm H x 16.26 cm W)
Box .....	3.75" H x 5.3" W x 2.5" D (9.5 cm H x 14.2 cm W x 6.35 cm D) 3-gang
Interface .....	2.8" H x 5.3" W x 2.5" D (7.1 cm H x 13.5 cm W x 6.4 cm D) (depth is given with an HR cable attached)
Enclosure dimensions <b>(RGB 406)</b>	
Plate .....	4.50" H x 4.60" W (11.43 cm H x 11.68 cm W)
Box .....	3.75" H x 3.75" W x 2.5" D (9.5 cm H x 9.5 cm W x 6.35 cm D) 2-gang
Interface .....	2.8" H x 3.5" W x 2.5" D (7.1 cm H x 8.9 cm W x 6.4 cm D) (depth is given for the circuit board with an HR cable attached)
Enclosure dimensions <b>(RGB 408)</b>	
Plate .....	4.50" H x 8.33" W (11.43 cm H x 21.15 cm W)
Box .....	3.75" H x 7.38" W x 2.50" D (9.50 cm H x 18.73 cm W x 6.35 cm D) 4-gang
Interface .....	2.8" H x 3.5" W x 2.5" D (7.1 cm H x 8.9 cm W x 6.4 cm D) (depth is given for the circuit board with an HR cable attached)
Shipping weight (all models) .....	3 lbs (1.4 kg)
Vibration .....	NSTA 1A in carton (National Safe Transit Association)

Approvals .....	UL, CE, FCC Class A
MTBF .....	30,000 hours
Warranty .....	2 years parts and labor

**NOTE** *Specifications are subject to change without notice.*



# Appendix B

## **Templates**

RGB 406 Cut-out Template

RGB 404 Cut-out Template

RGB 408 Cut-out Template

# Templates

All the templates in this section are actual size. Also, they all include the recommended 0.1" (0.25 cm) clearance on all sides of the electrical wall box to allow room for the raised areas surrounding the knockouts.

The dashed line in each template indicates the cut-out area for installing a wall box. If you plan to install the interface without a wall box, use the smaller cut-out area indicated by the dotted lines.

## RGB 406 Cut-out Template

Use this template as a guide for cutting a hole in a wall or furniture for the 2-gang size electrical box in order to install an RGB 406.

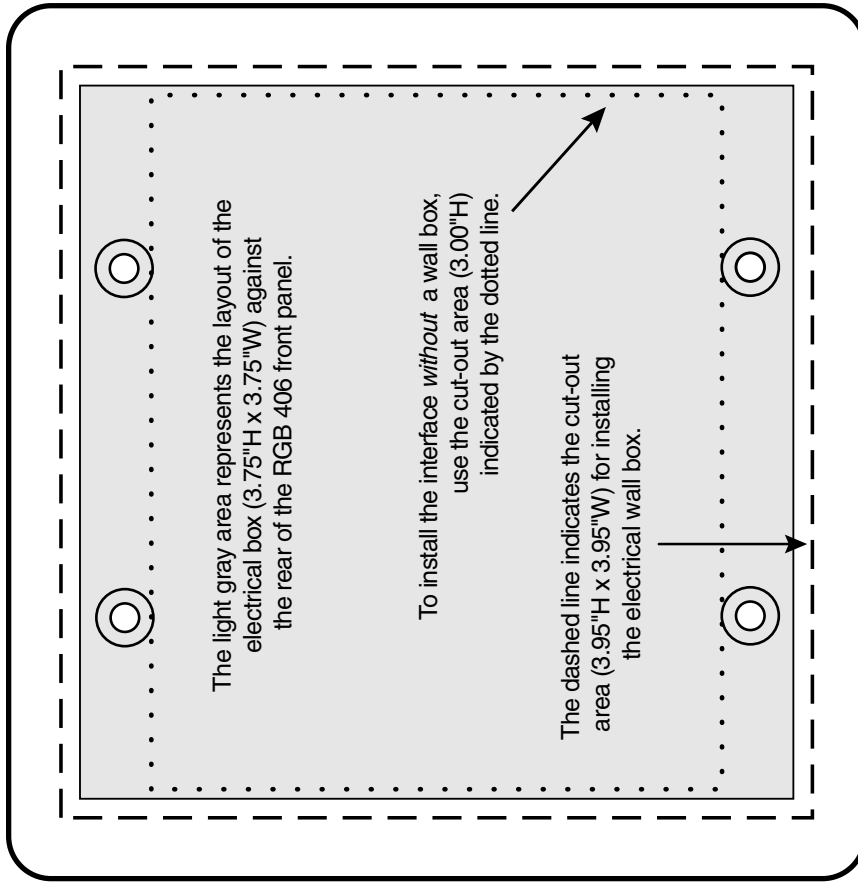

## RGB 404 Cut-out Template

Use this template for cutting a hole in a wall or furniture for the 3-gang size electrical box for an RGB 404.

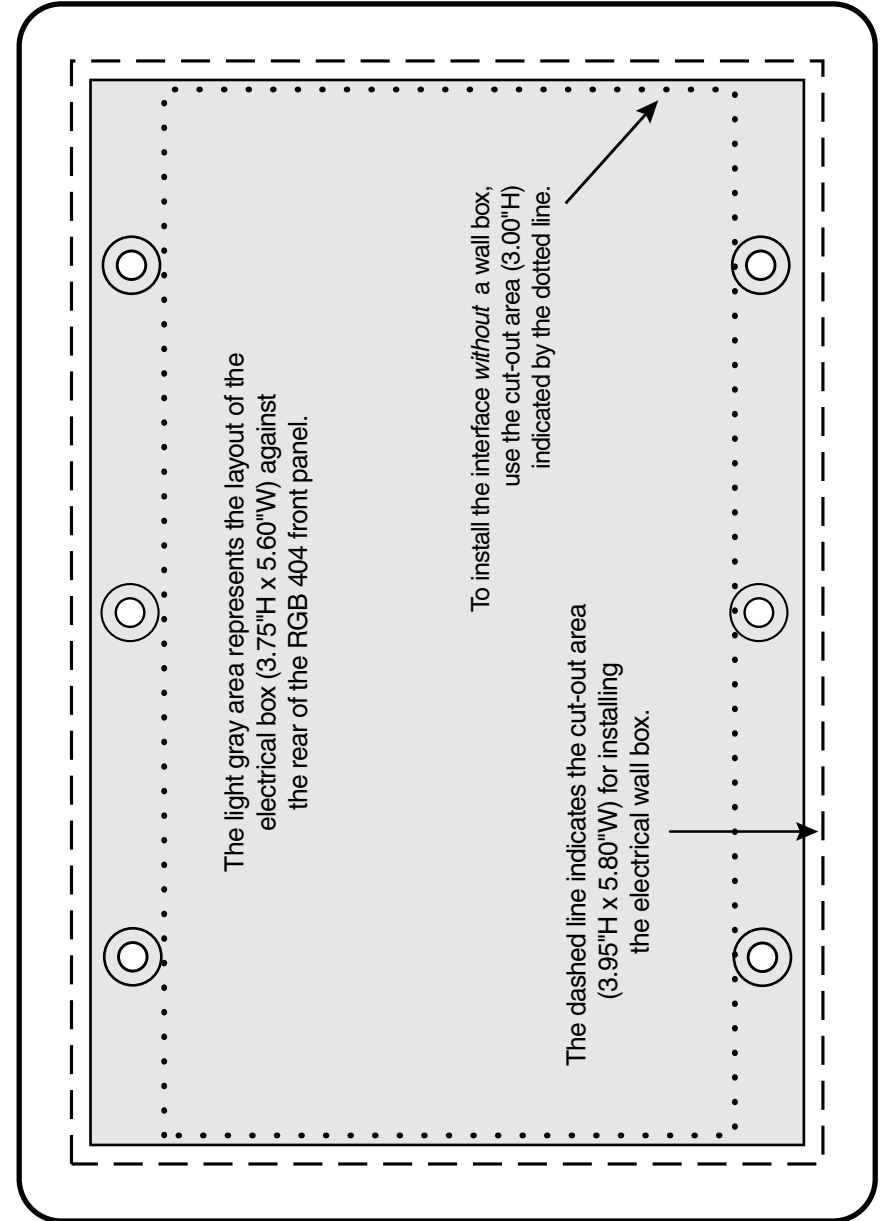



# Appendix C

## Dimensions

RGB 404 Panel Dimensions

RGB 406 Panel Dimensions

RGB 408 Panel Dimensions

RGB 408 Panel Dimension Details

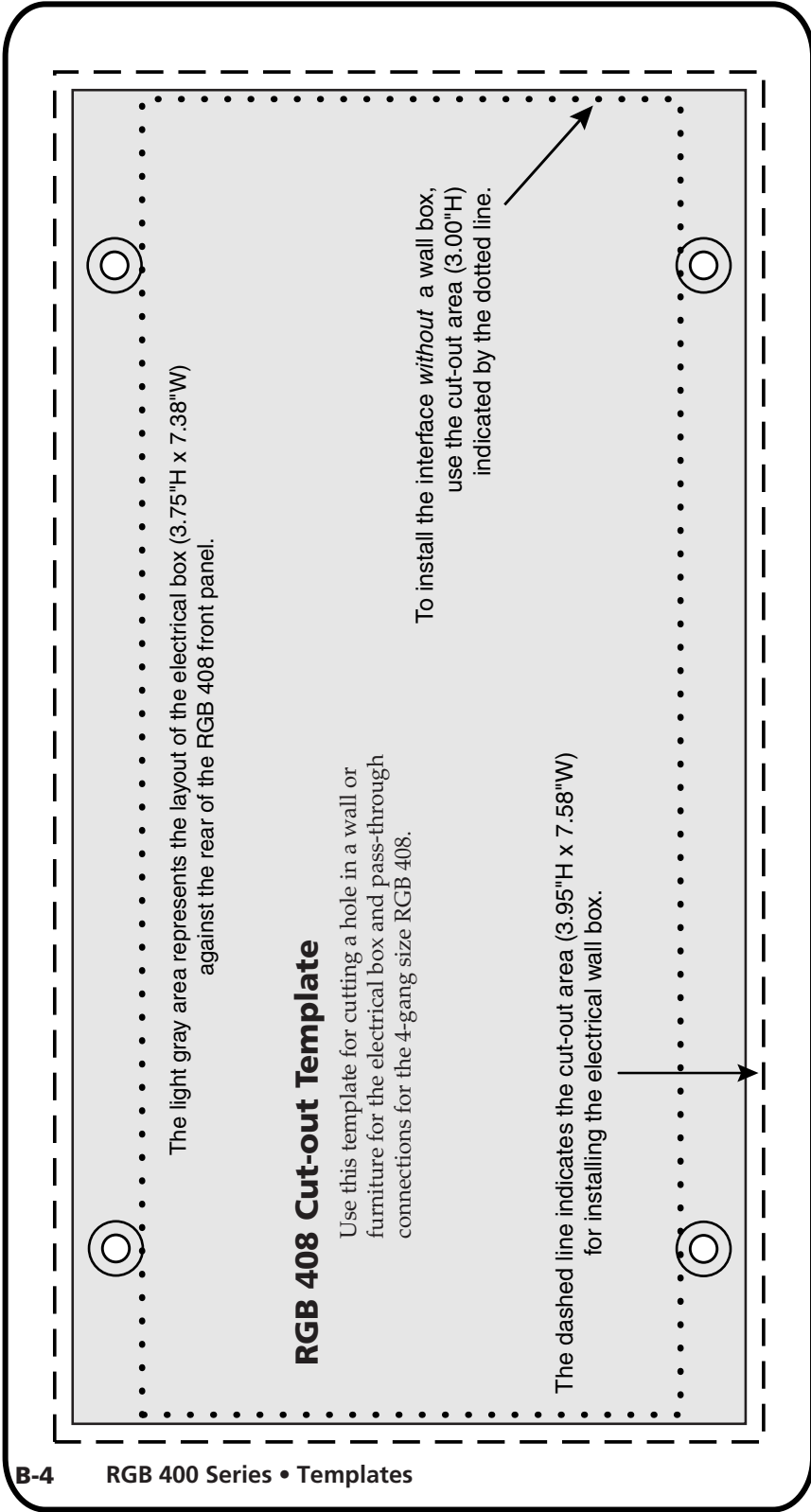



RGB 408 Panel Dimensions

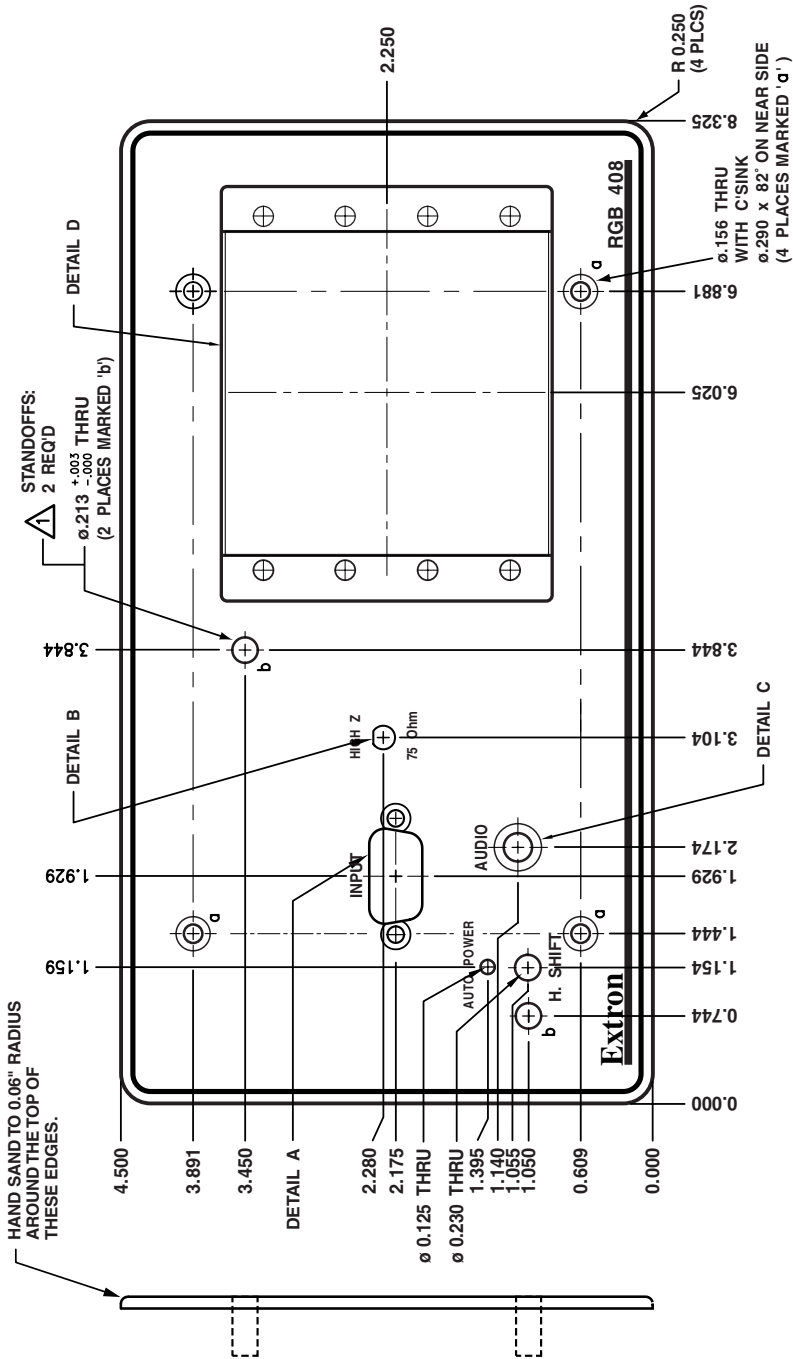

RGB 408 Panel Dimension Details

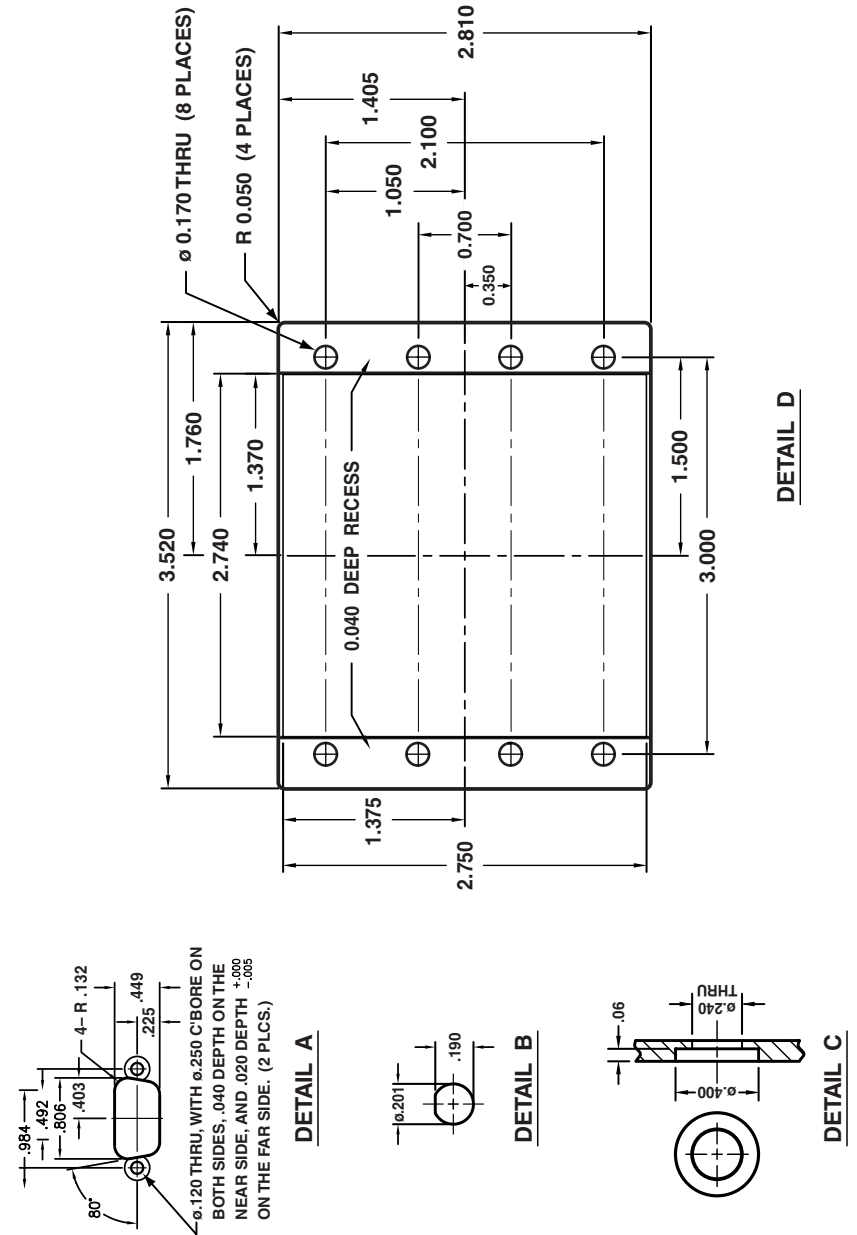





# D

## **Appendix D**

### **Accessories and Part Numbers**

Interfaces and Included Parts

Accessories and Connectors

Cables

Optional Adapter Plates

## Part Numbers and Accessories

### Interfaces and Included Parts

This section lists the interfaces and the main parts that are shipped with each model. All models include:

- this manual, part number 68-364-01,
- one standard cable clamp with two machine screws, and
- four 3/8 inch, flathead screws (for attaching the faceplate).

Interfaces and included parts	Part number
RGB 404G (gray faceplate)	60-237-01
RGB 404B (black faceplate)	60-237-02
RGB 404W (white faceplate)	60-237-03
0.31" diameter plastic plug (1) *	
0.50" diameter plastic plug (1) *	
3.5 mm, 10-pole captive screw connector	10-319-11
RGB 406G (gray faceplate)	60-249-01
RGB 406B (black faceplate)	60-249-02
RGB 406W (white faceplate)	60-249-03
RGB 408G (gray faceplate)	60-307-01
RGB 408B (black faceplate)	60-307-02
RGB 408W (white faceplate)	60-307-03
EMI strips (two, 4-inch)	100-107-01
Blank, single-height adapter plates	70-090-01/-11/-21
Blank, double-height adapter plate	70-090-02/-12/-22

\* These plugs can replace unused pass-through connectors.

### Accessories and Connectors

Accessories/connectors	Part number
12VDC, 1A external power supply (from 100 to 240 VAC, 50/60 Hz)	70-055-01
3.5 mm, 5-pole captive screw connector	10-319-10
BNC mini HR crimp connectors (qty. = 50)	100-074-51
BNC SHR crimp connectors (qty. = 50)	100-075-51
BNC bulkhead connectors (qty. = 50) (for custom wallplates)	100-076-51
BNC 5½" extension male-female mini HR RGBHV 5 cable kit	70-113-01

### Cables

Monitor breakout cables	Part number
MBC VGA/XGA HR	26-162-01
MBC Mac/Quadra	26-018-02
MBC Sun/Sparc HR	26-424-01
MBC SGI/13W3 HR	26-425-01

Below is a listing of some of the laptop breakout cables and other cables available for use with RGB 400 Series interfaces. A variety of lengths is available for each type of cable. See the Extron product catalog or call Extron's support hotline for details.

Laptop breakout cables	Part number
LBC VGA HR 3'	26-224-02
LBC VGA HR 6'	26-224-01
LBC VGA HR 12'	26-224-03
LBC Mac HR 6'	26-363-01
LBC Sun HR 6' (61 kHz)	26-413-01
LBC Sun HR 6' (71 kHz)	26-413-02
LBC Sun HR 6' (81 kHz)	26-413-03
LBC Mac/VGA HR	26-394-01

Laptop breakout cables w/audio	Part number
LBC VGA HR 3'A	26-441-01
LBC VGA HR 6'A	26-441-02
LBC VGA HR 12'A	26-441-03
LBC Mac HR 6'A	26-442-02
LBC Sun HR 6'A (61 kHz)	26-443-02
LBC Sun HR 6'A (71 kHz)	26-444-02
LBC Sun HR 6'A (81 kHz)	26-445-02

Bulk cables (without connectors)	Part number
Bulk SHR-1, 500'	22-098-02
Bulk SHR-4, 500'	22-099-02
Bulk SHR-5, 500'	22-100-02
Bulk BNC 4-500' mini HR	22-032-02
Bulk BNC 5-500' mini HR	22-020-02
Bulk plenum BNC-5 mini HRP, 500'	22-103-02
Bulk plenum 17-conductor installation, 500'	22-111-03

## Part Numbers and Accessories, cont'd

### Pre-cut cables

BNC-5 cables are primarily used for applications that require RGBHV signals. BNC-4 cables are mainly used for RGBS signals. Either can be used to route composite video, S-video or RGB with sync on green. All of these cables come in lengths from 3 feet to 300 feet, and all have male BNC connectors on both ends. The BNC-5 HR cables are also available in a plenum version.

Pre-cut high resolution cables	Part number
BNC-4-25'MHR (25 feet/7.5 meters)	26-210-04
BNC-4-300'MHR (300 feet/90.0 meters)	26-210-53
BNC-5-25'MHR (25 feet/7.5 meters)	26-260-03
BNC-5-300'MHR (300 feet/90.0 meters)	26-260-14

### Optional Adapter Plates

A variety of optional adapter plates for pass-through connections may be ordered for the RGB 408 interface. The RGB 408 can have up to 4 adapter plates installed in one of the following configurations:

- four adapter plates with a "plate size" of one,
- two adapter plates with a plate size of one and one adapter plate with a plate size of two,
- or two adapter plates with a plate size of two.

The RGB 408 is shipped with two single height blank plates (part #70-090-01/-11/-21) and one double height blank plate (part #70-090-02/-12/-22).

The tables on the following page list some of the available adapter plates. Contact Extron for a complete list.

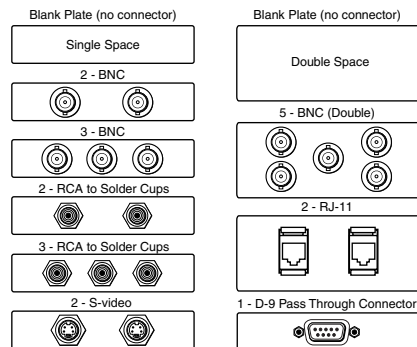

**Architectural adapter plates**

Adapter plate description	Plate size	Front connector type	Rear connector type	Part #	Color		
					Gray	Black	White
2 BNC barrel (female to female)	1	BNC female	BNC female	70-091	-01	-11	-21
3 BNC barrel (female to female)	1	BNC female	BNC female	70-091	-02	-12	-22
5 BNC barrel (female to female)	2	BNC female	BNC female	70-091	-03	-13	-23
2 RCA to BNC barrel (female to female)	1	RCA female (red/black)	BNC female	70-094	-01	-11	-21
3 RCA to BNC barrel (female to female)	1	RCA female (red/black)	BNC female	70-094	-02	-12	-22
2 S-video to S-video barrel (fem. to fem.)	1	4-pin mini DIN female	4-pin mini DIN female	70-095	-01	-11	-21
2 1/4" stereo phono female	1	1/4" stereo phono female	3 solder lug terminals	70-097	-01	-11	-21
2 3.5mm mini stereo female	1	3.5mm mini stereo female	3 solder lug terminals	70-098	-01	-11	-21
2 RJ-45 (female to female)	2	RJ-45 female	RJ-45 female	70-100	-01	-11	-21
1 HD-15 (female to female)	1	15-pin HD female	15-pin HD female	70-101	-01	-11	-21
1 D-9 (female to female)	1	9-pin D female	9-pin D female	70-102	-01	-11	-21
1 3-pin XLR female	2	3-pin XLR female	3 solder lug terminals	70-103	-01	-11	-21
2 6-pin mini DIN (keyboard/mouse)	1	6-pin mini DIN female	6-pin mini DIN female	70-104	-01	-11	-21
1 3.5mm, 5 pole captive screw terminal	1	3.5mm, 5 pole captive screw	solder cups	70-105	-01	-11	-21
1 contact closure switch/LED show-me and 3.5mm stereo mini jack	1	contact closure switch and 3.5mm mini stereo jack	solder cups	70-106	-01	-11	-21

Multi Type Connector Architectural Adapter Plates							
Adapter plate description	Plate size	Front connector type	Rear connector type	Part #	Gray	Black	White
1 S-video female and 3 RCA female	2	4-pin mini DIN female and RCA female	4-pin mini DIN female and RCA female	70-107	-02	-12	-22
1 BNC female and 1 3.5mm mini stereo jack	1	BNC female and 3.5mm mini stereo jack	BNC female and 3 solder cups	70-108	-02	-12	-22

## **Part Numbers and Accessories, cont'd**

---