

# **pH/ORP HART® Analyzer/Controller**



## **ESSENTIAL INSTRUCTIONS**

### **READ THIS PAGE BEFORE PROCEEDING!**

Rosemount Analytical designs, manufactures, and tests its products to meet many national and international standards. Because these instruments are sophisticated technical products, you must properly install, use, and maintain them to ensure they continue to operate within their normal specifications. The following instructions must be adhered to and integrated into your safety program when installing, using, and maintaining Rosemount Analytical products. Failure to follow the proper instructions may cause any one of the following situations to occur: Loss of life; personal injury; property damage; damage to this instrument; and warranty invalidation.

- Read all instructions prior to installing, operating, and servicing the product. If this Instruction Manual is not the correct manual, telephone 1-800-654-7768 and the requested manual will be provided. Save this Instruction Manual for future reference.
- If you do not understand any of the instructions, contact your Rosemount representative for clarification.
- Follow all warnings, cautions, and instructions marked on and supplied with the product.
- Inform and educate your personnel in the proper installation, operation, and maintenance of the product.
- Install your equipment as specified in the Installation Instructions of the appropriate Instruction Manual and per applicable local and national codes. Connect all products to the proper electrical and pressure sources.
- To ensure proper performance, use qualified personnel to install, operate, update, program, and maintain the product.
- When replacement parts are required, ensure that qualified people use replacement parts specified by Rosemount. Unauthorized parts and procedures can affect the product's performance and place the safe operation of your process at risk. Look alike substitutions may result in fire, electrical hazards, or improper operation.
- Ensure that all equipment doors are closed and protective covers are in place, except when maintenance is being performed by qualified persons, to prevent electrical shock and personal injury.

### **WARNING** **ELECTRICAL SHOCK HAZARD**

Making cable connections to and servicing this instrument require access to shock hazard level voltages which can cause death or serious injury, therefore, disconnect all hazardous voltage before accessing the electronics.

Relay contacts made to separate power sources must be disconnected before servicing.

Electrical installation must be in accordance with the National Electrical Code (ANSI/NFPA-70) and/or any other applicable national or local codes.

Unused cable conduit entries must be securely sealed by non-flammable closures to provide enclosure integrity in compliance with personal safety and environmental protection requirements. Use NEMA 4X or IP65 conduit plugs supplied with the instrument to maintain the ingress protection rating (IP65).

For safety and proper performance this instrument must be connected to a properly grounded three-wire power source.

Proper relay use and configuration is the responsibility of the user. No external connection to the instrument of more than 60VDC or 43V peak allowed with the exception of power and relay terminals. Any violation will impair the safety protection provided.

Do not operate this instrument without front cover secured. Refer installation, operation and servicing to qualified personnel.

### **WARNING**

This product is not intended for use in the residential, commercial or light industrial environment per  certification to EN50081-2.

#### **Emerson Process Management**

##### **Liquid Division**

2400 Barranca Parkway  
Irvine, CA 92606 USA  
Tel: (949) 757-8500  
Fax: (949) 474-7250

<http://www.raihome.com>

**CAUTION**

Ground conduit to metal stiffener or to metal enclosure. Use non-flammable watertight conduit fittings/plugs to preserve enclosure rating.

**DANGER**

 **LIVE VOLTAGES MAY BE PRESENT**  
When fuse or this cover is removed will cause severe injury or death.

**CAUTION**

For continued protection against fire, replace only with fuses of specified voltage and current ratings. Fuses are located under this cover.

**VAROVANI**

Zemnici vodici musi byt vodive spojen s kostrou pristroje. Pouzivejte nehorlavé vodotesné průchodky, abyste zachovali stupeň krytí pristroje.

**NEBEZPECI**

 **ZARIZENI POD NAPETIM**  
Odstraneni pojistky nebo tohoto krytu muze zpusobit vazne zraneni nebo smrt.

**VAROVANI**

Poskozene pojistky nahrazujte pouze pojistkami se stejným jmenovitým napetím a proudem. Pojistky jsou umístěny pod tímto krytem.

**FORSIGTIG**

Brug uantændelig vandtæt forskrning som sikkerhed for bevaring af kapslings klasse.

Jordforbindelse til metal kapsel.

**FARE**

 **UBESKYTTET SPÆNDING**  
Hvis sikringen eller denne påskrift fjernes kan dette medføre alvorlige kvæstelser eller død.

**FORSIGTIG**

Brug kun sikringer med nærmere angivet spænding og strømstyrke som sikkerhed for vedvarende beskyttelse mod brandfare. Sikringerne er placeret under denne påskrift.

**ATENCION**

La toma a tierra debe hacerse a un contrafuerte de metal o a la caja metálica. Utilice accesorios/enchufes no inflamables y estancos al agua para preservar las especificaciones de la caja.

**PELIGRO**

 **VOLTAJE PUEDE ESTAR PRESENTE**  
Cuando los fusibles o esta cubierta son removidos causará severas lesiones o muerte.

**ATENCION**

Para una protección continua contra el fuego, reemplace solamente con fusibles de voltaje y corriente especificados. Los fusibles se encuentran debajo de esta cubierta.

**VOORZICHTIG**

Aardleiding naar metalen profiel of naar metalen behuizing. Gebruik onbrandbare, waterdichte wartels en pluggen om de beschermingsklasse te handhaven.

**GEVAAR**

 **KAN ONDER SPANNING STAAN**  
Verwijderen van zekering of dit deksel kan dit leiden tot ernstig of dodelijk letsel.

**VOORZICHTIG**

Voor duurzame bescherming tegen brand, uitsluitend zekeringen gebruiken met aangegeven nominale spannings- en stroomwaarden. De zekeringen bevinden zich onder dit deksel.

**ATTENTION**

Raccorder le tube à la masse métallique d'une entretoise ou du coffret. Utiliser des raccords et des bouchons étanches ininflammables afin de préserver la classification du boîtier.

**DANGER**

 **POSSIBILITE DE HAUTE TENSION**  
En cas de démontage de ce capot ou des fusibles. Risques de Blessures graves ou de mort

**ATTENTION**

Afin d'assurer une protection permanente contre le feu, ne remplacer les fusibles que par des modèles équivalents en tension et en courant. Les fusibles se trouvent derriere cette plaquette.

**ADVARSEL**

Kabelinnføring må jordes til metallavstiver eller til metalenkapslingen. Bruk flammesikre og vannette nipler/plugger slik at kapslingens tetthetsgrad opprettholdes.

**FARE**

 **SPENNING KAN VÆRE TIL STEDE**  
når sikringen eller dette dekslet fjernes, og kan føre til alvorlige skader eller dødsulykker.

**ADVARSEL**

For at beskyttelse mot antennelse skal opprettholdes, må sikringer bare erstattes med tilsvarende som har spesifisert spenning- og strømstyrke. Sikringer er plassert under dette dekslet.

**ACHTUNG**

Der Analysator ist vorschriftsmässig zu erden.

Um die Schutzart des Gerätes sicherzustellen ist es mit den entsprechenden Kabelverschraubungen und Blindkappen auszurüsten.

**ACHTUNG**

 **GEFAEHRLICHE ELEK-TRISCHE SPANNUNG**  
Ist die Schutzabdeckung oder die Sicherung entfernt, so koennen am Geraet ernsthafte oder toedliche Verletzungen entstehen.

**ATTENTION**

Um die Gefahr von Kurzschluß und Funkenbildung zu verhindern dürfen die Sicherungen nur durch solche gleicher Spannung und Stromwerte ausgetauscht werden. Die Sicherungen befinden sich unter dieser Abdeckung.

**Attenzione**

Tubo di protezione per messa a terra con elemento di ingresso in metallo o con custodia in metallo.

Utilizzare accessori/connettori del tubo di protezione a tenuta stagna, non infiammabili, per assicurare i limiti di resistenza della custodia

**Pericolo**

 **POSSIBILE PRESENZA DI ALTA TENSIONE**  
La rimozione del fusibile o del coperchio può causare gravi lesioni o morte.

**ATTENZIONE**

Per garantire una continua protezione contro gli incendi, sostituire solo con fusibili del voltaggio indicato e dell'attuale potenza. I fusibili sono alloggiati sotto il coperchio.

**UWAGA**

Uziemij przewód do metalowego płaskownika lub obudowy. Aby zachować stopień szczelności obudowy stosuj niepalne, wodoszczelne dławiki.

**NIEBEZPIECZENSTWO**

 **URZADZENIE MOZE BYC POD NAPIECIEM**  
Gdy bezpieczniki lub ta pokrywa sa usunięte istnieje mozliwosc uszkodzenia ciała lub śmierci.

**UWAGA**

W celu utrzymania zabezpieczenia przed zapaleniem, należy stosować bezpieczniki o identycznym z oryginalnym napięciu i amperażu. Bezpieczniki sa umieszczone pod ta pokrywa.

**ATENÇÃO**

Ligar a conducta de cabos à terra através de suporte ou invólucro metálicos. Utilize bujins e acessórios ignífugos e estanques para preservação da estanqueidade.

**PERIGO**

 **POSSIBILIDADE DE TENSÃO PERIGOSA**  
A remoção do fusível ou desta tampa pode causar lesões graves ou a morte.

**ATENÇÃO**

Para manter sempre uma boa proteção contra incêndio, substituir somente por fusíveis com a tensão e corrente especificadas. Os fusíveis encontram-se sob esta tampa.

**IAKTTAG FÖRSIKTIGHET**

Anslutningspunkt är jordad till chassi. Använd brandsäker, vattentät kabelanslutning för att bevara klassificering av apparatskåp.

**FARA**

 **HÖGSPÄNNING KAN FÖREKOMMA**  
Avlägsnande av säkring eller skyddskåpa kan förorsaka allvarlig skada eller dödsfall

**IAKTTAG FÖRSIKTIGHET**

För kontinuerligt skydd mot brandfara, ersätt endast med specificerad säkringsstorlek och spänning.

# MODEL 54E PH/ORP MICROPROCESSOR ANALYZER

## TABLE OF CONTENTS

Section Title	Page
<b>1.0 DESCRIPTION AND SPECIFICATIONS .....</b>	<b>1</b>
1.1 General Description .....	1
1.2 Description of Controls .....	1
1.3 Specifications.....	2
1.4 Ordering Information.....	4
 <b>2.0 INSTALLATION.....</b>	 <b>5</b>
2.1 Locating the Controller .....	5
2.2 Unpacking and Inspection .....	5
2.3 Mechanical Installation .....	5
 <b>3.0 WIRING .....</b>	 <b>7</b>
3.1 General.....	7
3.2 Power Input Wiring .....	7
3.3 Analog Output Wiring .....	7
3.4 Alarm Relay Output Wiring.....	7
3.5 pH Sensor Wiring .....	9
3.6 Final Electrical Check.....	12
 <b>4.0 CALIBRATION .....</b>	 <b>14</b>
4.1 Temperature Calibration .....	15
4.2 Automatic Two-Point Calibration .....	16
4.3 Manual Two-Point Calibration.....	18
4.4 Single-Point pH Calibration .....	19
4.5 Compensation Options .....	20
4.6 pH Slope Adjustment.....	20
4.7 Hold Mode .....	21
4.8 Trim Outputs.....	21
 <b>5.0 SOFTWARE CONFIGURATION .....</b>	 <b>22</b>
5.1 Changing Alarm Setpoints .....	26
5.2 Changing Output Setpoints (PID only) .....	27
5.3 Changing Output Setpoints (Normal) .....	28
5.4 Testing Outputs and Alarms .....	29
5.5 Choosing Display Options .....	31
5.6 Changing Output Parameters.....	33
5.7 Changing Alarm Parameters .....	36
5.8 On-Line Diagnostics Setup.....	42
5.9 Auto Calibration Setup .....	43

**TABLE OF CONTENTS (CONTINUED)**

<b>Section</b>	<b>Title</b>	<b>Page</b>
<b>6.0</b>	<b>THEORY OF OPERATION.....</b>	<b>45</b>
6.1	The pH Sensor Assembly.....	45
6.2	Continuous Sensor Diagnostics.....	45
6.3	Interval Timer.....	46
6.4	Alarm Relays.....	47
6.5	Time Proportional Control (TPC) Mode.....	47
6.6	Normal Mode.....	48
6.7	Analog Outputs.....	48
6.8	Controller Mode Priority.....	49
6.9	PID Control.....	50
<b>7.0</b>	<b>SPECIAL PROCEDURES AND FEATURES.....</b>	<b>54</b>
7.1	Password Protection.....	54
7.2	Configuring Security.....	55
7.3	Solution Temperature Compensation.....	56
<b>8.0</b>	<b>TROUBLESHOOTING.....</b>	<b>58</b>
8.1	Displaying Diagnostic Variables.....	61
8.2	Troubleshooting Guidelines.....	63
8.3	Replacement Parts.....	69
<b>9.0</b>	<b>RETURN OF MATERIALS.....</b>	<b>70</b>
<b>Appendix</b>	<b>Title</b>	<b>Page</b>
<b>A</b>	<b>ORP CONFIGURATION.....</b>	<b>71</b>

**LIST OF TABLES**

<b>Table No.</b>	<b>Title</b>	<b>Page</b>
5-1	pH Settings List.....	22
5-2	Standard Buffers.....	44
6-1	Controller Mode Priority Chart.....	49
8-1	Diagnostic Messages.....	59
8-2	Quick Troubleshooting Guide.....	60
8-3	Troubleshooting Guide.....	66
A-1	ORP Settings List.....	72

## TABLE OF CONTENTS (CONTINUED)

### LIST OF FIGURES

Figure No.	Title	Page
1-1	Main Display Screen.....	1
2-1	Wall Mounting.....	5
2-2	Pipe Mounting.....	6
2-3	Panel Mounting.....	6
3-1	Power Input and Relay Output Wiring for Model 54e pH/ORP.....	8
3-2	Sensor Wiring Photo.....	9
3-3	Sensor Wiring Diagram.....	10
3-4	Cable Dressing.....	11
3-5	Wiring for Sensors that have Solution Grounds.....	11
3-6	Wiring for Sensors without Solution Grounds Directly to Analyzer.....	12
3-7	Wiring for Sensors without Solution Grounds to a Junction Box.....	12
3-8	Wiring to Model 399-14.....	13
5-1	Menu Tree.....	25
5-2	Interval Timer Examples.....	41
6-1	Time Proportional Control.....	47
6-2	The Process Reaction Curve.....	52
8-1	Theoretical pH vs. Millivolt Values at 25°C (77°F).....	62
8-2	Junction Box Preamplifier Check.....	65
8-3	Controller Preamplifier Check.....	65
A-1	Outline of Menu Levels for ORP.....	74

---

## About This Document

This manual contains instructions for installation and operation of the Model 54e pH/ORP HART Analyzer/Controller. The following list provides notes concerning all revisions of this document.

<u>Rev. Level</u>	<u>Date</u>	<u>Notes</u>
0	5/00	This is the initial release of the product manual. The manual has been reformatted to reflect the Emerson documentation style and updated to reflect any changes in the product offering.
0	11/01	Added trip output infor & fixed panel dimension reference.
A	3/02	Updated multiple drawings & added menus.
B	7/02	Fixed setpoint example screen on page 27.
C	4/03	Updated CE info.
D	7/04	Fixed power and weight specs on page 2.
E	3/05	Updated recommended sensors on page 3.
F	4/05	Added note re ordering circuit board stack on page 69.
G	2/06	Updated Figure 1, Menu tree.

# SECTION 1.0

## DESCRIPTION AND SPECIFICATIONS

### 1.1 GENERAL DESCRIPTION

The Model 54e pH/ORP analyzer/controller monitors and controls pH in chemical processes used in many industries. This manual's sections and appendices cover the system's configuration, calibration, and maintenance, and provides a troubleshooting guide.

All adjustments to the current outputs, alarm relays, and calibration of the pH and temperature inputs can be made using the controller's membrane keypad.

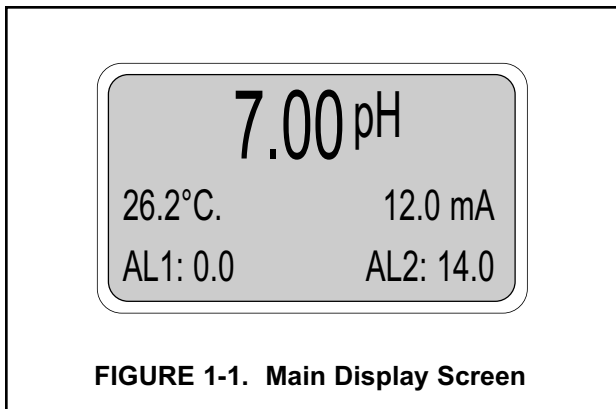

### 1.2 DESCRIPTION OF CONTROLS

Figure 1-1 shows a diagram of the main display screen. Similar diagrams are used throughout this manual. The primary variable is continuously displayed in large numerals. The process temperature and primary current output value are always displayed on the second line of the main display screen. The third line can be configured to read several different items, as desired. In this case, it is displaying setpoints for alarms 1 and 2.

The F1-F4 keys are multifunction. The active operation for that key is displayed as a label just above each function key as needed. For example, F1 is usually labeled Exit and F4 may be labeled Edit, Save, or Enter. Pressing Enter (F4) will access sub-menus, while pressing Edit allows changing values and Save stores the values in memory. Esc (F3) can be used to abort unwanted changes. Exit (F1) returns to the previous screen. Other labels may appear for more specialized tasks.

The up (↑) and down (↓) keys are used to:

1. Move the cursor (shown in reverse video) up and down on the menu screens.
2. Scroll through the list of options available for the field shown in reverse video. **When the last item of a menu has been reached, the cursor will rest on the third line of the display. If the cursor is on the second line, there are more items to see with the down arrow key.**
3. Scroll through values when a highlighted numerical value is to be set or changed.

The right and left keys are used to move the cursor to the next digit of a number.

Green LEDs (labeled 1, 2, and 3) indicate when alarm relays 1, 2, and 3 are energized. The fourth relay indicates a fault condition. When a fault occurs, the red LED (labeled FAIL) lights up, a descriptive error message is displayed, and the action of the outputs and relays will be as described in Section 5.6 and Section 5.7 under fault value (e.g. 22 mA).

The red LED also indicates when the interval timer routine is activated and when the time limit has been reached on a feed limit timer. For more information on these subjects, see Section 5.7.

## 1.3 SPECIFICATIONS

### PHYSICAL SPECIFICATIONS - GENERAL

**Enclosure:** Epoxy-painted aluminum, NEMA 4X (IP65), 144 X 144 X 132 mm, DIN size (5.7 X 5.7 X 5.2 in.)

**Front Panel:** Membrane keyboard with tactile feedback and user selectable security. Light gray, blue and white overlay. Light gray enclosure, dark gray bezel

**Display:** Back-lit dot matrix LCD (7.0 x 3.5 cm), blue on gray-green. The display contrast is compensated for ambient temperature.

**Process Variable Character Height:** 16mm (0.6 in.)

#### Electrical Classification:

Class I, Division 2, Groups A, B, C, & D.

T5 Ta=50°C. Dust ignition proof: Class II, Division 1, Groups E, F, & G; Class III.

CSA-LR34186:

Max. relay contact rating: 28 Vdc; 110 Vac;  
230 Vac; 6 amps resistive

FM: Max. relay contact rating: 28 Vdc resistive

150 mA - Groups A & B;

400 mA - Group C;

540 mA - Group D

#### Power:

Code -01: 100 - 127 VAC, 50/60 Hz  $\pm$  6%, 6.0 W  
200 - 253 VAC, 50/60 Hz  $\pm$  6%, 6.0 W

Code -02: 20 - 30 VDC, 6.0 W

#### Current Outputs:

Output 1: pH, ORP, temperature, glass impedance, or reference impedance.

Output 2: pH, ORP, temperature, glass impedance, or reference impedance.

Each output is galvanically isolated, 0-20 mA or 4-20 mA into 600 ohms maximum load at 115/230 Vac or 24 Vdc (Code -02) or 550 ohms maximum load at 100/200 Vac. Output 1 includes digital signal 4-20 mA superimposed HART (Code -09 only).

RFI/EMI: EN-61326



LVD (Code -01 only): EN-61010-1

**Ambient Temperature:** 0 to 50°C (32 to 122°F)

NOTE: The analyzer is operable from -20 to 60°C (-4 to 140°F) with some degradation in display performance.

**Relative Humidity:** 95%, non condensing

#### Alarms:

Relay 1 - Process, Interval\*, or Time Proportional Control (code -20)

Relay 2 - Process, Interval\*, or Time Proportional Control (code -20)

Relay 3 - Process, Interval\*, or Time Proportional Control (code -20)

Relay 4 - Sensor/analyzer and process fault alarm

Each relay has a dedicated LED on the front panel.

\*maximum of one interval timer

**Relay Contacts:** Relays 1-3: Epoxy sealed form A contacts, SPST, normally open

Relay 4: Epoxy sealed form C, SPDT

	<u>Resistive</u>	<u>Inductive</u>
28 Vdc	5.0 Amps	3.0 Amps
115 Vac	5.0 Amps	3.0 Amps
230 Vac	5.0 Amps	1.5 Amps

**Weight/Shipping Weight:** 1.8 kg/2.3 kg (4 lb/5 lb)



**The Model 54e when configured as a pH analyzer**, requires a dual (glass and reference) impedance pre-amplifier (patent pending). This preamp converts the high impedance pH glass electrode signal to a low impedance signal. The preamplifier may be located in one of three areas: 1) in the pH sensor for best performance, 2) in a remote junction box when process temperatures exceed 80°C (176°F) in submersion applications, or 3) in the analyzer when the distance between the pH sensor and the analyzer is 4.5 meters (15 feet) or less.

The Model 54e pH measures over the full range of 0-14 pH. The current output may be calibrated to represent any 1 to 14 pH span.

A two-point calibration is made by immersing the sensor in two different buffer solutions and entering the pH values. When two buffers are used, the micro-processor automatically calculates the electrode slope which is used for self-diagnostics. The electrode slope can be read on the display and manually adjusted. A one-point process standardization is easily accomplished by entering the pH value of a grab sample.

### **ANALYZER SPECIFICATIONS @ 25°C**

**Measurement Range:** 0 to 14 pH

**Output Scale Expansion:** Zero suppression: up to 13 pH units

Span: Any pH from 1 to 14

**Accuracy:** ± 0.01 pH

**Repeatability:** ± 0.01 pH

**Stability:** ± 0.01 pH/month, non-cumulative

**Temperature Coefficient:** Input: ± 0.003 pH/°C  
Output: ± 0.006 pH/°C

**Temperature Compensation :** Pt 100 or Pt 1000 RTD,  
Automatic or Manual  
-15 to 120°C (5 to 248°F)

### **RECOMMENDED SENSORS:**

Model 320B Flow Through pH

Model 320HP High Purity pH

\*Model 328A Steam Sterilizable pH

\*Model 370 and 371 EuroSenz pH

Model 381+ Insertion/Submersion/Flow Through pH

\*Model 389 Disposable pH

\*Model 396/VP Disposable pH

Model 396P/VP Disposable pH

Model 396R/VP Retractable pH

Model 397 Quik Disconnect pH

Model 398/VP Insertion/Submersion pH

\*Model 398R/VP Retractable pH

\*Model 399 Disposable pH

\*Model Hx338 Steam Sterilizable pH

\*Model Hx348 Steam Sterilizable pH

**The Model 54e when configured as an ORP analyzer**, measures over a range of -1400 mV to +1400 mV in either the American convention (Oxidation Reduction Potential), or the European convention (Reduction Oxidation-Redox). Although temperature compensation is not used for ORP measurements, the process temperature is measured and displayed. Temperature measurement is made by an RTD located in the sensor assembly.

### **ANALYZER SPECIFICATIONS @ 25°C**

**Measurement Range:** -1400 to +1400 mV

**Output Scale Expansion:** Zero suppression: up to ±1300 mV  
Span: Any ORP range from 100 to 2800 mV

**Accuracy:** ± 1.0 mV

**Repeatability:** ± 1.0 mV

**Stability:** ± 1.0 mV/month, non-cumulative

**Temperature Coefficient:** Input: ± 0.2 mV/°C  
Output: ± 0.4 mV/°C

**Temperature Measurement:** -15 to 120°C (5 to 248°F)  
Pt 100 or Pt 1000 RTD

### **RECOMMENDED SENSORS:**

Model 330 Flow Through ORP

\*Model 371 EuroSenz ORP

Model 381+ Insertion/Submersion/Flow Through ORP

\*Model 389 Disposable ORP

Model 396P Disposable ORP

Model 396R Retractable ORP

Model 398 Insertion/Submersion ORP

Model 398VP Insertion/Submersion with VP 6.0 connector

Model 398R Retractable ORP

Model 398RVP Retractable ORP with VP 6.0 connector

**The Model 54e when ordered for ISE capability**, is suitable for use with a number of ion-selective electrodes. Consult the factory for available measurements and ranges.

**1.4 ORDERING INFORMATION**

The **Model 54e pH/ORP Microprocessor Analyzer** is housed in a rugged, NEMA 4X (IP65) epoxy- painted cast aluminum enclosure. Standard features include a back-lit dot-matrix liquid crystal display, sensor diagnostics, dual isolated outputs, and four relays. The analyzer can measure pH or ORP as configured by the user. For ISE capability, please consult the factory.

<b>MODEL 54e pH/ORP MICROPROCESSOR ANALYZER</b>	
<b>CODE</b>	<b>OPTIONS</b>
01	115/230 VAC, 50/60 Hz Power
02	24 VDC Power
<b>CODE</b>	<b>OPTIONS</b>
09	HART Communications Protocol
20	Controller Outputs - PID and TPC
<b>54e pH/ORP</b>	<b>-01 -20 EXAMPLE</b>

<b>ACCESSORIES</b>	
<b>PART NO.</b>	<b>DESCRIPTION</b>
2002577	Wall and two inch pipe mounting kit
23545-00	Panel mounting kit
23554-00	Cable glands, kit (Qty 5 of PG 13.5)
9240048-00	Stainless steel tag (specify marking)

## SECTION 2.0 INSTALLATION

This section is for installation of the controller.

### WARNING

All electrical installation must conform to the National Electrical Code, all state and local codes, and all plant codes and standards for electrical equipment. All electrical installations must be supervised by a qualified and responsible plant electrician.

### 2.1 LOCATING THE CONTROLLER

Position the Model 54e pH/ORP controller to minimize the effects of temperature extremes and to avoid vibration and shock. Locate the controller away from your chemical process to protect it from moisture and fumes.

Select an installation site that is more than 2 ft from high voltage conduit, has easy access for operating personnel, and is not exposed to direct sunlight.

### 2.2 UNPACKING AND INSPECTION

Inspect the exterior of the shipping container for any damage. Open the container and inspect the controller and related hardware for missing or damaged parts.

If there is evidence of damage, notify the carrier immediately. If parts are missing, contact Rosemount Analytical customer support.

### 2.3 MECHANICAL INSTALLATION

#### 2.3.1 Mounting the Controller

The Model 54e pH/ORP controller may be supplied with a mounting bracket accessory. If you use the mounting bracket on wall or pipe installations, avoid mounting on pipes which vibrate or are close to the process. The bracket may be modified to mount the controller on I-beams or other rigid members. You can also fabricate your own bracket or panel mount the controller using the bracket as an example.

#### 2.3.2 Wall or Surface Mounting:

1. Mount the bracket to the controller using the supplied four screws as shown in Figure 2-2.
2. Mount controller mounting bracket to wall using any appropriate fastener such as screws, bolts, etc (see Figure 2-1 below).

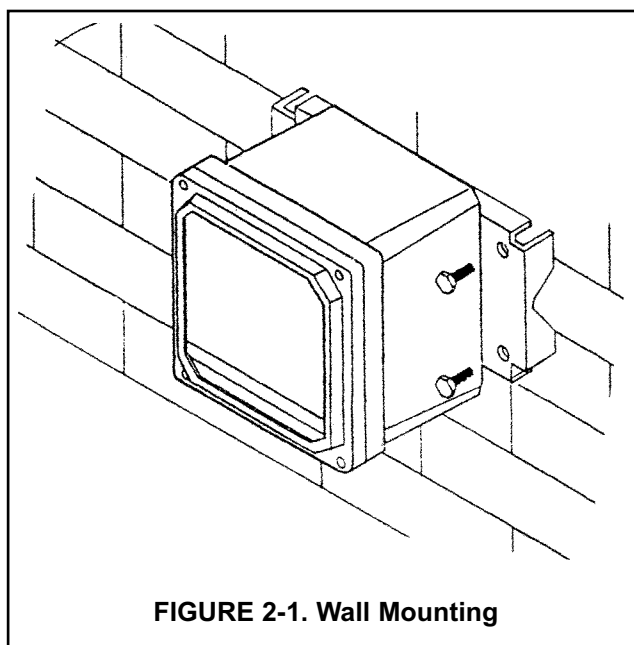

FIGURE 2-1. Wall Mounting

#### 2.3.3 Pipe Mounting:

1. Attach the mounting bracket to the rear of the controller and tighten the four screws as shown in Figure 2-2.
2. Place supplied U bolts around the mounting pipe and through the pipe mounting bracket and mounting bracket. Tighten the U bolt nuts until the controller is securely mounted to the pipe.

**2.3.4 Panel Mounting:**

The controller is designed to fit into a 5.43 x 5.43 inch (DIN standard 137.9 x137.9 mm) panel cutout (Figure 2-3). Installation requires both front and rear access.

1. Install the controller as shown in Figure 2-3. Insert the instrument enclosure through the front of the panel cutout and align the panel mounting brackets as shown.
2. Insert two mounting bracket screws through each of the two mounting brackets and into the tapped holes in the rear of the controller enclosure and tighten each screw.
3. Insert four panel mounting screws through each hole in the mounting brackets. Tighten each screw until the mounting bracket holds controller firmly in place. To avoid damaging the controller mounting brackets, do not use excessive force.

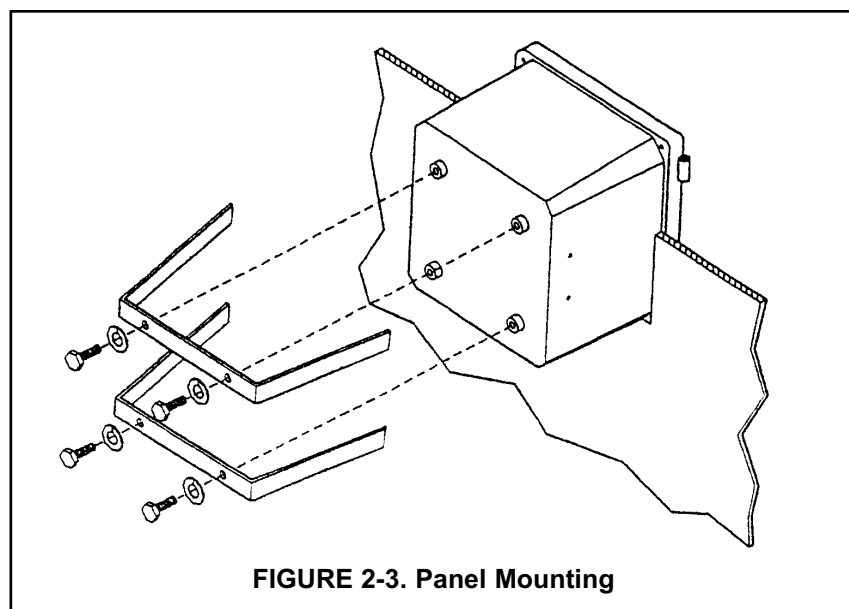
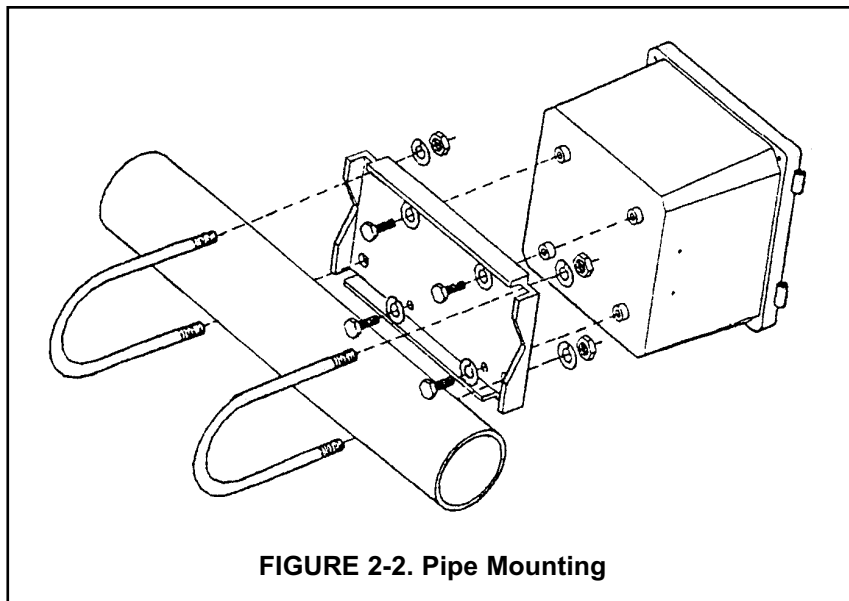

## SECTION 3.0 WIRING

### 3.1 GENERAL

#### WARNING

All electrical installation must conform to the National Electrical Code, all state and local codes, and all plant codes and standards for electrical equipment. All electrical installations must be supervised by a qualified and responsible plant electrician.

#### NOTE

Wire only the analog and alarm outputs required for your application. Be sure to read the warning at the beginning of Section 2.0.

The Model 54e pH/ORP has five access holes in the bottom of the instrument housing which accept ½-in. strain relief connectors or conduit fittings. Be sure to seal any unused access holes. As you face the front of the unit, the rear openings are for input power, and alarm relay signals. The opening on the front left is for sensor wiring only (DC). The front right is for analog output wiring.

#### NOTE

For best EMI/RFI protection, the output cable should be shielded and enclosed in an earth grounded, rigid, metal conduit. Connect the output cable's outer shield to the earth ground connection on TB2 (Figure 3-1)

### 3.2 POWER INPUT WIRING

Figure 3-1 depicts the wiring detail for the Model 54e pH/ORP. **Code -01:** connect AC power to TB3, terminals 1 and 2 for 115 VAC (terminals 2 and 3 for 230 VAC). **Code -02:** connect DC power to TB3 terminals 1 and 2. Connect earth ground to the nearby ground lug. A good earth ground is essential for proper operation of the controller. Be sure to provide a means of disconnecting the main power to the controller.

#### CAUTION

Do not apply power to the controller until all electrical connections are made.

#### WARNING

**Electrical connections to this equipment must be made in accordance with the current National and Local Electrical Codes in effect for the installation location.**

### 3.3 ANALOG OUTPUT WIRING

The analog output wiring consists of two 4-20 mA signals: output one from terminals 4 and 5, output 2 from 1 and 2 on TB2, as shown in Figure 3-1. These signals can be used for chart recorder, computer monitoring, or PID control output. The analog outputs can be programmed for 4-20 mA or for 0-20 mA, direct or reverse acting. Current output 1 includes superimposed HART (code -09 only).

### 3.4 ALARM RELAY OUTPUT WIRING

The controller has 3 "dry" alarm relay contacts which are normally open. Alarm 1 is across terminals 4 and 5 on TB3. This alarm is typically used to control the pump in a chemical feed system. Alarm 2 across terminals 6 and 7 on TB3 is usually used to operate a light or horn as a means of alerting the chemical process operator when pH/ORP is outside the control range. Alarm 3 is across terminals 8 and 9 on TB3. All 3 of these alarms may be activated on pH/ORP or temperature. They can also be used to control other pumps or valves provided they are programmed to do so. Refer to Section 5.0 to set up these functions.

All three alarm contacts on the Model 54e pH/ORP are rated for a maximum of 3 A (1.5A, 230 VAC, inductive load). If your associated pump or valve exceeds this, use a separate contact or relay rated for the external device.

To use a contact output to control a pump, valve, or light, the contact must be wired into a circuit together with a source of power for the device to be controlled. The power can be jumpered from the main power into the controller and the circuit can be wired as shown on the wiring diagrams, Figure 3-1.

#### PREAMPLIFIER SELECTION

The pH sensor signal requires a preamplifier at some point in the measuring circuit. The preamp can be inside the sensor, in the junction box, or in the controller. To allow for these options, the Model 54e pH/ORP has a jumper selectable preamp mounted on the CPU circuit board (Figure 3-3). The jumper is placed in the "analyzer" position when there is no preamp in the sensor (or junction box). Generally, this jumper is in the "sensor" position.

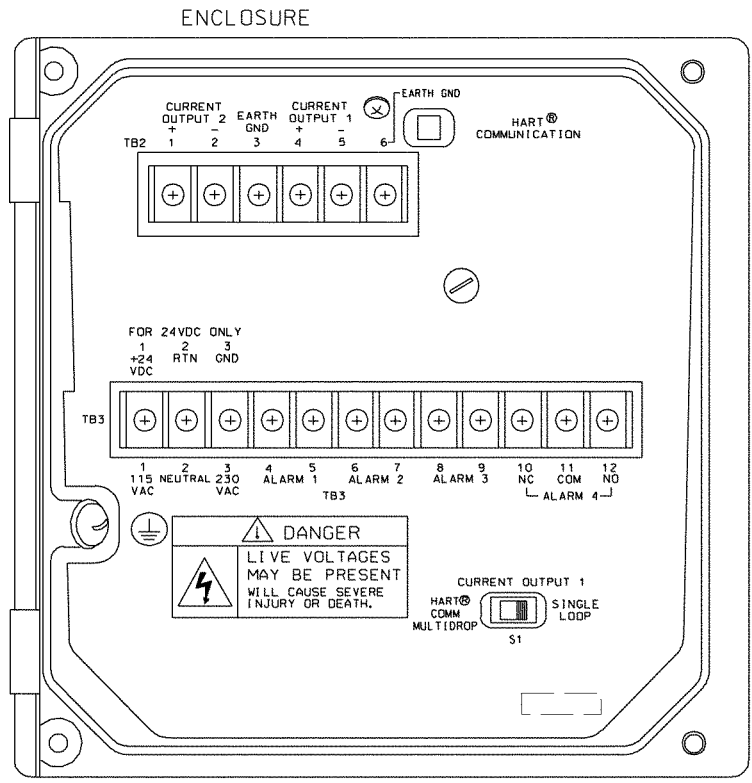

OUTPUT AND POWER WIRING

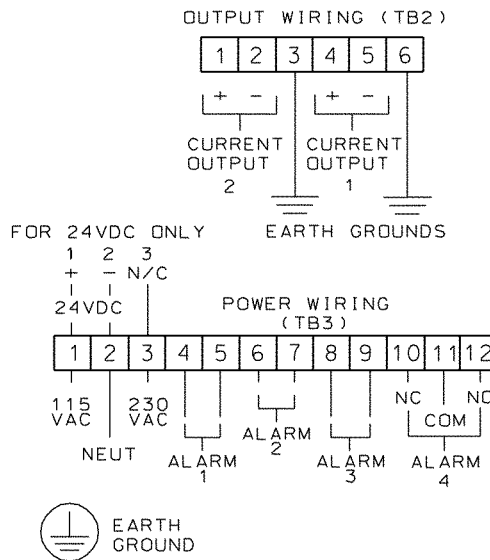

DWG. NO. 454EPH02	REV. D
----------------------	-----------

FIGURE 3-1. Power Input and Relay Output Wiring for Model 54e pH/ORP

**pH SENSOR COMPATIBILITY**

The following sensors contain solution grounds:

Models 381+, 385+, 396P, 396R

The use of these sensors will allow both glass and reference diagnostics.

Figure 3-3 shows how these sensors should be wired. Note that wiring connections depend on whether the sensor (or junction box) has a preamp or not. If the sensor (or j-box) has a preamp, then the preamp location jumper is moved accordingly and wiring connected as on the left of Figure 3-3. Otherwise, the jumper is moved to the "analyzer" position and wiring for TB1 is connected as on the right hand side.

Junction box (P/N 23550-00) wiring for sensors that contain a preamp is strictly point to point. All sensor leads are run to the junction box and carried through by the extension cable (P/N 9200273). Only use this recommended extension cable and be careful to connect all cable leads in the junction box. Sensors without preamps that require cable extension should be wired up to the junction box (P/N 23555-00) as per the appropriate sensor instruction manual.

The following sensors do not contain solution grounds but are compatible with the Model 54e pH/ORP:

Models 389-02-54, 396-54, 397-54, 399-09

Sensors without solution grounds must be wired differently (see Figure 3-6). Diagnostics will only be possible on the glass electrode side of the sensor.

When extending cable, the junction box with preamp (P/N 23555-00) must be used. See Figure 3-7 for wiring details.

**3.5 pH SENSOR WIRING**

Be sure that the pH sensor has been properly installed and mounted. Wire the sensor to the junction box (if so equipped) and/or Model 54e pH/ORP according to Figures 3-5 through 3-7, or use the wiring diagram drawing included inside the controller. Use a narrow-bladed screwdriver to facilitate sensor wiring (see Figure 3-2).

**The wiring diagrams show connections between the Model 54e pH/ORP and the junction box used where distance from the sensor to the controller exceeds the integral sensor cable length and interconnecting wire is required. The interconnecting sensor wire recommended is P/N 9200273. Use of this cable provides EMI/RFI protection and complete sensor diagnostics (for sensors so equipped). The maximum interconnecting wire length is 500 ft.**

**IMPORTANT**

**All interconnecting sensor cable ends must be properly dressed, as shown in Figure 3-4, to prevent the individual sensor and shield wires from shorting. All shields must be kept electrically separate all the way back to the terminals on the Model 54e pH/ORP. Check that there is no continuity between the shield wires and any other sensor conductors or shields prior to connecting the sensor wiring to the terminals on the Model 54e pH/ORP. FAILING TO FOLLOW THESE INSTRUCTIONS WILL RESULT IN CONTROLLER MALFUNCTION.**

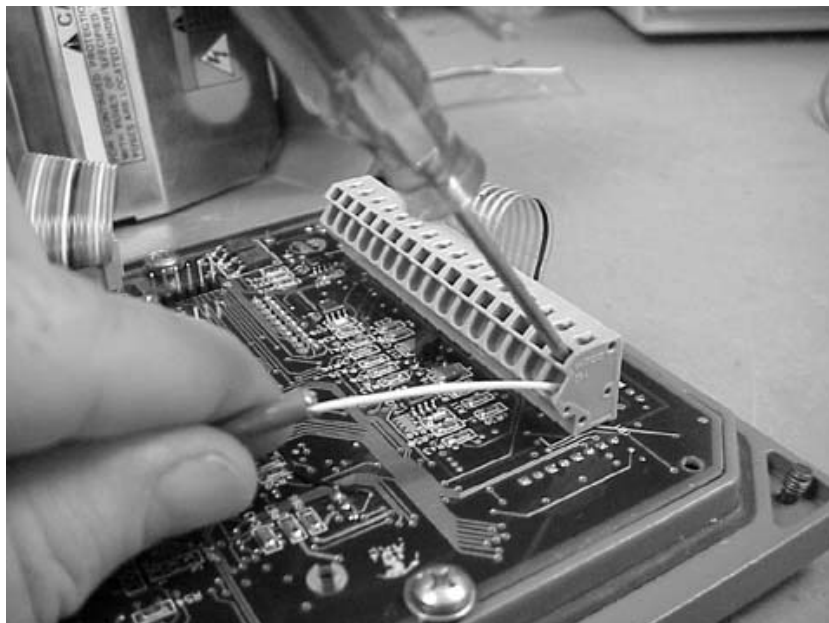

**FIGURE 3-2. Sensor Wiring Photo**

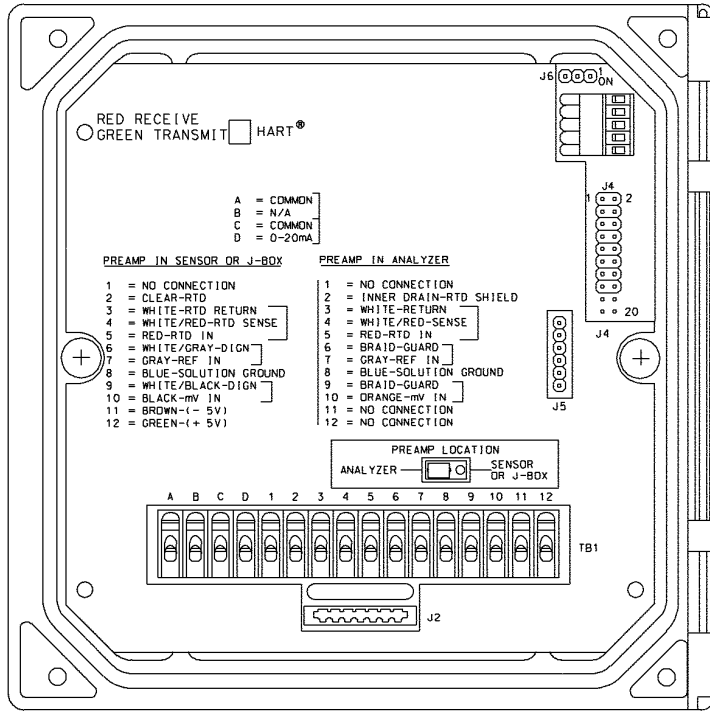

FRONT PANEL

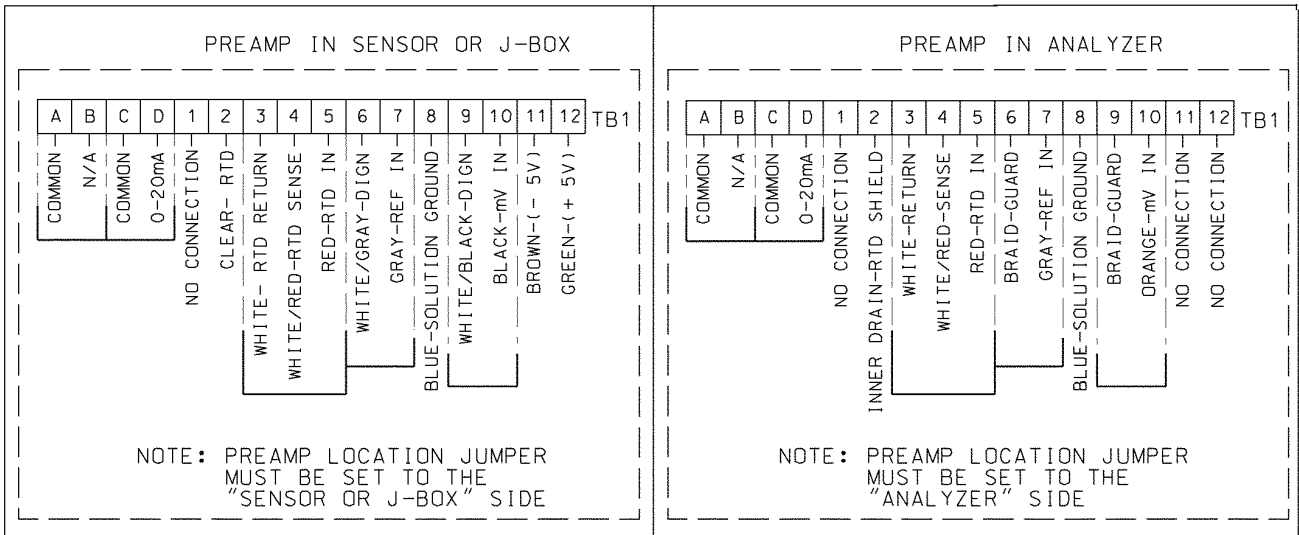

TB1 SENSOR WIRING

DWG. NO. 454EPH01	REV. C
----------------------	-----------

FIGURE 3-3. Sensor Wiring Diagram



To prepare the cable for sensor wiring:

1. Use only the cable specified. Figure 3-4 shows the 10 conductor cable with 3 shields (9200273).
2. Strip back the PVC jacket 4 in. or far enough to access the eleven screw terminals in the junction box, or the eleven terminals in the controller. Separate the two coaxial cables and prepare each as follows:
  - 2a. Strip back the insulating black sheath about 1½ in.
  - 2b. Separate the braid from the inner black conductive sheath.
  - 2c. Solder an insulated wire to the braid.
  - 2d. Strip the black conductive sheath 1 in. to expose the colored (orange or gray) cable inside.
  - 2e. Insulate the exposed black sheath and braid area to prevent shorts.
3. Strip ¼ in. of insulation on each conductor for terminal mounting. Insulate the exposed foil shields with heat shrink sleeves or electrical tape. Be sure that heat shrink overlaps the exposed metal end where the foil shield has been cut. Shields must not be shorted together. The sensor will not work if foil shields or drain wires are not electrically isolated from each other.

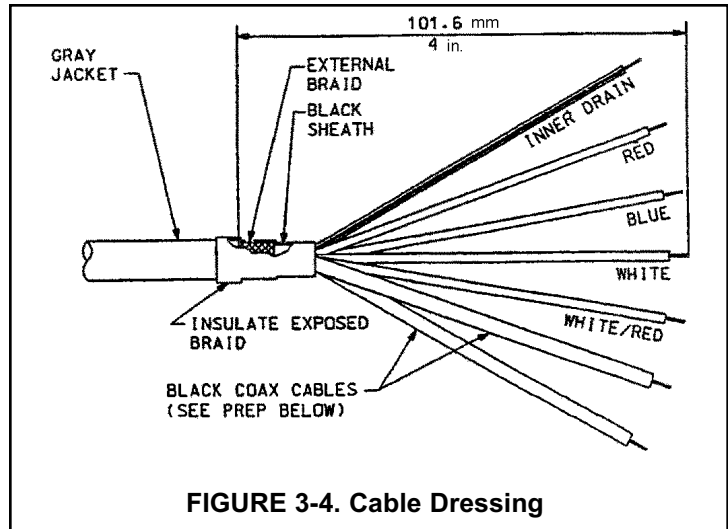

FIGURE 3-4. Cable Dressing

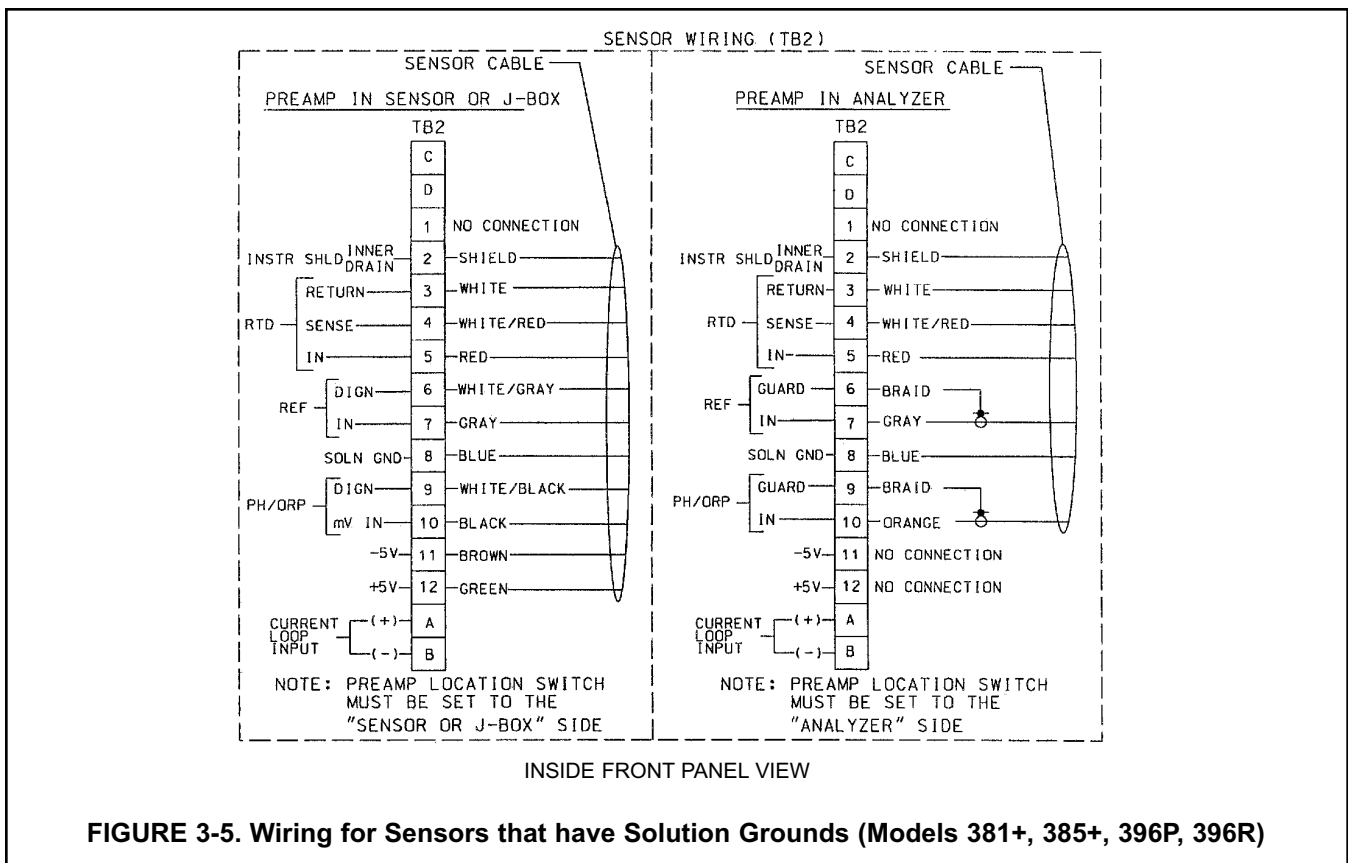
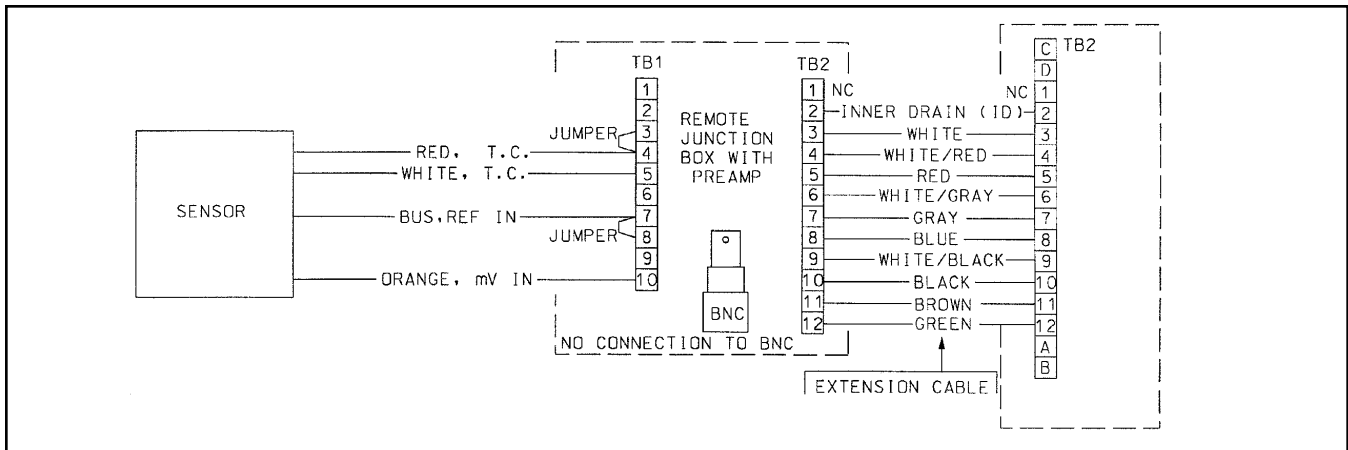
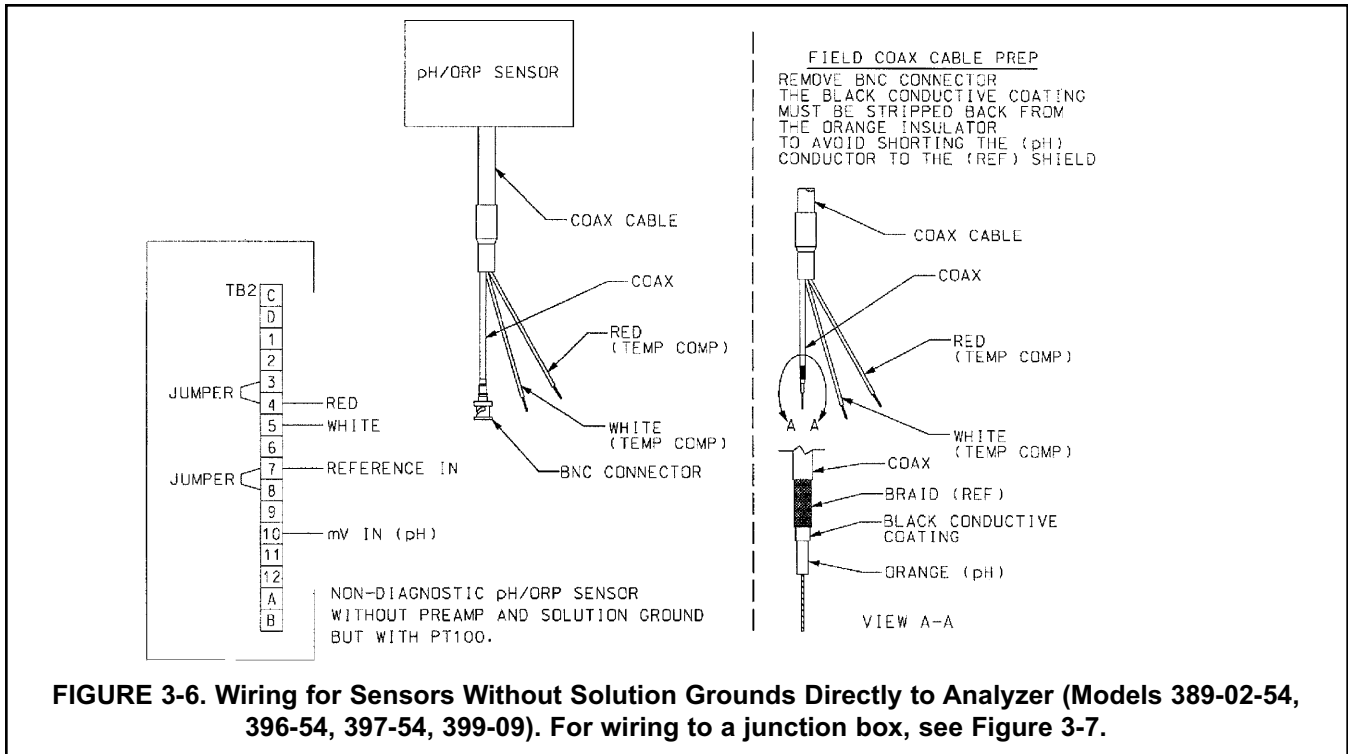

FIGURE 3-5. Wiring for Sensors that have Solution Grounds (Models 381+, 385+, 396P, 396R)



**FIGURE 3-7. Wiring for Sensors Without Solution Grounds to a Junction Box (Models 389-02-54, 396-54, 399-09)**

**NOTES:**

1. Interconnecting wire maximum length is 500 ft. Use PN 9200273 (no substitutes). Shields must be insulated from each other at all cable ends. Connect to junction box as shown.
2. If distance to controller is short, the junction box is not required. Connect sensor leads directly to controller.

**3.6 FINAL ELECTRICAL CHECK**

When all wiring is completed, apply power to the controller. Observe the controller for any questionable behavior and remove power if you see a problem. With the pH sensor in the process, the display will show a pH value (though it may not be accurate).

**CAUTION**

**To prevent unwanted chemical feed into the process and to prevent injury to operating personnel, disconnect the chemical feed pump and other external devices until the controller is checked out, programmed, and calibrated.**

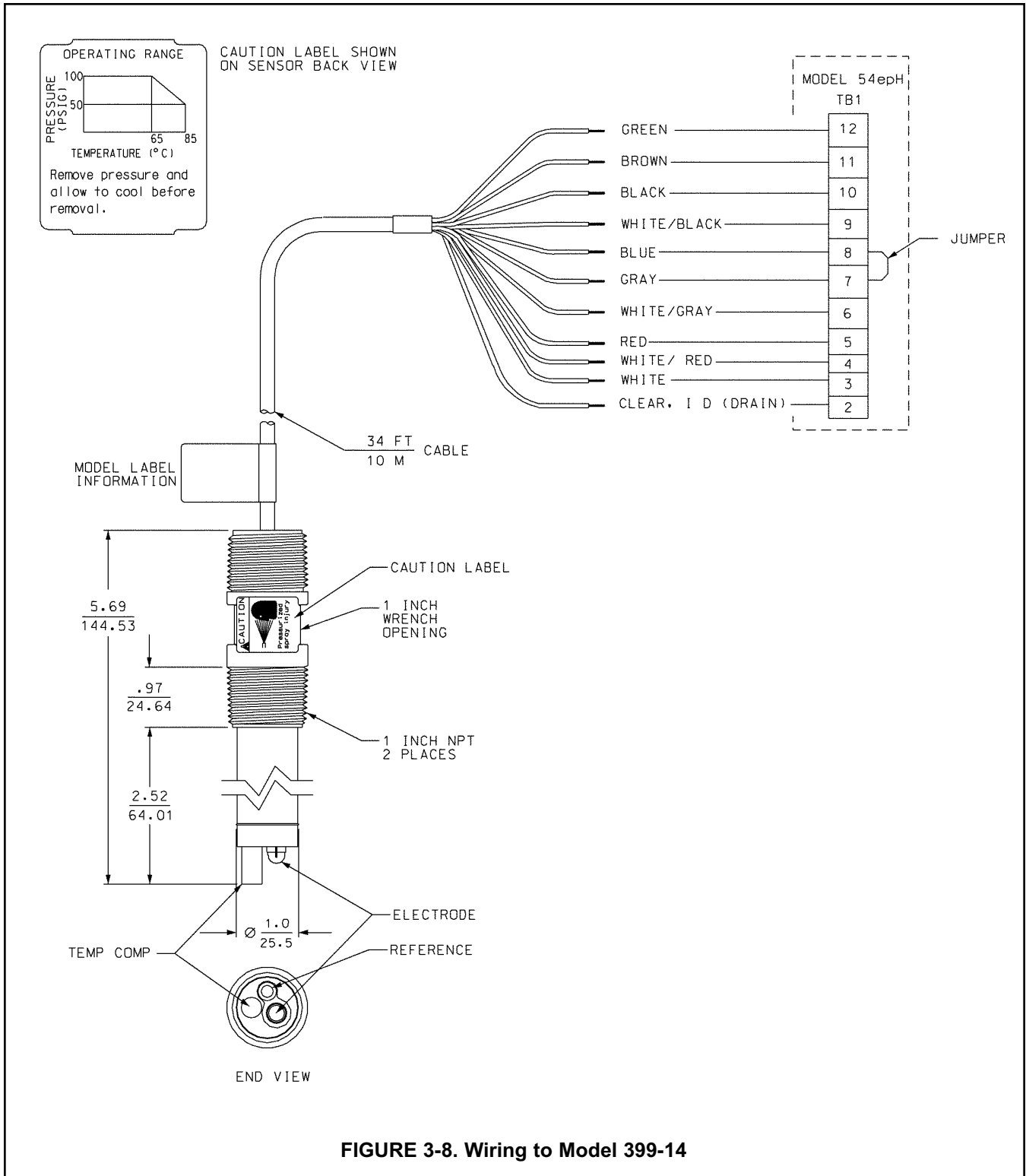

FIGURE 3-8. Wiring to Model 399-14

## SECTION 4.0 CALIBRATION

The following procedures are described in this section:

- Temperature Calibration (Section 4.1)
- Auto Buffer (Two-Point) Calibration (Section 4.2)
- Manual Two-Point Calibration (Section 4.3)
- Single-Point pH Calibration (Section 4.4)
- Temperature Compensation Options (Section 4.5)
- pH Slope Adjustment (Section 4.6)
- Hold Mode (Section 4.7)

### INTRODUCTION

Calibration is the process of adjusting or standardizing the controller to a lab test (such as free acid titration) or a calibrated laboratory instrument, or standardizing to some known reference (such as a commercial pH buffer). Calibration ensures that the controller shows an accurate, and therefore, repeatable reading of pH or temperature.

Since pH measurements are affected by temperature, the Model 54e pH/ORP reads the temperature at the sensor and compensates for the changing temperature by referencing all pH measurements to 25°C (77 °F).

This compensates for temperature-related changes in the response of the glass pH electrode which would affect the pH measurement. The pH temperature compensation does not account for changes in chemical activity which affect the actual pH value of the solution being measured. See Section 7.0 for information on solution temperature compensation.

To ensure the controller's accuracy, it is important to perform all the calibration procedures provided in this section if you are:

- installing this unit for the first time
- changing or replacing electrodes or sensor elements
- troubleshooting

### IMPORTANT

**Before attempting to calibrate, inspect the pH sensor assembly. It must be clean, undamaged and free from cracks or other signs of leakage or wear.**

### WARNINGS

Before performing any of these procedures, be sure to disable or disconnect the chemical feed pumps or other external devices (see placing controller in hold, Section 4.7)

Perform the calibration procedures in this section **only in the order they are given.**

Do not attempt to calibrate the controller if the fault LED is lit or the display is showing fault messages.

## 4.1 TEMPERATURE CALIBRATION

This procedure is used to ensure an accurate temperature measurement by the temperature sensor. It enables the controller to display process temperature accurately as well as to compensate for the effect of temperature on the pH reading when the temperature in your process changes. The following steps should be performed with the sensor in the process or in a grab sample near the operating temperature.

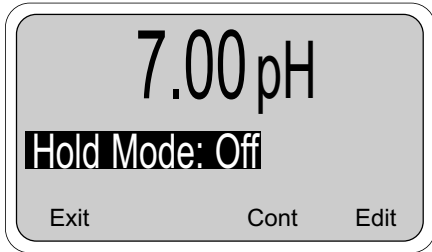

1. Check the controller temperature reading (main display) to make sure the sensor has acclimated to the process temperature. Compare the controller temperature to a calibrated temperature reading device. Proceed to the next step if the reading requires adjustment.
2. From the main display, press any key and then press Enter (F4) to access the Calibrate menu.

**NOTE**

The hold mode screen (top left) will appear if the hold mode was enabled in Section 5.6. Activate hold mode by pressing Edit (F4), using the arrow key to change Off to On, and then pressing Save(F4). The hold mode holds the outputs and relays in a fixed state to avoid process upsets to a control system. The message "Hold Mode Activated" will always be displayed when the controller is in hold. To leave the hold mode in it's current state, press Cont(F3).

Press the ↓ arrow key twice to bring up the screen to the left and then press Enter (F4).

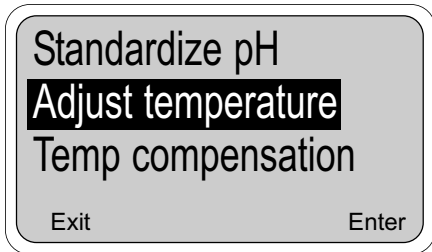

**NOTE**

(To verify that the controller is using automatic temperature compensation, highlight the "Temp compensation" menu item and press Enter (F4). For more details, see Section 4.5)

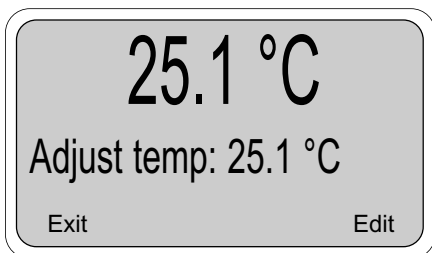

3. Press Edit (F4) with this display shown to adjust the temperature. The screen below will then appear. Using the arrow keys, input the correct temperature value and press Save (F4). The controller will enter the value into memory. To abort the change, press Esc (F3). Afterwards, to continue with buffer calibration, go to Section 4.2 or 4.3, otherwise press Exit (F1) three times for the main display.

**NOTE**

If hold mode was turned ON, be certain to install the sensor back in the process and change the setting to OFF to resume normal operation before leaving the controller. The screen on the top left will appear again before the main display is shown. Follow the same routine as in the Note for step 2 to turn the Hold Mode Off and then press Exit (F1).

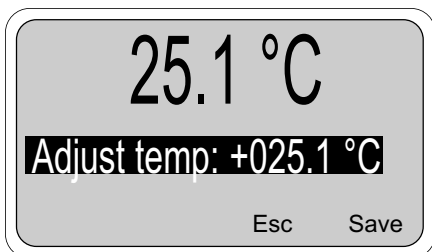

## 4.2 AUTOMATIC TWO-POINT CALIBRATION

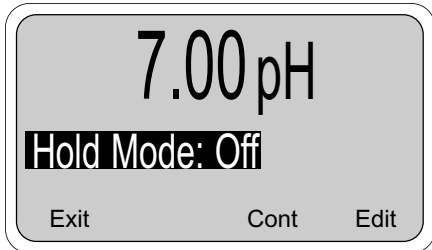

The two-point calibration is performed when the controller is initially installed and whenever elements of the sensor assembly or controller are replaced. The two-point calibration re-establishes the slope of the electrode. This is necessary because the slope (mV/pH change) decreases as the glass pH electrode ages.

Buffer calibration uses measurements of two solutions to calculate the slope (efficiency) and the zero offset of the pH sensor.

Obtain two pH buffer solutions with different pH values. They should be at least 2 pH units apart. Unopened buffers have a shelf life of about a year and should generally not be reused because of possible contamination.

Before taking readings, clean and rinse the sensor (if necessary). Shake the sensor down to remove air bubbles from the glass electrode tip. Place the sensor into the first buffer solution. Verify and adjust the temperature (Section 4.1), if necessary.

The controller is set at the factory for automatic calibration. If this feature has been disabled (Section 5.9), see Section 4.3 for manual calibration.

Auto calibration includes automatic buffer recognition (factory set buffers are 4.01, 7.00, and 10.01 pH) and a stabilization check. The stabilization feature eliminates errors caused by changes in temperature and response time of the glass electrode. To change these settings, refer to Section 5.9.

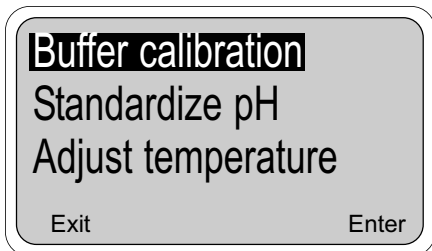

1. From the main display, press any key to obtain the main menu. With the cursor on "Calibrate", press Enter (F4). With the cursor on "Buffer calibration", press Enter (F4) again.

### NOTE

The hold mode screen (top left) will appear if the hold mode was enabled in Section 5.6. Activate hold mode by pressing Edit (F4), using the arrow key to change Off to On, and then pressing Save(F4). The hold mode holds the outputs and relays in a fixed state to avoid process upsets to a control system. To leave the hold mode in it's current state, press Cont (F3).

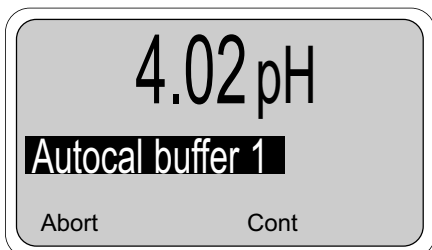

2. With the sensor in the first buffer, press Cont (F3). To cancel the calibration, press Abort (F1.)

The word "Wait" flashes until the sensor is stabilized.

The controller is waiting for the pH reading to stabilize within the parameters established in Section 5.9. If the controller appears to be locked at this stage, the reading is not stable enough. Increase the stabilize pH and/or decrease the stabilize time and retry the calibration.

Press Abort (F1) to cancel the calibration if it appears to be taking too long.

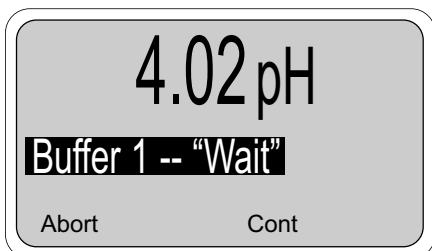

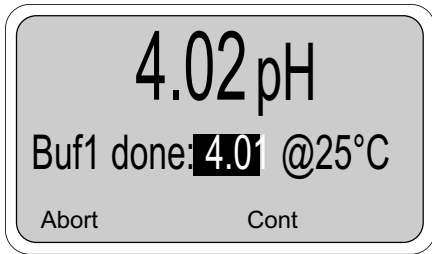

3. A screen like the one on the left will appear after stabilization.

**Use the arrow keys to select the correct buffer.**

If the correct buffer does not appear, refer to Section 5.9 and select a buffer group that includes the desired buffers. As usual, to cancel the calibration, press Abort (F1).

When the correct buffer is shown, remove the sensor from buffer 1, rinse and gently dry it. Press Cont (F3) to continue.

**NOTE**

The calibration calculation does not occur until buffer 2 is completed. Aborting the calibration at this point will not change the reading of the controller.

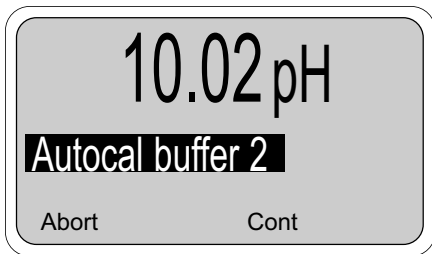

4. This screen appears immediately after pressing the Cont key in step 3.

Place the sensor into the second buffer. Press Cont (F3) to proceed. The word "Wait" flashes (as before) until the sensor is stabilized.

Press Abort (F1) to cancel the calibration if the process is taking too long. (see step 2).

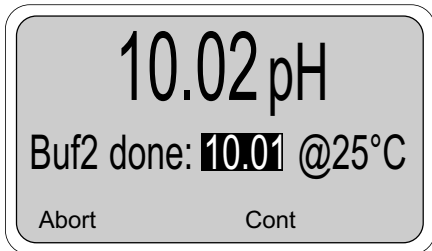

5. A screen like the one on the left will appear after stabilization. **Use the arrow keys to select the correct buffer, and press Cont (F3).** If the correct buffer does not appear, refer to Section 5.9 and select a buffer group that includes the desired buffers. As usual, to cancel the calibration, press Abort (F1).

This completes the calibration. The controller has now recalculated the slope and the zero offset of the sensor.

**CALIBRATION NOTES**

1. **A two-point calibration should always be followed by a single-point calibration (see Section 4.4).**
2. After a buffer calibration, the electrode slope value can be checked to see if the electrode is aging.
3. If the sensor is not at the same temperature as the buffer the calibration will be in error.

**NOTE**

If hold mode was turned ON, be certain to install the sensor back in the process and change the setting to OFF to resume normal operation before leaving the controller. The hold mode screen will appear again before the main display is shown. Follow the same routine as in the Note for step 1 to turn the Hold Mode Off and then press Exit (F1).

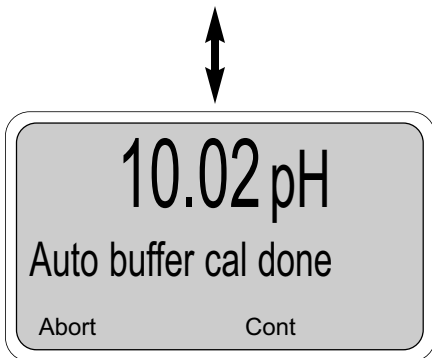

### 4.3 MANUAL TWO-POINT CALIBRATION

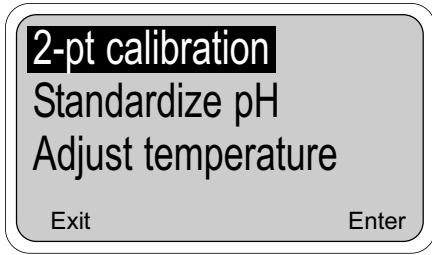

This procedure is followed if Autocal is set to "Manual" in Section 5.9. Buffer values are entered manually and no stabilization check is used.

1. From the main display, press any key to obtain the main menu. With the cursor on "Calibrate", press Enter (F4). With the cursor on "2-pt Calibration", press Enter (F4) again.

**NOTE**

The Hold Mode screen may appear if the feature was enabled in Section 5.6. Changing the Hold Mode to ON holds the outputs in a fixed state, and avoids process upsets during calibration.

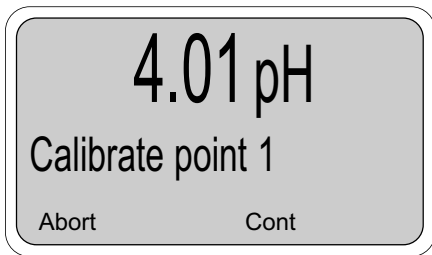

2. Place the sensing portion of the pH sensor into a beaker containing the first buffer solution. The large displayed pH shows the actual pH.
3. Allow the pH and temperature to stabilize. This may take several minutes, as the pH sensor may need to cool down to the buffer temperature. The display will flash "wait" while the reading is stabilizing. When the pH reading is stable, press Cont (F3) to update the reading. Press Edit (F4) and use the arrow keys to change the indicated buffer value to the correct value for the buffer at the stabilized temperature. The pH values at various temperatures are written on the label of most buffer bottles.

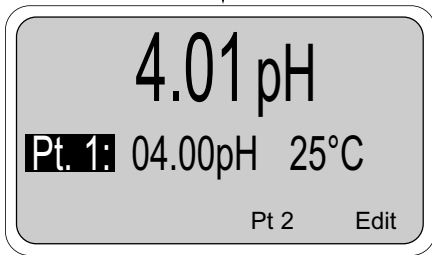

4. Press Pt 2 (F3) to enter Buffer 1 into memory and proceed to buffer 2 (pt. 2) calibration.

**NOTE**

Press Abort (F1) to cancel buffer calibration and return to the calibration menu.

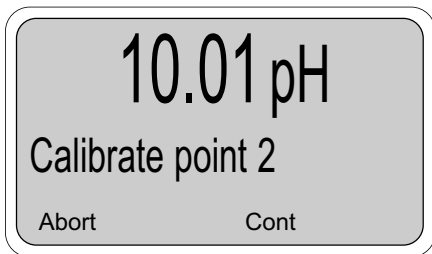

5. Remove the sensor from buffer 1 and rinse in water.
6. Place the pH sensor into a beaker containing the second buffer solution.
7. Allow the pH and temperature to stabilize (as before) and press Cont (F3). The display will flash "wait" while the reading is stabilizing.
8. Enter the correct value for buffer 2 as described in step 3 and press Save (F4) to complete the calibration. Reinstall the sensor.

**CALIBRATION NOTES**

1. **A two-point calibration should always be followed by a single-point calibration (see Section 4.4)**
2. After a buffer calibration, the electrode slope value can be checked to see if the electrode is aging.
3. If the sensor is not at the same temperature as the buffer the calibration will be in error.
4. If the hold mode is ON, be certain to reinstall the sensor in the process and change the setting to OFF to return to normal operation.

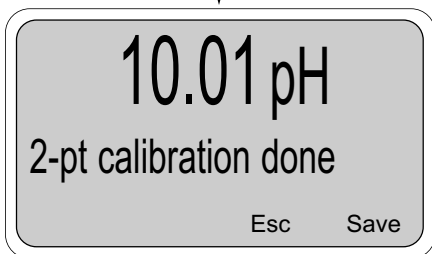



## 4.4 SINGLE-POINT pH CALIBRATION

A single-point calibration (standardization) should always be performed following a two-point calibration. It may have to be performed as often as once a day to ensure that the sensor is accurately reading pH. As the glass electrode or the porous reference plug fouls and ages, the pH reading will drift. The single-point calibration re-establishes the exact pH reading. Experience with your process and its acceptable range of pH will dictate how often the single-point calibration will have to be performed. The procedure is most easily performed on-line by determining the pH of a process grab sample with a laboratory instrument. This value can then be entered into the Model 54e pH/ORP to make it agree with the lab instrument.

Many processes have effects on on-line sensors that cause them to read slightly different than grab samples measured with laboratory electrodes. Standardizing the controller allows both readings to agree. This procedure does not calculate the sensor slope.

1. Take a grab sample that is as close to the sensor as possible.
2. Using a calibrated pH instrument with automatic temperature compensation, determine the pH of the process or grab sample (as close to actual process temperature as possible). Continue with this procedure if an adjustment is needed.
3. From the main display, press any key to obtain the main menu. With the cursor on "Calibrate", press Enter (F4).

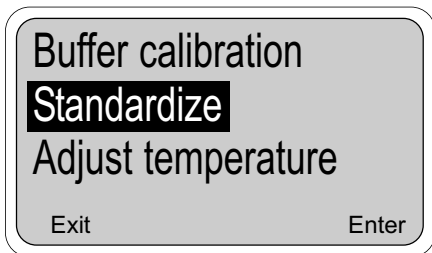

**NOTE**

The Hold Mode screen may appear if the feature was enabled in section 5.6. Changing the Hold Mode to ON holds the outputs in a fixed state, and avoids process upsets during calibration. Remember to change the Hold Mode back to OFF when calibration is completed.

4. Move the cursor (using the down arrow key) from "Buffer Calibration" (or 2-pt calibration) to "Standardize" and press Enter (F4).

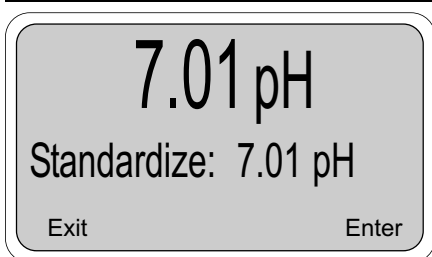

5. The pH reading in large numbers is the live process pH reading. The next line displays the pH reading when this screen was first accessed. Press Edit (F4) to perform the standardize.

Use the arrow keys to change the second line standardize value to the correct pH and press Save (F4) to complete the procedure. Esc (F3) will cancel.

The pH reading in the large display will change to the new value and the zero offset number will be recalculated.

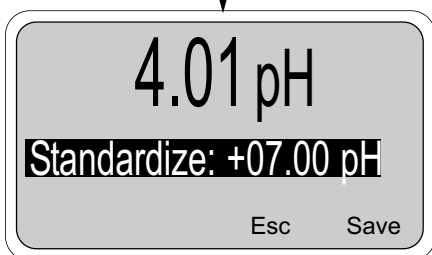

**NOTE**

Before exiting the calibration mode, remember to change the hold mode setting to OFF (if it was turned on in step 3).

## 4.5 TEMPERATURE COMPENSATION OPTIONS

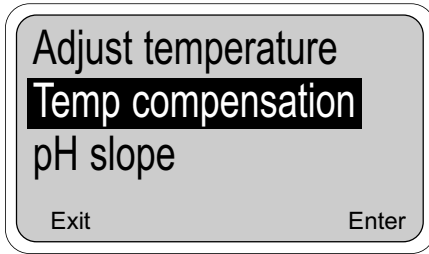

Automatic Temperature Compensation is a standard option for pH equipment and is used in virtually all pH measurement situations. If compensation is not desired, the temperature signal from the sensor can be ignored by placing the controller in the manual temperature compensation mode.

Manual mode allows the input of a fixed value that will be used instead of the sensor value. The manual temperature value need only be entered if the temperature compensation setting is manual. In this case, a value may be entered between -15 and 120°C (5 and 248°F).

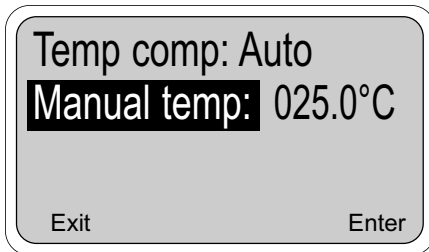

To change these settings, obtain the top screen by pressing Enter (F4) when Calibrate is highlighted in the main menu and then press the arrow key. Press Enter (F4) again to obtain the lower screen. Highlight the desired item and press Edit (F4) and change the value as needed. Options are Auto or Manual temperature compensation and the temperature values listed above. Press Save (F4) to save the change. Esc (F3) will cancel the change.

### NOTE

When the temperature compensation setting is manual, all temperature specific faults are disabled.

## 4.6 pH SLOPE ADJUSTMENT

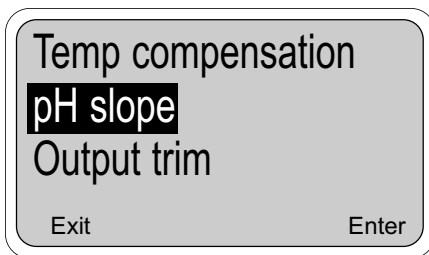

The slope of the glass electrode is normally calculated during buffer calibration. It can, however, be entered directly (if known) using this procedure. A new electrode has a slope of about 59 mV/pH but as it ages the slope will decrease. A slope value below 47 mV/pH unit is a sign of an aged electrode and is not considered adequate for calibration. The pH slope can also be viewed on the diagnostic variables screen.

Use the procedure in Section 4.5 to obtain the screen to the left with "pH slope" highlighted. Press Enter (F4) to display the slope value now being used. Press Edit (F4) for editing and then change the value as needed. Save the new value with Save (F4).

Acceptable slope values are between 45.0 and 60.0 mV/pH.

### NOTE

Before exiting the calibration mode, if the Hold Mode is ON, be certain to change the setting to OFF to resume normal operation.

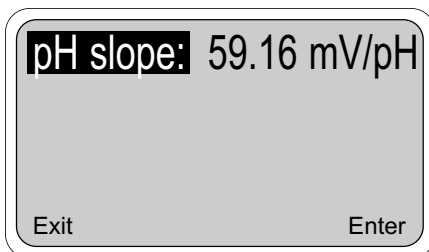

## 4.7 HOLD MODE

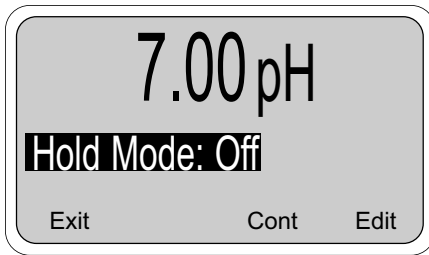

Placing the Controller on Hold for Maintenance. Before performing maintenance or repair of the sensor, the Controller can be placed in hold (refer to Section 5.6 to enable this feature) to prevent process upsets while the reading is off-line. This will place the current outputs into the selected default states (see Section 5.6). The relays will act as selected in relay default, see Section 5.7.

Before removing the sensor from the process, press any key and then Enter (F4). When the hold mode has been enabled, the hold mode screen (on the left) will appear prior to calibration. To continue without putting the controller in hold, simply press Cont (F3). To put the controller in hold, press Edit (F4), use the arrow key to change the "Off" to "On" and press Save (F4).

### NOTE

When the Hold Mode is activated ("On"), "Hold Mode Activated" will always appear on the bottom line of the display.

Always calibrate after cleaning or repair of the pH sensor. After installing the sensor back into the process, always change the Hold Mode setting to OFF.

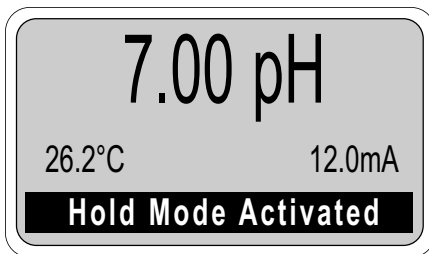

## 4.8 TRIM OUTPUTS

The instrument's current outputs may be calibrated (trimmed) if necessary. If either the power board or the CPU board is replaced, the outputs must be calibrated. To perform this procedure, a calibrated meter must be connected to the output being calibrated.

To perform an output calibration, from the main display press any key to obtain the main menu. With the cursor on "calibrate," press Enter (F4). With the cursor on "Output trim," press Enter (F4) again. Select "Trim output 1" or "Trim output 2" as appropriate.

Press Edit (F4) to select Cal point 1 (4 mA expected and simulated) or Cal point 2 (20 mA expected and simulated). Adjust the Meter value to match the reading of the calibrated meter connected to the output. Press Enter (F4) to complete the calibration.

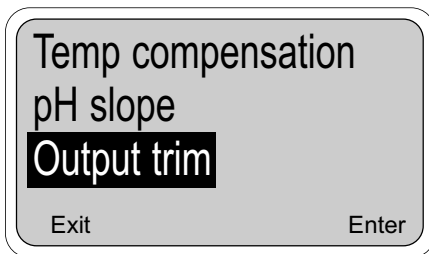

# SECTION 5.0 SOFTWARE CONFIGURATION

This section contains the following:

- An introduction to using the configuration process
- A List of Settings for the controller
- Step-by-step instructions and explanations for each parameter on the List

## INTRODUCTION TO CONFIGURATION

The controller arrives from the factory configured and ready to operate as a pH controller. Refer to Appendix A for ORP measurements.

Figure 5-1 is an outline of the menu structure. Before attempting any changes refer to the parameter setup list shown in Table 5-1. This table presents a brief description and the possible options.

The factory setting is listed with a space for the user setting. It is recommended that the list be carefully reviewed before any changes are made.

On initial configuration, it is recommended that the parameters be entered in the order shown on the worksheet. This will reduce the chance of accidentally omitting a needed parameter.

**TABLE 5-1. pH Settings List**

ITEM	CHOICES	FACTORY SETTINGS	USER SETTINGS
<b>PROGRAM LEVEL (Sections 5.1 - 5.3)</b>			
<b>A. Alarm Setpoints (Section 5.2)</b>			
1. Alarm 1 (low action)	0 - 14 pH	0.00 pH	_____
2. Alarm 2 (high action)	0 - 14 pH	14.00 pH	_____
3. Alarm 3 (high action)	0 - 14 pH	14.00 pH	_____
<b>B. Output Setpoints (Section 5.1, 5.3)</b>			
1. Output 1: 4 mA	0 - 14 pH	0.00 pH	_____
2. Output 1: 20 mA	0 - 14 pH	14.00 pH	_____
3. Output 2: 4 mA	-15 - 130°C	0.0°C	_____
4. Output 2: 20 mA	-15 - 130°C	100.0°C	_____
<b>CONFIGURE LEVEL (Sections 5.5-5.9)</b>			
<b>A. Display (Section 5.5)</b>			
1. Measurement type	pH/ORP/Redox	pH	_____
2. pH Resolution	0.01 pH/0.1 pH	0.01 pH	_____
3. Temperature Units	°C/°F	°C	_____
4. Output 1 Units	mA/% (of full scale)	mA	_____
5. Output 2 Units	mA/% (of full scale)	mA	_____
6. Language	English/Français/Español/Deutsch/Italiano	English	_____
7. Main display lower left	See Section 5.5	Alarm 1 Setpoint	_____
8. Main display lower right	See Section 5.5	Alarm 2 Setpoint	_____
9. Display contrast	0-9 (9 darkest)	5	_____
10. Test Timeout	On/Off	On	_____
11. Timeout Value	1-60 min	10 min	_____
<b>B. Outputs (Section 5.6)</b>			
1. Output 1 Control			
(a) Output 1 Measurement	Process/Temp/Glass Imp/Ref Imp	Process (pH)	_____
(b) Output1 Control Mode	Normal/PID	Normal	_____
2a. Output 1 Setup (Normal)			
(a) Current Range	4-20 mA/0-20 mA	4-20 mA	_____
(b) Dampening	0-299 Sec	0 Sec	_____
(c) Hold Mode	Last value/Fixed value	Last value	_____
(d) Fixed Hold Value (if (c) Fixed)	0-22 mA	21 mA	_____
(e) Fault value	0-22 mA	22 mA	_____

TABLE 5-1. pH Settings List (continued)

ITEM	RANGES	FACTORY SETTINGS	USER SETTINGS
2b. Output 1 Setup (PID)			
(a) Setpoint	-2 to 16 pH or -15 to 130°C	7 pH	_____
(b) Proportional	0-299.9%	100.0%	_____
(c) Integral	0-2999 sec	0 sec	_____
(d) Derivative	0-299.9%	0.0%	_____
(e) LRV (4 mA)	-2 to 16 pH or -15 to 130°C	2 pH	_____
(f) URV (20 mA)	-2 to 16 pH or -15 to 130°C	0 pH	_____
3. Output 2 Control			
(a) Output 2 Measurement	Process/Temp/Glass Imp/Ref Imp	Temperature	_____
(b) Output 2 Control Mode	Normal/PID	Normal	_____
4a. Output 2 Setup (Normal)			
(a) Current Range	4-20 mA/0-20 mA	4-20 mA	_____
(b) Dampening	0-255 Sec	0 Sec	_____
(c) Hold Mode	Last value/Fixed value	Last value	_____
(d) Fixed Hold Value (if (c) Fixed)	0-22 mA	21 mA	_____
(e) Fault value	0-22 mA	22 mA	_____
4b. Output 2 Setup (PID)			
(a) Setpoint	-2 to 16 pH or -15 to 130°C	7 pH	_____
(b) Proportional	0-299.9%	100.0%	_____
(c) Integral	0-2999 sec	0 sec	_____
(d) Derivative	0-299.9%	0.0%	_____
(e) LRV (4 mA)	-2 to 16 pH or -15 to 130°C	2 pH	_____
(f) URV (20 mA)	-2 to 16 pH or -15 to 130°C	0 pH	_____
5. Hold (Outputs and Relays)	Disable/Enable/ 20 min timeout	Disable feature	_____
<b>C. Alarms (Section 5.7)</b>			
1. Alarm 1 Control			
(a) Activation Method	Process/Temp	Process	_____
(b) Alarm 1 Control Mode	Normal/TPC	Normal	_____
2a. Alarm 1 Setup (Normal)			
(a) Configuration	Low alarm/High alarm/Off	Low	_____
(b) Hysteresis (deadband)	0 - 5.00 pH	0.01 pH	_____
(c) Delay Time	0-99 sec	0 sec	_____
(d) Relay Fault	Open/Closed/None	None	_____
2b. Alarm 1 Setup (TPC)			
(a) Setpoint	-2 to 16 pH or -15 to 130°C	7 pH	_____
(b) Proportional	0-299.9%	100.0%	_____
(c) Integral	0-2999 sec	0 sec	_____
(d) Derivative	0-299.9%	0.0%	_____
(e) Time Period	10-2999 sec	30 sec	_____
(f) LRV (100% On)	-2 to 16 pH or -15 to 130°C	2 pH	_____
(g) URV (100% Off)	-2 to 16 pH or -15 to 130°C	0 pH	_____
(h) Relay Fault	None/Open/Closed	None	_____
3. Alarm 2 Control			
(a) Activation Method	Process/Temp	Process	_____
(b) Alarm 2 Control Mode	Normal/TPC	Normal	_____
4a. Alarm 2 Setup (Normal)			
(a) Configuration	Low alarm/High alarm/Off	High	_____
(b) Hysteresis (deadband)	0 - 5.00 pH	0.01 pH	_____
(c) Delay Time	0-99 sec	0 sec	_____
(d) Relay Fault	Open/Closed/None	None	_____
4b. Alarm 2 Setup (TPC)			
(a) Setpoint	-2 to 16 pH or -15 to 130°C	7 pH	_____
(b) Proportional	0-299.9%	100.0%	_____
(c) Integral	0-2999 sec	0 sec	_____
(d) Derivative	0-299.9%	0.0%	_____
(e) Time Period	10-2999 sec	30 sec	_____
(f) LRV (100% On)	-2 to 16 pH or -15 to 130°C	2 pH	_____
(g) URV (100% Off)	-2 to 16 pH or -15 to 130°C	0 pH	_____
(h) Relay Fault	None/Open/Closed	None	_____

Continued on the following page

TABLE 5-1. pH Settings List (continued)

ITEM	RANGES	FACTORY SETTINGS	USER SETTINGS
5. Alarm 3 Control			
(a) Activation Method	Process/Temp	Process	_____
(b) Alarm 3 Control Mode	Normal/TPC	Normal	_____
6a. Alarm 3 Setup (Normal)			
(a) Configuration	Low alarm/High alarm/Off	High	_____
(b) Hysteresis (deadband)	0 - 5.00 pH	0.01 pH	_____
(e) Delay Time	0-99 sec	0 sec	_____
(d) Relay Fault	Open/Closed/None	None	_____
6b. Alarm 3 Setup (TPC)			
(a) Setpoint	-2 to 16 pH or -15 to 130°C	7 pH	_____
(b) Proportional	0-299.9%	100.0%	_____
(c) Integral	0-2999 sec	0 sec	_____
(d) Derivative	0-299.9%	0.0%	_____
(e) Time Period	10-2999 sec	30 sec	_____
(f) LRV (100% On)	-2 to 16 pH or -15 to 130°C	2 pH	_____
(g) URV (100% Off)	-2 to 16 pH or -15 to 130°C	0 pH	_____
(h) Relay Fault	None/Open/Closed	None	_____
7. Alarm 4 Control			
(a) Alarm	Fault/Off	Fault	_____
8. Feed Limit Timer			
(a) Feed Limit	Disable/alarm 1/alarm 2/alarm 3	Disable	_____
(b) Timeout Value	0-10,800 sec	3600 sec	_____
<b>C. Alarms (Section 5.7)</b>			
9. Interval Timer			
(a) Timer (selection)	Disable/alarm 1/alarm 2/alarm 3	Disable	_____
(b) Timer (activation method)	Time activated/Imped. activated	Time activated	_____
(c) Interval	0-999.9 hr	24.0 hr	_____
(d) Repeats	1-60	1	_____
(e) On Time	0-2999 sec	120 sec	_____
(f) Off Time	0-2999 sec	1 sec	_____
(g) Recovery	0-999 sec	600 sec	_____
<b>D. Diagnostics (Section 5.8)</b>			
1. Diagnostics (Glass and Reference)	On/Off	000 (no security)	_____
2. Glass Imp(edance) High Setpoint	0-2000 MOhms (0 disables)	000 (no security)	_____
3. Glass Imp(edance) Low Setpoint	0-900 MOhms (0 disables)		_____
4. Ref(erence) Imp(edance) High	0-140 KOhms (0 disables)	000 (no security)	_____
5. Zero Offset	0-999 mV (0 disables)	000 (no security)	_____
6. Cal(ibration) Warn(ing)	0-500% (0 disables)		_____
7. Imped(ance Temperature) Comp(ensation)	On/Off	000 (no security)	_____
<b>E. Auto Calibration (Section 5.9)</b>			
1. Autocal (Buffer List Selection)	Manual/Standard/DIN 19267	000 (no security)	_____
2. Stabilize pH (Auto Calibration)	.01-.50 pH	000 (no security)	_____
3. Stabilization Time (Auto Calibration)	0-30 sec	000 (no security)	_____
<b>F. Security (Section 7.1)</b>			
1. Lock all	000-999	000 (no security)	_____
2. Lock Program (Lock all except Calibrate)	000-999	000 (no security)	_____
3. Lock Config. (Lock all except Calibrate, Output setpoints (PID), Simulated Tests Alarm Setpoints, and Rerange Outputs)	000-999	000 (no security)	_____
<b>D. Solution Temperature Compensation (Section 7.3)</b>			
1. Temp(erature) Coeff(icient)	-0.044 to 0.028pH/°C	000 (no security)	_____
2. Operate Iso(potential) pH	-1.35 to 20.12 pH	000 (no security)	_____
3. Sensor Iso(potential)	0-14 pH	000 (no security)	_____

By changing the standard output configuration, you can set up the Model 54e pH/ORP to perform a wide variety of control and monitoring tasks. The configuration procedures allow you to program the controller to meet the specific control and monitoring requirements of your particular plant. This is done by recording the desired configuration parameters on the List of Settings Form and then actually configuring them by using the keys on the controller front panel.

**Accessing Calibrate, Program and Configure Menus.**

Operating configuration changes are made at the levels shown in Figure 5-1. Pressing any key from the main display will access the main menu (top left). Refer to Appendix A for ORP measurements.

**Level 1 Calibrate.** To access calibration selections from the main menu, with the cursor over "Calibrate" press Enter (F4). All buffer calibration, pH standardization and temperature adjustments are made at this level (refer to Section 4.0 for these procedures).

**Level 2 Program.** To access the program level from the main menu, place the cursor over "Program" with the down arrow key. Then press Enter (F4). From the program level menu, changes can be made to the alarm setpoints and the output setpoints.

**Level 3 Configure.** To access the configure level from the main menu place cursor over "Program" and Enter (F4), then place cursor over "Configure" and Enter (F4). This level contains advanced selections, such as alarms, diagnostics, autocal and others.

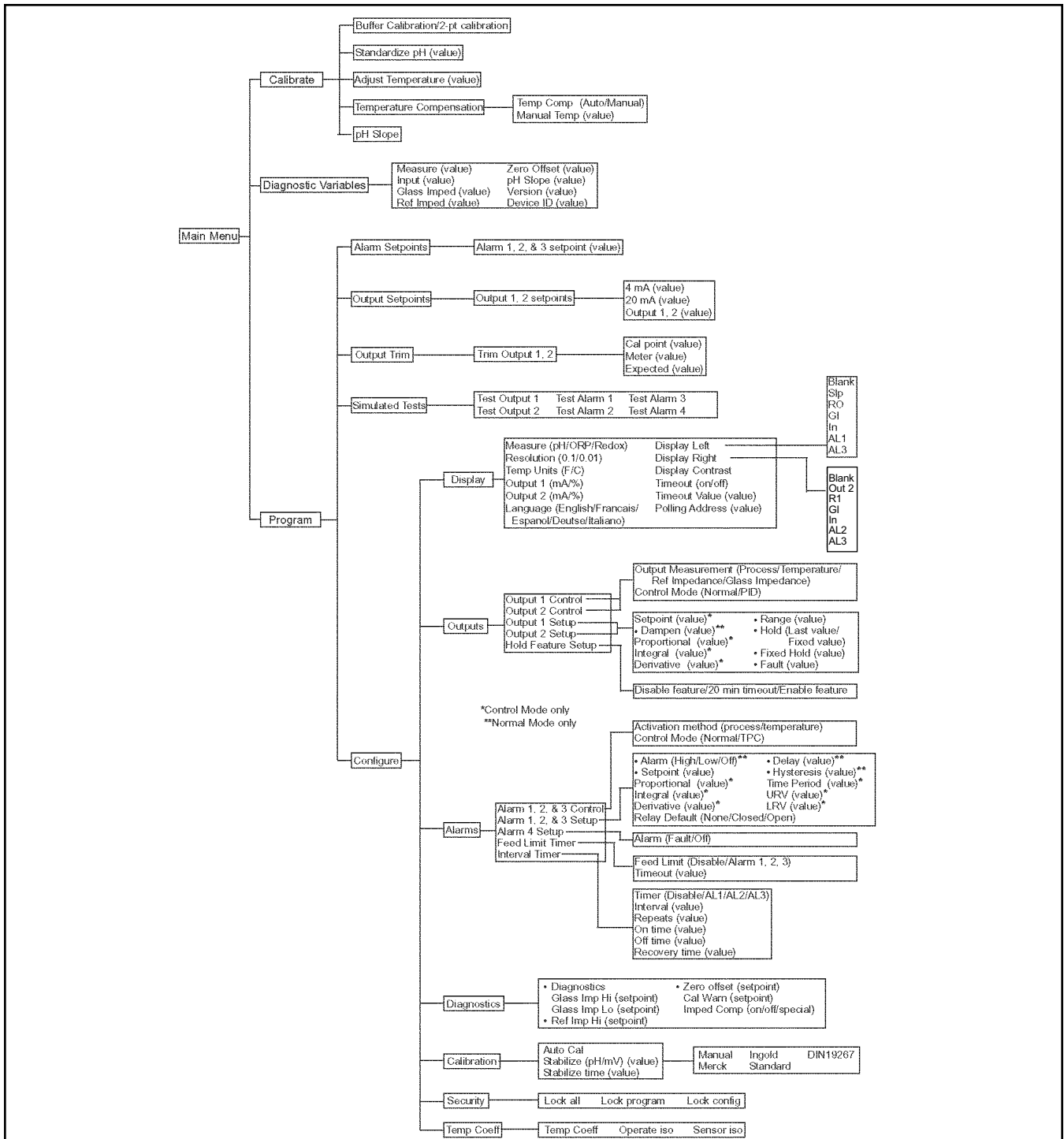
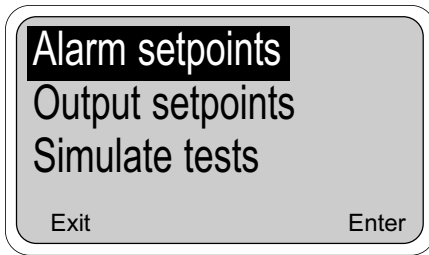

FIGURE 5-1. Outline of Menu Levels

## 5.1 CHANGING ALARM SETPOINTS



This section describes how the three alarm setpoints can be changed. Move the cursor down by pressing the arrow key.

1. From the main menu, move the cursor down to "Program" and press Enter (F4). On the next display, with the cursor on "Alarm setpoints", press Enter (F4).

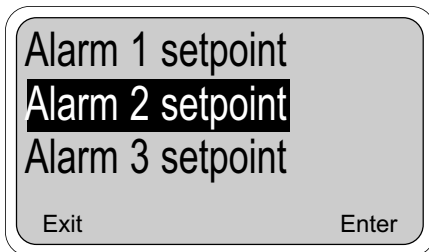

2. Select the desired alarm by moving the cursor down to highlight it. When the correct alarm is highlighted, press Enter (F4) to get to the adjustment screen.

In this example we have pressed the arrow key down once to access the alarm 2 setpoint.

### NOTE

There are 2 different possible screens at the next point, depending on whether the alarm has been configured as normal or TPC.

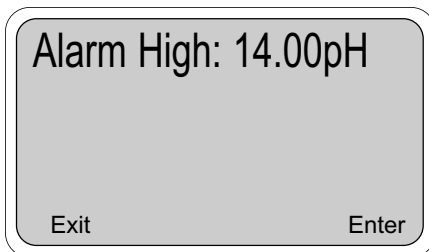

- 3a. (normal alarm). The setpoint now being used for this alarm and the kind of alarm (high or low) are displayed. If the alarm has been turned off, then "off" will be displayed instead of "High". The "Enter" key has now changed to the "Edit" key and will allow changing the setpoint once the F4 key has been pressed. If the setpoint is ok, then press Exit (F1).

After the Edit (F4) key is pressed, use the arrow keys to change the display to the desired setpoint and press Save (F4) to enter into memory. The plus (+) sign can be changed to a minus sign by pressing the down arrow key when the (+) is highlighted. To abort the change, press Esc (F3) to return to the previous menu.

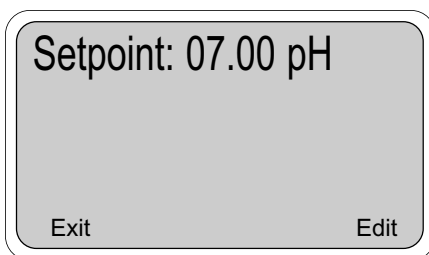

- 3b. (TPC alarm only). When the alarm has been configured as TPC, the setpoint is used for the TPC calculation of how long the alarm should stay on. The "Enter" key has now changed to the "Edit" key and will allow changing the setpoint once the F4 key has been pressed. If the setpoint is ok, then press Exit (F1).

After the F4 key is pressed, use the arrow keys to change the display to the desired setpoint and press Save (F4) to enter into memory. The plus + sign can be changed to a minus sign by pressing the down arrow key. To abort the change, press Esc (F3) to return to the previous menu.



## 5.2 CHANGING OUTPUT SETPOINTS (PID ONLY)

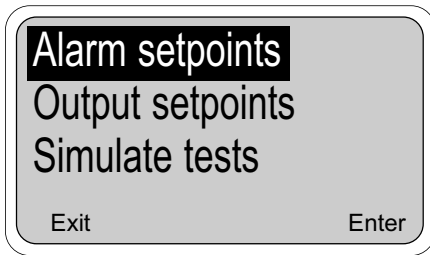

This section describes how the two output setpoints can be changed. This selection is only active if the current output control mode has been set to "PID" (see Section 5.6). If the control mode is set to "normal", then "Not applicable" will be displayed. For reranging outputs, go to Section 5.3.

1. From the main display, press any key to obtain the main menu. With the down arrow key, move the cursor to "Program" and press Enter (F4). With the cursor on "Output setpoints" (as on the left), press Enter (F4).

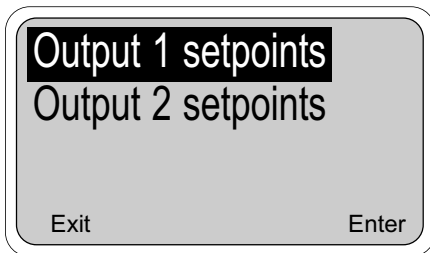

2. Highlight the desired Output setpoints and press Enter (F4).

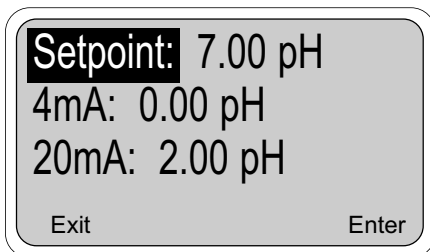

3. The setpoint now being used is displayed. Press Edit (F4) and use the arrow keys to change the display to the new value.

4 mA is the deviation from setpoint that will result in a 4 mA out. 20 mA is the deviation from setpoint that will result in a 20 mA setpoint. Highlight the desired item and press Edit (F4) and the arrow keys to change the display to the new value.

Example: A setpoint of 6 pH with a URV of +2 and a LRV of 0.0 pH. When the pH is 7, the output will be  $(7 - 6)/(2 - 0) = 50\%$  of range (12 mA). If the setpoint is changed to 6.5 pH, the output will be  $(7 - 6.5)/(2 - 0) = 25\%$  of range (8 mA).

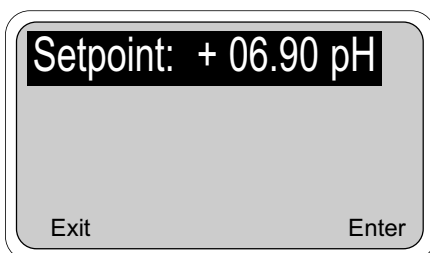

4. Press Save (F4) to enter into memory or Esc (F3) to abort the change.

The Control setpoint is typically the condition where the current output is at a minimum. The P and I control calculations use the setpoint to adjust the current output to the desired level based on the parameters established in Section 5.6.

### 5.3 CHANGING OUTPUT SETPOINTS (NORMAL ONLY)

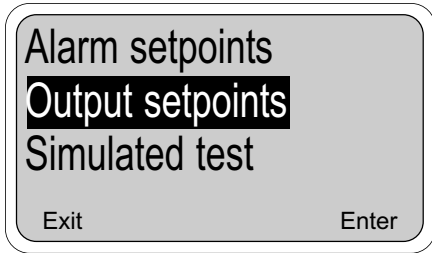

This section describes how the 4 (or 0) to 20 mA current outputs can be reranged. Note that the current outputs can be configured to represent pH, temperature, glass impedance, or reference impedance. See Section 5.6 for details on configuration.

1. From the main menu, move the cursor down to "Program" and press Enter (F4). On this display, move the cursor to "Rerange outputs" and press Enter (F4).

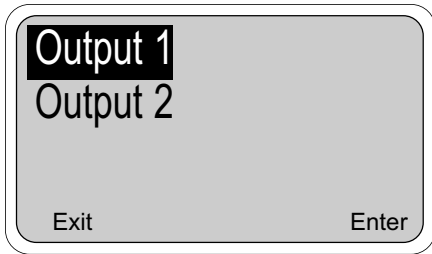

2. Select the desired output by moving the cursor down to highlight it. When the correct output is highlighted, press Enter (F4) to get to the adjustment screen.

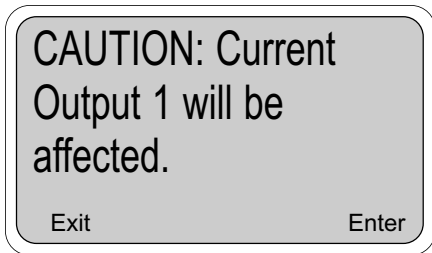

3. This message asks for confirmation of the requested change. Changes in these settings may degrade process control, so use caution when making changes. Press Enter (F4) to continue. Otherwise press Abort (F1).

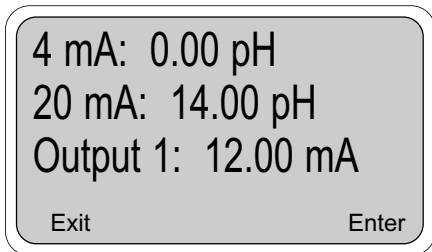

This screen allows changing the setpoints for output 1. A similar screen is available for output 2. The live current output now being transmitted by the controller is shown on the third line.

4. Press Edit (F4) to make changes in the setpoints. The Edit key changes to a Save key and the F3 key becomes active as an Esc key. Use the arrow keys to make the display read the desired values for the high and low current output limits. When done, press Save (F4) to enter the changes into memory. Press Esc (F3) to cancel changes.

**NOTE**

Outputs that have been configured as 0-20 mA in Section 5.6, will show 0 mA instead of 4 mA on the top line. Outputs that are based on temperature or impedance values will show matching units such as °C, MΩ, or kΩ. See Section 5.6 for output configuration.

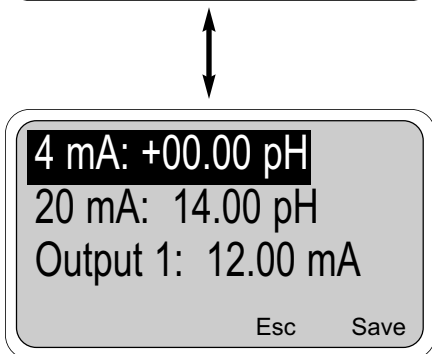

## 5.4 TESTING OUTPUTS AND ALARMS

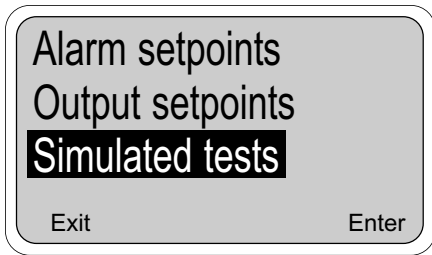

This section describes how the current outputs and alarm relays can be manually set for the purposes of checking devices such as valves, pumps, or recorders.

1. From the main menu, move the cursor down to "Program" and press Enter **[F4]**. On this display, move the cursor to "Simulated tests" and press Enter **[F4]**.

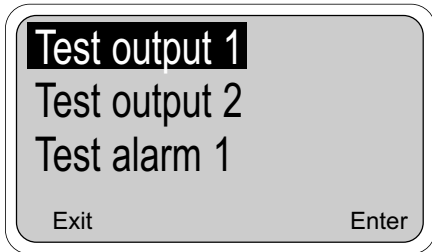

2. At this point there are six separate screens for testing each of the current outputs and each of the alarm relays. Highlight the desired item by pressing the arrow **[↓]** **[↑]** keys as needed.

When the desired item is highlighted, press Enter **[F4]** to continue. Go to step 3a for outputs and 3b for alarms.

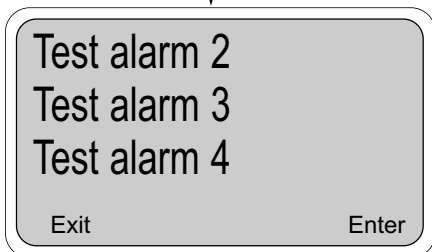

### NOTE

A cautionary message will appear to warn that the output or alarm that was selected will be changed by the following action. Be sure to alert plant personnel that these changes are simulated and do not represent a change in the actual process. Press Enter **[F4]** to continue or Abort **[F1]** to cancel the simulation.

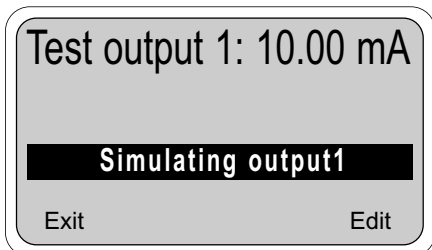

- 3a. The output is now being simulated. In the example to the left, output 1 has been set to 10.00 mA. The output will remain at 10.00 mA until either Exit **[F1]** (or Edit **[F4]** see below) is pressed or the test is concluded by timeout. The default value for the timeout is 10 minutes, so after 10 minutes, the output would go back to normal operation. To configure the timeout option, see Section 5.5.

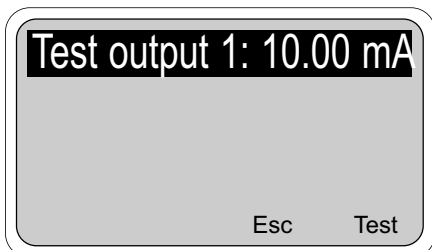

If the displayed current is not the desired value, press the Edit **[F4]** key and the next screen will allow changing the value. Use the arrow keys to change the display as needed, and press Test **[F4]** to use that value. Press Esc **[F3]** to cancel the change in the value and continue simulating the previous current.

## 5.4 TESTING OUTPUTS AND ALARMS (continued)

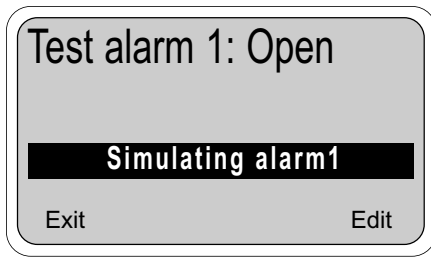

3b. The alarm relay is now being simulated. In the example to the left, alarm 1 has been set to Open. This means that the relay is not energized (i.e. off). The alarm will remain open until either Exit (F1) or Edit (F4) is pressed or the test is concluded by timeout. The default value for the timeout is 10 minutes, so after 10 minutes, the alarm would go back to normal operation and the display will return to the main menu. To configure the timeout option, see Section 5.5.

If the displayed alarm action is not as desired, press the Edit (F4) key and the next screen will allow changing it. Use the arrow keys to change the display as needed, and press Test (F4) to enter the change. Press Esc (F3) to cancel the change in the value and continue simulating the previous action.

### NOTE

Alarm relays may be simulated in the energized (Closed) position or the de-energized (Open) position.

## 5.5 CHOOSING DISPLAY OPTIONS

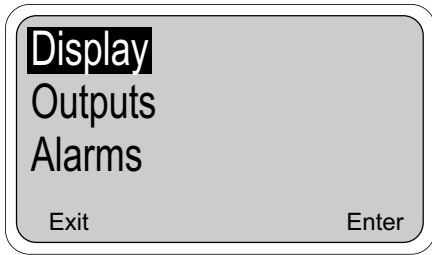

This section describes the options available for the changing of engineering units and variables on the main display.

1. From the main menu, move the cursor down to "Program" and press Enter (F4). From the program menu, move the cursor down using the arrow key to highlight "Configure" and press Enter (F4).

The first configuration menu is displayed. With the cursor on "Display" press Enter (F4).

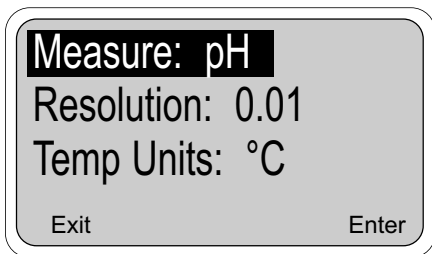

2.

Menu Item	Options
Measure	pH/ORP/Redox
Resolution (pH only)	0.01pH/0.1pH
Temperature units	°C/°F

The values now being used by the controller are displayed. To change any of these items, use the arrow key to highlight the desired item and press Edit(F4). Use the arrow keys to make the change and press Save (F4) to enter the change into memory.

### WARNING

Changing the measurement selection from pH to ORP or ORP to pH will reset all controller settings to factory values. Press Abort (F1) to cancel the change. Press Cont (F3) to change the measurement. Refer to Appendix A for more about ORP measurements.

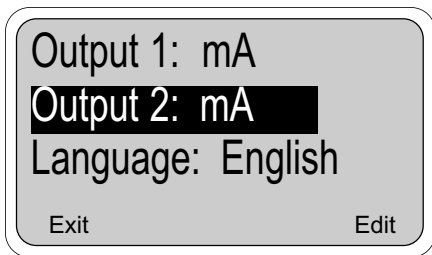
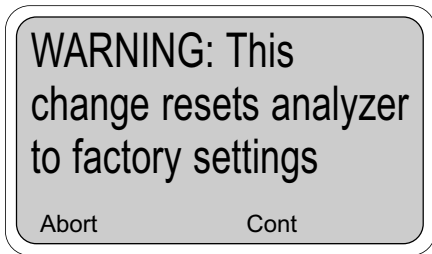

3.

Menu Item	Options
Output 1 units	mA/%
Output 2 units	mA/%
Language	English/Français/Español/Deutsch/Italiano

Press the arrow key three times to access this screen. The current outputs can be displayed as milliamps or as percent of full scale. The default is mA. To change any of these items, use the arrow key to highlight the desired item and press Edit (F4). Use the arrow keys to make the change and press Save (F4) to enter the change into memory.

Further menu items are available by pressing the arrow key repeatedly. When the display is highlighting the item on the third line, the end of the menu has been reached. To back up within the menu, use the up arrow key.

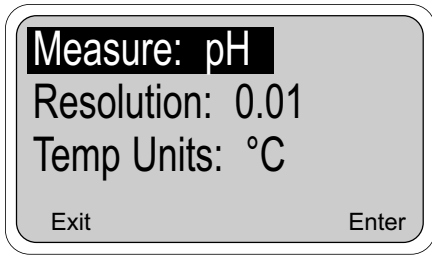
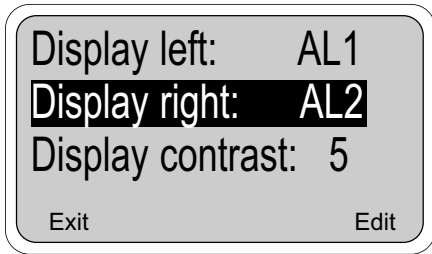

### 5.5 CHOOSING DISPLAY OPTIONS (CONTINUED)

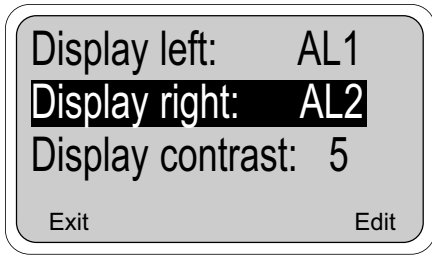

4. This screen allows you to choose the items displayed on the third line left and right of the main display screen. The process temperature and output 1 value (in mA or %) are always shown on line 2 of the main display. This screen allows you to make the following choices:

Lower Left of Main Display

- AL 1 (alarm 1 setpoint - no units shown)
- AL 3 (alarm 3 setpoint - no units shown)
- In (sensor mV input)
- GI (glass impedance in Megohms)
- RO (reference offset in mV)
- Slp (slope of glass in mV/pH - no units shown)
- Blank (nothing displayed in lower left)

Lower Right of Main Display

- AL 2 (alarm 2 setpoint - no units shown)
- AL 3 (alarm 3 setpoint - no units shown)
- In (sensor mV input)
- RI (reference impedance in Kohms)
- Out 2 (Output 2 value in mA or %)
- Blank (nothing displayed in lower right)



The "Display contrast" selection allows the display to be made lighter or darker. Entry 0 is the lightest and 9 is the darkest. The display changes as the number is changed.

To change any of these items, use the arrow key to highlight the desired item and press Edit (F4). Use the arrow keys to make the change and press Save (F4) to enter the change into memory. Press Esc (F3) to abort.

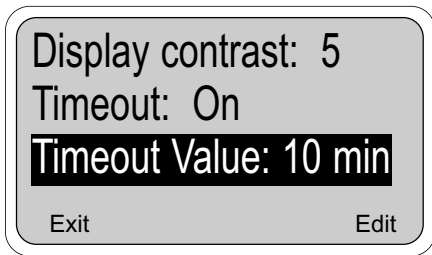

5. The timeout feature works on both the display and simulated tests using the current outputs and alarm relays.

The display timeout will return the display to the main display screen (from any other screen) if no key is pressed before the timeout value. This is useful because the main display screen is usually the most important screen to the operator.

The timeout feature also allows simulating the current output and alarm actions with an automatic return to normal operation. When the feature is turned on (the default), simulated tests (see Section 5.4 for details) will be completed automatically when the timeout value is reached.

As before, to change these settings, use the arrow key to highlight the desired item and press Edit (F4). Use the arrow keys to make the change and press Save (F4) to enter the change into memory. Press Esc (F3) to abort.

#### SECURITY CAUTION

The Timeout Value is also used by the controller to activate security (Section 7.1). After unlocking the controller by entering a security code, security is not re-activated unless a display timeout occurs. If Timeout has been turned off here, security will never re-activate.

## 5.6 CHANGING OUTPUT PARAMETERS

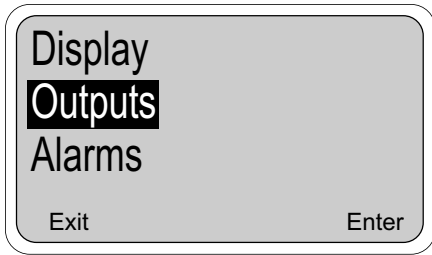

This section describes the options available for configuration of the outputs. Each output can be configured to represent pH (or ORP/Redox, see Appendix A), temperature, glass impedance, or reference impedance. In addition, each output can be linear (normal) or nonlinear (PID). Several options for both modes of outputs can be configured. This section describes the features and shows how to make modifications in the settings.

1. Beginning from the main menu, move the cursor down to "Program" and press Enter (F4). From the program menu, move the cursor down using the arrow key (↓) to highlight "Configure" and press Enter (F4). Use the arrow key again to highlight "Outputs" (as shown on the left) and press Enter (F4).

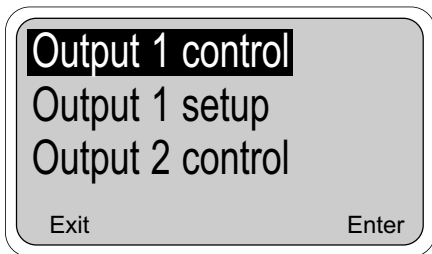

2. There are 5 menu headers that relate to outputs. Each output has a control header and a setup header. In addition, the hold feature is turned on here. The hold feature is mostly used to prevent upsets during buffer calibration of the pH sensor.

To access each header, highlight the desired item and press the Enter (F4) key. To select another header, use the arrow keys. The bottom menu header will only be highlighted if the end of the menu has been reached.

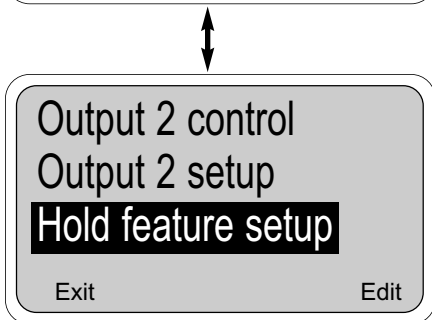

### NOTE

Always configure the control parameters BEFORE making changes in the output setup. Changes in the output setup in step 4 will depend on the options that have been selected in step 3.

### Output Control Parameters

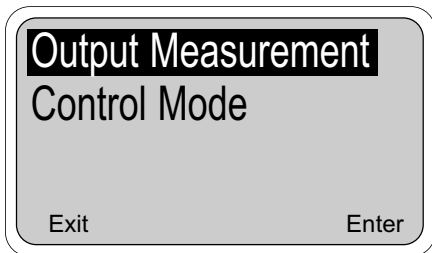

3.

Menu Item	Options
Output Measurement	Process/Temperature/Ref Impedance/Glass Impedance
Control Mode	Normal/PID

Each output can be configured with the options above. The default options are that output 1 is Process (pH or ORP/Redox), output 2 is Temperature and that both outputs are Normal (not PID). This is the most common configuration and may not require changes. If no changes are desired, skip to step 4.

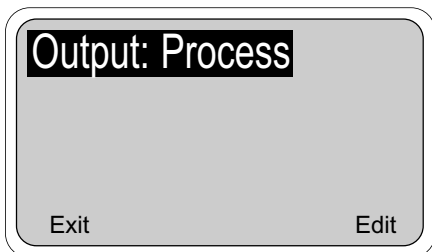

To make changes in these parameters, highlight the desired menu header and press Enter (F4). The value now being used is displayed and the F4 key can be pressed to Edit the item. Once Edit has been pressed, change the item as needed and then press Save (F4) to store the value. Repeat for the other output and/or items as needed.

### 5.6 CHANGING OUTPUT PARAMETERS (continued)

#### Output Setup Parameters (for Normal Outputs)

Range: 4-20 mA  
Dampen: 0 sec  
Hold: Last Value

Exit Edit



Hold: Last Value  
Fixed Hold: 21.00 mA  
Fault: 22.00 mA

Exit Edit

#### Output Setup Parameters (for PID Outputs only)

Setpoint: 7.00 pH  
Proportional: 100.0%  
Integral: 0 sec

Exit Edit



Derivative: 0.0%  
Range: 4-20 mA  
Hold: Last Value

Exit Edit

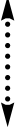

4a.

Menu Item	Options
Range	4-20mA/0-20mA
Dampen(ing)	0-299 sec
Hold	Last value/fixed value
Fixed Hold (if Output 1 hold is "fixed value")	0-22.00 mA
Fault (fixed value in a fault condition)	0-22.00 mA

These parameters can be adjusted by highlighting the desired item and pressing the Edit (F4) key. Once Edit has been pressed, change the item as needed and then press Save (F4) to store the value.

"Range" determines whether the 4-20mA or 0-20 mA convention is used for the current output. If the range is changed, be sure to rerange the outputs as described in Section 5.3.

"Dampening" is used to time-average the current output, smoothing out the effect of a noisy reading. Higher values provide more smoothing.

Enabling the "hold" feature will give the user the option of placing the output in hold during the calibration sequence.

A "fixed value" places the held output at a fixed value between 0 and 22 mA.

4b.

Menu Item	Options
Setpoint	-2 to 16 (pH), ±1400 mV (ORP/Redox) -15 to 120°C (Temp), 0-140 kΩ(Ref Imp), 0-2000 MΩ(Glass Imp)
Proportional	0-299.9 %
Integral	0-2999 sec
Derivative	0-299.9 %

The four parameters above are only available for outputs that have been configured as PID outputs in step 3. These parameters can be adjusted using the same technique as in step 4a, by highlighting the desired item and pressing the Edit (F4) key. Once Edit has been pressed, change the item as needed and then press Save (F4) to store the value.

**Use caution in changing the values of these parameters.**

"Setpoint" is usually the desired value at which the process is being controlled, typically the output will be 4(or 0) mA when the parameter is near the setpoint. This setting can also be changed using the procedure in Section 5.1.



## 5.6 CHANGING OUTPUT PARAMETERS (continued)

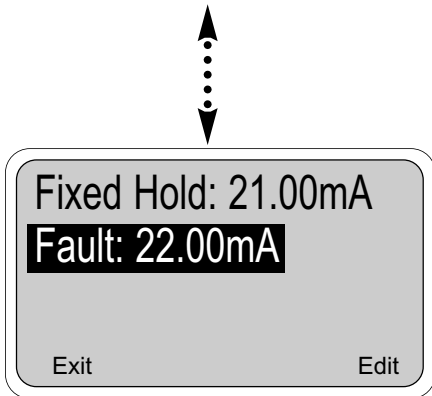

**"Proportional"** is short for Proportional Band and indicates the range over which control is being used. It is the opposite of the process gain. Smaller values provide tighter control.

**"Integral"** is the number of seconds over which deviations from the set-point are integrated to remove continuing offsets. Smaller values provide higher response.

**"Derivative"** is a form of control that resists all changes in readings. Higher readings increase the derivative function. Use caution in setting the derivative value to prevent process oscillation.

More information regarding PID control can be found in Section 7.0. Setting these parameters may require some trial and error and should be tested while the process is being supervised to prevent future upsets.

The rest of the PID output setup parameters are identical to those used for normal outputs. See step 4a for details .

### Hold Feature Setup

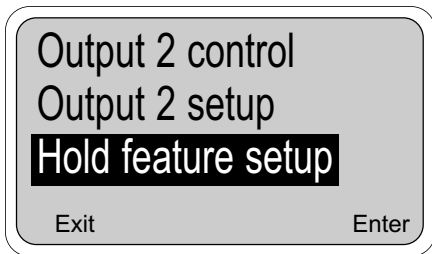

- The Hold feature is used to prevent problems that may occur during calibration if the current outputs are used for control. The feature is turned on (enabled) here and is specifically configured in step 4. The controller starts out with the hold feature turned off (disabled).

To enable the Hold feature, obtain the screen to the left with the hold feature setup highlighted (see steps 1 and 2 for exact instructions). Press Enter **[F4]** and the screen below will appear.



Press the Edit **[F4]** key to enable changes. Options include Disable, Enable, and 20 minute timeout. When 20 minute timeout is selected, the hold mode will automatically disengage after being on for 20 minutes. Selecting Enable or 20 minute timeout does not actually put the controller in hold, but rather allows putting the controller in hold when calibration is conducted.

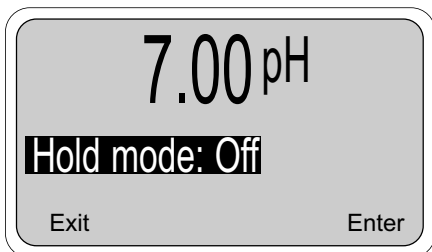

When the hold feature has been enabled, this Hold Mode Screen will appear when the Calibrate routine is entered. Possible actions are Exit **[F1]** which cancels the calibration, Enter **[F4]** which enters the calibrate menu without putting the controller in hold, and Edit **[F4]** which allows turning Hold Mode On. Note that when hold has been enabled, this screen requires pushing Cont **[F3]** to enter and leave the calibrate menu.

## 5.7 CHANGING ALARM PARAMETERS



This section describes the options available for configuration of the alarms. Alarms 1, 2, and 3 can be activated on pH (or ORP/Redox, see Appendix A), or temperature. One of these alarms can be setup as a feed limit timer and another alarm can be dedicated as an interval timer. Alarm 4 is reserved as a fault alarm.

Alarms that activate on pH (or ORP/Redox) or temperature can be configured as on/off (normal), or TPC. These modes are described below. The two alarm modes have several configuration options that are described in detail in this section.

1. Beginning from the main menu, move the cursor down to "Program" and press Enter [F4]. From the program menu, move the cursor down using the arrow key [↓] to highlight "Configure" and press Enter [F4]. Use the arrow key again to highlight "Alarms" (as shown on the left) and press Enter [F4].

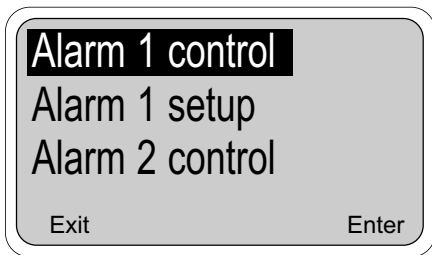

2. There are 9 menu headers that relate to alarms. Alarms 1, 2, and 3 each have a control header and a setup header. Alarm 4 has a simple setup header. Configuration of a feed limit timer and an interval timer is also described here.

To access each header, highlight the desired item and press the Enter [F4] key. To select another header, use the arrow keys. The bottom menu header will only be highlighted if the end of the menu has been reached.

### NOTE

Always configure the control parameters **BEFORE** making changes in the alarm setup. Changes in the output setup in step 4 will depend on the options that have been selected in step 3.

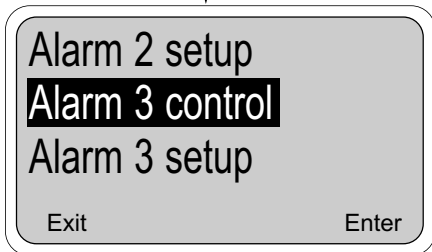

### Alarm Modes:

Normal: Alarm turns on when setpoint is exceeded and turns off when the reading no longer exceeds the setpoint (simple high alarm example).

Fault: Alarm turns on when controller detects a fault condition.

TPC: Alarm turns on for a time that depends on what the reading is. The time it stays on is proportional to how far the reading is from the 0% On Time point, also called the setpoint. (time proportional control)

TPC: Alarm turns on for a time that depends on what the reading is. The time it stays on is proportional to how far the reading is from the setpoint (time proportional control). In addition, the "on time" can be dependent on how long the reading has exceeded the setpoint (integral control) and how fast the reading has actually changed (derivative control).

Feed limit timer: When the alarm has been energized (on) for a long period, it automatically turns off to prevent overfeeding of chemicals.

Interval timer: Alarm is programmed to activate at various times, usually to provide automated cleaning. Useful for spray cleaning and/or automatic retraction of sensors in processes.

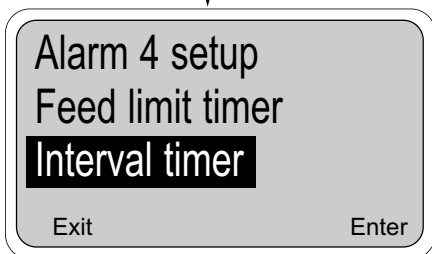

## 5.7 CHANGING ALARM PARAMETERS (continued)

### Alarm Control Parameters

Activation Method  
Control Mode

Exit Enter

Activate: Process

Exit Edit

3.

Menu Item	Options
Activation Method	Process/Temperature
Control Mode	Normal/TPC

Alarms 1, 2, and 3 can each be configured with the options above. The default options are that all three alarms are Process (pH or ORP/Redox), and Normal (not TPC). This is a common configuration and may not require changes. If no changes are desired, skip to step 4a.

To make changes in these parameters, highlight the desired menu header and press Enter (F4). The value now being used is displayed and the F4 key can now be pressed to Edit the item. Once Edit has been pressed, change the item as needed and then press Save (F4) to store the value. Repeat for the other output and/or items as needed.

### Alarm Setup Parameters (for Normal Alarms only)

Alarm: Low  
Setpoint: 0.01 pH  
Delay: 0 sec

Exit Enter



Hysteresis: 0.01 pH  
Delay: 0 sec  
Relay Default: None

Exit Enter

4a.

Menu Item	Options
Alarm (action)	Low/High/Off
Setpoint	-1400 to 1400 mV, -2.00 to 20.00 pH, 0 to 200°C.
Hysteresis	-2.00 to 20.00 pH, 0 to 10°C.
Delay	0-99 sec
Relay default	None/Close/Open

These parameters can be adjusted by highlighting the desired item and pressing the Edit (F4) key. Once Edit has been pressed, change the item as needed and then press Save (F4) to store the value.

**"Alarm action"** determines whether alarm will activate when the reading exceeds the setpoint (high alarm) or when it drops below the setpoint (low action). It can also be turned off (i.e. not used).

**"Hysteresis"** is a deadband that prevents deactivating a relay until the reading has dropped below the setpoint minus the hysteresis amount (high alarm example).

**"Delay"** will delay activation (and deactivation) of the relay for a certain number of seconds. Larger delays can reduce relay chatter.

**"Relay Default"** determines how the relay will act if there is a fault or hold condition. Each alarm can be forced on (Close), off (Open) or can remain unchanged (None). The factory configuration is "None".

### 5.7 CHANGING ALARM PARAMETERS (continued)

#### Alarm Setup Parameters (for TPC Alarms)

**Setpoint: +07.00 pH**  
 Proportional: 100.0%  
 Integral: 0 sec

Exit

Edit



Derivative: 0.0%  
**Time period: 30 sec**  
 URV: 2.00 pH

Exit

Enter



URV: 2.00 pH  
**LRV: 0.00 pH**  
 Relay default: None

Exit

Enter

4b.

Menu Item	Options
Set point	-2 to 20 pH, -1400 to +1400 mV(ORP/Redox)
Proportional	0-299.9 %
Integral	0-2999 sec
Derivative	0-299.9 %
Time period	10-2999 sec
URV	-2 to 20 pH, -1400 to +1400 mV(ORP/Redox)
LRV	-2 to 20 pH, -1400 to +1400 mV(ORP/Redox)
Relay Default	None/Close/Open

These parameters are available for alarms that have been configured as TPC alarms in step 3. Parameters can be adjusted using the same technique as in step 4a, by highlighting the desired item and pressing the Edit (F4) key. Once Edit has been pressed, change the item as needed and then press Save (F4) to store the value.

**"Setpoint"** is usually the desired value at which the process is being controlled, typically the alarm will not be on very much when the process is at this value. This setpoint is also accessible in the Program Menu under "Alarm Setpoints" (see Section 5.2)

**"Proportional"** is short for Proportional Band and indicates the range over which control is being used. It is the opposite of the process gain. Smaller values provide tighter control.

**"Integral"** is the number of seconds over which deviations from the setpoint are integrated to remove continuing offsets. Smaller values provide higher response.

**"Derivative"** is a form of control that resists all changes in readings. Higher readings increase the derivative function. Use caution in setting the derivative value to prevent process oscillation.

**"Time period"** is the cycle time for the TPC control. One cycle consists of an energized (relay on) time and an deenergized (relay off) time. The relative amounts of on time and off time depends on the reading and the other settings listed here.

**"URV"** is the deviation from the setpoint that results in the alarm being on all the time.

**"LRV"** is the deviation from the setpoint that results in the alarm being off all the time. This should be set to 0.00.

**EXAMPLE 1:** A setpoint of 6 pH with URV of +2.0 pH and LRV of 0.0 pH, a time period of 30 seconds. When the pH is 7.0, the relay will be on  $(7-6)/(2-0) = 50\%$  of the time, 15 seconds each time. If the setpoint is changed to 6.5 pH, the relay will be on  $7-6.5/(2-0) = 25\%$  of the time. The relay would then be on for 7 seconds and off for 23 seconds.

**"Relay Default"** determines how the relay will act if there is a fault or hold condition. Each alarm can be forced on (Close), off (Open) or can remain unchanged (None). The original configuration is "None".

## 5.7 CHANGING ALARM PARAMETERS (continued)

### CAUTION

Understanding where to set the TPC parameters is not trivial and is likely to require substantial trial and error to yield acceptable results. pH and ORP/Redox are nonlinear measurements and applying PID algorithms can result in unintended effects.

### Alarm 4 Setup

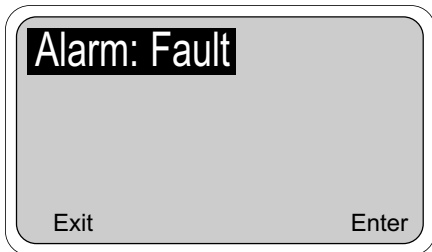

- Alarm 4 is dedicated as a fault alarm. The only option for this alarm is to enable it or to disable it. To disable the alarm, press Edit (F4) and use the arrow key to change "Fault" to "Off".

When a fault condition exists, the relay will energize and the red LED on the front display will turn on.

### Feed Limit Timer Setup

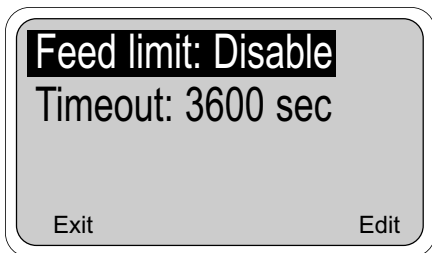

- | Menu Item          | Options             |
|--------------------|---------------------|
| Feed limit (timer) | Disable/AL1/AL2/AL3 |
| Timeout            | 0-10,800 sec        |

The controller allows configuring one of the alarms as a Feed Limit timer. The Feed Limit timer prevent overfeeding of chemical reagent by automatically turning the relay off after a timeout period. To enable this feature, press Edit when the Feed limit is highlighted (as on the left), use the arrow key to select an alarm relay and then press Save (F4).

When a feed limit alarm has timed out, a message will appear on the main display indicating "Feed limit alarm1" (for an alarm 1 feed limit), the red LED will turn on, alarm 4 will close (if not turned "Off"), the selected feed limit relay will open (de-energize), but all other alarms and current outputs will remain unchanged (i.e. this is not a real fault condition). This condition will continue until the (F2) (Ack) key is pressed, at which time the controller returns to normal operation and the feed limit's clock starts again. See Table 6-1, Controller Mode Priority Chart, for controller action in the event of several modes occurring at the same time.

### NOTE

Pressing the (F2) (Ack) key will acknowledge all conditions that turn the red LED on. If another event occurs after the key is pressed, then the key must be pressed again to acknowledge the new event. **This is the only way to clear a Feed Limit Timeout.**

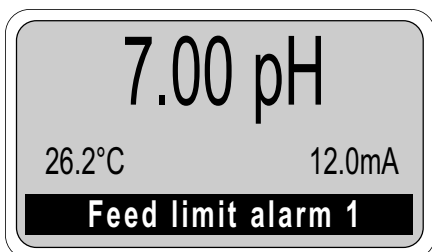

## 5.7 CHANGING ALARM PARAMETERS (continued)

### Interval Timer Setup

Timer: **Disable**  
 Timer: Time activated  
 Interval: 24.0 hr  
 Exit Edit



Repeats: 1  
 On time: **120 sec**  
 Off time: 1 sec  
 Exit Edit



On time: 120 sec  
 Off time: 1 sec  
 Recovery: **600 sec**  
 Exit Edit

7.

Menu Item	Options
Timer (enable)	Disable/AL1/AL2/AL3
Interval	0-999.9 hr
Repeats	1-60
On time	1-2999 sec
Off time	0-2999 sec
Recovery	0-999 sec

The Interval Timer is used to automate a relay closure sequence based on a time interval. See Figure 5-2 for examples. The original controller configuration disables the timer, so the first step in using the timer is to select an alarm relay (1, 2, or 3), which will enable the feature. All parameters can be adjusted by highlighting the desired item and pressing the Edit (F4) key. Once Edit has been pressed, change the item as needed and then press Save (F4) to store the value.

**NOTE**

The alarm relay selected for Interval Timer cannot be used for other purposes such as a process or temperature alarm. While a timer sequence is occurring, both current outputs will be placed in hold (even if hold was not enabled in Section 5.6) and the other 2 alarms will be placed in their default states.

"Interval" determines how often the timer sequence will run. When set to 24 hours, the sequence will run daily.

"Repeats" is the number of times the relay will activate during the sequence.

"On time" is the number of seconds the relay will stay closed (on) during each repeat.

"Off time" is the number of seconds the relay will stay open (off) between each repeat.

"Recovery" is a waiting period after the activation sequence that allows sensor readings to return to normal before outputs and alarm relays are taken out of the hold/default states.

For more on the Interval Timer, see Section 6.0, Theory of Operation.

**NOTE**

The timer can be used for periodic chemical or mechanical cleaning of a coated sensor. If high reference impedance is used to initiate the timer cycle, the reference impedance set point in Section 5.8 is used.

### 5.7 CHANGING ALARM PARAMETERS (continued)

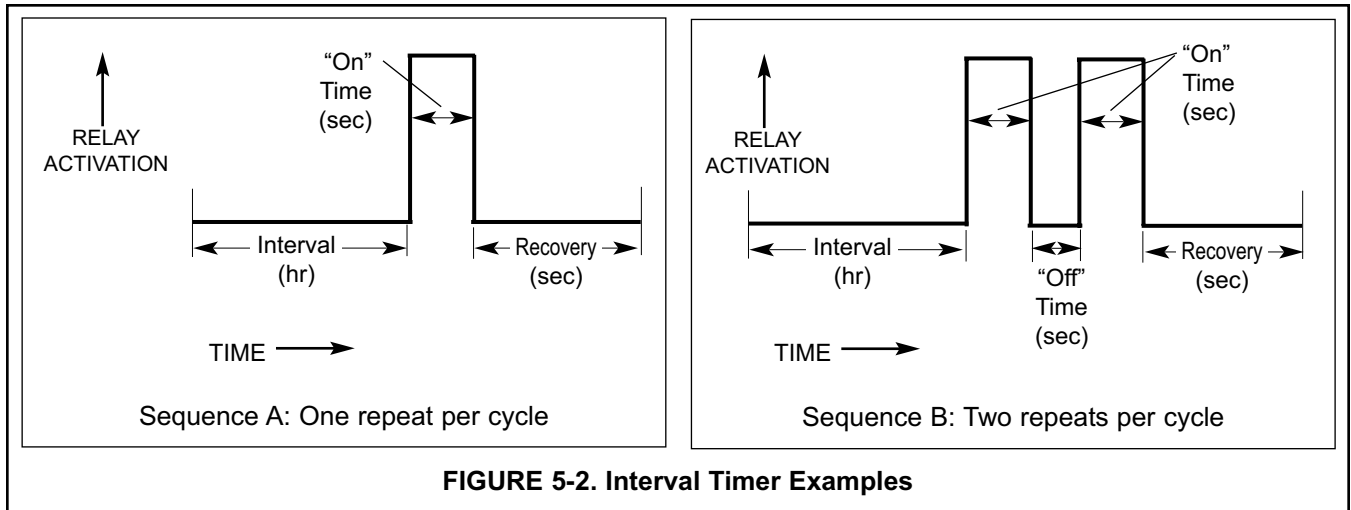

### 5.8 ON-LINE DIAGNOSTICS SETUP

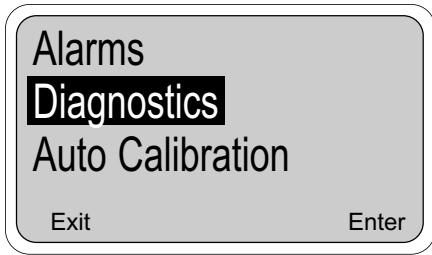

This section describes the options available for configuration of the on-line sensor diagnostics. The controller checks the integrity of the glass electrode (for pH only) and the reference electrode by continuously measuring the impedance of each. The original controller configuration is with diagnostic messages turned off. To enable this feature, see below.

1. Beginning from the main menu, move the cursor down to "Program" and press Enter (F4). From the program menu, move the cursor down using the arrow key to highlight "Configure" and press Enter (F4).

Use the arrow key again to highlight "Diagnostics" (as shown on the left) and press Enter (F4).

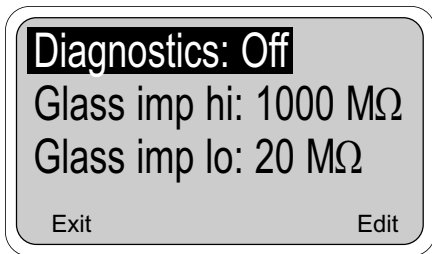

- 2.

Menu Item	Option	Related Fault Messages
Diagnostics	On/Off	
Glass impedance high setpoint	1-2000 MΩ (0 disables)	"Aged glass warning"
Glass impedance low setpoint	1-900 MΩ (0 disables)	"Cracked glass failure"
Reference impedance high setpoint	1-140 kΩ (0 disables)	"High reference impeded"
Zero offset	1-999 mV (0 disables)	"Zero offset err"
Calibration recommended	1-500% (0 disables)	"Calibration warning"
Imped comp	On/Off	

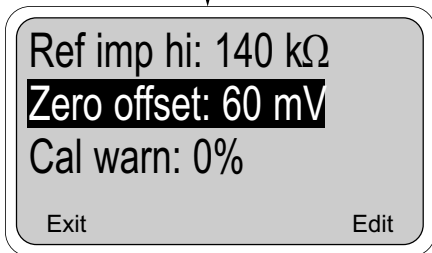

The values now being used by the controller are displayed. To change any of these items, use the arrow key to highlight the desired item and press Edit(F4). Use the arrow keys to make the change and press Save(F4) to enter the change into memory.

"Glass Imp hi" warns of a glass electrode that may have exceeded its useful life. This warning level should be set higher than the new sensor's impedance. For example, for a new sensor with a glass impedance of 150 MΩ, a setting of 400 MΩ may be appropriate.

"Glass Imp lo" warns of a broken glass electrode. This warning level should be set lower than the new sensor's impedance. A good typical setting would be 20 MΩ.

"Ref imp hi" warns of a coated sensor. This warning level should be set higher than the new sensor's reference impedance. Sensors may have reference impedance values that vary considerably, so it is a good idea to check each new sensor before setting this value.

"Zero offset" indicates how far the millivolt response of the sensor is from the ideal case. It is updated after buffer calibration and standardization. If a calibration results in a large enough offset, the fault message will be displayed.

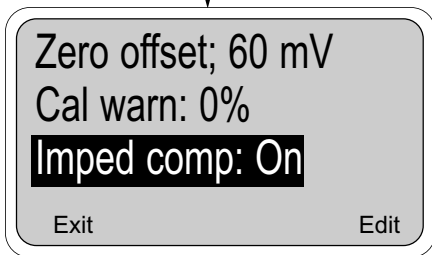



## 5.8 ON-LINE DIAGNOSTICS SETUP (continued)

"Cal warn" compares the on-line glass impedance with the value measured at the last buffer calibration. This setting should be set to 0 (disabled).

"Imped comp" is used to compensate the glass impedance for temperature changes. This is especially important at temperature extremes.

### NOTE

The actual on-line values of the sensor diagnostics are available on the controller under the "Diagnostic Variables" header in the main menu (regardless of whether the messages have been turned on in this section).

## 5.9 AUTO CALIBRATION SETUP

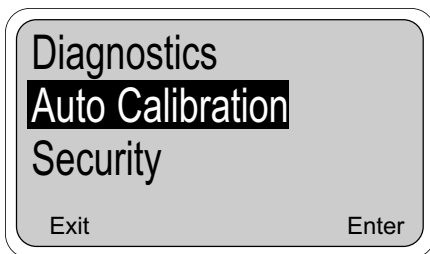

This section describes how the controller may be set up for auto calibration, which includes automatic buffer recognition and auto stabilization. Alternatively, the controller may be configured to perform a manual calibration without the automatic features.

1. Beginning from the main menu, move the cursor down to "Program" and press Enter (F4). From the program menu, move the cursor down using the arrow key to highlight "Configure" and press Enter (F4).

Use the arrow key again to highlight "Auto Calibration" (as shown on the left) and press Enter (F4).

### NOTE

There are three buffer groups that may be selected. Automatic buffer recognition includes temperature curves from 0 to 60°C.

- a. Standard: Includes NIST (US), BSM (Britain), JIS 8802 (Japan) and DIN 19266 (Germany) buffers. See Table 5-2 for details.
- b. DIN 19267: 1.09/4.65/6.79/9.23/12.75
- c. Manual: (for manual calibration) disables automatic buffer recognition and stabilization.

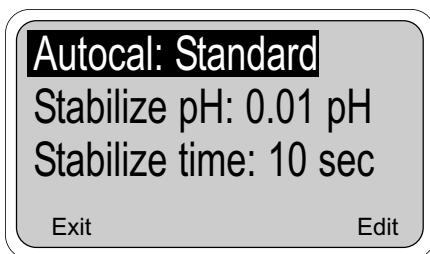

Menu Item	Options
Autocal	Standard/ DIN 19267/ Manual
Stabilize pH	0.01-0.50 pH
Stabilize time	0-30 sec

The values now being used by the controller are displayed. To change any of these items, use the arrow key to highlight the desired item and press Edit(F4). Use the arrow keys to make the change and press Save (F4) to enter the change into memory.

The pH reading must not change by more than the stabilize pH value over the stabilize time to be considered stable. Using a smaller pH value and a larger time provides the best protection against calibration while the reading is still changing.

**5.9 AUTO CALIBRATION SETUP (continued)****TABLE 5-2. Standard Buffers**

Buffer Value @ 25°C	Standards Referenced	Buffer Composition	Factory Configured
1.68	NIST, DIN 19266, JIS 8802	0.05M K tetroxalate	
3.56	NIST, BSM	KH tartrate (sat'd @ 25°C)	
3.78	NIST	0.05M KH <sub>2</sub> citrate	
4.01	NIST, DIN 19266, BSM, JIS 8802	0.05 KH Phthalate	X
4.64	BSM	0.1M HOAc .01M NaOAc	
6.86	NIST, DIN 19266, BSM, JIS 8802	0.025M KH <sub>2</sub> PO <sub>4</sub> 0.025M KH <sub>2</sub> HPO <sub>4</sub>	
7.00		0.05M NA <sub>2</sub> HPO <sub>4</sub> 0.05M KH <sub>2</sub> PO <sub>4</sub>	X
7.41	NIST, JIS 8802	0.0087M KH <sub>2</sub> PO <sub>4</sub> 0.0302M KH <sub>2</sub> HPO <sub>4</sub>	
9.18	NIST, DIN 19266, BSM, JIS 8802	0.01M Na <sub>2</sub> B <sub>4</sub> O <sub>7</sub>	
10.01	NIST, BSM, JIS 8802	0.025M NaHCO <sub>3</sub> 0.025M Na <sub>2</sub> CO <sub>3</sub>	X
12.45	NIST, DIN 19266	Ca(OH) <sub>2</sub> (sat'd @ 25°C)	

## SECTION 6.0

# THEORY OF OPERATION

### 6.1 THE pH SENSOR ASSEMBLY

The pH measurement is accomplished by means of a measuring electrode (usually made of glass) which develops a potential directly related to the hydrogen ion concentration (pH) of the solution in which the electrode is immersed. A second electrode, called the reference electrode, is necessary to complete the electrical circuit and to serve as a constant reference potential against which the potential of the glass electrode can be compared. Together, the two electrodes comprise the pH sensor.

#### The Glass Electrode

The glass electrode is a thin-walled bulb of glass containing a pH-buffered solution and the elements of a half-cell (typically silver/silver chloride). The glass membrane provides a means of collecting hydrogen ions so the potential can be measured. The hydrogen ions on the surface of the glass membrane are in equilibrium with the hydrogen ions in the solution being measured. As the hydrogen ion concentration in the solution changes, the concentration of hydrogen ions on the electrode changes, creating a change in potential on the glass electrode.

#### The Reference Cell

The purpose of the reference cell is to maintain a stable reference potential regardless of a change in sample pH. The cell is comprised of the reference electrode, reference fill solution and porous reference junction. The reference cell also serves to complete the voltage measuring circuit. Within the reference electrode, a silver chloride element is surrounded by a concentrated potassium chloride solution. The internal element maintains electrical contact with the pH sensitive glass electrode through the porous liquid junction (a multi-capillary hardwood plug) of the internal reference electrode.

The external wood reference junction and the gelled reference fill solution provide protection for the internal reference electrode to prevent contamination from harsh chemical environments. The internal liquid junction can become blocked if the process contains any material that reacts with the filling solution to form a precipitate. The double-junction reference electrode is

designed to avoid blocking of the internal liquid junction. It is essentially a complete electrode within an electrode outer body, using two liquid junctions.

A non-reactive electrolyte (potassium chloride gel) is the filling solution in the outer body, and only this solution is in contact with the process. Clogging of the outer junction is minimized, since neither potassium ions nor chloride ions form insoluble compounds with the majority of materials found in process streams. Contamination of the inner junction is not likely with this configuration.

#### The Temperature Compensation Element

In addition to the glass electrode and reference cell, a third element required in the pH measurement system is the temperature compensation element. Its purpose is to compensate for "apparent" pH changes due to the pH response of a glass electrode increasing with temperature. At values around 7 pH, the variation with temperature is zero. Thus, no compensation is required at 7 pH. The error caused by varying temperatures is greater at high/low pH values; in other words, as you move away from a neutral pH of 7. This compensation is done automatically by the Model 54e pH/ORP unless specifically disabled.

#### The Preamp

Because of the high resistance of the glass measuring electrode, a preamplifier must be used to transform the extremely low level, high impedance signal to a low-impedance signal. The Model 54e pH/ORP includes a switchable preamplifier that may be used if the distance to the pH sensor is less than 15 feet. When longer runs of cable are necessary, the preamp can be located in the pH sensor itself or in a remote junction box. Either design allows transmission of the pH signal long distances without suffering degradation or interference from outside voltage sources.

### 6.2 CONTINUOUS SENSOR DIAGNOSTICS

The Model 54e pH/ORP verifies the integrity of the glass and reference segments of the pH sensor by continuously measuring the impedance between each segment and the solution ground.

A new glass electrode has an impedance of approximately 200 megohms. As it ages, this value typically increases over time because lithium ions (which carry current) in the glass are slowly depleted by the process. If an electrode cracks, the impedance drops sharply, usually to below 5 MΩ.

The following Diagnostic Checks are possible with the Model 54e pH/ORP:

**Cracked Glass Diagnostic.** One way to tell that you have a broken or cracked glass electrode is that the controller will read a constant value (usually between 5.0-7.0 pH) in any process or buffer. The other way is to note the impedance value. The controller can be configured to generate a fault when the glass impedance drops below a setpoint. When a crack occurs, the controller will indicate that the electrode is broken.

#### NOTE

A broken electrode may not be detected above 70°C (158°F).

**Old Glass Diagnostic.** This diagnostic is used for programming the high impedance limit. For example, if the set point is 1000 megohms, and the impedance rises above this value, the controller will go into a fault mode. The electrode is either worn out, severely coated, or not immersed in the process fluid..

**Calibration Warning.** Under this diagnostic you can select the percent increase in impedance before a calibration warning fault appears. It is recommended to keep this feature disabled.

**High Reference Impedance.** The reference is also continuously checked. High values indicate a plugged liquid junction or a coated sensor. The setpoint can be adjusted depending on the sensor used. Always set this value above the value for a new clean sensor.

You may also get this fault if:

1. The sensor becomes excessively coated.
2. The sensor is not immersed in the process

#### Typical set points:

1. 1000 Megohms for old glass diagnostics.
2. 10 Megohms for cracked glass.
3. 0 Megohms for calibration warning (disabled)
4. 40 Kohms for high reference impedance.

#### NOTE

See Section 5.8 for instructions on changing these setpoints.

## 6.3 INTERVAL TIMER

The interval timer may be used for periodic sensor cleaning or periodic process adjustment (see Section 5.7 for procedure).

The interval timer settings are:

1. Timer - Enables/disables the interval timer.
2. Interval - the time period between cycles.
3. Repeats - the number of relay activations per cycle.
4. On time - the time period of one relay activation.
5. Off time - the time period between two or more relay activations.
6. Recovery - the time period following the final relay activation.

The cycle begins at the Interval time when the Switch is turned on. When the Interval time has expired the analyzer activates hold mode and the relay is activated for the On time period. If the number of Repeats is greater than one, the relay is deactivated for the Off time period and reactivated for the On time period for the number of relay activations selected. When the final relay activation is complete the relay is deactivated for the Recovery time period. Note that no Off time period follows this last relay activation. When the Recovery time period expires the Hold mode deactivates, and the cycle repeats, beginning with the Interval time.

Typically, the interval timer is configured with a long Interval, several Repeats of fairly short On times, fairly short Off times and a Recovery time which allows the process to stabilize. Setting Interval to zero results in continuous pulsing and setting Off time to zero will cause a single pulse equal to [On time x Repeats].

High reference impedance can be used to trigger timer activation. In this case, the interval time is used only to allow the analyzer time to determine whether the reference impedance has exceeded the reference impedance setpoint. If the reference impedance setpoint is exceeded, the timer cycle will begin. This is an ideal way to start a cleaning cycle in a dirty application.

Note that the hold mode supersedes the Timer State. If the hold mode is on, the present interval time continues to expire and once expired the interval timer is suspended until the hold state is removed. For more information on Controller Mode Priority, see Table 6-1.

## 6.4 ALARM RELAYS

An alarm is a relay that closes a set of contact points (a switch) inside the controller. In doing so, the relay closes an electrical circuit and turns on a device wired to the contacts. The Model 54e pH/ORP controller has four alarm relays.

The relays are turned on and off by the controller based on the control points or setpoints that you program into the controller through the keypad. See Section 5.7 "Alarms" to program the alarm relays.

The Model 54e pH/ORP has two control modes for devices which are turned off and on: Time Proportional Control Mode (TPC), and Normal Mode. TPC is generally used for chemical feed control. Normal or "on-off" mode is typically used to control external alarm lights or horns.

## 6.5 TIME PROPORTIONAL CONTROL (TPC) MODE (Code -20)

In the TPC mode, you must establish the following parameters which will determine how the Model 54e pH/ORP responds to your system (see Section 5.7):

- Setpoint
- Time period
- URV point (or 100% on)
- LRV point (or 0% on)
- Proportional
- Integral
- Derivative

The setpoint is the desired value that you want to control at. Time period is programmed in seconds and defines the interval during which the controller compares the pH input from the sensor with the Setpoint. In the TPC mode the controller divides the period up into pump on-time (feed time) and pump off-time (blend time).

The URV setting determines how far the pH must deviate from the setpoint to get the pump to be on for the entire period. The LRV setting determines how close the pH must be to the setpoint for the pump to be off for the entire period. The LRV setting should always be set at zero. When the error (the pH minus the setpoint) is between the URV and LRV values, the relay will be energized for some portion of the time period. As the pH

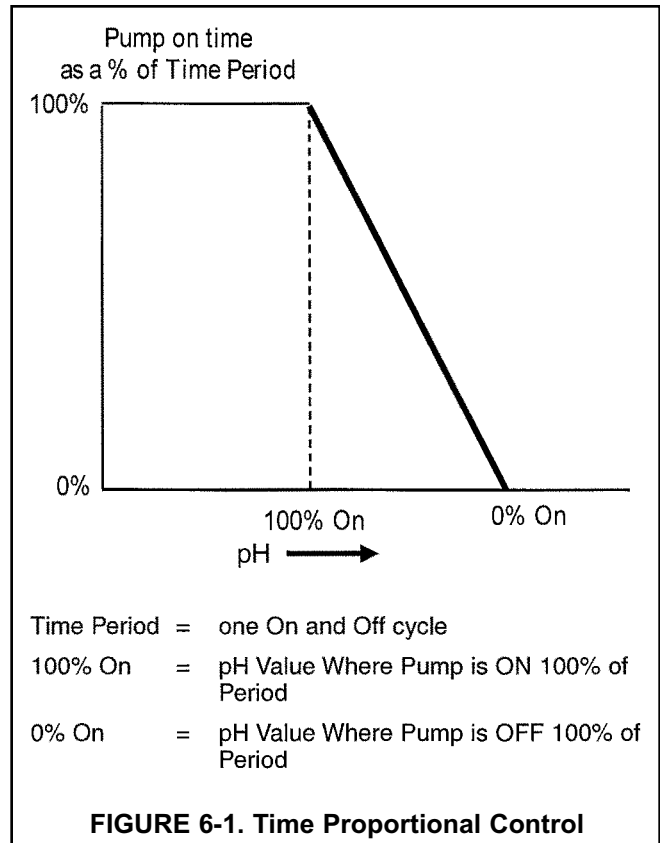

value approaches the setpoint, the pump will be feeding for shorter and shorter intervals, and the chemicals will be allowed to mix for longer and longer intervals of the period. This relationship is illustrated in Figure 6-1.

The exact amount of on time and off time per period is determined by the settings for proportional, integral, and derivative bands. The proportional band (P) in % is a separate adjustment that narrows (or widens) the range of the TPC 0-100% action. Smaller values are used for more control response. For a setpoint of 7 pH, a URV of 2 pH, and P=100%, a pH reading of 8 would result in a relay on  $(8-7)/((2-0)*(100\%))$  or 50% of the time. If P was changed to 50%, the same relay would be on  $(8-7)/((2-0)*50\%)$  or 100% of the time.

The integral band is set in seconds and acts to increase the controller output as more time is spent away from the setpoint. A smaller value in seconds will result in faster integration response. Too low a value will result in excess oscillation.

The derivative band is set in % and acts to prevent changes in the reading. This setting should generally be set to zero for pH and ORP applications.

TPC offers precise control by forcing the pump to feed chemical for shorter periods of time as you approach the desired setpoint. If the process faces a large upset, TPC mode forces the pump to feed chemical for longer periods of time as the process deviates further from the setpoint. This action continues until the pump is feeding all the time, providing a speedy recovery from large up-sets.

The controller can be programmed to be direct or reverse acting, depending on the pH (or temperature) value selected for URV. For example, if the controller is direct acting based on pH, such as in caustic chemical addition control, the pH will rise as chemical is added, so the URV value will be below the LRV (i.e. below zero). As the pH rises toward the control point value, the pump will be on for gradually less time. Conversely, if the controller is reverse-acting based on pH, such as in acid addition for control, the pH will drop as acid is added, and the URV value will be positive. The pH will fall toward the control point value, and the pump will be on for gradually less time.

Complete TPC configuration is explained and typical settings for these parameters are listed in Section 5.0. After startup, the operator needs to adjust only the 0% On to maintain the desired chemical concentration.

## 6.6 NORMAL MODE

Normal mode is on-and-off control based on an alarm setpoint. To prevent nuisance alarms, a hysteresis (deadband) setting, and/or a time delay can be programmed during configuration. You can configure each alarm to trigger above the setpoint as a high alarm or below the setpoint as a low alarm. The operator need only raise or lower the alarm setpoint as necessary.

## 6.7 ANALOG OUTPUTS

The Model 54e pH/ORP controller includes a second analog output. An analog output produces an electrical current signal which varies in linear proportion to a value measured by the controller. You can configure the controller to produce a 4-20 mA or 0-20 mA current output proportional to pH or temperature. See Section 5.6 for programming details.

The analog output must be "scaled" so that 4 (or 0) mA corresponds to the low end of the scale and 20 mA corresponds to the high end. The operator can scale the output as in the following example:

The Model 54e pH/ORP is connected to a strip chart recorder with a 0 to 100% scale. The average value of the bath is 10.0 pH, plus or minus 0.5 pH. The operator wants to match this value with the 50% mark on the recorder. To do so, the operator selects 9.5 pH as the 4 mA value and 10.5 pH as the 20 mA value by entering them as in Section 5.3. The chart on the recorder will display 0% when the pH is 9.5 or below and 100% when the pH equals 10.5 or greater. (this is for a 4-20 mA recorder).

The Model 54e pH/ORP is also capable of PID control where the analog output will be proportional to the difference between the setpoint and the measured variable, either pH or temperature. This control mode is used to modulate a pump or valve, rather than to turn a device off and on.

## 6.8 CONTROLLER MODE PRIORITY

Your Model 54e pH/ORP can function in different modes depending on both how it is configured, what process conditions exist, and actions an operator may have made. To reconcile these possible modes, there is a set priority that determines exactly what will happen to the 2 current outputs and the 4 alarm relays in the event of multiple modes occurring at the same time. See Table 6-1 below.

Priority is in the following order (from lowest to highest): normal, fault, timer, hold, feed limit, test. Each output or relay acts as if it is only in the state of highest priority.

**NOTE**

Some of these features may not be in use for your controller.

**TABLE 6-1. Controller Mode Priority Chart**

Condition	Priority	Current Output 1	Current Output 2	Alarm Relay 1	Alarm Relay 2	Alarm Relay 3	Alarm Relay 4
Normal	1	Normal	Normal	Normal	Normal	Normal	Open
Fault	2	Default	Default	Default	Default	Default	Closed
Interval Timer	3	Hold	Hold	Default/ Normal <sup>1</sup>	Default/ Normal <sup>1</sup>	Default/ Normal <sup>1</sup>	Prior
Hold Mode	4	Hold	Hold	Default	Default	Default	Prior
Feed Limit	5	Normal	Normal	Open <sup>1</sup>	Open <sup>1</sup>	Open <sup>1</sup>	Closed
Simulate tests	6	Test <sup>1</sup>	Test <sup>1</sup>	Test <sup>1</sup>	Test <sup>1</sup>	Test <sup>1</sup>	Test <sup>1</sup>

<sup>1</sup> Indicates the state **IF** that item has been configured or selected (i.e. if it is an interval timer or a feed limit timer or it is the one being tested). Unconfigured or unselected items are not affected by that mode.

**Condition Definitions:**

1. Normal refers to conditions when no other mode is present.
2. Fault is when the instrument has diagnosed a fault condition.  
A fault message is displayed and the red LED will be on.
3. Interval Timer is only while the timer sequence is occurring.
4. Hold Mode is while hold is activated by the operator (i.e. during calibration).
5. Feed Limit occurs when a feed limit timer has reached it's limit and is turned off after being on for too long.
6. Simulate tests are described in Section 5.4.

**Action Definitions:**

1. Normal is determined by process conditions or how the item has been configured (Sections 5.5, 5.6)
2. Open is a deenergized alarm relay. (alarm off)
3. Default is the setting configured for each item if there is a fault. (Sections 5.5, 5.6)
4. Closed is an energized alarm relay. (alarm on)
5. Hold is the setting for the current output configured in Section 5.5 (this could be a fixed mA value or the last normal value)
6. Prior is the state the alarm had before that mode occurred.
7. Test is the value input by the operator (mA for current, on or off for a relay).

## 6.9 PID CONTROL (CODE -20)

### PID Control

The Model 54e pH/ORP current outputs can be programmed for PID control. PID control is used with a control device which is capable of varying its output from 0 to 100 percent in response to a changing signal in milliamps. Automated control valves or variable volume pumps are commonly used. These types of devices are referred to as modulating control devices because of their 0 to 100% adjustability. PID control is typically used where greater accuracy than is achievable with an on/off device is required, or where it is desirable to have the pump or valve "on" continuously, or where the existing or preferred pump or valve is of the modulating type.

Any process control system must manually or automatically hold the controlled variable (pH, conductivity, temperature) in a steady condition at selected set point values. For manual control, the operator looks at the value of the process variable, decides whether or not it is correct, and makes necessary adjustments. He decides the amount, direction, rate of change and duration of the adjustment. With automatic control, the controller does all of this. The operator only adjusts the set point of the controller to the selected value of the measured variable. Automatic process control such as PID is usually feedback control; it eliminates the deviation between measurement and set point based on continuous updates (feedback) from the process itself.

### Measurement and Set Point (Feedback Control)

The Model 54e pH/ORP controller is given two items of information: measurement and set point. The controller reacts to the difference in value of these two signals and produces an analog output signal to eliminate that difference. As long as the difference exists, the controller will try to eliminate it with the output signal. When measurement and set point are equal, the condition of the controller is static and its output is unchanged. Any deviation of measurement from set point will cause the controller to react by changing its output signal.

### PID Control Mode Combinations

All PID controllers have several control modes which can be used in various combinations: proportional plus integral (reset), proportional plus derivative (rate) and a combination of proportional (P), integral (I) and derivative (D). Each control mode produces a response to the deviation of measurement from set point that is the result of a specific characteristic of the deviation, and each control mode is separately adjustable. D, the derivative, or rate mode, is seldom used in water treatment and is beyond the scope of this manual.



## 6.9 PID CONTROL (continued)

### Proportional Mode (Gain)

The simplest control is proportional. Proportional may also be referred to as sensitivity or gain. Although these terms may refer to a different version of proportional, the control function is still fundamentally the same - the error from set point is multiplied by this factor to produce the output.

**The Model 54e pH/ORP's proportional mode is referred to as proportional "band" which is configurable from 0 to 299%.** For good control of a specific process, the proportional band must be properly adjusted. The proportional band is the percent of the analog output span (the difference between the 4 (or 0) mA and 20 mA settings) through which the measured variable must move to change the output from minimum to maximum. **The larger the proportional band, the less the controller reacts to changes in the measured variable. As the proportional band is made smaller, the reaction of the controller increases.** At 0 proportional band, the proportional-only controller behaves like an on/off controller (an alarm set at 20 mA).

Most processes require that the measured variable be held at the set point. The proportional mode alone will not automatically do this. Proportional alone will only stabilize the measured variable at some offset to the actual control point. To control at an exact setpoint, proportional plus integral mode is used.

### Proportional (Gain) Plus Integral (Reset)

For the automatic elimination of deviation, I (Integral mode), also referred to as Reset, is used. The proportional function is modified by the addition of automatic reset. With the reset mode, the controller continues to change its output until the deviation between measurement and set point is eliminated.

The action of the reset mode depends on the proportional band. The rate at which it changes the controller output is based on the proportional band size and the reset adjustment. **The reset time is the time required for the reset mode to repeat the proportional action once. It is expressed as seconds per repeat, adjustable from 0-2999 seconds.**

The reset mode repeats the proportional action as long as an offset from the set point exists. Reset action is cumulative. The longer the offset exists, the more the output signal is increased.

The controller configured with reset continues to change until there is no offset. If the offset persists, the reset action eventually drives the controller output to its 100% limit - a condition known as **"reset windup"**. To prevent reset windup, a controller with reset mode should never be used to control a measured variable influenced by uncorrectable conditions. Once the controller is "wound up", the deviation must be eliminated or redirected before the controller can unwind and resume control of the measured variable. The integral time can be cleared and the "windup" condition quickly eliminated by **manually overriding the Model 54e pH/ORP's analog output using the simulate tests feature (detailed in Section 5.4).**

### Control Loop Adjustment and Tuning

There are several methods for tuning PID loops including: Ziegler-Nichols frequency response, open loop step response, closed loop step response, and trial and error. Described in this section is a form of the open loop response method called the process reaction curve method. The reaction times and control characteristics of installed equipment and real processes are difficult to predict. The Process Reaction Curve Method of tuning works well because it is based on the response of the installed system. This procedure, outlined in the following paragraphs, can be used as a starting point for the **P** and **I** settings. Experience has shown that PID controllers will do a fair job of controlling most processes with many combinations of reasonable control mode settings.

## 6.9 PID CONTROL (continued)

### Process Reaction Curve Method

A PID loop can be tuned using the Process Reaction Curve Method. This method involves making a step change in the chemical feedrate (usually about 50% of the pump or valve range) and graphing the response of the Model 54e pH/ORP reading versus time.

The process reaction curve graphically shows the reaction of the process to step change in the input signal. Figure 6-2 shows an example of a tuning process for a pH controller. Similar results can be obtained for the conductivity controller.

To use this procedure with a Model 54e pH/ORP and a control valve or metering pump, follow the steps outlined below.

The Model 54e pH/ORP should be wired to the control valve or metering pump. You will introduce a step change to the process by using the simulate test function to make the step change in the output signal.

The change in the measured variable (conductivity, pH, or millivolts) will be graphed as shown in Figure 6-2.

This can be done by observing the reading on the Model 54e pH/ORP and noting values at intervals timed with a stop watch. A strip chart recorder can be used for slower reacting processes. To collect the data, perform the following steps:

1. Let the system come to a steady state where the measured variable (pH, conductivity or temperature) is relatively stable.
2. Observe the output current on the main display of the controller.
3. Using the simulate test, manually set the controller output signal at the value which represented the stable process measurement observed in step 1, then observe the process reading to ensure steady state conditions (a stable process measurement).
4. Using the simulate test, cause a step change in the output signal. This change should be large enough to produce a significant change in the measured variable in a reasonable amount of time, but not too large to drive the process out of desired limits.

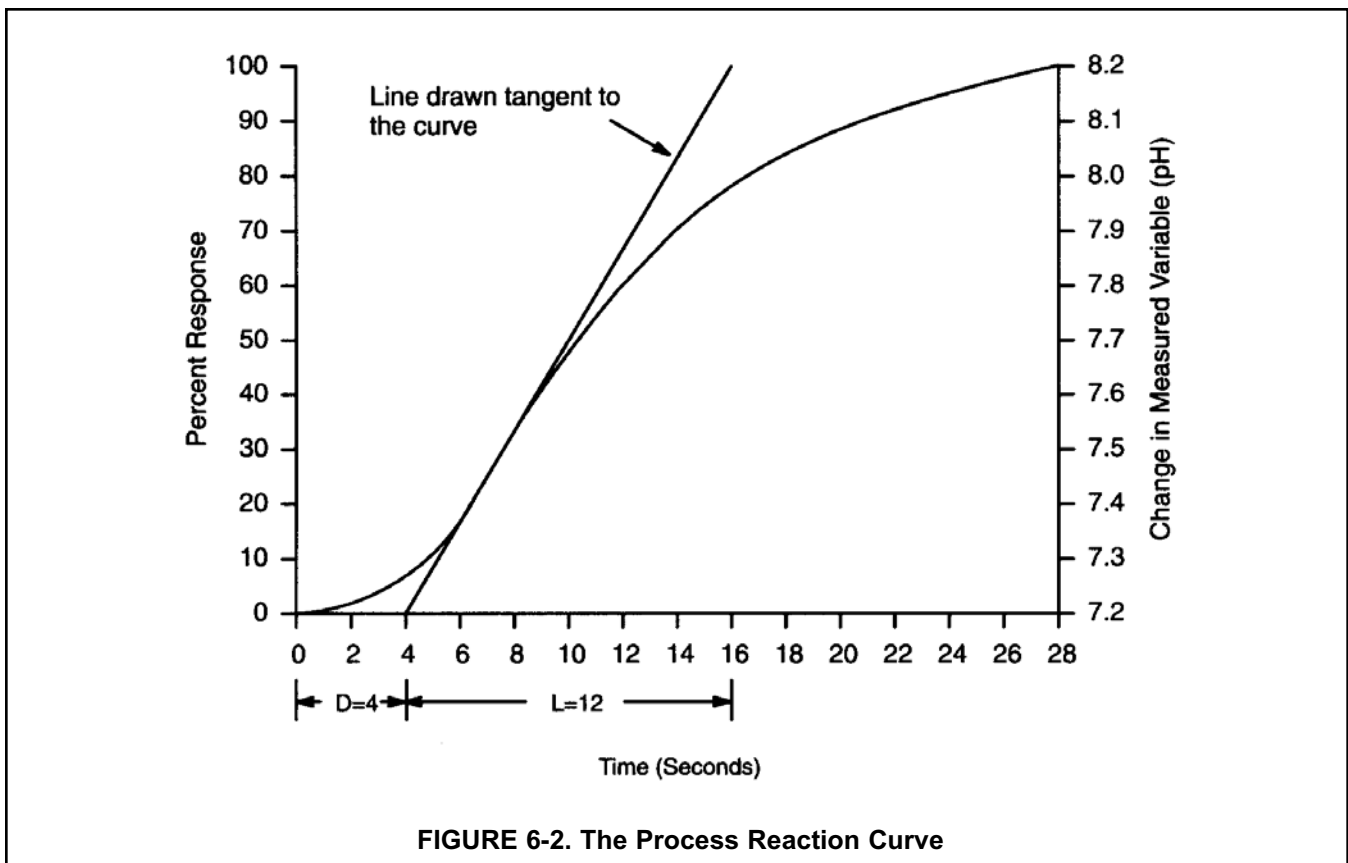

FIGURE 6-2. The Process Reaction Curve

## 6.9 PID CONTROL (continued)

- The reaction of the system, when graphed, will resemble Figure 6-2, showing a change in the measured variable over the change in time. After a period of time (the process delay time), the measured variable will start to increase (or decrease) rapidly. At some further time the process will begin to change less rapidly as the process begins to stabilize from the imposed step change. It is important to collect data for a long enough period of time to see the process begin to level off to establish a tangent to the process reaction curve.
- When sufficient data has been collected, return the output signal to its original value using the simulate test function. Maintain the controller in this manual mode until you are ready to initiate automatic PID control, after you have calculated the tuning constants.

Once these steps are completed, the resulting process reaction curve is used to obtain information about the overall dynamics of the system. It will be used to calculate the needed tuning parameters of the Model 54e pH/ORP controller.

### NOTE

The tuning procedure outlined below is adapted from "Instrumentation and Process Measurement and Control", by Norman A. Anderson, Chilton Co., Radnor, Pennsylvania, ©1980.

Information derived from the process reaction curve will be used with the following empirical formulas to predict the optimum settings for proportional and integral tuning parameters.

Four quantities are determined from the process reaction curve for use in the formulas: time delay (D), time period (L), a ratio of these two (R), and plant gain (C).

A line is drawn on the process reaction curve tangent to the curve at point of maximum rise (slope) as shown in Figure 6-2. The Time Delay (D), or lag time, extends from "zero time" on the horizontal axis to the point where the tangent line intersects the time axis. The Response Time period (L), extends from the end of delay period to the time at which the tangent line intersects the 100% reaction completion line representing the process stabilization value. The ratio (R) of the Response Time period to the Time Delay describes the dynamic behavior of the system.

In the example, the process Delay Time (D) was four seconds and the Response Time period (L) was 12 seconds, so:

$$R = \frac{L}{D} = \frac{12 \text{ seconds}}{4 \text{ seconds}} = 3$$

The last parameter used in the equations is a plant gain (C). The plant gain is defined as a percent change in the controlled variable divided by the percent change in manipulated variable; in other words, the change in the measured variable (pH, conductivity, temperature) divided by the percent change in the analog output signal.

The percent change in the controlled variable is defined as the change in the measured variable (pH, conductivity, temperature) compared to the measurement range, the difference between the 20 mA (Hi) and 4 (or 0) mA (Lo) setpoints, which you determined when configuring the analog output.

In the example shown in Figure 6-2:

The percent change in pH was:

$$\frac{\text{pH}_2 - \text{pH}_1}{\text{pH "Hi"} - \text{pH "Lo"}} \times 100\% = \frac{8.2 - 7.2 \text{ pH}}{9.0 - 6.0 \text{ pH}} = 33.3\%$$

The change in the output signal was:

$$\frac{6 - 4 \text{ milliamps}}{20 - 4} \times 100\% = 12.5\%$$

So the Plant Gain is:

$$C = \frac{33.3}{12.5} = 2.66$$

Once R and C are calculated, the proportional and integral bands can be determined as follows:

$$\text{Proportional band (\%)} = P = 286 \frac{C}{R}$$

$$\text{Integral Time (seconds per repeat)} = I = 3.33 D \times C$$

So for the example:

$$P = \frac{286 (2.66)}{3} = 254\%$$

$$I = 3.33 (4 \text{ sec.}) 2.66 = 36 \text{ seconds}$$

To enter these parameters, use the procedure detailed in Section 5.6.

## SECTION 7.0

# SPECIAL PROCEDURES AND FEATURES

This section covers features of the Model 54e pH/ORP controller that are used less frequently. Use of the features outlined in the appendix is optional.

Special procedures and features outlined in this appendix include the following:

- Password Protection
- Temperature Slope Calculation
- Temperature Sensor
- Reference Temperature
- Controller Mode Priority
- PID Control

Before using this section, you should become familiar with the basic Theory of Operation of the controller as outlined in Section 6.0, the keypad functions in Section 1.0, and the List of Settings Table and configuration procedures outlined in Section 5.0.

As with all the settings in your Model 54e pH/ORP, the first step to configuration is obtaining a good understanding of how the feature works, before determining the values of the settings to achieve the desired control. This appendix provides more background for deciding on the appropriate settings. Configuring the settings is done using the instructions in this appendix and Section 5.0, Software Configuration.

### 7.1 PASSWORD PROTECTION

Your Model 54e pH/ORP can be programmed so that a 3-digit password must be entered before any changes in the configuration are allowed. This protects your controller from tampering by unauthorized users. There are three levels of password access, Level 1 (calibration only), Level 2 (lockout of Configure Menu), and Level 3 (total access). Password privileges for each level are described below.

If password protection is not desirable, you can configure all security codes to be 000. This will leave the controller unlocked so the configuration can be changed without entering a password. The controller is shipped from the factory with the password set at 000.

### Level 1 - 3 Password Privileges

Level 1 access is usually given to an operator who simply needs to calibrate during the course of normal operation. A separate section of the manual contains operating procedures normally used by this type of personnel. Level 1 restricts the operator from changing the major control mode configuration by preventing access to the Program Menu.

The Level 1 user can do the following:

1. Access Diagnostic Variables (Section 8.1).
2. Zero the controller in air (Section 4.3).
3. Enter the Temperature Slope (Section 4.4).
4. Change Temperature Compensation from Auto to Manual and select a temperature (Section 4.7).
5. Calibrating pH and Temperature readings (Section 4.1 and Section 4.6).

A Level 2 user can do all of the above and:

1. Change control setpoints for PID current outputs (Section 5.1).
2. Change alarm setpoints for normal and TPC alarms (Section 5.2).
3. Rerange both 4-20 (or 0-20) mA outputs (Section 5.3).
4. Manually test both outputs and all 4 alarm relays for operation.

A Level 3 user has total access to the Configure Menu and can make any changes that are deemed necessary.

**These privileges should be given only to an individual who fully understands the controller, the process and the potential effects of modifying the setup.**

An individual with no password access privilege can only view the main display, containing conductivity, temperature, current output 1, and the lower line display items configured in Section 5.5.

#### NOTE

You must have level 3 access to change any security code.

## 7.2 CONFIGURING SECURITY

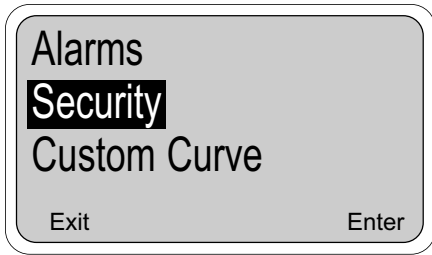

Security clearance is required at the following security "gates". Users without the security code will only be able to use the features indicated in parentheses:

- I. Lock out all access (read main screen only)
- II. Lock out program features (only calibration is allowed)
- III. Lock out configuration features (only calibration, alarm setpoint and rerange output setpoints (4 and 20 mA values) are allowed)

For convenience, the level 3 security code will be accepted at levels 1 and 2 and the level 2 security code will be accepted at level 1.

1. Beginning from the main menu, move the cursor down to "Program" and press Enter (F4). From the program menu, move the cursor down using the arrow key (↓) to highlight "Configure" and press Enter (F4).

Use the arrow key again to highlight "Security" (as shown on the left) and press Enter (F4).

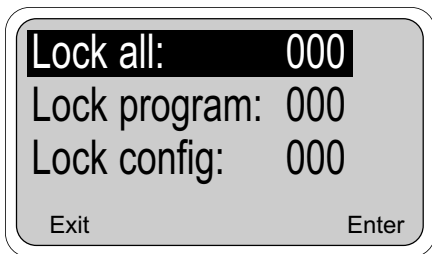

2.

Menu Item	Options
1 Lock all	000-999
2 Lock program	000-999
3 Lock configuration	000-999

The values now being used by the controller are displayed. To change any of these items, use the arrow key to highlight the desired item and press Edit (F4). Use the arrow keys to make the change and press Save (F4) to enter the change into memory.

### NOTES ON SECURITY:

- a. A code of 000 disables security for that level.
- b. The security feature will not activate until the keypad has not been pressed for a short period of time (the timeout value programmed in Section 5.5).
- c. A hold condition will indefinitely prolong the time out period.
- d. Security will activate immediately if power is removed from the controller and then restored.
- e. **Forgotten Code:** Press and hold F4 Key for 5 seconds when the security screen appears and the code for that level will appear on the display.

## 7.3 SOLUTION TEMPERATURE COMPENSATION

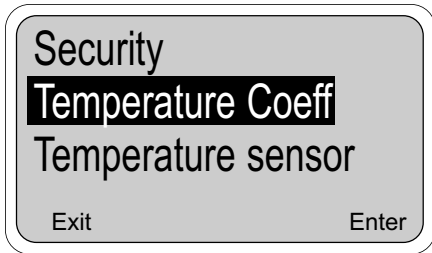

This section is for advanced users only.

It explains how to input values for:

- the isopotential pH and
- the temperature coefficient for solution temperature compensation.

1. Beginning from the main menu, move the cursor down to "Program" and press Enter (F4). From the program menu, move the cursor down using the arrow key to highlight "Configure" and press Enter (F4).

Use the arrow key again to highlight "Temperature Coeff" (as shown on the left) and press Enter (F4) .

The Controller can compensate for two different temperature effects on the measured pH: the temperature effect on the pH sensor and the temperature effect on the actual pH of the process solution.

**Sensor Temperature Compensation.** The millivolt output of a pH sensor changes with temperature, which in turn, changes the measured pH value. The Sensor Isopotential pH (Sensor ISO) is the pH where the pH sensor's output does not change with temperature. The Controller uses the Sensor Isopotential pH value to correct for the temperature effect on the pH sensor. Except in rare instances (antimony or glass on metal electrode systems), the Sensor Isopotential pH is always 7.0 pH.

**Solution Temperature Compensation.** The actual pH of a solution can sometimes noticeably change with temperature. This can occur in solutions with a pH above 6.5 pH and in solutions containing weak acids, bases, and their salts. This effect can be compensated for by entering a Temperature Coefficient (Temperature Coeff) which is the change in solution pH per degree centigrade (°C). If there is no noticeable solution pH change with temperature, or solution temperature compensation is not desired, the Temperature Coefficient (Temperature Coeff) should be set to 0.00.

**Operating Isopotential pH.** The Operating Isopotential pH (Operate ISO) is the Isopotential pH, which the Controller is using for overall temperature compensation. It represents a combination of both the sensor and the solution temperature compensations.

If no solution temperature compensation is being used (Temperature Coeff = 0), the Operating Isopotential pH (Operate ISO) is equal to the Sensor Isopotential pH (Sensor ISO).

If there is a non-zero Temperature Coefficient (Temperature Coeff) being used, the Controller automatically calculates the Operating Isopotential pH (Operate ISO) from the following relation:

$$\text{Operate ISO} = \text{Sensor Iso} - (\text{Temperature Coeff}) \times (298.16)$$

Conversely, if an Operating Isopotential pH is known for a particular solution, the Controller will automatically calculate the corresponding Temperature Coefficient.

Example: High Purity water with Ammonia, being measured with a normal pH sensor (Sensor Isopotential pH of 7.0 pH), has a Temperature Coefficient of -.033pH per °C and an Operating Isopotential pH of 16.84.

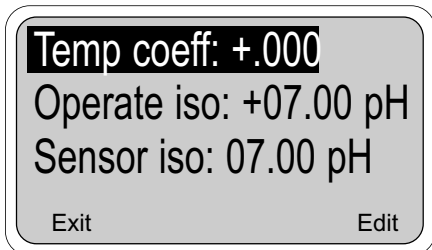

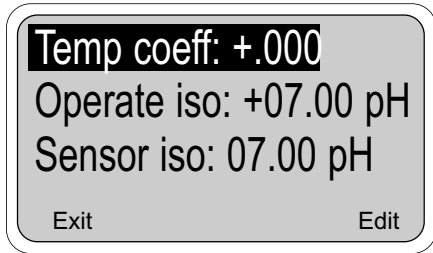
**7.3 SOLUTION TEMPERATURE COMPENSATION (continued)**

2.

Menu Item	Options
Temperature coefficient	-0.044 to 0.028 pH/°C (0.00 for most applications)
Operating isopotential (Isopotential pH)	-1.35 to 20.12 pH (7.00 for most applications)
Sensor isopotential	0-14 pH (7.00 for most applications)

The values now being used by the controller are displayed. To change any of these items, use the arrow key to highlight the desired item and press Edit **[F4]**. Use the arrow keys to make the change and press Save **[F4]** to enter the change into memory.

## SECTION 8.0 TROUBLESHOOTING

The Model 54e pH/ORP automatically searches for fault conditions that would cause an error in the measured pH reading. If such a condition occurs, the current outputs and alarm relays will act as configured in Section 5.6 and Section 5.7, the red "FAIL" LED on the controller panel will be lit and a diagnostic message will be displayed. If more than one fault exists, the display will sequence through the diagnostic messages. This will continue until the cause of the fault has been corrected or until the Ack **[F2]** key is pressed.

### Troubleshooting is easy as 1, 2, 3...

- Step 1** Look for a diagnostic fault message on the display to help pinpoint the problem. Refer to Table 8-1 for an explanation of the message and a list of the possible problems that triggered it.
- Step 2** Refer to the Quick Troubleshooting Guide, Table 8-2, for common pH hardware problems and the recommended actions to resolve them.
- Step 3** Follow the step by step troubleshooting approach offered in Table 8-3 to diagnose less common or more complex problems.

#### CAUTION

Do not attempt to troubleshoot unless you have familiarized yourself with this manual. Only trained, qualified technicians should perform these procedures. Do not attempt to troubleshoot, repair, or modify the printed circuit cards or electronic components inside the controller.

#### IMPORTANT

**Always recalibrate the controller before returning it to service.**

Many control problems are unrelated to the pH measurement system. When problems arise, first check other systems that affect chemical concentration. Consider what may have changed in the system that can cause poor control. Some causes for poor control other than controller malfunction are:

1. An empty chemical drum.
2. Malfunction of a chemical feed pump, pump motor, or motor starter.
3. Water inlet or drain valves stuck or left open by operators.
4. Check flow interlocks (if used).
5. A temperature control malfunction.
6. Broken or blocked chemical feed lines.
7. A conductivity probe that has been left out of the bath.
8. The level of bath is below the probe and the probe is dry.
9. The probe needs to be cleaned.
10. The condition of the incoming metal has changed, i.e., temperature, cleanliness, speed.
11. The condition of the incoming water has changed, i.e., temperature, cleanliness, flow rate, hardness, pH.
12. Unauthorized personnel have tampered with the controller settings.
13. Standardizing procedure is not accurate due to a malfunctioning laboratory instrument or contaminated chemical standard solutions.

#### WARNING

To prevent chemical feed into the process or injury to operating personnel, disconnect or disable the chemical feed pump and other external devices while you are servicing and troubleshooting the controller.



**TABLE 8-1. Diagnostic Messages**

<b>Diagnostic Messages</b>	<b>Description of problem</b>
"Cracked glass failure"	Broken or cracked glass electrode
"Zero offset error" *	Reference electrode poisoned.
"High reference impeded"	1. Coated reference electrode (Sensor cleaning recommended) 2. Sensor out of process.
"Temp error high" "Temp error low"	1. Open or shorted RTD 2. Temperature out of range
"Calibration warning"	1. Calibration suggested due to change in glass 2. Sensor out of process
"Old glass warning"	1. Glass electrode worn out 2. Sensor out of process
"Lo slope error"* "Hi slope error"*	1. Worn out electrode 2. Improper buffer calibration (check buffer accuracy, wait for stabilization in buffers) 3. Plugged liquid junction/coated glass
"Sensor line open"	1. Open wire between sensor and controller. 2. Distance between sensor and controller is too long.
"Failure - EEPROM" "Failure - CPU" "Failure - Factory"	1. Defective CPU board. Notify Rosemount if cycling power does not clear the fault
"Failure - ROM"	Bad "ROM" chip on CPU board
"Field cal needed"	Output 1 and 2 need adjustment
"Hold mode activated" (operator activated)	All relays open and outputs set to default values
"High input voltage"	Open connection from preamplifier to controller.
"Low input voltage"	Open connection from glass electrode to preamplifier.
"High reference voltage"	1. Sensor not in process 2. Coated Sensor 3. Open wire between preamplifier and controller.
"Simulating Output 1 or 2" "Simulating Alarm 1, 2, 3, or 4"	The indicated output or alarm is being tested. see Section 5.4
"Feed limit alarm 1, 2, or 3"	Indicated alarm has been on for longer than it's limit and has been turned off.

\* **Off line** error messages will not initiate fault condition, and will display only once. The message will clear from the screen when a key is pressed.

**TABLE 8-2. Quick Troubleshooting Guide**

<b>SYMPTOM</b>	<b>ACTION</b>
pH reading won't change in different buffers.	Clean the electrode, check wiring. Replace electrode.
"Cracked glass failure".	1. Replace electrode if cracked. 2. Check wiring for short.
pH sensor has sluggish response.	Clean the electrode; if still sluggish soak in 1% HCl for 1 hr. Replace electrode if not rejuvenated by the HCl soak.
"Old glass warning".	Check sensor in buffers; replace if calibration unsuccessful.
"Lo or Hi slope error".	1. Verify internal preamp switch is in the appropriate position. 2. Improper buffer calibration: check buffer accuracy; wait for reading to stabilize; 3. Clean the electrode; if fault persists; replace electrode. 4. If new electrode doesn't resolve the fault; replace preamp.
"Calibration warning".	Check sensor in buffers; replace if calibration unsuccessful.
"Wait" flashing continuously; won't stabilize during Auto Buffer Calibration.	1. Readjust stabilization pH or time for Auto Cal (Section 5.9) 2. Clean the sensor and retry Auto Cal in buffers. 3. Try a Manual Buffer Calibration. (see Section 5.9 for configuration)
Calibrates in buffers but not in the process	1. Verify process reading to be correct 2. Possible ground loop. Make sure that the shield wires do NOT touch grounded metal. (Process noise).
Incorrect temperature reading. Suspected temp. compensation problem. "Temp. error high" "Temp. error low"	1. Standardize the temperature 2. Verify sensor's RTD resistance vs. temperature 3. Verify temperature reading to be correct
Display segments missing.	Replace Display board.
Analyzer locks up; won't respond.	Replace CPU board.
Erratic display and relays chattering.	Check alarm set points, configuration (Sections 5.2, 5.7)
Analyzer not responding to key presses. Key press gives wrong selection.	Verify and clean ribbon cable connection on CPU board. Replace enclosure door/keyboard assembly.
Wrong or no current output.	1. Verify that output is not being overloaded (max load is 600 ohms) 2. Rerange outputs (Section 3.3) 3. Replace Power board
No display or indicators.	Verify that the removable fuse module is securely seated.
Alarm relay closure problems. Power board cut-off.	Check Power board. Replace the Power board.
Sensor diagnostics faults keep appearing	1. Calibrate sensor in buffers; replace if unsuccessful 2. Check the diagnostic variables for inappropriate settings (Section 5.8) 3. Turn analyzer diagnostics "OFF" (Section 5.8) 4. Verify proper wiring and preamp switch position. 5. Perform Systematic Troubleshooting procedures.

## 8.1 DISPLAYING DIAGNOSTIC VARIABLES

This section explains how these helpful diagnostics can be viewed:

1. **Electrode input in mV:** Used to check if the signal produced by the sensor is within acceptable limits (see Figure 8-1 for typical sensor mV response at 25°C).
2. **Glass impedance in MΩ:** Used to check integrity of glass electrode. Broken glass membranes will have low impedance.
3. **Reference impedance in kΩ:** Used to indicate how coated the reference electrode has become. Coated or plugged sensors will have high values of reference impedance.
4. **Zero offset in mV:** Indicates the deviation from the typical sensor response (Figure 8-1) as of the last buffer calibration. The controller compares the value at 7 pH with the ideal value of zero mV at 7 pH.
5. **Slope in mV/pH:** Indicates the sensitivity of the glass electrode. This number tends to drop as a sensor ages. Values below 47 are considered too low for calibration.
6. Software version

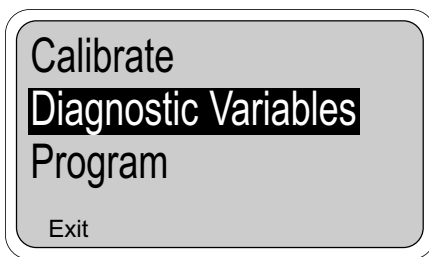

Use the following procedure :

1. From the main display, press any key.
2. With the down arrow key, move the cursor down to "Diagnostic Variables" and then press Enter (F4).

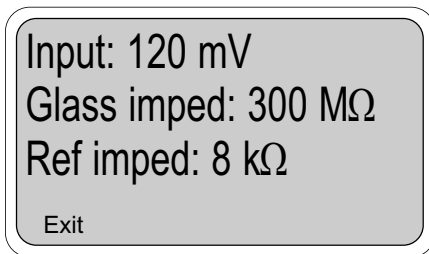

3. Diagnostic variables are displayed three at a time. More variables are viewable until the cursor (showing highlighted text) is brought down to the bottom line.

Use the down arrow key to view the items on the lower screen.

The up arrow key can be used to return to a previously viewed item .

Press the Exit (F1) key to return to the main menu above.

### NOTE

Many diagnostic variables can be read directly on the main display in the lower left or lower right positions. For details, see Section 5.5.

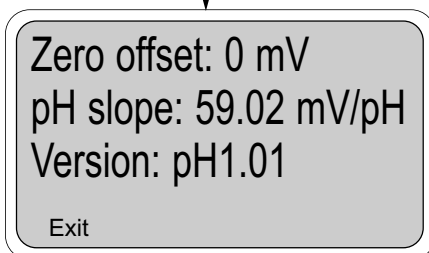

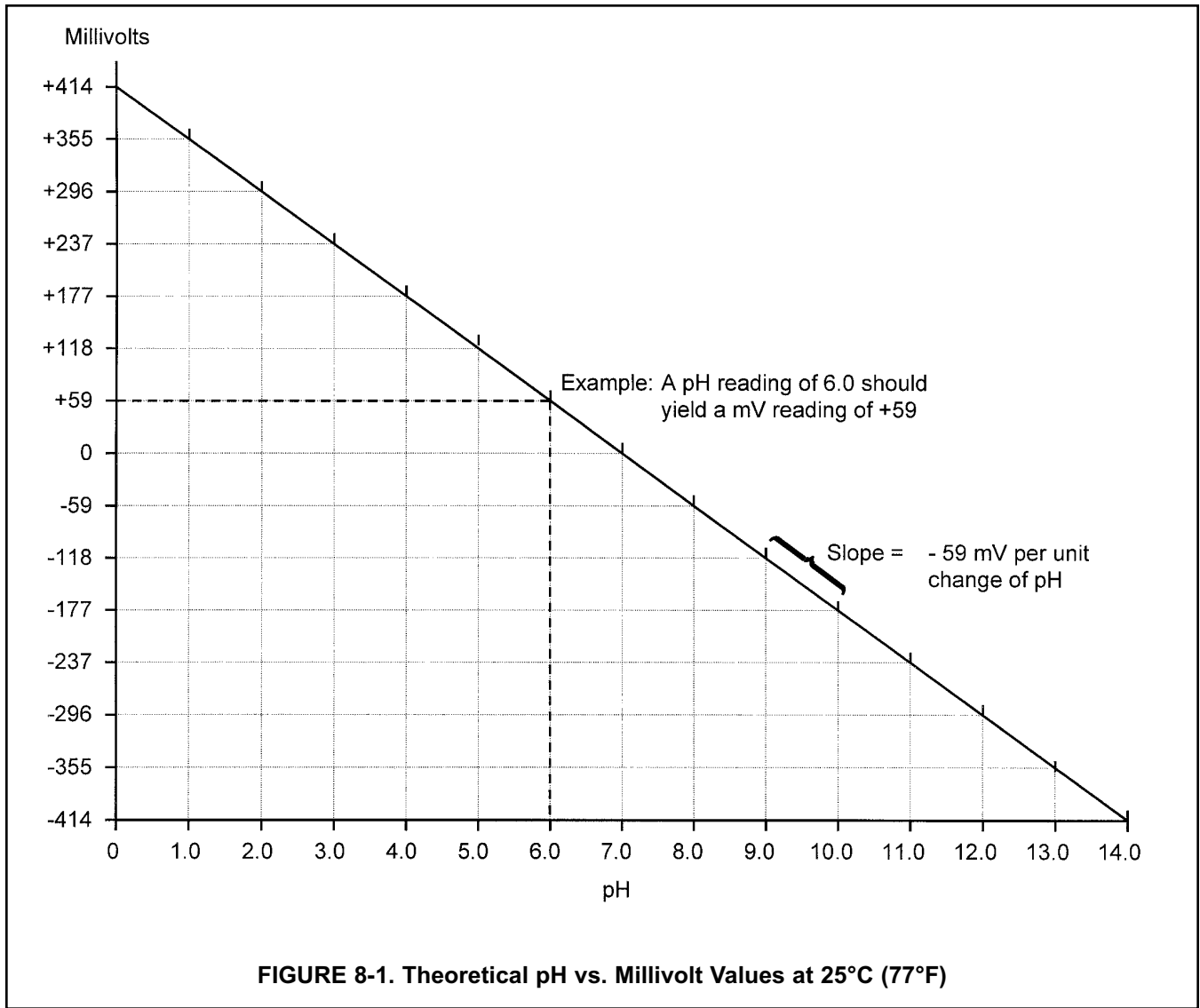

## 8.2 TROUBLESHOOTING GUIDELINES

### NOTE

To clear any Fault message, press the **F2** key.

If no specific error message is being displayed, the following procedure can identify the specific problem.

The only sure way to diagnose sensor related conditions is to isolate the pH sensor from the process, immerse the sensor in a pH buffer solution, and observe the controller response.

For any given pH value, the millivolt reading at the controller should be approximately that shown in Figure 8-1, Theoretical pH vs. Millivolt Values.

Therefore, one way to check the controller is to see if the incoming millivolt signal corresponds to the process pH or the pH of a test buffer solution (see Figure 8-1). The displayed pH value can be changed by standardizing, but the millivolt value (displayed under "Diagnostic variables", see Section 8.1) will always be the exact incoming value. Another good check of the controller is to check the slope obtained after performing the two-point calibration with two different buffer solutions, as described in Section 3.

If the controller reads correctly when the sensor is removed from the process and isolated in a container of buffer solution, then the sensor and controller are most likely functioning correctly. The problem is caused by something in the process such as:

- Sensor "seeing" poorly mixed, non-homogeneous solution.
- Sensor located too close to chemical feed lines or heat sources.
- Air bubbles entrained in the process or entrapped around the sensor.
- Voltage on the process due to static electricity buildup, improperly grounded recirculation pump motors, or some other electrical source.
- A ground loop caused by improper sensor wiring, as outlined in Installation, Section 2.
- A source of electrical noise which only takes effect when the sensor is immersed in the process.

Most of these problems can be eliminated by either moving the sensor or providing proper grounding.

### TEMPERATURE COMPENSATION CIRCUIT

#### Troubleshooting Procedure

Use this procedure to diagnose problems in the temperature compensation circuit or as directed by the Troubleshooting Guide, Table 8-3. Refer to the appropriate wiring diagram in Section 3.

To check the sensor:

1. Check the resistance of the RTD element at the end of the sensor lead. Do not include interconnecting wire. Disconnect the red lead and white lead on the end of the sensor cable.
2. Check the resistance between the red and the white leads. If values do not agree within  $\pm 1\%$  of those shown below, replace the sensor (see Step 4).

OHMS	AMBIENT TEMPERATURE
100.00	32°F/0°C
107.79	68°F/20°C
109.62	77°F/25°C
111.67	86°F/30°C
115.54	104°F/40°C
119.40	122°F/50°C

3. Disconnect sensor leads from interconnecting wire prior to measuring resistance. Values shown are only accurate when measured at the end of the cable directly attached to the sensor. Allow enough time for the temperature compensation RTD embedded in the sensor to stabilize to the surrounding temperature. Temperature coefficient = 0.215 ohms per °F.
4. If the sensor is bad, you can replace the sensor, or you can clear the fault by switching to manual temperature compensation as a short-term solution. Refer to Section 3.5 to program for manual temperature compensation. If the temperature compensator RTD in the sensor is bad, the displayed temperature will be incorrect. Using manual temperature compensation will remove all temperature related faults.

## PREAMPLIFIER TROUBLESHOOTING PROCEDURE

Use this procedure when diagnosing the circuit which carries the signal from the sensor. There are 3 separate procedures, depending on where the preamplifier is located.

### A. Preamp in a junction box (Figure 8-2)

1. Verify that the controller's preamp switch is in the sensor/J box position (see Figure 2-5).
2. Remove the cover of the junction box.
3. Disconnect the BNC adapter or remove leads from TB1-7 and TB1-10 (whichever is connected).
4. Install a jumper between 7 and 10, 3 and 4, and 7 and 8 (see Figure 8-2).
5. The controller should now read approximately 7 pH.

#### NOTE

If the controller has been calibrated with a large zero offset, the pH may not be close to 7. In this case, standardize the controller at 7. (Section 3.4).

6. If the controller does not read correctly (after standardizing, if necessary), go to step B.

### B. Controller preamp check (Figure 8-3)

1. Disconnect all sensor wiring from the controller at TB2.
2. Verify that the preamp location switch is in the analyzer position, and that temperature compensation is set to manual at 25°C or 77°F (see Section 3.5).
3. Jumper TB2-3 to TB2-4 and TB2-7 to TB2-8.
4. Jumper TB2-7 to TB2-10 to simulate 7 pH.
5. The controller should now read 7 pH (or 0 mV in ORP mode).

#### NOTE

If the controller has been calibrated with a large zero offset, the pH may not be close to 7. In this case, standardize the controller at 7. (Section 3.4).

6. If the controller does not read correctly (after standardizing, if necessary), replace the controller.
7. If a millivolt source is available, it can be connected to TB2-7 and TB2-10 to simulate pH values. Refer to Figure 8-1 for the relationship between mV and pH, sample values are +172 mV for 4 pH and -172 mV for 10 pH.

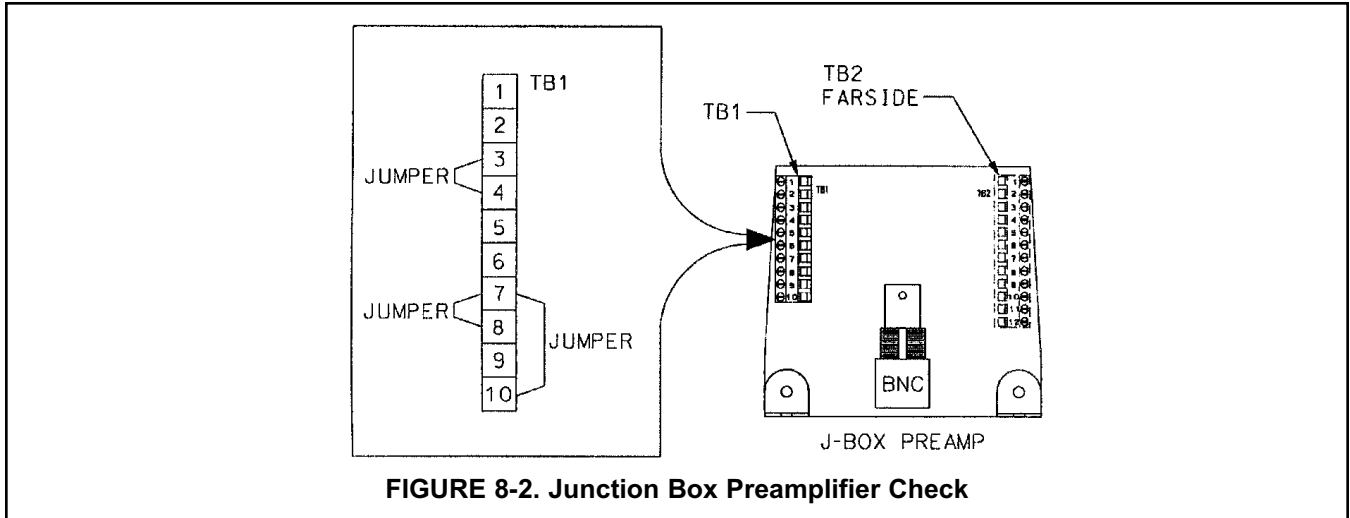

FIGURE 8-2. Junction Box Preampifier Check

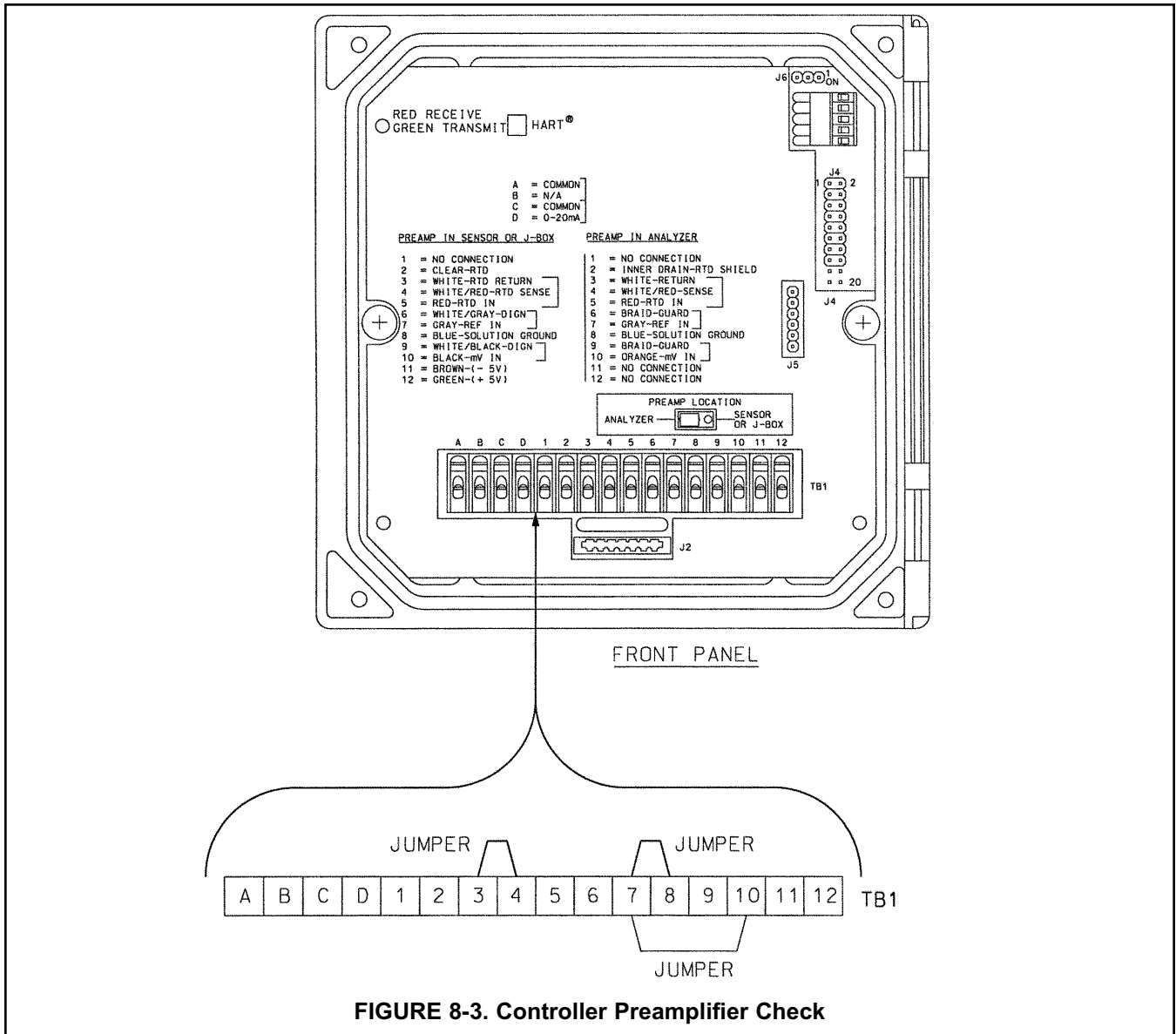

FIGURE 8-3. Controller Preampifier Check

**TABLE 8-3. Troubleshooting Guide**

PROBLEM OR CONDITION	PROBABLE CAUSE AND CORRECTIVE ACTION	FOR MORE HELP, REFER TO
Controller completely inoperative	<p><b>No Power -</b> Check power supply at breaker and inside controller: 115 V across terminals 1 and 2 on TB3.</p> <p><b>Cut-off circuit -</b> Check power supply board.</p> <p><b>Electronics Failure -</b> Replace the electronics.</p>	<p>Wiring, Section 3.0 and Figure 3-1</p> <p>Figure 3-1</p>
Controller operating, but adding chemical above setpoint, or not adding below setpoint, or not holding setpoint.	<p><b>Incorrect or Changed Settings -</b> Refer to software configuration procedure and verify that control parameters are correct and entered properly. Pay special attention to the TPC settings.</p> <p><b>Electronics Failure -</b> Try power down and power back up to reboot the program. Test alarm relays.</p> <p>Replace electronics if necessary.</p>	<p>Software Configuration, Section 5.0</p> <p>Simulated tests Section 5.4</p>
Inability to standardize pH "Zero Offset Err"	<p><b>Incorrect standardization procedure -</b> If you are trying to adjust the pH reading by a large amount, the controller may reject your standardization and will continue to display the previous value. Check that your lab instrument, titrations, or chemical standard solutions have been used properly and are correct.</p> <p><b>Sensor failure -</b> Simulate sensor in "Preamp Troubleshooting".  Replace sensor if preamp ok.</p> <p><b>Electrode coated -</b> Clean electrode as needed.</p> <p><b>(381+ Sensor) Reference chamber is contaminated -</b> Replace gel-filled solution as instructed in 381+ manual</p> <p><b>Defective preamplifier -</b> Check preamplifier as instructed in Preamp Troubleshooting procedure and replace if defective.</p> <p><b>(381+ Sensor) Bad Reference -</b> If trouble still persists, microjunction on reference electrode is defective.  Replace reference electrode.</p>	<p>Calibration, Section 4.0</p> <p>Section 8.2</p> <p>Section 8.0</p>



**TABLE 8-3. Troubleshooting Guide (continued)**

PROBLEM OR CONDITION	PROBABLE CAUSE AND CORRECTIVE ACTION	FOR MORE HELP, REFER TO
<p>Controller "short spans." Buffer check with 2-point calibration gives slope less than 47 mV/pH . "lo slope error"</p>	<p><b>Coated glass electrode -</b> Clean with soft cloth and clean water.</p> <p>Service 381+ Reference Junction and Solution.</p> <p><b>Old glass electrode -</b> If used for more than 1 yr, replace electrode.</p>	
<p>Change in pH slope (value shrinking) after 2-point calibration.</p>	<p><b>Old or coated glass electrode -</b> Clean or replace glass electrode.</p> <p><b>Bad RTD value -</b> See Temp. Comp. Troubleshooting Procedure with expected RTD value resistances at temperature values.</p>	<p>Temp.Comp. Troubleshooting Procedure, Section 8.2</p>
<p>pH value locks up (no change in buffers).</p>	<p><b>Glass electrode cracked -</b> Replace glass electrode.</p> <p><b>Coated glass electrode -</b> Clean glass electrode.</p>	
<p>Displayed pH value not the same as grab sample of process.</p>	<p><b>Grab sample incorrect -</b> Reevaluate sample technique and equipment.</p> <p><b>Unclear which is correct -</b> Retest with new buffer solution.</p> <p><b>Controller out of calibration -</b> Recalibrate per Calibration, (See Section 3.0)</p>	<p>Calibration, Section 4.0</p> <p>Calibration, Section 4.0</p> <p>Calibration, Section 4.0</p>
<p>Display reads off scale.</p>	<p><b>(381+ Sensor) Reference depleted -</b> Replace reference electrolyte as instructed in 381+ manual.</p> <p><b>Defective preamplifier -</b> Check preamplifier as instructed in Preamp Troubleshooting Procedure, and replace preamplifier, if defective.</p> <p><b>Electrode not in process solution -</b> Make sure sensor is in solution.</p> <p><b>Open circuit within glass electrode -</b> Replace glass electrode.</p> <p><b>(381+ Sensor) Plugged reference -</b> Replace reference junction. Recharge reference solution.</p>	<p>Section 8.0</p> <p>Wiring, Section 3.0</p>

Table 8-3 is continued on the following page

**TABLE 8-3. Troubleshooting Guide (continued)**

PROBLEM OR CONDITION	PROBABLE CAUSE AND CORRECTIVE ACTION	FOR MORE HELP, REFER TO
<p>Display reads between 3 and 6 pH regardless of actual pH solution or sample.</p> <p>"cracked glass failure"</p>	<p><b>Electrode cracked -</b> Replace electrode.</p>	
<p>Sluggish or slow display indication for real changes in pH level.</p>	<p><b>Electrode coated -</b> Clean electrode as instructed in sensor manual</p>	
<p>Inability to change parameters in the controller.</p> <p>"Level 1 security: Lock"</p> <p>"Level 2 security: Lock"</p> <p>"Level 3 security: Lock"</p>	<p><b>Password protected -</b> Your controller has password protection. You must enter the correct password to make changes in the controller.</p>	<p>Section 7.0</p>
<p>Outputs do not change</p> <p>"Hold Mode activated"</p> <p>"simulating output 1 or 2"</p> <p>"simulating alarm 1,2,3, or 4"</p>	<p><b>Controller is in Hold or simulate mode -</b> To remove from Hold, press any key and then press Enter (F4). Press Edit (F4), change "On" to "Off", and press Save (F4).</p> <p>To stop simulation, press Exit (F1). When the unit has been put into "Hold", all outputs go to their default states.</p>	<p>Software Configuration, Section 5.6 Calibration , Section 4.7</p>
<p>Red LED light is on</p> <p>Various fault messages shown on lower display.</p>	<p><b>Unit has gone into fault mode -</b> Read the message and take action as indicated in Table 8-2.</p>	<p>Section 8.0</p>

### 8.3 REPLACEMENT PARTS

PART NUMBER	DESCRIPTION
23540-05	Enclosure, Front with Keyboard
23848-00	Power Supply Circuit Board Shield
23849-00	Half Shield, Power Supply
23854-00	PCB, CPU for Back-lit Display
23969-00	PCB, Calibrated board set, 115/230 Vac
23969-04	PCB, Calibrated board set, 24 Vdc
33281-00	Hinge Pin
33286-00	Gasket, Front Panel
33293-00	Enclosure, Rear
9010377	Back-lit Display, LCD Dot Matrix
9510048	Enclosure Conduit Plug, 1/2 inch

**NOTE:** Individual printed circuit boards cannot be ordered for Model 54e. Replacement boards for Model 54e are assembled and calibrated as an integrated board stack.

## SECTION 9.0 RETURN OF MATERIAL

### 9.1 GENERAL.

To expedite the repair and return of instruments, proper communication between the customer and the factory is important. Before returning a product for repair, call 1-949-757-8500 for a Return Materials Authorization (RMA) number.

### 9.2 WARRANTY REPAIR.

The following is the procedure for returning instruments still under warranty:

1. Call Rosemount Analytical for authorization.
2. To verify warranty, supply the factory sales order number or the original purchase order number. In the case of individual parts or sub-assemblies, the serial number on the unit must be supplied.
3. Carefully package the materials and enclose your "Letter of Transmittal" (see Warranty). If possible, pack the materials in the same manner as they were received.
4. Send the package prepaid to:

Rosemount Analytical Inc., Uniloc Division  
Uniloc Division  
2400 Barranca Parkway  
Irvine, CA 92606

Attn: Factory Repair

RMA No. \_\_\_\_\_

Mark the package: Returned for Repair

Model No. \_\_\_\_\_

#### IMPORTANT

Please see second section of "Return of Materials Request" form. Compliance with the OSHA requirements is mandatory for the safety of all personnel. MSDS forms and a certification that the instruments have been disinfected or detoxified are required.

### 9.3 NON-WARRANTY REPAIR.

The following is the procedure for returning for repair instruments that are no longer under warranty:

1. Call Rosemount Analytical for authorization.
2. Supply the purchase order number, and make sure to provide the name and telephone number of the individual to be contacted should additional information be needed.
3. Do Steps 3 and 4 of Section 9.2.

#### NOTE

Consult the factory for additional information regarding service or repair.

# APPENDIX A

## ORP CONFIGURATION

### QUICK STARTUP (ORP)

The Model 54e pH/ORP controller comes pre-programmed by the factory as a pH controller. In order to perform a quick startup as an ORP controller, the controller must first be switched to the pre-configured ORP program. Most ORP sensors will look and connect very much like pH sensors, but will have a metal ring electrode over a glass shaft with a thick end instead of a thin pH glass membrane.

To switch to an ORP controller and perform a quick startup:

1. Connect the ORP sensor to the controller. Wire to controller per Figure 2-5 or 2-6.
2. Apply primary power (Figure 2-4) to the controller.
3. Change the controller to ORP operation. Refer to Section 5.3, or:
  - A. Press any key to display the main menu.
  - B. Move cursor until Program is highlighted.
  - C. Press Enter (F4).
  - D. Highlight "Configure" and press Enter (F4).
  - E. Highlight "Display" and press Edit (F4).
  - F. Use the arrow key to change "Measure" from pH to ORP and press Save (F4). Warning screen appears - press Cont (F3).
4. Complete the ORP standardize instructions).
5. Preset alarm and output settings are listed below: If these values are unacceptable, refer to Section A.1 for a detailed configuration procedure. For a summary of the complete factory settings see Table A-1.

Alarm 1 (low alarm):	-1400mV
Alarm 2 (high alarm):	+1400mV
Alarm 3 (high alarm):	+1400mV
Output 1 (4mA setpoint):	-1400mV
Output 1 (20mA setpoint):	+1400mV

### CONFIGURING THE CONTROLLER

Configuration of the ORP settings can be done at any time after the controller has been set to ORP mode (step 3 in Quick Startup on the left). Procedures for these operations follow the ORP Standardization instructions in this appendix.

Before attempting any changes refer to the configuration setup list shown in Table A-1. This table presents a brief description and the configurable items. The factory setting is also given with a space for the user setting. It is recommended that the list be carefully reviewed before any changes are made.

On initial configuration, it is recommended that the settings be entered in the order shown on the worksheet. This will reduce the chance of accidentally omitting a needed setting.

TABLE A-1. ORP Settings List

ITEM	CHOICES	ORP SETTINGS	USER SETTINGS	
<b>PROGRAM LEVEL (Sections A.2 - A.3)</b>				
<b>A. Alarm Setpoints (Section A.2)</b>				
1.	Alarm 1 (low action)	-1400 to +1400 mV	-1400 mV	_____
2.	Alarm 2 (high action)	-1400 to +1400 mV	+1400 mV	_____
3.	Alarm 3 (high action)	-1400 to +1400 mV	+1400 mV	_____
<b>B. Output Setpoints (Section A.3)</b>				
1.	Output 1: 4 mA	-1400 to +1400 mV	-1400 mV	_____
2.	Output 1: 20 mA	-1400 to +1400 mV	+1400 mV	_____
3.	Output 2: 4 mA	-15 to 130 °C	0.0 °C	_____
4.	Output 2: 20 mA	-15 to 130 °C	100.0 °C	_____
<b>CONFIGURE LEVEL (Sections 5.5 - 5.9)</b>				
<b>A. Display (Section 5.5)</b>				
1.	Measurement type	pH/ORP	ORP	_____
2.	Convention	ORP/Redox	ORP	_____
3.	Temperature Units	°C/°F	°C	_____
4.	Output 1 Units	mA/% of full scale	mA	_____
5.	Output 2 Units	mA/% of full scale	mA	_____
6.	Language	English/Français/Español/Deutsch/Italiano	English	_____
7.	Main display lower left	See Section 5.5	Alarm 1 Setpoint	_____
8.	Main display lower right	See Section 5.5	Alarm 2 Setpoint	_____
9.	Display contrast	0-9 (9 darkest)	5	_____
10.	Tests Timeout	On/Off	On	_____
11.	Timeout Value	1-60 min	10 min	_____
<b>B. Outputs (Section 5.6)</b>				
1.	Output 1 Control			
	(a) Output 1 Measurement	Process/Temp/Ref Imp	Process (ORP)	_____
	(b) Output 1 Control Mode	Normal/PID	Normal	_____
2.	Output 1 Setup			
	(a) Current Range	4-20 mA/0-20 mA	4-20 mA	_____
	(b) Dampening	0-299 Sec	0 Sec	_____
	(c) Hold Mode	Last value/Fixed value	Last value	_____
	(d) Fixed Hold Value (if (c) Fixed)	0-22 mA	21 mA	_____
	(e) Fault Value	0-22 mA	22 mA	_____
3.	Output 2 Control			
	(a) Output 2 Measurement	Process/Temp /Ref Imp	Temperature	_____
	(b) Output 2 Control Mode	Normal/PID	Normal	_____
4.	Output 2 Setup			
	(a) Current Range	4-20 mA/0-20 mA	4-20 mA	_____
	(b) Dampening	0-255 Sec	0 Sec	_____
	(c) Hold Mode	Last value/Fixed value	Last value	_____
	(d) Fixed Hold Value (if (c) Fixed)	0-22 mA	21 mA	_____
	(e) Fault Value	0-22 mA	22 mA	_____
5.	Hold (Outputs and Relays)	Disable/Enable/ 20 min timeout	Disable feature	_____
<b>C. Alarms (Section 5.7)</b>				
1.	Alarm 1 Control			
	(a) Activation Method	Process/Temp	Process(ORP)	_____
	(b) Alarm 1 Control Mode	Normal/TPC	Normal	_____

Continued on the following page.

TABLE A-1. ORP Settings List

ITEM	CHOICES	ORP SETTINGS	USER SETTINGS
2. Alarm 1 Setup			
(a) Configuration	Low alarm/High alarm/Off	Low	_____
(b) Hysteresis (deadband)	0-500 mV	0 mV	_____
(c) Delay Time	0-99 sec	0 sec	_____
(d) Relay Default	Open/Closed/None	None	_____
3. Alarm 2 Control			
(a) Activation Method	Process/Temp	Process(ORP)	_____
(b) Alarm 2 Control Mode	Normal/TPC	Normal	_____
4. Alarm 2 Setup			
(a) Configuration	Low alarm/High alarm/Off	High	_____
(b) Hysteresis (deadband)	0-500 mV	0 mV	_____
(c) Delay Time	0-99 sec	0 sec	_____
(d) Relay Default	Open/Closed/None	None	_____
5. Alarm 3 Control			
(a) Activation Method	Process/Temp	Process(ORP)	_____
(b) Alarm 3 Control Mode	Normal/TPC	Normal	_____
6. Alarm 3 Setup			
(a) Configuration	Low alarm/High alarm/Off	High	_____
(b) Hysteresis (deadband)	0-500 mV	0 mV	_____
(c) Delay Time	0-99 sec	0 sec	_____
(d) Relay Default	Open/Closed/None	None	_____
7. Alarm 4 Control			
(a) Alarm	Fault/Off	Fault	_____
8. Feed Limit Timer			
(a) Feed Limit	Disable/alarm 1/alarm 2/alarm 3	Disable	_____
(b) Timeout Value	0-10,800 sec	3600 sec	_____
9. Interval Timer			
(a) Timer (selection)	Disable/alarm 1/alarm 2/alarm 3	Disable	_____
(b) Timer (activation method)	Time activated/Imped.activated	Time activated	_____
(c) Interval	0-999.9 hr	24.0 hr	_____
(d) Repeats	1-60	1	_____
(e) On Time	0-2999 sec	120 sec	_____
(f) Off Time	0-2999 sec	1 sec	_____
(g) Recovery	0-999 sec	600 sec	_____
<b>D. Diagnostics (Section 5.8)</b>			
1. Diagnostics (Glass and Reference)	On/Off	Off	_____
4. Ref(erence) Imp(edance) High	0-140 KOhms (0 disables)	140 KOhms	_____
5. Zero Offset	0-999 mV (0 disables)	60 mV	_____
<b>E. Security (Section 7)</b>			
1. Lock all	000-999	000 (no security)	_____
2. Lock Program (Lock all except Calibrate)	000-999	000 (no security)	_____
3. Lock Config. (Lock all except Calibrate, Alarm Setpoints and Rerange Outputs)	000-999	000 (no security)	_____

**Accessing Calibrate, Program and Configure Menus.** Operating configuration changes are made at the levels shown in Figure A-1. Press any key from the main display to access the main menu (top left). Refer to Section 5 for pH measurements.

**Level 1 Calibrate.** To access calibration selections from the main menu, with the cursor on "Calibrate" press Enter (F4). ORP standardization and temperature adjustments are made at this level (refer to Section A.1 and Section 3.1 for these procedures).

**Level 2 Program.** To access the program level from the main menu, place the cursor over "Program" with the down arrow key. Then press Enter (F4). From the program level menu, changes can be made to the alarm setpoints and the output setpoints.

**Level 3 Configure.** To access the configure level from the main menu place cursor over "Program" and Enter (F4) then place cursor over "Configure" and Enter (F4). This level contains advanced selections, such as alarms and diagnostics.

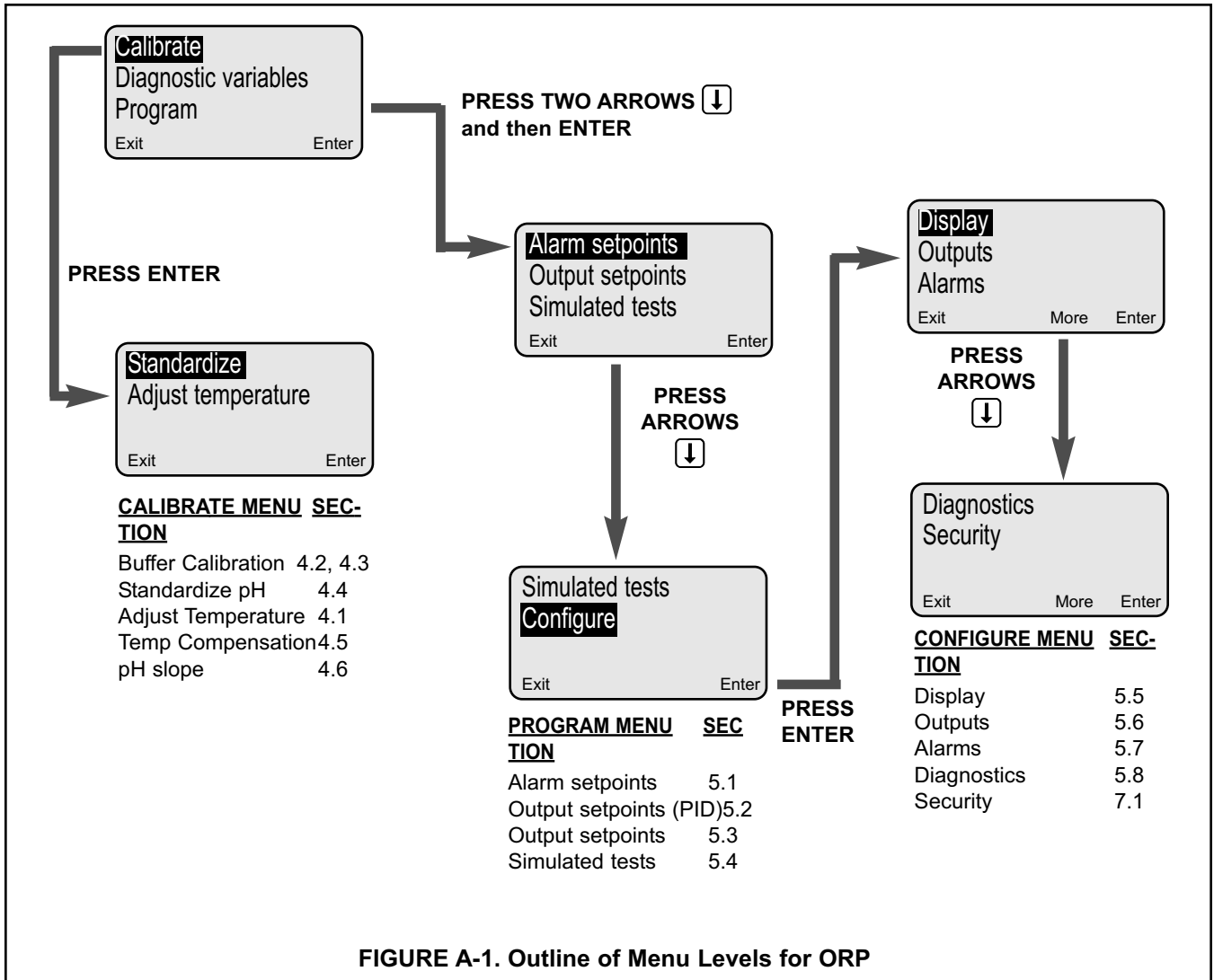



## A.1 ORP CALIBRATION

ORP Calibration consists of a single standardize adjustment that changes the zero offset of the controller. This procedure can be done with the ORP sensor in an ORP standard solution or with the sensor left in the process and a laboratory analysis of a grab sample.

1. From the main display, press any key to obtain the main menu. With the cursor on "Calibrate", press Enter (F4).

**NOTE**

The Hold Mode screen may appear at this time if the feature was enabled in Section 5.6. Changing the Hold Mode to ON holds the outputs in a fixed state, and avoids process upsets during calibration. If you don't want to engage Hold, simply press F3 (Cont). Otherwise, press F4 (Edit), and change the Hold Mode to On before continuing.

Skip to step 4 if using an ORP standard solution.

2. Take a grab sample that is as close to the sensor as possible.
3. Using a calibrated ORP instrument, determine the ORP of the process or grab sample.
4. Move the cursor to "Standardize" and press Enter (F4).

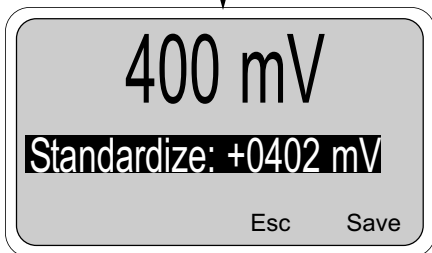
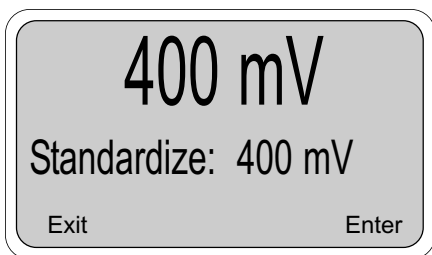
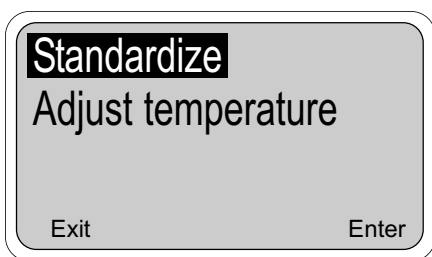

5. The number on the large display is the live process ORP reading. The next line displays the ORP reading when the display was accessed. Press Edit (F4) to perform the standardize.

Use the arrow (↓) key to change the reading to the desired value and then press Save (F4) to complete the procedure. Esc (F3) will cancel.

**NOTE**

The + sign can be changed to a - sign after the numerical portion of the number has been entered by highlighting the + and pressing the down arrow key.

Before exiting the calibration mode, remember to change the hold mode setting to OFF (if it was turned on in step 3).



## WARRANTY

Seller warrants that the firmware will execute the programming instructions provided by Seller, and that the Goods manufactured or Services provided by Seller will be free from defects in materials or workmanship under normal use and care until the expiration of the applicable warranty period. Goods are warranted for twelve (12) months from the date of initial installation or eighteen (18) months from the date of shipment by Seller, whichever period expires first. **Consumables, such as glass electrodes, membranes, liquid junctions, electrolyte, o-rings, catalytic beads, etc., and Services are warranted for a period of 90 days from the date of shipment or provision.**

Products purchased by Seller from a third party for resale to Buyer ("Resale Products") shall carry only the warranty extended by the original manufacturer. Buyer agrees that Seller has no liability for Resale Products beyond making a reasonable commercial effort to arrange for procurement and shipping of the Resale Products.

If Buyer discovers any warranty defects and notifies Seller thereof in writing during the applicable warranty period, Seller shall, at its option, promptly correct any errors that are found by Seller in the firmware or Services, or repair or replace F.O.B. point of manufacture that portion of the Goods or firmware found by Seller to be defective, or refund the purchase price of the defective portion of the Goods/Services.

All replacements or repairs necessitated by inadequate maintenance, normal wear and usage, unsuitable power sources, unsuitable environmental conditions, accident, misuse, improper installation, modification, repair, storage or handling, or any other cause not the fault of Seller are not covered by this limited warranty, and shall be at Buyer's expense. Seller shall not be obligated to pay any costs or charges incurred by Buyer or any other party except as may be agreed upon in writing in advance by an authorized Seller representative. All costs of dismantling, reinstallation and freight and the time and expenses of Seller's personnel for site travel and diagnosis under this warranty clause shall be borne by Buyer unless accepted in writing by Seller.

Goods repaired and parts replaced during the warranty period shall be in warranty for the remainder of the original warranty period or ninety (90) days, whichever is longer. This limited warranty is the only warranty made by Seller and can be amended only in a writing signed by an authorized representative of Seller. Except as otherwise expressly provided in the Agreement, THERE ARE NO REPRESENTATIONS OR WARRANTIES OF ANY KIND, EXPRESS OR IMPLIED, AS TO MERCHANTABILITY, FITNESS FOR PARTICULAR PURPOSE, OR ANY OTHER MATTER WITH RESPECT TO ANY OF THE GOODS OR SERVICES.

## RETURN OF MATERIAL

Material returned for repair, whether in or out of warranty, should be shipped prepaid to:

**Emerson Process Management  
Liquid Division  
2400 Barranca Parkway  
Irvine, CA 92606**

The shipping container should be marked:

Return for Repair

Model \_\_\_\_\_

The returned material should be accompanied by a letter of transmittal which should include the following information (make a copy of the "Return of Materials Request" found on the last page of the Manual and provide the following thereon):

1. Location type of service, and length of time of service of the device.
2. Description of the faulty operation of the device and the circumstances of the failure.
3. Name and telephone number of the person to contact if there are questions about the returned material.
4. Statement as to whether warranty or non-warranty service is requested.
5. Complete shipping instructions for return of the material.

Adherence to these procedures will expedite handling of the returned material and will prevent unnecessary additional charges for inspection and testing to determine the problem with the device.

If the material is returned for out-of-warranty repairs, a purchase order for repairs should be enclosed.



*The right people,  
the right answers,  
right now.*

ROSEMOUNT ANALYTICAL  
CUSTOMER SUPPORT CENTER  
1-800-854-8257



**Emerson Process Management**

**Liquid Division**

2400 Barranca Parkway  
Irvine, CA 92606 USA  
Tel: (949) 757-8500  
Fax: (949) 474-7250

<http://www.raihome.com>



ON-LINE ORDERING NOW AVAILABLE ON OUR WEB SITE  
<http://www.raihome.com>

*Specifications subject to change without notice.*

Credit Cards for U.S. Purchases Only.

