



**Electro-Voice®**

**EX-18 ELECTRONIC CROSSOVER**

**OWNER'S MANUAL**

**MASTER COPY**

## EV/TAPCO TWO-WAY/THREE-WAY ELECTRONIC CROSSOVER

DESCRIPTION: The TAPCO EX18 is a two-way , two channel or three-way single channel electronic crossover. It has been designed with the user in mind. Making the unit simple and easy to operate was a major design goal. To this end, the EX18 provides the necessary controls and functions for bi or tri-amplifying most speaker systems. The crossover frequency is continuously adjustable from 100hz to 16khz in two ranges and level controls are provided. The crossover slope is 18dB/octave. The high frequency output of each channel has a phase invert switch to facilitate setup and operation of any system. The mode switch allows easy conversion from two-way to three-way operation. The entire front panel is recessed to prevent accidental operation of any of the controls. A security cover is included with the unit. The EX18 is rack mountable and requires one unit (1.75 ins) of rack space.

### FEATURES

- \*\*\* STEREO/TWO CHANNEL BIAMP OR MONO/SINGLE CHANNEL TRIAMP OPERATION
- \*\*\* MODE SWITCH FOR INSTANT TWO WAY/THREE WAY CONVERSION
- \*\*\* CONTINUOUSLY VARIABLE CROSSOVER FREQUENCY--100 HZ TO 16 KHZ IN TWO RANGES
- \*\*\* 18dB/octave SLOPE--FEWER PHASE PROBLEMS--BETTER DRIVER PROTECTION
- \*\*\* HIGH FREQUENCY PHASE REVERSE SWITCH
- \*\*\* LEVEL CONTROLS
- \*\*\* COLOR CODED GRAPHICS
- \*\*\* BALANCED INPUT--ACCEPTS EITHER BALANCED OR UNBALANCED SOURCES.
- \*\*\* LOW IMPEDANCE UNBALANCED OUTPUTS--CAPABLE OF DRIVING LONG LINES
- \*\*\* +22dBu OUTPUT LEVEL--DRIVES ANY POWER AMP
- \*\*\* SPACE SAVER--1.75 INCH RACK HEIGHT
- \*\*\* SECURITY COVER--PROTECT CONTROL SETTINGS



## OPERATION

### 2 WAY/3 WAY SWITCH

This switch allows the EX18 to operate in a true two or three-way mode. In either case all controls perform only the actual function indicated. In two-way mode, each channel functions independently and may be used for completely different uses. For instance: house (mains) and monitors, two different monitor sends or of course, stereo. In two-way mode, use the white colored graphics. In three-way mode, the two channels are placed in series to form a mono (single channel) three-way crossover. No external patching (other than inputs and outputs) is required. When using the EX18 in three-way mode use the gold colored graphics.

### FREQUENCY KNOB

The frequency knob adjusts the crossover frequency. This is the point at which both crossover outputs are 3dB down from their passband levels, the frequency range where the crossover outputs are flat. The crossover frequency may be adjusted anywhere between 100hz and 1600hz. If the range switch is depressed the frequency range is now 1khz to 16khz (1000hz to 16,000hz). In the two-way mode, each frequency knob is independent of the other. In the three-way mode, the left hand knob adjusts the low frequency to midrange transition (crossover frequency) and the right hand knob adjusts the midrange to hi frequency transition.

### RANGE SWITCH

The range switches shifts the range of each respective frequency knob by a factor of 10. That is, the front panel marking is multiplied by ten. With the switch depressed, the range of the crossover frequency knob is now 1000 to 16,000 hz (1k to 16khz). This allows the selection of crossover points desired in some three-way systems and smaller two-way systems.

### LEVEL CONTROLS

In two-way mode the two level controls set the output level of the high frequency outputs. They should be set for the most pleasing hi frequency balance. In three-way operation, the left hand knob adjusts only the midrange speakers and the right hand knob adjusts the high frequency speakers. Again, they should be set for the most pleasing musical balance. In both cases this should be done with other system equalization (input channel or graphic) set at flat. Note that the 2way/3way switch allows independent control of midrange and tweeter in the three-way mode. (figure 4, page 6)

#### POLARITY SWITCH

Each polarity switch reverses the polarity of its respective output. For two-way operation this would be the high frequency outputs, and for three-way operation, both the midrange and high frequency outputs. Operating the polarity switch is similar to reversing the red and black wires at the loudspeaker terminals. The polarity switch allows you to make an instant determination of your system's phasing. The normal setting of the polarity switch is the button out position. (woofers and tweeters out of phase) This results in the flattest frequency response for most speaker systems.

#### CONNECTIONS

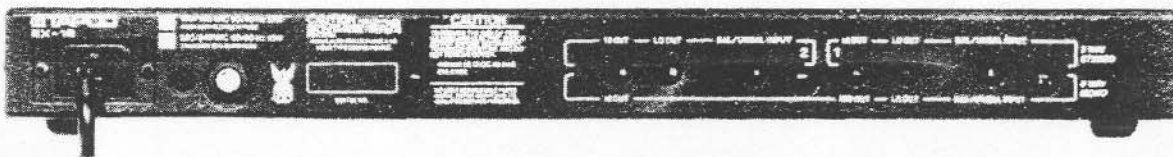

#### AC POWER

AC requirements are: 115 VAC, 50/60hz, 5W. If operation with a 2 wire outlet is required, a grounding adaptor is recommended with the green wire tied to a good earth ground.

It is important to obtain AC power for any remote equipment (like a console operated away from the rest of the equipment) from the same power outlet (or at least one on the SAME ground circuit) as the one that supplies your power amplifiers. Doing this will insure the lowest ground loop noise. DON'T use the outlet that may be located near the console location.

#### FUSE

The EX18 requires a 4/100A slo blow fuse, type 3AG 4/100 or equivalent. If replacing the fuse does not correct the problem, refer the unit to an authorized service center or to TAPCO.

## INPUT

The EX18 has a balanced input using a 3 circuit 1/4" phone (tip/ring/sleeve) jack, and will accept any source, balanced or unbalanced, high or low impedance. Refer to figure 1 for possible connection schemes. Unbalanced sources may be connected directly by inserting a 2 circuit (tip/sleeve) plug into the input jack (figure 1A). Under certain grounding conditions, the connection recommended in figure 1B may result in lower ground hum levels. In most circumstances, connection per figure 1A will be adequate.

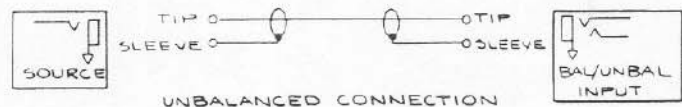

FIG. 1A

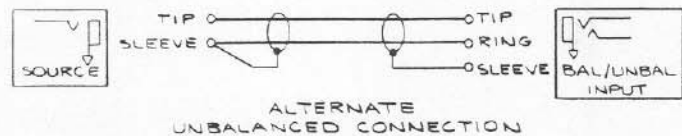

FIG. 1B

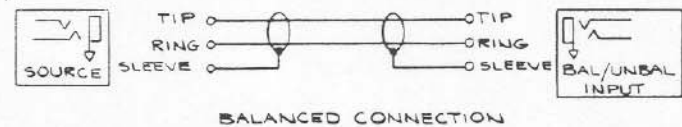

FIG. 1C

Balanced sources may also be connected directly. Use a tip/ring/sleeve plug. The tip connection is hi, ring is lo and sleeve is chassis ground. This connection is diagrammed in figure 1C.

## OUTPUTS

The EX18 outputs are all unbalanced. The output source impedance is low (<600 ohms) and can drive long lines and power amplifiers directly. The maximum output level is +22dBu (10V rms) and can drive most power amps directly. The low source impedance insures good high frequency response, even with long lines. Multiple power amplifiers may be driven by paralleling their inputs. The TAPCO amplifiers facilitate this by having looping (paralleled) input jacks on each input.

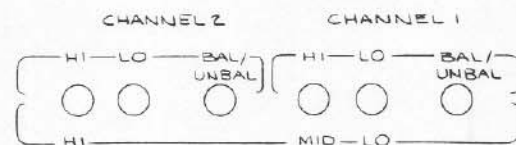

FIG. 2

In systems with the crossover mounted at the console (mixer) location, it is important that the remote console equipment share the same ground as the power amplifiers. Generally, this means using the same power outlet.



## APPLICATIONS

For most sound system applications, bi or tri amplification can provide a significant performance advantage over conventional passive crossovers. A biamplified system uses a separate power amplifier for each speaker (woofer and tweeter) in the system. Likewise, the triamplified system would require three amplifiers. The crossover is placed before the amplifiers and after the mixer, preamp or equalizer. Thus, each amplifier need only handle the frequency range of its respective speaker(s). This arrangement allows each speaker(s) to be driven by an amplifier that exactly suits the needs of that particular speaker. For a low frequency speaker, this means having enough power to insure adequate low frequency headroom. The absence of the passive crossover eliminates the crossover network unit's insertion loss and improves the damping factor seen by the woofer. This improves low frequency performance by allowing the amplifier to control the woofers cone movement more precisely.

Most high frequency loudspeakers are about 10dB higher in efficiency than most low frequency speakers. This means that for the same acoustical output level, the power requirements are about 10 to 1. Put into plain numbers: if the tweeters require 10 watts for a given sound pressure level, the woofers will require 10 times more for the same level (100 watts). Because of the limited power of the high frequency amplifier, it is much less likely to damage (blow up) the tweeters during an oops condition (dropped mike, loud feedback, etc.).

Musical signals demand the largest amount of power at low frequencies. This is compounded by the lower efficiency of most woofers. A passively crossed over system requires tremendous amounts of power to accurately reproduce musical transients at real-life (live performance) levels. In this system, when the power amplifier clips, the only thing the loudspeaker system can do is to try to reproduce it. During the instant that the amplifier is clipped, all other signals going through it are also clipped. This means all high frequency signals are lost. The clipping is heard as harsh distortion and is especially hard on the tweeters which are ill equipped to handle the drastically changed energy content. This is probably the number one cause of tweeter burn out.

In a biamplified system, when a large low frequency transient clips the low frequency amplifier, the accompanying high frequencies are not clipped because they have their own amplifier. The low frequency clipping is reproduced by the low frequency speaker, but is drowned out by the clean highs coming out of the tweeter. The net result is that the system will sound cleaner, longer.

## HIGH FREQUENCY DRIVER PROTECTION

In any bi, tri or multi-amp system, it is especially important to provide low frequency rolloff for the high frequency speakers. This protection can take the form of a series capacitor. The rolloff should occur at about 1 octave below the crossover point. This will help protect the driver from DC should the amplifier short out, or from low frequency energy when the high and low frequency sends get mixed up.

The formula to use is:  $C=1E6/(3.14FZ)$

where  $1E6=1,000,000$

F=the crossover frequency in HZ

Z=the speaker impedance in ohms

C=the capacitor value in microfarads (mfd)

Use (in order of preference) mylar or film, non polar electrolytic or series connected (plus to plus, 2X the calculated value) polar electrolytic capacitors with at least a 50V rating.

For the commonly used 16 ohm drivers: 500 hz=40mfd, 800hz=24mfd, 1000hz=20mfd.

8 ohm drivers will require twice the capacitance. 500 hz=80mfd.

## SETUP AND OPERATION

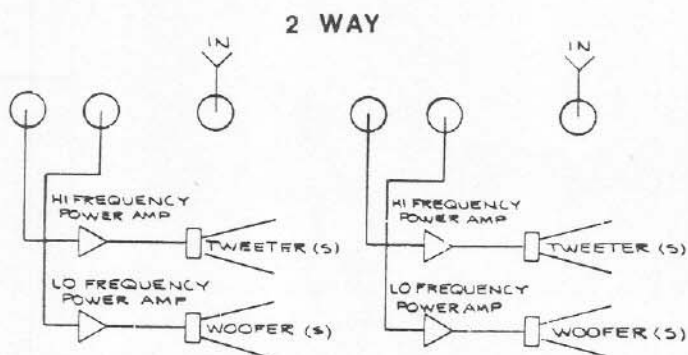

FIG. 3

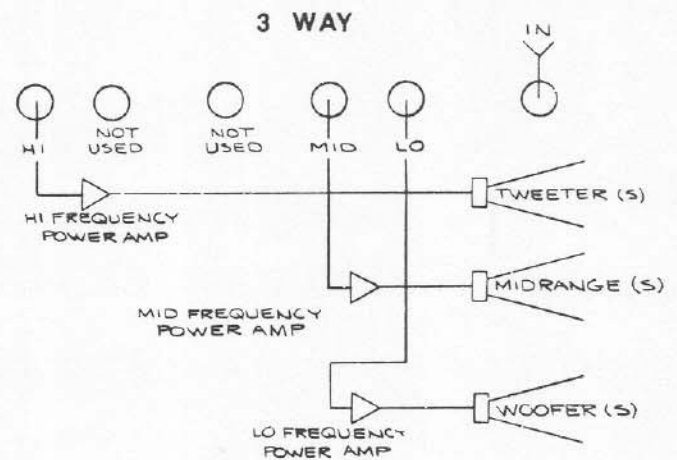

FIG. 4

1. Refer to figures 2,3 and 4 for wiring connections.
2. Set all power amplifier volume controls to minimum or off.
3. Select proper mode and crossover frequency for your system. Consult the loudspeaker manufacturer for choice of crossover frequency.
4. Check, double check and triple check the loudspeaker connections. Make sure that the high frequency amplifier actually feeds the high frequency speakers and that the low frequency amplifier actually feeds the low frequency loudspeakers. Be certain, a mixup here spells certain disaster. (Blown up loudspeakers!)

5. Turn on crossover, mixer(s) and signal processing equipment. Set any overall system equalization (graphic, parametric or other) to flat.
6. Now turn on power amps. Insure that the low frequency amplifier level control (if any) is set to 0 and that the high and/or mid amplifiers have their level controls (if any) set to maximum.
7. Feed a signal into the crossover input. Slowly advance the high frequency level control. Check to be sure that the sound you hear is actually coming from the high frequency speakers. Return the control to off.
8. Now turn the low frequency power amplifier on or up. Feed a signal into the crossover input. Use a low level. Be sure that the low frequency speakers are actually working and that no sound emerges from the high frequency speakers. The level control on the low frequency amplifier should be set to maximum.
9. Now bring up the high frequency level control until a pleasing, musical balance is heard.
10. Three-way systems: Repeat step 7 for the midrange speakers. Its really important that the woofers only woof, tweeters only tweet and midranges only mid. Its expensive when they don't.
11. Enjoy!

#### TURN OFF PROCEEDURE

1. Turn off power amps.
2. Wait 1 minute or until the system will no longer produce sound.
3. Turn off all other equipment.

#### IN CASE OF DIFFICULTY

1. Check power connections. Is the power LED on? Is the unit switched on?
2. Check fuse if power LED is out and unit is switched on.
3. Check all audio connections. Are all the cables OK? 95% of all system problems are bad cables.
4. Check control settings. Are the appropriate level controls turned up? Are the power amplifiers turned on and level controls (if any) turned up?
5. Verify that there is audio signal at the input to the crossover by plugging that cable directly into the low frequency power amplifier. Check the high frequency amplifier by temporarily patching the high freq. amplifier into the woofers and then patching the crossover input signal into the high frequency power amp.  
DO NOT DO THIS WITH THE HIGH FREQUENCY SPEAKERS CONNECTED!!!  
Remember to repatch the woofers and tweeters when you are finished..



6. When all else fails, take the EX18 to an authorized TAPCO service center or contact the factory. Be prepared to supply the serial number of your unit.

\*\*\*\* CAUTION \*\*\*\*

NO USER SERVICEABLE PARTS INSIDE. CAUTION--HIGH VOLTAGE PRESENT INSIDE CASE. REFER ALL SERVICING TO QUALIFIED SERVICE PERSONNEL.

7. For further applications assistance, write or call the factory. If you write, include your phone number and a time when you can be reached at that number.

#### SPECIFICATIONS

FREQUENCY RESPONSE: 20HZ TO 20KHZ  $\pm$  .5dB (SUM OF OUTPUTS)  
OUTPUT NOISE: -92dBv TYPICAL  
HARMONIC DISTORTION: <.05% TYPICAL (1kHz, 10k load)  
IM DISTORTION: <.05% TYPICAL (SMPTE METHOD)  
MAXIMUM INPUT: +20dBV  
MAXIMUM OUTPUT: +22dBV  
INPUT IMPEDANCE: 15K UNBALANCED, 30K BALANCED  
OUTPUT SOURCE Z: 470 OHMS, ALL OUTPUTS  
OUTPUT LOAD Z: 600 OHMS OR GREATER  
CMRR: 40dB MINIMUM  
GAIN: OVERALL UNITY  
FILTER TYPE: MAXIMALLY FLAT BUTTERWORTH  
SLOPE: 18DB/OCTAVE  
CONFIGURATION: 3 POLE STATE VARIABLE  
FREQUENCY RANGE: 100 TO 16,000 HZ IN 2 RANGES  
SIZE (HWD): 1.75 X 19 X 5 (INCHES)  
WEIGHT: 4 LBS  
POWER REQUIREMENTS: 115 VAC 50/60 HZ, 5W.  
FUSE: TYPE 3AG SLO BLO, 4/100A

## TAPCO BIBLIOGRAPHY

### BOOKS

1. THE PA BIBLE available from Electro Voice, 600 Cecil St., Buchanan MI 49107, ATTN: PA BIBLE. \$2 gets you Vol 1 and all subsequent chapters.
2. THE AUDIO CYCLOPEDIA Howard Tremaine c1969 Howard W. Sams Co. Indianapolis IN.
3. ACOUSTIC TECHNIQUES FOR HOME AND STUDIO F. Alton Everest c1973 Tab Books #646, Blue Ridge Summit PA 17214
4. SOUND REINFORCEMENT an anthology of articles from the Journal of the Audio Engineering society. c1978 Audio Engineering Society Inc.
5. SOUND SYSTEM DESIGN Don and Carolyn Davis c1975 Howard W. Sams Co. Indianapolis IN.

### MAGAZINES

1. RECORDING ENGINEER/PRODUCER published bi-monthly (6 iss/yr) by Gallay Communications Inc. POB 2449 Hollywood CA 90028. \$10/yr.
2. STUDIO SOUND monthly, subscription department, Link House, 25 West St., Poole, Dorset BH15 1LL, Great Britain. Sent free to qualified readers.
3. MODERN RECORDING AND MUSIC monthly, Cowan Publishing, 14 Vanderventer Ave, Port Washington NY 11050. \$12/yr
4. SOUND ARTS Sound Arts Merchandising Inc, 220 Westbury Ave. Carle Place, NY 11514.
5. JOURNAL OF THE AUDIO ENGINEERING SOCIETY (JAES) monthly except Jan/Feb and Jul/Aug. Free to members of any grade, \$45 to nonmembers.  
State of the Art papers on all phases of audio engineering. Papers are written by professionals in audio engineering and are usually presented at one of the society's 3 yearly conventions (February-Europe, May-Los Angeles, November-New York). Highly technical, written at engineering level (don't spare the math).

Membership in the society is open to anyone with an interest in audio engineering. There are 3 membership grades; Member, Associate and Student. Dues vary with membership grade. A subscription to the Journal is part of the yearly dues. Contact: Audio Engineering Society, Lincoln Building, 60 E 42nd St, New York NY 10165. (212) 661 2355

6. dB the SOUND ENGINEERING MAGAZINE monthly, \$9/yr. Sagamore Publishing Co.

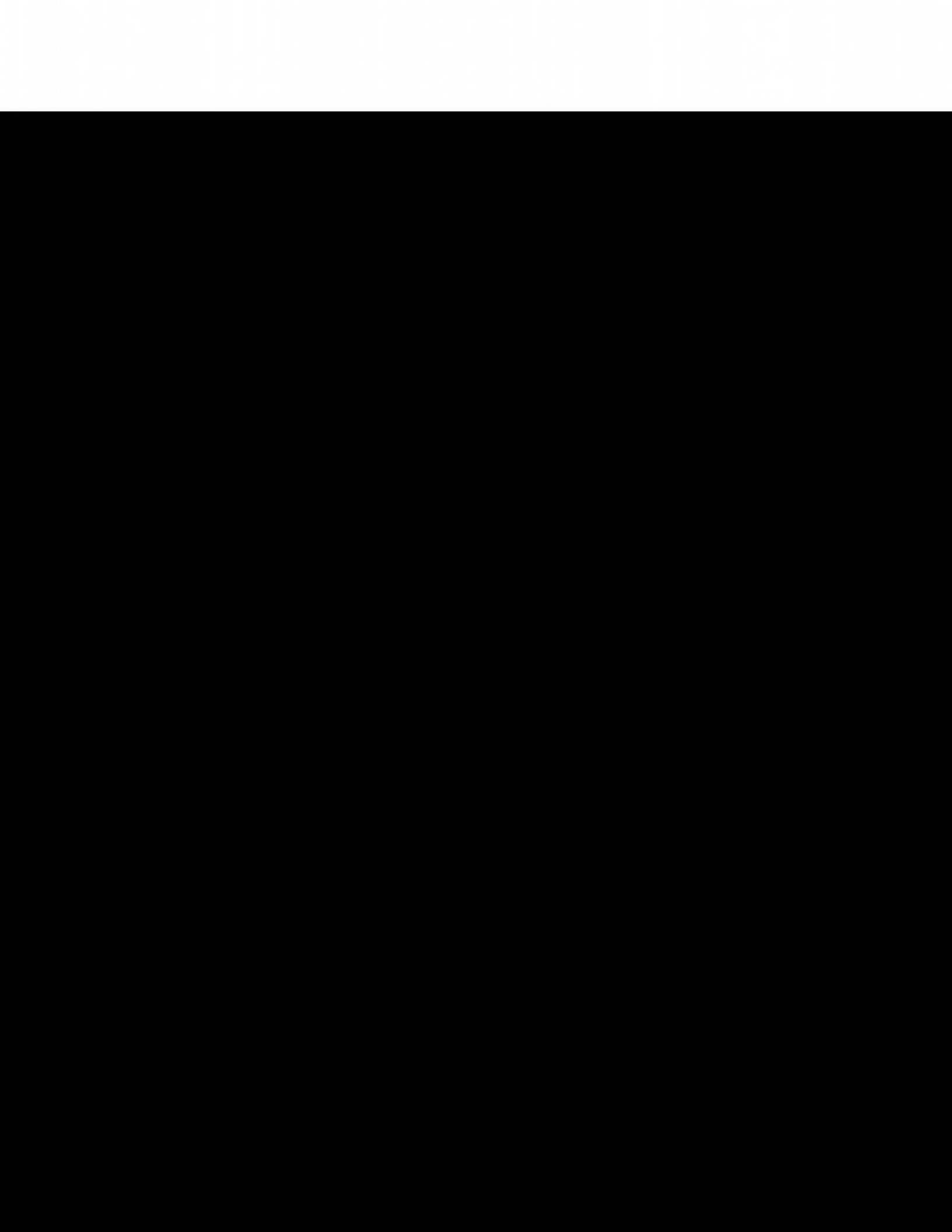

NOTES:

- 1. ALL RESISTANCE IN OHMS, %W, 5% UNLESS OTHERWISE SPECIFIED.
- 2. NOT USED: R17
- 3. LAST USED: R57, C43, U6, D6, D51

