

2019 PARTS & ACCESSORIES For Indian Motorcycles

Indian® is a registered trademark of Indian Motorcycle International, LLC



DRAG
Specialties

PARTS
UNLIMITED®

A Kolor-ful Ride

There is a cruise missile loose in the Midwest, the 2019 Indian catalog cover bike! A one-of-a-kind custom owned by a legend in the industry: House of Kolor founder Jon Kosmoski.

He purchased the bike – a holdover at the end of the 2016 season - off the show floor . Then he went right to work making it his own. With some help from the factory and the aftermarket industry, the bike got a host of upgrades including Stage II cams, Tour Pack, heated grips and heated seat, pegs, lights and more.

The real showstopper though is the paintwork. More than 40 hours of work resulted in a true eye-popping final design. The bike's seams are a zinc silver flake. The two primary colors used are titled purple haze and taco teal – two colors that are not available over the counter. Kosmoski developed the colors, but they were not chosen to be put into production.

The airbrush work on the tank and fairing lowers was handled by artist Jeff Urman. The tomahawk design on the lowers was specifically designed to angle back for a nonaggressive look.

Kosmoski is very pleased with the results, and reports the engine mods make the bike a real treat to ride. And it is not just a display piece; he rides it on a regular basis. “You have to use the bike, enjoy it,” Kosmoski says. “That is what motorcycles are for.”



TABLE OF CONTENTS

WINDSHIELDS & FAIRINGS	5-21	TRANSMISSION & DRIVELINE.	68-70
AUDIO, COMMUNICATION & MOUNTS	22-41	GASKETS & SEALS	N/A
SADDLEBAGS & LUGGAGE.	42-45	ELECTRICAL.	71-74
SEATS & SISSY BARS	46-52	LIGHTING.	75-83
EXHAUST.	53-61	HANDLEBARS, CONTROLS & MIRRORS	84-92
FUEL/AIR SYSTEMS	62-65	CABLES.	93-94
ENGINE	66-67	BRAKES.	95-100
		TANKS & OIL FILTERS	101
		DASHES & GAUGES.	102-103
		FRAMES & SUSPENSION	104-108
		FENDERS & LICENSE PLATE FRAMES	109-111
		FOOTRESTS & FLOORBOARDS	112-121
		WHEELS & AXLES.	122-123
		HARDWARE, COVERS & GENERAL.	124
		OEM CROSS REFERENCE.	125
		INDEX	126-130



DRAG
Specialties
PARTS
UNLIMITED®

IMPORTANT INFORMATION:

EMISSIONS AND NOISE REGULATIONS

NOTE: The California Air Resources Board (“CARB”) and/or the Environmental Protection Agency (“EPA”) do not permit the use of aftermarket emissions-related part(s) that alter the performance of OEM emissions-related devices unless CARB has issued an Executive Order, other than on racing vehicles on closed courses. Check your local laws and manufacturer’s information. More California exhaust information is available at www.arb.ca.gov/.

NOTE: Aftermarket products, including but not limited to exhausts, catalytic converters, oxygen sensors, fuel/air controller modules, air filter kits, camshafts, O₂ eliminators, and carburetors and jet kits which alter, modify, or replace emission control devices or systems of an originally compliant highway motorcycle, are not legal for sale or street use in California unless they have been issued a CARB Executive Order. Aftermarket emissions-related products which have not been issued an Executive Order or which are not aftermarket Replacement Parts, as defined in Title 13, California Code of Regulations, Section 1900(b)(2), are authorized for closed circuit race use only. Products shown may be designed, manufactured, intended and sold for closed circuit race use only, and use of the same on public roads or lands may be a violation of local, state and/or federal laws. See manufacturer’s information and state and local laws to determine what is authorized for your use on your vehicle.

The following emissions-related defined terms are used in this catalog (PARTS WITH THE FOLLOWING DESIGNATIONS IN THIS CATALOG ARE NOT ILLEGAL FOR SALE IN CALIFORNIA UNDER CARB REGULATIONS):

- **“CARB E.O.”** means the specified Executive Order issued by CARB. An Executive Order constitutes an exemption by CARB from CA Vehicle Code 27156 and 38391, for sale of the part number for the make/model/year fitment(s) specified in the Executive Order.
- **“Replacement Part”** means any aftermarket part intended to replace an original equipment emissions-related part and which is functionally identical to the original equipment part in all respects which in any way affect emissions (including durability), or a consolidated part.
- **“Qualified Manufacturer Declared Replacement Part”** means any aftermarket part intended to replace an original equipment emissions-related part and which is functionally identical to the original equipment part in all respects which in any way affect emissions (including durability), or a consolidated part that has been evaluated and declared by the manufacturer to meet this definition and carry this categorization and designation label. This manufacturer has declared in writing that it has documentation, based upon sound engineering judgment, indicating the replacement part does not reduce the effectiveness of any required emission control device and it does not cause the modified vehicle/engine/equipment to exceed applicable emissions standards for that make/model/year fitment(s) advertised.

NOTE: Products shown may not conform to federal, state or local emissions and/or noise regulations.

WARRANTY

There is no warranty on exhaust pipes and mufflers with regard to any discoloration. Discoloration (blueing) is caused by tuning characteristics, i.e., cam timing, carburetor, etc., and is not caused by defective manufacturing. See the Chemicals and Lubes section for products that will help prevent or remove blueing.

Check your applicable laws and manufacturer’s publication(s) and/or website(s) for manufacturer’s warranty, maintenance, safety, mounting and any regulatory compliance/non-compliance information.



2312-0261



2312-0263



FLARE™
WINDSHIELD

FLARE™ WINDSHIELDS

- Manufactured from dual-side, hard-coated polycarbonate material for outstanding impact strength
- Innovative design features "hips" at the outer edge of the shield that re-routes the air to add downforce and aid stability
- Installs easily using stock mounting hardware, maintains stock adjustability
- FLARE at the top sends clean, less turbulent air to rider and passenger
- Choose from clear, tint, dark smoke, and black color options
- Made in the U.S.A.

Chieftain/Roadmaster Flare™

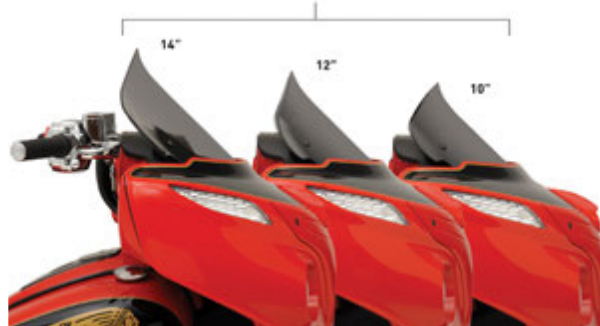

FOR 14-19 CHIEFTAIN, 15-19 ROADMASTER

COLOR	HEIGHT	PART #	SUG. RETAIL
TALL			
Tint	12"	2312-0259	\$209.95
Dark smoke	12"	2312-0260	209.95
Clear	14"	2312-0479	239.95
Tint	14"	2312-0480	239.95
Dark smoke	14"	2312-0481	239.95

COLOR	HEIGHT	PART #	SUG. RETAIL
SHORT			
Tint	10"	2312-0261	\$209.95
Dark smoke	10"	2312-0262	209.95
Black	10"	2312-0263	209.95



Clear

Gradient black

Gradient ruby

Gradient blue

Solar

"Night Shades" black

MEMPHIS SLIM

- Slimmed-down version of Memphis Fats
- Gradient translucent colors, as well as clear and solar (a light tint with 72% visible light transmission)
- Measures 18" wide; available in 15" and 17" heights with a 9" headlight cutout
- Made of Lucite® for excellent optics and durability
- Windshield straps are available in polished stainless steel with CNC-machined billet aluminum fittings and stainless steel socket-head screws or "Night Shades" black version, which is a gradient black windshield with black E-coated stainless steel straps, fittings and hardware for a black-on-black sinister look
- Mounting kits must be ordered separately; see page 11
- Optional Lowers available for additional windshield coverage; see page 7
- Made in the U.S.A.



MEM4121 Gradient black

PART #	COLOR	SUG. RETAIL	PART #	DESCRIPTION	SUG. RETAIL
17"					
MEM4220	Clear	\$177.95	MEM4120	Clear	\$167.95
MEM4221	Gradient black	177.95	MEM4121	Gradient black	167.95
MEM4222	Gradient ruby	177.95	MEM4122	Gradient ruby	167.95
MEM4226	Gradient blue	177.95	MEM4126	Gradient blue	167.95
MEM4229	Solar	177.95	MEM4129	Solar	167.95
2313-0107	"Night Shades" black	177.95	2313-0105	"Night Shades" black	167.95

All part numbers in **BLUE** are new for 2019.

WINDSHIELDS & FAIRINGS

AUDIO, COMMUNICATION & MOUNTS

SADDLEBAGS & LUGGAGE

SEATS & SISSY BARS

EXHAUST

FUEL/AIR SYSTEMS

ENGINE

TRANSMISSION & DRIVELINE

GASKETS & SEALS

ELECTRICAL

LIGHTING

HANDLEBARS, CONTROLS & MIRRORS

CABLES

BRAKES

TANKS & OIL FILTERS

DASHES & GAUGES

FRAMES & SUSPENSION

FENDERS & LICENSE PLATE FRAMES

FOOTRESTS & FLOORBOARDS

WHEELS & AXLES

HARDWARE, COVERS & GENERAL

WINDSHIELDS & FAIRINGS



AUDIO, COMMUNICATION & MOUNTS

SADDLEBAGS & LUGGAGE

SEATS & SISSY BARS

EXHAUST

FUEL/AIR SYSTEMS

ENGINE

TRANSMISSION & DRIVELINE

GASKETS & SEALS

ELECTRICAL

LIGHTING

HANDLEBARS, CONTROLS & MIRRORS

CABLES

BRAKES

TANKS & OIL FILTERS

DASHES & GAUGES

FRAMES & SUSPENSION

FENDERS & LICENSE PLATE FRAMES

FOOTRESTS & FLOORBOARDS

WHEELS & AXLES

HARDWARE, COVERS & GENERAL

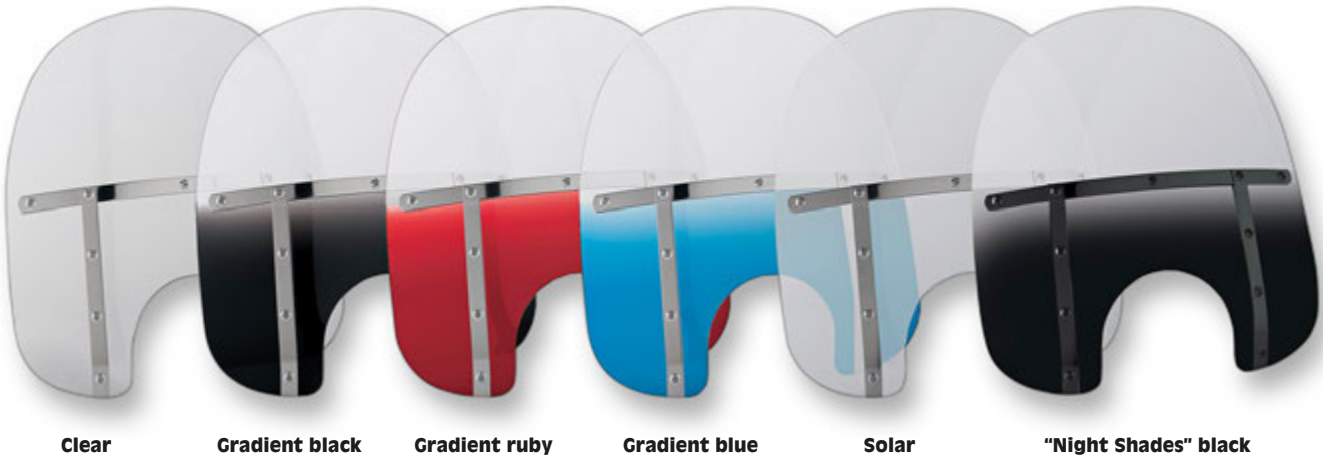

MEMPHIS FATS

- Feature traditional American styling with gradient translucent shading in vibrant colors, as well as clear and solar (a light tint with 72% visible light transmission)
- Made from Lucite® for excellent optics and durability
- 22" W with five standard heights to choose from
- Windshield straps are available in polished stainless steel with CNC-machined billet aluminum fittings and stainless steel socket-head screws or "Night Shades" black version, which is a gradient black windshield with black E-coated stainless steel straps, fittings and hardware for a black-on-black sinister look
- Available with a 9" headlight cutout
- Mounting kits must be ordered separately; see page 11
- Made in the U.S.A.

PART #	COLOR	SUG. RETAIL
13"		
2313-0003	Clear	\$175.95
2313-0004	Gradient black	175.95
2313-0005	Gradient ruby	175.95
2313-0009	Gradient blue	175.95
2313-0010	Solar	175.95
2313-0099	"Night Shades" black	175.95

PART #	COLOR	SUG. RETAIL
17"		
MEM3620	Clear	\$185.95
MEM3621	Gradient black	185.95
MEM3622	Gradient ruby	185.95
MEM3626	Gradient blue	185.95
MEM3629	Solar	185.95
2313-0101	"Night Shades" black	185.95

PART #	COLOR	SUG. RETAIL
21"		
MEM3810	Clear	\$206.95
MEM3811	Gradient black	206.95
MEM3812	Gradient ruby	206.95

PART #	COLOR	SUG. RETAIL
15"		
2313-0073	Clear	\$185.95
2313-0074	Gradient black	185.95
2313-0075	Gradient ruby	185.95
2313-0079	Gradient blue	185.95
2313-0081	Solar	185.95
2313-0100	"Night Shades" black	185.95

PART #	COLOR	SUG. RETAIL
19"		
MEM3710	Clear	\$195.95
MEM3711	Gradient black	195.95
MEM3712	Gradient ruby	195.95
MEM3716	Gradient blue	195.95
MEM3719	Solar	195.95
2313-0102	"Night Shades" black	195.95

PART #	COLOR	SUG. RETAIL
21" (CONT)		
MEM3816	Gradient blue	\$206.95
MEM3819	Solar	206.95
2313-0103	"Night Shades" black	206.95

All part numbers in **BLUE** are new for 2019.



SIDE WINGS

- Expand comfort pocket, channeling air outward while “cleaning” the flow
- Adjust to suit rider preference
- Can be installed/removed with windshield intact – Santoprene pads grip the windshield but do not mar the surface
- “Ghost” shade – a neutral tint with 85% light transmission; barely noticeable, with just enough tint to make the edges disappear
- Side Wings fit all Memphis Fats windshields or similar windshields that measure either 3mm or 4.5mm thick (includes inserts for both sizes); feature injection-molded glass-filled nylon clamps in place of the billet aluminum; can be mounted along with Hot Wing
- Made in the U.S.A.



PART #	DESCRIPTION	SUG. RETAIL
2350-0200	Side Wings	\$99.95

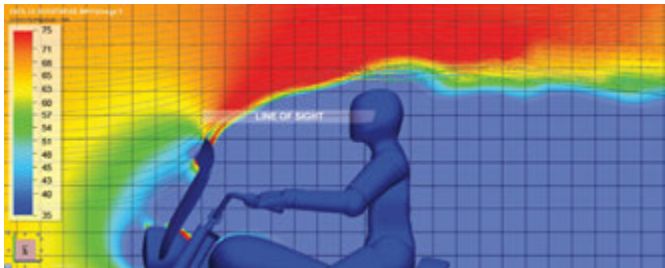

HOT WING

- Boost airstream upward – Venturi action speeds up the airstream while smoothing the flow – without buffeting
- Allows the use of a shorter shield; now you can easily look over your shield
- Made with “Ghost” shade – a neutral tint with 85% light transmission; barely noticeable, with just enough tint to make the edges disappear
- Uses lightweight, economical injection-molded glass-filled nylon clamps; fits Memphis Fats windshields or similar windshields that measure 3mm or 4.5mm thick (includes inserts for both sizes)
- Made in the U.S.A.



PART #	DESCRIPTION	SUG. RETAIL
2350-0199	Memphis Hot Wing	\$79.95

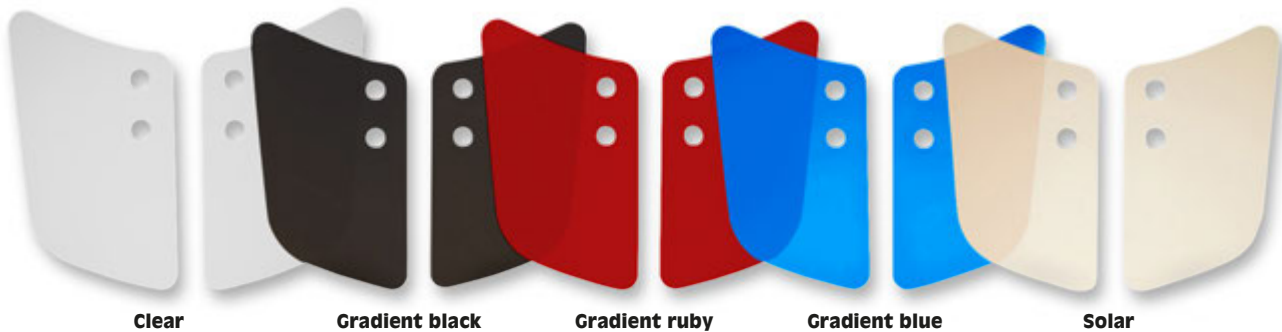

CUSTOM LOWERS PLASTIC

- Lowers work with Sportshields as well as Memphis Fats and Slim
- Extend coverage downward to shield rider from rain, wind and noise coming up from the road
- Made of the same high-quality materials as Memphis Shades windshields with matching tints
- Must purchase Lowers mounting hardware separately; see 2019 Drag Fatbook
- Sold in pairs



PART #	COLOR	SUG. RETAIL	PART #	COLOR	SUG. RETAIL	PART #	COLOR	SUG. RETAIL
MEP5810	Clear	\$24.95	MEP5812	Gradient ruby	\$24.95	MEP5819	Solar	\$24.95
MEP5811	Gradient black	24.95	MEP5816	Gradient blue	24.95			

All part numbers in **BLUE** are new for 2019.

WINDSHIELDS & FAIRINGS

AUDIO, COMMUNICATION & MOUNTS

SADDLEBAGS & LUGGAGE

SEATS & SISSY BARS

EXHAUST

FUEL/AIR SYSTEMS

ENGINE

TRANSMISSION & DRIVELINE

GASKETS & SEALS

ELECTRICAL

LIGHTING

HANDLEBARS, CONTROLS & MIRRORS

CABLES

BRAKES

TANKS & OIL FILTERS

DASHES & GAUGES

FRAMES & SUSPENSION

FENDERS & LICENSE PLATE FRAMES

FOOTRESTS & FLOORBOARDS

WHEELS & AXLES

HARDWARE, COVERS & GENERAL

WINDSHIELDS & FAIRINGS



AUDIO, COMMUNICATION & MOUNTS

SADDLEBAGS & LUGGAGE

SEATS & SISSY BARS

EXHAUST

FUEL/AIR SYSTEMS

ENGINE

TRANSMISSION & DRIVELINE

GASKETS & SEALS

ELECTRICAL

LIGHTING

HANDLEBARS, CONTROLS & MIRRORS

CABLES

BRAKES

TANKS & OIL FILTERS

DASHES & GAUGES

FRAMES & SUSPENSION

FENDERS & LICENSE PLATE FRAMES

FOOTRESTS & FLOORBOARDS

WHEELS & AXLES

HARDWARE, COVERS & GENERAL



Gradient black

Gradient ruby

Gradient blue

Solar

MEP5319 Solar



RIO GRANDE

- The most coverage of any windshield in the Sportshield family
- Made of Lucite® for excellent optics and durability
- Available in three gradient colors and solar (a light tint with 72% visible light transmission)
- Measures approximately 21" W x 19" H above headlight
- Fits most round headlights
- No-Tool detachable Trigger-Lock mounting kits must be ordered separately, see page 11
- Made in the U.S.A.

PART #	DESCRIPTION	SUG. RETAIL
MEP5311	Gradient black	\$96.95
MEP5312	Gradient ruby	96.95

PART #	DESCRIPTION	SUG. RETAIL
MEP5316	Gradient blue	\$96.95
MEP5319	Solar	96.95



Gradient black

Gradient blue

Solar

MEP5212 Gradient ruby



EL PASO

- Headlight cutout sized for 5³/₄ - 7" headlight
- Smooth design complements the lines of your machine
- Tapered windshield lower is ideal for handlebar-mounted turn signals
- Made of Lucite® for excellent optics and durability
- Available in three gradient colors and solar (a light tint with 72% visible light transmission)

- Measures approximately 20" W; available in 17" or 19" H above headlight
- Fits most round headlights
- No-Tool detachable Trigger-Lock mounting kits must be ordered separately; see page 11
- Made in the U.S.A.

PART #	DESCRIPTION	SUG. RETAIL
17" TALL		
MEP5211	Gradient black	\$96.95
MEP5212	Gradient ruby	96.95
MEP5216	Gradient blue	96.95
MEP5219	Solar	96.95

PART #	DESCRIPTION	SUG. RETAIL
19" TALL		
MEP5221	Gradient black	\$96.95
MEP5222	Gradient ruby	96.95
MEP5226	Gradient blue	96.95
MEP5229	Solar	96.95

All part numbers in **BLUE** are new for 2019.



WINDSHIELDS & FAIRINGS

AUDIO, COMMUNICATION & MOUNTS

SADDLEBAGS & LUGGAGE

SEATS & SISSY BARS

EXHAUST

FUEL/AIR SYSTEMS

ENGINE

TRANSMISSION & DRIVELINE

GASKETS & SEALS

ELECTRICAL

LIGHTING

HANDLEBARS, CONTROLS & MIRRORS

CABLES

BRAKES

TANKS & OIL FILTERS

DASHES & GAUGES

FRAMES & SUSPENSION

FENDERS & LICENSE PLATE FRAMES

FOOTRESTS & FLOORBOARDS

WHEELS & AXLES

HARDWARE, COVERS & GENERAL



DEL RIO

- Good torso protection in a sleek windshield design
- Made of Lucite® for excellent optics and durability
- Available in three gradient colors and solar (a light tint with 72% visible light transmission)
- Measures approximately 19" W x 15" H above headlight

- Fits most round headlights
- No-Tool detachable Trigger-Lock mounting kits must be ordered separately; see page 11
- Made in the U.S.A.

PART #	DESCRIPTION	SUG. RETAIL
MEP5111	Gradient black	\$86.95
MEP5112	Gradient ruby	86.95

PART #	DESCRIPTION	SUG. RETAIL
MEP5116	Gradient blue	\$86.95
MEP5119	Solar	86.95



MEP5011 Gradient black



MEP5012 Gradient ruby



MEP5016 Gradient blue



MEP5019 Solar

DEL REY

- Small, sleek design that offers good protection in a minimalist package
- Made of Lucite® for excellent optics and durability
- Available in three gradient colors and solar (a light tint with 72% visible light transmission)
- Measures approximately 15" W x 13" H above headlight

- Fits most round headlights
- No-Tool detachable Trigger-Lock mounting kits must be ordered separately; see page 11
- Made in the U.S.A.

PART #	DESCRIPTION	SUG. RETAIL
MEP5011	Gradient black	\$75.95
MEP5012	Gradient ruby	75.95

PART #	DESCRIPTION	SUG. RETAIL
MEP5016	Gradient blue	\$75.95
MEP5019	Solar	75.95



2313-0090



2313-0091

SPEED DEMON

- Offers more protection with a sporty look
- Features a similar shape and style to the popular handlebar mount "Demon" shield, but with the benefits of easier installation and faster removal due to the exclusive Sportshield mounting system
- Measures 21" W and 18" H above the headlight; fits a 7" or 9" headlight cutout

- Made of Lucite® for excellent optics and durability
- No-Tool detachable Trigger-Lock mounting kits must be ordered separately; see page 11
- Made in the U.S.A.

PART #	COLOR	SUG. RETAIL
2313-0090	Black	\$96.95

PART #	COLOR	SUG. RETAIL
2313-0091	Solar	\$96.95

All part numbers in **BLUE** are new for 2019.



MEP5621



MEP5629



ALLEY CAT SPORTSHIELDS

- Modeled after the popular Hell Cat handlebar-mounted windshield
- Measure 20" W x 18" H above the headlight
- Available for 9" headlights
- Made of Lucite® for excellent optics and durability

- Available in gradient black and solar tints
- No-Tool detachable Trigger-Lock mounting kits must be ordered separately; see page 11

PART #	COLOR	SUG. RETAIL
MEP5621	Gradient black	\$95.95

PART #	COLOR	SUG. RETAIL
MEP5629	Solar	\$95.95

MEP5721



MEP5729



BIG SHOT SPORTSHIELDS

- The biggest Sportshield available
- Sleek styling with maximum coverage
- Measure 21" W x 20" H above the headlight
- Available for 9" headlights

- Made of Lucite® for excellent optics and durability
- Available in gradient black and solar tint
- No-Tool detachable Trigger-Lock mounting kits must be ordered separately; see page 11

PART #	COLOR	SUG. RETAIL
MEP5721	Gradient black	\$95.95

PART #	COLOR	SUG. RETAIL
MEP5729	Solar	\$95.95

MEP5521



MEP5529



POP TOP SPORTSHIELD

- Two inches taller than the handlebar-mounted Shooter windshield
- Measures 18" W x 16" H above headlight
- Available for 9" headlights
- Made of Lucite® for excellent optics and durability

- Available in gradient black and solar tint
- No-Tool detachable Trigger-Lock mounting kits must be ordered separately; see page 11

PART #	COLOR	SUG. RETAIL
MEP5521	Gradient black	\$85.95

PART #	COLOR	SUG. RETAIL
MEP5529	Solar	\$85.95

All part numbers in **BLUE** are new for 2019.



2321-0370



2321-0373



2321-0368



2321-0367



2020-1621

NO-TOOL TRIGGER LOCK MOUNT KITS FOR FATS/SLIM AND SPORTSHIELDS

- Memphis Shades Fats/Slim mount kits feature Quick-Change mounting, which allows you to remove or swap out your Memphis Fats or Slim windshields in about one minute
- Hardware is custom-fit to each style of bike for no-hassle installation
- Hardware includes stainless steel bolts and CNC-machined aluminum mounting plates and anchors

PLATE-ONLY KITS

- Allow changing from Fats/Slim to Sportshield or from Sportshield to Fats/Slim without purchasing the entire mounting hardware



FITS MODEL	FATS/SLIM QUICK-CHANGE MOUNT KITS		PLATE-ONLY KITS	
	POLISHED	BLACK	POLISHED	BLACK
For 15-16 Scout	2321-0370	2321-0372	2321-0371	2321-0373
For 16 Scout Sixty	2321-0370	2321-0372	2321-0371	2321-0373

FITS MODEL	SPORTSHIELD QUICK-CHANGE MOUNT KITS		PLATE-ONLY KITS	
	POLISHED	BLACK	POLISHED	BLACK
For 15-16 Scout	2321-0366	2321-0368	2321-0367	2321-0369
For 16 Scout Sixty	2321-0366	2321-0368	2321-0367	2321-0369
For 18 Scout Bobber	2321-0366	2321-0368	2321-0367	2321-0369

PART #	SUG. RETAIL	PART #	SUG. RETAIL	PART #	SUG. RETAIL
2321-0366	\$149.95	2321-0369	\$65.95	2321-0372	\$149.95
2321-0367	65.95	2321-0370	149.95	2321-0373	65.95
2321-0368	149.95	2321-0371	65.95		

TURN SIGNAL RELOCATION KIT-BLACK	FITS MODEL	SUG. RETAIL
2321-0374	For 15-16 Scout	\$19.95
2321-0374	For 16 Scout Sixty	19.95
2020-1621	For 18 Scout Bobber	19.95

- WINDSHIELDS & FAIRINGS
- AUDIO, COMMUNICATION & MOUNTS
- SADDLEBAGS & LUGGAGE
- SEATS & SISSY BARS
- EXHAUST
- FUEL/AIR SYSTEMS
- ENGINE
- TRANSMISSION & DRIVELINE
- GASKETS & SEALS
- ELECTRICAL
- LIGHTING
- HANDLEBARS, CONTROLS & MIRRORS
- CABLES
- BRAKES
- TANKS & OIL FILTERS
- DASHES & GAUGES
- FRAMES & SUSPENSION
- FENDERS & LICENSE PLATE FRAMES
- FOOTRESTS & FLOORBOARDS
- WHEELS & AXLES
- HARDWARE, COVERS & GENERAL

All part numbers in **BLUE** are new for 2019.

slip streamer inc.



2312-0391



2312-0477

REPLACEMENT WINDSHIELDS

- Made of crystal clear or tinted 3/16" Lucite®
- Distortion-free, optically correct and break resistant
- Precision crafted for a perfect fit
- Made in the U.S.A.

PART #	DESCRIPTION	SUG. RETAIL
FOR CHIEFTAIN 15-19, ROADMASTER 15-19		
CLEAR		
2312-0391	12"	\$113.95
2312-0392	16"	113.95
2312-0393	20"	129.95
2312-0394	24"	133.95

PART #	DESCRIPTION	SUG. RETAIL
FOR CHIEFTAIN 15-19, ROADMASTER 15-19 (CONT)		
TINTED		
2312-0474	12"	\$115.95
2312-0475	16"	115.95
2312-0476	20"	131.95
2312-0477	24"	143.95

SS-34 PHANTOM

- Windshield is constructed of 3/16" aircraft-quality Lucite®
- Its dark tint and black powder-coated hardware will add an ominous look to most bikes
- Shield measures 13" H x 30" W
- Versatile new Quick Release mounting systems fit many different bikes with standard fork tubes or oversized fork tubes
- Made in the U.S.A.



2313-0234

PART #	DESCRIPTION	SUG. RETAIL
2313-0234	W/ standard fork mounting system (28-41mm fork tubes w/ 9"-10.5" fork span)	\$370.95
2313-0237	W/ Oversized fork mounting system (42-58mm fork tubes w/ 11"-12.5" fork span)	370.95
2313-0238	W/ Wide Glide fork mounting system (28-41mm fork tubes w/ 11"-12.5" fork span)	370.95

SS-32 FALCON

- Unique design combines classic styling of American vintage cruiser shield with features like size and hand protection from a classic touring shield
- Versatile new Quick Release mounting systems fit many different bikes with standard fork tubes or oversized fork tubes
- Available in clear
- DOT compliant
- Made in the U.S.A.



2313-0184

PART #	DESCRIPTION	SUG. RETAIL
16" H X 30.5" W WINDSHIELD W/ CHROME HARDWARE		
2313-0184	W/ standard fork mounting system (28-41mm fork tubes w/ 9"-10.5" fork span)	\$395.95
2313-0189	W/ Oversized fork mounting system (42-58mm fork tubes w/ 11"-12.5" fork span)	395.95
2313-0199	W/ Wide Glide fork mounting system (28-41mm fork tubes w/ 11"-12.5" fork span)	395.95
16" H X 30.5" W WINDSHIELD W/ BLACK HARDWARE		
2313-0224	W/ standard fork mounting system (28-41mm fork tubes w/ 9"-10.5" fork span)	368.95
2313-0228	W/ Wide Glide fork mounting system (28-41mm fork tubes w/ 11"-12.5" fork span)	368.95
20" H X 30.5" W WINDSHIELD W/ CHROME HARDWARE		
2313-0185	W/ standard fork mounting system (28-41mm fork tubes w/ 9"-10.5" fork span)	397.95
2313-0201	W/ Wide Glide fork mounting system (28-41mm fork tubes w/ 11"-12.5" fork span)	397.95
20" H X 30.5" W WINDSHIELD W/ BLACK HARDWARE		
2313-0229	W/ standard fork mounting system (28-41mm fork tubes w/ 9"-10.5" fork span)	370.95
2313-0232	W/ Oversized fork mounting system (42-58mm fork tubes w/ 11"-12.5" fork span)	370.95
2313-0233	W/ Wide Glide fork mounting system (28-41mm fork tubes w/ 11"-12.5" fork span)	370.95

All part numbers in **BLUE** are new for 2019.

slip streamer inc.

2313-0209



2313-0176



SS-30 CLASSIC WINDSHIELDS

- Complement your rider's style with this sleek design
- Versatile new Quick Release mounting systems fit many different bikes with standard fork tubes or oversized fork tubes
- All styles are 23" wide
- DOT compliant
- Made in the U.S.A.

PART #	DESCRIPTION	SUG. RETAIL
17" H X 23" W CLEAR WINDSHIELD W/ CHROME HARDWARE		
2313-0177	W/ standard fork mounting system (28-41mm fork tubes w/ 9"-10.5" fork span)	\$349.95
2313-0188	W/ Oversized fork mounting system (42-58mm fork tubes w/ 11"-12.5" fork span)	349.95
2313-0194	W/ Wide Glide fork mounting system (28-41mm fork tubes w/ 11"-12.5" fork span)	349.95
17" H X 23" W CLEAR WINDSHIELD W/ BLACK HARDWARE		
2313-0204	W/ standard fork mounting system (28-41mm fork tubes w/ 9"-10.5" fork span)	320.95
2313-0207	W/ Oversized fork mounting system (42-58mm fork tubes w/ 11"-12.5" fork span)	320.95
2313-0208	W/ Wide Glide fork mounting system (28-41mm fork tubes w/ 11"-12.5" fork span)	320.95
17" H X 23" W SMOKE WINDSHIELD W/ CHROME HARDWARE		
2313-0179	W/ standard fork mounting system (28-41mm fork tubes w/ 9"-10.5" fork span)	356.95
2313-0192	W/ Wide Glide fork mounting system (28-41mm fork tubes w/ 11"-12.5" fork span)	356.95
17" H X 23" W SMOKE WINDSHIELD W/ BLACK HARDWARE		
2313-0209	W/ standard fork mounting system (28-41mm fork tubes w/ 9"-10.5" fork span)	328.95
2313-0212	W/ Oversized fork mounting system (42-58mm fork tubes w/ 11"-12.5" fork span)	328.95
2313-0213	W/ Wide Glide fork mounting system (28-41mm fork tubes w/ 11"-12.5" fork span)	328.95

PART #	DESCRIPTION	SUG. RETAIL
22" H X 23" W CLEAR WINDSHIELD W/ CHROME HARDWARE		
2313-0176	W/ standard fork mounting system (28-41mm fork tubes w/ 9"-10.5" fork span)	\$370.95
2313-0191	W/ Oversized fork mounting system (42-58mm fork tubes w/ 11"-12.5" fork span)	370.95
2313-0193	W/ Wide Glide fork mounting system (28-41mm fork tubes w/ 11"-12.5" fork span)	370.95
22" H X 23" W CLEAR WINDSHIELD W/ BLACK HARDWARE		
2313-0214	W/ standard fork mounting system (28-41mm fork tubes w/ 9"-10.5" fork span)	342.95
2313-0217	W/ Oversized fork mounting system (42-58mm fork tubes w/ 11"-12.5" fork span)	342.95
2313-0218	W/ Wide Glide fork mounting system (28-41mm fork tubes w/ 11"-12.5" fork span)	342.95
22" H X 23" W SMOKE WINDSHIELD W/ CHROME HARDWARE		
2313-0178	W/ standard fork mounting system (28-41mm fork tubes w/ 9"-10.5" fork span)	379.95
2313-0195	W/ Wide Glide fork mounting system (28-41mm fork tubes w/ 11"-12.5" fork span)	379.95
22" H X 23" W SMOKE WINDSHIELD W/ BLACK HARDWARE		
2313-0219	W/ standard fork mounting system (28-41mm fork tubes w/ 9"-10.5" fork span)	352.95
2313-0222	W/ Oversized fork mounting system (42-58mm fork tubes w/ 11"-12.5" fork span)	352.95
2313-0223	W/ Wide Glide fork mounting system (28-41mm fork tubes w/ 11"-12.5" fork span)	352.95

2311-0006



2311-0009



2320-0009

BILLET SERIES WINDSHIELDS

- A unique approach to wind protection
- Mirror-polished, chrome-plated, billet aluminum universal hardware mount; one bracket fits both 7/8" and 1" handlebars

- Shield adjusts up/down; hardware mount adjusts left/right and rotational
- Made in the U.S.A.

NOTE: See application chart on pages 16.

PART #	DESCRIPTION	SUG. RETAIL
BULLET (14" W)		
2311-0006	15" clear	\$169.95
2311-0007	18" clear	169.95
2320-0009	Repl. mounting hardware kit	110.95

PART #	DESCRIPTION	SUG. RETAIL
B-WING (19" W)		
2311-0008	15" clear	\$178.95
2311-0009	18" clear	179.95
2320-0009	Repl. mounting hardware kit	110.95

All part numbers in **BLUE** are new for 2019.

- WINDSHIELDS & FAIRINGS
- AUDIO, COMMUNICATION & MOUNTS
- SADDLEBAGS & LUGGAGE
- SEATS & SISSY BARS
- EXHAUST
- FUEL/AIR SYSTEMS
- ENGINE
- TRANSMISSION & DRIVELINE
- GASKETS & SEALS
- ELECTRICAL
- LIGHTING
- HANDLEBARS, CONTROLS & MIRRORS
- CABLES
- BRAKES
- TANKS & OIL FILTERS
- DASHES & GAUGES
- FRAMES & SUSPENSION
- FENDERS & LICENSE PLATE FRAMES
- FOOTRESTS & FLOORBOARDS
- WHEELS & AXLES
- HARDWARE, COVERS & GENERAL

WINDSHIELDS & FAIRINGS

AUDIO, COMMUNICATION & MOUNTS

SADDLEBAGS & LUGGAGE

SEATS & SISSY BARS

EXHAUST

FUEL/AIR SYSTEMS

ENGINE

TRANSMISSION & DRIVELINE

GASKETS & SEALS

ELECTRICAL

LIGHTING

HANDLEBARS, CONTROLS & MIRRORS

CABLES

BRAKES

TANKS & OIL FILTERS

DASHES & GAUGES

FRAMES & SUSPENSION

FENDERS & LICENSE PLATE FRAMES

FOOTRESTS & FLOORBOARDS

WHEELS & AXLES

HARDWARE, COVERS & GENERAL

2313-0001



2313-0121



S-06 SPITFIRE SPORT SHIELDS

- Great protection and devastating style come together in the Spitfire Sport Shield
- Constructed of 1/8" acrylic with red graphics
- Fully adjustable; mounts/dismounts in seconds; fits both 7/8" and 1" handlebars
- For round or rectangular headlights
- Height: 15" above headlight; width: 17 1/2"
- Made in the U.S.A.

NOTE: See application chart on page 16.



2321-0408

PART #	DESCRIPTION	SUG. RETAIL
2313-0001	Clear w/ black hardware	\$104.95
2313-0120	Clear w/ chrome hardware	131.95
2313-0002	Tint w/ black hardware	104.95

PART #	DESCRIPTION	SUG. RETAIL
2313-0121	Tint w/ chrome hardware	\$132.95
2321-0408	Repl. chrome hardware kit	70.95

SS-10-C-1



SS-10 VIPER

- Uses the same quick-release mounting system as the Spitfire shield
- Larger glass for added protection
- Available in clear or smoke tint with 7/8" and 1" hardware
- Dimensions: 17 1/4" H x 22 1/4" W
- Made in the U.S.A.

NOTE: See application chart on page 16.



2321-0408

PART #	DESCRIPTION	SUG. RETAIL
SS-10-C-1	Clear w/ black hardware	\$130.95
SS-10-T-1	Smoke w/ black hardware	140.95
2321-0408	Opt. chrome hardware kit	70.95

SS24-A



SS24-T



SS-24 HELLFIRE CRUISER SHIELDS

- Constructed of high-strength, 3/16" clear acrylic
- Fully adjustable four-point mounting
- Ball-socket mounts for versatility
- For height and width see chart
- Made in the U.S.A.

NOTE: See application chart on page 16.

PART #	DESCRIPTION	SUG. RETAIL
SS24-A	Clear windshield 17" H x 19" W	\$179.95
SS24-T	Tint windshield 17" H x 19" W	187.95

PART #	DESCRIPTION	SUG. RETAIL
SS24V-C	Clear windshield 18" H x 19" W	\$179.95
SS24V-V	Tint windshield 18" H x 19" W	187.95

All part numbers in BLUE are new for 2019.

slip streamer inc.



2313-0241



2321-0408

S-09 COBRA WINDSHIELD

- Curved looks and distinctive styling make the Cobra the striking leader in small fairing protection
- Exclusive anodized aluminum disc hardware system allows windshield to be taken off and put back on in seconds; fully adjustable for height and angle
- Fits either a round or square headlight
- Available in smoke tint with 7/8" and 1" black hardware
- Dimensions: 16³/₄" H x 19" W

PART #	DESCRIPTION	SUG. RETAIL
2313-0241	Smoke w/ black hardware	\$105.95
2321-0408	Opt. chrome hardware kit	\$70.95

DS-710361



MINI POLICE WINDSHIELDS

- Designed to replicate the Harley police shield, this Slipstreamer original takes it one step farther
- Mounted with quick-release mounting hardware to remove and put back in seconds
- Features stainless steel straps and anodized aluminum hardware
- Comes standard with both 7/8" and 1" handlebar hardware
- Measures 14¹/₂" wide, 15" from headlight to top
- Made in the U.S.A.

PART #	DESCRIPTION	SUG. RETAIL
DS-710360	Clear windshield and hardware kit	\$145.95
DS-710361	Smoke windshield and hardware kit	146.95
HD-OHDW	Repl. 1" hardware kit	50.95



HD3-DS



HD3-C

TOMBSTONE

- A nostalgic design that gives your bike a one-of-a-kind American style
- Shield mounts/removes in short order thanks to an advanced quick-release system
- Fits both 7/8" and 1" handlebars
- 10" W, 13⁵/₈" from headlight cutout to top and 14" H overall
- Available in dark smoke or clear
- Made in the U.S.A.

PART #	DESCRIPTION	SUG. RETAIL	PART #	DESCRIPTION	SUG. RETAIL
HD3-DS	Dark smoke windshield and black hardware kit	\$109.95	HD3-C	Clear windshield and black hardware kit	\$106.95
2313-0240	Dark smoke windshield and chrome hardware kit	137.95	2313-0239	Clear windshield and chrome hardware kit	134.95



CF-30



CF-40



CF-50

UNIVERSAL WINDSHIELDS

- These clear windshields offer both style and protection from the elements
- Constructed of 3/16" clear acrylic
- Top edge is scientifically designed to direct windblast above rider's head
- Anodized-aluminum mounting hardware will not rust
- Four-point mounting provides adjustments for shield height, position and angle
- Three sizes available; all fit 7/8" and 1" handlebars
- Made in the U.S.A.

PART #	DESCRIPTION	SUG. RETAIL	PART #	DESCRIPTION	SUG. RETAIL	PART #	DESCRIPTION	SUG. RETAIL
CF-30	15" W x 17" H	\$117.95	CF-40	18" W x 24" H	\$124.95	CF-50	24" W x 24" H	\$150.95

All part numbers in BLUE are new for 2019.

WINDSHIELDS & FAIRINGS

AUDIO, COMMUNICATION & MOUNTS

SADDLEBAGS & LUGGAGE

SEATS & SISSY BARS

EXHAUST

FUEL/AIR SYSTEMS

ENGINE

TRANSMISSION & DRIVELINE

GASKETS & SEALS

ELECTRICAL

LIGHTING

HANDLEBARS, CONTROLS & MIRRORS

CABLES

BRAKES

TANKS & OIL FILTERS

DASHES & GAUGES

FRAMES & SUSPENSION

FENDERS & LICENSE PLATE FRAMES

FOOTRESTS & FLOORBOARDS

WHEELS & AXLES

HARDWARE, COVERS & GENERAL

WINDSHIELDS & FAIRINGS

AUDIO, COMMUNICATION & MOUNTS

SADDLEBAGS & LUGGAGE

SEATS & SISSY BARS

EXHAUST

FUEL/AIR SYSTEMS

ENGINE

TRANSMISSION & DRIVELINE

GASKETS & SEALS

ELECTRICAL

LIGHTING

HANDLEBARS, CONTROLS & MIRRORS

CABLES

BRAKES

TANKS & OIL FILTERS

DASHES & GAUGES

FRAMES & SUSPENSION

FENDERS & LICENSE PLATE FRAMES

FOOTRESTS & FLOORBOARDS

WHEELS & AXLES

HARDWARE, COVERS & GENERAL



S00-C

slip streamer inc.

S-00 ENTERPRISE II FAIRINGS

- A full-size bolt-on fairing for excellent protection from the elements; even provides coverage below the headlight
- High-strength, 3/16" acrylic
- Four-point, fully adjustable mounting for versatility
- Anodized aluminum support rods; logo graphics
- Round or rectangular headlights
- Height: 21" above headlight; width: 33"
- Fits both 7/8" and 1" handlebars
- Made in the U.S.A.

NOTE: See application chart below.

PART #	DESCRIPTION	SUG. RETAIL
S00-C	Clear windshield and hardware kit	\$255.95
S00-T	Tint windshield and hardware kit	270.95



S02-C

slip streamer inc.

S-02 SPIRIT FAIRINGS

- Striking styling and graphics complement fit and function
- Constructed of high-strength, 3/16" acrylic
- Anodized-aluminum support rods will never rust
- For cycles with round headlights
- Ball-socket mounts for versatility
- Available in clear or smoke tint
- Height: 21" above headlight; width: 33"
- Fits 7/8" and 1" handlebars
- Made in the U.S.A.

NOTE: See application chart below.

PART #	DESCRIPTION	SUG. RETAIL
S02-C	Clear fairing and hardware kit	\$264.95
S02-T	Smoke fairing and hardware kit	279.95

slip streamer inc.

SLIP STREAMER SHIELD APPLICATIONS

FITS MODEL

	OEM BAR DIA.	ENTERPRISE (S-00)	SPIRIT (S-02)	SLIPSTREAMER (S-05)	SPITFIRE (S-06)	COBRA (S-09)	VIPER (SS-10)	HELLFIRE (SS-24)	SPORT FAIRING (SS-28)	CLASSIC (SS-30)	FALCON (SS-32)	PHANTOM (SS-34)	BULLET/B-WING	MINI POLICE (HD-0)	TOMBSTONE (HD-3)	
INDIAN																
For 14-18 Chief Classic	1 1/4"	-	-	-	4	4	4	-	-	-	-	-	-	4	4	
For 00-03 Chief	1"	-	-	-	1	1	1	-	-	-	-	-	1	1	1	
For 10-12 Chief Classic	1"	-	-	-	1	1	1	-	-	-	-	-	1	1	1	
For 10-18 Chief Dark Horse	1"	-	-	-	1	1	1	-	-	-	-	-	1	1	1	
For 10 Chief Bomber	1"	-	-	-	1	1	1	-	-	-	-	-	1	1	1	
For 01-03 Scout	1"	1	1	-	1	1	1	1	1	1	1	1	1	1	1	
For 15-18 Scout (41mm/11" span)	1"	-	-	1	1	1	1	-	1	1	1	1	1	1	1	
For 16-18 Scout 60 (41mm/11" span)	1"	-	-	1	1	1	1	-	1	1	1	1	1	1	1	
For Spirit 01-03	1"	1	1	-	1	1	1	-	7	7	7	7	1	1	1	

¹ Fits with no modifications.

⁴ Fits with 1 1/4" handlebar clamps.

⁷ Order w/ "Wide Glide" fork hardware



2312-0372



TOURING WINDSHIELD

- Larger touring windshield provides a better riding pocket
- 6" wider with an additional 1.5" in height
- 30% larger than OEM

PART #	DESCRIPTION	SUG. RETAIL
2312-0401	For 14-19 Roadmaster/Chieftain	\$165.95

GUN SMOKE WINDSHIELDS

- High-impact, shatterproof 5mm acrylic windshield
- 2" side contours with integrated deflector divert ind away from your head and chest
- Innovative cross-bar bracket and billet aluminum handlebar clamps hold the windshield firmly in place
- Quick-detachable hardware and mounting holes or easy installation and adjustment

PART #	SIZE	SUG. RETAIL
FOR 14-19 CHIEFTAIN, 15-19 ROADMASTER		
2312-0371	10"	\$169.95
2312-0372	12"	179.95

All part numbers in **BLUE** are new for 2019.



2330-0075



2321-0403



2321-0406

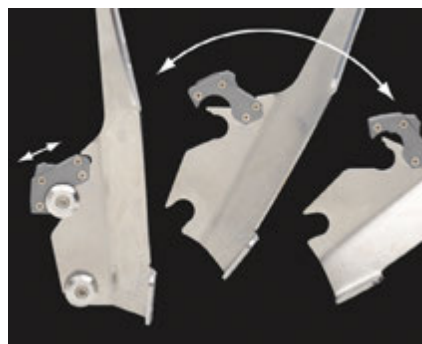

Trigger-Lock Mounts let you remove your Batwing Fairings in a moment's time or quickly change to your Memphis Shades Fats/Slim or Sportshield to instantly change the look of your bike.

MEMPHIS SHADES BATWING FAIRING

- Features clean aerodynamic shape
- Inner fairing structure is black ABS
- Fairing outer shell is opaque black Lucite® with a class A finish that looks great as is, or can easily be painted
- Memphis Shades exclusive No-Tool Trigger-Lock mounting kits feature a detach system that allows you to quickly and easily remove or install your fairing, or swap out with other Memphis Shades windshields, sportshields or fairings
- Trigger-Lock kits are available in a combination of CNC-machined aluminum plates, stainless steel bolts and aluminum anchors or black E-coated plates, bolts and anchors for a clean appearance that's built to last
- Fairing is predrilled and fitted with push-out hole plugs for easy wind deflector installation
- Windshields are available in four height and three translucent color options, as well as clear and solar (a light tint with 72% visible light transmission) for Spoiler windshields; see page 18
- Optional wind deflectors for increased downward airflow, windshield tri-pouch for storage and fairing trim for style are also available; see below and on page 18
- Made in the U.S.A.

NOTE: Batwing Fairing is not compatible with any other fairing windshields, wind deflectors or accessories.

NOTE: Plate-only kits are for riders who already have a Memphis Shades Trigger-Lock windshield installed and do not need the anchoring hardware components.

WHAT TO ORDER

1. Batwing Fairing
2. Trigger-Lock Mount Kit
3. Windshield of your preference; height and color options are shown below, see below for Spoiler windshields

FITS MODEL	BATWING FAIRING	SUG. RETAIL	TRIGGER LOCK MOUNTING KIT			SUG. RETAIL	PLATE-ONLY HARDWARE KIT		
			POLISHED	BLACK	SUG. RETAIL		POLISHED	BLACK	SUG. RETAIL
15-19 Scout/Scout Sixty ¹	2330-0075	\$299.95	2321-0403	2321-0405	\$149.95	2321-0404	2321-0406	\$65.95	
18-19 Scout Bobber ^{2,3}	2330-0081	299.95	2321-0403	2321-0405	149.95	2321-0404	2321-0406	65.95	

¹ Requires headlight riser block kit PART #2001-1502. ² Requires turn signal relocation kit PART #2020-1621. ³ Requires headlight extension kit PART #2001-1827.

BATWING FAIRING, WINDSHIELDS, DEFLECTORS AND ACCESSORIES

- Windshields specific to the Batwing Fairing provide superior optics and Lucite® construction
- Available in four height and three translucent color options, as well as clear and solar (a light tint with 72% visible light transmission)
- 5" windshields are solid translucent while 7", 9" and 12" windshields are gradient translucent
- Optional solid translucent color wind deflectors are available to extend the lower fairing surface for smooth downward airflow
- See page 18 for Spoiler windshields
- Also available is a windshield tri-pouch for storage and decorative trims for style



WINDSHIELDS											
PART #	DESCRIPTION	SUG. RETAIL	PART #	DESCRIPTION	SUG. RETAIL	PART #	DESCRIPTION	SUG. RETAIL	PART #	DESCRIPTION	SUG. RETAIL
5" WINDSHIELDS			7" WINDSHIELDS			9" WINDSHIELDS			12" WINDSHIELDS		
2310-0215 ¹	Black	\$84.95	2310-0216	Gradient black	\$84.95	2310-0217	Gradient black	\$84.95	2310-0308	Gradient black	\$84.95
2310-0227 ¹	Ruby	84.95	2310-0233	Gradient ruby	84.95	2310-0239	Gradient ruby	84.95	2310-0309	Gradient ruby	84.95
2310-0231 ¹	Blue	84.95	2310-0237	Gradient blue	84.95	2310-0243	Gradient blue	84.95	2310-0313	Gradient blue	84.95
2310-0269	Clear	84.95	2310-0270	Clear	84.95	2310-0271	Clear	84.95	2310-0307	Clear	84.95
2310-0304	Solar	84.95	2310-0305	Solar	84.95	2310-0306	Solar	84.95	2310-0315	Solar	84.95

¹ Solid color.

BATWING FAIRING, WINDSHIELDS, DEFLECTORS AND ACCESSORIES continued on next page.

All part numbers in **BLUE** are new for 2019.

WINDSHIELDS & FAIRINGS

AUDIO, COMMUNICATION & MOUNTS

SADDLEBAGS & LUGGAGE

SEATS & SISSY BARS

EXHAUST

FUEL/AIR SYSTEMS

ENGINE

TRANSMISSION & DRIVELINE

GASKETS & SEALS

ELECTRICAL

LIGHTING

HANDLEBARS, CONTROLS & MIRRORS

CABLES

BRAKES

TANKS & OIL FILTERS

DASHES & GAUGES

FRAMES & SUSPENSION

FENDERS & LICENSE PLATE FRAMES

FOOTRESTS & FLOORBOARDS

WHEELS & AXLES

HARDWARE, COVERS & GENERAL



BATWING FAIRING, WINDSHIELDS, DEFLECTORS AND ACCESSORIES (CONT)



PART #	DESCRIPTION	SUG. RETAIL
WIND DEFLECTORS		
2350-0111	Black	\$24.95
2350-0112	Ruby	24.95
2350-0116	Blue	24.95



DESCRIPTION	PART #	SUG. RETAIL
ACCESSORIES		
"Night Shades" cut fairing trim; Dots	2350-0152	\$59.95
"Night Shades" cut fairing trim; Ellipse	2350-0153	59.95
Polished stainless steel fairing trim; slotted fat-style	2350-0110	49.95
Polished stainless steel fairing trim; solid fat-style	2350-0119	49.95
Polished stainless steel fairing trim; solid slim-style	2350-0128	49.95
Polished stainless steel fairing trim; slotted slim-style	2350-0134	49.95
Windshield single pouch	3508-0017	59.95
Big Zipper quad pouch for Batwing Fairings and windshield	3508-0020	89.95
Headlight riser block kit	2001-1502	14.95



SPOILER WINDSHIELDS

- Designed to be looked over, the spoiler windshield diffuses the air stream, effectively slowing the flow without buffeting
- Fit all Memphis Shades Batwing Fairings
- Made of Lucite® for superior optics and durability
- Made in the U.S.A.

COLOR	5"	6.5"	9"	SUG. RETAIL
FOR MEMPHIS SHADES BATWING FAIRINGS				
Smoke	2350-0167	2350-0155	2350-0170	\$99.95
Ghost	2350-0168	2350-0165	2350-0171	99.95

All part numbers in **BLUE** are new for 2019.



WINDSHIELDS & FAIRINGS

AUDIO, COMMUNICATION & MOUNTS

SADDLEBAGS & LUGGAGE

SEATS & SISSY BARS

EXHAUST

FUEL/AIR SYSTEMS

ENGINE

TRANSMISSION & DRIVELINE

GASKETS & SEALS

ELECTRICAL

LIGHTING

HANDLEBARS, CONTROLS & MIRRORS

CABLES

BRAKES

TANKS & OIL FILTERS

DASHES & GAUGES

FRAMES & SUSPENSION

FENDERS & LICENSE PLATE FRAMES

FOOTRESTS & FLOORBOARDS

WHEELS & AXLES

HARDWARE, COVERS & GENERAL

ROAD WARRIOR FAIRING

- Stylish coverage with clean lines and smooth curves
- 19" wide
- Class A gloss black finish outside
- Model-specific mounting kits feature Memphis Shades exclusive Trigger-Lock mounting system and are sold separately
- Made in the U.S.A.

WHAT TO ORDER

1. Road Warrior Fairing
2. Trigger-lock mounting kit
3. Windshield for Road Warrior
4. Headlight extension block



2330-0165



2320-0205



2001-1829

FITS MODEL	ROAD WARRIOR FAIRING	SUG. RETAIL	TRIGGER-LOCK MOUNT KITS BLACK	SUG. RETAIL	HEADLIGHT EXTENSION BLOCKS	SUG. RETAIL
For 15-19 Scout/Scout Sixty ¹	2330-0165	\$199.95	2320-0205	\$149.95	2001-1828	\$29.95
For 18-19 Scout Bobber ²	2330-0165	199.95	2320-0205	149.95	2001-1829	29.95

¹ Requires headlight extension block PART #2001-1828.

² Requires headlight extension block PART #2001-1829.



2330-0093



2321-0401



2321-0400

MEMPHIS SHADES BULLET FAIRINGS

- Strong, one-piece fairings constructed of high-impact aircraft-grade Lucite®
- Bold aerodynamic shape with a hint of outlaw styling designed to streamline today's low-slung cruisers
- Provide full torso coverage to virtually eliminate wind fatigue while allowing an unobstructed view of the countryside; your head is in clean air
- A machined groove outlines the smoke windshield section
- The lower section features an opaque glare-free matte coating on the inside that gives the outside a high-gloss black "factory" finish for a clean two-piece look; looks great as is, or can be easily painted to really achieve the next level of custom
- Custom fit, model-specific mounting kits feature Memphis Shades exclusive Trigger-Lock mounting system – on and off without tools, or wap out with Memphis Fats/Slim windshields, Sportshields or Batwing Fairing
- Made in the U.S.A.



Trigger-Lock Mounts let you remove or change your Bullet Fairing in a moment's time

FITS MODEL	BULLET FAIRING	SUG. RETAIL	POLISHED	BLACK	SUG. RETAIL	POLISHED	BLACK	SUG. RETAIL
15-19 Scout/Scout Sixty ¹	2330-0093	\$169.95	2321-0399	2321-0401	\$149.95	2321-0400	2321-0402	\$65.95

¹ Requires turn signal relocation kit PART #2321-0374.

All part numbers in **BLUE** are new for 2019.

WINDSHIELDS & FAIRINGS

AUDIO, COMMUNICATION & MOUNTS

SADDLEBAGS & LUGGAGE

SEATS & SISSY BARS

EXHAUST

FUEL/AIR SYSTEMS

ENGINE

TRANSMISSION & DRIVELINE

GASKETS & SEALS

ELECTRICAL

LIGHTING

HANDLEBARS, CONTROLS & MIRRORS

CABLES

BRAKES

TANKS & OIL FILTERS

DASHES & GAUGES

FRAMES & SUSPENSION

FENDERS & LICENSE PLATE FRAMES

FOOTRESTS & FLOORBOARDS

WHEELS & AXLES

HARDWARE, COVERS & GENERAL

2330-0161

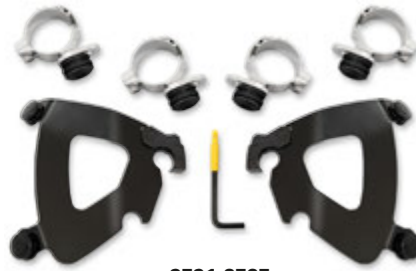

2321-0393



2321-0392



Trigger-Lock Mounts let you remove or change your Gauntlet Fairing in a moment's time

GAUNTLET FAIRINGS

- Gauntlet Fairings are unitized quarter fairings with a matte black finish inside
- Class A gloss black finish outside
- Smoked windscreen
- Trigger Lock Mounting system – on and off without tools

FITS MODEL	GAUNTLET FAIRING	TRIGGER LOCK MOUNTING KIT		PLATES ONLY KIT	
		POLISHED	BLACK	POLISHED	BLACK
15-19 Scout/Scout Sixty ¹	2330-0161	2321-0391	2321-0393	2321-0392	2321-0394
18-19 Scout Bobber ^{2,3}	2330-0161	2321-0391	2321-0393	2321-0392	2321-0394

¹ Requires turn signal relocation kit PART #2321-0374.

² Requires turn signal relocation kit PART #2020-1621.

³ Requires headlight extension block PART #2001-1827.

PART #	SUG. RETAIL	PART #	SUG. RETAIL	PART #	SUG. RETAIL
2321-0374	\$19.95	2321-0393	\$149.95	2001-1827	\$29.95
2321-0391	149.95	2321-0394	65.95	2020-1621	19.95
2321-0392	65.95	2330-0161	169.95		

2330-0162



2321-0397



2321-0396



Trigger-Lock Mounts let you remove or change your Cafe Fairing in a moment's time

CAFE FAIRINGS

- One-piece construction-machined groove outlines
- Class A gloss black finish
- Made of aircraft-grade Lucite
- Custom fit, model specific mounting kits feature Memphis Shades exclusive Trigger Lock Mounting System – on and off without tools

2330-0107



FITS MODEL	CAFE FAIRING	TRIGGER LOCK MOUNTING KIT		PLATE-ONLY KIT	
		POLISHED	BLACK	POLISHED	BLACK
15-19 Scout/Scout Sixty ¹	2330-0162	2321-0395	2321-0397	2321-0396	2321-0398
18-19 Scout Bobber ^{2,3}	2330-0107	2321-0395	2321-0397	2321-0396	2321-0398

¹ Requires turn signal relocation kit PART #2321-0374.

² Requires turn signal relocation kit PART #2020-1621.

³ Requires headlight extension block PART #2001-1827.

PART #	SUG. RETAIL	PART #	SUG. RETAIL	PART #	SUG. RETAIL
2321-0374	\$19.95	2321-0397	\$149.95	2330-0162	\$169.95
2321-0395	149.95	2321-0398	65.95	2001-1827	29.95
2321-0396	65.95	2330-0107	169.95	2020-1621	19.95

All part numbers in **BLUE** are new for 2019.



FAIRINGS

- Sturdy ABS plastic construction
- Included Plexiglass® windscreen has a smoke tint
- Available with a gloss black coated ABS finish or raw (unpainted) finish that is ready for prep and paint
- All necessary mounting hardware included
- Requires relocation of front turn signals for installation
- Made in the U.S.A.



2331-0121



2331-0122

PART #	DESCRIPTION	SUG. RETAIL	PART #	DESCRIPTION	SUG. RETAIL
FOR 15-19 SCOUT/SCOUT SIXTY			FOR 15-19 SCOUT/SCOUT SIXTY (CONT)		
2331-0121	Gloss black	\$379.95	2331-0122	Raw	\$329.95

KURYAKYN

SIGNATURE SERIES SPRINT CAFE FAIRING

- Adds a sleek, streamlined race-inspired look
- Scalloped design adds to the cafe racer appearance
- Made from injection-molded, high-impact ABS
- Unfinished surface requires minimal prep for paint
- Bolt-on installation; mount bracket and hardware included



PART #	DESCRIPTION	SUG. RETAIL
2330-0160	For 15-19 Scout/Scout Sixty	\$149.99

WINDSHIELD TRIM

- Classes up the top edge of the fairing
- Chrome ABS construction
- Easy to install



PART #	DESCRIPTION	SUG. RETAIL
2350-0276	For 14-18 Chieftain, 19 Chieftain Classic and 15-19 Roadmaster models	\$81.99

FRONT FAIRING TURN SIGNAL TRIM

- Continue the design lines from the OEM chrome fairing panel to the front turn signals
- Quick, simple peel-and-stick installation
- Sold in pairs



PART #	DESCRIPTION	SUG. RETAIL
0521-1254	For 14-18 Chieftain, 19 Chieftain Classic and 15-19 Roadmaster models	\$61.99

TAILLIGHT TOP TRIM

- Durable ABS construction
- Simple, peel-and-stick installation via high-strength adhesive
- Available in chrome or satin black finish



2010-1232

PART #	DESCRIPTION	SUG. RETAIL	PART #	DESCRIPTION	SUG. RETAIL
FOR 14-19 INDIAN MODELS (EXCEPT SCOUT)			FOR 14-19 INDIAN MODELS (EXCEPT SCOUT) (CONT)		
2010-1232	Chrome	\$30.99	2010-1343	Satin black	\$30.99

All part numbers in **BLUE** are new for 2019.

WINDSHIELDS & FAIRINGS

AUDIO, COMMUNICATION & MOUNTS

SADDLEBAGS & LUGGAGE

SEATS & SISSY BARS

EXHAUST

FUEL/AIR SYSTEMS

ENGINE

TRANSMISSION & DRIVELINE

GASKETS & SEALS

ELECTRICAL

LIGHTING

HANDLEBARS, CONTROLS & MIRRORS

CABLES

BRAKES

TANKS & OIL FILTERS

DASHES & GAUGES

FRAMES & SUSPENSION

FENDERS & LICENSE PLATE FRAMES

FOOTRESTS & FLOORBOARDS

WHEELS & AXLES

HARDWARE, COVERS & GENERAL

WINDSHIELDS & FAIRINGS

AUDIO, COMMUNICATION & MOUNTS

SADDLEBAGS & LUGGAGE

SEATS & SISSY BARS

EXHAUST

FUEL/AIR SYSTEMS

ENGINE

TRANSMISSION & DRIVELINE

GASKETS & SEALS

ELECTRICAL

LIGHTING

HANDLEBARS, CONTROLS & MIRRORS

CABLES

BRAKES

TANKS & OIL FILTERS

DASHES & GAUGES

FRAMES & SUSPENSION

FENDERS & LICENSE PLATE FRAMES

FOOTRESTS & FLOORBOARDS

WHEELS & AXLES

HARDWARE, COVERS & GENERAL

SENA



4402-0727



4402-0770



4402-0713



4402-0718



4402-0772

30K MESH INTERCOM™

- Stay connected with your group as Mesh Intercom™ technology automatically searches for and reconnects to lost and dropped signals
- Dual antennas and processors allow for simultaneous connections to 4.1 Bluetooth® and Mesh Intercom technology making it easier to connect to large groups
- Communicate with up to 16 riders at a range of 1.3 miles
- Guests can also join and listen
- With five or more riders connected, Mesh Intercom will keep the group connected at a range of up to five miles
- Connects via Bluetooth or the Sena RideConnected App
- Multitask by talking via the Mesh Intercom technology and listen to GPS navigation, phone calls or the built-in FM radio via Bluetooth connection

- Smoother listening experiences from audio that overlays instead of interrupts
- Control the headset with the optional handlebar remote, or hands-free by utilizing voice commands
- Twenty minutes of charging gives you five hours of Bluetooth intercom use or three hours of Mesh Intercom use
- Firmware upgradeable
- Dual-pack kit includes two single kits in one box

SINGLE KIT INCLUDES

- 1- Bluetooth® headset main unit
- 1- Universal helmet clamp
- 1- Wired boom microphone
- 1- Wired microphone
- 1- Hook-and-loop fastener for boom microphone
- 1- Hook-and-loop fastener for wired microphone
- 2- Microphone sponges
- 1- Glued surface mounting adapter
- 2- Foam speaker covers
- 4- Speaker pads
- 2- Hook-and-loop fasteners for speakers
- 1- Boom microphone holder
- 1- Hook-and-loop fastener for holder
- 1- 2.5 to 3.5mm audio cable
- 2- Rubber pads
- 1- Allen wrench
- 1- Speaker port cover
- 1- USB Power & Data Cable
- 1- Cigarette charger

DUAL KIT INCLUDES

- 2- Bluetooth® headset main units
- 2- Universal helmet clamps
- 2- Wired boom microphones
- 2- Wired microphones
- 2- Hook-and-loop fastener for boom microphones
- 2- Hook-and-loop fastener for wired microphones
- 4- Microphone sponges
- 2- Glued surface mounting adapters
- 4- Foam speaker covers
- 8- Speaker pads
- 4- Hook-and-loop fastners for speakers
- 2- Boom microphone holders
- 2- Hook-and-loop fasteners for holder
- 2- 2.5 to 3.5mm audio cables
- 4- Rubber pads
- 2- Allen wrenches
- 2- Speaker port covers
- 2- USB Power & Data Cables
- 2- Cigarette chargers

WiFi KIT INCLUDES

- 1- Headset main unit
- 1- Universal helmet clamp
- 1- Wired boom microphone
- 1- Wired microphone
- 1- WiFi docking station
- 1- Boom microphone holder
- 2- Microphone sponges
- 1- USB power & data cable (Micro USB type)
- 1- 2.5 to 3.5 mm audio cable
- 1- Cigarette charger
- 1- Glued surface mounting adapter
- 2- Rubber pads
- 4- Speakers pads
- 2- Hook-and-loop fasteners for speakers
- 1- Hook-and-loop fastener for boom microphone

PART #	DESCRIPTION	SUG. RETAIL	PART #	DESCRIPTION	SUG. RETAIL
4402-0727	Single kit	\$329.00	ACCESSORIES (CONT)		
4402-0728	Dual-pack kit	579.00	4402-0269	USB power cable (micro USB type)	\$3.95
4402-0770	WiFi kit	389.00	4402-0271	USB wall charger (worldwide)	14.95
ACCESSORIES			4402-0621	2.5mm male to 3.5mm male, 4 pole aux. cable	5.95
4402-0545	Bluetooth® handlebar remote	99.00	4402-0418	5V cigarette USB headset charger	19.95
4402-0634	Wristband remote	99.00	4402-0771	Clamp kit 20S EVO	94.95
4402-0713	RC3 3-button remote	49.95	4402-0772	Clamp kit slim 20 EVO	94.95
4402-0718	RC4 4-button remote	99.00	4402-0773	Slim speakers 20S EVO	41.95
4402-0417	Microphone sponges (5-pk.)	5.95			

All part numbers in **BLUE** are new for 2019.

SENA

- WINDSHIELDS & FAIRINGS
- AUDIO, COMMUNICATION & MOUNTS
- SADDLEBAGS & LUGGAGE
- SEATS & SISSY BARS
- EXHAUST
- FUEL/AIR SYSTEMS
- ENGINE
- TRANSMISSION & DRIVELINE
- GASKETS & SEALS
- ELECTRICAL
- LIGHTING
- HANDLEBARS, CONTROLS & MIRRORS
- CABLES
- BRAKES
- TANKS & OIL FILTERS
- DASHES & GAUGES
- FRAMES & SUSPENSION
- FENDERS & LICENSE PLATE FRAMES
- FOOTRESTS & FLOORBOARDS
- WHEELS & AXLES
- HARDWARE, COVERS & GENERAL



20S EVO MOTORCYCLE BLUETOOTH® COMMUNICATION SYSTEM

- State-of-the-art motorcycle and powersports Bluetooth® communication system provides a sleek and aerodynamic design that offers a versatile jog dial that maximizes the ease of use for riders
- Features Bluetooth 4.0 technology with dual Bluetooth communication modules, to create one of the most advanced Bluetooth headsets in the market; the new Bluetooth technology increases the performance and reliability of the headset while also allowing for increased high-definition audio quality
- The advanced Audio Multitasking™ allows for a seamless blend of incoming and outgoing audio to create a mixed audio experience versus the traditional interruption-based audio technology of other Bluetooth devices
- With the 20S, users can call hands-free with their Bluetooth mobile phones, listen to stereo music or voice instructions of GPS navigation by Bluetooth wirelessly, and have intercom conversations in full duplex with a passenger or other riders
- Advanced Noise Control™
- Versatile bike-to-bike conference intercom
- Intercom working distance up to 1.5 miles in open terrain
- Multipoint Bluetooth for dual mobile phone
- HD Quality crystal-clear and natural sound
- Intuitive voice prompts and commands
- Built-in FM radio tuner with a station scan-and-save function
- All-in-one helmet clamp kit
- Quick Bluetooth pairing
- Universal Intercom™: intercom with other brand communication systems
- Water-resistant for use in inclement weather
- Firmware upgradeable
- Dual kit includes two single kits in one box

SINGLE UNIT KIT INCLUDES:

- 1- Bluetooth® headset main unit
- 1- Universal helmet clamp
- 1- Wired boom microphone
- 1- Wired microphone
- 1- USB power and data cable (micro USB type)
- 1- 2.5 to 3.5mm audio cable
- 1- Cigarette charger
- 1- Glued surface mounting adapter
- 2- Rubber pads
- 2- Speaker pads
- 2- Hook-and-loop pads for speakers
- 1- Hook-and-loop pad for boom microphone
- 1- Hook-and-loop pad for wired microphone
- 1- Allen wrench (for attaching clamp kit)

PART #	DESCRIPTION	SUG. RETAIL	PART #	DESCRIPTION	SUG. RETAIL
4402-0721	20S Evo communication system	\$299.00	ACCESSORIES (CONT)		
4402-0723	20S Evo communication system, dual pack	549.00	4402-0557	Wired microphone	\$10.95
ACCESSORIES			4402-0558	Speakers	34.95
4402-0415	20S mounting accessories	7.95	4402-0621	2.5mm male to 3.5mm male, 4 pole aux. cable	5.95
4402-0417	Microphone sponges (5 pk.)	5.95	4402-0418	5V cigarette USB headset charger	19.95
4402-0555	Boom microphone	10.95	4402-0545	Handlebar remote	99.00
4402-0556	Wired boom microphone	15.95	4402-0634	Wristband remote	99.00

All part numbers in **BLUE** are new for 2019.

WINDSHIELDS & FAIRINGS

AUDIO, COMMUNICATION & MOUNTS

SADDLEBAGS & LUGGAGE

SEATS & SISSY BARS

EXHAUST

FUEL/AIR SYSTEMS

ENGINE

TRANSMISSION & DRIVELINE

GASKETS & SEALS

ELECTRICAL

LIGHTING

HANDLEBARS, CONTROLS & MIRRORS

CABLES

BRAKES

TANKS & OIL FILTERS

DASHES & GAUGES

FRAMES & SUSPENSION

FENDERS & LICENSE PLATE FRAMES

FOOTRESTS & FLOORBOARDS

WHEELS & AXLES

HARDWARE, COVERS & GENERAL



SENA 10S 4.1 BLUETOOTH® COMMUNICATION SYSTEM

- Upgraded system of the original SMH10 system
- Bluetooth® specification v4.1
- Bluetooth Intercom up to 1 mile in open terrain
- Ultra slim and light for sportbike helmets
- Four-way conference intercom through One Touch Group Intercom™
- Also uses the Universal Intercom to communicate with all Sena and non-Sena Bluetooth headsets on the market
- Simplifies connections for earbuds and microphone (wired or boom-type) by condensing them down to a single clamp connector, minimizing the number of wires and enhancing reliability
- Easy operation by versatile Jog Dial makes it effortless to operate
- Micro USB port for battery charging and future software updates
- Bluetooth music playback control: play, pause, track forward and track back
- Remarkable battery life: talk time up to 12 hours; standby time up to 10 days; can be fully charged in as little as 3 hours
- Advanced noise control for less road noise and clearer communication
- Built-in FM radio tuner with a station scan and save function
- Water-resistant for use in inclement weather
- 10S Smartphone app makes configuration a snap – change settings, set groups of intercom friends and access a Quick Guide; pair up to two mobile phones for convenient hands-free calling
- 10S Dual-Pack Kit includes two complete sets of the 10S Single Unit Kit in one box

NOTE: Do not apply any other Sena cigarette charger to the 10S main module.

10S SINGLE UNIT KIT INCLUDES:

- 1- Bluetooth® main module
- 1- Clamp unit
- 1- Microphone cap
- 2- Speakers
- 1- Wired boom microphone
- 1- Boom microphone holder
- 2- Microphone sponges
- 1- Wired microphone
- 1- USB power/data cable (micro USB type)
- 1- Stereo audio cable, 2.5mm to 3.5mm with straight type
- 1- 10S cigarette charger
- 1- Glued surface mounting adapter
- 2- Foam speaker covers
- 4- Speaker pads
- 4- Hook-and-loop fasteners for speakers
- 1- Hook-and-loop fastener for boom microphone
- 1- Hook-and-loop fastener for holder
- 1- Hook-and-loop fastener for wired microphone
- 1- Allen wrench
- 1- Owner's manual

PART #	DESCRIPTION	SUG. RETAIL	PART #	DESCRIPTION	SUG. RETAIL
4402-0635	Single unit kit (10S-01)	\$239.00	ACCESSORIES AND REPLACEMENT PARTS (CONT)		
4402-0636	Dual-pack kit (10S-01D)	439.00	4402-0657	Supplies kit	\$10.95
ACCESSORIES AND REPLACEMENT PARTS			4402-0658	Speakers	34.95
4402-0545	Handlebar remote	99.00	4402-0659	Clamp kit	69.95
4402-0634	Wristband remote	99.00	4402-0660	Stereo audio cable, 2.5mm to 3.5mm with straight type	5.90
4402-0269	USB power cable (micro USB type)	3.95	4402-0661	Wired boom microphone	15.95
4402-0271	USB wall charger (worldwide)	14.95	4402-0662	Wired microphone	7.95
4402-0197	Repl. 3.5 mm stereo audio cable	5.95	4402-0762	Helmet clamp upgrade for Bell Mag-9 helmets	69.95
4402-0417	Microphone sponges (5-pk.)	5.95			

All part numbers in **BLUE** are new for 2019.

SENA

- WINDSHIELDS & FAIRINGS
- AUDIO, COMMUNICATION & MOUNTS**
- SADDLEBAGS & LUGGAGE
- SEATS & SISSY BARS
- EXHAUST
- FUEL/AIR SYSTEMS
- ENGINE
- TRANSMISSION & DRIVELINE
- GASKETS & SEALS
- ELECTRICAL
- LIGHTING
- HANDLEBARS, CONTROLS & MIRRORS
- CABLES
- BRAKES
- TANKS & OIL FILTERS
- DASHES & GAUGES
- FRAMES & SUSPENSION
- FENDERS & LICENSE PLATE FRAMES
- FOOTRESTS & FLOORBOARDS
- WHEELS & AXLES
- HARDWARE, COVERS & GENERAL



4402-0551



4402-0552



4402-0550



4402-0553

10C BLUETOOTH® COMMUNICATION SYSTEM WITH CAMERA

- Bike-to-bike or rider-to-passenger communication
- Bluetooth® specification v4.1
- Bluetooth Intercom up to 1 mile in open terrain
- Up to 17 hours talk time, two hours recording time
- 125° field of view
- 720p/1080p video resolution
- 3.5 MP photo capability
- Micro HDMI for quick television hook-up
- Four-way conference intercom
- Conference phone call with intercom participant
- Advanced Noise Control™ and wide volume control
- Built-in FM radio with RDS AF
- Bluetooth stereo headset by A2DP
- Bluetooth music playback control by AVRCP: play, pause, track forward and track back
- Sufficient sound level with integrated audio booster
- Links up with the Sena headset app (for Android® or iPhone®), allows the wearer to configure device settings and access a quick guide
- Bluetooth hands-free for Bluetooth mobile phones
- Uses MicroSD memory cards (up to 32 GB)
- Water-resistant for use in inclement weather
- Crystal-clear and natural sound quality
- Charges via a USB power and data cable



4402-0554



4402-0653



4402-0634

BLUETOOTH® CAMERA SYSTEM INCLUDES:

- 1- Bluetooth® camera main unit
- 1- Speaker set
- 1- Wired boom microphone
- 1- Wired microphone

PART #	DESCRIPTION	SUG. RETAIL	PART #	DESCRIPTION	SUG. RETAIL
BLUETOOTH® CAMERA SYSTEM					
4402-0550	10C Bluetooth® camera system	\$349.00	ACCESSORIES AND REPLACEMENT PARTS (CONT)		
ACCESSORIES AND REPLACEMENT PARTS					
4402-0551	Mounting kit	12.95	4402-0653	Lens caps	\$3.95
4402-0552	Supplies kit	7.95	4402-0271	USB wall charger (worldwide)	14.95
4402-0553	Speaker set	29.95	4402-0623	5V cigarette charger (B-type)	19.95
4402-0554	Helmet clamp kit	39.95	4402-0654	Wired boom microphone	15.95
4402-0651	Earbud adapter split cable	12.95	4402-0545	Handlebar remote	99.00
4402-0652	Microphone sponges (5-pk.)	5.95	4402-0634	Wristband remote	99.00
			4402-0622	Straight USB cable	3.95

All part numbers in **BLUE** are new for 2019.

WINDSHIELDS & FAIRINGS

AUDIO, COMMUNICATION & MOUNTS

SADDLEBAGS & LUGGAGE

SEATS & SISSY BARS

EXHAUST

FUEL/AIR SYSTEMS

ENGINE

TRANSMISSION & DRIVELINE

GASKETS & SEALS

ELECTRICAL

LIGHTING

HANDLEBARS, CONTROLS & MIRRORS

CABLES

BRAKES

TANKS & OIL FILTERS

DASHES & GAUGES

FRAMES & SUSPENSION

FENDERS & LICENSE PLATE FRAMES

FOOTRESTS & FLOORBOARDS

WHEELS & AXLES

HARDWARE, COVERS & GENERAL



PRISM TUBE WIFI

- Record in 2K Quad HD quality
- Quad HD: 1440P 30 FPS; Full HD: 1080P 60FPS
- Two hours of recording time
- Wind noise reduction for clear voice recording
- 125° field of view and allows for spherical adjustment
- 360° lens rotation and 25° tilt
- Water resistant

PART #	DESCRIPTION	SUG. RETAIL
4402-0780	Prism Tube Wifi, Action Camera for helmet	\$199.00



4402-0781

10C PRO CAMERA

- Shoots in QHD: 1440p/30fps; 1080p/60fps; 1080p/30fps with a resolution of 3.7 MP
- 135° field of view
- Features Smart Audio Mix™
- Allows riders to take and make phone calls and listen to music and GPS
- Built-in FM tuner
- Four-way universal intercom capability to stay in touch with up to three other riders
- Bluetooth® intercom allows connectivity with other riders up to 1 mile away
- Connectivity to onbike entertainment systems
- Integrated voice prompts advise riders on use of the device with instant status updates
- Riders have the ability to link 10C Pro with Sena camera apps and headset apps (for Android® and iPhone®)
- Preview images using Sena smartphone apps directly on a smartphone through built-in WiFi



4402-0554



4402-0718

DESCRIPTION	PART #	SUG. RETAIL
MAIN PACKAGES		
10C Pro Motorcycle Bluetooth® Camera & Communication System	4402-0781	\$349.00
ACCESSORIES		
10C helmet clamp kit	4402-0554	39.95
USB power & data cable (straight micro USB type)	4402-0622	3.95
Handlebar remote for Bluetooth® communication system	4402-0545	99.00
Wristband remote for Bluetooth communication system	4402-0634	99.00
RC3, 3-button remote for Bluetooth communication system	4402-0713	49.95
RC4, 4-button remote for Bluetooth communication system	4402-0718	99.00

All part numbers in **BLUE** are new for 2019.

SENA

WINDSHIELDS & FAIRINGS

AUDIO, COMMUNICATION & MOUNTS

SADDLEBAGS & LUGGAGE

SEATS & SISSY BARS

EXHAUST

FUEL/AIR SYSTEMS

ENGINE

TRANSMISSION & DRIVELINE

GASKETS & SEALS

ELECTRICAL

LIGHTING

HANDLEBARS, CONTROLS & MIRRORS

CABLES

BRAKES

TANKS & OIL FILTERS

DASHES & GAUGES

FRAMES & SUSPENSION

FENDERS & LICENSE PLATE FRAMES

FOOTRESTS & FLOORBOARDS

WHEELS & AXLES

HARDWARE, COVERS & GENERAL



4402-0550



4402-0634



4402-0551



4402-0552



4402-0553



4402-0554



4402-0653

10C MOTORCYCLE BLUETOOTH® CAMERA & COMMUNICATION SYSTEM

- Universal fitment
- Bluetooth® 4.1
- Unibody design for Bluetooth headset and video camera
- 1080p full HD video with 3,5MP still shot camera image capture
- Video mode: 1080p: 30fps, 720p: 30/60fps
- Versatile photo mode: shot, burst and timelapse shot functions
- Video tagging
- Pitch angle adjustment, lens rotation up to 30 degrees
- Bluetooth intercom up to 1,6 km (1,0 mile) in open terrain
- Four-way intercom
- Voice prompts
- Smart Audio Mix™ to mix your voice and music into your video
- Smartphone app for iPhone® and Android®
- Advanced Noise Control™
- Universal Intercom™
- Music sharing
- Built-in FM radio tuner with a station scan-and-save function
- Easy operation by versatile Jog Dial
- Water-resistant for use in inclement weather
- Can be used while charging on road trips
- Support microSD 32GB memory card (not included)
- Firmware upgradeable

10 C SINGLE PACK INCLUDES:

- 1- Headset main unit
- 1- Clamp unit
- 1- Glued surface mounting plate
- 1- Helmet speaker
- 1- Attachable boom microphone
- 1- Boom microphone holder
- 2- Microphone sponges
- 1- Wired microphone
- 1- USB power and data cable
- 1- Cigarette charger
- 4- Speaker pads
- 2- Pair of hook-and-loop fasteners for speakers
- 1- Hook-and-loop fastener for boom microphone
- 1- Hook-and-loop fastener for wired microphone
- 1- Allen wrench
- 2- Foam speaker covers
- 1- Owner's manual

PART #	DESCRIPTION	SUG. RETAIL	PART #	DESCRIPTION	SUG. RETAIL
CAMERA AND COMMUNICATION SYSTEM			ACCESSORIES (CONT)		
4402-0550	Communication system and Bluetooth® camera combination	\$349.00	4402-0554	10 C helmet clamp kit	\$39.95
ACCESSORIES			4402-0651	Earbud adapter split cable	12.95
4402-0545	Handlebar remote	99.00	4402-0652	Microphone sponges (5-pk.)	5.95
4402-0634	Wristband remote	99.00	4402-0653	Lens caps	3.95
4402-0551	10 C mounting accessories kit	12.95	4402-0271	USB wall charger (worldwide)	14.95
4402-0552	10 C supplies kit	7.95	4402-0623	5V cigarette charger (B-type)	19.95
4402-0553	10 C speakers	29.95	4402-0654	Wired boom microphone	15.95
			4402-0622	Straight USB cable	3.95

All part numbers in **BLUE** are new for 2019.

WINDSHIELDS & FAIRINGS

AUDIO, COMMUNICATION & MOUNTS

SADDLEBAGS & LUGGAGE

SEATS & SISSY BARS

EXHAUST

FUEL/AIR SYSTEMS

ENGINE

TRANSMISSION & DRIVELINE

GASKETS & SEALS

ELECTRICAL

LIGHTING

HANDLEBARS, CONTROLS & MIRRORS

CABLES

BRAKES

TANKS & OIL FILTERS

DASHES & GAUGES

FRAMES & SUSPENSION

FENDERS & LICENSE PLATE FRAMES

FOOTRESTS & FLOORBOARDS

WHEELS & AXLES

HARDWARE, COVERS & GENERAL



4402-0251



4402-0252



4402-0191



4402-0192



3807-0157



4402-0305

SMH-10 BLUETOOTH® HEADSET/COMMUNICATOR/INTERCOM

- The Sena SMH-10 is a premium long-range Bluetooth® communication and multimedia stereo headset
- Bike-to-bike or rider-to-passenger communication
- Features hands-free calling; listen to stereo voice instructions of GPS and multi-pair four-way intercom conversations with a passenger or other riders
- Thanks to the latest Bluetooth and advanced digital processing technology, the SMH-10 offers the best sound quality for both incoming and outgoing sound in its class
- Provides sufficient sound level with integrated audio booster (even with earplugs) and individual volume control for each audio source
- Easy operation by versatile Jog Dial makes it effortless to operate
- Micro USB port for battery charging and future software updates
- Bluetooth music playback control: play, pause, track forward and track back
- Remarkable battery life: talk time of 12 hours; standby time of 10 days; can be fully charged in as little as 2.5 hours
- Intercom range of up to 980 yards in open terrain
- Water-resistant for use in inclement weather
- Firmware upgradable
- Dual kit includes two single kits in one box

SINGLE UNIT KIT INCLUDES:

- 1- Bluetooth® main module
- 1- Speaker-microphone helmet clamp kit
- 1- Glued surface mounting adapter
- 1- 12-volt cigarette lighter charger
- 1- USB cable
- 1- 3.5mm stereo audio cable (for connecting non-Bluetooth audio devices)
- 2- Microphone sponges
- 2- Hook-and-loop speaker mounting pads
- 1- 3mm Allen wrench (for attaching clamp kit)
- 1- Owner's manual

DUAL-KIT INCLUDES:

- 2- Bluetooth® main modules
- 2- Speaker-microphone helmet clamp kits
- 2- Glued surface mounting adapters
- 2- 12-volt cigarette lighter chargers
- 2- USB cables
- 2- 3.5mm stereo audio cables (for connecting non-Bluetooth audio devices)
- 4- Microphone sponges
- 4- Hook-and-loop speaker mounting pads
- 2- 3mm Allen wrenches (for attaching clamp kit)
- 1- Owner's manual

PART #	DESCRIPTION	SUG. RETAIL
HEADSETS/INTERCOM KITS		
4402-0251	Bluetooth® headset/intercom (single unit) (SMH10-10)	\$209.00
4402-0252	Bluetooth headset/intercom (single unit w/ universal microphone) (SMH10-11)	219.00
4402-0253	Bluetooth headset/intercom (dual pack) (SMH10D-10)	379.00
4402-0254	Bluetooth® headset/intercom (dual pack w/ universal microphones) (SMH10D-11)	399.00
ACCESSORIES		
4402-0255	Repl. Bluetooth® headset/intercom	149.00
4402-0190	Repl. helmet clamp with boom mic	39.95
4402-0191	Optional helmet clamp with wired mic and boom mic	39.95
4402-0192	Optional helmet clamp kit for earbud with boom mic	39.95
4402-0193	Optional helmet clamp kit for earbud with wired and boom mic	39.95

PART #	DESCRIPTION	SUG. RETAIL
ACCESSORIES (CONT)		
4402-0195	Repl. USB cable	\$3.95
4402-0196	Repl. cigarette charger	5.95
3807-0157	Cigarette charger (Micro USB type) with on/off control by ignition switch	7.95
4402-0197	Repl. 3.5mm stereo audio cable	5.95
4402-0198	Repl. mounting accessories	7.95
4402-0199	Repl. backplate for speaker microphone clamp	5.95
4402-0304	Helmet clamp kit (for speakers and earbuds)	59.95
4402-0305	Helmet clamp kit (for speakers and earbuds w/ attachable boom mic or wired mic)	59.95
4402-0623	Cigarette charger	19.95
4402-0628	Micro sponges	5.95

All part numbers in **BLUE** are new for 2019.

SENA

**SENA SMH-10R BLUETOOTH® STEREO HEADSET/COMMUNICATOR/INTERCOM**

- Bike-to-bike or rider-to-passenger communication
- Bluetooth® Intercom up to 980 yards in open terrain
- Ultra slim and light for sportbike helmets
- Four-way conference intercom
- Conference phone call with intercom participant
- Multi-point for mobile phone and GPS
- Voice prompts
- Bluetooth stereo headset by A2DP
- Bluetooth music playback control by AVRCP: play, pause, track forward and track back
- Sufficient sound level with integrated audio booster
- Bluetooth hands-free for Bluetooth mobile phones
- Bluetooth headset or stereo headset for Bluetooth GPS navigation
- Water-resistant for use in inclement weather
- Crystal clear and natural sound quality
- Up to eight hours talk time, seven days standby time
- Can be used while charging on road trips
- Individual volume control for each audio source
- Firmware upgradable
- External battery can easily be swapped out or replaced

SMH-10R-01 (SINGLE) KIT INCLUDES:

- 1- Headset main unit
- 1- Attachable boom microphone
- 1- Wired microphone
- 1- USB power and data cable
- 1- Cigarette charger
- 1- Owner's manual
- 1- Battery pack
- 1- Battery charger adapter
- 1- Large helmet speaker
- 2- Speaker pads
- 2- Microphone sponges
- 1- Hook-and-loop pad for boom microphone
- 2- Hook-and-loop pads for main unit
- 2- Double-sided adhesive tape for main unit
- 1- Hook-and-loop pad for battery pack

SMH-10RD-01 (DUAL) KIT INCLUDES:

- 2- Headset main units
- 2- Attachable boom microphones
- 2- Wired microphones
- 2- USB power and data cables
- 2- Cigarette chargers
- 2- Owner's manual
- 2- Battery packs
- 2- Battery charger adapters
- 2- Large helmet speakers
- 4- Speaker pads
- 4- Microphone sponges
- 2- Hook-and-loop pads for boom microphone
- 4- Hook-and-loop pads for main unit
- 4- Double-sided adhesive tape for main unit
- 2- Hook-and-loop pads for battery pack

PART #	DESCRIPTION	SUG. RETAIL
BLUETOOTH® HEADSET/INTERCOMS		
4402-0677	10R-01 (single)	\$239.00
ACCESSORIES AND REPLACEMENT PARTS		
4402-0196	Repl. cigarette charger	5.95
4402-0195	Repl. USB cable	3.95

PART #	DESCRIPTION	SUG. RETAIL
ACCESSORIES AND REPLACEMENT PARTS (CONT)		
4402-0271	Micro USB wall charger	\$14.95
4402-0628	Microphone sponges for SMH10 (5 pc.)	5.95
4402-0678	Ear bud splitter for 10R-01	12.95

All part numbers in **BLUE** are new for 2019.WINDSHIELDS
& FAIRINGSAUDIO,
COMMUNICATION
& MOUNTSSADDLEBAGS
& LUGGAGESEATS &
SISSY BARS

EXHAUST

FUEL/AIR
SYSTEMS

ENGINE

TRANSMISSION
& DRIVELINEGASKETS
& SEALS

ELECTRICAL

LIGHTING

HANDLEBARS,
CONTROLS
& MIRRORS

CABLES

BRAKES

TANKS &
OIL FILTERSDASHES
& GAUGESFRAMES &
SUSPENSIONFENDERS
& LICENSE
PLATE FRAMESFOOTRESTS &
FLOORBOARDSWHEELS
& AXLESHARDWARE,
COVERS &
GENERAL

WINDSHIELDS & FAIRINGS

AUDIO, COMMUNICATION & MOUNTS

SADDLEBAGS & LUGGAGE

SEATS & SISSY BARS

EXHAUST

FUEL/AIR SYSTEMS

ENGINE

TRANSMISSION & DRIVELINE

GASKETS & SEALS

ELECTRICAL

LIGHTING

HANDLEBARS, CONTROLS & MIRRORS

CABLES

BRAKES

TANKS & OIL FILTERS

DASHES & GAUGES

FRAMES & SUSPENSION

FENDERS & LICENSE PLATE FRAMES

FOOTRESTS & FLOORBOARDS

WHEELS & AXLES

HARDWARE, COVERS & GENERAL



SENA 10R LOW-PROFILE BLUETOOTH® COMMUNICATION SYSTEM

- Lightweight and ultra-slim design for nearly any size helmet
- Bluetooth® specification v4.1
- Bluetooth Intercom up to 980 yards in open terrain
- OPTIONAL Bluetooth handlebar remote puts the controls where the rider can easily see and use them; fully functional while wearing gloves
- Four-way conference intercom
- Also uses the Universal Intercom™ to communicate with all Sena and non-Sena Bluetooth headsets on the market
- Voice prompts
- Bluetooth stereo headset by A2DP
- Bluetooth music playback control by AVRCP: play, pause, track forward and track back
- Sufficient sound level with integrated audio booster
- Bluetooth hands-free for Bluetooth mobile phones
- Bluetooth headset or stereo headset for Bluetooth GPS navigation

- Water-resistant for use in inclement weather
- Advanced Noise Control™
- Music sharing allows talk or share playlists with the four-way intercom function
- Built-in FM radio tuner with a station scan and save function
- Up to 10 hours talk time, seven days stand-by time
- Can be used while charging on road trips
- Individual volume control for each audio source
- Firmware upgradeable
- 10S Smartphone app makes configuration a snap – change settings, set groups of intercom friends and access a Quick Guide; pair up to two mobile phones for convenient hands-free calling
- Dual kit includes two single kits in one box

NOTE: DO NOT apply any other Sena cigarette charger to the 10R main module.

SINGLE KIT INCLUDES:

- 1- Bluetooth® main module
- 2- Handlebar rubber bands
- 2- Hook-and-loop fasteners for main unit
- 2- Double-sided adhesive tape for main unit
- 2- Speakers
- 2- Foam speaker covers
- 4- Speaker pads
- 4- Hook-and-loop fasteners for speakers
- 1- Wired boom microphone
- 1- Wired microphone
- 1- Hook-and-loop fastener for boom microphone

- 1- Boom microphone holder
- 1- Hook-and-loop fastener for holder
- 1- Hook-and-loop fastener for wired microphone
- 2- Microphone sponges
- 1- Battery pack
- 1- Battery pack holder
- 1- Double-sided adhesive tape for battery pack holder
- 1- USB power/data cable (micro USB type)
- 1- 10R cigarette charger
- 1- Owner's manual

PART #	DESCRIPTION	SUG. RETAIL	PART #	DESCRIPTION	SUG. RETAIL
4402-0677	10R Low-profile communication system, single kit	\$239.00	REPLACEMENT PARTS AND ACCESSORIES (CONT)		
4402-0637	10R Communication system with remote	299.00	4402-0545	Handlebar remote	\$99.00
4402-0714	10R Communication system, dual pack	439.00	4402-0634	Wristband remote	99.00
REPLACEMENT PARTS AND ACCESSORIES			4402-0269	USB power cable (micro USB type)	3.95
4402-0638	Supplies kit	6.95	4402-0271	USB wall charger (worldwide)	14.95
4402-0639	Speaker	34.95	4402-0417	Microphone sponges (5-pk.)	5.95
4402-0640	Wired boom microphone	15.95	4402-0730	10R battery pack	34.95
4402-0641	Wired microphone	7.95	4402-0678	Earbud splitter for 10R-01	12.95

All part numbers in **BLUE** are new for 2019.



- WINDSHIELDS & FAIRINGS
- AUDIO, COMMUNICATION & MOUNTS
- SADDLEBAGS & LUGGAGE
- SEATS & SISSY BARS
- EXHAUST
- FUEL/AIR SYSTEMS
- ENGINE
- TRANSMISSION & DRIVELINE
- GASKETS & SEALS
- ELECTRICAL
- LIGHTING
- HANDLEBARS, CONTROLS & MIRRORS
- CABLES
- BRAKES
- TANKS & OIL FILTERS
- DASHES & GAUGES
- FRAMES & SUSPENSION
- FENDERS & LICENSE PLATE FRAMES
- FOOTRESTS & FLOORBOARDS
- WHEELS & AXLES
- HARDWARE, COVERS & GENERAL

SENA

SENA 3S BLUETOOTH® WIRED BOOM MICROPHONE KIT

- Simple solution for superior communication with a simple design
- Features Bluetooth® 3.0 technology
- Delivers outstanding audio performance for incoming/outgoing calls, music, GPS directions and intercom conversations up to 220 yards away
- Unique unibody design integrates all components – main unit, control panel, speakers and microphone – into a single piece for quick and easy installation
- Two-button controls work with both boom and wired mic, which make it easy to adjust settings on the fly
- Advanced Noise Control™
- Eight hours of talk time and seven days of stand-by time with a single charge; 2.5 hour charging time
- Firmware upgradeable
- Speaker measures: 39.9 mm x 39.9 mm x 11.3 mm (1.6 in x 1.6 in x 0.4 in)

3S HEADSET AND INTERCOM INCLUDES:

- 1- 3S headset
- 1- USB power and data cable (micro USB type)
- 1- Attachable boom microphone
- 2- Hook-and-loop fasteners for speakers
- 2- Microphone sponges
- 1- Owner's manual

PART #	DESCRIPTION	SUG. RETAIL
MICROPHONE KITS		
4402-0642	3S Wired boom microphone kit	\$99.00
4402-0737	3S Boom microphone kit	99.00
4402-0738	3S Wired microphone kit	99.00
REPLACEMENT PARTS AND ACCESSORIES		
4402-0643	3S supply kit	3.95

PART #	DESCRIPTION	SUG. RETAIL
REPLACEMENT PARTS AND ACCESSORIES (CONT)		
4402-0269	USB power cable (micro USB type)	\$3.95
4402-0270	Cigarette charger (micro USB type)	5.95
4402-0271	Worldwide USB wall charger (micro USB type)	14.95
4402-0417	Microphone sponges (5 pk.)	5.95



4402-0739



4402-0283



SENA SPH10H-FM-01 HALF-HELMET BLUETOOTH® STEREO HEADSET/COMMUNICATOR/INTERCOM

- Simple earpad design for quick installation to half helmets
- Bluetooth® intercom up to 760 yards
- Four-way conference intercom
- Conference phone call with intercom participant
- Multipoint for two mobile phones
- Built-in FM radio tuner with station scan/save function
- Voice prompts
- Bluetooth stereo headset for Bluetooth audio devices such as MP3 players
- Bluetooth music playback control by AVRCP: play, pause, track forward and track back
- Easy operation by versatile Jog Dial

- Sufficient sound level with integrated audio booster
- Bluetooth hands-free for Bluetooth mobile phones
- Bluetooth headset or stereo headset for Bluetooth GPS navigation
- Water-resistant for use in inclement weather
- Crystal-clear and natural sound quality
- Up to seven hours talk time, eight days stand-by time
- Individual volume control for each audio source
- Firmware upgradeable
- Dual kit includes two single kits in one box

SPH10H-FM-01 KIT INCLUDES:

- 1- SPH10H-FM main unit
- 1- Snapfit earpad
- 1- USB power and data cable
- 1- Cigarette charger

PART #	DESCRIPTION	SUG. RETAIL
HEADSETS		
4402-0739	Headset/intercom w/o built-in FM tuner, single kit	\$199.00
4402-0283	Headset/intercom w/ built-in FM tuner, single kit	219.00
4402-0732	Headset/intercom w/ built-in FM tuner, dual kit	399.00
ACCESSORIES		
4402-0269	USB power cable (micro USB type)	3.95
4402-0201	Stereo audio cable, 2.5mm to 3.5mm	5.95
4402-0270	Cigarette charger (micro USB type)	5.95

PART #	DESCRIPTION	SUG. RETAIL
ACCESSORIES (CONT)		
4402-0271	USB wall charger (world wide)	\$14.95
4402-0740	Supplies kit (includes earpads, earpad sponges, and four microphone sponges)	12.95
4402-0741	Microphone sponges (10 ct.)	5.95
4402-0742	Microphones (includes large and small microphones and mic sponges)	19.95

All part numbers in **BLUE** are new for 2019.

- WINDSHIELDS & MOUNTS
- AUDIO, COMMUNICATION & MOUNTS
- SADDLEBAGS & LUGGAGE
- SEAT & Sissy Pads
- ENGINE
- TRANSMISSION & DRIVELINE
- GASKETS & SEALS
- ELECTRICAL
- LIGHTING
- HANDLEBARS, CONTROLS & MIRRORS
- CABLES
- BRAKES
- TANKS & OIL FILTERS
- DASHES & GAUGES
- FRAMES & SUSPENSION
- FENDERS & LICENSE PLATE FRAMES
- FOOTRESTS & FLOORBOARDS
- WHEELS & AXLES
- HARDWARE, COVERS & GENERAL

SENA



4402-0238



4402-0240



4402-0301



4402-0303



4402-0633

SENA SMH-5 BLUETOOTH® STEREO HEADSET/COMMUNICATOR/INTERCOM

- Bike-to-bike or rider-to-passenger communication
- Available with boom microphones for open-face helmets or with wired microphones for full-face helmets
- Bluetooth® Intercom up to 430 yards in open terrain
- Multi-pair Bluetooth intercom
- Voice prompts
- Bluetooth stereo headset by A2DP
- Bluetooth music playback control by AVRCP: play, pause, track forward and track back
- Easy operation by versatile Jog Dial
- Sufficient sound level with integrated audio booster
- Bluetooth hands-free for Bluetooth mobile phones
- Bluetooth headset or stereo headset for Bluetooth GPS navigation
- Water-resistant for use in inclement weather
- Crystal clear and natural sound quality
- Up to eight hours talk time, seven days standby time
- Can be used while charging on road trips
- Individual volume control for each audio source
- Firmware upgradable

SMH-5 SINGLE UNIT KIT INCLUDES:

- 1- Headset main unit
- 1- Clamp unit
- 1- Attachable boom microphone or wired microphone
- 1- USB power and data cable
- 1- Hook-and-loop surface mounting plate
- 1- Hook-and-loop pad for boom microphone
- 1- Attachable boom microphone holder
- 1- Allen wrench
- 1- Owner's manual
- 2- Microphone sponges
- 2- Hook-and-loop pads for speakers
- 2- Speaker pads
- 2- Helmet speakers

SMH-5 DUAL-PACK KIT INCLUDES:

- 1- Owner's manual
- 2- Headset main units
- 2- Clamp units
- 2- Attachable boom microphones or wired microphones
- 2- USB power and data cables
- 2- Glued surface mounting plates
- 2- Hook-and-loop pads for boom microphones
- 2- Attachable boom microphone holders
- 2- Allen wrenches
- 4- Microphone sponges
- 4- Hook-and-loop pads for speakers
- 4- Speaker pads
- 4- Helmet speakers

PART #	DESCRIPTION	SUG. RETAIL	PART #	DESCRIPTION	SUG. RETAIL
BLUETOOTH® HEADSET/INTERCOMS			ACCESSORIES AND REPLACEMENT PARTS (CONT)		
4402-0632	Single unit	\$129.00	4402-0195	Repl. USB cable	\$3.95
4402-0630	Dual pack	249.00	4402-0301	Large speakers with locking-type connector	24.95
ACCESSORIES AND REPLACEMENT PARTS			4402-0303	Helmet clamp kit	39.95
4402-0271	World wide USB wall charger (micro USB type)	14.95	4402-0633	Half helmet earpads	79.00
4402-0238	Mounting kit	5.95	4405-0313	Slim speakers	24.95
4402-0239	Supplies kit	6.95	4404-0004	SMH5 Replacement boom microphone	15.95
4402-0240	Boom mic helmet clamp kit	39.95	4404-0005	SMH5 Replacement wire microphone	7.95
4402-0196	Repl. cigarette charger (micro USB type)	5.95			

SMH5 MULTICOM QUICK MOUNT

- Designed to easily snap on and off user's helmets
- Quick clamp allows unit to be quickly installed and transferred between helmets
- Four-way intercom keeps you connected to other riders
- Bluetooth® specification v3.0
- Working distance: up to 700 meters (760 yards) in open terrain
- Advance Noise Control™ reduces ambient noise

PART #	DESCRIPTION	SUG. RETAIL
4402-0724	SMH5 Multicom quick mount	\$129.00



All part numbers in **BLUE** are new for 2019.

SENA



4402-0631



4402-0301



4402-0303



4402-0240



4405-0313

SENA SMH5-FM BLUETOOTH® STEREO HEADSET/COMMUNICATOR/INTERCOM WITH FM RADIO

- Designed specifically for motorcycles
- Bike-to-bike or rider-to-passenger communication
- Available with boom microphones for open-face helmets or with wired microphones for full-face helmets
- Bluetooth® Intercom up to 760 yards in open terrain
- Built-in FM radio tuner with station scan-and-save function
- Multi-pair Bluetooth intercom
- Voice prompts
- Bluetooth stereo headset by A2DP
- Bluetooth music playback control by AVRCP: play, pause, track forward and track back
- Easy operation by versatile Jog Dial
- Sufficient sound level with integrated audio booster
- Bluetooth hands-free for Bluetooth mobile phones
- Bluetooth headset or stereo headset for Bluetooth GPS navigation
- Water-resistant for use in inclement weather
- Crystal clear and natural sound quality
- Up to seven hours talk time, six days standby time
- Can be used while charging on road trips
- Individual volume control for each audio source
- Firmware upgradeable
- Dual kit includes two single kits in one box

SINGLE SMH5-FM BOOM MIC INCLUDES:

- 1- Headset main unit
- 1- Clamp unit
- 1- Attachable boom microphone
- 1- USB power and data cable
- 1- Hook-and-loop surface mounting plate
- 1- Hook-and-loop pad for boom microphone
- 1- Attachable boom microphone holder
- 1- Allen wrench
- 1- Owner's manual
- 2- Microphone sponges
- 2- Hook-and-loop pads for speakers
- 2- Speaker pads
- 2- Helmet speakers

DUAL SMH5-FM BOOM MIC INCLUDES:

- Two complete sets of the SMH5-FM in a single box

PART #	DESCRIPTION	SUG. RETAIL
BLUETOOTH® HEADSET/INTERCOMS		
4402-0631	Single unit	\$159.00
4402-0629	Dual pack	299.00
ACCESSORIES AND REPLACEMENT PARTS		
4402-0301	Large speakers w/ locking connectors	24.95
4402-0271	World wide USB wall charger (micro USB type)	14.95
4402-0238	Mounting kit	5.95
4402-0239	Supplies kit	6.95

PART #	DESCRIPTION	SUG. RETAIL
ACCESSORIES AND REPLACEMENT PARTS (CONT)		
4402-0240	Boom mic helmet clamp kit	\$39.95
4402-0196	Repl. cigarette charger (micro USB type)	5.95
4402-0195	Repl. USB cable	3.95
4402-0303	Helmet clamp kit w/ locking connector (for wired mic)	39.95
4404-0004	Repl. boom mic	15.95
4404-0005	Repl. wired mic	7.95
4405-0313	Slim speakers	24.95



4402-0759



4402-0760



4402-0761

SF SERIES HEADSETS

SF1

- 13 hours of talk time
- Perfect set of features for those who ride solo
- Bluetooth® connection to MP3, GPS or smartphone

SF2

- 13 hours of talk time
- Bluetooth® connection to MP3, GPS or smartphone
- Two-way intercom communication with passenger

- Range of up to 220 yards
- Audio overlay feature allows rider to listen to music and use intercom simultaneously

SF4

- 13 hours of talk time
- Bluetooth® connection to MP3, GPS or smartphone
- Connect up to 8 other intercoms

- Features a four-way intercom at a range of up to .8 miles
- Audio overlay feature allows rider to listen to music and use intercom simultaneously

PART #	DESCRIPTION	SUG. RETAIL	PART #	DESCRIPTION	SUG. RETAIL	PART #	DESCRIPTION	SUG. RETAIL
4402-0759	SF1	\$139.00	4402-0760	SF2	\$159.00	4402-0761	SF4	\$219.00

All part numbers in **BLUE** are new for 2019.

WINDSHIELDS & FAIRINGS

AUDIO, COMMUNICATION & MOUNTS

SADDLEBAGS & LUGGAGE

SEATS & SISSY BARS

EXHAUST

FUEL/AIR SYSTEMS

ENGINE

TRANSMISSION & DRIVELINE

GASKETS & SEALS

ELECTRICAL

LIGHTING

HANDLEBARS, CONTROLS & MIRRORS

CABLES

BRAKES

TANKS & OIL FILTERS

DASHES & GAUGES

FRAMES & SUSPENSION

FENDERS & LICENSE PLATE FRAMES

FOOTRESTS & FLOORBOARDS

WHEELS & AXLES

HARDWARE, COVERS & GENERAL

SENA

WINDSHIELDS & FAIRINGS

AUDIO, COMMUNICATION & MOUNTS

SADDLEBAGS & LUGGAGE

SEATS & SISSY BARS

EXHAUST

FUEL/AIR SYSTEMS

ENGINE

TRANSMISSION & DRIVELINE

GASKETS & SEALS

ELECTRICAL

LIGHTING

HANDLEBARS, CONTROLS & MIRRORS

CABLES

BRAKES

TANKS & OIL FILTERS

DASHES & GAUGES

FRAMES & SUSPENSION

FENDERS & LICENSE PLATE FRAMES

FOOTRESTS & FLOORBOARDS

WHEELS & AXLES

HARDWARE, COVERS & GENERAL



4402-0766



4402-0767



4402-0768



4402-0769

4402-0634

4402-0270

SENA 10U SHOEI®/ARAI® BLUETOOTH® STEREO HEADSET/COMMUNICATOR/INTERCOM

- Bike-to-bike or rider-to-passenger communication
- Bluetooth® specification v4.1
- Bluetooth Intercom up to 1.6 kilometers (1 mile) in open terrain
- Ultra-slim and light to fit two specific Shoei® brand sportbike helmets
- Four-way conference intercom
- Conference phone call with intercom participant
- Multi-point for mobile phone and GPS
- Voice prompts
- Advanced noise control and wide volume control™
- Built-in FM radio with RDS AF
- Bluetooth stereo headset by A2DP
- Bluetooth music playback control by AVRCP: play, pause, track forward and track back
- Sufficient sound level with integrated audio booster
- Bluetooth hands-free for Bluetooth mobile phones

- Bluetooth headset or stereo headset for Bluetooth GPS navigations
- Links up with the Sena headset app (for Android® or iPhone®), allows the wearer to configure device settings and access a quick guide
- Water-resistant for use in inclement weather
- Crystal-clear and natural sound quality
- Up to 10 hours talk time, seven days stand-by time
- Charges via a USB power and data cable

10U SHOEI®/ARAI® SPORTBIKE KIT INCLUDES:

- 1- Headset main unit
- 1- Handlebar remote
- 2- Foam speaker snap holders
- 2- Handlebar rubber bands
- 1- USB power and data cable (micro USB type)
- 1- Owner's manual

PART #	DESCRIPTION	SUG. RETAIL
BLUETOOTH® HEADSET/INTERCOMS		
4402-0766	10U for Shoei® GT-Air helmet	\$299.00
4402-0767	10U for Shoei Neotec helmet	299.00
4402-0768	10U for Shoei® J-Cruise helmet	299.00
4402-0769	10U Arai communication system, for full-face helmets	299.00

PART #	DESCRIPTION	SUG. RETAIL
ACCESSORIES AND REPLACEMENT PARTS		
4402-0545	Handlebar remote	\$99.00
4402-0634	Wristband remote	99.00
4402-0270	Cigarette charger (micro USB)	5.95
4402-0269	USB power cable (micro USB)	3.95
4402-0271	USB charger (worldwide)	14.95

All part numbers in **BLUE** are new for 2019.



20S CB/AUDIO HELMET CLAMP KIT

- Communicate with the CB radio built into the onboard audio system using the clamp kit's microphones
- All sounds from the onboard audio system (GPS, CB, FM radio) can be mixed with 20S sound sources (Intercom, MP3 Music, phone etc.)
- Can be used with 20S main module
- Without the 20S main module you can attach the helmet clamp with the clamp cover adapter and only use CD radio and onboard audio systems

PART #	DESCRIPTION	SUG. RETAIL
4402-0716	20S Helmet clamp kit for Harley-Davidson®	\$129.00



4402-0545



4402-0713



4402-0718



4402-0634

RC REMOTES

- Works over 10-meter distance
- Compatible with 30K, 20S, 10U, 10C, 10R, and 10S communication systems
- 4.1 Bluetooth® connection
- Water-resistant
- Three- or four-button remote for Bluetooth communication system

HANDLEBAR REMOTE

- Easily clamps to handlebars of almost any size
- Allows rider to safely manipulate controls without removing hands from the handlebar
- Features a small joystick and easy to reach buttons
- Charges via USB

RC 3 BUTTON REMOTE

- Clips onto the rider's sleeve or mounts to motorcycle body
- Five-month battery life

PART #	DESCRIPTION	SUG. RETAIL
4402-0545	Handlebar Remote	\$99.00
4402-0713	RC3 3-Button Remote	49.95

RC 4 BUTTON REMOTE

- Clamps to handlebars of almost any size
- Four buttons that are easily manipulated by gloved hands
- Five-month battery life

WRISTBAND REMOTE

- Glove friendly joystick and buttons for easy manipulation
- Charges via USB with a seven-month battery life

PART #	DESCRIPTION	SUG. RETAIL
4402-0718	RC4 4-Button Remote	\$99.00
4402-0634	Wristband Remote	99.00

All part numbers in **BLUE** are new for 2019.

WINDSHIELDS & FAIRINGS

AUDIO, COMMUNICATION & MOUNTS

SADDLEBAGS & LUGGAGE

SEATS & SISSY BARS

EXHAUST

FUEL/AIR SYSTEMS

ENGINE

TRANSMISSION & DRIVELINE

GASKETS & SEALS

ELECTRICAL

LIGHTING

HANDLEBARS, CONTROLS & MIRRORS

CABLES

BRAKES

TANKS & OIL FILTERS

DASHES & GAUGES

FRAMES & SUSPENSION

FENDERS & LICENSE PLATE FRAMES

FOOTRESTS & FLOORBOARDS

WHEELS & AXLES

HARDWARE, COVERS & GENERAL



4402-0259

SENA SR-10 TWO-WAY RADIO ADAPTER

- The Sena SR-10 is a Bluetooth® Class 1 radio adapter
- You can connect various two-way radio devices by using the SR-10 and talk wirelessly using Bluetooth® headsets
- The SR-10 has two AUX ports that enable you to connect non-Bluetooth devices such as a radar detector or GPS navigation system
- You can talk by phone or two-way radios at the same time
- Hands-free for Bluetooth® mobile phones
- Supports a variety of two-way radios: Kenwood, Motorola, Icom, Yaesu and Midland
- Supports both handlebar mounting kits and mounting clips
- Supports wired PTT button
- Water-resistant for use in inclement weather
- 12 hours of talk time; 10 days of stand-by time

SENA SR-10 KIT INCLUDES:

- 1- Bluetooth main module
- 1- DC power charger
- 1- USB power cable
- 1- 3.5mm stereo audio cable (for connecting non-Bluetooth audio devices)
- 1- Wired PTT button
- 1- Mounting kit
- 1- Clip kit

PART #	DESCRIPTION	SUG. RETAIL
RADIO ADAPTER		
4402-0259	SR-10 2-way adapter	\$199.00
ACCESSORIES		
4402-0306	SR10 supplies kit (belt clip and handlebar mount)	13.95
4402-0307	Wired PTT button	14.95
4402-0308	Extension cable (for wired PTT button PART #4402-0307)	5.95
4402-0205	Kenwood twin-pin radio cable	19.95
4402-0206	Motorola twin-pin radio cable	19.95
4402-0207	Motorola single-pin radio cable	19.95

PART #	DESCRIPTION	SUG. RETAIL
ACCESSORIES (CONT)		
4402-0208	Icom twin-pin radio cable	\$19.95
4402-0209	Yaesu single-pin radio cable	19.95
4402-0210	Midland twin-pin radio cable	19.95
4402-0246	Two-way radio cable w/ open end	19.95
4402-0247	Two-way radio cable for Midland or Icom straight twin-pin connector	19.95
3807-0157	Cigarette lighter port charger	7.95

SM10 DUAL STREAM BLUETOOTH® STEREO TRANSMITTER

- Bluetooth® stereo audio adapter based on Bluetooth 2.1+EDR technology
- Connect various audio devices such as mobile phone or MP3 player by using the SM10
- It also supports onboard audio systems of specific brands by using optional audio cables
- Along with the dual streaming feature of SM10, both you and your passenger may listen to the same music or radio at the same time by using Bluetooth headsets on the market
- The SM10 has AUX audio input that enables you to connect additional non-Bluetooth audio devices such as radar/laser detector or GPS navigation
- Water-resistant for use in inclement weather
- Firmware upgradeable
- Talk time: 8 hours
- Stand-by time: 3 days
- 3.3" x 1.8" x 1.0"
- Two 3.5mm jack ports
- Lithium polymer battery; charging time: 3 hours
- Sold in a kit that includes Dual Stream Bluetooth Stereo Transmitter Main Unit, handlebar mounting kit, mounting cradle, USB power and data cable, 3.5mm 3-pole stereo audio cable, 3.5mm 4-pole stereo audio cable and cigarette charger



4402-0250

PART #	DESCRIPTION	SUG. RETAIL
BLUETOOTH® STEREO TRANSMITTER		
4402-0250	Dual Stream Bluetooth® Stereo Transmitter	\$149.00
OPTIONAL AUDIO CABLES		
4402-0298	SM10 supplies kit (mounting cradle and belt cradle)	8.95

PART #	DESCRIPTION	SUG. RETAIL
OPTIONAL AUDIO CABLES (CONT)		
4402-0291	3.5mm stereo jack to 5-pin DIN cable for Yamaha 83-13, H-D/Kawasaki/Suzuki 89-97	\$24.95
4402-0245	3.5mm stereo audio straight connector	5.95

All part numbers in **BLUE** are new for 2019.

SENA

- WINDSHIELDS & FAIRINGS
- AUDIO, COMMUNICATION & MOUNTS
- SADDLEBAGS & LUGGAGE
- SEATS & SISSY BARS
- EXHAUST
- FUEL/AIR SYSTEMS
- ENGINE
- TRANSMISSION & DRIVELINE
- GASKETS & SEALS
- ELECTRICAL
- LIGHTING
- HANDLEBARS, CONTROLS & MIRRORS
- CABLES
- BRAKES
- TANKS & OIL FILTERS
- DASHES & GAUGES
- FRAMES & SUSPENSION
- FENDERS & LICENSE PLATE FRAMES
- FOOTRESTS & FLOORBOARDS
- WHEELS & AXLES
- HARDWARE, COVERS & GENERAL

10U PAD COMMUNICATION SYSTEM

- Fits into the cheek pads of the HJC® IS-17 and IS-MAX2 helmets
- Up to 10 hours talk time, seven days stand-by time
- Bluetooth® specification v4.1
- Four-way conference intercom
- Conference phone call with intercom participant
- Simple snap-in design
- Advanced Noise Control™ and wide volume control
- Working distance of up to 900 meters
- Bluetooth stereo headset by A2DP
- Bluetooth music playback control by AVRCP: play, pause, track forward and track back
- Built-in FM radio with RDS AF



4402-0733



4402-0763

PART #	DESCRIPTION	SUG. RETAIL	PART #	DESCRIPTION	SUG. RETAIL
4402-0733	For HJC® IS-17	\$199.00	4402-0763	For HJC® IS-MAX2	\$199.00

EXPAND BLUETOOTH® INTERCOM AND STEREO SYSTEM

- Advanced noise control boosts volume in noisy environments
- Make phone calls, talk over the intercom or share music within a 900-meter range
- Water-and-sweat resistant
- Universal intercom allows you to connect to other non-Sena devices
- Voice commands allow for hands-free operation
- Up to 10 hours talk time, seven days standby time
- Can be used while charging
- Firmware upgradeable
- Playback control



4402-0743



4402-0744

PART #	DESCRIPTION	SUG. RETAIL
4402-0743	Expand headset	\$169.00
4402-0744	Accessories kit (earphone and microphone foam)	\$14.95

FREEWIRE ADAPTER

- Wirelessly connect to your bike's infotainment system, GPS, or communicate via CB radio
- Use an additional Freewire to communicate with a passenger
- Seven hours of talk time
- 3 1/4" x 8" x 1"
- CE, FCC, IC-certified



4402-0703



4402-0706



4402-0708

PART #	DESCRIPTION	SUG. RETAIL	PART #	DESCRIPTION	SUG. RETAIL
4402-0703	Freewire Harley-Davidson	\$249.00	4402-0706	Micro USB CBL 7 pin Harley-Davidson	\$39.95
4402-0705	Freewire supplies kit	8.95	4402-0708	Cigarette lighter port charger 5V Jack	14.95

POWERPRO CHARGING MOUNT

- Charge and use your smartphone at the same time
- Micro USB port allows for a variety of devices to be charged
- One charge of the PowerPro can charge most iPhones® approximately 5 times
- Ball joint allows user to position device in whatever position they need
- Water resistant
- 5V 2A output
- 6.5 hour charge time with a 10,000mAh capacity



Shown with armband



Shown with handlebar mount

POWERBANK PORTABLE BATTERY

- Charges most cell phones and all Sena headsets via USB
- Battery pack can be fully charged in 4 hours
- Easy to read LED light power level indicator
- Includes handlebar mount and armband

PART #	DESCRIPTION	SUG. RETAIL	PART #	DESCRIPTION	SUG. RETAIL
0636-0131	PowerPro charging mount	\$99.95	3807-0444	Powerbank portable battery	\$99.95

All part numbers in BLUE are new for 2019.

WINDSHIELDS & FAIRINGS

AUDIO, COMMUNICATION & MOUNTS

SADDLEBAGS & LUGGAGE

SEATS & SISSY BARS

EXHAUST

FUEL/AIR SYSTEMS

ENGINE

TRANS & DRIV

GASKETS & ST

ELEC

LIGHTING

HANDLEBARS, CONTROLS & MIRRORS

CABLES

BRAKES

TANKS & OIL FILTERS

DASHES & GAUGES

FRAMES & SUSPENSION

FENDERS & LICENSE PLATE FRAMES

FOOTRESTS & FLOORBOARDS

WHEELS & AXLES

HARDWARE, COVERS & GENERAL



4403-0114



4403-0115



4403-0116



4403-0117

BT-03 ELITE SERIES BLUETOOTH® HEADSETS

- Features miniature extra high-output AeroMike VI boom microphone
- Superior wind and ambient noise canceling at high speeds
- Easy-to-install clamp-on mounting system includes all necessary hardware
- CSR BlueCore8 module makes it easy to pair with most Bluetooth-enabled audio devices
- Up to four headsets can be paired together allowing for communication up to 1/2 mile
- Easy-to-operate controls

PART #	DESCRIPTION	SUG. RETAIL	PART #	DESCRIPTION	SUG. RETAIL
4403-0114	Full face	\$339.95	4403-0116	Flip-up/open style	\$359.95
4403-0115	Shorty-style (Half)	379.95	4403-0117	Universal	339.95

BT-03 PERFORMANCE SERIES BLUETOOTH® HEADSET

- Superior wind and ambient noise canceling at high speeds
- Easy-to-install clamp-on mounting system includes all necessary hardware
- CSR BlueCore8 module makes it easy to pair with most Bluetooth-enabled audio devices
- Up to four headsets can be paired together, allowing for communication up to 1/2 mile
- Easy-to-operate controls
- Universal application fits most full face, flip-up, or shorty style helmets

PART #	DESCRIPTION	SUG. RETAIL
4403-0118	BT-03 performance series Bluetooth® Headset	\$199.95



All part numbers in **BLUE** are new for 2019.

KURYAKYN



4405-0537



4405-0445



4405-0538



4405-0446

**ROAD THUNDER®
SOUND BAR PLUS BY MTX®**

- Peak music power 300 watts
- Two 2" x 3" full-range speakers with dual-voice coil
- Four 1" silk dome tweeters with N42 grade magnets for higher power handling
- Amplifier 4 x 19WRMS, Max 4 x 23W
- Integrated 3.0 Bluetooth receiver with automatic pairing via NFC
- Integrated, water-resistant 1.0 Amp USB charging port in end cap
- Auxiliary 3.5mm input in end cap for connecting devices via cable
- Auxiliary 3.5mm output in end cap for connecting an external amp or additional sound bar
- Speaker dimensions: 10.6" L x 2.9" diameter; bracket measures 6" L x 3" in diameter
- Universal articulating mounting clamps fit handlebars between 7/8" and 1 1/4"; brackets are patent pending
- Power, ground, ignition wire with connector for easy disconnect
- All weather construction for use on any vehicle - weather-resistant in accordance with IP66 rating
- Built-in, self-protection circuit and heat sink
- Available in satin silver or satin black finish

PART #	DESCRIPTION	SUG. RETAIL
4405-0537	Satin silver	\$449.99
4405-0538	Satin black	\$449.99

ROAD THUNDER® SOUND BARS BY MTX®

- Packed with power, peak output of 150W
- Exceptional sound quality; internal amp powers two 2" x 3" full-range speakers and four 1" tweeters
- All-weather construction in accordance with an IP66 rating
- Includes power, ground and ignition wire for easy disconnect
- Auxiliary input for connecting devices with 3.5mm audio cable
- Auxiliary output for connecting external amps or additional sound bar
- Internal Bluetooth® receiver allows wireless connectivity

PART #	DESCRIPTION	SUG. RETAIL
4405-0445	Satin silver	\$399.99
4405-0446	Satin black	399.99

**ROAD THUNDER®
SPEAKER PODS BY MTX®**

- Bring the noise with a peak power rating of 100W
- Low power draw of just 5 amps
- High-impact ABS speaker enclosures measure 3" in diameter and are durable and weather proof
- Include 3.5mm input and output connectors, power connector and ground connector
- Available with or without Bluetooth® controller
- Bluetooth® controller features auto-pairing and five front panel touch controls
- Handlebar mount brackets for 7/8" or 1" diameter handlebars included



4405-0441



4405-0443

PART #	DESCRIPTION	SUG. RETAIL
ROAD THUNDER® SPEAKER PODS		
4405-0441	Chrome	\$199.99
4405-0442	Satin black	199.99

PART #	DESCRIPTION	SUG. RETAIL
ROAD THUNDER® SPEAKER PODS WITH BLUETOOTH® CONTROLLER		
4405-0443	Chrome	\$299.99
4405-0444	Satin black	299.99

ROAD THUNDER® BLUETOOTH® AUDIO CONTROLLER BY MTX®

- Turn any smartphone or MP3 player into the ultimate sound system
- Controller wirelessly connects any Bluetooth® enabled device to Road Thunder® speaker pods, Sound of Chrome™ speakers or almost any other self-amplified speaker system
- Universal controller replaces the head unit and is easy to install
- Compatible with most Bluetooth® devices
- Durable, weather-proof design with included power, ground and output connections
- Includes adjustable handlebar mount brackets for 7/8" and 1" diameter handlebars



PART #	DESCRIPTION	SUG. RETAIL
4405-0447	Road Thunder® Bluetooth® audio controller	\$129.99

All part numbers in **BLUE** are new for 2019.

WINDSHIELDS & FAIRINGS

AUDIO, COMMUNICATION & MOUNTS

SADDLEBAGS & LUGGAGE

SEATS & SISSY BARS

EXHAUST

FUEL/AIR SYSTEMS

ENGINE

TRANSMISSION & DRIVELINE

GASKETS & SEALS

ELECTRICAL

LIGHTING

HANDLEBARS, CONTROLS & MIRRORS

CABLES

BRAKES

TANKS & OIL FILTERS

DASHES & GAUGES

FRAMES & SUSPENSION

FENDERS & LICENSE PLATE FRAMES

FOOTRESTS & FLOORBOARDS

WHEELS & AXLES

HARDWARE, COVERS & GENERAL

WINDSHIELDS & FAIRINGS

AUDIO, COMMUNICATION & MOUNTS

SADDLEBAGS & LUGGAGE

SEATS & SISSY BARS

EXHAUST

FUEL/AIR SYSTEMS

ENGINE

TRANSMISSION & DRIVELINE

GASKETS & SEALS

ELECTRICAL

LIGHTING

HANDLEBARS, CONTROLS & MIRRORS

CABLES

BRAKES

TANKS & OIL FILTERS

DASHES & GAUGES

FRAMES & SUSPENSION

FENDERS & LICENSE PLATE FRAMES

FOOTRESTS & FLOORBOARDS

WHEELS & AXLES

HARDWARE, COVERS & GENERAL



iOmounts™ DEVICE MOUNTS

- Motorcycle model-specific mounts incorporate the iOmounts™ system; install the mount to bike with included hardware
- Device is held in place by the strong iOcore™ magnet, and you can adjust the angle of your device
- Optional colors and new Builders Kit allows customization
- Builders Kit includes sphere iOcore, 1/4-20 bolt and 2-pk of iOadapt™

NOTE: Not for use with Samsung Galaxy S4 phones or inductive charging systems.

PART #	COLOR	SUG. RETAIL
FOR 14-19 DARKHORSE, CLASSIC, CHIEFTAIN, ROADMASTER W/ STOCK CONTROLS		
0636-0049	Chrome	\$99.95
0636-0050	Black	99.95
FOR 15-19 SCOUT/SCOUT SIXTY		
0636-0100	Left hand, chrome	99.95
0636-0101	Left hand, black	99.95
0636-0098	Right hand, chrome	99.95
0636-0099	Right hand, black	99.95

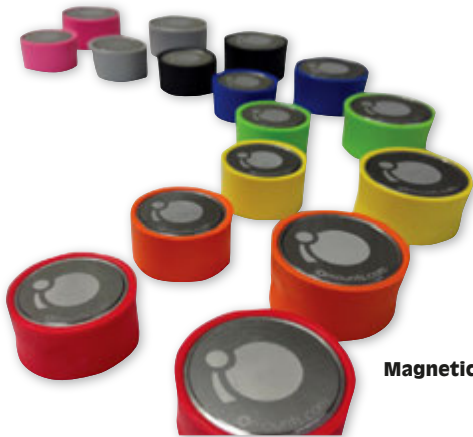

Magnetic iOcore



0636-0105

PART #	DESCRIPTION	SUG. RETAIL
OPTIONAL MAGNETIC iOcore		
0636-0037	Green iOcore	\$19.95
0636-0038	Black iOcore	19.95
0636-0039	Blue iOcore	19.95
0636-0040	Gray iOcore	19.95
0636-0041	Orange iOcore	19.95

PART #	DESCRIPTION	SUG. RETAIL
OPTIONAL MAGNETIC iOcore (CONT)		
0636-0043	Red iOcore	\$19.95
REPLACEMENT COMPONENTS (EA.)		
0636-0046	iOskin™	5.95
0636-0045	iOadapt disc	9.95
0636-0105	Builders kit	79.95

All part numbers in **BLUE** are new for 2019.



iOmounts™ SYSTEM NOMAD DEVICE MOUNT

- Attach razor-thin iOadapt™ stainless steel adapter to your device case and connect to the powerful iOcore™ magnetic carrier
- Innovative and clean, this mount uses 12 lb. magnetic force to hold device
- Nomad Universal mount fits any handlebars that are .5" to 2" in diameter; includes Nomad, two iOadapts™
- Can be remounted to other vehicles or uses

NOTE: Not for use with Samsung Galaxy S4 phones.
NOTE: Does not work with inductive charging.

PART #	DESCRIPTION	SUG. RETAIL
0636-0055	iOmounts™ System Nomad Device Mount	\$59.95

- WINDSHIELDS & FAIRINGS
- AUDIO, COMMUNICATION & MOUNTS
- SADDLEBAGS & LUGGAGE
- SEATS & SISSY BARS
- EXHAUST
- FUEL/AIR SYSTEMS
- ENGINE
- TRANSMISSION & DRIVELINE
- GASKETS & SEALS
- ELECTRICAL
- LIGHTING
- HANDLEBARS, CONTROLS & MIRRORS
- CABLES
- BRAKES
- TANKS & OIL FILTERS
- DASHES & GAUGES
- FRAMES & SUSPENSION
- FENDERS & LICENSE PLATE FRAMES
- FOOTRESTS & FLOORBOARDS
- WHEELS & AXLES
- HARDWARE, COVERS & GENERAL



DYNAMAT SOUND CONTROL SADDLEBAG AND FAIRING KIT

- High-efficiency, sound-dampening material
- Achieve tighter bass and clearer music with your stock stereo
- Stops fairing vibration and directs music out toward the rider
- No measuring, no cutting, easy to install; peel and stick
- Fairing kit is custom cut per motorcycle, resulting in no waste and no guesswork
- Made in the U.S.A.

PART #	DESCRIPTION	SUG. RETAIL
0521-1578	For 14-18 Chieftain and Roadmaster, 17-18 Chieftain Dark Horse	\$189.95



MAGNETIC TANK POUCH

- Convenient magnetic phone and GPS tank pouch for steel tanks
- Generous 8" x 4 1/2" size easily accommodates most cell phones or GPS units in a clear faced pocket
- Six ultra-strong magnets securely hold pocket in place and the felt backing protects against scratching
- Made in the U.S.A.

PART #	DESCRIPTION	SUG. RETAIL
3502-0311	Magnetic tank pouch	\$28.95



SHORT SPIRAL ANTENNA

- Great replacement for the long, stock OEM whip style antennas
- Easy-to-install, direct replacement
- Features grommet that remains in place and completes the installation process
- Includes a removable M6-1.0 threaded screw to mount on any model
- Measures 7 1/2" tall

PART #	DESCRIPTION	SUG. RETAIL
4401-0214	For Chieftain/Roadmaster 14-18	\$22.95

All part numbers in **BLUE** are new for 2019.

WINDSHIELDS & FAIRINGS

AUDIO, COMMUNICATION & MOUNTS

SADDLEBAGS & LUGGAGE

SEATS & SISSY BARS

EXHAUST

FUEL/AIR SYSTEMS

ENGINE

TRANSMISSION & DRIVELINE

GASKETS & SEALS

ELECTRICAL

LIGHTING

HANDLEBARS, CONTROLS & MIRRORS

CABLES

BRAKES

TANKS & OIL FILTERS

DASHES & GAUGES

FRAMES & SUSPENSION

FENDERS & LICENSE PLATE FRAMES

FOOTRESTS & FLOORBOARDS

WHEELS & AXLES

HARDWARE, COVERS & GENERAL



TRUNK RELOCATION BRACKETS

- Moves trunk back 2"
- Chrome-plated
- Easy to install

PART #
3550-0295

DESCRIPTION
For 15-19 Roadmaster

SUG. RETAIL
\$249.95



KURYAKYN

FIXED TRUNK RELOCATOR

- Free up space for you and your passenger by relocating the trunk 1", 2" or 3" back from the factory location
- Improves passenger ergonomics, and once installed can be easily adjusted with simple hand tools to locate ideal positioning
- Durable construction from machined and drilled aluminum



PART #
3550-0296

DESCRIPTION
For 15-19 Roadmaster and 14-19 Chieftain (if equipped with a Tour Trunk)

SUG. RETAIL
\$149.99

KURYAKYN

TRUNK LID ORGANIZER

- Keep the smaller items organized and easily accessible
- Mounts securely to Indian trunk lids and contains a variety of pockets for storage
- Quick-disconnect hook-and-loop and handles make it easy to carry when you reach your destination
- Includes flip-out removable mirror in separate pocket



PART #
3501-1342

DESCRIPTION
For 15-19 Roadmaster (except Classic), 14-19 Chieftain (if equipped with a Tour Trunk)

SUG. RETAIL
\$59.99

0822-0367



0822-0368



DELUXE PASSENGER ARMRESTS

- Mounts to the quick-release trunk bracket
- Creates a hidden mount and easily pivots for convenient passenger access
- Stainless steel hardware with a bright chrome finish
- Hardware included

PART #
FOR 14-18 CHIEF/CHIEFTAIN, 15-18 ROADMASTER
0822-0367 Black **\$279.95**

PART #
FOR 14-18 CHIEF/CHIEFTAIN, 15-18 ROADMASTER (CONT)
0822-0368 Tan **\$279.95**



PASSENGER ARMRESTS

- Pivot out horizontally to allow access to the passenger seat without inhibiting access to the trunk
- Water-resistant and feature two-inch thick padding
- Adjustable tension knobs and magnets hold arms in place while in use
- Installation uses existing bolt holes, no drilling or cutting required
- Includes cup holder mounting (cup holders sold separately)

0822-0358



0822-0359



PART #
FOR 15-18 ROADMASTER
0822-0358 Black **\$349.95**

PART #
FOR 15-18 ROADMASTER (CONT)
0822-0359 Tan **\$349.95**

All part numbers in **BLUE** are new for 2019.



SADDLEBAG FASTENERS

- Posi-Lock™ Saddlebag Fasteners keep saddlebags in place
- Designed not to fail, they are a great anti- theft and quick-release style
- U-Clip Nuts prevent using a wrench or pliers to remove the fastener from outside the saddlebag
- Comfortable 1.5" black rosette knobs make attachment easy and ensure installed saddlebags stay in place to avoid unwanted loss, yet quick enough to remove when not desired
- Sold as a set of 4, perfect for a pair of saddlebags



PART #	DESCRIPTION	SUG. RETAIL
2404-0668	Saddlebag fasteners	\$17.95

KURYAKYN

SADDLEBAG TOP TRIM

- Four-piece accent set (two pieces per saddlebag)
- Accentuates classic curves on hard saddlebags
- Chrome-plated ABS with easy, peel-and-stick installation



PART #	DESCRIPTION	SUG. RETAIL
3501-1125	For 14-19 Chieftain, Roadmaster (except Roadmaster Classic, 19 Chieftain, Chieftain Dark Horse and Chieftain Limited) and Springfield models	\$79.99



SADDLEBAG LID BRAS

- Custom tailored saddlebag lid protectors
- Designed to help minimize scratches to saddlebag lids or cover those that already exist
- Tapered lid bra design leaves the saddlebag lid artfully protected, covering the front face and gently tapering to the rear
- Secured in place with strategically placed hook and loop fasteners to the inside of the saddlebag lid
- Easily removes for cleaning and waxing
- Made in the U.S.A.



PART #	DESCRIPTION	SUG. RETAIL
3501-1263	For 14-18 Roadmaster/Chieftain/Springfield	\$65.95

KURYAKYN

SADDLEBAG COOLER

- Keeps your favorite fluids frosty and at the ready
- Holds up to a 12-pack of bottles or 18-pack of cans plus ice, and the sealed interior lining means moisture stays inside the cooler instead of your saddlebag
- Made from durable, 1200-denier polyester with a sealed, TPU-coated nylon liner with high-density insulation
- Sized to fit virtually any OEM saddlebag
- Includes bottle opener
- Wide-zippered opening and side-mounted carrying handles for easy access
- Includes removable/adjustable shoulder strap
- Measures 17.5" L x 6" W x 9" H



PART #	DESCRIPTION	SUG. RETAIL
3501-1340	Saddlebag cooler	\$59.99



480 SADDLEBAG KING KOOLER

- Turn your saddlebag into an insulated cooler
- Liner is insulated, waterproof and custom fit to H-D, Honda Gold Wing, Yamaha, Kawasaki, Indian and Victory saddlebags
- Ideal for hot, dusty roads, picnics or parties
- Measures 19" x 10" x 6"
- Sold each
- Made in the U.S.A.



PART #	DESCRIPTION	SUG. RETAIL
3511-0026	King Cooler	\$39.95

All part numbers in **BLUE** are new for 2019.

WINDSHIELDS & FAIRINGS

AUDIO, COMMUNICATION & MOUNTS

SADDLEBAGS & LUGGAGE

SEATS & SISSY BARS

EXHAUST

FUEL/AIR SYSTEMS

ENGINE

TRANSMISSION & DRIVELINE

GASKETS & SEALS

ELECTRICAL

LIGHTING

HANDLEBARS, CONTROLS & MIRRORS

CABLES

BRAKES

TANKS & OIL FILTERS

DASHES & GAUGES

FRAMES & SUSPENSION

ENDERS & LICENSE PLATE FRAMES

FOOTRESTS & FLOORBOARDS

WHEELS & AXLES

HARDWARE, COVERS & GENERAL

WINDSHIELDS & FAIRINGS

AUDIO, COMMUNICATION & MOUNTS

SADDLEBAGS & LUGGAGE

SEATS & SISSY BARS

EXHAUST

FUEL/AIR SYSTEMS

ENGINE

TRANSMISSION & DRIVELINE

GASKETS & SEALS

ELECTRICAL

LIGHTING

HANDLEBARS, CONTROLS & MIRRORS

CABLES

BRAKES

TANKS & OIL FILTERS

DASHES & GAUGES

FRAMES & SUSPENSION

FENDERS & LICENSE PLATE FRAMES

FOOTRESTS & FLOORBOARDS

WHEELS & AXLES

HARDWARE, COVERS & GENERAL

MOMENTUM DEADBEAT DUFFLE

- UV-rated weather-resistant 1200-denier textile material with removable rain cover
- Quick-mount sissy bar strap for safe and secure mounting in seconds
- External adjustable bungee storage for coat, bedroll or other items
- MOLLE modular attachment points
- Low-profile carrying handle and removable shoulder strap for off-the-bike convenience
- Roll top design with high-strength hook-and-loop closure for storage versatility and water resistance
- Fully adjustable, convenient speed-buckle clasps
- Side zippered quick-stash pockets
- Heavy-duty welded D-Rings and full mounting strap kit for bikes without sissy bars
- Dimensions: 10" D x 18" T (fully expanded)
- Measures: 1,414 cubic inches (23 liters)



PART #	DESCRIPTION	SUG. RETAIL
3515-0201	Momentum Deadbeat duffle	\$99.99

MOMENTUM DRIFTER BAG

- UV-rated, weather-resistant 1200-denier textile construction
- Ideal size and shape for tour trunks with luggage racks, passenger seats, or sissy bars with or without luggage racks
- Quick-mount sissy bar strap design for secure mounting in seconds
- Easily mounts to Kuryakyn Momentum Road Warrior, Vagabond or other luggage (all sold separately)
- Dual side entry doors offer easy access to main storage compartment
- External, adjustable bungee storage system for coats, bedrolls or other items
- Seven external quick-stash pockets, including two bottle pockets
- Integrated MOLLE modular attachment points
- Rigid structure retains its shape whether empty or loaded
- Tethered rain cover with designated storage pocket
- Low-profile carrying handles plus removable shoulder strap for easy portability off the bike
- Includes full mounting strap kit



- Dimensions: 18.5" W x 12" D x 11.5" T
- Measures: 2,553 cubic inches (42 liters)

PART #	DESCRIPTION	SUG. RETAIL
3515-0192	Momentum Drifter bag	\$169.99

MOMENTUM RAMBLER ROLL BAG

- UV-rated, weather-resistant 1200-denier textile construction with removable rain cover
- Bottom-mounted tie-down loops for easy mounting on luggage racks or Momentum Drifter, Road Warrior and Vagabond bags, all sold separately
- Convenient side entry doors to easily access items while mounted
- Front stash pocket for easy access to small items
- Quick-mount sissy bar strap design for secure mounting in seconds
- External, adjustable bungee storage system for coat, bedroll or other items
- Integrated MOLLE modular attachment points
- Low-profile carrying handle plus removable shoulder strap for easy portability off the bike
- Rigid structure retains its shape whether loaded or empty
- Multiple D-Rings for additional easy and secure mounting options
- Dimensions: 15.5" W x 9" T x 9.25" D
- Measures 1,290 cubic inches



PART #	DESCRIPTION	SUG. RETAIL
3516-0268	Momentum Rambler roll bag	\$109.99

JACKET ROLL

- Convenient storage option to keep jackets, extra layers, bedrolls or blankets handy and securely stowed away
- Made from durable UV-rated, weather-resistant 1200 denier textile
- Adjustable buckle snap straps for convenient mounting on virtually any handlebar or sissy bar setup
- Loaded with MOLLE modular attachment points
- Folds up for easy storage when not in use
- Perfect storage option for carrying extra layers or removing layers as temps rise
- Measures 16.5" W x 12" L x 1" D (rolls up to 12" L x 3" W)



PART #	DESCRIPTION	SUG. RETAIL
3515-0204	Jacket roll	\$39.99

All part numbers in **BLUE** are new for 2019.

KURYAKYN

MOMENTUM OUTRIDER THROW-OVER SADDLEBAGS

- UV-rated weather-resistant 1200-denier textile material with removable rain covers
- No saddlebag supports or mounting brackets required
- Fully adjustable mounting belt to fit almost any motorcycle
- Angled design accommodates most stock fender-mounted turn signals
- Mounts on top or under passenger seat with slant forward or backward
- Anti-scratch backs and heat resistant bottoms
- Includes mounting strap kit for extra security
- Forward-facing, quick-stash pockets for smaller items or bottle storage
- 2" expansion panel with capacity to fit a half helmet



- Internal, adjustable divider for organization
- Measure 18" wide x 8" deep (10" expanded) x 11" tall (each bag)
- Cubic inches: 1,584 per bag, Expanded: 1,980 per bag
- Liters: 26 per bag (32 expanded)

PART #	DESCRIPTION	SUG. RETAIL
3501-1359	Momentum Outrider throw-over saddlebags	\$229.99

KURYAKYN

MOMENTUM ROAMER TAIL BAG

- Durable UV-rated, weather-resistant 1200-denier textile material with removable rain cover
- External, adjustable bungee storage for coat, bedroll or other items
- Low-profile carrying handle and removable shoulder strap for off-the-bike convenience
- Multiple welded D-rings and included strap kit for secure mounting
- Integrated MOLLE modular attachment points
- External quick-stash pockets and bottle pockets
- Includes optional clear protective film for fender/paint protection



- Dimensions: 17.5" W x 15" D x 8" T
- Measures 1,860 cubic inches (30.5 liters)

PART #	DESCRIPTION	SUG. RETAIL
3502-0315	Momentum Roamer tail bag	\$149.99

DELUXE SOLO RACK BAG

- Constructed of heavy-duty, water-resistant polyester
- Expandable, contoured bag fits most solo racks and sissy bar racks
- Expandable side pockets for extra carrying capacity
- 1617 cu. in. of lined storage space
- Quick-release side lock buckle anchoring system with belly strap
- Rain cover and shoulder strap included
- Expanded dimensions: 14" L x 16 1/2" W x 7" H



PART #	DESCRIPTION	SUG. RETAIL
3515-0170	Deluxe solo rack bag	\$99.95



1510-0392

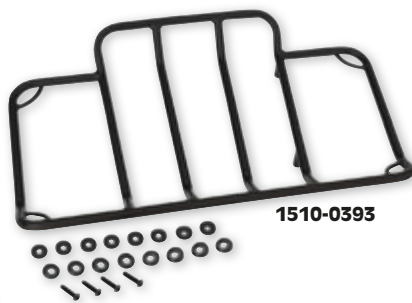

1510-0393



TOUR RACK RISER KIT FOR 1/2" TUBES

- For Show Chrome accessory racks
- Provides more clearance under luggage racks, allowing for easy cleaning or getting to other accessories to fit below
- These Rack Risers universally fit 1/2" diameter tubes with a custom recessed bevel to securely fit and enhance the original rack legs
- They extend rack legs 5/8" and fit racks with 1/2" round leg
- Comes as a complete set of four Rack Risers with two sets of bolts; 4 x 6mm (M6) bolts and 4 x 1/4"-20 bolts, to replace the shorter bolts that come with most racks
- For best fit, place risers between the rack leg and the angled feet that come with Show Chrome Accessories racks

TOUR TRUNK RACKS

- Generous 20" x 12 1/2" luggage rack easily accommodates the largest luggage bags and comes with custom tapered mounting spacers which allows the rack to more easily conform to the curve of the trunk
- The tapered spacers are recessed to allow the rack to rest securely into the spacers which helps spread the load over the trunk lid to alleviate stress cracking
- Rubber washers under each spacer not only protect the bikes finish, but also assure a water light fit



- The manufactures trunk specs should be viewed for loading limits
- Designed specifically for the Indian trunk, its mounting legs align with the OEM mounting points making it easy to upgrade if you already have an OEM rack installed

FOR 14-18 SPRINGFIELD/CHIEFTAIN/ROADMASTER								
PART #	DESCRIPTION	SUG. RETAIL	PART #	DESCRIPTION	SUG. RETAIL	PART #	DESCRIPTION	SUG. RETAIL
1510-0392	Chrome	\$135.95	1510-0393	Black satin	\$135.95	1510-0333	Black	\$22.95

All part numbers in **BLUE** are new for 2019.

- WINDSHIELDS & FAIRINGS
- AUDIO, COMMUNICATION & MOUNTS
- SADDLEBAGS & LUGGAGE**
- SEATS & SISSY BARS
- EXHAUST
- FUEL/AIR SYSTEMS
- ENGINE
- TRANSMISSION & DRIVELINE
- GASKETS & SEALS
- ELECTRICAL
- LIGHTING
- HANDLEBARS, CONTROLS & MIRRORS
- CABLES
- BRAKES
- TANKS & OIL FILTERS
- DASHES & GAUGES
- FRAMES & SUSPENSION
- FENDERS & LICENSE PLATE FRAMES
- FOOTRESTS & FLOORBOARDS
- WHEELS & AXLES
- HARDWARE, COVERS & GENERAL



WINDSHIELDS & FAIRINGS

AUDIO, COMMUNICATION & MOUNTS

SADDLEBAGS & LUGGAGE

SEATS & SISSY BARS

EXHAUST

FUEL/AIR SYSTEMS

ENGINE

TRANSMISSION & DRIVELINE

GASKETS & SEALS

ELECTRICAL

LIGHTING

HANDLEBARS, CONTROLS & MIRRORS

CABLES

BRAKES

TANKS & OIL FILTERS

DASHES & GAUGES

FRAMES & SUSPENSION

FENDERS & LICENSE PLATE FRAMES

FOOTRESTS & FLOORBOARDS

WHEELS & AXLES

HARDWARE, COVERS & GENERAL

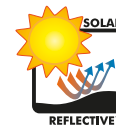

0810-1996



0810-1999

CABALLERO SEAT

- Stylish design featuring classic- or diamond-stitch pattern
- Black seats have Solar-reflective leather in the seating area and automotive-grade vinyl on the sides
- Solar-reflective leather has a patented process that reduces the surface temperature by as much as 25°F for a cooler seat; higher durability and longer life over conventional leather or vinyl
- Brown seats feature a faux brown leather material construction

- All have a flexible foam urethane foam interior, rubber bumpers and carpeted bottom to protect the bike's paint
- Seat measures approximately 29" L (total length)
- Driver's seat area measures approximately 12" W; passenger seat area measures approximately 5" W
- Made in the U.S.A.

NOTE: Rear seat portion is designed for style; not recommended for long-term passenger riding.

PART #	DESCRIPTION	SUG. RETAIL
FOR 15-19 SCOUT, SCOUT SIXTY		
0810-1996	Brown, diamond stitch	\$360.95
0810-1997	Black Solar-reflective, diamond stitch	377.95
0810-1999	Black Solar-reflective, classic stitch	363.95



0810-1993

0810-1985



0810-1994

0810-1986

BOBBER-STYLE SOLO FRONT AND REAR SEATS

- Looks like a vintage spring solo seat, but is rigid-mounted
- Black seats have Solar-reflective leather in the seating area and automotive-grade vinyl on the sides
- Solar-reflective leather has a patented process that reduces the surface temperature by as much as 25°F for a cooler seat; higher durability and longer life over conventional leather or vinyl
- Brown seats feature a faux brown leather material construction

- All have a flexible foam urethane foam interior, rubber bumpers and carpeted bottom to protect the bike's paint
- Front seats can be used with or without solo rear seat
- Solo rear seats will work with OEM solo front seat
- All will work with the OEM driver backrest bar
- Solo front seats measure approximately 16" L x 13" W
- Solo rear seats measure approximately 11 1/2" L x 8" W
- Made in the U.S.A.

PART #	DESCRIPTION	SUG. RETAIL
FOR 15-19 SCOUT, SCOUT SIXTY		
BOBBER FRONT SOLO SEAT (16" L x 13" W)		
0810-1984	Brown, smooth	\$234.95
0810-1985	Black Solar-reflective leather, smooth	253.95
0810-1986	Brown, diamond stitch	257.95
0810-1987	Black Solar-reflective leather, diamond stitch	276.95
SOLO REAR SEAT (11 1/2" L x 8" W)		
0810-1992	Brown, smooth	185.95
0810-1993	Black Solar-reflective leather, smooth	191.95
0810-1994	Brown, diamond stitch	200.95
0810-1995	Black Solar-reflective leather, diamond stitch	205.95

All part numbers in **BLUE** are new for 2019.



0810-1988



0810-1991



0810-2001



0810-2002

- WINDSHIELDS & FAIRINGS
- AUDIO, COMMUNICATION & MOUNTS
- SADDLEBAGS & LUGGAGE
- SEATS & SISSY BARS**
- EXHAUST
- FUEL/AIR SYSTEMS
- ENGINE
- TRANSMISSION & DRIVELINE
- GASKETS & SEALS
- ELECTRICAL
- LIGHTING
- HANDLEBARS, CONTROLS & MIRRORS
- CABLES
- BRAKES
- TANKS & OIL FILTERS
- DASHES & GAUGES
- FRAMES & SUSPENSION
- FENDERS & LICENSE PLATE FRAMES
- FOOTRESTS & FLOORBOARDS
- WHEELS & AXLES
- HARDWARE, COVERS & GENERAL

3/4 SOLO SEATS

- Gives the bike a cafe-racer style look
- Has a 6" rise at the back of the seat for added support
- Black seats have Solar-reflective leather in the seating area and automotive-grade vinyl on the sides
- Solar-reflective leather has a patented process that reduces the surface temperature by as much as 25°F for a cooler seat; higher durability and longer life over conventional leather or vinyl
- Brown seats feature a faux brown leather material construction

- All have a flexible foam urethane foam interior, rubber bumpers and carpeted bottom to protect the bike's paint
- Extended reach seat is approximately 1" taller than standard seat height; positions the rider approximately 1 1/2" back from the stock seating position
- Mount just like the OEM seat; no additional hardware needed
- Made in the U.S.A.

FOR 15-19 SCOUT, SCOUT SIXTY

PART #	DESCRIPTION	SUG. RETAIL
3/4 SOLO SEAT (22" L x 12 1/2" W)		
0810-1988	Brown, mild stitch	\$239.95
0810-1989	Black Solar-reflective, mild stitch	247.95
0810-1990	Brown, diamond stitch	261.95
0810-1991	Black Solar-reflective, diamond stitch	271.95
EXTENDED REACH 3/4 SOLO SEAT (22" L x 12" W)		
0810-2000	Brown, mild stitch	239.95
0810-2001	Black Solar-reflective, mild stitch	250.95
0810-2002	Brown, diamond stitch	263.95
0810-2003	Black Solar-reflective, diamond stitch	271.95

All part numbers in **BLUE** are new for 2019.

WINDSHIELDS & FAIRINGS

AUDIO, COMMUNICATION & MOUNTS

SADDLEBAGS & LUGGAGE

SEATS & SISSY BARS

EXHAUST

FUEL/AIR SYSTEMS

ENGINE

TRANSMISSION & DRIVELINE

GASKETS & SEALS

ELECTRICAL

LIGHTING

HANDLEBARS, CONTROLS & MIRRORS

CABLES

BRAKES

TANKS & OIL FILTERS

DASHES & GAUGES

FRAMES & SUSPENSION

FENDERS & LICENSE PLATE FRAMES

FOOTRESTS & FLOORBOARDS

WHEELS & AXLES

HARDWARE, COVERS & GENERAL



HEATED ONE-PIECE TOURING SEAT

- Seat features high/low dual heating controls for driver and passenger
- Controls are hidden beneath the diamond-stitched black seat cover
- Driver and passenger seating areas both measure approximately 15" W
- Seat also puts driver 3/4" lower and 7/8" further back than the stock seating position for improved comfort
- Fully adjustable driver's backrest pad is included; pad can be easily removed and folds for convenient storage
- Optional passenger wrap-around armrests and backrest pad provide added comfort options on long rides
- Seat base is marine-grade fiberglass construction with proprietary comfort foam padding
- Made in the U.S.A.



PART #	DESCRIPTION	SUG. RETAIL
FOR 16-19 ROADMASTER		
0810-1983	Heated one-piece touring seat	\$899.99

PART #	DESCRIPTION	SUG. RETAIL
FOR 16-19 ROADMASTER (CONT)		
0822-0314	Passenger backrest pad	\$429.99

PART #	DESCRIPTION	SUG. RETAIL
FOR 16-19 ROADMASTER (CONT)		
0822-0315	Passenger armrest pads	\$89.99

SOLO TOURING SEATS AND PASSENGER SEATS

- Seat positions the rider 1.5" back from stock
- Driver and passenger seats use controlled-density foam for ample support and all-day riding comfort
- Premium-quality expanded vinyl cover
- Studded style features a studded skirt with conchos and braid that extends below the edge of the seat
- Vintage style has no conchos or studs for a clean look
- Driver seat available with or without built-in backrest
- Passenger seats available with or without receiver for optional backrest, sold separately
- Made in the U.S.A.



FOR 14-19 CHIEF/CHIEFTAIN/CHIEFTAIN VINTAGE, 16-19 CHIEF DARK HORSE					
PART #	DESCRIPTION	SUG. RETAIL	PART #	DESCRIPTION	SUG. RETAIL
SOLO TOURING SEATS			PASSENGER SEATS (CONT)		
0810-1632	Studded w/ backrest; 16.5" W	\$549.99	0810-1635	Studded; 13" W	\$239.99
0810-1631	Studded; 16.5" W	339.99	0810-1638	Vintage; 13" W	229.99
0810-1633	Vintage; 16.5" W	324.99	PASSENGER BACKRESTS		
PASSENGER SEATS			0822-0221	Studded	214.99
0810-1636	Studded w/ backrest; 13" W	269.99	0822-0218	Vintage	204.99

SHOPE SIGNATURE SERIES TRIPPER SEATS

- Designed exclusively by John Shope of Dirty Bird Concepts®
- Features double-stitched, high-quality expanded vinyl
- Perforated design with diamond-stitched center panel
- Made in the U.S.A.



PART #	FRONT WIDTH	SUG. RETAIL
FOR 14-19 CHIEF/CHIEFTAIN		
0810-2018	Diamond; 11" W front, 6" W rear	\$399.99

PART #	FRONT WIDTH	SUG. RETAIL
FOR 15-19 SCOUT/SCOUT SIXTY		
0810-2016	Diamond; 8.5" W front, 5" W rear	\$399.99

SHOPE SIGNATURE SERIES CAFE SEATS

- Designed exclusively by John Shope of Dirty Bird Concepts®
- Features double-stitched, high-quality expanded vinyl
- Perforated design in choice of Tuck and Roll-stitched center panel or diamond-stitched center panel
- Made in the U.S.A.



PART #	DESCRIPTION	SUG. RETAIL
FOR 14-19 CHIEF/CHIEFTAIN		
0810-2017	Diamond; 11.5" W	\$379.99

PART #	DESCRIPTION	SUG. RETAIL
FOR 15-19 SCOUT/SCOUT SIXTY		
0810-2015	Tuck and roll; 9" W	\$379.99

All part numbers in **BLUE** are new for 2019.



- WINDSHIELDS & FAIRINGS
- AUDIO, COMMUNICATION & MOUNTS
- SADDLEBAGS & LUGGAGE
- SEATS & SISSY BARS
- EXHAUST
- FUEL/AIR SYSTEMS
- ENGINE
- TRANSMISSION & DRIVELINE
- GASKETS & SEALS
- ELECTRICAL
- LIGHTING
- HANDLEBARS, CONTROLS & MIRRORS
- CABLES
- BRAKES
- TANKS & OIL FILTERS
- DASHES & GAUGES
- FRAMES & SUSPENSION
- FENDERS & LICENSE PLATE FRAMES
- FOOTRESTS & FLOORBOARDS
- WHEELS & AXLES
- HARDWARE, COVERS & GENERAL

JARED MEES SIGNATURE SEATS

- Low-profile seat with raised tail section for lumbar support
- High-quality, expanded black vinyl cover
- Marine-grade fiberglass baseplate
- Places rider slightly lower and further back from stock position
- Carbon fiber Tuck and Roll inlay with gunmetal stitching on edges and Mees embroidered logo
- Seat measures 10" W; Fastback seat has 5" W passenger area
- Made in the U.S.A.



PART #	DESCRIPTION	SUG. RETAIL	PART #	DESCRIPTION	SUG. RETAIL
FOR 15-19 SCOUT/SCOUT SIXTY			FOR 15-19 SCOUT/SCOUT SIXTY (CONT)		
0810-2066	Solo seat	\$349.99	0810-2067	Fastback seat	\$379.99

VINTAGE SOLO SEATS WITH DRIVER BACKREST

- Provides quality comfort and design
- Features a precisely molded proprietary foam that contours to the shapes and angles needed for optimal cruising comfort
- 13" W solo seat provides ample room for comfort without compromising the look of the bike
- Constructed of marine-grade fiberglass for a secure install and long-term durability
- Features a fully adjustable driver backrest and a clean vintage look
- Available in brown or black vinyl, with or without leather inserts and nickel-plated studs
- Made in the U.S.A.



PART #	DESCRIPTION	SUG. RETAIL	PART #	DESCRIPTION	SUG. RETAIL
FOR 15-19 SCOUT/SCOUT SIXTY			FOR 15-19 SCOUT/SCOUT SIXTY (CONT)		
0810-1830	Black; studded w/ leather inserts	\$549.99	0810-1824	Brown; studded	\$519.99
0810-1829	Black; vintage w/ leather inserts	529.99	0810-1827	Black; vintage	509.99
0810-1828	Black; studded	519.00	0810-1823	Brown; vintage	509.99



VINTAGE SOLO SEATS

- Provides quality comfort and vintage design
- Features a precisely molded proprietary foam that contours to the shapes and angles needed for optimal cruising comfort
- 13" W driver and 8.5" W passenger solo seat provides ample room for comfort without compromising the look of the bike

- Constructed of marine-grade fiberglass for a secure install and long-term durability
- Available in brown or black vinyl, with or without leather inserts and nickel-plated studs
- Made in the U.S.A.

PART #	DESCRIPTION	SUG. RETAIL	PART #	DESCRIPTION	SUG. RETAIL
FOR 15-19 SCOUT/SCOUT SIXTY			FOR 15-19 SCOUT/SCOUT SIXTY		
STUDDED			VINTAGE		
0810-1836	Driver, black	\$319.99	0810-1835	Driver, black	\$309.99
0810-1846	Passenger, black	209.99	0810-1845	Passenger, black	189.99
0810-1842	Passenger, brown	209.99	0810-1841	Passenger, brown	209.99
STUDDED W/ LEATHER INSERTS			VINTAGE W/ LEATHER INSERTS		
0810-1838	Driver, black	349.99	0810-1837	Driver, black	329.99
0810-1848	Passenger, black	219.99	0810-1833	Driver, brown	329.99
0810-1844	Passenger, brown	219.99	0810-1847	Passenger, black	199.99
			0810-1843	Passenger, brown	209.99

All part numbers in **BLUE** are new for 2019.

WINDSHIELDS & FAIRINGS

AUDIO, COMMUNICATION & MOUNTS

SADDLEBAGS & LUGGAGE

SEATS & SISSY BARS

EXHAUST

FUEL/AIR SYSTEMS

ENGINE

TRANSMISSION & DRIVELINE

GASKETS & SEALS

ELECTRICAL

LIGHTING

HANDLEBARS, CONTROLS & MIRRORS

CABLES

BRAKES

TANKS & OIL FILTERS

DASHES & GAUGES

FRAMES & SUSPENSION

FENDERS & LICENSE PLATE FRAMES

FOOTRESTS & FLOORBOARDS

WHEELS & AXLES

HARDWARE, COVERS & GENERAL



RUNAROUND™ SOLO SEATS

- Provides quality comfort and distinctive styling
- Features a precisely molded proprietary foam that contours to the shapes and angles needed for optimal cruising comfort
- Engineered low, seat measures 9.5" W
- Constructed of marine-grade fiberglass for a secure install and long-term durability
- Available in brown or black vinyl
- Made in the U.S.A.

NOTE: Not intended for use with a passenger seat.

0810-1839



0810-1840

PART #	DESCRIPTION	SUG. RETAIL	PART #	DESCRIPTION	SUG. RETAIL
FOR 15-19 SCOUT/SCOUT SIXTY			FOR 15-19 SCOUT/SCOUT SIXTY (CONT)		
0810-1839	Black	\$269.99	0810-1840	Brown	\$264.99



2-UP SEATS

- Carefully designed to flow with rather than disrupt the lines of the motorcycle
- Ergonomic shape keeps the rider seated firmly and comfortably
- Marine-grade fiberglass baseplate
- Controlled-density polyurethane foam
- RSD metal logo
- Boss seat features triple-stitched, hand-sewn lines and a raised, perforated diamond pattern and black distressed vinyl material
- Enzo seat is a rich brown with a high level of detail
- Bolt-on installation
- Made in the U.S.A.

0802-0882



0802-0883



PART #	DESCRIPTION	SUG. RETAIL	PART #	DESCRIPTION	SUG. RETAIL
FOR 15-19 SCOUT/SCOUT SIXTY			FOR 15-19 SCOUT/SCOUT SIXTY (CONT)		
0802-0882	Boss	\$449.95	0802-0883	Enzo	\$459.95



SOLO SEATS

- Seats are designed to fit seamlessly with the stock rear fender
- Extra padding for maximum comfort during the ride
- Ergonomic shape keeps the rider seated firmly and comfortably
- Marine-grade fiberglass baseplate
- Controlled-density polyurethane foam
- RSD metal logo
- Boss seat features triple-stitched, hand-sewn lines and a raised, perforated diamond pattern and black distressed vinyl material
- Enzo seat is a rich brown with a high level of detail
- Bolt-on installation
- Made in the U.S.A.

0802-0880



0802-0881



PART #	DESCRIPTION	SUG. RETAIL	PART #	DESCRIPTION	SUG. RETAIL
FOR 15-19 SCOUT/SCOUT SIXTY			FOR 15-19 SCOUT/SCOUT SIXTY (CONT)		
0802-0880	Boss	\$399.95	0802-0881	Enzo	\$429.95

All part numbers in **BLUE** are new for 2019.



SEAT PAN KITS

- Great seat pan options for the Indian Scout
- Outrider seat pan kit comes with a smaller, sportier, black leather seat
- Classic comes with a more traditional, larger, brown seat

- Kits include everything needed to convert
- Metal pan and all brackets are black powder-coated
- Made in the U.S.A.

PART #	DESCRIPTION	SUG. RETAIL
FOR 15-19 SCOUT/SCOUT SIXTY		
0810-1871	Klassic	\$324.95

PART #	DESCRIPTION	SUG. RETAIL
FOR 15-19 SCOUT/SCOUT SIXTY (CONT)		
0810-1872	Outrider	\$274.95



DETACHABLE SMART MOUNT™ BACKREST

- Features the latest quick detach mount, allowing easy removal of the pad assembly, leaving all hardware below the seat top for a clean look when not in use
- Mounts through the factory backrest slot on the seat to a frame mounted backrest support bracket
- Unique design of the pad assembly provides three different pad height positions; starting at the lowest position it can be raised 1⁵/₈" higher at mid-point or a full 2³/₄" in the highest mount position
- The generous 12³/₈" x 7" full support pad provides superior comfort and support
- Exclusive hinge allows additional adjustment of 1" vertical and 3" horizontal positioning to achieve the desired comfort



- Includes convenient removable storage pouch that snaps to the back of the backrest pad
- Available in either black or saddle to match Indian seats
- Made in the U.S.A.

PART #	DESCRIPTION	SUG. RETAIL
FOR 14-18 CHIEF/CHIEFTAIN/SPRINGFIELD/ROADMASTER		
0822-0331	Black	\$189.95

PART #	DESCRIPTION	SUG. RETAIL
FOR 14-18 CHIEF/CHIEFTAIN/SPRINGFIELD/ROADMASTER (CONT)		
0822-0332	Saddle	\$189.95

VINTAGE Sissy BAR PADS

- Provides quality comfort and vintage design
- Mounts directly to stock bar
- Measures 7.5" W x 9" H
- Available in brown or black vinyl, with or without nickel-plated studs
- Made in the U.S.A.



0822-0256



0822-0253



FOR 15-19 SCOUT/SCOUT SIXTY								
PART #	DESCRIPTION	SUG. RETAIL	PART #	DESCRIPTION	SUG. RETAIL	PART #	DESCRIPTION	SUG. RETAIL
0822-0256	Black; studded	\$99.99	0822-0255	Black; vintage	\$89.99	0822-0253	Brown; vintage	\$89.99



SISSY BAR PADS

- Fits OEM accessory sissy bar
- Premium-quality expanded vinyl cover
- Foam is contoured to follow natural curvature of the back
- Available in Vintage or Studded styles
- Measure 12" W x 9" H
- Sold each
- Made in the U.S.A.



0822-0219

0822-0220



KURYAKYN BACKREST MOUNT KIT

- Mount kit for Kuryakyn multipurpose driver and passenger backrests (sold separately)

PART #	DESCRIPTION	SUG. RETAIL
FOR 14-19 CHIEF/CHIEFTAIN/VINTAGE, 16-19 CHIEF DARK HORSE		
0822-0219	Studded	\$109.99
0822-0220	Vintage	99.99

PART #	DESCRIPTION	SUG. RETAIL
0822-0346	For 14-19 Indian models (except Roadmaster and Scout models)	\$149.99

All part numbers in **BLUE** are new for 2019.

- WINDSHIELDS & FAIRINGS
- AUDIO, COMMUNICATION & MOUNTS
- SADDLEBAGS & LUGGAGE
- SEATS & Sissy BARS
- EXHAUST
- FUEL/AIR SYSTEMS
- ENGINE
- TRANSMISSION & DRIVELINE
- GASKETS & SEALS
- ELECTRICAL
- LIGHTING
- HANDLEBARS, CONTROLS & MIRRORS
- CABLES
- BRAKES
- TANKS & OIL FILTERS
- DASHES & GAUGES
- FRAMES & SUSPENSION
- FENDERS & LICENSE PLATE FRAMES
- FOOTRESTS & FLOORBOARDS
- WHEELS & AXLES
- HARDWARE, COVERS & GENERAL

WINDSHIELDS & FAIRINGS

AUDIO, COMMUNICATION & MOUNTS

SADDLEBAGS & LUGGAGE

SEATS & SISSY BARS

EXHAUST

FUEL/AIR SYSTEMS

ENGINE

TRANSMISSION & DRIVELINE

GASKETS & SEALS

ELECTRICAL

LIGHTING

HANDLEBARS, CONTROLS & MIRRORS

CABLES

BRAKES

TANKS & OIL FILTERS

DASHES & GAUGES

FRAMES & SUSPENSION

FENDERS & LICENSE PLATE FRAMES

FOOTRESTS & FLOORBOARDS

WHEELS & AXLES

HARDWARE, COVERS & GENERAL



BACKREST PADS

- Black pads have Solar-reflective leather in the contact area and automotive-grade vinyl on the sides
- Solar-reflective leather has a patented process that reduces the surface temperature by as much as 25°F for a cooler pad contact area; higher durability and longer life over conventional leather or vinyl
- Brown pads feature a faux brown leather material construction
- Internal base plate is 14-gauge steel
- Bolts directly to OEM accessory backrest bar #s 2880231-156, 2880871-156 and 2880985-156
- Pad measures approximately 9" W x 5³/₄" H

PART #	DESCRIPTION	SUG. RETAIL
FOR 15-19 SCOUT/SCOUT SIXTY		
0822-0316	Brown, smooth	\$60.95
0822-0317	Black Solar-reflective, smooth	64.95

0822-0316



0822-0319

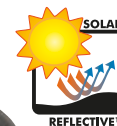

- Mounting screws included
- Made in the U.S.A.

PART #	DESCRIPTION	SUG. RETAIL
FOR 15-19 SCOUT/SCOUT SIXTY (CONT)		
0822-0318	Brown, diamond stitch	\$71.95
0822-0319	Black Solar-reflective, diamond stitch	75.95



BEAT THE HEAT DYNAMAT SEAT KIT

- Reduce the heat from under your seat by 10 degrees
- Keeps your seat cooler by deflecting heat from the rear rocker cover
- Easy installation, precut material and only takes about 10 minutes

PART #	DESCRIPTION	SUG. RETAIL
0502-0550	For 15-18 Roadmaster, 16-18 Springfield, 14-18 Chieftain/Classic/Vintage/Dark Horse	\$24.95



FENDER BIBS

- Add style to your ride
- Made with waterproof black synthetic leather that will look good for years to come
- Felt-backed to protect bike's paint
- Use stock mounts and snugly fits to edge of fender without any gaps
- Made in the U.S.A.



1405-0197



1405-0198



PART #	DESCRIPTION	SUG. RETAIL
FOR 14-19 CHIEF/CHIEFTAIN/VINTAGE, 16-19 CHIEF DARK HORSE		
1405-0197	Studded	\$39.99
FOR 14-19 CHIEF/CHIEFTAIN/VINTAGE, 16-19 CHIEF DARK HORSE (CONT)		
1405-0198	Vintage	\$34.99

KURYAKYN

SADDLE SHIELDS

- Beat the heat produced by the potent Thunder Stroke™ 111 powerplant
- Redirects heat from motor and headpipes away from rider to increase comfort
- A classic high-temp reflective smoke finish provides a refined, aesthetically pleasing appearance
- Made from durable polycarbonate
- Bolts directly to the rear tank mount using existing hardware
- Sold in pairs



PART #	DESCRIPTION	SUG. RETAIL
0504-0284	For 14-19 Indian models (except Scout models)	\$81.99

SISSY BAR SIDE PLATES

- Made of 10-gauge steel
- Fit with 6.88" to 7.625" sissy bars

NOTE: Sissy bar must be purchased separately.



1504-0060



1504-0061



PART #	DESCRIPTION	SUG. RETAIL
FOR 15-19 SCOUT/SCOUT SIXTY		
1504-0060	Chrome	\$99.95
1504-0061	Black	99.95

All part numbers in **BLUE** are new for 2019.



**2-INTO-1
HOT ROD
EXHAUST
SYSTEM**

- Made from high-quality seamless, mandrel-bent stainless steel
- Dyno developed and tested
- Offers a sleek look, aggressive sound and all-around performance throughout the entire powerband
- Features full heat-shield coverage and built-in O₂ bungs
- Made in the U.S.A.

NOTE: Bikes equipped with passenger footpegs will require rear footpeg relocation kit, PART #1620-1644.

PART #	DESCRIPTION	SUG. RETAIL
FOR 15-19 SCOUT/SCOUT SIXTY, 18-19 SCOUT BOBBER		
1810-2282	Black	\$799.95



1811-2901

SLIP-ON MUFFLERS

- Provide improved performance and sound throughout the entire powerband
- Dyno developed and tested
- Made from high-quality steel pipe
- Tapered tip
- Available in high-quality chrome or black ceramic coated finish
- Sold in pairs

FOR 15-19 SCOUT/SCOUT SIXTY, 18-19 SCOUT BOBBER					
PART #	DESCRIPTION	SUG. RETAIL	PART #	DESCRIPTION	SUG. RETAIL
1811-2901	Black	\$599.95	1811-2902	Chrome	\$599.95

DISCLAIMER: NOT LEGAL FOR SALE OR USE IN CALIFORNIA ON ANY POLLUTION CONTROLLED MOTOR VEHICLES. SEE PAGE 4 FOR IMPORTANT EMISSION DEFINITIONS AND REGULATORY COMPLIANCE AND WARRANTY INFORMATION.

All part numbers in **BLUE** are new for 2019.

- WINDSHIELDS & FAIRINGS
- AUDIO, COMMUNICATION & MOUNTS
- SADDLEBAGS & LUGGAGE
- SEATS & SISSY BARS
- EXHAUST**
- FUEL/AIR SYSTEMS
- ENGINE
- TRANSMISSION & DRIVELINE
- GASKETS & SEALS
- ELECTRICAL
- LIGHTING
- HANDLEBARS, CONTROLS & MIRRORS
- CABLES
- BRAKES
- TANKS & OIL FILTERS
- DASHES & GAUGES
- FRAMES & SUSPENSION
- FENDERS & LICENSE PLATE FRAMES
- FOOTRESTS & FLOORBOARDS
- WHEELS & AXLES
- HARDWARE, COVERS & GENERAL



WINDSHIELDS & FAIRINGS

AUDIO, COMMUNICATION & MOUNTS

SADDLEBAGS & LUGGAGE

SEATS & SISSY BARS

EXHAUST

FUEL SYSTEMS

ENGINE

TRANSMISSION & DRIVELINE

GASKETS & SEALS

ELECTRICAL

LIGHTING

HANDLEBARS, CONTROLS & MIRRORS

CABLES

BRAKES

TANKS & OIL FILTERS

DASHES & GAUGES

FRAMES & SUSPENSION

FENDERS & LICENSE PLATE FRAMES

FOOTRESTS & FLOORBOARDS

WHEELS & AXLES

HARDWARE, COVERS & GENERAL



1811-3434



1811-3435

TRUE DUAL PERFORMANCE EXHAUSTS

- 1³/₄" equal length headers
- 4" straight can mufflers with removable baffles
- Slant cut billet aluminum end caps
- Includes full heat shields
- 18mm O₂ bungs with 12mm O₂ adapters included
- Made in the U.S.A.

FOR 14-19 CHIEFTAIN

PART #	DESCRIPTION	SUG. RETAIL	PART #	DESCRIPTION	SUG. RETAIL
1811-3434	Black w/ black end caps	\$1,399.95	1811-3435	Chrome w/ polished end caps	\$1,379.95



1810-2352



1810-2355

ROAD RAGE 2-INTO-1 EXHAUST SYSTEMS

- Uses 2-into-1 equal-length 1³/₄" to 1⁷/₈" header pipes
- Advanced inner collector maximizes performance gains
- Includes heat shields and all necessary installation hardware
- Available with long or short megaphone-style muffler
- Show chrome or black ceramic finish available
- Made in the U.S.A.

FOR 15-19 SCOUT/SCOUT SIXTY/SCOUT BOBBER

PART #	DESCRIPTION	SUG. RETAIL	PART #	DESCRIPTION	SUG. RETAIL
WITH SHORT MEGAPHONE MUFFLER			WITH LONG MEGAPHONE MUFFLER		
1810-2352	Chrome	\$799.95	1810-2354	Chrome	\$799.95
1810-2353	Black ceramic	859.95	1810-2355	Black ceramic	859.95

DISCLAIMER: NOT LEGAL FOR SALE OR USE IN CALIFORNIA ON ANY POLLUTION CONTROLLED MOTOR VEHICLES. SEE PAGE 4 FOR IMPORTANT EMISSION DEFINITIONS AND REGULATORY COMPLIANCE AND WARRANTY INFORMATION.

All part numbers in **BLUE** are new for 2019.



1811-2689

4" PERFORMANCE SLIP-ON MUFFLERS

- Chromed 4" slip-on mufflers mount to stock headpipes and fit under hard bags
- Gives your bike a unique style, performance and sound
- Come with a 4" slash-cut polished end cap
- Constructed from 16-gauge stainless steel with a chrome finish
- Optional 4" end caps available separately
- Necessary hardware included
- Made in the U.S.A.

PART #	FITS MODEL	SUG. RETAIL	PART #	DESCRIPTION	SUG. RETAIL
SLIP-ON MUFFLERS			OPTIONAL QUICK-CHANGE END CAPS		
1811-2689	For 14-19 Chieftain w/ hard bags, 14-19 Roadmaster	\$699.95	1861-0999	Black, fluted +1	\$69.95
1811-2690	For 14-19 Chief Vintage, 14-19 Chief Classic, 14-19 Chieftain w/o bags or w/ soft bags, 14-19 Darkhorse	649.95	1861-1000	Black, fluted +2	69.95
			1861-1001	Black, slash +1	69.95



1811-2905

1811-2906

CLASSIC 3" SLIP-ON MUFFLERS WITH TIP

- 16-gauge steel construction with chrome or black finish
- Include mounting hardware
- Include chrome or black billet end cap
- 50% lighter than stock mufflers
- Increase power and performance
- Made in the U.S.A.

PART #	DESCRIPTION	SUG. RETAIL
FOR 15-19 SCOUT/SCOUT SIXTY, 18-19 SCOUT BOBBER		
1811-2905	Chrome	\$499.95
1811-2906	Black	499.95

DISCLAIMER: NOT LEGAL FOR SALE OR USE IN CALIFORNIA ON ANY POLLUTION CONTROLLED MOTOR VEHICLES. SEE PAGE 4 FOR IMPORTANT EMISSION DEFINITIONS AND REGULATORY COMPLIANCE AND WARRANTY INFORMATION.

All part numbers in **BLUE** are new for 2019.

WINDSHIELDS & FAIRINGS

AUDIO, COMMUNICATION & MOUNTS

SADDLEBAGS & LUGGAGE

SEATS & SISSY BARS

EXHAUST

FUEL/AIR SYSTEMS

ENGINE

TRANSMISSION & DRIVELINE

GASKETS & SEALS

ELECTRICAL

LIGHTING

HANDLEBARS, CONTROLS & MIRRORS

CABLES

BRAKES

TANKS & OIL FILTERS

DASHES & GAUGES

FRAMES & SUSPENSION

WHEELS & AXLES

FOOTRESTS & FLOORBOARDS

WHEELS & AXLES

HARDWARE, COVERS & GENERAL

WINDSHIELDS & FAIRINGS

AUDIO, COMMUNICATION & MOUNTS

SADDLEBAGS & LUGGAGE

SEAT & SISSE

EXHAUST

FUEL/AIR SYSTEMS

ENGINE

TRANSMISSION & DRIVELINE

GASKETS & SEALS

ELECTRICAL

LIGHTING

HANDLEBARS, CONTROLS & MIRRORS

CABLES

BRAKES

TANKS & OIL FILTERS

DASHES & GAUGES

FRAMES & SUSPENSION

FENDERS & LICENSE PLATE FRAMES

FOOTRESTS & FLOORBOARDS

WHEELS & AXLES

HARDWARE, COVERS & GENERAL



1811-3397



1811-3399

SLIP-ON MUFFLERS

- 6-gauge steel construction
- Include mounting hardware and instructions
- Available in black or chrome
- Made in the U.S.A.

NOTE: Installation of new exhaust system may change fuel-air mixture requirements.

PART #	DESCRIPTION	SUG. RETAIL
FOR 15-19 SCOUT/SCOUT SIXTY/SCOUT BOBBER		
1811-3397	3" black with slash-cut end cap (removable baffles)	\$499.95
1811-3398	3" chrome with slash-cut end cap (removable baffles)	499.95
1811-3399	2 1/4" chrome fishtail (non-removable baffles)	499.95



2 1/4" CHROME MUFFLERS WITH FISHTAIL END CAPS

- 16-gauge steel construction with chrome finish and fishtail tips
- Includes mounting hardware
- Baffles are not removable
- Made in the U.S.A.

PART #	DESCRIPTION	SUG. RETAIL
1811-2907	For 15-19 Scout/Scout Sixty/Scout Bobber	\$499.95

DISCLAIMER: NOT LEGAL FOR SALE OR USE IN CALIFORNIA ON ANY POLLUTION CONTROLLED MOTOR VEHICLES. SEE PAGE 4 FOR IMPORTANT EMISSION DEFINITIONS AND REGULATORY COMPLIANCE AND WARRANTY INFORMATION.

All part numbers in **BLUE** are new for 2019.

**VANCE
HINES**



**HI-OUTPUT
GRENADES 2-INTO-2
EXHAUST SYSTEM**

- Features an innovative three-step muffler shape with CNC-machined billet end caps
- Discreet crossover section maintains the aggressive 2-into-2 look
- Aggressive, pulse-quickenning exhaust note
- Made in the U.S.A.

PART #	DESCRIPTION	SUG. RETAIL
FOR 15-19 SCOUT/SCOUT SIXTY, 18-19 SCOUT BOBBER		
1800-1917	Matte black	\$899.99



**4" TURN DOWN
SLIP-ON MUFFLERS**

- Gorgeous nostalgic styling
- Deep rich tone
- 2 1/2" fiberglass wrapped perforated core baffle
- Beautiful chrome finish with scalloped end caps
- Sold in pairs
- Made in the U.S.A.

PART #	DESCRIPTION	SUG. RETAIL
FOR 14-16 CHIEFTAIN/ROADMASTER		
1801-0728	Chrome	\$749.99

DISCLAIMER: NOT LEGAL FOR SALE OR USE IN CALIFORNIA ON ANY POLLUTION CONTROLLED MOTOR VEHICLES. SEE PAGE 4 FOR IMPORTANT EMISSION DEFINITIONS AND REGULATORY COMPLIANCE AND WARRANTY INFORMATION.

All part numbers in **BLUE** are new for 2019.

- WINDSHIELDS & FAIRINGS
- AUDIO, COMMUNICATION & MOUNTS
- SADDLEBAGS & LUGGAGE
- SEATS & SISSY BARS
- EXHAUST**
- FUEL/AIR SYSTEMS
- ENGINE
- TRANSMISSION & DRIVELINE
- GASKETS & SEALS
- ELECTRICAL
- LIGHTING
- HANDLEBARS, CONTROLS & MIRRORS
- CABLES
- BRAKES
- TANKS & OIL FILTERS
- DASHES & GAUGES
- FRAMES & SUSPENSION
- FENDERS & LICENSE PLATE FRAMES
- FOOTRESTS & FLOORBOARDS
- WHEELS & AXLES
- HARDWARE, COVERS & GENERAL

**VANCE
HINES**



**4" CLASSIC
SLIP-ON MUFFLERS**

- Large 4" diameter mufflers finished with beautifully embellished CNC-machined billet end caps add that extra touch of style
- Fiberglass insulated acoustic baffles provide a deep rich rumble to the powerful Thunder Stroke 111 engine
- Include all necessary hardware and mounting instructions for a hassle-free, perfect fit every time
- Sold in pairs
- Made in the U.S.A.

PART #	DESCRIPTION	SUG. RETAIL
FOR 14-16 CHIEFTAIN/ROADMASTER		
1801-0829	Chrome	\$749.99



**TWIN SLASH 4" ROUND
SLIP-ON MUFFLERS**

- Give your bike a clean, classic look and an aggressive exhaust note
- Feature 45° slash-cut ends
- Brilliant chrome finish
- Optional quiet baffle sold separately
- Sold in pairs
- Made in the U.S.A.

FOR 15-19 SCOUT/SCOUT SIXTY, 18-19 SCOUT BOBBER					
PART #	DESCRIPTION	SUG. RETAIL	PART #	DESCRIPTION	SUG. RETAIL
1801-0857	Slip-on mufflers	\$499.99	1861-1075	Opt. quiet baffle (ea.)	\$59.99

DISCLAIMER: NOT LEGAL FOR SALE OR USE IN CALIFORNIA ON ANY POLLUTION CONTROLLED MOTOR VEHICLES. SEE PAGE 4 FOR IMPORTANT EMISSION DEFINITIONS AND REGULATORY COMPLIANCE AND WARRANTY INFORMATION.

All part numbers in **BLUE** are new for 2019.

WINDSHIELDS & FAIRINGS

AUDIO, COMMUNICATION & MOUNTS

SADDLEBAGS & LUGGAGE

SEATS & SISSY BARS

EXHAUST

FUEL/AIR SYSTEMS

ENGINE

TRANSMISSION & DRIVELINE

GASKETS & SEALS

ELECTRICAL

LIGHTING

HANDLEBARS, CONTROLS & MIRRORS

CABLES

BRAKES

TANKS & OIL FILTERS

DASHES & GAUGES

FRAMES & SUSPENSION

FENDERS & LICENSE PLATE FRAMES

FOOTRESTS & FLOORBOARDS

WHEELS & AXLES

HARDWARE, COVERS & GENERAL



1801-1230



1801-1231



TWIN SLASH 3" SLIP-ON MUFFLERS

- Designed with the signature Vance & Hines twin slash end treatment rotated out 45°
- Bring out the roar of the Scout's aggressive double overhead cam engine
- Include full coverage heat shields
- Quick and cost-effective upgrade for the Scout
- Available in chrome or black
- Optional baffles sold separately
- Include mounting hardware and installation instructions
- Sold in pairs
- Made in the U.S.A.



1861-0570

1861-0571

PART #	DESCRIPTION	SUG. RETAIL
FOR 15-19 SCOUT/SCOUT SIXTY, 18-19 SCOUT BOBBER		
1801-1230	Chrome	\$399.99
1801-1231	Black	399.99

PART #	DESCRIPTION	SUG. RETAIL
OPTIONAL BAFFLES		
1861-0571	Quiet baffle (ea.)	\$54.99
1861-0570	Competition baffle (ea.)	39.99



1811-3439



1811-3438



TRACK SLIP-ON MUFFLERS

- Deep sound with race inspired looks
- Matching billet aluminum end caps
- Easy installation
- Optional quiet baffle sold separately
- All required hardware included
- Sold in pairs
- Made in the U.S.A.



1861-1242

PART #	DESCRIPTION	SUG. RETAIL
FOR 15-19 SCOUT/SCOUT SIXTY, 18-19 SCOUT BOBBER		
1811-3439	Black	\$499.99
1811-3438	Chrome	479.99

PART #	DESCRIPTION	SUG. RETAIL
FOR 15-19 SCOUT/SCOUT SIXTY, 18-19 SCOUT BOBBER (CONT)		
1861-1242	Opt. quiet baffle (ea.)	\$24.99

DISCLAIMER: NOT LEGAL FOR SALE OR USE IN CALIFORNIA ON ANY POLLUTION CONTROLLED MOTOR VEHICLES. SEE PAGE 4 FOR IMPORTANT EMISSION DEFINITIONS AND REGULATORY COMPLIANCE AND WARRANTY INFORMATION.

All part numbers in **BLUE** are new for 2019.

- WINDSHIELDS & FAIRINGS
- AUDIO, COMMUNICATION & MOUNTS
- SADDLEBAGS & LUGGAGE
- SEATS & SISSY BARS
- EXHAUST**
- FUEL/AIR SYSTEMS
- ENGINE
- TRANSMISSION & DRIVELINE
- GASKETS & SEALS
- ELECTRICAL
- LIGHTING
- HANDLEBARS, CONTROLS & MIRRORS
- CABLES
- BRAKES
- TANKS & OIL FILTERS
- DASHES & GAUGES
- FRAMES & SUSPENSION
- FENDERS & LICENSE PLATE FRAMES
- FOOTRESTS & FLOORBOARDS
- WHEELS & AXLES
- HARDWARE, COVERS & GENERAL

WINDSHIELDS & FAIRINGS

AUDIO, COMMUNICATION & MOUNTS

SADDLEBAGS & LUGGAGE

SEATS & SISSY BARS

EXHAUST

FUEL/AIR SYSTEMS

ENGINE

TRANSMISSION & DRIVELINE

GASKETS & SEALS

ELECTRICAL

LIGHTING

HANDLEBARS, CONTROLS & MIRRORS

CABLES

BRAKES

TANKS & OIL FILTERS

DASHES & GAUGES

FRAMES & SUSPENSION

FENDERS & LICENSE PLATE FRAMES

FOOTRESTS & FLOORBOARDS

WHEELS & AXLES

HARDWARE, COVERS & GENERAL



1811-3332



1811-3334



KHROME WERKS

4" HP-PLUS® PERFORMANCE MUFFLERS

- Cat-back mufflers provide a deep, mellow exhaust tone
- Horsepower and torque gains over stock mufflers are achieved in part by an internal expansion chamber in the baffle core
- The steel baffle core is machine wrapped, first with a stainless steel wool, then with a high-temperature fiberglass blanket for acoustic longevity assurance
- Muffler shell is finished in highly polished, duplex nickel chrome
- Designed to enhance top-end power while retaining good low-end torque
- The one-piece, 16-gauge steel tubing muffler shell is finished in highly polished, duplex nickel chrome

- Mufflers feature black billet tips; mufflers for hard bag Chieftain models feature saddlebag protectors (shown)
- Install using factory mounting hardware, clamps and heat shields
- Sold in pairs
- Made in the U.S.A.

PART #	DESCRIPTION	SUG. RETAIL
1811-3332	For 14-19 Chief Classic, Chief Vintage	\$699.95
1811-3333	For 14-19 Chieftain, Roadmaster	729.95

PART #	DESCRIPTION	SUG. RETAIL
1811-3334	For 15-19 Scout/Scout Sixty/Scout Bobber	\$499.95



CRUSHER

CRUSHER MAVERICK SLIP-ONS

- Shed pounds and gain a 5% increase in horsepower without intake or header upgrades
- Slim 2.5" muffler diameter flaunts the Scout's smooth lines and matches the stock headers to preserve the lean profile of traditional staggered dual exhausts
- Aggressively-styled billet aluminum tips with high-temp black ceramic coating and brushed stainless steel banding
- Premium, chrome-plated steel
- High-flow baffles produce a throaty exhaust note when cracking the throttle
- 5% horsepower gain without intake, header or fuel mapping modifications
- Simple, bolt-on installation with included bracket and hardware
- Approximately 14 lb. lighter than stock mufflers
- Made in the U.S.A.

PART #	DESCRIPTION	SUG. RETAIL
1811-3429	For 15-19 Scout/Scout Sixty/Scout Bobber	\$479.99

DISCLAIMER: NOT LEGAL FOR SALE OR USE IN CALIFORNIA ON ANY POLLUTION CONTROLLED MOTOR VEHICLES. SEE PAGE 4 FOR IMPORTANT EMISSION DEFINITIONS AND REGULATORY COMPLIANCE AND WARRANTY INFORMATION.

All part numbers in **BLUE** are new for 2019.



- WINDSHIELDS & FAIRINGS
- AUDIO, COMMUNICATION & MOUNTS
- SADDLEBAGS & LUGGAGE
- SEATS & SISSY BARS

EXHAUST

- DRIVE SHAFT
- EMISSION
- DRIVELINE

GASKETS & SEALS

ELECTRICAL

LIGHTING

HANDLEBARS, CONTROLS & MIRRORS

CABLES

BRAKES

TANKS & OIL FILTERS

DASHES & GAUGES

FRAMES & SUSPENSION

FENDERS & LICENSE PLATE FRAMES

FOOTRESTS & FLOORBOARDS

WHEELS & AXLES

HARDWARE, COVERS & GENERAL



SLIP-ON MUFFLERS

- Serious bolt-on performance
- Aggressive sound
- Huge increase in flow over the stock units
- Tunable 3" internal disc-based mufflers, with completely rebuildable cores
- Chrome-plated 3.5" muffler bodies
- Supplied with chrome-plated removable tapered end caps, discs, closed end caps and all mounting hardware
- Sold in pairs
- Made in the U.S.A.

PART #	DESCRIPTION	SUG. RETAIL
1801-0991	For 15-19 Scout/Scout Sixty/Scout Bobber	\$648.95



4" SLIP-ON MUFFLERS

- 4" muffler body
- 2.5" perforated core, with 2" steps
- Proprietary Cobra pillow insulation
- 4" billet aluminum scalloped tip

PART #	DESCRIPTION	SUG. RETAIL
1811-2851	For 15-16 Chief/Chieftain/Roadmaster	\$399.95

DISCLAIMER: NOT LEGAL FOR SALE OR USE IN CALIFORNIA ON ANY POLLUTION CONTROLLED MOTOR VEHICLES. SEE PAGE 4 FOR IMPORTANT EMISSION DEFINITIONS AND REGULATORY COMPLIANCE AND WARRANTY INFORMATION.

All part numbers in **BLUE** are new for 2019.

WINDSHIELDS & FAIRINGS

AUDIO, COMMUNICATION & MOUNTS

SADDLEBAGS & LUGGAGE

SEATS & SISSY BARS

EXHAUST

FUEL/AIR SYSTEMS

ENGINE

TRANSMISSION & DRIVELINE

GASKETS & SEALS

ELECTRICAL

LIGHTING

HANDLEBARS, CONTROLS & MIRRORS

CABLES

BRAKES

TANKS & OIL FILTERS

DASHES & GAUGES

FRAMES & SUSPENSION

FENDERS & LICENSE PLATE FRAMES

FOOTRESTS & FLOORBOARDS

WHEELS & AXLES

HARDWARE, COVERS & GENERAL



Fi2000 POWRPRO BLACK

- Requires no dyno tuning – plug it in and ride
- PowrPro Black analyzes, tunes and adjusts your air/fuel ratio for peak performance instantaneously
- Tunes acceleration fuel delivery in every gear for peak performance
- Works with stock or modified engines, air cleaners and exhaust systems
- Can fine-tune the non-acceleration air/fuel curves using the Bluetooth® app
- Can tune engine fuel delivery in specific ranges, check rpm, read fuel injector pulse width and duty cycle, and add or remove fuel in low- or mid-range rpm



PART #	DESCRIPTION	SUG. RETAIL	PART #	DESCRIPTION	SUG. RETAIL
1020-2653	For 14-16 Chief	\$519.95	1020-2654	For 15-17 Scout/Sixty	\$519.95



FUELPAK LCD

- Throttle position sensor-based system simplifies the process of fuel-injection tuning
- Enables you to fine-tune the fuel mixture throughout the entire rpm range with the touch of a button
- Increases power and improves throttle response
- Very user friendly; plugs into the existing harness on the bike
- No computer or software is required; simply punch in the values provided on the V&H website
- Values provided are for use with Vance & Hines exhaust systems
- Fuelpak will also work with other exhaust systems (contact V&H tech support for tuning information)
- Includes all necessary mounting hardware



NOTE: Requires the use of a high-performance air filter.

PART #	DESCRIPTION	SUG. RETAIL
1020-2694	For 15-17 Scout	\$299.99



POWER COMMANDER V

- Fuel control for each individual cylinder in a smaller enclosure
- "Warm-up" fuel adjustment (unit reads engine temp and allows fuel/timing adjustments based on the reading)
- Includes ignition adjustment feature; allows full ignition timing control of each cylinder
- Easy to install
- USB powered from computer; 9 volt adapter is no longer needed
- Two-position map-switching function built in
- Can add any Single Pole Single Throw (SPST) switch and toggle between two different fuel maps



- Gear/speed input allows for map adjustment based on gear
- Analog input allows user to install any 0-5 volt sensor
- Build an adjustment table based on analog input such as boost or temperature
- Power Commander V is capable of allowing each cylinder to be mapped individually and for each gear with the gear position input connected
- Enhanced "accel pump" utility
- Made in the U.S.A.

PART #	DESCRIPTION	SUG. RETAIL	PART #	DESCRIPTION	SUG. RETAIL	PART #	DESCRIPTION	SUG. RETAIL
1020-2130	For 14-18 Chief	\$419.95	1020-2960 ¹	For 15-18 Scout	\$419.95	1020-2628 ¹	For 17-18 Scout Sixty	\$419.95

¹ Includes ignition adjustment.

DISCLAIMER: NOT LEGAL FOR SALE OR USE IN CALIFORNIA ON ANY POLLUTION CONTROLLED MOTOR VEHICLES. SEE PAGE 4 FOR IMPORTANT EMISSION DEFINITIONS AND REGULATORY COMPLIANCE AND WARRANTY INFORMATION.

All part numbers in **BLUE** are new for 2019.



- WINDSHIELDS & FAIRINGS
- AUDIO, COMMUNICATION & MOUNTS
- SADDLEBAGS & LUGGAGE
- SEATS & SISSY BARS
- EXHAUST
- FUEL/AIR SYSTEMS
- ENGINE
- TRANSMISSION & DRIVELINE
- GASKETS & SEALS
- ELECTRICAL
- LIGHTING
- HANDLEBARS, CONTROLS & MIRRORS
- CABLES
- BRAKES
- TANKS & OIL FILTERS
- DASHES & GAUGES
- FRAMES & SUSPENSION
- FENDERS & LICENSE PLATE FRAMES
- FOOTRESTS & FLOORBOARDS
- WHEELS & AXLES
- HARDWARE, COVERS & GENERAL



POWER VISION CX

- Flash performance tunes via OEM diagnostic connector; no need to remove and send out ECU
- Weather-resistant for use in all conditions
- High-contrast display, viewable in direct sunlight
- Fueling revised for maximum power and torque
- Tunes available for popular aftermarket modifications
- Spark timing optimized for 91-93 octane fuel
- Rev limit and speed limits raised
- Torque limiting functions reduced or eliminated
- Revised drive-by-wire throttle profiles

PART #	DESCRIPTION	SUG. RETAIL
1020-2670	For 17-18 Scout Sixty	\$399.95
1020-2668	For 15-18 Scout	399.95
1020-2669	For 14-17 Thunderstroke 111ci	399.95

UNIVERSAL POWER VISION CX

- Flash performance tunes via OEM diagnostic connector, no need to remove and send out ECU
- Display vehicle data channels in real time
- Weather-resistant design for use in all conditions
- High-contrast display is viewable in direct sunlight
- Fueling revised for maximum power and torque
- Tunes available for popular aftermarket modifications
- Spark timing optimized for 91-93 octane fuel
- Rev limit and speed limits raised
- Torque limiting functions reduced or eliminated
- Revised drive-by-wire throttle profiles
- Does not come pre-loaded with tunes

PART #	DESCRIPTION	SUG. RETAIL
1020-2820	For all Indian models	\$399.95

POD-300 DIGITAL DISPLAY

- Real-time fuel adjustment
- Display channels real-time: RPM, TP, map position (when using map switch), duty cycle, fuel exchange, ignition change and wideband air/fuel ratio (w/ WB2 or auto-tune connected)
- Weather resistant for use in all conditions
- Log channels saved to internal memory and can be viewed/analyzed with Dynojet's powercore software
- High-contrast display, viewable in sunlight
- Includes CAN cable for attachment to Power Commander V, Auto Tune and Wide Band Power Commander

NOTE: Not for use with Power Commander III USB.



PART #	DESCRIPTION	SUG. RETAIL
1020-2371	POD-300 digital display	\$249.95

POWER COMMANDER V MAP SELECT SWITCH

- Switches between two different maps that have been pre-loaded in a Power Commander V
- Comes with a switch, wiring and instructions
- Universal mount

PART #	DESCRIPTION	SUG. RETAIL
1020-2082	Map select switch	\$49.95



DISCLAIMER: NOT LEGAL FOR SALE OR USE IN CALIFORNIA ON ANY POLLUTION CONTROLLED MOTOR VEHICLES. SEE PAGE 4 FOR IMPORTANT EMISSION DEFINITIONS AND REGULATORY COMPLIANCE AND WARRANTY INFORMATION.

All part numbers in **BLUE** are new for 2019.

WINDSHIELDS & FAIRINGS

AUDIO, COMMUNICATION & MOUNTS

SADDLEBAGS & LUGGAGE

SEATS & SISSY BARS

EXHAUST

FUEL/AIR SYSTEMS

ENGINE

TRANSMISSION & DRIVELINE

GASKETS & SEALS

ELECTRICAL

LIGHTING

HANDLEBARS, CONTROLS & MIRRORS

CABLES

BRAKES

TANKS & OIL FILTERS

DASHES & GAUGES

FRAMES & SUSPENSION

FENDERS & LICENSE PLATE FRAMES

FOOTRESTS & FLOORBOARDS

WHEELS & AXLES

HARDWARE, COVERS & GENERAL



AIR CLEANER KITS WITH COVERS

- Engineered to boost performance
- High-flow air filter provides twice the surface area of the stock filter for up to 37% more airflow and a five horsepower gain
- Design maintains leg clearance
- Billet aluminum construction with a high-quality, washable and re-usable cotton gauze air filter element
- Covers are made from billet aluminum and show-chrome plated
- Optional S&S® Pre-filter available separately
- Made in the U.S.A.

NOTE: Exempt per Carb Executive Order (EO) #D-355-23 for 14-18 models.



1010-2400

1010-2402

PART #	DESCRIPTION	SUG. RETAIL
FOR 14-19 CHIEF CLASSIC, CHIEF VINTAGE, CHIEFTAIN AND ROADMASTER MODELS		
1010-2400	W/ Nostalgic Script cover	\$420.95
1010-2402	W/ S&S Logo cover	420.95



1010-2409

AIR CLEANER KIT AND OPTIONAL COVERS

- Engineered to boost performance
- High-flow air filter provides twice the surface area of the stock filter for up to 37% more airflow and a five horsepower gain
- Design maintains leg clearance
- Billet aluminum construction with a high-quality, washable and re-usable cotton gauze air filter element
- Covers not included, optional air cleaner covers sold separately; must order an air cleaner kit and cover for a complete assembly
- Covers are made from billet aluminum and show-chrome plated
- Optional S&S® Pre-filter available separately
- Made in the U.S.A.

NOTE: Exempt per Carb Executive Order (EO) #D-355-23 for 14-18 models.



1014-0219



1014-0220



PART #	DESCRIPTION	SUG. RETAIL
AIR CLEANER W/O COVER		
1010-2409	For 14-19 Chief, Chief Classic, Chief Vintage, Roadmaster	\$304.95
OPTIONAL CHROME COVERS		
1014-0219	S&S Nostalgic Script air cleaner cover	123.95
1014-0220	S&S logo air cleaner cover	123.95



STEALTH TWO AIR CLEANER KIT

- One-piece, black molded filter body with blue element
- Element constructed of pleated cotton
- Made in the U.S.A.

NOTE: Exempt per Carb Executive Order (EO) #D-355-23 for 15-18 models.

PART #	DESCRIPTION	SUG. RETAIL
1010-2401	14-19 Scout, Scout Sixty, Scout Bobber	\$152.95



AIR FILTER PRE-FILTER

- Water resistant and traps large dirt particles
- For use with S&S air cleaners

PART #	DESCRIPTION	SUG. RETAIL
1011-3491	S&S pre-filter	\$43.95



KURYAKYN

VANTAGE AIR CLEANERS

- Designed by John Shope of Dirty Bird Concepts
- Forward-facing and rear openings allow additional airflow, while stainless steel mesh inserts add aggressive styling and block debris
- Modular outer cover design allows custom finish applications with minimal prep work
- Available in chrome or gloss black finish, with contrasting satin black inserts
- Includes high-performance K&N synthetic filter element that's washable and reusable



1010-2492



1010-2493

PART #	DESCRIPTION	SUG. RETAIL	PART #	DESCRIPTION	SUG. RETAIL
FOR ALL 14-19 INDIAN MODELS (EXCEPT SCOUT MODELS)			FOR ALL 14-19 INDIAN MODELS (EXCEPT SCOUT MODELS) (CONT)		
1010-2492	Chrome and black	\$349.99	1010-2493	Gloss black	\$349.99

DISCLAIMER: NOT LEGAL FOR SALE OR USE IN CALIFORNIA ON ANY POLLUTION CONTROLLED MOTOR VEHICLES. SEE PAGE 4 FOR IMPORTANT EMISSION DEFINITIONS AND REGULATORY COMPLIANCE AND WARRANTY INFORMATION.

All part numbers in **BLUE** are new for 2019.



VINTAGE AIR CLEANERS

- Designed for a timeless look
- Prominently placed headbolt
- Available in chrome, Contrast Cut and Black Ops finishes



1010-2239



1010-2240



1010-2241

PART #	DESCRIPTION	SUG. RETAIL
FOR 14-19 CHIEFTAIN		
1010-2239	Contrast Cut™	\$499.95

PART #	DESCRIPTION	SUG. RETAIL
FOR 14-19 CHIEFTAIN (CONT)		
1010-2240	Chrome	\$499.95

PART #	DESCRIPTION	SUG. RETAIL
FOR 14-19 CHIEFTAIN (CONT)		
1010-2241	Black Ops	\$499.95

1010-1977



MAX HP AIR CLEANER

- CNC-machined aluminum backing plate
- Internal rubber breather tubes to eliminate oil leakage
- Internal power cone design for smooth, laminar air flow
- Innovative conical design for improved knee clearance
- Contrast Cut™ finish starts with a polished air cleaner that has been black anodized, then recut to open the design
- All mounting hardware and gaskets included
- Made in the U.S.A.



1010-1978



TRASK

POWERFLOW AIR CLEANER

- Improves airflow and efficiency of engine
- Increases horsepower and torque with no additional remapping
- High-quality rubber construction, six layers of cotton gauze and epoxy-coated wire mesh
- Durable, washable and reusable
- Made in the U.S.A.



PART #	DESCRIPTION	SUG. RETAIL
FOR 14-19 CHIEFTAIN		
1010-1977	Contrast Cut™	\$449.95

PART #	DESCRIPTION	SUG. RETAIL
FOR 14-19 CHIEFTAIN (CONT)		
1010-1978	Chrome	\$449.95

PART #	DESCRIPTION	SUG. RETAIL
1010-1967	For 15-19 Scout/Scout Sixty/ Scout Bobber	\$149.95



HIGH-FLOW AIR FILTERS™

- Designed to provide increased performance
- Pleated media provides a large filtration area offering long service intervals
- Multi-layers of woven cotton gauze media offers excellent filtration
- Fits directly into OEM airbox with application specific Sealing Bead to ensure a precise fit
- Fuel-management modifications are not required for increased performance
- Washable and reusable, pre-oiled and ready to ride
- Made in the U.S.A. for over 45 years



1011-3818



1011-1278

FITS MODEL

For 14-19 Chief, Chieftain, Roadmaster, Springfield
For 09-13 Chief

For 15-19 Scout, Scout Sixty, Scout Bobber

6" OD x 4⁵/₈" ID x 2³/₄" H fits stock S&S teardrop backing plate and Indian teardrop outer cover

PART # SUG. RETAIL

1011-3818 \$91.95

1011-3837 63.95

1011-3730 78.95

1011-1278 88.95



OEM-STYLE REPLACEMENT AIR FILTER ELEMENTS

- High-quality paper filter medium
- Meets or exceeds OEM specifications
- For use with OEM stock air filter housings



1011-3523



1011-3522



APPLICATION CHART

FITS MODEL	PART #	SUG. RETAIL
14-19 Chief Classic/Vintage/Chieftain	1011-3523	\$36.95
15-19 Chief Classic/Vintage	1011-3523	36.95

FITS MODEL	PART #	SUG. RETAIL
15-19 Chieftain/Roadmaster	1011-3523	\$36.95
15-19 Scout, 16-19 /Scout Sixty/Scout Bobber	1011-3522	17.95

DISCLAIMER: NOT LEGAL FOR SALE OR USE IN CALIFORNIA ON ANY POLLUTION CONTROLLED MOTOR VEHICLES. SEE PAGE 4 FOR IMPORTANT EMISSION DEFINITIONS AND REGULATORY COMPLIANCE AND WARRANTY INFORMATION.

All part numbers in **BLUE** are new for 2019.

WINDSHIELDS & FAIRINGS

AUDIO, COMMUNICATION & MOUNTS

SADDLEBAGS & LUGGAGE

SEATS & SISSY BARS

EXHAUST

FUEL/AIR SYSTEMS

ENGINE

TRANSMISSION & DRIVELINE

GASKETS & SEALS

ELECTRICAL

LIGHTING

HANDLEBARS, CONTROLS & MIRRORS

CABLES

BRAKES

TANKS & OIL FILTERS

DASHES & GAUGES

FRAMES & SUSPENSION

FENDERS & LICENSE PLATE FRAMES

FOOTRESTS & FLOORBOARDS

WHEELS & AXLES

HARDWARE, COVERS & GENERAL

WINDSHIELDS & FAIRINGS

AUDIO, COMMUNICATION & MOUNTS

SADDLEBAGS & LUGGAGE

SEATS & SISSY BARS

EXHAUST

FUEL/AIR SYSTEMS

ENGINE

TRANSMISSION & DRIVELINE

GASKETS & SEALS

ELECTRICAL

LIGHTING

HANDLEBARS, CONTROLS & MIRRORS

CABLES

BRAKES

TANKS & OIL FILTERS

DASHES & GAUGES

FRAMES & SUSPENSION

FENDERS & LICENSE PLATE FRAMES

FOOTRESTS & FLOORBOARDS

WHEELS & AXLES

HARDWARE, COVERS & GENERAL



0712-0479

OIL FILTERS

- High-quality spin-on filter
- A dependable replacement for OEM
- Available in chrome or black

BLACK	SUG. RETAIL	CHROME	SUG. RETAIL
FOR 14-19 CHIEF CLASSIC/DARK HORSE/VINTAGE/VINTAGE LE /SPRINGFIELD			
0712-0479	\$7.95	0712-0480	\$9.95
FOR 14-19 CHIEFTAIN			
0712-0479	7.95	0712-0480	9.95
FOR 15-19 ROADMASTER			
0712-0479	7.95	0712-0480	9.95
FOR 15-19 SCOUT, SCOUT SIXTY, SCOUT BOBBER			
0712-0479	7.95	0712-0480	9.95



MOTORCYCLE OIL FILTER

- Dependable Fram protection for your motorcycle engine
- Complete change kit; all gaskets included

DESCRIPTION	PART #	SUG. RETAIL
14-19 Chieftain/Chief Classic/Vintage, 16-19 Dark Horse	PH6017	\$10.95
15-19 Roadmaster/Springfield	PH6017	10.95
15-19 Scout/Scout Sixty/Scout Bobber	PH6017	10.95



FLO STAINLESS STEEL, REUSABLE "SPIN-ON" OIL FILTER

- Made from laser-cut, medical-grade, 304 stainless steel micronic filter cloth, this filter provides 200% more filter area in many cases
- Stainless filter catches items down to 35 microns, which is about three times better than most good paper or brass filters
- Unlike glued paper filters, the FLO Oil Filter pleat seam is welded and able to withstand up to 600° F
- Filter maintains consistent flow under all conditions including extreme heat, the presence of water, and cold start-ups where paper filters can flow so poorly that they often cause the bypass valve to open and allow unfiltered oil to enter your engine
- Should be the last filter an owner ever needs; this high tech filter technology is widely used in all types of auto racing including NASCAR, Indy type cars, Formula 1 and in the aerospace industry where filtration is of the utmost importance
- FLO reference # PCS1

PART #	FITS MODEL	SUG. RETAIL
0712-0149	14-19 Chief Classic/Vintage, 16-19 Dark Horse	\$129.95
0712-0149	14-19 Chieftain, 15-19 Roadmaster, 15-19 Scout, 17-19 Springfield	129.95



CHROME TAPPET BLOCK ACCENT

- Finish off the OEM chrome look with this tappet block accent
- Creates a unique transition from the cylinder head to the motor block
- Simple installation

PART #	DESCRIPTION	SUG. RETAIL
0940-1359	For 14-19 Indian models (except Scout)	\$71.99

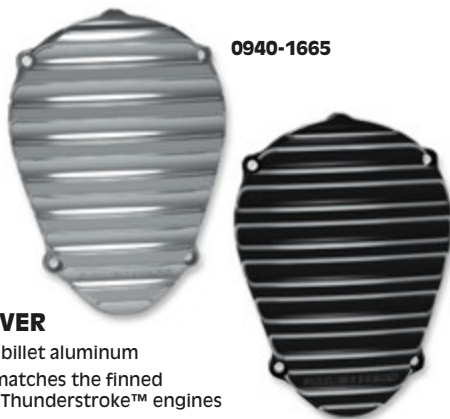

0940-1665

0940-1664



0940-1710



0940-1711



FINNED CAM COVER

- CNC-machined from billet aluminum
- 3D-sculpted design matches the finned rocker box's on 111" Thunderstroke™ engines
- Includes chrome hardware
- Choose from chrome or black anodize finish

PART #	DESCRIPTION	SUG. RETAIL
FOR 14-19 MODELS W/ 111" THUNDERSTROKE™ ENGINES		
0940-1665	Chrome	\$199.95
0940-1664	Black	199.95



AZTEC CAM COVER ACCENTS

- Direct replacement for the stock cam cover emblem with classy styling designed to complement the entire line of Aztec accessories for Indian
- Made from die-cast aluminum, with easy installation utilizing high-strength and high-temp VHB™ tape
- Available in chrome or satin black

PART #	DESCRIPTION	SUG. RETAIL
FOR 14-19 INDIAN MODELS (ALL EXCEPT SCOUT)		
0940-1710	Chrome	\$24.99
0940-1711	Satin black	24.99

DISCLAIMER: NOT LEGAL FOR SALE OR USE IN CALIFORNIA ON ANY POLLUTION CONTROLLED MOTOR VEHICLES. SEE PAGE 4 FOR IMPORTANT EMISSION DEFINITIONS AND REGULATORY COMPLIANCE AND WARRANTY INFORMATION.

All part numbers in **BLUE** are new for 2019.



KURYAKYN

ENGINE CYLINDER BASE COVER

- Covers the powder-coated left side cylinder base
- Made from quality aluminum with a flawless chrome finish
- Easy to install using high-strength, high-temp 3M® VHB™

PART #	DESCRIPTION	SUG. RETAIL
0940-1639	For 14-19 Indian models (except Scout models)	\$79.99



OUTRIDER RAD GUARD

- Guards the radiator against road debris
- Easy-to-install laser cut, honeycomb aluminum mesh screen
- Includes installation instructions and mounting adhesive
- Made in the U.S.A.



PART #	DESCRIPTION	SUG. RETAIL
1904-0092	For 15-19 Scout models	\$74.95



STATOR COVERS

- High-quality covers that add a custom touch
- Constructed of 6061-T6 aluminum
- Easy installation
- Available with a choice of black-anodized or chrome finishes
- Bomber series has brass rivets incorporated in the design for an industrial look
- Made in the U.S.A.

PART #	DESCRIPTION	SUG. RETAIL
FOR 15-19 SCOUT MODELS		
0940-1647	Bomber series black anodized	\$142.95
0940-1648	Bomber series chrome	142.95
0940-1649	Cross series black anodized w/ offset cut	142.95
0940-1650	Cross series chrome	142.95



0940-1648



0940-1649



1902-1384

KURYAKYN

COOLANT HOSE COVERS

- Minimizes engine heat by covering the water inlet
- Cast from quality aluminum
- Available in chrome or satin black finish
- Easy to install using factory bolts

PART #	DESCRIPTION	SUG. RETAIL
FOR 15-19 SCOUT MODELS		
1902-1384	Chrome	\$59.99
1902-1385	Satin black	59.99



1902-1383

1107-0562



1107-0565



CARL BROUHARD DESIGNS LLC

DERBY COVERS

- High-quality covers that add a custom touch
- Constructed of 6061-T6 aluminum
- Easy installation
- Available with a choice of black-anodized or chrome finishes
- Bomber series has brass rivets incorporated in the design for an industrial look
- Made in the U.S.A.

PART #	DESCRIPTION	SUG. RETAIL
FOR 15-19 SCOUT MODELS		
1107-0562	Bomber series black anodized	\$152.95
1107-0563	Bomber series chrome	152.95
1107-0564	Cross series black anodized w/ offset cut	152.95
1107-0565	Cross series chrome	152.95



KURYAKYN

LEGACY STATOR COVER

- Quality A380 cast aluminum construction with premium chrome plating
- Direct bolt-on replacement for the stock cover
- Includes new O-ring for installation

PART #	DESCRIPTION	SUG. RETAIL
2110-0957	For 15-19 Scout models	\$59.99

WINDSHIELDS & FAIRINGS

AUDIO, COMMUNICATION & MOUNTS

SADDLEBAGS & LUGGAGE

SEATS & SISSY BARS

EXHAUST

FUEL/AIR SYSTEMS

ENGINE

TRANSMISSION & DRIVELINE

GASKETS & SEALS

ELECTRICAL

LIGHTING

HANDLEBARS, CONTROLS & MIRRORS

CABLES

BRAKES

TANKS & OIL FILTERS

DASHES & GAUGES

FRAMES & SUSPENSION

FENDERS & LICENSE PLATE FRAMES

FOOTRESTS & FLOORBOARDS

WHEELS & AXLES

HARDWARE, COVERS & GENERAL

DISCLAIMER: NOT LEGAL FOR SALE OR USE IN CALIFORNIA ON ANY POLLUTION CONTROLLED MOTOR VEHICLES. SEE PAGE 4 FOR IMPORTANT EMISSION DEFINITIONS AND REGULATORY COMPLIANCE AND WARRANTY INFORMATION.

All part numbers in **BLUE** are new for 2019.

WINDSHIELDS & FAIRINGS

AUDIO, COMMUNICATION & MOUNTS

SADDLEBAGS & LUGGAGE

SEATS & SISSY BARS

EXHAUST

FUEL/AIR SYSTEMS

ENGINE

TRANSMISSION & DRIVELINE

GASKETS & SEALS

ELECTRICAL

LIGHTING

HANDLEBARS, CONTROLS & MIRRORS

CABLES

BRAKES

TANKS & OIL FILTERS

DASHES & GAUGES

FRAMES & SUSPENSION

FENDERS & LICENSE PLATE FRAMES

FOOTRESTS & FLOORBOARDS

WHEELS & AXLES

HARDWARE, COVERS & GENERAL

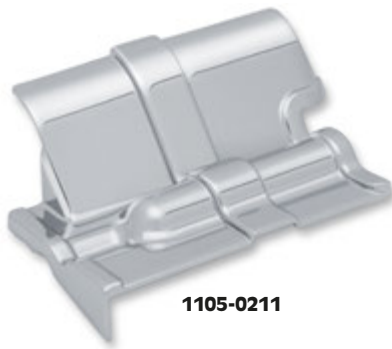

1105-0211



1120-0363



1120-0363

TRANSMISSION CENTER COVER

- Precisely sculpted and contoured to completely transform the dull, wrinkle black area of the transmission case behind the cylinders
- Made from premium chrome-plated, die-cast aluminum
- Installs in minutes using high-temp and high-strength VHB™ adhesive

PART #	DESCRIPTION	SUG. RETAIL
1105-0211	For 14-19 Indian models (except Scout, Scout Sixty, Scout Bobber)	\$79.99

INNER PRIMARY COVER

- Die-cast aluminum construction with a chrome finish
- Quick installation using high-strength 3M® VHB™ adhesive

PART #	DESCRIPTION	SUG. RETAIL
1120-0363	For 14-19 Indian models (except Scout/Scout Sixty/Scout Bobber)	\$119.99
1120-0402	VHB™ service kit for inner primary cover	9.99

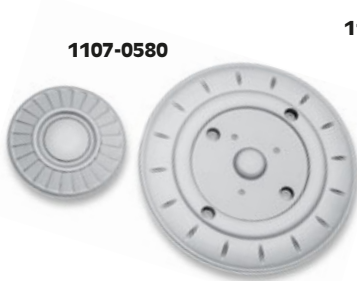

1107-0580

1107-0581



1107-0582

AZTEC PRIMARY COVERS

- Two-piece direct replacement for the stock cover made from quality aluminum with a grooved outer perimeter and center medallion featuring a stunning sundial design
- Includes primary cover and center medallion, which can also be purchased separately as a replacement if lost or damaged
- Aztec center medallion is sized to match Indian Commemorative Coins and other factory emblems intended for the primary, offering multiple custom options
- Available in chrome or satin black finish

PART #	DESCRIPTION	SUG. RETAIL
FOR 14-19 INDIAN MODELS (EXCEPT SCOUT/SCOUT SIXTY/SCOUT BOBBER)		
1107-0580	Chrome primary cover	\$99.99
1107-0581	Satin black primary cover	99.99
1107-0582	Replacement chrome medallion	24.99
1107-0583	Replacement satin black medallion	24.99



1107-0590



1107-0591



TRI-FIN PRIMARY COVER CAPS

- Classic design flows with the front inlay for a fully-finned appearance
- Direct replacement with easy installation
- A380 aluminum construction available in chrome or satin black finish

PART #	DESCRIPTION	SUG. RETAIL
FOR 14-19 INDIAN MODELS (EXCEPT SCOUT)		
1107-0590	Chrome	\$99.99
1107-0591	Satin black	99.99

CLUTCH COVER ACCENT

- Dished design with a distinct stepped pattern around the border
- Quality A380 cast aluminum construction with premium chrome plating
- Direct bolt-on replacement for the stock accent
- Sold each

PART #	DESCRIPTION	SUG. RETAIL
1107-0608	For 15-19 Scout models	\$59.99

All part numbers in **BLUE** are new for 2019.



FINNED DERBY COVERS

- CNC-machined from billet aluminum
- 3D-sculpted design matches the finned rocker box's on 111" Thunderstroke™ engines
- Includes chrome hardware
- Choose from chrome or black anodize finish

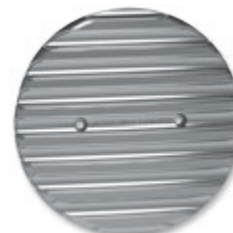

0940-1667



0940-1666

PART #	DESCRIPTION	SUG. RETAIL
FOR ALL MODELS W/ 111" THUNDERSTROKE™ ENGINES		
0940-1667	Chrome	\$119.95

PART #	DESCRIPTION	SUG. RETAIL
FOR ALL MODELS W/ 111" THUNDERSTROKE™ ENGINES (CONT)		
0940-1666	Black	\$119.95

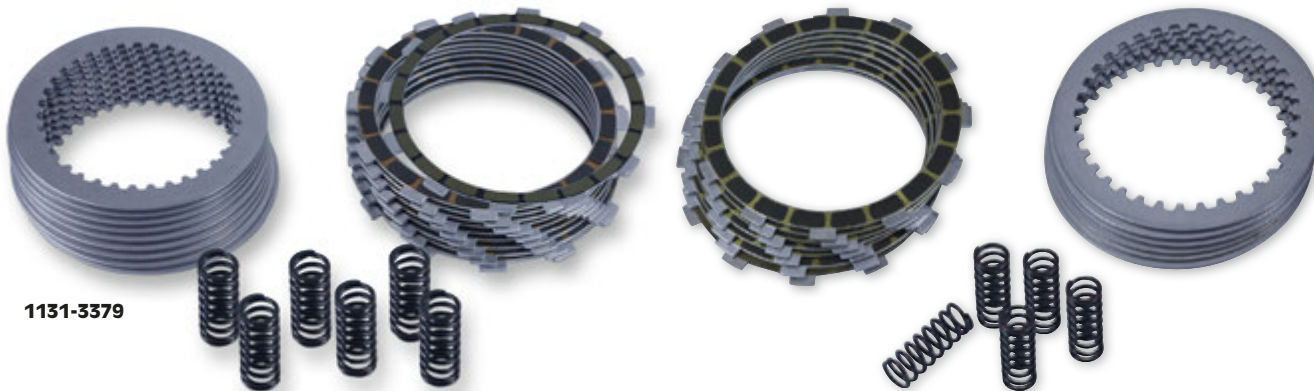

1131-3379

EXTRA PLATE CLUTCH KIT

- Kit includes 8 aramid fiber plates, 7 tempered steel plates and a set of 5 heavy-duty springs
- Increases clutch capacity and performance
- Measured to ensure proper fit and performance

PART #	DESCRIPTION	SUG. RETAIL
1131-3378	For 14-19 Chief/Roadmaster	\$224.95
1131-3379	For 14-19 Scout/Scout Sixty/Scout Bobber	210.95



CARBON FIBER CLUTCH KIT

- Carbon fiber
- Includes seven frictions, six steels and a set of five heavy-duty springs
- Made in the U.S.A.

PART #	DESCRIPTION	SUG. RETAIL
1131-3025	For 14-19 Chief/Chieftain	\$200.95



1131-3326

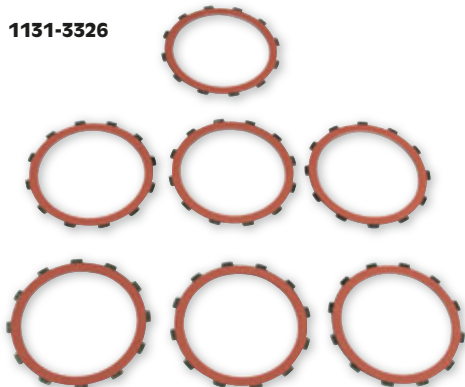

1131-3327

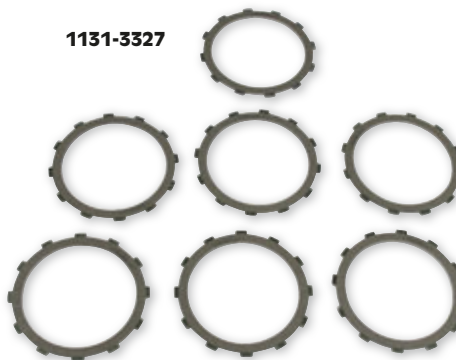

1131-3328

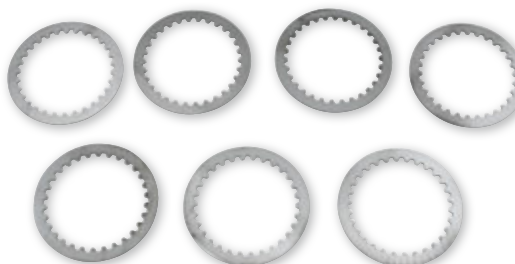

CLUTCH PLATE KITS

- Available in Red Eagle®, aramid fiber or steel
- Include seven clutch plates
- Made in the U.S.A.

PART #	DESCRIPTION	SUG. RETAIL
FOR 14 CLASSIC, 14-15 CHIEFTAIN, 14-15 CHIEF VINTAGE, 15 CHIEF CLASSIC AND 16 CHIEF DARK HORSE		
1131-3326	Red Eagle® plate kit	\$76.95
1131-3327	Aramid fiber plate kit	91.95
1131-3328	Steel plate kit	82.95



CLUTCH SHAFT ARM

- Provides better clutch separation, smoother shifting and ease of finding neutral
- Made in the U.S.A.

PART #	DESCRIPTION	SUG. RETAIL
1132-1343	For 14-19 Chief/Chieftain/Springfield	\$97.95

All part numbers in **BLUE** are new for 2019.

- WINDSHIELDS & FAIRINGS
- AUDIO, COMMUNICATION & MOUNTS
- SADDLEBAGS & LUGGAGE
- SEATS & SISSY BARS
- EXHAUST
- FUEL/AIR SYSTEMS
- ENGINE
- TRANSMISSION & DRIVELINE
- GASKETS & SEALS
- ELECTRICAL
- LIGHTING
- HANDLEBARS, CONTROLS & MIRRORS
- CABLES
- BRAKES
- TANKS & OIL FILTERS
- DASHES & GAUGES
- FRAMES & SUSPENSION
- FENDERS & LICENSE PLATE FRAMES
- FOOTRESTS & FLOORBOARDS
- WHEELS & AXLES
- HARDWARE, COVERS & GENERAL

WINDSHIELDS & FAIRINGS

AUDIO, COMMUNICATION & MOUNTS

SADDLEBAGS & LUGGAGE

SEATS & SISSY BARS

EXHAUST

FUEL/AIR SYSTEMS

ENGINE

TRANSMISSION & DRIVELINE

GASKETS & SEALS

ELECTRICAL

LIGHTING

HANDLEBARS, CONTROLS & MIRRORS

CABLES

BRAKES

TANKS & OIL FILTERS

DASHES & GAUGES

FRAMES & SUSPENSION

FENDERS & LICENSE PLATE FRAMES

FOOTRESTS & FLOORBOARDS

WHEELS & AXLES

HARDWARE, COVERS & GENERAL



ELECTRIC EASY SHIFT SPEED SHIFTER KITS

- Easy shifting for rider comfort and convenience or for speed for the performance-oriented rider
- For performance, this is the best bang-for-your-buck product
- Gain a minimum of one bike length per shift
- Shift up at partial or full throttle and back down with the push of a button
- Eliminates the need to shift with your foot or clutch
- OEM shifting ability is retained after installation

PART #	FITS MODEL	SUG. RETAIL
1601-0469	15-18 Scout	\$1,155.95



1601-0499



1601-0500

SHIFT RODS

- Dress up your bike with a high-quality shift rod that add a custom touch
- Constructed of 6061-T6 aluminum
- Available with a choice of black-anodized or chrome finishes
- Bomber series has brass rivets incorporated in the design for an industrial look
- Made in the U.S.A.



PART #	DESCRIPTION	SUG. RETAIL
FOR 15-19 SCOUT MODELS		
1601-0499	Black anodized	\$102.95
1601-0500	Chrome	102.95



1601-0469



1601-0470

- Clutch use is still required for starting and stopping when using these kits
- Uses state-of-the-art control module to send a signal from the button control to the shift solenoid
- Kits include a stylish dual-button shift control for upshifts/downshifts, a chrome-plated electronic shift cylinder, ignition kill module, control modules and all necessary brackets
- Made in the U.S.A.

PART #	FITS MODEL	SUG. RETAIL
1601-0470	14-18 Chief	\$1,155.95



1601-0497



1601-0498



ADJUSTABLE SHIFT RODS

- Adjustable shift rod changes your shift peg height up to 0.75"
- 13" overall length
- CNC-machined billet aluminum construction
- Hard black or chrome-plated finishes
- Can be used with race-inspired lightweight cut-outs or with the solid bar style showing
- Easy installation
- Made in the U.S.A.

PART #	DESCRIPTION	SUG. RETAIL
FOR 15-19 SCOUT		
1601-0497	Black	\$89.95
1601-0498	Chrome	89.95

1201-0854

1201-0855



CARL BROUHARD DESIGNS LLC

BOMBER SERIES DRIVE PULLEY COVERS

- Direct replacement for stock pulley
- Constructed of 6061-T6 aluminum
- Easy installation
- Available with a choice of black-anodized or chrome finishes
- Brass rivets incorporated in the design for an industrial look
- Made in the U.S.A.

PART #	DESCRIPTION	SUG. RETAIL
FOR 13-19 SCOUT/SCOUT SIXTY/SCOUT BOBBER		
1201-0854	Black anodized	\$259.95
1201-0855	Chrome	259.95

1201-0849

1201-0850

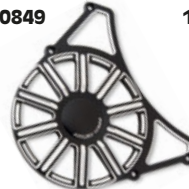

10-GAUGE FRONT PULLEY COVERS

- CNC machined from billet aluminum
- Multi-piece design enhances style and replaces heavy factory cast cover
- Includes chrome hardware
- Black or chrome finish
- Sold each

PART #	COLOR	SUG. RETAIL
FOR 15-19 SCOUT/SIXTY/SCOUT BOBBER		
1201-0849	Black	\$219.95
1201-0850	Chrome	229.95



KURYAKYN

LEGACY FRONT PULLEY COVER

- Quality A380 cast-aluminum construction with premium chrome plating
- Direct replacement for stock belt pulley cover
- Includes chrome-plated mounting hardware for a uniform look

PART #	DESCRIPTION	SUG. RETAIL
1201-0856	For 15-19 Scout models	\$129.99



PULLEY COVERS

- CNC-machined from 6061 billet aluminum
- Hard black and chrome-plated finishes
- Race-inspired cut-out design
- Mounting hardware included
- Replaces OEM #633277
- Made in the U.S.A.



1201-0851



1201-0852

PART #	DESCRIPTION	SUG. RETAIL
FOR 15-19 SCOUT/SCOUT SIXTY/SCOUT BOBBER		
1201-0851	Black	\$189.95
1201-0852	Chrome	189.95

All part numbers in **BLUE** are new for 2019.



PLUG WIRES

- Constructed with silicone throughout the jacket, insulation and core to deliver high-temperature resistance
- Rated at SAE Class E J2031 with a continuous operating temperature of 450°F
- Made in the U.S.A.

PART #	DESCRIPTION	SUG. RETAIL
2104-0296	For 09-13 Indian models (all)	\$35.95



BLUE STREAK XXX PLUG WIRES

- Triple silicone construction through jacket, insulation and core for higher heat-resistance
- Rated at SAE CLASS E J2031 with a continuous operating temperature of 450°F
- Made in the U.S.A.

PART #	DESCRIPTION	SUG. RETAIL
2104-0299	For 09-13 Indian models (all)	\$37.95



IGNITION COILS

- Increased spark energy
- Replaces OEM #4010425
- Cost-effective replacement

MODEL	PART #	SUG. RETAIL
12-15 Chief Classic	2102-0330	\$179.95
12-15 Chief Vintage	2102-0330	179.95
14-15 Chieftain	2102-0330	179.95
15 Roadmaster	2102-0330	179.95
12-13 Dark Horse	2102-0330	179.95



RECTIFIER/REGULATOR

- OEM-style rectifier/regulator
- Made in the U.S.A.



FITS MODEL	PART #	SUG. RETAIL
14-15 Chief Classic	2112-1151	\$152.95
14-15 Chief Vintage	2112-1151	152.95
14-15 Chieftain	2112-1151	152.95
15 Roadmaster	2112-1151	152.95



DRAG SPECIALTIES HIGH PERFORMANCE BATTERIES

- Specifically designed for high-performance engines that need extra cranking power
- Superior engineering features include an AGM (Absorbed glass-matt) radial grid design for maximum cranking amps
- High vibration resistance
- Spill-proof, pre-filled, pre-charged, maintenance-free sealed design
- Batteries include brass spacers, stainless steel nuts, bolts and star washers
- Made in the U.S.A.



2113-0013



2113-0011

NOTE: Factory-activated batteries should be charged once a month when not in service.

FITS MODEL	PART #	SUG. RETAIL	FITS MODEL	PART #	SUG. RETAIL
For 12-13 Chief Classic/ Vintage/Dark Horse	2113-0013	\$137.95	For 02-03 Chief	2113-0013	137.95
For 09-11 Chief (all models)	2113-0011	122.95	For 02-03 Scout/Spirit	2113-0011	122.95
			For all 99-01 models	2113-0011	122.95

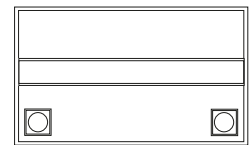

FACTORY-ACTIVATED PART #	YUASA REF. #	COLD CRANKING AMPS	LENGTH	WIDTH	HEIGHT	TERMINAL CONFIGURATION
DRAG SPECIALTIES BATTERY CROSS REFERENCE						
2113-0011	YTX20H-BS	310	6 ⁷ / ₈ "	3 ⁷ / ₁₆ "	6 ¹ / ₈ "	+ -
2113-0013	YTX24HL-BS	350	8 ¹ / ₈ "	3 ⁷ / ₁₆ "	6 ³ / ₈ "	- +

DISCLAIMER: NOT LEGAL FOR SALE OR USE IN CALIFORNIA ON ANY POLLUTION CONTROLLED MOTOR VEHICLES. SEE PAGE 4 FOR IMPORTANT EMISSION DEFINITIONS AND REGULATORY COMPLIANCE AND WARRANTY INFORMATION.

All part numbers in **BLUE** are new for 2019.

WINDSHIELDS & FAIRINGS

AUDIO, COMMUNICATION & MOUNTS

SADDLEBAGS & LUGGAGE

SEATS & SISSY BARS

EXHAUST

FUEL/AIR SYSTEMS

ENGINE

TRANSMISSION & DRIVELINE

GASKETS & SEALS

ELECTRICAL

LIGHTING

HANDLEBARS, CONTROLS & MIRRORS

CABLES

BRAKES

TANKS & OIL FILTERS

DASHES & GAUGES

FRAMES & SUSPENSION

FENDERS & LICENSE PLATE FRAMES

FOOTRESTS & FLOORBOARDS

WHEELS & AXLES

HARDWARE, COVERS & GENERAL



HIGH-PERFORMANCE AGM MAINTENANCE-FREE BATTERIES

- This new generation of maintenance-free batteries delivers higher cranking amps for vehicles that require extra starting power
- Additional cranking amps make these one of the most powerful batteries on the market
- Acid pack included, except where noted as Factory-activated

NOTE: Factory-activated batteries should be charged once a month when not in service.

NOTE: See below for battery application chart.

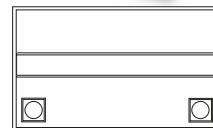

FITS MODEL	HIGH-PERFORMANCE FACTORY-ACTIVATED AGM MAINTENANCE-FREE		HIGH-PERFORMANCE AGM MAINTENANCE-FREE	
	SUG. RETAIL	YTX20HL-BS	SUG. RETAIL	YTX20HL-BS
For 16-18 Chief Dark Horse, Springfield	\$140.95	YTX20HL-BS	\$138.95	YTX20HL-BS
For 14-18 Chief Classic/Chief Vintage/Chieftain/Roadmaster	140.95	YTX20HL-BS	138.95	YTX20HL-BS
For 12-13 Chief Classic/Vintage/Dark Horse	161.95	YTX24HL-BS	159.95	YTX24HL-BS
For 09-11 Chief (all models)	-	YTX20H-BS	138.95	YTX20H-BS
For 02-03 Chief	161.95	YTX24HL-BS	159.95	YTX24HL-BS
For 02-03 Scout/Spirit	-	YTX20H-BS	138.95	YTX20H-BS
For all 99-01 models	-	YTX20H-BS	138.95	YTX20H-BS

PART #	YUASA REFERENCE #	CAPACITY AH (10H-R)	REGULAR CHARGE CURRENT (AMP)	COLD CRANKING AMPS @0°F	LENGTH	WIDTH	HEIGHT	APPROX. WEIGHT W/ ACID (LB.)	TERMINAL CONFIGURATION
YTX20H-BS	YTX20H-BS	18	1.8	310	6 ⁷ / ₈ "	3 ⁷ / ₁₆ "	6 ¹ / ₈ "	15.1	+ -
YTX20HL-BS	YTX20HL-BS	18	1.8	310	6 ⁷ / ₈ "	3 ⁷ / ₁₆ "	6 ¹ / ₈ "	15.1	- +
2113-0104	YTX20HL (Factory-Activated)	18	1.8	310	6 ⁷ / ₈ "	3 ⁷ / ₁₆ "	6 ¹ / ₈ "	15.1	- +
YTX24HL-BS	YTX24HL-BS	21	2.1	350	8 ¹ / ₈ "	3 ⁷ / ₁₆ "	6 ³ / ₈ "	17.5	- +
YTX24HL	YTX24HL (Factory-Activated)	21	2.1	350	8 ¹ / ₈ "	3 ⁷ / ₁₆ "	6 ³ / ₈ "	17.5	- +

YTX-20BS

AGM (MAINTENANCE-FREE) BATTERY

- Special absorbed-glass mat battery eliminates water loss, permitting the battery to be permanently sealed once it is filled with acid; Acid Pak included
- Truly the world's finest "install it and forget it" motorcycle battery

NOTE: See below for battery application chart.

FITS MODEL	PART #	SUG. RETAIL
For 09-11 Chief (all models)	YTX-20BS	\$129.95
For 02-03 Scout/Spirit	YTX-20BS	129.95
For all 99-01 models	YTX-20BS	129.95

PART #	YUASA REFERENCE #	CAPACITY AH (10H-R)	COLD CRANKING AMPS @0°F	LENGTH	WIDTH	HEIGHT	APPROX. WEIGHT W/ ACID (LB.)	TERMINAL CONFIGURATION
YTX-20BS	YTX20-BS	18	270	6 ⁷ / ₈ "	3 ⁷ / ₁₆ "	6 ¹ / ₈ "	13.9	+ -

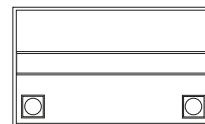

SPARE PARTS

- Bolts and nuts sold in packs of five sets of two each
- Vent tube is 750mm long; fits all Yuasa batteries; sold in packs of five

PART #	DESCRIPTION	SUG. RETAIL	PART #	DESCRIPTION	SUG. RETAIL
2113-0079	Bolt/nut set (2 ea.) 6 x 11mm (5-pk.)	\$1.20	2113-0080	Bolt/nut set (2 ea.) 6 x 14mm (5-pk.)	\$1.20
2113-0082	Bolt/nut set (2 ea.) 6 x 12mm/20 (fits Drag Specialties battery PART #s 2113-0010, 2113-0011, 2113-0012 or 2113-0013)	2.40	2113-0081	Bolt/nut set (2 ea.) 6 x 22mm (5-pk.)	1.80
2113-0083	Bolt/nut set 6 x 12mm SB	2.40	2113-0078	Bolt/nut set for YB16CL-B (5-pk.)	2.40
2113-0084	Bolt/nut set 6 x 12mm TM	1.80	2113-0085	Bolt/nut set (fits Drag Specialties battery PART #s 2113-0010, 2113-0011, 2113-0012 or 2113-0013)	2.40
			YU04-5	Vent tube - 750mm (5-pk.)	6.95



2113-0079



YU04-5

DISCLAIMER: NOT LEGAL FOR SALE OR USE IN CALIFORNIA ON ANY POLLUTION CONTROLLED MOTOR VEHICLES. SEE PAGE 4 FOR IMPORTANT EMISSION DEFINITIONS AND REGULATORY COMPLIANCE AND WARRANTY INFORMATION.

All part numbers in **BLUE** are new for 2019.

WINDSHIELDS & FAIRINGS

AUDIO, COMMUNICATION & MOUNTS

SADDLEBAGS & LUGGAGE

SEATS & SISSY BARS

EXHAUST

FUEL/AIR SYSTEMS

ENGINE

TRANSMISSION & DRIVELINE

GASKETS & SEALS

ELECTRICAL

LIGHTING

HANDLEBARS, CONTROLS & MIRRORS

CABLES

BRAKES

TANKS & OIL FILTERS

DASHES & GAUGES

FRAMES & SUSPENSION

FENDERS & LICENSE PLATE FRAMES

FOOTRESTS & FLOORBOARDS

WHEELS & AXLES

HARDWARE, COVERS & GENERAL

- WINDSHIELDS & FAIRINGS
- AUDIO, COMMUNICATION & MOUNTS
- SADDLEBAGS & LUGGAGE
- SEATS & SISSY BARS
- EXHAUST
- FUEL/AIR SYSTEMS
- ENGINE
- TRANSMISSION & DRIVELINE
- GASKETS & SEALS
- ELECTRICAL
- LIGHTING
- HANDLEBARS, CONTROLS & MIRRORS
- CABLES
- BRAKES
- TANKS & OIL FILTERS
- DASHES & GAUGES
- FRAMES & SUSPENSION
- FENDERS & LICENSE PLATE FRAMES
- FOOTRESTS & FLOORBOARDS
- WHEELS & AXLES
- HARDWARE, COVERS & GENERAL



HIGH-PERFORMANCE AGM MAINTENANCE-FREE BATTERIES

- Parts Unlimited is proud to offer a premium-quality, maintenance-free battery at a great low price
- Special absorbed-glass mat battery eliminates water loss, permitting the battery to be permanently sealed once it is filled with acid
- Acid pack included
- Battery seals to prevent water loss
- Hold charge three times longer than conventional batteries

FITS MODEL	PART #	SUG. RETAIL	FITS MODEL	PART #	SUG. RETAIL
For 16-18 Chief Dark Horse, Springfield	2113-0022	\$81.95	For 09-11 Chief (all models)	2113-0021	\$82.95
For 14-18 Chief Classic/Chief Vintage/Chieftain/Roadmaster	2113-0022	81.95	For 02-03 Chief	2113-0205	114.95
For 12-13 Chief Classic/Vintage/Dark Horse	2113-0205	114.95	For 02-03 Scout/Spirit	2113-0021	82.95
			For all 99-01 models	2113-0021	82.95

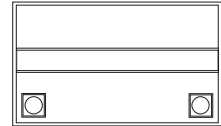

PART #	YUASA REFERENCE #	CAPACITY AH (10H-R)	COLD CRANKING AMPS @0°F	LENGTH	WIDTH	HEIGHT	APPROX. WEIGHT W/ OUT ACID (LB.)	TERMINAL CONFIGURATION
2113-0021	YTX20H-BS	18	320	6 ⁷ / ₈ "	3 ⁷ / ₁₆ "	6 ¹ / ₁₆ "	11.23	+ -
2113-0022	YTX20HL-BS	18	320	6 ⁷ / ₈ "	3 ⁷ / ₁₆ "	6 ¹ / ₁₆ "	11.23	- +
2113-0205	YTX24HL-BS	21	340	8 ¹ / ₁₆ "	3 ⁹ / ₁₆ "	6 ¹ / ₂ "	13.00	- +

POWER MAX MAINTENANCE-FREE BATTERIES

- Completely sealed black case can be mounted in almost any position
- Advanced technology allows very high power discharge
- Accept a high rate of recharge without damage to the battery
- Can be recharged over 90% in less than one hour on a regulated charger
- Battery MUST BE CHARGED in the same manner as any lead acid battery
- When not in service, battery should be charged once a month



DS-325030

NOTE: Order by Yuasa reference #. See below for battery application chart.

FITS MODEL	PART #	SUG. RETAIL	FITS MODEL	PART #	SUG. RETAIL
For 12-13 Chief Classic/Vintage/Dark Horse	2113-0223	\$119.95	For 02-03 Chief	2113-0223	\$119.95
For 09-11 Chief (all models)	DS-325030	111.95	For 02-03 Scout/Spirit	DS-325030	111.95
			For all 99-01 models	DS-325030	111.95

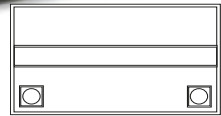

PART #	YUASA REFERENCE #	CAPACITY AH (10H-R)	LENGTH	WIDTH	HEIGHT	TERMINAL CONFIGURATION
DS-325030	YTX20-BS	18	6 ⁷ / ₈ "	3 ⁷ / ₁₆ "	6 ¹ / ₈ "	+ -
2113-0223	YIX24HL-BS	21	8 ¹ / ₈ "	3 ⁷ / ₁₆ "	6 ³ / ₈ "	- +



AIR HORNS

- Waterproof dual-trumpet air horns replace stock horn and give a loud warning blast of 128 dB
- Trumpets, mounts and brackets are triple-chrome-plated or black powder-coated
- Includes horn assembly, air compressor, relay, simple wiring, cone-shaped dust/bug covers and complete installation instructions
- Air compressor creates instant air pressure to the horns and mounts either under the seat, behind right side cover or down tube of frame (mounting position varies per model)
- Use the stock horn button; bolt-on, plug-in installation
- Made in the U.S.A.

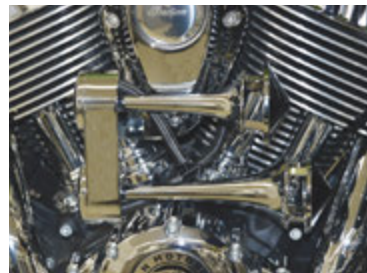

2107-0270

PART #	DESCRIPTION	SUG. RETAIL
2107-0270	For 14-16 Chief/Chieftain, 15-16 Roadmaster, 16 Springfield	\$229.95
2107-0271	For 17 Chief/Chieftain, 17 Roadmaster, 17 Springfield	229.95
2107-0272	For 18-19 Chief/Chieftain, 18-19 Roadmaster, 18-19 Springfield	229.95

DISCLAIMER: NOT LEGAL FOR SALE OR USE IN CALIFORNIA ON ANY POLLUTION CONTROLLED MOTOR VEHICLES. SEE PAGE 4 FOR IMPORTANT EMISSION DEFINITIONS AND REGULATORY COMPLIANCE AND WARRANTY INFORMATION.

All part numbers in **BLUE** are new for 2019.

WINDSHIELDS & FAIRINGS

AUDIO, COMMUNICATION & MOUNTS

SADDLEBAGS & LUGGAGE

SEATS & SISSY BARS

EXHAUST

FUEL/AIR SYSTEMS

ENGINE

TRANSMISSION & DRIVELINE

GASKETS & SEALS

ELECTRICAL

LIGHTING

HANDLEBARS, CONTROLS & MIRRORS

CABLES

BRAKES

TANKS & OIL FILTERS

DASHES & GAUGES

FRAMES & SUSPENSION

FENDERS & LICENSE PLATE FRAMES

FOOTRESTS & FLOORBOARDS

WHEELS & AXLES

HARDWARE, COVERS & GENERAL

2107-0285



2107-0284

2107-0266

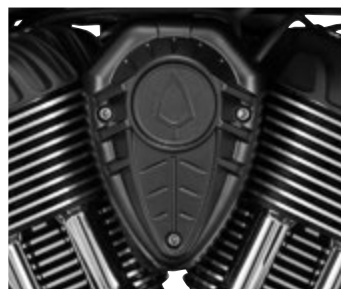

2107-0267



FINNED HORN COVERS

- CNC-machined from billet aluminum
- 3D-sculpted design matches the finned rocker box's on 111" Thunderstroke™ engines
- Includes chrome hardware
- Choose from chrome or black anodize finish

PART #	DESCRIPTION	SUG. RETAIL
FOR ALL 18-19 MODELS W/ 111" THUNDERSTROKE™ ENGINES		
2107-0285	Chrome	\$169.95
2107-0284	Black	169.95



SPEAR HORN COVERS

- Direct replacement with easy installation using factory hardware
- Durable aluminum construction offered in chrome or satin black finish

PART #	DESCRIPTION	SUG. RETAIL
FOR 14-19 INDIAN MODELS (EXCEPT SCOUT)		
2107-0266	Chrome	\$79.99
2107-0267	Satin black	79.99



2106-0404

2106-0405



LEGACY HORN COVER

- Centralized speedlines and a distinct stepped border completely alter the look of the boring black horn housing
- Durable, lightweight, injection-molded ABS cover
- Includes a relocation bracket that eliminates the need to remove the horn when changing the oil filter

PART #	DESCRIPTION	SUG. RETAIL
2107-0275	For 15-19 Scout	\$34.99

10-GAUGE KEY SWITCH COVERS

- CNC machined from forged billet aluminum
- Full replacements for factory key switch cover
- Bolt-on installation, includes hardware
- Chrome or black anodize finish

PART #	COLOR	SUG. RETAIL
FOR 15-19 SCOUT/SIXTY/BOBBER		
2106-0404	Black	\$179.95
2106-0405	Chrome	189.95



STARTER COVER

- Chrome-plated die-cast aluminum construction
- Simple bolt-on installation
- All necessary hardware included

PART #	DESCRIPTION	SUG. RETAIL
2110-0582	For 14-19 Indian models (except Scout)	\$69.99



2120-0868



ROCKER SWITCH

- Switch has 8A @ 12V load on one side and 10A @ 30V load on other
- Measures approximately 0.480" x 1.072"
- Available in black

PART #	DESCRIPTION	SUG. RETAIL
2106-0385	Rocker switch	\$3.95

24" HANDLEBAR EXTENSION HARNESSES

- Complete plug-and-play kit includes Throttle-By-Wire and all the items needed to successfully extend the wiring to a set of OEM handlebar switches
- Made in the U.S.A.

PART #	FITS MODEL	SUG. RETAIL
2120-0867	For 14-19 Chief, Springfield	\$89.95
2120-0868	For 14-19 Chieftain, Roadmaster	99.95

ISOLATOR MODULES

- Total isolation of all lighting and electrical accessories from vehicle
- Short circuit protection of all outputs without any relays or fuses
- Plug-and-play (except for universal version)
- 45 amp max total capacity
- Left turn, right turn, brake, battery, accessory power inputs
- Isolated outputs: left turn, right turn, brake, run/accessory
- Isolated integrated output: turn/brake output
- Isolated 4-pin trailer output

PART #	DESCRIPTION	SUG. RETAIL
2050-0296	For 14-19 Chief/Chieftain/Springfield/Roadmaster	\$109.95

DISCLAIMER: NOT LEGAL FOR SALE OR USE IN CALIFORNIA ON ANY POLLUTION CONTROLLED MOTOR VEHICLES. SEE PAGE 4 FOR IMPORTANT EMISSION DEFINITIONS AND REGULATORY COMPLIANCE AND WARRANTY INFORMATION.

All part numbers in **BLUE** are new for 2019.



2001-1825



2001-1826



2001-1573



2001-1574



7" PROBEAM® LED HEADLAMPS

- Low beam consists of three high-power advanced optical D lenses and a DRL
- High Beam keeps low beam illuminated and adds two additional advanced optical D lenses with three projector lenses for an incredibly wide optical pattern producing an ideal beam pattern with illumination down the road as well as on either side
- Made from a heavy-duty, lightweight die-cast aluminum, the low-profile housing requires no trim ring and offers a plug-and-play installation
- Durable polycarbonate lens for long term durability
- Headlamps are SAE, DOT and ECE compliant
- Headlamps are available with a chrome or True Black finish
- Made in the U.S.A..

PART #	DESCRIPTION	SUG. RETAIL
FOR 15-18 CHIEF/SPRINGFIELD/CHEFTAIN AND ROADMASTER MODELS		
2001-1825	Chrome	\$449.95
2001-1826	True Black	449.95

7" TruBEAM® HEADLIGHTS

- Premium 7" Round LED headlamp designed for custom installation on models with factory 7" headlight
- Complex reflector design features three low beam LEDs and two high beam LEDs with a combination of projector and reflector type LEDs and built-in Halo ring
- LED combination provides superior low and high beam outputs
- Durable polycarbonate lens with H4 connector and mounting hardware included; no additional trim ring needed
- 4210 raw lumens/2947 effective lumens; 5800K color temp
- 1.1 amp low current draw, 1.5 amp high current draw, 0.2 amp halo ring current draw
- Available in chrome or black chrome (smoked) reflector

PART #	DESCRIPTION	SUG. RETAIL
FOR 15-18 CHIEF/SPRINGFIELD		
2001-1573	Chrome	\$439.95
2001-1572	Black chrome	439.95
FOR 15-18 CHEFTAIN/ROADMASTER		
2001-1575	Chrome	439.95
2001-1574	Black chrome	439.95



2001-1775



2001-1774



2001-1419



2001-1420



2001-1106



7" LED ADAPTIVE 2 HEADLIGHTS

- The improved Adaptive 2 series headlight allows for the adaptive technology when using high beam, as well as low beam
- Senses leaning angles up to 30° and dynamically fills in dark areas while turning
- Direct replacement for most 7" headlight, retrofits PAR56 headlight
- Superior visibility, safety and durability
- Easy plug-n-play H4-style connector
- Die-cast aluminum housing
- 1600 lumen output (high beam), 1020 lumen output (low beam)
- Include mount kit for easy installation
- DOT compliant
- Made in the U.S.A.

PART #	DESCRIPTION	SUG. RETAIL
FOR 14-18 CHIEF CLASSIC, 14-18 CHIEF VINTAGE, 14-18 CHEFTAIN, 16-18 SPRINGFIELD, 15-18 ROADMASTER, 16-18 CHIEF DARK HORSE, 16-18 CHEFTAIN DARK HORSE, 17-18 ROADMASTER CLASSIC		
2001-1775	Black	\$721.95
2001-1776	Chrome	721.95
2001-1773	Replacement black headlight	665.95
2001-1774	Replacement chrome headlight	665.95



7" LED HEADLIGHTS

- Direct replacement for most 7" headlight
- Superior visibility, safety and durability
- Easy, plug-n-play H4-style connector
- Die-cast aluminum housing
- 1150 lumen output (high beam), 750 lumen output (low beam)
- DOT compliant
- Made in the U.S.A.

NOTE: Mount kit PART #2001-1106 must be ordered separately.

PART #	DESCRIPTION	SUG. RETAIL
FOR 14-18 CHIEF CLASSIC, 14-18 CHIEF VINTAGE, 14-18 CHEFTAIN, 16-18 SPRINGFIELD, 15-18 ROADMASTER, 16-18 CHIEF DARK HORSE, 16-18 CHEFTAIN DARK HORSE, 17-18 ROADMASTER CLASSIC		
2001-1419	Chrome	\$468.95
2001-1420	Black	468.95
2001-1106	Mount kit	69.95

All part numbers in **BLUE** are new for 2019.

WINDSHIELDS & FAIRINGS

AUDIO, COMMUNICATION & MOUNTS

SADDLEBAGS & LUGGAGE

SEATS & SISSY BARS

EXHAUST

FUEL/AIR SYSTEMS

ENGINE

TRANSMISSION & DRIVELINE

GASKETS & SEALS

ELECTRICAL

LIGHTING

HANDLEBARS, CONTROLS & MIRRORS

CABLES

BRAKES

TANKS & OIL FILTERS

DASHES & GAUGES

FRAMES & SUSPENSION

FENDERS & LICENSE PLATE FRAMES

FOOTRESTS & FLOORBOARDS

WHEELS & AXLES

HARDWARE, COVERS & GENERAL

WINDSHIELDS & FAIRINGS

AUDIO, COMMUNICATION & MOUNTS

SADDLEBAGS & LUGGAGE

SEATS & SISSY BARS

EXHAUST

FUEL/AIR SYSTEMS

ENGINE

TRANSMISSION & DRIVELINE

GASKETS & SEALS

ELECTRICAL

LIGHTING

HANDLEBARS, CONTROLS & MIRRORS

CABLES

BRAKES

TANKS & OIL FILTERS

DASHES & GAUGES

FRAMES & SUSPENSION

FENDERS & LICENSE PLATE FRAMES

FOOTRESTS & FLOORBOARDS

WHEELS & AXLES

HARDWARE, COVERS & GENERAL



7" EVO 2 DUAL BURN HEADLIGHTS

- Direct replacement for most 7" PAR56 headlights
- Dual burn technology provides the rider with the spread of the low beam and the punch of the high beam simultaneously
- 1260 lumen output (high beam), 750 lumen output (low beam)
- Easy, plug-n-play H4-style connector
- Die-cast aluminum housing
- Includes mounting ring for easy installation
- DOT compliant
- Made in the U.S.A.



2001-1549



2001-1546



PART #	DESCRIPTION	SUG. RETAIL
FOR 14-18 CHIEF CLASSIC, 14-18 CHIEF VINTAGE, 14-18 CHIEFTAIN, 16-18 SPRINGFIELD, 15-18 ROADMASTER, 16-18 CHIEF DARK HORSE, 16-18 CHIEFTAIN DARK HORSE, 17-18 ROADMASTER CLASSIC		
2001-1548	Black	\$361.95
2001-1549	Chrome	361.95
2001-1546	Replacement black headlight	314.95
2001-1547	Replacement chrome headlight	299.95



5.75" LED ADAPTIVE 2 HEADLIGHTS

- The improved Adaptive 2 series headlights allow for the adaptive technology when using high beam, as well as low beam
- Senses leaning angles up to 30° and dynamically fills in dark areas while turning
- Direct replacement for most 5.75" headlights, retrofits PAR46 headlights
- Superior visibility, safety and durability
- Easy plug-n-play H4-style connector
- Die-cast aluminum housing
- 1600 lumen output (high beam), 1020 lumen output (low beam)
- DOT compliant
- Made in the U.S.A.



2001-1779



2001-1780

PART #	DESCRIPTION	SUG. RETAIL	PART #	DESCRIPTION	SUG. RETAIL
FOR 15-18 SCOUT/SCOUT SIXTY			FOR 15-18 SCOUT/SCOUT SIXTY (CONT)		
2001-1779	Black	\$517.95	2001-1780	Chrome	\$517.95



5.75" LED HEADLIGHTS

- Direct replacement for most 5.75" headlights, retrofits PAR46 headlights
- Superior visibility, safety and durability
- Easy, plug-n-play H4-style connector
- Die-cast aluminum housing
- 1150 lumen output (high beam), 750 lumen output (low beam)
- DOT compliant
- Made in the U.S.A.



2001-1194



2001-1195

PART #	DESCRIPTION	SUG. RETAIL	PART #	DESCRIPTION	SUG. RETAIL
FOR 15-18 SCOUT/SCOUT SIXTY			FOR 15-18 SCOUT/SCOUT SIXTY (CONT)		
2001-1194	Black	\$354.95	2001-1195	Chrome	\$354.95



7" ORBIT HEADLIGHT ADAPTER KIT

- Direct replacement for the stock headlight support
- Constructed from durable glass-filled nylon
- Includes hardware and also uses existing factory hardware for installation
- Orbit Headlights sold separately (see page 984 of the 2019 Drag Specialties Fatbook)



PART #	DESCRIPTION	SUG. RETAIL
2001-1837	For 14-19 Indian models (except Scout)	\$29.99

All part numbers in **BLUE** are new for 2019.



2001-1570



4.5" TruBEAM® PASSING LAMPS

- TruBEAM® LED Passing Lamps include built-in Halo
- Lamps integrate the latest in LED technology to provide a superior beam pattern in terms of both distance and coverage
- Each features a 10 Watt Cree XML LED with an optimized MSR style reflector; the combination provides a powerful beam pattern that is approximately five times brighter than the OEM bulb, while drawing one sixth of the current

- 5800K color temp
- Lamps come with a 881 connector for installation
- Sold in pairs

NOTE: Passing Lamp Adapter required for installation on 14-18 Roadmaster and Chieftain models (sold separately).

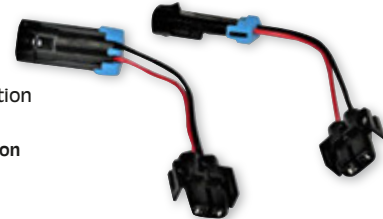

2001-1571

DESCRIPTION	PART #	SUG. RETAIL
FOR 14-18 CHIEFTAIN/ROADMASTER/SPRINGFIELD/CHIEF VINTAGE AND 14-15 CHIEF CLASSIC		
Chrome	2001-1570	\$349.95
Black chrome	2001-1569	349.95
Passing lamps adapters	2001-1571	19.95



2³/₈" LED DRIVING LIGHT KIT

- Custom die-cast aluminum lights and fork mounts make an ideal fit on many cruisers
- The Litespan LED reflector bulbs produce 400 lumens each from 7 watt 6-LED output in bright white 4000K color
- Their concentrated 20° beam angle puts more light down the road in front of riders for a true driving light function
- The die-cast clamps fit cruisers with 38mm to 41mm forks and come with a wire harness, relay and switch



PART #	DESCRIPTION	SUG. RETAIL
2001-1323	2 ³ / ₈ " LED driving light kit	\$189.95



HIGHWAY BAR MINI DRIVING LIGHT KITS

- 7W/400 lumens or 4000K LED lights
- Pair of die-cast 2³/₈" visored mini driving lights
- Includes pair of 1¹/₄" highway bar clamps; additional clamps available separately
- Comes complete with wiring harness and isolation relay to protect your bike's circuit along with a choice of two styles of switches



2001-1342



2001-1522

PART #	DESCRIPTION	SUG. RETAIL	PART #	DESCRIPTION	SUG. RETAIL
CHROME			BLACK SATIN POWDER-COAT		
2001-1343	LED kit	\$159.95	2001-1522	LED kit	\$179.95
2001-1342	Halogen kit	119.95	2001-1823	Halogen kit	139.95
1624-0318	1 ¹ / ₄ " clamps, chrome (pr.)	22.95	1624-0340	1 ¹ / ₄ " clamps, black (pr.)	22.95

All part numbers in **BLUE** are new for 2019.

- WINDSHIELDS & FAIRINGS
- AUDIO, COMMUNICATION & MOUNTS
- SADDLEBAGS & LUGGAGE
- SEATS & SISSY BARS
- EXHAUST
- FUEL/AIR SYSTEMS
- ENGINE
- TRANSMISSION & DRIVELINE
- GASKETS & SEALS
- ELECTRICAL
- LIGHTING**
- HANDLEBARS, CONTROLS & MIRRORS
- CABLES
- BRAKES
- TANKS & OIL FILTERS
- DASHES & GAUGES
- FRAMES & SUSPENSION
- FENDERS & LICENSE PLATE FRAMES
- FOOTRESTS & FLOORBOARDS
- WHEELS & AXLES
- HARDWARE, COVERS & GENERAL

WINDSHIELDS & FAIRINGS

AUDIO, COMMUNICATION & MOUNTS

SADDLEBAGS & LUGGAGE

SEATS & SISSY BARS

EXHAUST

FUEL/AIR SYSTEMS

ENGINE

TRANSMISSION & DRIVELINE

GASKETS & SEALS

ELECTRICAL

LIGHTING

HANDLEBARS, CONTROLS & MIRRORS

CABLES

BRAKES

TANKS & OIL FILTERS

DASHES & GAUGES

FRAMES & SUSPENSION

FENDERS & LICENSE PLATE FRAMES

FOOTRESTS & FLOORBOARDS

WHEELS & AXLES

HARDWARE, COVERS & GENERAL



MINI DRIVING LIGHTS

- Available in halogen or LED
- Die-cast body with smooth design comes in aluminum or black finish
- Visor integrated into bezel; setscrew allows visor to rotate to desired position for custom installation
- 3³/₄" L x 2³/₈" dia.; 8mm stem
- Halogen features 55W, 12V bulb
- LED features 7W, six LEDs per light
- Sold each



PART #	DESCRIPTION	SUG. RETAIL
HALOGEN		
2040-0488	Aluminum	\$49.95
2001-1340	Black	49.95

PART #	DESCRIPTION	SUG. RETAIL
LED		
2001-1339	Aluminum	\$65.95
2001-1341	Black	65.95



DRIVING LIGHT SET

- Super-bright rated at 3000 lumens
- Pure white light rated at 6000K
- Waterproof light housings
- Lights turn with steering for added visibility
- Includes a pair of 2" LED lights, fork leg mounting and wiring



PART #	DESCRIPTION	SUG. RETAIL
2001-1819	For all 111 C.I. Indian Chief models	\$299.95



KURYAKYN

CHROME DRIVING LIGHT BEZELS

- Lightweight ABS plastic construction with a show-chrome finish
- Simple to install
- Sold in pairs

PART #	DESCRIPTION	SUG. RETAIL
2001-0945	For 19 Chieftain Classic, 14-18 Chieftain/Roadmaster models	\$61.99

KURYAKYN

REAR FENDER STRIP LIGHTS

- Chrome housing has a gentle curve and contains a series of bright red dual-function LEDs
- Strips measure approximately 12" long
- Plug-and-play wiring installation
- Install quickly using high-strength 3M™ VHB™ adhesive
- Sold in pairs



PART #	DESCRIPTION	SUG. RETAIL
2040-1823	For all 14-19 Indian models (except Scout, Scout Sixty, Scout Bobber)	\$169.99

All part numbers in **BLUE** are new for 2019.

- WINDSHIELDS & FAIRINGS
- AUDIO, COMMUNICATION & MOUNTS
- SADDLEBAGS & LUGGAGE
- SEATS & SISSY BARS
- EXHAUST
- FUEL/AIR SYSTEMS
- ENGINE
- TRANSMISSION & DRIVELINE
- GASKETS & SEALS
- ELECTRICAL
- LIGHTING**
- HANDLEBARS, CONTROLS & MIRRORS
- CABLES
- BRAKES
- TANKS & OIL FILTERS
- DASHES & GAUGES
- FRAMES & SUSPENSION
- FENDERS & LICENSE PLATE FRAMES
- FOOTRESTS & FLOORBOARDS
- WHEELS & AXLES
- HARDWARE, COVERS & GENERAL



KURYAKYN

TRUNK LIGHT ACCENT

- Injection-molded ABS accent matches the stock chrome housing
- Brilliant chrome finish
- Installs quickly with high-strength 3M™ VHB™ adhesive

PART #	DESCRIPTION	SUG. RETAIL
2040-1863	For 15-19 Roadmaster (except Roadmaster Classic), 14-19 Chieftain w/ Tour Trunk	\$49.99



REAR RED LED TURN SIGNALS

- Plug-n-play
- For use with Badlands Illuminator module PART #2050-0260; sold separately on page 83
- Sold in pairs



PART #	DESCRIPTION	SUG. RETAIL
2020-1279	For 14-19 Indian models (except Scout)	\$119.95



REAR TURN SIGNAL ADAPTERS

- Use to mount any turn signals that mount with a 5/16" or 8mm thru hole bolt to the license plate bracket
- CNC-machined billet aluminum construction
- Hard black or chrome-plated finish
- 5/16" or 8mm diameter mounting bolt hole
- Made in the U.S.A.



PART #	DESCRIPTION	SUG. RETAIL	PART #	DESCRIPTION	SUG. RETAIL
FOR 15-19 SCOUT/SCOUT SIXTY			FOR 15-19 SCOUT/SCOUT SIXTY (CONT)		
2040-2008	Black	\$36.95	2040-2009	Chrome	\$36.95



BRITE-SABER ORBIT LED LIGHT POD

- Portable with 24 super-bright LEDs
- Base contains earth magnet
- Fold-out hook
- Mounting plate option; VHB tape included
- Requires three AAA batteries (not included)



PART #	DESCRIPTION	SUG. RETAIL
2040-2290	LED light pod	\$7.95

All part numbers in **BLUE** are new for 2019.



WINDSHIELDS & FAIRINGS

AUDIO, COMMUNICATION & MOUNTS

SADDLEBAGS & LUGGAGE

SEATS & Sissy BARS

EXHAUST

FUEL/AIR SYSTEMS

ENGINE

TRANSMISSION & DRIVELINE

GASKETS & SEALS

ELECTRICAL

LIGHTING

HANDLEBARS, CONTROLS & MIRRORS

CABLES

BRAKES

TANKS & OIL FILTERS

DASHES & GAUGES

FRAMES & SUSPENSION

FENDERS & LICENSE PLATE FRAMES

FOOTRESTS & FLOORBOARDS

WHEELS & AXLES

HARDWARE, COVERS & GENERAL

MAGICAL WIZARDS™ FULL LIGHTED ENGINE KIT

- Magical Wizards™ are the next generation of color-changing LED accent lights
- Available with Color Command™ 5 remote control or Bluetooth®-compatible Color Command™ 5 remote control
- All Magical Wizards™ come with 60" wire leads to make installation easier, have a waterproof conformal coating, and are pre-taped with 3M™ adhesive tape for a durable installation
- Kit includes: 2 MWZ15 LED strips (11⁷/₈" L x 7⁷/₁₆" W x 3³/₁₆" D) for mounting under the gas tank, 8 Standard Pods (2⁵/₁₆" L x 9⁹/₁₆" W x 7⁷/₁₆" D) for mounting to the frame under the seat, back of the air cleaner, on upper part of frame at the front of the gas tank, and on the lower frame on each side of the oil cooler, 1 Mini Slimline Pod (1¹/₂" L x 7⁷/₁₆" W x 3³/₁₆" H) for mounting under the horn cover, 1 complete Installation Kit which includes 3M™ Promoter, Pushbutton Switch, battery terminal connectors, 3 position Cage Clamp® connectors, butt connectors, tie wraps and Mounting Sticks™ along with 1 CCM-5 Remote Control System



2040-2171

PART #	DESCRIPTION	SUG. RETAIL
FOR ALL INDIAN MODELS		
2040-2171	W/ standard Color Command™ 5 remote control	\$279.95
2040-2161	W/ Bluetooth-compatible Color Command™ 5 remote control	309.95

MAGICFLEX®2 ENGINE ACCENT LIGHTING KITS

- MagicFLEX®2 are the next generation of single color LED accent lights
- Provide a 120 degree viewing angle with 3 high output 5050 surface mount LEDs per inch giving the brightest, most compact flexible 5050 LED strip on the market
- All MagicFLEX®2 come with 48" color coded wire leads in high temp protective black sheathing, have a waterproof conformal coating, and are pre-taped with 3M™ adhesive tape for a durable installation
- Each kit includes: 2 MagicFLEX®2 24 LED strips (12" length) for under the gas tank, 8 MagicFLEX®2 6 LED strips (3" length) for mounting to the frame under the seat, back of the air cleaner, on upper part of frame at the front of the gas tank, and on the lower frame on each side of the oil cooler, 1 MagicFLEX®2 3 LED strip (1.5" length) for mounting under the horn cover, 1 Complete Installation Kit which includes 3M™ Promoter, pushbutton switch, battery terminal connectors, mini ATC fuse holder with 3 amp fuse and 5 position Cage Clamp® connector

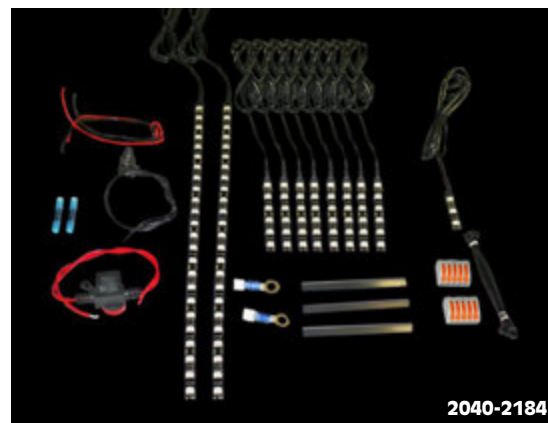

2040-2184

PART #	COLOR	SUG. RETAIL	PART #	COLOR	SUG. RETAIL	PART #	COLOR	SUG. RETAIL
FOR ALL INDIAN MODELS			FOR ALL INDIAN MODELS (CONT)			FOR ALL INDIAN MODELS (CONT)		
2040-2184	Amber	\$164.95	2040-2187	Orange	\$164.95	2040-2190	UV	\$164.95
2040-2185	Blue	164.95	2040-2188	Piink	164.95	2040-2191	White	164.95
2040-2186	Green	164.95	2040-2189	Red	164.95			

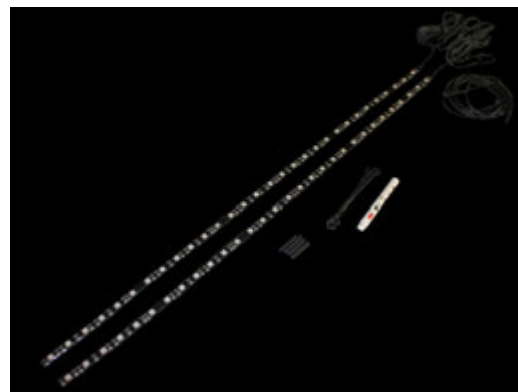

MAGICAL WIZARDS™ WHEEL LIGHT KIT

- Magical Wizards™ are the next generation of color-changing LED accent lights
- All come with 60" wire leads to make installation easier, have a waterproof conformal coating, and are pre-taped with 3M™ adhesive tape for a durable installation
- Kit includes: 2 Magical Wizards™ 24 LED strips (24" length) for mounting along the inside of the front fender skirts, 4 Mounting Sticks to allow the Magical Wizards™ LEDs to aim light down, extra cable, Tie Wraps and 3M™ Promoter Ampule



PART #	DESCRIPTION	SUG. RETAIL
2040-2160	For all Indian front and rear wheels	\$149.95

All part numbers in **BLUE** are new for 2019.



- WINDSHIELDS & FAIRINGS
- AUDIO, COMMUNICATION & MOUNTS
- SADDLEBAGS & LUGGAGE
- SEATS & SISSY BARS
- EXHAUST
- FUEL/AIR SYSTEMS
- ENGINE
- TRANSMISSION & DRIVELINE
- GASKETS & SEALS
- ELECTRICAL
- LIGHTING**
- HANDLEBARS, CONTROLS & MIRRORS
- CABLES
- BRAKES
- TANKS & OIL FILTERS
- DASHES & GAUGES
- FRAMES & SUSPENSION
- FENDERS & LICENSE PLATE FRAMES
- FOOTRESTS & FLOORBOARDS
- WHEELS & AXLES
- HARDWARE, COVERS & GENERAL

MAGICFLEX®2 WHEEL LIGHTS

- MagicFLEX®2 are the next generation of single color LED accent lights
- Provide a 120 degree viewing angle with 3 high output 5050 surface mount LEDs per inch giving the brightest, most compact flexible 5050 LED strip on the market
- All MagicFLEX®2 come with 48" color coded wire leads in high temp protective black sheathing, have a waterproof conformal coating, and are pre-taped with 3M™ adhesive tape for a durable installation
- Kit includes 2 MagicFLEX®2 24 LED strips (12" length) for mounting along the inside of the front fender skirts, 2 Mounting Stickz to allow the MagicFLEX®2 LEDs to aim light down, extra 2 conductor cable, tie wraps and 3M™ promoter ampule

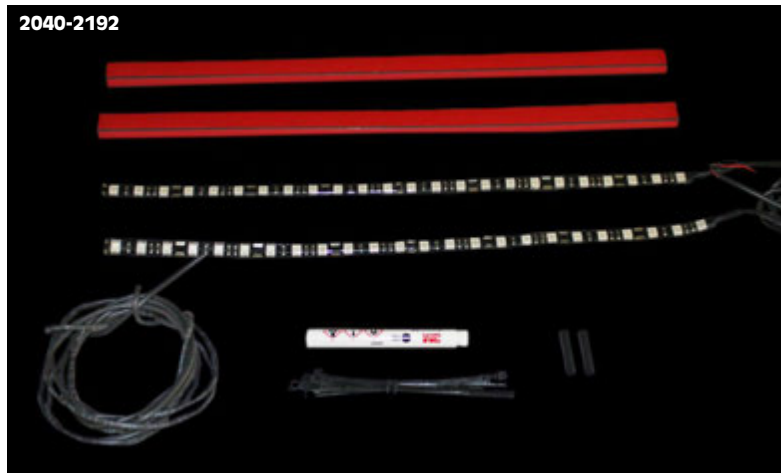

PART #	DESCRIPTION	SUG. RETAIL	PART #	DESCRIPTION	SUG. RETAIL
FOR ALL INDIAN FRONT OR REAR WHEELS			FOR ALL INDIAN FRONT OR REAR WHEELS (CONT)		
2040-2192	Amber	\$74.95	2040-2196	Pink	\$74.95
2040-2193	Blue	74.95	2040-2197	Red	74.95
2040-2194	Green	74.95	2040-2198	UV	74.95
2040-2195	Orange	74.95	2040-2199	White	74.95

MAGICFLEX®2 INDIAN WAR BONNET ACCENT LIGHT KITS

- MagicFLEX®2 are the next generation of single color LED accent lights
- Provide a 120 degree viewing angle with 3 high output 5050 surface mount LEDs per inch giving the brightest, most compact flexible 5050 LED strip on the market
- All MagicFLEX®2 come with 48" color coded wire leads in high temp protective black sheathing, have a waterproof conformal coating, and are pre-taped with 3M™ adhesive tape for a durable installation
- Each kit includes: 1 MagicFLEX®2 6 LED strip (3" length) for mounting inside war bonnet, 1 Complete Installation Kit which includes 3M™ Promoter, heat shrink, 2 extra conductor cable and tie wraps



NOTE: Requires use of remote control
PART #2050-0230 or 2050-0281 sold separately.

PART #	COLOR	SUG. RETAIL	PART #	COLOR	SUG. RETAIL
FOR ALL INDIAN WAR BONNETS			FOR ALL INDIAN WAR BONNETS (CONT)		
2040-2162	Amber	\$17.95	2040-2166	Pink	\$17.95
2040-2163	Blue	17.95	2040-2167	Red	17.95
2040-2164	Green	17.95	2040-2168	UV	17.95
2040-2165	Orange	17.95	2040-2169	White	17.95

MAGICAL WIZARDS™ INDIAN WAR BONNET ACCENT LIGHT KIT

- Magical Wizards™ are the next generation of color-changing LED accent lights
- All come with 60" wire leads to make installation easier, have a waterproof conformal coating, and are pre-taped with 3M™ adhesive tape for a durable installation
- Kit includes: 1 Standard Pod (2⁵/₁₆" L x 9⁹/₁₆" W x 7⁷/₁₆" D) for mounting inside war bonnet, 1 Complete Installation Kit which includes 3M™ Promoter, heat shrink, extra cable and tie wraps



PART #	DESCRIPTION	SUG. RETAIL
2040-2170	For all Indian War Bonnets	\$29.95

All part numbers in **BLUE** are new for 2019.

WINDSHIELDS & FAIRINGS

AUDIO, COMMUNICATION & MOUNTS

SADDLEBAGS & LUGGAGE

SEATS & SISSY BARS

EXHAUST

FUEL/AIR SYSTEMS

ENGINE

TRANSMISSION & DRIVELINE

GASKETS & SEALS

ELECTRICAL

LIGHTING

HANDLEBARS, CONTROLS & MIRRORS

CABLES

BRAKES

TANKS & OIL FILTERS

DASHES & GAUGES

FRAMES & SUSPENSION

FENDERS & LICENSE PLATE FRAMES

FOOTRESTS & FLOORBOARDS

WHEELS & AXLES

HARDWARE, COVERS & GENERAL



KURYAKYN

PASSING LAMP ADAPTER HARNESS

- Offer easy plug-and-play installation of Kuryakyn Orbit and Phase 7 LED passing lamps
- Eliminate the hassle of cutting and splicing the stock wiring harness
- Sold in pairs

PART #	DESCRIPTION	SUG. RETAIL
2120-0935	For 14-19 Chieftain and Roadmaster models with OEM passing lamps	\$24.99



MAGIC STROBES BRAKE LIGHT FLASHER

- 10 user selectable flash/strobe patterns
- Over current protection
- Thermal protection
- Built-in short circuit protection
- Reverse wiring protection
- 84 watts max power rating, 12VDC
- Works with stock Indian LED taillight
- Sealed, weathertight case
- Compact size: 2.25" x 1.25" x 0.5"

PART #	DESCRIPTION	SUG. RETAIL
2050-0282	For 14-18 Chief/Springfield/Chieftain/Roadmaster	\$59.95



2050-0322



2050-0324



MAGIC STROBES™

- Applies brake/strobe pattern to OEM trunk brake light
- Riders can easily select from 10 flash/strobe patterns
- Sleek compact design
- Measures 4.2" L x 1.4" W x 0.6" H

PART #	DESCRIPTION	SUG. RETAIL
2050-0322	For 15-18 Scout/Scout-Sixty	\$59.95
2050-0324	For 15-19 Roadmaster	59.95



CANBUS MODULE

- Requires no cutting, splicing or soldering
- Prevents damage to your factory wiring
- Plug-n-play installation
- Allows CANbus signal to work with trailer lights
- Works with Rivco trailer wiring components

PART #	DESCRIPTION	SUG. RETAIL
3902-0194	For all 14-18 Indian models (except Scout)	\$51.95



2050-0303



STATIC/DYNAMIC SEQUENTIAL SIGNAL MODULES

- Allow for the three separate LED turn signals, installed on the rear of the bike, to flash sequentially
- LEDs will also perform brake and running light functions
- Include color-coded replacement rear fender harness and installation instructions
- Built-in load-equalizer prevents rapid flashing
- Static sequential flashing: when the turn signal button is pressed, the first LED will light up followed by the second and third before all three shut off and the sequence starts again
- Dynamic sequential flashing: when the turn signal button is pressed, the first LED will light up then power off, followed by the second on/off and third on/off before the sequence starts again

PART #	DESCRIPTION	SUG. RETAIL
FOR 14-19 INDIAN MODELS (EXCEPT SCOUT)		
2050-0313	Static module	\$149.95
2050-0314	Dynamic module	149.95
UNIVERSAL FITMENT		
2050-0303	Static module	149.95
2050-0307	Dynamic module	149.95

All part numbers in **BLUE** are new for 2019.



BADLANDS ILLUMINATOR MODULE

- Designed to add running light, brake light and turn signal functions to each rear turn signal
- Features a built-in load equalizer that is perfect for switching out factory turn signals to LED versions
- Plug-n-play design for easy installation
- For use with LED turn signals PART # 2020-1279 on page 79
- Made in the U.S.A.



PART #	DESCRIPTION	SUG. RETAIL
2050-0260	For all 14-19 Indian models (except Scout)	\$118.95



PLUG-N-PLAY ILLUMINATOR

- Provides running light function to front turn signals
- Built-in load equalizer prevents turn signals from flashing rapidly
- Made in the U.S.A.

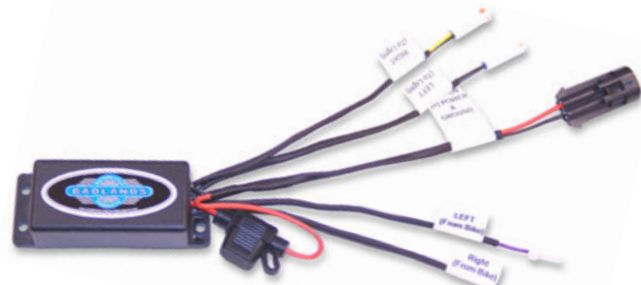

PART #	DESCRIPTION	SUG. RETAIL
2050-0291	For 15-19 Indian models (except Scout)	\$118.95



PLUG-N-PLAY ILLUMINATOR

- Provides running light, brake light and turn signal functions to new rear turn signals
- Built-in load equalizer to prevent rapid flashing
- Includes new wiring harness for rear fender
- Made in the U.S.A.



PART #	DESCRIPTION	SUG. RETAIL
2050-0290	For 15-19 Scout models	\$129.95



PIAA PLATINUM LED BULBS

- High-powered Z ES LEDs
- Dual alloy heat sink and thermal-resistant LEDs allow for consistent operating temperatures and longer life
- Plug-and-play
- Adjustable base
- Sold each



PART #	STYLE	POWER CONSUMPTION	COLOR TEMPERATURE
2060-0613	H11	25W	6,000K
2060-0614	H7	25W	6,000K
2060-0615	H4	25W	6,000K



RIVCO LED REPLACEMENT FOR H8 BULBS

- Replaces Indian H8 bulbs
- 1700 lumens of total output (850 per bulb)
- Intense white light rated at 6000 Kelvin
- Plug-n-play installation using factory bulb housing
- Sold as pair



PART #	DESCRIPTION	SUG. RETAIL
2060-0627	H8 replacement bulbs	\$79.95

MR16 LED REPLACEMENT BULB

- Popular MR16 LED bulb introduced in 2015 is now pushed to an additional 90 lumens
- MR16 LED bulb now delivers 490 lumens with its high-output, high intensity LED and now has a bright 5000K color temperature
- Dimmable design of this bulb also delivers less feedback to weak radio signals, making this a great upgrade to many of Big Bike Parts Mini LED Driving Light Kits
- Sold each



PART #	DESCRIPTION	SUG. RETAIL
2060-0636	MR16 LED replacement bulb	\$15.95

All part numbers in **BLUE** are new for 2019.

- WINDSHIELDS & FAIRINGS
- AUDIO, COMMUNICATION & MOUNTS
- SADDLEBAGS & LUGGAGE
- SEATS & SISSY BARS
- EXHAUST
- FUEL/AIR SYSTEMS
- ENGINE
- TRANSMISSION & DRIVELINE
- GASKETS & SEALS
- ELECTRICAL
- LIGHTING
- HANDLEBARS, CONTROLS & MIRRORS
- CABLES
- BRAKES
- TANKS & OIL FILTERS
- DASHES & GAUGES
- FRAMES & SUSPENSION
- FENDERS & LICENSE PLATE FRAMES
- FOOTRESTS & FLOORBOARDS
- WHEELS & AXLES
- HARDWARE, COVERS & GENERAL

WINDSHIELDS & FAIRINGS

AUDIO, COMMUNICATION & MOUNTS

SADDLEBAGS & LUGGAGE

SEATS & SISSY BARS

EXHAUST

FUEL/AIR SYSTEMS

ENGINE

TRANSMISSION & DRIVELINE

GASKETS & SEALS

ELECTRICAL

LIGHTING

HANDLEBARS, CONTROLS & MIRRORS

CABLES

BRAKES

TANKS & OIL FILTERS

DASHES & GAUGES

FRAMES & SUSPENSION

FENDERS & LICENSE PLATE FRAMES

FOOTRESTS & FLOORBOARDS

WHEELS & AXLES

HARDWARE, COVERS & GENERAL



0601-3593



0601-3592

KLASSIC HANDLEBARS

- A great choice for building a bobber, and/or just creating a vintage feel
- Low-profile bars give a more forward stance and traditional flat track style
- More aggressive position than stock bars, and they position rider's wrists/arms outward when compared to stock
- Made in the U.S.A.



PART #	SUG. RETAIL	DESCRIPTION	END RISE	WIDTH	CENTER WIDTH	PULLBACK	DIAMETER
FOR 15-19 SCOUT/SCOUT SIXTY							
0601-3593	\$279.95	Chrome	3"	35"	8"	8"	1"
0601-3592	279.95	Black	3"	35"	8"	8"	1"



Chrome/Chrome



Black/Black



Black/Chrome

KLIP HANGER HANDLEBAR KITS

- The ultimate in rider personal adjustment and fit
- Innovative "Klamps" allow the control/grip portions of the handlebar to be adjusted in several directions to allow the rider to find that perfect fit
- Included handlebars manufactured from DOM tubing, clamps machined from 6061 billet aluminum, chrome hardware, polished aluminum domed bar end plugs
- 1" diameter
- Bars are drilled and slotted for internal wiring and work with heated grips
- Bar ends are slotted for throttle-by-wire option
- Fully knurled center section (riser clamp area) for use with stock riser clamp set-up
- Made in the U.S.A.



PART #	DESCRIPTION	SUG. RETAIL	PART #	DESCRIPTION	SUG. RETAIL	PART #	DESCRIPTION	SUG. RETAIL
FOR 15-19 SCOUT/SCOUT SIXTY			FOR 15-19 SCOUT/SCOUT SIXTY (CONT)			FOR 14-18 CHIEFTAIN/ROADMASTER		
0601-3426	5" Chrome/chrome	\$459.95	0601-3423	10" Chrome/chrome	\$459.95	0601-3254	12" Chrome/chrome	\$599.95
0601-3427	5" Black/chrome	459.95	0601-3424	10" Black/chrome	459.95	0601-3255	12" Black/chrome	599.95
0601-3425	5" Black/black	459.95	0601-3422	10" Black/black	459.95	0601-3253	12" Black/black	599.95



0601-3131



PRAIRIE HANDLEBAR FIT KITS

- Combine traditional beach bar styling with a more comfortable, relaxed cruising position
- Wider and lower than the stock bars on your Indian Chief Classic or Vintage, with 3" more pullback for reduced reach to the handgrips and controls
- Easy to replace your stock bars by including necessary cables in the convenient Prairie Bar Fit Kit
- Available in chrome or black; cables are black in both kits
- Made in the U.S.A.



0601-3130

PART #	SUG. RETAIL	DESCRIPTION	END RISE	WIDTH	CENTER WIDTH	PULLBACK	DIAMETER
FOR 15-18 CHIEF CLASSIC AND CHIEF VINTAGE							
0601-3130	\$374.95	Chrome	8"	37"	8"	14"	1.25"
0601-3131	374.95	Black	8"	37"	8"	14"	1.25"

NOTE: I HANDLEBARS LISTED WILL NOT ACCEPT H-D OEM HEATED GRIPS (EXCEPT AS NOTED).

All part numbers in **BLUE** are new for 2019.



1 1/4" TWIN PEAKS HANDLEBARS

- Designed for use with stock cables, grips and handlebar clamp
- Available in chrome or gloss black powder-coat
- Made in the U.S.A.

CHROME	BLACK	SUG. RETAIL	RISE	END RISE	WIDTH	CENTER WIDTH	PULLBACK
FOR 15-19 SCOUT MODELS							
0601-4466	0601-4467	\$279.95	5 3/4"	6 1/2"	34"	7 3/4"	5"



1 1/4" MODULAR HANDLEBARS

- Innovative 1 1/4" steel handlebars feature billet aluminum junction clamps that rotate towards or away from the rider to set at their desired comfort needs
- Mini-Ape styling
- Multi-piece design allows for easier installation and ability to adjust bar angle to each riders preferred riding position
- Choose from chrome or black finish

CHROME PART #	SUG. RETAIL	BLACK PART #	SUG. RETAIL	DESCRIPTION	END RISE	WIDTH	CENTER WIDTH	PULLBACK
0601-3969	\$449.95	0601-3968	\$449.95	For 14-17 Chieftain models w/ Nav	12"	38"	15"	Adjustable



1 1/4" V-LINE HANDLEBARS

- Seamless DOM mild steel construction with black powder-coated or chrome finish
- All bars have a 7/8" grip and clamping area, are drilled for internal wiring and notched for TBW
- The 2+ bars offer 2" more rise than the standard V-line bar
- Made in the U.S.A.

PART #	DESCRIPTION	SUG. RETAIL	PART #	DESCRIPTION	SUG. RETAIL
FOR 15-19 SCOUT/SCOUT SIXTY, 18-19 SCOUT BOBBER			FOR 15-19 SCOUT/SCOUT SIXTY, 18-19 SCOUT BOBBER (CONT)		
0601-3056	Black powder-coated	\$309.95	0601-3057	Chrome	\$309.95



1 1/4" BRO BARS

- Made from .120 wall tubing
- Dimpled and pre-drilled for internal wiring
- Available in chrome or powder-coated black
- Measurements: 14" tall, 16" pullback and 36" wide
- Made in the U.S.A.

PART #	DESCRIPTION	SUG. RETAIL	PART #	DESCRIPTION	SUG. RETAIL
FOR 18-19 CHIEFTAIN/ROADMASTER			FOR 14-17 FAIRING MODELS		
0601-4156	Powder-coated black	\$399.95	0601-3730	Powder-coated black	\$399.95
0601-4155	Chrome	399.95	0601-3731	Chrome	399.95



NOTE: I HANDLEBARS LISTED WILL NOT ACCEPT H-D OEM HEATED GRIPS (EXCEPT AS NOTED).

All part numbers in **BLUE** are new for 2019.

- WINDSHIELDS & FAIRINGS
- AUDIO, COMMUNICATION & MOUNTS
- SADDLEBAGS & LUGGAGE
- SEATS & SISSY BARS
- EXHAUST
- FUEL/AIR SYSTEMS
- ENGINE
- TRANSMISSION & DRIVELINE
- GASKETS & SEALS
- ELECTRICAL
- LIGHTING
- HANDLEBARS, CONTROLS & MIRRORS**
- CABLES
- BRAKES
- TANKS & OIL FILTERS
- DASHES & GAUGES
- FRAMES & SUSPENSION
- FENDERS & LICENSE PLATE FRAMES
- FOOTRESTS & FLOORBOARDS
- WHEELS & AXLES
- HARDWARE, COVERS & GENERAL

WINDSHIELDS & FAIRINGS

AUDIO, COMMUNICATION & MOUNTS

SADDLEBAGS & LUGGAGE

SEATS & SISSY BARS

EXHAUST

FUEL/AIR SYSTEMS

ENGINE

TRANSMISSION & DRIVELINE

GASKETS & SEALS

ELECTRICAL

LIGHTING

HANDLEBARS, CONTROLS & MIRRORS

CABLES

BRAKES

TANKS & OIL FILTERS

DASHES & GAUGES

FRAMES & SUSPENSION

FENDERS & LICENSE PLATE FRAMES

FOOTRESTS & FLOORBOARDS

WHEELS & AXLES

HARDWARE, COVERS & GENERAL

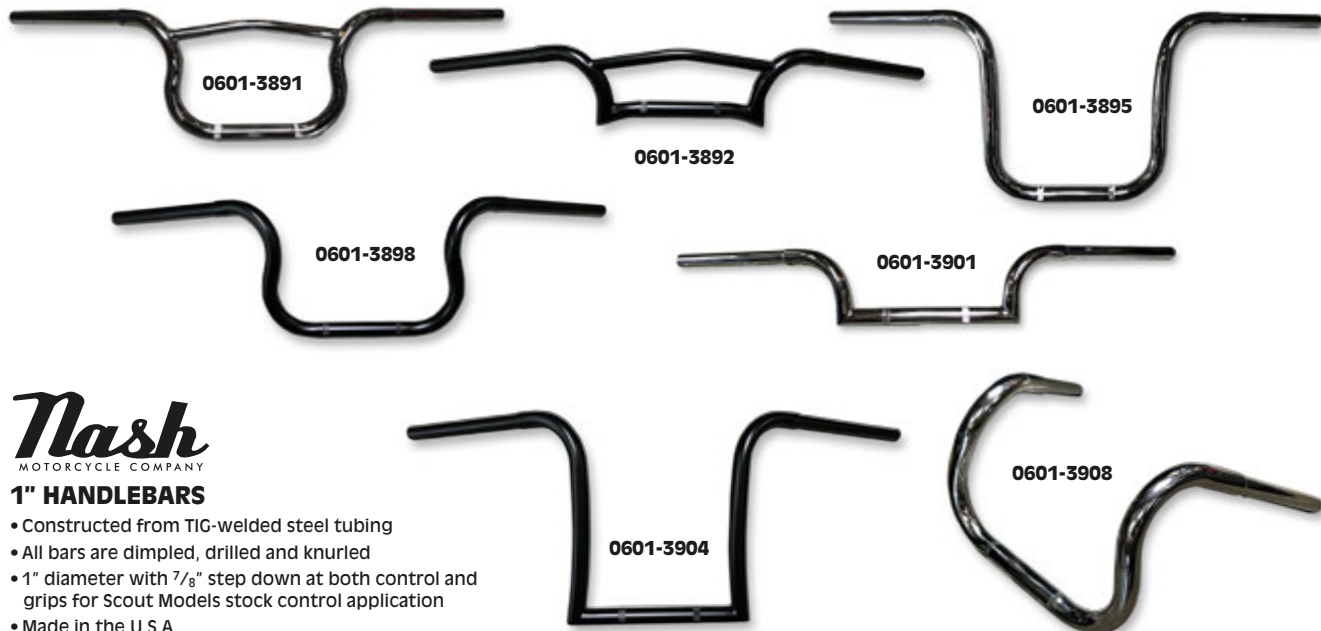

1" HANDLEBARS

- Constructed from TIG-welded steel tubing
- All bars are dimpled, drilled and knurled
- 1" diameter with 7/8" step down at both control and grips for Scout Models stock control application
- Made in the U.S.A.

CHROME	SUG. RETAIL	BLACK	SUG. RETAIL	DESCRIPTION	END RISE	WIDTH	CENTER WIDTH	PULLBACK
FOR 15-19 SCOUT MODELS								
0601-3891	\$274.95	0601-3890	\$244.95	Punchy Bars	8"	33"	11"	5"
0601-3893	309.95	0601-3892	284.95	EL Gringos	4"	31"	10"	5"
0601-3895	269.95	0601-3894	224.95	Smart Gimps	12"	33"	11"	5"
0601-3897	269.95	0601-3896	224.95	Smart Gimps	14"	33"	11"	5"
0601-3899	269.95	0601-3898	224.95	Looky-Looky Bars	8"	29"	11 1/2"	5"
0601-3901	274.95	0601-3900	244.95	Drag Bars	4"	33"	10 1/2"	5"
0601-3903	274.95	0601-3902	244.95	Gimp Hangers	10"	33"	10 1/2"	5"
0601-3905	274.95	0601-3904	244.95	Gimp Hangers	12"	33"	10 1/2"	5"
0601-3907	274.95	0601-3906	244.95	Gimp Hangers	14"	33"	10 1/2"	5"
0601-3908	274.95	-	-	Way Backs	8"	17 1/2"	11 1/2"	11"



2" PIVOTING BAR RISERS

- 2" of rise
- 1 1/4" stem
- Accept 1 1/4" handlebar
- Bring the stock handlebar location back toward the rider by approximately 2"
- These risers are a great option for riders who want to get more upright in the seat and/or get weight off of their arms, neck, and shoulders
- Work with stock cables on the Indian Chieftain/Roadmaster
- Riser positioning will be limited by the large OEM fairing assembly
- Black anodized finish
- Made in the U.S.A.

NOTE: Will not work on 17-18 models with Ride Command.
US Patent #6,920,806.

PART #	DESCRIPTION	SUG. RETAIL
0602-0908	For 12-18 Chieftain/Roadmaster	\$119.95



0410-0296



0410-0297



0410-0298

STEERING STEM NUTS

- CNC-machined from 6061 billet aluminum
- Available in hard black or clear anodized and chrome-plated finishes
- Machined hex for easy installation
- Made in the U.S.A.



PART #	DESCRIPTION	SUG. RETAIL
FOR ALL 14-19 MODELS		
0410-0296	Black anodized	\$39.95
0410-0297	Chrome	39.95
0410-0298	Clear anodized	39.95



STEERING STEM BEARING KIT

- Designed as a drop-in replacement to upgrade OEM ball-type bearings to taper bearings (where ball-type bearings are used by the OEM)
- Designed as a replacement taper bearing seat (where taper bearings are original equipment)
- Kits come complete with both upper and lower taper bearing cups and cones and seals (both top and bottom seals are included in most kits)
- Tapered roller bearings decrease maintenance along with less wear and longer life



PART #	DESCRIPTION	SUG. RETAIL
0410-0192	For 14-17 Chief Classic/Vintage, Chieftain, 15-17 Roadmaster, Scout, Scout Sixty, 16-17 Springfield	\$37.95

NOTE: I HANDLEBARS LISTED WILL NOT ACCEPT H-D OEM HEATED GRIPS (EXCEPT AS NOTED).

All part numbers in **BLUE** are new for 2019.

KURYAKYN

MECHANICAL CRUISE ASSIST

- Looks like a bar end weight
- Spring-loaded tensioner inside holds the throttle in position once you set it with your little finger
- Easy throttle shut-down – just roll the throttle forward to disengage
- Optional matching clutch bar end weight available separately
- For use with OEM or Kuryakyn ISO®, Flame or Transformer grips

NOTE: Proper installation may require cutting a 5/8" hole in the end of your OEM grip. Handlebars must have open ends.

PART #	DESCRIPTION	SUG. RETAIL
FOR USE W/ 7/8 or 1" DIA. HANDLEBARS W/ OPEN ENDS		
0634-0197	Cruise assist	\$91.99
0634-0198	Clutch bar end weight	35.99



0634-0198



0611-0127

1731-0607



BOMBER SERIES MASTER CYLINDER COVER KITS

- High-quality covers that add a custom touch
- Constructed of 6061-T6 aluminum
- Easy installation
- Available with a choice of black-anodized or chrome finishes
- Brass rivets incorporated in the design for industrial look
- Made in the U.S.A.



PART #	DESCRIPTION	SUG. RETAIL
FOR 15-19 SCOUT		
FRONT		
0611-0127	Black anodized	\$62.95
0611-0128	Chrome	62.95
REAR		
1731-0606	Black anodized	71.95
1731-0607	Chrome	71.95

0610-1966



0610-1968



0610-1970



0610-1971



FRONT BRAKE MASTER CYLINDER COVERS

- CNC-machined from 6061 billet aluminum
- Mounting hardware included
- Made in the U.S.A.

FOR 15-19 SCOUT			FOR 14-17 INDIAN MODELS (EXCEPT SCOUT)		
PART #	DESCRIPTION	SUG. RETAIL	PART #	DESCRIPTION	SUG. RETAIL
FINNED			SMOOTH (CONT)		
0610-1965	Black anodized	\$49.95	0610-1969	Chrome	\$49.95
0610-1966	Black anodized/silver	49.95	WARRIOR		
0610-1967	Chrome	49.95	0610-1970	Black anodized	49.95
SMOOTH			0610-1971	Chrome	49.95
0610-1968	Black anodized	49.95			

1731-0577



1731-0580



1731-0581



1731-0614



1731-0615



REAR MASTER CYLINDER COVERS

- CNC-machined from 6061 billet aluminum
- Mounting hardware included
- Easy installation
- Made in the U.S.A.

FOR 15-19 SCOUT		
PART #	DESCRIPTION	SUG. RETAIL
FINNED		
1731-0576	Black anodized	\$49.95
1731-0577	Black anodized/silver	49.95
1731-0578	Chrome	49.95
SMOOTH		
1731-0579	Black anodized	49.95
1731-0580	Chrome	49.95
WARRIOR		
1731-0581	Black anodized	49.95
1731-0582	Chrome	49.95

KURYAKYN

REAR MASTER CYLINDER COVERS

- Direct replacement for the OEM reservoir cap, with the additional benefit of covering the rear master cylinder and sleeve for an ultra-clean look
- Easy, two-bolt installation
- Durable, die-cast aluminum construction
- Available in chrome or satin black finish

PART #	DESCRIPTION	SUG. RETAIL
FOR 14-17 INDIAN MODELS (EXCEPT SCOUT)		
1731-0614	Chrome	\$59.99
1731-0615	Satin black	59.99

All part numbers in BLUE are new for 2019.

WINDSHIELDS & FAIRINGS

AUDIO, COMMUNICATION & MOUNTS

SADDLEBAGS & LUGGAGE

SEATS & SISSY BARS

EXHAUST

FUEL/AIR SYSTEMS

ENGINE

TRANSMISSION & DRIVELINE

GASKETS & SEALS

ELECTRICAL

LIGHTING

HANDLEBARS, CONTROLS & MIRRORS

CABLES

BRAKES

TANKS & OIL FILTERS

DASHES & GAUGES

FRAMES & SUSPENSION

FENDERS & LICENSE PLATE FRAMES

FOOTRESTS & FLOORBOARDS

WHEELS & AXLES

HARDWARE, COVERS & GENERAL

WINDSHIELDS & FAIRINGS

AUDIO, COMMUNICATION & MOUNTS

SADDLEBAGS & LUGGAGE

SEATS & SISSY BARS

EXHAUST

FUEL/AIR SYSTEMS

ENGINE

TRANSMISSION & DRIVELINE

GASKETS & SEALS

ELECTRICAL

LIGHTING

HANDLEBARS, CONTROLS & MIRRORS

CABLES

BRAKES

TANKS & OIL FILTERS

DASHES & GAUGES

FRAMES & SUSPENSION

FENDERS & LICENSE PLATE FRAMES

FOOTRESTS & FLOORBOARDS

WHEELS & AXLES

HARDWARE, COVERS & GENERAL



0613-1356



0614-1113

CLUTCH AND BRAKE LEVERS

- CNC-machined from 6061 billet aluminum with a chrome-plated or black anodized finish
- Finger indents for a comfortable grip
- Uses stock mounting hardware
- Sold each
- Made in the U.S.A.

FOR 15-16 SCOUT/SCOUT SIXTY

PART #	DESCRIPTION	SUG. RETAIL
CLUTCH LEVERS (REPL. OEM #5139545)		
0613-1356	Black	\$84.95
0613-1357	Chrome	84.95
BRAKE LEVERS (REPL. OEM #2205842)		
0614-1112	Black	84.95
0614-1113	Chrome	84.95

KURYAKYN

PHANTOM LEVERS

- Feature a sculpted concave design that offers maximum leverage when engaging the clutch or front brake
- Constructed from A380 aluminum
- Direct replacement for stock with easy installation
- Dished design provides leverage for any sized hands to effortlessly actuate the clutch or front brake
- Available in chrome or gloss black finish



0610-2104



0610-2103

PART #	DESCRIPTION	SUG. RETAIL	PART #	DESCRIPTION	SUG. RETAIL
FOR 14-17 INDIAN MODELS (EXCEPT SCOUT)			FOR 14-17 INDIAN MODELS (EXCEPT SCOUT) (CONT)		
0610-2103	Chrome	\$99.99	0610-2104	Gloss black	\$99.99



FRINGED LEATHER GRIP COVERS

- Black leather grip covers with 12" L fringe for grips on 1" bars
- Available for foam- or rubber-covered grips
- Matching lever covers also available (PART #DS-243062; sold separately)

- Sold in pairs; grips not included
- Made in the U.S.A.



DS-243060

PART #	DESCRIPTION	SUG. RETAIL	PART #	DESCRIPTION	SUG. RETAIL
DS-243060	Grip covers for rubber grips	\$17.95	DS-243061	Grip covers for foam grips	\$19.95



FRINGED LEATHER LEVER COVERS

- Black leather lever covers feature 12" L fringe
- Fit any of the larger, cruiser-style replacement levers
- Covers are a good match with our grip covers PART #S DS-243060 and DS-243061
- Sold in pairs
- Made in the U.S.A.



LEATHER LEVER FRINGE

- Leather, lace-up lever covers for style and comfort
- Measure 12" L
- Sold in pairs



PART #	DESCRIPTION	SUG. RETAIL	PART #	DESCRIPTION	SUG. RETAIL
DS-243062	Fringed leather covers	\$12.95	0618-0001	Leather lever fringe	\$20.95

All part numbers in **BLUE** are new for 2019.

0601-3810



0630-1845



CARL BROUHARD DESIGNS LLC

CROSS STYLE GRIPS

- Ergonomic seamless rubber grip technology
- Billet aluminum end caps and collars
- Available in black anodize with off-set cut or chrome
- Made in the U.S.A.

PART #	DESCRIPTION	SUG. RETAIL	PART #	DESCRIPTION	SUG. RETAIL
FOR 13-19 SCOUT/SCOUT SIXTY			FOR 14-17 TOURING		
0601-3809	Black	\$88.95	0630-1845	Black	\$88.95
0601-3810	Chrome	88.95	0630-1846	Chrome	88.95



TRASK

V-LINE GRIPS

- Contoured and feature rubber inserts for maximum comfort and superior grip
- Available in chrome or gloss black powder-coated finish w/ remachined accents
- Made in the U.S.A.

PART #	DESCRIPTION	SUG. RETAIL
FOR 15-19 SCOUT, SCOUT SIXTY		
0630-1875	Gloss black w/ remachined accents	\$169.95
0630-1876	Chrome	169.95



0630-1875



0630-1876



0630-2371



0630-2316

KURYAKYN

THRESHER GRIPS

- Combine a soft, shark tooth-inspired, knurled rubber texture with an ergonomic profile that contours to the shape of your hands for unbeatable comfort and control
- Features a wider diameter for thumb, index and middle fingers and a tapered outer profile for ring and pinky
- Premium, durable EPDM rubber compound will not harden, crack or wear over time and provides an ultra-soft, "cushiony" feel for all-day vibration-dampening comfort

- Assembled with OEM-specific throttle tube and feature a "glueless" clutch grip offering easy installation or removal for handlebar swaps
- Available in chrome or satin black with aluminum trim
- Sold in pairs

PART #	DESCRIPTION	SUG. RETAIL
FOR 14-19 CHIEF CLASSIC, CHIEFTAIN, DARK HORSE, SPRINGFIELD AND VINTAGE MODELS		
0630-2315	Chrome	\$79.99
0630-2371	Satin black	79.99
FOR UNIVERSAL APPLICATIONS W/ 1" HANDLEBARS		
0630-2316	Chrome	79.99

PART #	DESCRIPTION	SUG. RETAIL
FOR UNIVERSAL APPLICATIONS W/ 1" HANDLEBARS (CONT)		
0630-2407	Satin black	\$79.99
FOR UNIVERSAL APPLICATIONS W/ 7/8" HANDLEBARS		
0630-2317	Chrome	79.99
0630-2374	Satin black	79.99



0630-2364



0630-2365

KURYAKYN

UNIVERSAL HEX GRIPS

- Contoured to fit perfectly in your hands for unbeatable comfort
- Ergonomic design features a widened diameter for thumb, index, and middle fingers, and a tapered outer profile for ring and pinky fingers to match the natural shape of your hands
- Premium, durable EPDM rubber compound will not harden, crack or wear over time and provides an ultra soft, cushiony feel for all-day vibration dampening comfort

- Combination of smooth and "hex" shaped embossed rubber provides amazing grip and distinct styling
- Available with chrome or satin black aluminum collars and end caps
- Feature bar-mounted end caps that can be easily replaced with bar end mirrors or weights

PART #	DESCRIPTION	SUG. RETAIL
FOR 1" HANDLEBARS		
0630-2364	Chrome	\$79.99
0630-2365	Satin black	79.99

PART #	DESCRIPTION	SUG. RETAIL
FOR 7/8" HANDLEBARS		
0630-2366	Chrome	\$79.99
0630-2367	Satin black	79.99

All part numbers in **BLUE** are new for 2019.

- WINDSHIELDS & FAIRINGS
- AUDIO, COMMUNICATION & MOUNTS
- SADDLEBAGS & LUGGAGE
- SEATS & SISSY BARS
- EXHAUST
- FUEL/AIR SYSTEMS
- ENGINE
- TRANSMISSION & DRIVELINE
- GASKETS & SEALS
- ELECTRICAL
- LIGHTING
- HANDLEBARS, CONTROLS & MIRRORS**
- CABLES
- BRAKES
- TANKS & OIL FILTERS
- DASHES & GAUGES
- FRAMES & SUSPENSION
- FENDERS & LICENSE PLATE FRAMES
- FOOTRESTS & FLOORBOARDS
- WHEELS & AXLES
- HARDWARE, COVERS & GENERAL

WINDSHIELDS & FAIRINGS

AUDIO, COMMUNICATION & MOUNTS

SADDLEBAGS & LUGGAGE

SEATS & SISSY BARS

EXHAUST

FUEL/AIR SYSTEMS

ENGINE

TRANSMISSION & DRIVELINE

GASKETS & SEALS

ELECTRICAL

LIGHTING

HANDLEBARS, CONTROLS & MIRRORS

CABLES

BRAKES

TANKS & OIL FILTERS

DASHES & GAUGES

FRAMES & SUSPENSION

FENDERS & LICENSE PLATE FRAMES

FOOTRESTS & FLOORBOARDS

WHEELS & AXLES

HARDWARE, COVERS & GENERAL

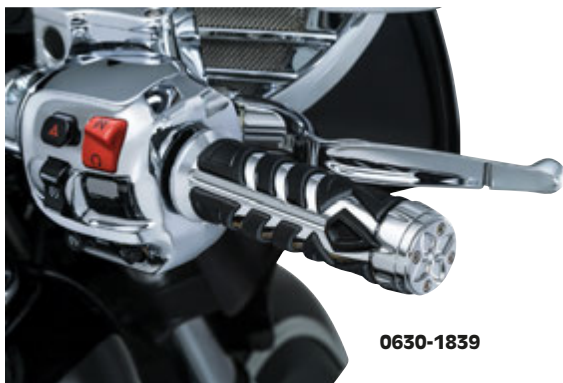

0630-1839



0630-1867

SPEAR GRIPS

- Grip housings are cast aluminum with a chrome-plated finish
- Embedded, soft EPDM rubber inserts provide sure grip in all conditions, reduce vibration and allow airflow
- Sold in pairs

NOTE: Not compatible with OEM heated grips where heat element is in the grips.

CHROME/BLACK PART #	BLACK PART #	FITS MODEL	SUG. RETAIL
0630-1839	0630-1867	For 14-19 Chief Classic/Chieftain/Dark Horse/Springfield/Vintage	\$91.99
0630-1840	0630-1868	For 15-19 Scout	91.99

GLOSS BLACK KINETIC GRIPS

- Designed to keep moving forward with the latest in styling and vibration-isolating technology
- Aluminum body and EPDM rubber to help ride with less fatigue and more control in a modern design
- Sold in pairs



PART #	DESCRIPTION	SUG. RETAIL
0630-1823	For 15-19 Scout models	\$91.99



ISO®-GRIPS

- Combine style and comfort in a soft, non-slip surface that dampens handlebar vibrations
- Recessed area between ISO®-Pads allows cooling airflow in warm weather
- Knurled accent ring adds a touch of class
- Sold in pairs

NOTE: Not compatible with bar-end weights.

NOTE: Not compatible with OEM heated grips where heat element is in the grips.

PART #	DESCRIPTION	SUG. RETAIL
0630-1464	For 14-19 Chief Classic, Chieftain, Dark Horse, Springfield, Vintage models	\$81.99

RIOT GRIPS

- Grips have MX styling for a thin profile and aggressive look
- Grip housings are cast aluminum
- Soft, durable premium EPDM rubber grip compound inserts
- Trim rings are cast aluminum with a bead-blasted silver or blasted black finish
- Sold in pairs



0630-2093

PART #	DESCRIPTION	SUG. RETAIL	PART #	DESCRIPTION	SUG. RETAIL
FOR 15-19 SCOUT, SCOUT SIXTY MODELS			FOR 15-19 SCOUT, SCOUT SIXTY MODELS (CONT)		
0630-2093	Black	\$89.99	0630-2094	Silver	\$89.99

All part numbers in **BLUE** are new for 2019.

GEL GRIPS

- Ergonomic grip
- Soft, gel rubber
- Tacky, rubber feel
- Vibration dampening
- Billet aluminum ends
- Made in the U.S.A.

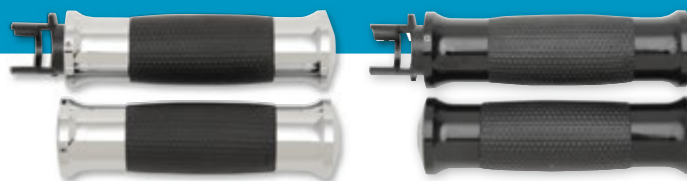

PART #	DESCRIPTION	SUG. RETAIL
FOR ALL 14-17 INDIAN MODELS (EXCEPT SCOUT)		
0630-1510	Chrome	\$59.95

PART #	DESCRIPTION	SUG. RETAIL
FOR ALL 14-17 INDIAN MODELS (EXCEPT SCOUT) (CONT)		
0630-1511	Black anodized	\$59.95



AIR CUSHIONED HEATED AND NON-HEATED GRIPS

- Feature billet end caps and rings with ergonomic Avon seamless rubber grip technology
- Designed with a very soft, tacky and durable material
- Fit 1" handlebars
- Available in chrome or black anodized design with or without throttle boss
- Made in the U.S.A.

CUSTOM CONTOUR HEATED GRIPS

- Feature 6061 billet end caps and collars
- Designed with a very soft, tacky and durable Kraton rubber construction
- Fit 1" handlebars
- Available in chrome or black anodized design
- Sold in pairs
- Made in the U.S.A.



PART #	DESCRIPTION	SUG. RETAIL
FOR ALL 14-17 CHIEFTAIN MODELS		
0631-0228	Chrome	\$224.95
0631-0229	Black anodized	224.95
0631-0230	Spike, chrome	247.95
0631-0231	Spike, black anodized	247.95
FOR 15-19 SCOUT MODELS		
0631-0218	Chrome	224.95
0631-0219	Black anodized	224.95
0631-0220	Spike, chrome	247.95
0631-0221	Spike, black anodized	247.95

FOR ALL 14-17 CHIEFTAIN MODELS

PART #	DESCRIPTION	SUG. RETAIL	PART #	DESCRIPTION	SUG. RETAIL
NON-HEATED			HEATED		
0630-1496	3-ring, chrome	\$59.95	0631-0222	3-ring, chrome	\$224.95
0630-1502	3-ring, black-anodized	59.95	0631-0225	3-ring, black-anodized	224.95
0630-1504	Spike, black-anodized	69.95	0631-0224	Spike, chrome	247.95
0630-1497	3-ring, chrome w/ throttle boss	79.95	0631-0227	Spike, black-anodized	247.95
0630-1503	3-ring, black-anodized w/ throttle boss	79.95	0631-0223	3-ring, chrome w/ throttle boss	264.95
0630-1505	Excalibur, black-anodized	89.95	0631-0226	3-ring, black-anodized w/ throttle boss	264.95

FOR 15-19 SCOUT MODELS

PART #	DESCRIPTION	SUG. RETAIL	PART #	DESCRIPTION	SUG. RETAIL
HEATED			HEATED (CONT)		
0631-0212	3-ring, chrome	\$224.95	0631-0213	3-ring, chrome w/ throttle boss	\$264.95
0631-0215	3-ring, black-anodized	224.95	0631-0216	3-ring, black-anodized w/ throttle boss	264.95
0631-0217	Spike, black-anodized	247.95			
0631-0214	Spike, chrome	247.95			



HEATED GRIP XTENSION HARNESS

- 24" wire harness extension
- Plug-n-play

PART #	DESCRIPTION	SUG. RETAIL
2120-0892	For 14-19 Indian models (except Scout)	\$49.95



HAND GUARDS

- Stylish wind protection for your hands
- Mounts are E-coated aluminum, guards are rubber isolated
- Made of aircraft grade Lucite® in black opaque
- Comes with black mounting
- Made in the U.S.A.



PART #	DESCRIPTION	SUG. RETAIL
0635-1578	For 15-19 Scout	\$79.95
0635-1578	For 16-19 Scout-Sixty	79.95
0635-1577	For 19 Scout Bobber	79.95

All part numbers in **BLUE** are new for 2019.

- WINDSHIELDS & FAIRINGS
- AUDIO, COMMUNICATION & MOUNTS
- SADDLEBAGS & LUGGAGE
- SEATS & SISSY BARS
- EXHAUST
- FUEL/AIR SYSTEMS
- ENGINE
- TRANSMISSION & DRIVELINE
- GASKETS & SEALS
- ELECTRICAL
- LIGHTING
- HANDLEBARS, CONTROLS & MIRRORS
- CABLES
- BRAKES
- TANKS & OIL FILTERS
- DASHES & GAUGES
- FRAMES & SUSPENSION
- FENDERS & LICENSE PLATE FRAMES
- FOOTRESTS & FLOORBOARDS
- WHEELS & AXLES
- HARDWARE, COVERS & GENERAL

- WINDSHIELDS & FAIRINGS
- AUDIO, COMMUNICATION & MOUNTS
- SADDLEBAGS & LUGGAGE
- SEATS & SISSY BARS
- EXHAUST
- FUEL/AIR SYSTEMS
- ENGINE
- TRANSMISSION & DRIVELINE
- GASKETS & SEALS
- ELECTRICAL
- LIGHTING
- HANDLEBARS, CONTROLS & MIRRORS**
- CABLES
- BRAKES
- TANKS & OIL FILTERS
- DASHES & GAUGES
- FRAMES & SUSPENSION
- FENDERS & LICENSE PLATE FRAMES
- FOOTRESTS & FLOORBOARDS
- WHEELS & AXLES
- HARDWARE, COVERS & GENERAL



0640-1090



0640-1091



0640-0919



0640-0920

HEAVY INDUSTRY CUSTOM MIRRORS, STEMS AND ACCENT KITS

- Mirror heads measure approximately 6" L x 3" W
- Mirror stems measure 6" L; position the mirror approximately 4" above and 5 1/2" outward from the mirror mount
- Stems are designed for use with most Kuryakyn mirrors that attach to the stem using a hex-head fastener

- Accent kits allow you to change the look of the mirror backs with custom trim
- Mounting hardware included
- Sold in pairs

NOTE: Not compatible with Kuryakyn handlebar dress up kits.

PART #	DESCRIPTION	SUG. RETAIL
MIRRORS		
0640-1089	Chrome w/ chrome accents	\$152.99
0640-1090	Satin black w/ satin black accents	152.99
0640-1091	Chrome w/ satin black accents	152.99
0640-1092	Satin black w/ chrome accents	152.99

PART #	DESCRIPTION	SUG. RETAIL
STEMS		
0640-0918	Chrome	\$40.99
0640-0919	Satin black	40.99
ACCENT KITS		
0640-0920	Chrome	40.99
0640-0921	Satin black	40.99

TRIDENT BAR-END MIRROR

- Transform the look of your handlebars and move the mirrors to a wider, more useful position
- For use with 7/8" or 1" diameter hollow handlebars
- Sold each

NOTE: Proper installation requires cutting or drilling a 5/8" hole in the end of the OEM grips. Proper installation requires 7/8" or 1" diameter handlebars with open ends. Not compatible with Kuryakyn chrome-style Throttle Bosses that screw to the end of the Kuryakyn grips or other grip end accessories or bar end weights. Not suggested for Buckhorn-style handlebars.



PART #	DESCRIPTION	SUG. RETAIL
0640-0663	Trident bar-end mirror	\$81.99

RAISED MIRROR ADAPTERS

- Provide a raised mirror mount location when mounting Kuryakyn mirrors
- Raise mirror mounting position approximately 1 1/2"
- Allow clearance from brake master cylinder and greatly improve visibility
- Quality stainless steel construction
- Fit all Indian models
- Sold in pairs



0641-0178

0641-0213

PART #	DESCRIPTION	SUG. RETAIL	PART #	DESCRIPTION	SUG. RETAIL
0641-0178	Stainless steel	\$18.99	0641-0213	Satin black	\$18.99

All part numbers in **BLUE** are new for 2019.



0652-2037



0652-2039

BRAIDED HIGH EFFICIENCY CLUTCH CABLES

- The Industry's highest-quality braid available in two color choices to complement your bike; Sterling Chromite II® and Black Pearl braided with black wire
- Braid color and weave match on all Magnum control cables and brake lines
- Coated with a non-yellowing, crystal-clear outer jacket for exceptional protection against scuffing paint or chrome

- All fittings are polished then chrome or black-chrome plated
- Low effort, high-efficiency cable design
- All cables are factory lubricated for smooth, consistent, long lasting-operation
- Made in the U.S.A.

STERLING CHROMITE II

FITS MODEL	OEM #	STOCK	+2"	+4"	+6"	+8"
For 14-18 Chief, Chieftain, Springfield	7082130	0652-2036	0652-2045	0652-2046	0652-2047	0652-2048
For 15-18 Scout, Scout Sixty	7082099	0652-2037	0652-2049	0652-2050	0652-2051	-

BLACK PEARL

FITS MODEL	OEM #	STOCK	+2"	+4"	+6"	+8"
For 14-18 Chief, Chieftain, Springfield	7082130	0652-2039	0652-2056	0652-2057	0652-2058	0652-2059
For 15-18 Scout, Scout Sixty	7082099	0652-2040	0652-2060	0652-2061	0652-2062	-

PART #	SUG. RETAIL	PART #	SUG. RETAIL	PART #	SUG. RETAIL	PART #	SUG. RETAIL	PART #	SUG. RETAIL
0652-2036	\$107.95	0652-2045	\$107.95	0652-2049	\$88.95	0652-2057	\$107.95	0652-2061	\$88.95
0652-2037	88.95	0652-2046	107.95	0652-2050	88.95	0652-2058	107.95	0652-2062	88.95
0652-2039	107.95	0652-2047	107.95	0652-2051	88.95	0652-2059	107.95		
0652-2040	88.95	0652-2048	107.95	0652-2056	107.95	0652-2060	88.95		



0652-1975



0652-1974



STEEL CABLES

- Barnett cables are smooth-working, long-lasting and made with the finest components available, making them virtually indestructible
- Steel cables with clear coating offer that custom look without the fear of damaging areas that the cables come in contact with

- Black vinyl cables are available with standard nylon-lined, PVC-coated casings
- Made in the U.S.A.

FITS MODEL	DESCRIPTION	STEEL PART #	SUG. RETAIL	BLACK VINYL PART #	SUG. RETAIL
For 14-18 Chief/Chieftain	Clutch (+6")	-	-	0652-1970	\$94.95
For 15-18 Scout	Clutch	0652-1975	\$85.95	0652-1973	64.95
	Clutch (+6")	-	-	0652-1974	64.95

All part numbers in **BLUE** are new for 2019.

- WINDSHIELDS & FAIRINGS
- AUDIO, COMMUNICATION & MOUNTS
- SADDLEBAGS & LUGGAGE
- SEATS & SISSY BARS
- EXHAUST
- FUEL/AIR SYSTEMS
- ENGINE
- TRANSMISSION & DRIVELINE
- GASKETS & SEALS
- ELECTRICAL
- LIGHTING
- HANDLEBARS, CONTROLS & MIRRORS
- CABLES**
- BRAKES
- TANKS & OIL FILTERS
- DASHES & GAUGES
- FRAMES & SUSPENSION
- FENDERS & LICENSE PLATE FRAMES
- FOOTRESTS & FLOORBOARDS
- WHEELS & AXLES
- HARDWARE, COVERS & GENERAL



WINDSHIELDS & FAIRINGS

AUDIO, COMMUNICATION & MOUNTS

SADDLEBAGS & LUGGAGE

SEATS & SISSY BARS

EXHAUST

FUEL/AIR SYSTEMS

ENGINE

TRANSMISSION & DRIVELINE

GASKETS & SEALS

ELECTRICAL

LIGHTING

HANDLEBARS, CONTROLS & MIRRORS

CABLES

BRAKES

TANKS & OIL FILTERS

DASHES & GAUGES

FRAMES & SUSPENSION

FENDERS & LICENSE PLATE FRAMES

FOOTRESTS & FLOORBOARDS

WHEELS & AXLES

HARDWARE, COVERS & GENERAL



Stainless kit



Black vinyl/stainless kit



Midnight kit



HANDLEBAR CABLE KITS, CLUTCH CABLES, AND BRAKE LINES

- Take "cable calculation" headaches out of swapping handlebars
- Kits include the correct length brake/clutch lines to complete a handlebar swap; electrical wire extensions not included
- Stainless braided kits include clutch line, brake lines, chrome "T" brake line junction, banjo bolts, fittings and copper crush washers
- Black vinyl/stainless kits include black vinyl clutch line and black stainless brake lines with chrome fittings, banjo bolts and crush washers
- The midnight kits include stainless steel brake lines and clutch lines covered in a black smoke tinted coating with pure black fittings throughout; lines appear graphite or carbon fiber in appearance providing that ultra custom look and the black fittings seamlessly blend with blacked out controls and covers on the bike
- Individual components for all kits are available as listed
- Made in the U.S.A.

STAINLESS BRAIDED KITS AND COMPONENTS

DESCRIPTION	CABLE KITS	SUG. RETAIL	CLUTCH CABLES	SUG. RETAIL	BRAKE LINES	SUG. RETAIL
FOR 15-19 SCOUT/SCOUT SIXTY/SCOUT BOBBER						
Stock	0662-0454	\$159.95	0652-2300	\$102.95	1741-5256	\$56.95
For use w/ 12"-14" Ape Hangers	0662-0457	159.95	0652-2303	102.95	1741-5259	56.95
For use w/ 15"-17" Ape Hangers	0662-0460	159.95	0652-2306	102.95	1741-5262	56.95
For use w/ 18"-20" Ape Hangers	0662-0463	159.95	0652-2309	102.95	1741-5265	56.95

BLACK VINYL/STAINLESS BRAIDED KITS AND COMPONENTS

DESCRIPTION	CABLE KITS	SUG. RETAIL	CLUTCH CABLES	SUG. RETAIL	BRAKE LINES	SUG. RETAIL
FOR 15-19 SCOUT/SCOUT SIXTY/SCOUT BOBBER						
Stock	0662-0455	\$159.95	0652-2301	\$102.95	1741-5257	\$56.95
For use w/ 12"-14" Ape Hangers	0662-0458	159.95	0652-2304	102.95	1741-5260	56.95
For use w/ 15"-17" Ape Hangers	0662-0461	159.95	0652-2307	102.95	1741-5263	56.95
For use w/ 18"-20" Ape Hangers	0662-0464	159.95	0652-2310	102.95	1741-5266	56.95

MIDNIGHT BRAIDED KITS AND COMPONENTS

DESCRIPTION	CABLE KITS	SUG. RETAIL	CLUTCH CABLES	SUG. RETAIL	BRAKE LINES	SUG. RETAIL
FOR 15-19 SCOUT/SCOUT SIXTY/SCOUT BOBBER						
Stock	0662-0456	\$159.95	0652-2302	\$102.95	1741-5258	\$56.95
For use w/ 12"-14" Ape Hangers	0662-0459	159.95	0652-2305	102.95	1741-5261	56.95
For use w/ 15"-17" Ape Hangers	0662-0462	159.95	0652-2308	102.95	1741-5264	56.95
For use w/ 18"-20" Ape Hangers	0662-0465	159.95	0652-2311	102.95	1741-5267	56.95

All part numbers in **BLUE** are new for 2019.



14" OFFSET FRONT BRAKE ROTOR

- Add braking performance and style
- 14" front rotors are drastically larger than stock, resulting in improved braking performance
- Billet brake caliper adapter included to relocate factory brake caliper
- Great way to improve the look of your bike; adds a race-style upgrade to the front wheel
- Bolt-on installation; requires no fabrication or bleeding of the front brakes

NOTE: Will not fit Scout models equipped with ABS when relocating the the caliper. The ABS sensor is attached and will not read the ABS timing ring.

PART #	DESCRIPTION	SUG. RETAIL
1710-3220	For 15-19 Scout/Sixty/Bobber without ABS	\$299.95



1710-3634



GALFER WAVE® BRAKE ROTORS

- Made from 420 high-carbon stainless Tier 1 steel
- Laser cut, never stamped
- Every rotor is individually heat-treated and double-disc parallel ground to assure perfect flatness
- Wave® design allows for lower operating temperatures in extreme use conditions
- Wave design is lighter than the stock round rotor design
- Sold each

FITS MODEL	DESCRIPTION	PART #	SUG. RETAIL
15-16 Scout (all)	Front, solid mount	1710-3634	\$245.95
	Rear, solid mount	1710-3634	245.95
14-16 Chief (all)	Front, floating	1710-3633	237.95
14-16 Chieftain (all)	Front, floating	1710-3633	237.95
15-16 Roadmaster	Front, floating	1710-3633	237.95
16 Springfield	Front, floating	1710-3633	237.95

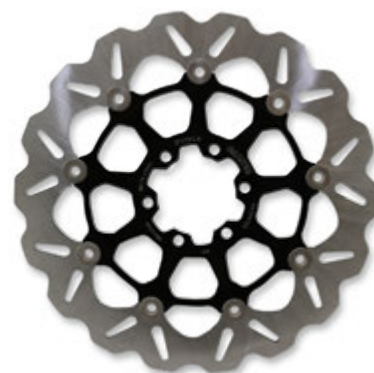

1710-3633



Organic



Semi-metallic



Sintered metal



BRAKE PADS

- Sintered metal brake pads are the OEM-type replacement pads for most bikes from the late 1970s to the present
- Sintered metal brake pads are proudly made in the U.S.A.; second-to-none in their stopping abilities and wear characteristics, while still providing excellent reduction in noise and dust
- Organic pads are OEM-type replacement brake pads for 1970s and earlier models

- Organic pads with aramid high-performance fibers are the perfect choice for polished or chromed rotors and billet steel rotors
- Both compounds of Drag Specialties brake pads are asbestos-, nickel- and lead-free

NOTE: If you are using aftermarket billet steel rotors, it is recommended you use our Organic pads with aramid high-performance fiber brake pads to avoid damage to them. Sintered pads are not recommended for billet steel rotors as the pad material is too aggressive for those rotors.

FRONT BRAKE PADS	SINTERED METAL	SEMI-METALLIC	ORGANIC ARAMID FIBER
DESCRIPTION			
02-08 (all models)	1721-1360	-	-
11 Chief Blackhawk (Brembo calipers)	1721-1947	-	1720-0277

BRAKE PADS continued on next page.

All part numbers in **BLUE** are new for 2019.

WINDSHIELDS & FAIRINGS

AUDIO, COMMUNICATION & MOUNTS

SADDLEBAGS & LUGGAGE

SEATS & SISSY BARS

EXHAUST

FUEL/AIR SYSTEMS

ENGINE

TRANSMISSION & DRIVELINE

GASKETS & SEALS

ELECTRICAL

LIGHTING

HANDLEBARS, CONTROLS & MIRRORS

CABLES

BRAKES

TANKS & OIL FILTERS

DASHES & GAUGES

FRAMES & SUSPENSION

FENDERS & LICENSE PLATE FRAMES

FOOTRESTS & FLOORBOARDS

WHEELS & AXLES

HARDWARE, COVERS & GENERAL



WINDSHIELDS & FAIRINGS

AUDIO, COMMUNICATION & MOUNTS

SADDLEBAGS & LUGGAGE

SEATS & SISSY BARS

EXHAUST

FUEL/AIR SYSTEMS

ENGINE

TRANSMISSION & DRIVELINE

GASKETS & SEALS

ELECTRICAL

LIGHTING

HANDLEBARS, CONTROLS & MIRRORS

CABLES

BRAKES

TANKS & OIL FILTERS

DASHES & GAUGES

FRAMES & SUSPENSION

FENDERS & LICENSE PLATE FRAMES

FOOTRESTS & FLOORBOARDS

WHEELS & AXLES

HARDWARE, COVERS & GENERAL

BRAKE PADS (CONT)

FRONT BRAKE PADS (CONT)

DESCRIPTION	SINTERED METAL	SEMI-METALLIC	ORGANIC ARAMID FIBER
11 Chief Blackhawk Dark (Brembo calipers)	1721-1947	-	1720-0277
11-13 Chief Classic (Brembo calipers)	1721-1947	-	1720-0277
09-11 Chief Standard (Brembo calipers)	1721-1947	-	1720-0277
09 Chief Deluxe (Brembo calipers)	1721-1947	-	1720-0277
09-11 Chief Roadmaster (Brembo calipers)	1721-1947	-	1720-0277
09-13 Chief Vintage (Brembo calipers)	1721-1947	-	1720-0277
13 Chief Vintage FE/LE	1721-1947	-	1720-0277
10-11 Bomber (Brembo Calipers)	1721-1947	-	1720-0277
10-13 Dark Horse (Brembo calipers)	1721-1947	-	1720-0277
15-16 Scout, Scout Sixty (Cast Wheel/Toso calipers)	1721-1948	-	-
15-18 Scout, Scout Sixty	1721-1949	-	-
15-16 Scout, 16 Scout Sixty	-	1721-2253	-
14-18 Chief Classic (Spoke Wheel/Nissin calipers)	1721-1952	-	-
14-18 Chief Vintage (Spoke Wheel/Nissin calipers)	1721-1952	-	-
16-18 Chief Dark Horse (Nissin calipers)	1721-1952	-	-
14-18 Chieftain (Cast Wheel/Nissin calipers)	1721-1952	-	-
15-18 Roadmaster (Cast Wheel/Nissin calipers)	1721-1952	-	-
16-18 Springfield	1721-1952	-	-

REAR BRAKE PADS

DESCRIPTION	SINTERED METAL	SEMI-METALLIC	ORGANIC ARAMID FIBER
02-08 (all models)	-	-	1720-0209
09 (all models)	1721-1946	-	1720-0276
11 Chief Blackhawk (Brembo calipers)	1721-1946	-	-
11 Chief Blackhawk Dark (Brembo calipers)	1721-1946	-	-
11-13 Chief Classic (Brembo calipers)	1721-1946	-	-
14-18 Chief Classic (Spoke Wheel/Nissin calipers)	1721-1948	-	1720-0278
16-18 Chief Dark Horse (Nissin calipers)	1721-1948	-	1720-0278
09-11 Chief Standard (Brembo calipers)	1721-1946	-	-
09 Chief Deluxe (Brembo calipers)	1721-1946	-	-
09-11 Chief Roadmaster (Brembo calipers)	1721-1946	-	-
09-13 Chief Vintage (Brembo calipers)	1721-1946	-	-
13 Chief Vintage FE/LE	1721-1946	-	-
14-18 Chief Vintage (Spoke Wheel/Nissin calipers)	1721-1948	-	1720-0278
14-18 Chieftain (Cast Wheel/Nissin calipers)	1721-1948	-	1720-0278
10-11 Bomber (Brembo Calipers)	1721-1946	-	-
10-13 Dark Horse (Brembo calipers)	1721-1946	-	1720-0276
15-16 Scout (Cast Wheel/Nissin calipers)	1721-1948	-	1720-0278
15-16 Scout, Scout Sixty	-	1721-2254	-
15-16 Scout, Scout Sixty (Cast Wheel/Toso calipers)	-	1721-2254	-
15-16 Roadmaster (Cast Wheel/Nissin calipers)	1721-1948	-	1720-0278

PRICE LIST

PART #	SUG. RETAIL	PART #	SUG. RETAIL	PART #	SUG. RETAIL
1720-0209	\$22.95	1721-1360	\$33.95	1721-1949	\$32.95
1720-0276	20.95	1721-1946	32.95	1721-1952	27.95
1720-0277	20.95	1721-1947	24.95	1721-2253	24.95
1720-0278	21.95	1721-1948	29.95	1721-2254	24.95

All part numbers in **BLUE** are new for 2019.



- WINDSHIELDS & FAIRINGS
- AUDIO, COMMUNICATION & MOUNTS
- SADDLEBAGS & LUGGAGE
- SEATS & SISSY BARS
- EXHAUST
- FUEL/AIR SYSTEMS
- ENGINE
- TRANSMISSION & DRIVELINE
- GASKETS & SEALS
- ELECTRICAL
- LIGHTING
- HANDLEBARS, CONTROLS & MIRRORS
- CABLES
- BRAKES**
- TANKS & OIL FILTERS
- DASHES & GAUGES
- FRAMES & SUSPENSION
- FENDERS & LICENSE PLATE FRAMES
- FOOTRESTS & FLOORBOARDS
- WHEELS & AXLES
- HARDWARE, COVERS & GENERAL

DP BRAKES

THE ORIGINAL SINTERED BRAKES

- DP Brakes brake pads are designed with sintered metal compounds to give your bike high-tech performance in all conditions
- Pads have a quick break-in period so you get maximum performance fast
- DP Brakes design and materials ensure consistent hard stops and fade-free performance
- Sintered metal compounds outlast more conventional organic or aramid fiber pads

STANDARD SINTERED METAL BRAKE PADS

- GG friction rated and made with DP Brakes' proven sintered metal material
- Gray-colored aluminum oxide-based ceramic material on rear of backing plate keeps heat away from caliper piston and fluid in extreme conditions for fade-free performance
- Pad compound gives equal performance in wet or dry conditions
- Ideal replacement for street and touring machines where durability is the prime requirement
- No brake fade

SPORT HH+ SUPERSPORT PADS

- Powerful, industry-high HH+ friction rating with no mileage penalty
- High-tech ceramic heat shield eliminates brake fade
- Dust-free compound design
- Quick break-in so you get maximum braking ability fast
- For front wheel use only

NOTE: For brake pad applications, see chart below.

FITS MODEL		STANDARD PAD PART #	SPORT HH+ PAD PART#				
FRONT BRAKE PADS							
02-08 All models	-	-	SDP-911HH				
09-11 All models	-	-	SDP-614HH				
11 Chief Blackhawk (Brembo calipers)	-	-	SDP-614HH				
11 Chief Blackhawk Dark (Brembo calipers)	-	-	SDP-614HH				
11-13 Chief Classic (Brembo calipers)	-	-	SDP-614HH				
09-11 Chief Standard (Brembo calipers)	-	-	SDP-614HH				
09 Chief Deluxe (Brembo calipers)	-	-	SDP-614HH				
09-11 Chief Roadmaster (Brembo calipers)	-	-	SDP-614HH				
09-13 Chief Vintage (Brembo calipers)	-	-	SDP-614HH				
13 Chief Vintage FE/LE	-	-	SDP-614HH				
10-11 Bomber (Brembo Calipers)	-	-	SDP-911HH				
10-13 Dark Horse (Brembo calipers)	-	-	SDP-614HH				
14-18 Chief Classic (Spoke Wheel/Nissin calipers)	-	-	SDP-922HH				
14-19 Chief Vintage (Spoke Wheel/Nissin calipers)	-	-	SDP-922HH				
14-19 Chief Dark Horse (Nissin calipers)	-	-	SDP-922HH				
14-19 Chieftain (Cast Wheel/Nissin calipers)	-	-	SDP-922HH				
16-19 Scout (Nissin Calipers)	1721-2450	-	-				
15-16 Roadmaster (Cast Wheel/Nissin calipers)	-	-	SDP-922HH				
REAR BRAKE PADS							
02-08 All models	-	-	SDP-911HH				
09 All models	DP-701	-	-				
11 Chief Blackhawk (Brembo calipers)	DP-701	-	-				
11 Chief Blackhawk Dark (Brembo calipers)	DP-701	-	-				
11-13 Chief Classic (Brembo calipers)	DP-701	-	-				
09-11 Chief Standard (Brembo calipers)	DP-701	-	-				
09 Chief Deluxe (Brembo calipers)	DP-701	-	-				
09-11 Chief Roadmaster (Brembo calipers)	DP-701	-	-				
09-13 Chief Vintage (Brembo calipers)	DP-701	-	-				
13 Chief Vintage FE/LE	DP-701	-	-				
10-11 Bomber (Brembo Calipers)	DP-701	-	-				
10-13 Dark Horse (Brembo calipers)	DP-701	-	-				
14-19 Chief Classic (Spoke Wheel/Nissin calipers)	DP-118	-	-				
14-19 Chief Vintage (Spoke Wheel/Nissin calipers)	DP-118	-	-				
16 Chief Dark Horse (Nissin calipers)	DP-118	-	-				
14-18 Chieftain (Cast Wheel/Nissin calipers)	DP-118	-	-				
16-19 Scout (Nissin Calipers)	1721-2451	-	-				
15-16 Roadmaster (Cast Wheel/Nissin calipers)	DP-118	-	-				
PART #	SUG. RETAIL	PART #	SUG. RETAIL	PART #	SUG. RETAIL	PART #	SUG. RETAIL
DP-118	\$48.95	SDP-614HH	\$48.95	SDP-922HH	\$48.95	1721-2451	\$44.95
DP-701	43.95	SDP-911HH	42.95	1721-2450	49.95		

All part numbers in **BLUE** are new for 2019.



- WINDSHIELDS & FAIRINGS
- AUDIO, COMMUNICATION & MOUNTS
- SADDLEBAGS & LUGGAGE
- SEATS & SISSY BARS
- EXHAUST
- FUEL/AIR SYSTEMS
- ENGINE
- TRANSMISSION & DRIVELINE
- GASKETS & SEALS
- ELECTRICAL
- LIGHTING
- HANDLEBARS, CONTROLS & MIRRORS
- CABLES
- BRAKES**
- TANKS & OIL FILTERS
- DASHES & GAUGES
- FRAMES & SUSPENSION
- FENDERS & LICENSE PLATE FRAMES
- FOOTRESTS & FLOORBOARDS
- WHEELS & AXLES
- HARDWARE, COVERS & GENERAL



1721-1817



1722-0699



Sintered

BRAKE PADS

- SBS brake pads feature asbestos-free brake pad materials using patented Unified Composite Technology (UCT)
- UCT technology completely blends all brake pad materials into a balanced, unified pad
- This balance ensures no hot spots, glazing, premature fading or excessive rotor wear
- The result is powerful, fade-free braking performance, even in extreme conditions

BRAKE PAD APPLICATION CHART

FITS MODEL	STREET EXCEL PART #
FRONT BRAKE PADS	
01-08 Chief, all models	1721-1817
09-13 Chief, all models	1721-1553 ¹
11 Chief Blackhawk (Brembo calipers)	1721-1553
11 Chief Blackhawk Dark (Brembo calipers)	1721-1553
11-13 Chief Classic (Brembo calipers)	1721-1553
09-11 Chief Standard (Brembo calipers)	1721-1553
09 Chief Deluxe (Brembo calipers)	1721-1553
09-11 Chief Roadmaster (Brembo calipers)	1721-1553
09-13 Chief Vintage (Brembo calipers)	1721-1553
13 Chief Vintage FE/LE	1721-1553
10-11 Bomber (Brembo Calipers)	1721-1553
10-13 Dark Horse (Brembo calipers)	1721-1553
14-16 Chief Classic (Spoke Wheel/Nissin calipers)	1722-0674
16 Chief Dark Horse (Nissin calipers)	1722-0674
14-19 Chief, all models	1722-0674 ¹
14-16 Chieftain (Cast Wheel/Nissin calipers)	1722-0674
15-19 Roadmaster	1722-0674 ¹
15-16 Roadmaster (Cast Wheel/Nissin calipers)	1722-0674
01-08 Scout, all models	1721-1817
17-19 Scout, Scout Sixty, Scout Bobber	1721-1899
16-19 Springfield	1722-0674 ¹
15-19 Springfield Dark Horse	1722-0674 ¹

STREET EXCEL SINTERED METAL PADS

- The best in sintered replacement pads for high-performance front (HS) and rear (LS) street applications
- Use advanced sintering process technology; perfect for sport riding
- The highest coefficient of friction in the lineup to provide maximum stopping power
- Formulation also offers high fade-resistance and quick cool-down under severe braking
- When you need to replace your worn sintered metal pads, choose STREET excel; the sinter compounds with the power to stop you

FITS MODEL	STREET EXCEL PART #
REAR BRAKE PADS	
01-08 Chief, all models	1721-1818
09-13 Chief, all models	1721-1646
11 Chief Blackhawk (Brembo calipers)	1721-1646
11 Chief Blackhawk Dark (Brembo calipers)	1721-1646
11-13 Chief Classic (Brembo calipers)	1721-1646
09-11 Chief Standard (Brembo calipers)	1721-1646
09 Chief Deluxe (Brembo calipers)	1721-1646
09-11 Chief Roadmaster (Brembo calipers)	1721-1646
09-13 Chief Vintage (Brembo calipers)	1721-1646
13 Chief Vintage FE/LE	1721-1646
10-11 Bomber (Brembo Calipers)	1721-1646
10-13 Dark Horse (Brembo calipers)	1721-1646
14-16 Chief Classic (Spoke Wheel/Nissin calipers)	1722-0672
16 Chief Dark Horse (Nissin calipers)	1722-0672
14-19 Chief, all models	1722-0672
14-16 Chieftain (Cast Wheel/Nissin calipers)	1722-0672
15-19 Roadmaster	1722-0672
15-16 Roadmaster (Cast Wheel/Nissin calipers)	1722-0672
01-08 Scout, all models	1721-1818
17-19 Scout, Scout Sixty, Scout Bobber	1722-0699
16-19 Springfield	1722-0672
15-19 Springfield Dark Horse	1722-0672

¹ Requires two sets.

PART #	SUG. RETAIL	PART #	SUG. RETAIL
1721-1553	\$33.95	1721-1817	\$44.95
1721-1646	41.95	1721-1818	46.95

PART #	SUG. RETAIL	PART #	SUG. RETAIL
1721-1899	\$44.95	1722-0674	\$41.95
1722-0672	41.95	1722-0699	41.95

All part numbers in **BLUE** are new for 2019.



Organic pads

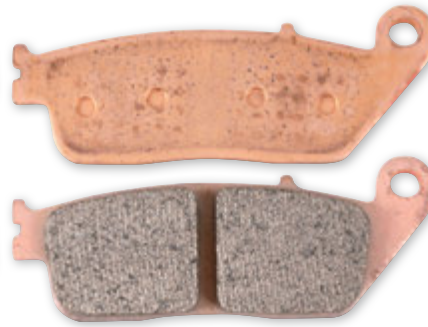

Double-H sintered pads



Semi-sintered "V" pads

- WINDSHIELDS & FAIRINGS
- AUDIO, COMMUNICATION & MOUNTS
- SADDLEBAGS & LUGGAGE
- SEATS & SISSY BARS
- EXHAUST
- FUEL/AIR SYSTEMS
- ENGINE
- TRANSMISSION & DRIVELINE
- GASKETS & SEALS
- ELECTRICAL
- LIGHTING
- HANDLEBARS, CONTROLS & MIRRORS
- CABLES
- BRAKES**
- TANKS & OIL FILTERS
- DASHES & GAUGES
- FRAMES & SUSPENSION
- FENDERS & LICENSE PLATE FRAMES
- FOOTRESTS & FLOORBOARDS
- WHEELS & AXLES
- HARDWARE, COVERS & GENERAL

BRAKE PADS

ORGANIC BRAKE PADS

- The world's #1 selling organic disc brake pads
- EBC Organic brake pads contain Aramid fibers; these are man-made high-performance fibers used widely for their light weight, high strength, abrasion resistance and thermal stability
- Aramid fibers have high strength-to-weight, thermal stability and abrasion resistance to provide advantages over cheaper steel fiber-based products
- Provide excellent stopping power without noise and rotor galling, even on polished rotors
- Fingertip control and strong, predictable brake response

DOUBLE-H SINTERED METAL PADS

- Feature the HH friction rating – the highest in the industry
- Provide maximum brake effect and last twice as long as organic pads
- Sintered pads are made in the U.S.A.

SEMI-SINTERED "V" PADS

- All-new semi-sintered construction containing 30% copper by weight within an organic matrix
- This design has the long life of a sintered pad with the great feel and are more rotor friendly than the more aggressive sintered pads
- Can be used to replace organic or sintered metal compound pads

	ORGANIC PAD PART #	V SEMI SINTERED PART #	HH SINTERED PART #
FITS MODEL			
FRONT BRAKE PADS			
All 02-08 models	FA216/3	1721-1416	1721-0139
All 09 models	FA95	1721-1450	FA95HH
11 Chief Blackhawk (Brembo calipers)	FA95	1721-1450	FA95HH
11 Chief Blackhawk Dark (Brembo calipers)	FA95	1721-1450	FA95HH
11-13 Chief Classic (Brembo calipers)	FA95	1721-1450	FA95HH
09-11 Chief Standard (Brembo calipers)	FA95	1721-1450	FA95HH
09 Chief Deluxe (Brembo calipers)	FA95	1721-1450	FA95HH
09-11 Chief Roadmaster (Brembo calipers)	FA95	1721-1450	FA95HH
09-13 Chief Vintage (Brembo calipers)	FA95	1721-1450	FA95HH
13 Chief Vintage FE/LE	FA95	1721-1450	FA95HH
10-11 Bomber (Brembo Calipers)	FA95	1721-1450	FA95HH
10-13 Dark Horse (Brembo calipers)	FA95	1721-1450	FA95HH
14-18 Chief Classic/Vintage (Spoke Wheel/Nissin calipers)	-	-	FA347HH
16-18 Chief Dark Horse (Nissin calipers)	-	-	FA347HH
14-18 Chieftain (Cast Wheel/Nissin calipers)	-	-	FA347HH
16-18 Scout 1200 (Cast Wheel/Toso calipers)	1720-0021	1721-1411	FA196HH
16-19 Scout 1200 (Nissin Calipers)	FA209/2	1721-1415	FA209/2HH
18 Scout Bobber	FA209/2	1721-1415	FA209/2HH
17-19 Scout Sixty	FA209/2	1721-1415	FA209/2HH
15-18 Roadmaster/Classic/Elite (Nissin calipers)	-	-	FA347HH
REAR BRAKE PADS			
All 02-08 models	FA216/3	1721-1416	1721-0139
All 09 models	FA18	-	FA18HH
11 Chief Blackhawk (Brembo calipers)	FA18	-	FA18HH
11 Chief Blackhawk Dark (Brembo calipers)	FA18	-	FA18HH
11-13 Chief Classic (Brembo calipers)	FA18	-	FA18HH
09-11 Chief Standard (Brembo calipers)	FA18	-	FA18HH
09 Chief Deluxe (Brembo calipers)	FA18	-	FA18HH
09-11 Chief Roadmaster (Brembo calipers)	FA18	-	FA18HH
09-13 Chief Vintage (Brembo calipers)	FA18	-	FA18HH
13 Chief Vintage FE/LE	FA18	-	FA18HH
10-11 Bomber (Brembo Calipers)	FA18	-	FA18HH
10-13 Dark Horse (Brembo calipers)	FA18	-	FA18HH
14-18 Chief Classic/Vintage (Spoke Wheel/Nissin calipers)	1720-0021	1721-1411	FA196HH
16-18 Chief Dark Horse (Nissin calipers)	1720-0021	1721-1411	FA196HH
14-18 Chieftain (Cast Wheel/Nissin calipers)	1720-0021	1721-1411	FA196HH
16-18 Scout 1200 (Nissin Calipers)	1720-0021	1721-1411	FA196HH
15-18 Roadmaster/Classic/Elite (Nissin calipers)	1720-0021	1721-1411	FA196HH

PART #	SUG. RETAIL	PART #	SUG. RETAIL	PART #	SUG. RETAIL	PART #	SUG. RETAIL	PART #	SUG. RETAIL
FA18	\$29.95	FA95HH	\$38.95	FA209/2HH	\$45.95	1720-0021	\$31.95	1721-1415	\$56.95
FA18HH	38.95	FA196HH	38.95	FA216/3	31.95	1721-0139	38.95	1721-1416	34.95
FA95	29.95	FA209/2	34.95	FA347HH	38.95	1721-1411	34.95	1721-1450	35.95

All part numbers in **BLUE** are new for 2019.

WINDSHIELDS & FAIRINGS

AUDIO, COMMUNICATION & MOUNTS

SADDLEBAGS & LUGGAGE

SEATS & SISSY BARS

EXHAUST

FUEL/AIR SYSTEMS

ENGINE

TRANSMISSION & DRIVELINE

GASKETS & SEALS

ELECTRICAL

LIGHTING

HANDLEBARS, CONTROLS & MIRRORS

CABLES

BRAKES

TANKS & OIL FILTERS

DASHES & GAUGES

FRAMES & SUSPENSION

FENDERS & LICENSE PLATE FRAMES

FOOTRESTS & FLOORBOARDS

WHEELS & AXLES

HARDWARE, COVERS & GENERAL



1722-0797



1721-2343

BRAKE PADS

- Galfer has more than 60 years of experience in brake pad friction material construction
- Multiple compounds available for all types of riding styles

SEMI-METALLIC CARBON

- Great feel and modulation; ideal choice when replacing OEM compound pads
- Long-lasting pad compound with minimal rotor wear
- Good performance in wet/dry conditions
- GG friction rated

HH SINTERED

- For aggressive street riding/sport use
- Excellent feel at the lever and power modulation
- Advanced ceramic composites are ready to withstand higher temperatures than regular semi-metallic carbon brake pads
- Great heat recovery and easy on brake rotor discs
- HH friction rated

HH SINTERED CERAMIC

- For aggressive street riding/sport use
- Excellent feel at the lever and power modulation
- Advanced ceramic composites are ready to withstand higher temperatures than regular semi-metallic carbon brake pads
- Ceramic-coated backing plate assists with brake temperature management and heat dissipation
- HH friction rated

FITS MODEL	FRONT COMPOUND TYPE	FRONT PART #	SUG. RETAIL	REAR COMPOUND TYPE	REAR PART #	SUG. RETAIL
15-16 Scout	-	-	-	Semi Metallic Carbon	1722-0795	\$31.95
17-19 Scout/Scout Sixty/Bobber	HH Sintered	1722-0796	\$38.95	HH Sintered	1722-0797	34.95
19 FTR1200/R	HH Sintered Ceramic	1722-0798	69.95	-	-	-
	-	-	-	HH Sintered	1722-0797	34.95
09-13 Chief	HH Sintered Ceramic	1721-2335	69.95	-	-	-
	-	-	-	HH Sintered	1721-2373	40.95
14-16 Chief	HH Sintered Ceramic	1721-2343	69.95	-	-	-
	-	-	-	HH Sintered	1722-0794	38.95
17-19 Chief	-	-	-	HH Sintered	1722-0794	38.95
18-19 Chieftain	-	-	-	HH Sintered	1722-0794	38.95
17-19 Roadmaster	HH Sintered Ceramic	1721-2343	69.95	-	-	-
	-	-	-	HH Sintered	1722-0794	38.95
17-19 Springfield	HH Sintered Ceramic	1721-2343	69.95	-	-	-
	-	-	-	HH Sintered	1722-0794	38.95



1741-5060



1741-4663

EZ-ALIGN BRAIDED FRONT BRAKE LINES

- E-Z Align rotating caliper banjo feature for perfect no-kink fitments
- All fittings are polished and chrome or black chrome plated
- The industry's highest-quality braid available in two color choices to complement your bike; Sterling Chromite II® and Black Pearl braided with black wire
- Braid color and weave match on all Magnum control cables and brake lines
- Crystal-clear outer jacket offers exceptional protection against scuffing paint or chrome and will never discolor
- Inner PTFE tubing braided with Aramid Fiber reinforcement provides the ultimate in high performance by greatly reducing line expansion
- Exceeds all DOT FMVSS-106 Specifications
- Made in the U.S.A.

FITS MODEL	DESCRIPTION	COLOR	OEM #	STOCK	+2"	+4"	+6"	+8"
14-18 Chief/ Chieftain/ Chief Vintage, 15-18 Roadmaster, 16-18 Chief Dark Horse/ Chieftain Dark Horse/Springfield	Upper ABS Brake Line	Sterling Chromite II	-	-	1741-5054	1741-5055	1741-5056	1741-5057
	Upper ABS Brake Line	Black Pearl	-	1741-5058	1741-5059	1741-5060	1741-5061	1741-5062
15-18 Scout/Scout Sixty	Non-ABS Brake Line	Sterling Chromite II	1912416	1741-4663	1741-4664	1741-4665	1741-4666	1741-4667
	Non-ABS Brake Line	Black Pearl	1912416	1741-4675	1741-4676	1741-4677	1741-4678	1741-4679

PART #	SUG. RETAIL	PART #	SUG. RETAIL	PART #	SUG. RETAIL	PART #	SUG. RETAIL
1741-4663	\$70.95	1741-4675	\$70.95	1741-5054	\$126.95	1741-5059	\$126.95
1741-4664	71.95	1741-4676	71.95	1741-5055	127.95	1741-5060	127.95
1741-4665	72.95	1741-4677	72.95	1741-5056	129.95	1741-5061	129.95
1741-4666	73.95	1741-4678	73.95	1741-5057	130.95	1741-5062	130.95
1741-4667	74.95	1741-4679	74.95	1741-5058	125.95		

All part numbers in **BLUE** are new for 2019.

KURYAKYN



TANK SIDE SCOOPS

- Formed for a seamless fit to match the tank's contours
- Durable injection-molded ABS housings
- Easy to install with high-strength 3M® VHB™
- Available in chrome or satin black finish

PART #	DESCRIPTION	SUG. RETAIL
FOR ALL 15-19 SCOUT MODELS		
0504-0307	Chrome	\$79.99

PART #	DESCRIPTION	SUG. RETAIL
FOR ALL 15-19 SCOUT MODELS (CONT)		
0504-0308	Gloss black	\$79.99



AZTEC FUEL CAPS

- Classic styling reminiscent of a traditional sundial design
- Direct replacement made from durable die-cast aluminum
- Includes vented fuel cap and dummy cap
- Available in chrome or satin black finish

PART #	DESCRIPTION	SUG. RETAIL
FOR INDIAN MODELS 14-19 (EXCEPT SCOUT/SCOUT SIXTY/SCOUT BOBBER)		
0703-0800	Chrome	\$99.99
0703-0801	Satin black	99.99

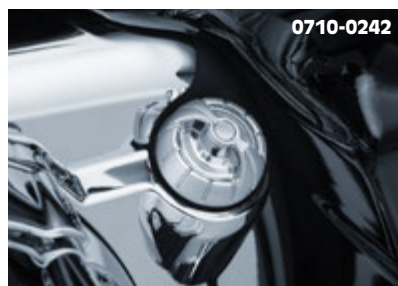

AZTEC DIPSTICKS

- Eliminate the hassle of removing the OEM dipstick while maintaining a clean custom appearance with this direct replacement designed with factory styling cues in mind
- Do not require tools to remove and check oil level
- Made from quality aluminum and durable, injection-molded high-temp ABS
- Available in chrome or satin black finish

PART #	DESCRIPTION	SUG. RETAIL
FOR INDIAN MODELS 14-19 (EXCEPT SCOUT/SCOUT SIXTY/SCOUT BOBBER)		
0710-0242	Chrome	\$59.99
0710-0243	Satin black	59.99



CHROME OIL COOLER COVER

- Mounts directly over the oil cooler
- Does not restrict airflow
- Simple to install

PART #	DESCRIPTION	SUG. RETAIL
0713-0130	For 14-19 Indian models (all except Scout/Scout Sixty/Scout Bobber)	\$61.99

All part numbers in **BLUE** are new for 2019.

- WINDSHIELDS & FAIRINGS
- AUDIO, COMMUNICATION & MOUNTS
- SADDLEBAGS & LUGGAGE
- SEATS & SISSY BARS
- EXHAUST
- FUEL/AIR SYSTEMS
- ENGINE
- TRANSMISSION & DRIVELINE
- GASKETS & SEALS
- ELECTRICAL
- LIGHTING
- HANDLEBARS, CONTROLS & MIRRORS
- CABLES
- BRAKES
- TANKS & OIL FILTERS**
- DASHES & GAUGES
- FRAMES & SUSPENSION
- FENDERS & LICENSE PLATE FRAMES
- FOOTRESTS & FLOORBOARDS
- WHEELS & AXLES
- HARDWARE, COVERS & GENERAL



WINDSHIELDS & FAIRINGS

AUDIO, COMMUNICATION & MOUNTS

SADDLEBAGS & LUGGAGE

SEATS & SISSY BARS

EXHAUST

FUEL/AIR SYSTEMS

ENGINE

TRANSMISSION & DRIVELINE

GASKETS & SEALS

ELECTRICAL

LIGHTING

HANDLEBARS, CONTROLS & MIRRORS

CABLES

BRAKES

TANKS & OIL FILTERS

DASHES & GAUGES

FRAMES & SUSPENSION

FENDERS & LICENSE PLATE FRAMES

FOOTRESTS & FLOORBOARDS

WHEELS & AXLES

HARDWARE, COVERS & GENERAL

CLASSIC BLACK TUXEDO™ TIE

- Made from marine-grade vinyl
- Double-layered face pouch and simple decorative concho
- Includes EZ Lock™ mounting which allows the pouch to be removed with a twist
- Measures 8" x 4.5" x 1.5"
- Made in the U.S.A.

PART #	DESCRIPTION	SUG. RETAIL
0701-0860	For 14-18 Roadmaster/Chieftain	\$89.95



TANK POUCH

- The Black Classic Pouch attaches to the tuxedo base using Hopnel's EZ Lock™ mount system
- With a single twist, this handy pouch can be removed
- The generous 7¼" x 4½" x 1½" storage pouch accommodates most cell phones behind a clear pocket that allows rider to swipe easily
- Includes Black Classic Tank Pouch and Hopnel's EZ Lock™ mounting system
- Made in the U.S.A.



GAS TANK MINI BRA

- A great way to help protect a gas tank from buckles, zippers, and knee scratches
- Wraps around the gas tank between rider and the seat, providing a tailored fit design with scratch protection
- Securely attaches with hook-and-loop material to the gas tank, allowing easy access for cleaning
- Made in the U.S.A.



PART #	DESCRIPTION	SUG. RETAIL
3502-0263	For 14-18 Roadmaster/Chieftain/Chief/Springfield	\$55.95

PART #	DESCRIPTION	SUG. RETAIL
0701-0857	For 14-18 Roadmaster/Chieftain/Chief/Springfield	\$34.95



3508-0052

TWIN DASH POUCHES

- Mount securely with hook-and-loop material to the top of the fairing dash and will not work loose even in the harshest driving conditions
- Tapered design allows airflow from the windshield vent opening, keeping proper air movement over the dash
- Zippered openings are protected by a full-length flap covering the opening to keep weather from getting inside
- Available in Black or matching Desert Tan
- Each pouch measures 8.5" x 2.5" x 3" deep, with a combined length of 17"
- Made in the U.S.A.

PART #	DESCRIPTION	SUG. RETAIL
FOR 14-18 ROADMASTER/CHIEFTAIN		
3508-0052	Black	\$49.95
3508-0053	Desert tan	49.95



3508-0053

All part numbers in **BLUE** are new for 2019.

KURYAKYN

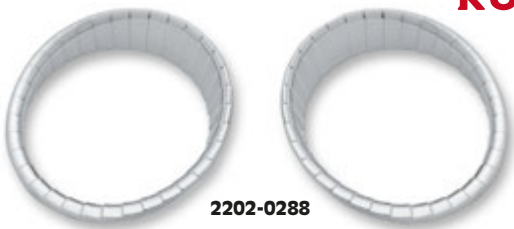

2202-0288



2202-0289

AZTEC GAUGE CLUSTER ACCENTS

- Feature a grooved and beveled design that delivers a clean, custom style to the recessed area surrounding the gauges
- Hassle-free installation using high-strength 3M® VHB™ adhesive
- Durable, injection-molded ABS available in chrome or satin black

PART #	DESCRIPTION	SUG. RETAIL
FOR 17-18 CHIEFTAIN/ROADMASTER MODELS		
2202-0288	Chrome	\$49.99
2202-0289	Satin black	49.99



4405-0502

ACCENT STEREO ACCENTS

- Bring life to the panel surrounding the Indian Ride Command touchscreen and controls for a completely new look
- Hassle-free installation using high-strength 3M® VHB™ adhesive
- Durable, injection-molded ABS available in chrome or satin black



2202-0286

PART #	DESCRIPTION	SUG. RETAIL
FOR 17-18 CHIEFTAIN/ROADMASTER		
4405-0502	Chrome	\$39.99
2202-0286	Satin black	39.99



SPEAKER GRILLES

- Add just the right amount of chrome to the inner fairing
- Easy to install

PART #	DESCRIPTION	SUG. RETAIL
4405-0374	For 14-16 Chieftain and Roadmaster models	\$99.99



TOP DASH ACCENT

- Injection-molded, chrome-plated ABS accent complements OEM gauge bezels
- Design incorporates the same raised center and grooved scallop feature found above the OEM headlight housing
- Simple, peel-and-stick application

PART #	DESCRIPTION	SUG. RETAIL
2202-0222	For 14-16 Chieftain and Roadmaster models	\$61.99



AZTEC TOP DASH ACCENT

- Enhances the top dash panel behind the windshield and above the touchscreen for a unique, custom appearance
- Made from durable injection-molded ABS
- Easy to install using high-strength VHB™ adhesive
- Available in satin black

PART #	DESCRIPTION	SUG. RETAIL
2202-0290	For 17-18 Chieftain/Roadmaster	\$49.99



All part numbers in **BLUE** are new for 2019.

- WINDSHIELDS & FAIRINGS
- AUDIO, COMMUNICATION & MOUNTS
- SADDLEBAGS & LUGGAGE
- SEATS & SISSY BARS
- EXHAUST
- FUEL/AIR SYSTEMS
- ENGINE
- TRANSMISSION & DRIVELINE
- GASKETS & SEALS
- ELECTRICAL
- LIGHTING
- HANDLEBARS, CONTROLS & MIRRORS
- CABLES
- BRAKES
- TANKS & OIL FILTERS
- DASHES & GAUGES
- FRAMES & SUSPENSION
- FENDERS & LICENSE PLATE FRAMES
- FOOTRESTS & FLOORBOARDS
- WHEELS & AXLES
- HARDWARE, COVERS & GENERAL

WINDSHIELDS & FAIRINGS

AUDIO, COMMUNICATION & MOUNTS

SADDLEBAGS & LUGGAGE

SEATS & SISSY BARS

EXHAUST

FUEL/AIR SYSTEMS

ENGINE

TRANSMISSION & DRIVELINE

GASKETS & SEALS

ELECTRICAL

LIGHTING

HANDLEBARS, CONTROLS & MIRRORS

CABLES

BRAKES

TANKS & OIL FILTERS

DASHES & GAUGES

FRAMES & SUSPENSION

FENDERS & LICENSE PLATE FRAMES

FOOTRESTS & FLOORBOARDS

WHEELS & AXLES

HARDWARE, COVERS & GENERAL



SIGNATURE SERIES SPRINT CHIN SPOILER

- Gives the radiator a clean, stylish appearance
- Design provides optimum airflow to the radiator
- Made from high-impact ABS with an unfinished surface that requires minimum prep for paint
- Direct replacement for the OEM radiator spoiler

PART #	DESCRIPTION	SUG. RETAIL
0504-0295	For 15-19 Scout models	\$149.99



REAR SWINGARM COVERS

- Conceals the unsightly axle nut and adjuster stud for a clean, custom look
- Quality A380 aluminum construction with premium chrome plating
- Secure bolt-on installation and easy removal for required maintenance
- Sold in pairs

PART #	DESCRIPTION	SUG. RETAIL
1303-0309	For 15-16 Scout models	\$119.99



LEGACY SWINGARM PIVOT ACCENT

- A simple and effective way to cover the unsightly swingarm pivot and bolt
- Quality, cast-aluminum construction with premium chrome plating
- Includes hardware for easy, bolt-on installation
- Measures 3 1/2" long x 2 3/4" tall

PART #	DESCRIPTION	SUG. RETAIL
1303-0308	For 15-19 Scout models	\$49.99

LEGACY MID-FRAME ACCENTS

- Contoured to flow with the frame, the beveled edges, grooved speedlines and unique stepped design reflect classic Indian Scout styling
- Conceal unsightly frame bolts
- Durable, lightweight injection-molded ABS with premium chrome plating
- Hassle-free, tool-less installation using automotive-grade 3M® VHB™
- Sold in pairs



PART #	DESCRIPTION	SUG. RETAIL
0504-0316	For 15-19 Scout models	\$79.99



0502-0535

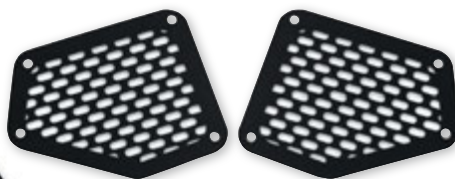

0504-0296



1303-0298

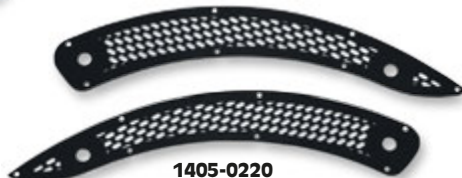

1405-0220



1904-0149

SIGNATURE SERIES FRAME, SWINGARM, FENDER, SIDE COVER AND RADIATOR SIDE ACCENTS

- Satin black mesh accents with visible rivets transform the Scout into a bold, race-inspired custom look
- Made of stamped 6061 aluminum
- Easy installation using high-strength adhesive
- Sold in pairs

PART #	DESCRIPTION	SUG. RETAIL	PART #	DESCRIPTION	SUG. RETAIL
FOR 15-19 SCOUT, SCOUT SIXTY					
0502-0535	Neck frame accents	\$29.99	1405-0220	Rear fender side accents	\$59.99
0504-0296	Side cover frame accents	29.99	1904-0149	Radiator side accents	49.99
1303-0298	Swingarm frame accents	34.99			

All part numbers in **BLUE** are new for 2019.

KURYAKYN

TIE-DOWN BRACKETS

- Provide a secure, easily accessible location to attach tie-down straps for transport
- Laser-cut from high-quality, durable steel
- Satin black or chrome finish
- Quick, easy installation
- Sold in pairs



3920-0429



3920-0436

PART #	DESCRIPTION	SUG. RETAIL
FOR 14-18 CHIEFTAIN, 19 CHIEFTAIN CLASSIC, 15-19 ROADMASTER MODELS		
3920-0429	Satin black	\$59.99
FOR 14-19 CHIEF, CLASSIC, DARK HORSE AND VINTAGE MODELS		
3920-0436	Chrome	59.99



TRAILER HITCH

- Classic 1 1/4" receiver hitch mounts directly to the bike's frame with provided graded bolts for a secure fitment
- Hitch includes Big Bike Parts® standard anti-chatter bolt to remove excess movement from the hitch receiver, improving the pulling smoothness of the hitch systems
- Made in the U.S.A.



PART #	DESCRIPTION	SUG. RETAIL
3902-0208	For 14-18 Roadmaster/Chieftain/Chief/Springfield	\$259.95



3902-0190



HIDDEN TRAILER HITCH

- Hitch is hidden when tongue is removed
- Bolt-on installation
- Made from high-tensile steel
- Chrome-plated tongue
- Includes mounting instructions and hardware
- Made in the U.S.A.

PART #	DESCRIPTION	SUG. RETAIL
3902-0190	For all 14-16 Indian models (except Scout)	\$299.95
3902-0204	For all 17-19 Indian models (except Scout)	299.95



TRAILER ISOLATOR HARNESS

- Five-wire features left, right, brake, turn and ground wire outputs
- Four-wire features a molex flat connector with left/brake, right/brake, run and ground wire outputs

PART #	DESCRIPTION	SUG. RETAIL
FOR 14-19 INDIAN MODELS EXCEPT SCOUT		
2010-1355	5-wire harness	\$119.95
2010-1356	4-wire harness	119.95



2010-1355



TRAILER WIRING SUB-HARNESS

- Six-pin Molex plug-n-play motorcycle trailer wiring sub-harness
- No splicing or soldering
- No damage to your factory wiring
- Plugs directly into your factory taillight harness

PART #	DESCRIPTION	SUG. RETAIL
3902-0193	For 14-19 Chief/Chieftain	\$39.95



LINDBY CUSTOM, INC. THE LINBAR®

LINBAR® FRONT HIGHWAY BARS

- Made from 1 1/4" high-strength steel that has a triple-chrome-plated finish for long-lasting durability
 - Precision bent and welded for a perfect fit every time
 - Neoprene O-rings provide traction in all climates
- U.S. Patent #D361311.

NOTE: Not recommended for use with extended forward controls or extended floorboards.



1624-0261



1907-5010

PART #	FITS MODEL	SUG. RETAIL
1624-0261	For 14-18 Chief Classic/Chief Vintage/Chieftain	\$369.95
1907-5010	For 99-01 Chief	369.95
7805-0030	For 02-05 Spirit	369.95



BLACK CLASSIC PAC-A-DERMS™

- Front engine guard covers block wind and water spray
- Includes a pair of Black Classic EZ Mount™ removable pouches
- No tools required to install, securely attach with custom hold snaps to wrap around the highway bars
- Made in the U.S.A.



1624-0333



1624-0331

FITS MODEL	PART #	SUG. RETAIL	FITS MODEL	PART #	SUG. RETAIL
For 14-18 Roadmaster/Springfield/Chief/Chieftain w/ mustache highway bars (all)	1624-0333	\$119.95	OEM round bars (#2879581-156) on 14-18 Roadmaster, 17-18 Springfield, 14-18 Chief	1624-0331	\$125.95

All part numbers in **BLUE** are new for 2019.

- WINDSHIELDS & FAIRINGS
- AUDIO, COMMUNICATION & MOUNTS
- SADDLEBAGS & LUGGAGE
- SEATS & SISSY BARS
- EXHAUST
- FUEL/AIR SYSTEMS
- ENGINE
- TRANSMISSION & DRIVELINE
- GASKETS & SEALS
- ELECTRICAL
- LIGHTING
- HANDLEBARS, CONTROLS & MIRRORS
- CABLES
- BRAKES
- TANKS & OIL FILTERS
- DASHES & GAUGES
- FRAMES & SUSPENSION
- FENDERS & LICENSE PLATE FRAMES
- FOOTRESTS & FLOORBOARDS
- WHEELS & AXLES
- HARDWARE, COVERS & GENERAL

WINDSHIELDS & FAIRINGS

AUDIO, COMMUNICATION & MOUNTS

SADDLEBAGS & LUGGAGE

SEATS & SISSY BARS

EXHAUST

FUEL/AIR SYSTEMS

ENGINE

TRANSMISSION & DRIVELINE

GASKETS & SEALS

ELECTRICAL

LIGHTING

HANDLEBARS, CONTROLS & MIRRORS

CABLES

BRAKES

TANKS & OIL FILTERS

DASHES & GAUGES

FRAMES & SUSPENSION

FENDERS & LICENSE PLATE FRAMES

FOOTRESTS & FLOORBOARDS

WHEELS & AXLES

HARDWARE, COVERS & GENERAL



0411-0162

0411-0163



CARL BROUHARD DESIGNS LLC

BOMBER SERIES FORK SLIDER COVERS

- Brass rivets incorporated into the design for an industrial look
- 6061 billet aluminum
- Made in the U.S.A.

PART #	DESCRIPTION	SUG. RETAIL
FOR 15-19 SCOUT MODELS		
0411-0162	Black anodized	\$338.95
0411-0163	Chrome	338.95



KURYAKYN

LEGACY LOWER LEG ACCENTS

- Durable, lightweight, injection-molded ABS construction with premium chrome plating
- Installs in minutes using high-strength, automotive-grade 3M® VHB™ adhesive
- Sold in pairs

PART #	DESCRIPTION	SUG. RETAIL
0403-0151	For 15-19 Scout models	\$69.99



AXEO FRONT END SUSPENSION SYSTEM

- Includes two mono-tube, dual-chambered damper cartridges
- Nitrogen chambers with internal floating pistons
- Performance spring rate
- Machined 303 Stainless threaded preload adjuster
- Increased preload range allows fine-tuning for various riding styles and weights
- Ride quality is smooth and controlled
- Improves stability, cornering and traction
- Eliminates front-end dive during aggressive braking and maneuvering



- Firm feel for high-speed sweeping turns
- Eliminates bottoming out on large bumps or potholes
- Reduces dragging floorboards and pegs
- Designed for optimum performance with Legend rear suspensions
- Includes Maxima Racing Oil in cartridge and quart bottle
- Made in the U.S.A.

PART #	DESCRIPTION	SUG. RETAIL
0414-0550	For 18-19 Scout and Scout Bobber	\$799.95



AXEO FRONT END SUSPENSION

- Includes two mono-tube, dual-chambered fork damper cartridges
- Cartridges have nitrogen chambers with internal floating pistons
- Performance spring rate
- Machined 303 Stainless threaded preload adjuster
- Increased preload range allows fine tuning for various riding styles and weights
- Ride quality is smooth and controlled
- Improves stability, cornering and traction
- Eliminates front-end dive during aggressive braking and maneuvering



- Firm feel for high-speed sweeping turns
- Eliminates bottoming out on large bumps or potholes
- Reduces dragging floorboards and pegs
- Designed for optimum performance with Legend rear suspensions
- Includes Maxima Racing Oil in cartridge and quart bottle
- Made in the U.S.A.

PART #	DESCRIPTION	SUG. RETAIL
0414-0545	For 15-17 Scout, 17-19 Scout Sixty	\$799.95

All part numbers in **BLUE** are new for 2019.



FRONT FORK SPRINGS

- Progressive springs offer a soft initial spring rate for a plush ride
- Progressively wound design provides increased resistance to bottoming as spring compresses
- Improve handling while retaining OEM geometry
- Sold in pairs
- Made in the U.S.A.

PART #	DESCRIPTION	SUG. RETAIL
0405-0528	For 15-16 Scout models	\$97.00



FORK LOWERING KITS

- Give Cruiser bike front ends that custom lowered look by lowering the forks
- Your choice of 1" or 2" lowering height is available at time of installation
- To maintain proper balanced geometry, it is recommended lowering the rear of the bike the same amount as the front (Progressive Suspension Series shocks available for lowering the rear); see page 108
- Installing a lowering kit will decrease initial ground clearance; motorcycle will be lower to the ground, and care should be taken to avoid bottoming, especially over bumps or in turns

PART #	DESCRIPTION	SUG. RETAIL
0416-0095	For 15-16 Scout models	\$124.95



LEGEND REVO-A COIL SUSPENSION

- Provides improved plush ride quality, control, and resistance to bottoming out
 - Extended coil length has larger "sweet spot" without increasing overall shock length
 - Unique spring rate offers the ability to soften preload, reducing ride height and maintaining a smooth ride
 - Allows minimal preload adjustments when changing between riders' weights or loads
 - Adjusts by hand, no tools needed
 - Easy installation
 - Suspension alignment is provided by spherical bearings on both top and bottom
 - External knob has six adjustments allow fine-tuning of rebound
 - Provides optimum rebound performance for any given rider weight, personal ride quality preference, or personal riding style
 - Light to heavy riders can fine-tune ride preference
 - Black finish
 - Made in the U.S.A.
- NOTE: For solo rider only, with total weight of 250 lb. or less.

PART #	DESCRIPTION	SUG. RETAIL
1310-1739	For 15-19 Scout/Scout Sixty, 18-19 Scout Bobber	\$924.95

All part numbers in **BLUE** are new for 2019.

WINDSHIELDS & FAIRINGS

AUDIO, COMMUNICATION & MOUNTS

SADDLEBAGS & LUGGAGE

SEATS & SISSY BARS

EXHAUST

FUEL/AIR SYSTEMS

ENGINE

TRANSMISSION & DRIVELINE

GASKETS & SEALS

ELECTRICAL

LIGHTING

HANDLEBARS, CONTROLS & MIRRORS

CABLES

BRAKES

TANKS & OIL FILTERS

DASHES & GAUGES

FRAMES & SUSPENSION

FENDERS & LICENSE PLATE FRAMES

FOOTRESTS & FLOORBOARDS

WHEELS & AXLES

HARDWARE, COVERS & GENERAL

WINDSHIELDS & FAIRINGS

AUDIO, COMMUNICATION & MOUNTS

SADDLEBAGS & LUGGAGE

SEATS & SISSY BARS

EXHAUST

FUEL/AIR SYSTEMS

ENGINE

TRANSMISSION & DRIVELINE

GASKETS & SEALS

ELECTRICAL

LIGHTING

HANDLEBARS, CONTROLS & MIRRORS

CABLES

BRAKES

TANKS & OIL FILTERS

DASHES & GAUGES

FRAMES & SUSPENSION

FENDERS & LICENSE PLATE FRAMES

FOOTRESTS & FLOORBOARDS

WHEELS & AXLES

HARDWARE, COVERS & GENERAL

970 SERIES PIGGYBACK SHOCKS



- Progressive Suspension does it once again!
- Designed for performance-oriented twin shock bikes
- Feature piggyback reservoirs, high-pressure gas charge and deflective disc-valving, all packaged in a mono-tube style body
- Include progressive rate springs
- The threaded preload adjustment and external compression adjustment knob allow for fine-tuning to provide optimum performance for rider weight or riding style
- 12" L



PART #	DESCRIPTION	SUG. RETAIL
1310-1320	For 15-16 Scout models	\$1,199.00



444 SERIES

- Features the all new Frequency Sensing Technology (FST) which allows the shocks to sense the frequency of a bump and automatically adjust damping for superior ride quality
- Deflective disc valving
- Adjust spring pre-load by hand, no special tool needed
- Includes a progressive rate spring and is high-pressure gas charged for consistent performance
- Standard or heavy duty spring rate with a black or chrome finish
- Sold in pairs
- Made in the U.S.A.

NOTE: A shock which is slightly longer than stock may alter the head angle slightly and provide somewhat quicker steering.

NOTE: A shock which is slightly shorter than stock may slightly alter the head angle and provide somewhat slower steering.

NOTE: Heavy Duty Applications are recommended for bikes that are operated at or near the manufacturer's maximum load rating over 50% of the time.

1310-1576



1310-1581

NOTE: Before purchasing or attempting to install shocks that are different than the OEM length, confirm that your wheel travel can be altered without causing clearance issues such as swingarm/axle to exhaust contact as well as chain/belt guard or tire contact.

FOR 15-19 SCOUT, SCOUT SIXTY, SCOUT BOBBER				
DESCRIPTION	11"	11.5"	12"	SUG. RETAIL
STANDARD				
Chrome	1310-1582	1310-1584	1310-1586	\$679.95
Black	1310-1576	1310-1578	1310-1580	679.95
HEAVY-DUTY				
Chrome	1310-1583	1310-1585	1310-1587	679.95
Black	1310-1577	1310-1579	1310-1581	679.95



413 SERIES 11" AND 11.5" SHOCKS

- Progressive puts its expertise to work for high-performance applications
- Longer than stock for increased travel and ground clearance
- Freon-cell gas system for fade resistance and superior damping characteristics
- Proper rates provide stability
- Sold in pairs

• Made in the U.S.A.

NOTE: Before purchasing or attempting to install shocks that are different than the OEM length, confirm that your wheel travel can be altered without causing clearance issues, such as swingarm/axle to exhaust contact as well as chain/belt guard or tire contact.



Chrome

Black

FOR 15-19 SCOUT, SCOUT SIXTY, SCOUT BOBBER							
DESCRIPTION	11"	11.5"	SUG. RETAIL	DESCRIPTION	11"	11.5"	SUG. RETAIL
STANDARD				HEAVY DUTY			
Black	1310-1594	1310-1598	\$299.95	Black	1310-1596	1310-1600	\$299.95
Chrome	1310-1595	1310-1599	299.95	Chrome	1310-1597	1310-1601	299.95



ADJUSTABLE HEIGHT PERFORMANCE SHOCK

- The proper way to lower your Indian while improving ride quality
- Shock is preset to 310mm length which lowers the bike 38mm (1 1/2") and spring rate is adjusted for a 200 lb. rider
- Both shock height and preload are adjustable
- Height is adjustable from factory height to 1 1/2" lower
- Preload adjustability allows the rider to set the spring preload to their individual weight
- Lowered position: Retains factory suspension geometry and provides improved ride quality even though bike is lowered. Unlike lowering links, which reduce ride quality by messing up the engineering of the rear suspension



1304-0898



1304-0899



REAR SUSPENSION LOWERING KITS

- Replace the stock suspension arms
- Give your bike the low look without losing suspension travel
- Kits include everything needed for a complete installation
- Made in the U.S.A.

DESCRIPTION	LOWERED DISTANCE	PART #	SUG. RETAIL
FOR 14-19 CHIEFTAIN			
Chrome	1 1/2"	1304-0898	\$84.95
Black	1 1/2"	1304-0899	54.95

All part numbers in **BLUE** are new for 2019.



1402-0382



1402-0383

FRONT FENDERS

- Fender comes pre-drilled and E-coated and is stamped, not spun, for the ultimate smooth, long-lasting fender
- Steel fender is thick enough to add rigidity to the front end by acting as a fork brace
- Can still be cut or shaped enough for an even more Kustom appearance; you decide

- Direct bolt-on replacement front fender that uses stock mounting hardware
- Give the Klassic full-fender look that still shows off the wheel
- Made in the U.S.A.

FOR 14-18 CLASSIC VINTAGE, 15-18 DARK HORSE, 16-18 SPRINGFIELD, 14-18 CHIEFTAIN, 15-18 ROADMASTER

DESCRIPTION	PART #	SUG. RETAIL	DESCRIPTION	PART #	SUG. RETAIL
16"/17"/18"/19"	1402-0382	\$359.95	21"	1402-0383	\$359.95



TIRE HUGGER SERIES FRONT FENDERS

- Hug your 16-19" or 21" wheels
- Pre-drilled and E-coated for factory precision
- Add style and show off those rims
- Stamped from 14-gauge steel for torsional rigidity and strength
- Fender comes with mounting hardware and chrome spacers



1402-0389



1402-0391

FOR 14-18 CLASSIC AND VINTAGE, 15-18 DARK HORSE, 16-18 SPRINGFIELD, 14-18 CHIEFTAIN, 15-18 ROADMASTER

PART #	DESCRIPTION	SUG. RETAIL	PART #	DESCRIPTION	SUG. RETAIL
16"/17"/18"/19" FRONT WHEEL			21" FRONT WHEEL		
1402-0389	Wrapper	\$359.95	1402-0388	Wrapper	\$359.95
1402-0391	Slicer	359.95	1402-0390	Slicer	359.95



1402-0364



1402-0363



FRONT FENDERS

- All fenders come predrilled and E-coated and are stamped, not spun, for the ultimate smooth, long-lasting fender
- Steel fenders are thick enough to add rigidity to the front end by acting like a fork brace, but can still be cut or shaped enough for an even more Kustom appearance
- 16", 17", 18" and 19" fenders for Indian Scout models

- Benchmark is a more slammed, lower profile look
- Outrider is a tire-hugging style
- All are direct bolt-on replacement front fenders that use stock mounting hardware
- Made in the U.S.A.

FOR 15-19 SCOUT MODELS

PART #	DESCRIPTION	SUG. RETAIL	PART #	DESCRIPTION	SUG. RETAIL
16"/17"/18"/19" FRONT WHEEL			16"/17"/18"/19" FRONT WHEEL (CONT)		
1402-0364	Benchmark	\$279.95	1402-0363	Outrider	\$279.95

All part numbers in **BLUE** are new for 2019.

WINDSHIELDS & FAIRINGS

AUDIO, COMMUNICATION & MOUNTS

SADDLEBAGS & LUGGAGE

SEATS & SISSY BARS

EXHAUST

FUEL/AIR SYSTEMS

ENGINE

TRANSMISSION & DRIVELINE

GASKETS & SEALS

ELECTRICAL

LIGHTING

HANDLEBARS, CONTROLS & MIRRORS

CABLES

BRAKES

TANKS & OIL FILTERS

DASHES & GAUGES

FRAMES & SUSPENSION

FENDERS & LICENSE PLATE FRAMES

FOOTRESTS & FLOORBOARDS

WHEELS & AXLES

HARDWARE, COVERS & GENERAL

WINDSHIELDS & FAIRINGS

AUDIO, COMMUNICATION & MOUNTS

SADDLEBAGS & LUGGAGE

SEATS & SISSY BARS

EXHAUST

FUEL/AIR SYSTEMS

ENGINE

TRANSMISSION & DRIVELINE

GASKETS & SEALS

ELECTRICAL

LIGHTING

HANDLEBARS, CONTROLS & MIRRORS

CABLES

BRAKES

TANKS & OIL FILTERS

DASHES & GAUGES

FRAMES & SUSPENSION

FENDERS & LICENSE PLATE FRAMES

FOOTRESTS & FLOORBOARDS

WHEELS & AXLES

HARDWARE, COVERS & GENERAL



OUTRIDER REAR FENDER

- Direct bolt-on replacement fender offers an instant bobber style, using stock mounting locations and hardware
- Complete with bolt-in taillight/license plate mount (included)
- Stamped from 14-gauge steel using precision, deep-draw stamping technology that ensures a consistently smooth and flawless finish that minimizes bodywork
- 13 step E-coated process prevents rust and corrosion, from manufacture to paint booth and beyond, as it continues to resist rust after paint
- Precision, laser cut technology ensures accurate fitment
- Works with stock 150/80-16 rear and up to a 180 rear tire
- Made in the U.S.A.

PART #	DESCRIPTION	SUG. RETAIL
1402-0365	For 15-19 Scout models	\$479.95



NUMBER PLATE KIT

- Personalize, identify, and get that hot competition look for an Indian Scout with aluminum number plates
- Easy to install because they are pre-drilled to use the stock rear fender mounting locations
- Precision cut from heavy gauge aluminum
- The hardware is included
- Sold in pairs



PART #	DESCRIPTION	SUG. RETAIL
1405-0218	For 15-19 Scout/Scout Sixty	\$99.95

KURYAKYN

SIGNATURE SERIES SPRINT FRONT FENDER

- Shorter, scalloped and streamlined bolt-on front fender
- Hugs the front tire for a clean, racy appearance
- Durable fiberglass construction
- Requires minimal prep before painting
- Includes mounting brackets



PART #	DESCRIPTION	SUG. RETAIL
1401-0618	For 15-19 Scout models	\$149.99

LEGACY FRONT FENDER SKIRT

- Stepped edges, beveled contours and grooved badge icon capture and reflect light for a unique look
- Durable, lightweight injection-molded ABS construction with premium chrome plating
- Hassle-free installation with no drilling or permanent modifications required



PART #	DESCRIPTION	SUG. RETAIL
1405-0276	For 15-19 Scout (except Bobber)	\$69.99

LEGACY FRONT FENDER TOP ACCENT

- Highlights the contours of the front fender's recessed area
- Durable, lightweight injection-molded ABS with premium chrome plating
- Installs in minutes using high-strength automotive-grade 3M® VHB™ adhesive tape



PART #	DESCRIPTION	SUG. RETAIL
1405-0275	For 15-19 Scout models (except Bobber)	\$49.99

REAR FENDER TIP

- Stepped edges, beveled contours and grooved center medallion capture and reflect light for a unique look
- Extends the rear fender's trailing edge and integrates cleanly with the taillight for a classic appearance
- Durable, lightweight injection-molded ABS construction with premium chrome plating
- Hassle-free installation with no drilling or permanent modifications required



PART #	DESCRIPTION	SUG. RETAIL
1405-0278	For 15-19 Scout models (except Bobber)	\$74.99



LEGACY REAR FENDER SIDE ACCENTS

- Flow with the shape of the stock fender and feature beveled edges and grooved speedlines that reflect light for a clean, custom look
- Made from durable chrome-plated die-cast zinc
- Bolt-on installation with included hardware that replaces the unfinished stock bolts
- Sold in pairs

PART #	DESCRIPTION	SUG. RETAIL
1405-0277	For 15-19 Scout models (except Bobber)	\$99.99

All part numbers in **BLUE** are new for 2019.



CARL BROUHARD DESIGNS LLC

BOMBER SERIES SIDE-MOUNT LICENSE PLATES

- Relocate your license plate to the left side
- Constructed of 6061-T6 aluminum
- Available with a choice of black-anodized or chrome finishes
- Extended style extends the shift arm 2" further forward than stock
- Brass rivets incorporated in the design for an industrial look
- Mount includes LED light to illuminate the license plate
- Made in the U.S.A.



2030-1115



2030-1116

PART #	DESCRIPTION	SUG. RETAIL
FOR 15-19 SCOUT MODELS		
2030-1115	Black anodized	\$371.95

PART #	DESCRIPTION	SUG. RETAIL
FOR 15-19 SCOUT MODELS (CONT)		
2030-1116	Chrome	\$371.95



precision crafted billet products

SIDE-MOUNT LICENSE PLATES

- Billet 6061-T6 construction
- Includes a bright LED license plate light
- Mounts horizontally or vertically
- Mounts on the left side of the swingarm in place of the oval axle adjuster plate
- Window size: 6" x 3 1/4"
- Outside dimensions: 7 1/2" x 4 1/2"
- Mounting holes: 5 3/4" x 2 3/4"
- Available in chrome and black finishes



2030-0905



2030-0906

PART #	DESCRIPTION	SUG. RETAIL
FOR 15-19 SCOUT MODELS		
2030-0905	Black	\$179.95

PART #	DESCRIPTION	SUG. RETAIL
FOR 15-19 SCOUT MODELS (CONT)		
2030-0906	Chrome	\$179.95



LED CURVED LICENSE PLATE FRAME WITH MOUNT

- Die-cast aluminum frame is a direct replacement that hugs the rear fender and complements surrounding OEM chrome accents
- Built-in LEDs illuminate the license plate

PART #	DESCRIPTION	SUG. RETAIL
2030-0974	For 14-19 Indian models (except Scout, 19 Chieftain, Chieftain Dark Horse and Chieftain Limited)	\$119.99



2030-1195

2030-1196



SIDE-MOUNT LICENSE PLATE MOUNT BRACKETS

- Mount brackets are for use with a Kuryakyn side-mount license plate holder
- Bracket places the license plate in a sleek, side-mount position
- Must order one license plate holder (sold separately), see page ??? of the 2019 Fatbook for plate holders

PART #	DESCRIPTION	SUG. RETAIL
FOR 15-19 SCOUT MODELS (EXCEPT BOBBERS)		
2030-1195	Chrome	\$39.99
2030-1196	Gloss black	39.99



LAYDOWN CURVED LICENSE PLATE MOUNT WITH LED LICENSE PLATE FRAME

- Curved plate frame features LED backlighting for full license plate illumination
- 8" mounting angle flows with lines on rear fender
- Fits 4" x 7" license plates

PART #	DESCRIPTION	SUG. RETAIL
2030-0988	Satin black	\$122.99



All part numbers in **BLUE** are new for 2019.

- WINDSHIELDS & FAIRINGS
- AUDIO, COMMUNICATION & MOUNTS
- SADDLEBAGS & LUGGAGE
- SEATS & SISSY BARS
- EXHAUST
- FUEL/AIR SYSTEMS
- ENGINE
- TRANSMISSION & DRIVELINE
- GASKETS & SEALS
- ELECTRICAL
- LIGHTING
- HANDLEBARS, CONTROLS & MIRRORS
- CABLES
- BRAKES
- TANKS & OIL FILTERS
- DASHES & GAUGES
- FRAMES & SUSPENSION
- FENDERS & LICENSE PLATE FRAMES
- FOOTRESTS & FLOORBOARDS
- WHEELS & AXLES
- HARDWARE, COVERS & GENERAL

WINDSHIELDS & FAIRINGS

AUDIO, COMMUNICATION & MOUNTS

SADDLEBAGS & LUGGAGE

SEATS & SISSY BARS

EXHAUST

FUEL/AIR SYSTEMS

ENGINE

TRANSMISSION & DRIVELINE

GASKETS & SEALS

ELECTRICAL

LIGHTING

HANDLEBARS, CONTROLS & MIRRORS

CABLES

BRAKES

TANKS & OIL FILTERS

DASHES & GAUGES

FRAMES & SUSPENSION

FENDERS & LICENSE PLATE FRAMES

FOOTRESTS & FLOORBOARDS

WHEELS & AXLES

HARDWARE, COVERS & GENERAL

0621-0809

1621-0811

1621-0642

1621-0707



CARL BROUHARD DESIGNS LLC

ELITE VELOCITY DRIVER FLOORBOARDS

- Oversized floorboard with added outer edge with three slots to match the Elite shift arms and brake
- Driver's floorboards measure 18" x 5"
- Mounting hardware included
- Made in the U.S.A.

PART #	COLOR	SUG. RETAIL
FOR 12-18 CHIEFTAIN, ROADMASTER, CHIEF CLASSIC, OR CHIEF VINTAGE		
1621-0809	Black	\$506.95
1621-0811	Chrome	506.95



CARL BROUHARD DESIGNS LLC

ELITE DRIVER AND PASSENGER FLOORBOARDS

- Driver's boards lower the foot 1" from the stock position
- Oversize floorboards measure 18" L x 5" W; that is 2" longer and .5" wider than the stock boards for a more comfortable riding position
- Passenger boards measure 11" L x 3.5" W
- All boards are made of 6061 billet aluminum and available in chrome or black anodized with off-set cut
- Made in the U.S.A.

PART #	DESCRIPTION	SUG. RETAIL
FOR 14-18 CHIEFTAIN, ROADMASTER, CHIEF CLASSIC, CHIEF VINTAGE		
DRIVER FLOORBOARDS		
1621-0642	Black anodized w/ off-set cut	\$507.95
1621-0643	Chrome	507.95
PASSENGER FLOORBOARDS		
1621-0706	Black anodized w/ off-set cut	432.95
1621-0707	Chrome	432.95



precision crafted billet products

FLOORBOARDS

- Machined from 6061-T6 billet aluminum
- Fit the front of 2014-up Chief
- Extended Drilled Instigator front floor boards are extended 2 1/2" in the front and rear and are 3/4" wider than stock floorboards
- Extended Drilled Teardrop front floor boards are extended 2 1/8" in front
- Extended Drilled Vintage front floor boards are extended 2 1/2" in front and 3/4" wider and 1" longer in the rear
- Drilled Original and Drilled Vintage front floor boards are 1 3/4" shorter in front and 1/2" wider
- Feature multi-directional slip-resistant black pyramid-top rubber inserts



- Available in black or Night Series (black anodized and then machined again, yielding a contrast of black anodized and raw aluminum finish)
- Sold in pairs
- Made in the U.S.A.

FOR 14-18 CHIEFTAIN, ROADMASTER, CHIEF CLASSIC, CHIEF VINTAGE

PART #	DESCRIPTION	SUG. RETAIL	PART #	DESCRIPTION	SUG. RETAIL	PART #	DESCRIPTION	SUG. RETAIL
EXTENDED DRILLED INSTIGATOR			DRILLED ORIGINAL (CONT)			EXTENDED DRILLED VINTAGE		
1621-0880	Knurled Heel, Black	\$444.95	1621-0884	Rubber Heel, Black	\$444.95	1621-0888	Rubber Heel, Black	\$444.95
1621-0881	Knurled Heel, Night Series	444.95	1621-0885	Rubber Heel, Night Series	444.95	1621-0889	Rubber Heel, Night Series	444.95
1621-0886	Rubber Heel, Black	444.95	EXTENDED DRILLED TEARDROP			DRILLED VINTAGE		
1621-0887	Rubber Heel, Night Series	444.95	1621-0878	Knurled Heel, Black	444.95	1621-0874	Knurled Heel, Black	444.95
DRILLED ORIGINAL			1621-0879	Knurled Heel, Night Series	444.95	1621-0875	Knurled Heel, Night Series	444.95
1621-0876	Knurled Heel, Black	444.95	1621-0882	Rubber Heel, Black	444.95			
1621-0877	Knurled Heel, Night Series	444.95	1621-0883	Rubber Heel, Night Series	444.95			



precision crafted billet products

"INSTIGATOR" EXTENDED DRIVER FLOORBOARDS

- Give a custom look
- Floorboards machined from 6061-T6 billet aluminum
- Boards extended 1" further forward and rear than stock boards; are 1 3/8" wider than stock
- Feature multi-directional non-slip black Pyramid Top rubber inserts
- Chrome or black-anodized/raw aluminum finish available
- Install using stock mounts and hardware
- Made in the U.S.A.



FOR 14-18 CHIEFTAIN, ROADMASTER, CHIEF CLASSIC, CHIEF VINTAGE

PART #	DESCRIPTION	SUG. RETAIL	PART #	DESCRIPTION	SUG. RETAIL
1621-0632	Chrome	\$444.95	1621-0633	Black-anodized/aluminum	\$444.95

All part numbers in **BLUE** are new for 2019.



1621-0904

1621-0905

KURYAKYN

PHANTOM DRIVER FLOORBOARDS

- Constructed from A380 aluminum
- Durable EPDM rubber will not harden, crack or wear over time
- Sharp lines and a sculpted angular design keeps function intact by providing plenty of foot room
- Direct replacements for all Indian Chief, Chieftain, Roadmaster and Springfield driver floorboards
- Available in chrome or gloss black
- Sold in pairs

PART #	DESCRIPTION	SUG. RETAIL
FOR 14-19 INDIAN MODELS (EXCEPT SCOUT)		
1621-0904	Chrome	\$299.99
1621-0905	Gloss black	299.99



1621-0805

1621-0806

MINI SERRATED DRIVER FLOORBOARDS

- CNC-machined from 6061 billet aluminum
- Strong yet lightweight two-piece construction
- Serrated for exceptional grip
- 360° footpeg adjustment
- Pitch adjustment screw for a level riding position
- Dimensions: 5" long, 3" wide, .0675" thick
- Easy installation
- Made in the U.S.A.

DESCRIPTION	PART #	SUG. RETAIL
FOR 15-19 SCOUT		
Raw aluminum	1621-0805	\$199.95
Black anodized	1621-0806	199.95



1621-0803

1621-0804

KURYAKYN

RIOT MINI FLOORBOARDS

- Rugged, MX-style mini floorboards made from durable cast aluminum
- Serrated, toothed top surface for no-slip secure footing
- Tapered bottom design provides excellent cornering clearance
- Measure 5 1/2" L x 3 3/4" W x 1 1/2" H
- Sold in pairs

NOTE: Require Kuryakyn bike-specific splined adapters for installation (sold separately; see page 121).

PART #	DESCRIPTION	SUG. RETAIL
1621-0803	Blasted satin black	\$79.99
1621-0804	Bead-blasted silver	79.99



1621-0897

1621-0898

KURYAKYN

PHANTOM MINI BOARDS

- Feature a pass-through design with sharp, sculpted lines, along with a much larger area to rest your foot compared to standard footpegs
- Constructed from quality A380 aluminum
- Durable EPDM rubber inserts offer traction and long-haul vibration dampening comfort
- Available in chrome or gloss black finish
- Require Kuryakyn splined bike-specific adapters for installation (sold separately; see page 121)

PART #	DESCRIPTION	SUG. RETAIL
1621-0897	Chrome	\$199.99
1621-0898	Gloss black	199.99

KURYAKYN

GLOSS BLACK ISO@-WINGS MINI FLOORBOARDS

- An attractive alternative to footpegs
- Size provides more support than OEM footpegs, yet the stylish design remains unobtrusive
- Sold in pairs

NOTE: Require Kuryakyn bike-specific splined adapters for installation (sold separately; see page 121).

PART #	DESCRIPTION	SUG. RETAIL
1620-1085	Iso@-Wings mini floorboards	\$101.99



KURYAKYN

SPEAR MINI BOARDS

- Combine the comfort and convenience of a floorboard in a small, convenient package
- Sturdy die-cast aluminum construction
- Proprietary EPDM premium rubber compound inserts reduce vibration
- Satin black finish
- Sold in pairs

NOTE: Require Kuryakyn bike-specific splined adapters for installation (sold separately; see page 121).

PART #	DESCRIPTION	SUG. RETAIL
1621-0764	Spear mini floorboards	\$101.99



All part numbers in **BLUE** are new for 2019.

- WINDSHIELDS & FAIRINGS
- AUDIO, COMMUNICATION & MOUNTS
- SADDLEBAGS & LUGGAGE
- SEATS & SISSY BARS
- EXHAUST
- FUEL/AIR SYSTEMS
- ENGINE
- TRANSMISSION & DRIVELINE
- GASKETS & SEALS
- ELECTRICAL
- LIGHTING
- HANDLEBARS, CONTROLS & MIRRORS
- CABLES
- BRAKES
- TANKS & OIL FILTERS
- DASHES & GAUGES
- FRAMES & SUSPENSION
- FENDERS & LICENSE PLATE FRAMES
- FOOTRESTS & FLOORBOARDS
- WHEELS & AXLES
- HARDWARE, COVERS & GENERAL

WINDSHIELDS & FAIRINGS

AUDIO, COMMUNICATION & MOUNTS

SADDLEBAGS & LUGGAGE

SEATS & SISSY BARS

EXHAUST

FUEL/AIR SYSTEMS

ENGINE

TRANSMISSION & DRIVELINE

GASKETS & SEALS

ELECTRICAL

LIGHTING

HANDLEBARS, CONTROLS & MIRRORS

CABLES

BRAKES

TANKS & OIL FILTERS

DASHES & GAUGES

FRAMES & SUSPENSION

FENDERS & LICENSE PLATE FRAMES

FOOTRESTS & FLOORBOARDS

WHEELS & AXLES

HARDWARE, COVERS & GENERAL

KURYAKYN

ISO™ DRIVER AND PASSENGER FLOORBOARDS WITH SPLINED ADAPTER MOUNTS

- Kits include our chromed ISO®-Boards with full-length rubber inserts and a cast bracket to connect with Kuryakyn's splined adapter mounts (sold separately)
- Floorboards measure approximately 9 1/8" long
- Passenger peg-only bracket positions the floorboards 1" higher than the stock footpeg height
- Sold in pairs

NOTE: Require Kuryakyn bike-specific splined adapters for installation (sold separately; see page 121).

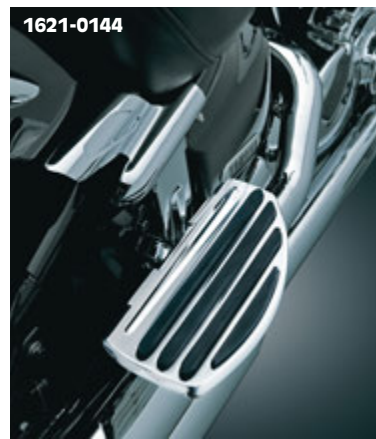

PART #	DESCRIPTION	SUG. RETAIL	PART #	DESCRIPTION	SUG. RETAIL
1621-0088	Driver floorboards	\$203.99	1621-0144	Passenger floorboards	\$224.99

KURYAKYN

SPEAR DRIVER AND PASSENGER FLOORBOARD INSERTS

- Have a slightly larger profile than the stock inserts
- Use 1/4" spacers for improved foot positioning and better comfort
- Proprietary EPDM premium rubber compound for less vibration through the boards and better long-ride comfort
- Driver floorboards measure 15.5" L x 5.75" W (at widest point)
- Sold in pairs



1621-0742



1621-0767

PART #	DESCRIPTION	SUG. RETAIL	PART #	DESCRIPTION	SUG. RETAIL
DRIVER FLOORBOARD INSERTS FOR ALL 14-19 INDIAN MODELS (EXCEPT SCOUT MODELS)			PASSENGER FLOORBOARD INSERTS FOR 15-19 ROADMASTER, SPRINGFIELD (EXCEPT ROADMASTER ELITE)		
1621-0742	Chrome	\$173.99	1621-0765	Chrome	\$99.99
1621-0763	Satin black	173.99	1621-0767	Satin black	99.99



ADJUSTABLE PASSENGER FLOORBOARDS

- Classic steel passenger floorboards measure 8" x 5" and replace stock fixed passenger pegs and mounts
- Mounts machined from billet aluminum and feature triple-chrome-plating with soft anti-vibration neoprene rubber pads
- Install easily without modification to the bike
- Adjust in seconds to 12 positions through a 9" range of motion - no tools required
- Provide great passenger comfort
- Sold in pairs
- Made in the U.S.A.



PART #	DESCRIPTION	SUG. RETAIL
1621-0744	For 14-19 Chief/Chieftain, 16-19 Dark Horse	\$429.95



DRIVER FLOORBOARD SPREADERS

- Manufactured from billet aluminum with black finish
- Floorboard spreaders 1 1/4" black
- Easy installation
- Kit includes necessary hardware for easy installation
- Sold in pairs



PART #	DESCRIPTION	SUG. RETAIL
1621-0906	For 14-19 Chief/Chieftain/Roadmaster/Springfield models	\$85.95

All part numbers in **BLUE** are new for 2019.



CARL BROUHARD DESIGNS LLC

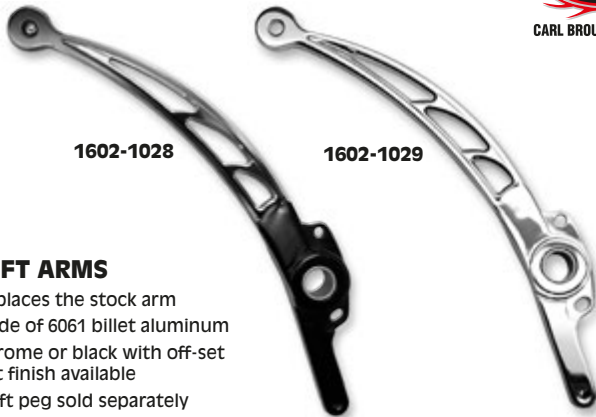

1602-1028

1602-1029

SHIFT ARMS

- Replaces the stock arm
- Made of 6061 billet aluminum
- Chrome or black with off-set cut finish available
- Shift peg sold separately
- Made in the U.S.A.

PART #	DESCRIPTION	SUG. RETAIL
FOR 14-19 CHIEF, CHIEF CLASSIC, CHIEF VINTAGE, ROADMASTER		
1602-1028	Black w/ off-set cut	\$175.95
1602-1029	Chrome	175.95



1602-1120

1602-1121

SHIFT ARMS

- High-quality shift arms that add a custom touch
- Constructed of 6061-T6 aluminum
- Available with a choice of black-anodized or chrome finishes
- Extended style extends the shift arm 2" further forward than stock
- Brass rivets incorporated in the design for an industrial look
- Made in the U.S.A.

FOR 15-19 SCOUT

PART #	DESCRIPTION	SUG. RETAIL
STANDARD		
1602-1119	Black anodized	\$220.95
1602-1120	Chrome	220.95
EXTENDED +2"		
1602-1121	Black anodized	232.95
1602-1122	Chrome	232.95



1610-0543

1610-0546

BRAKE ARMS

- Replaces the stock brake arm
- Constructed of 6061-T6 aluminum
- Available with a choice of black-anodized or chrome finishes
- Extended style extends the brake arm 2" further forward than stock
- Brass rivets incorporated in the design for an industrial look
- Made in the U.S.A.

FOR 15-19 SCOUT		
PART #	DESCRIPTION	SUG. RETAIL
STANDARD		
1610-0543	Black anodized	\$182.95
1610-0544	Chrome	182.95
EXTENDED +2"		
1610-0545	Black anodized	185.90
1610-0546	Chrome	185.90



1610-0460

1610-0461

ELITE BRAKE ARMS

- Creates a more comfortable foot position
- Coordinate with CBD Elite floorboards and brake pedals for Indian models
- Made of 6061 billet aluminum and available in chrome or black anodize with off-set cut
- Easy to install; mounting hardware included
- Made in the U.S.A.

PART #	DESCRIPTION	SUG. RETAIL
FOR 14-18 CHIEFTAIN, ROADMASTER, CHIEF CLASSIC, CHIEF VINTAGE		
1610-0460	Black anodize w/ off-set cut	\$189.95
1610-0461	Chrome	189.95



1610-0270

1610-0271

ELITE BRAKE PEDALS

- Made of 6061 billet aluminum and available in chrome or black anodize with off-set cut
- Sleek design measures 5.75" L
- Coordinate with CBD Elite floorboards and brake arms for Indian models
- Mounts directly to CBD brake arm PART #s 1610-0460 or 1610-0461; will not work with stock brake arm
- Made in the U.S.A.

PART #	DESCRIPTION	SUG. RETAIL
FOR 14-18 CHIEFTAIN/ROADMASTER/CHIEF CLASSIC/CHIEF VINTAGE		
1610-0270	Black anodize w/ off-set cut	\$101.95
1610-0271	Chrome	101.95



1610-0469

1610-0470

BRAKE PEDALS

- Made of 6061 billet aluminum and available in chrome or black anodize with off-set cut
- Coordinate with CBD Elite floorboards and brake arms for Indian models
- Easy to install; mounting hardware included
- Mounts directly to CBD brake arm PART #s 1610-0460 or 1610-0461; will not work with stock brake arm
- Made in the U.S.A.

PART #	DESCRIPTION	SUG. RETAIL
FOR 14-18 CHIEFTAIN, ROADMASTER, CHIEF CLASSIC, CHIEF VINTAGE		
1610-0469	Black anodize w/ off-set cut	\$112.95
1610-0470	Chrome	112.95

All part numbers in **BLUE** are new for 2019.

WINDSHIELDS & FAIRINGS

AUDIO, COMMUNICATION & MOUNTS

SADDLEBAGS & LUGGAGE

SEATS & SISSY BARS

EXHAUST

FUEL/AIR SYSTEMS

ENGINE

TRANSMISSION & DRIVELINE

GASKETS & SEALS

ELECTRICAL

LIGHTING

HANDLEBARS, CONTROLS & MIRRORS

CABLES

BRAKES

TANKS & OIL FILTERS

DASHES & GAUGES

FRAMES & SUSPENSION

FENDERS & LICENSE PLATE FRAMES

FOOTRESTS & FLOORBOARDS

WHEELS & AXLES

HARDWARE, COVERS & GENERAL

WINDSHIELDS & FAIRINGS

AUDIO, COMMUNICATION & MOUNTS

SADDLEBAGS & LUGGAGE

SEATS & SISSY BARS

EXHAUST

FUEL/AIR SYSTEMS

ENGINE

TRANSMISSION & DRIVELINE

GASKETS & SEALS

ELECTRICAL

LIGHTING

HANDLEBARS, CONTROLS & MIRRORS

CABLES

BRAKES

TANKS & OIL FILTERS

DASHES & GAUGES

FRAMES & SUSPENSION

FENDERS & LICENSE PLATE FRAMES

FOOTRESTS & FLOORBOARDS

WHEELS & AXLES

HARDWARE, COVERS & GENERAL

BRAKE PEDAL COVERS

- Covers the stock brake pedal
- Coordinate with CBD Elite Floorboards for Indian models
- Made of 6061 billet aluminum and available in chrome or black-anodized with off-set cut
- Made in the U.S.A.



1610-0453



1610-0454

PART #	DESCRIPTION	SUG. RETAIL
FOR 14-17 CHIEFTAIN, ROADMASTER, CHIEF CLASSIC, CHIEF VINTAGE		
1610-0453	Black-anodized w/ off-set cut	\$101.95

PART #	DESCRIPTION	SUG. RETAIL
FOR 14-17 CHIEFTAIN, ROADMASTER, CHIEF CLASSIC, CHIEF VINTAGE (CONT)		
1610-0454	Chrome	\$101.95

1611-0090



1611-0088



KURYAKYN PHANTOM BRAKE PEDAL PADS

- Modern, aggressive design features sharp angular lines
- Constructed from quality A380 aluminum
- Durable EPDM rubber pad offers traction and will not harden, crack or wear over time

- Direct replacement for stock brake pedal pads on Indian Chief, Chieftain, Roadmaster and Springfield models
- Available in chrome or gloss black

PART #	DESCRIPTION	SUG. RETAIL
FOR 14-19 INDIAN MODELS (EXCEPT 18 CHIEF, 18-19 CHIEFTAIN, 19 CHIEFTAIN DARK HORSE AND 15-19 SCOUT MODELS)		
1611-0090	Chrome	\$69.99
1611-0088	Gloss black	69.99

KURYAKYN SATIN BLACK SPEAR BRAKE PEDAL

- Quality die-cast aluminum construction with a form-fitted proprietary EPDM premium rubber compound
- Quick installation using the stock hardware
- Measures 4.5" W x 3" T

PART #	DESCRIPTION	SUG. RETAIL
1610-0503	For 14-19 Indian models (except 18-19 Chief/Chieftain and 15-19 Scout models)	\$61.99

ELITE HEEL-TOE SHIFTERS

- Replaces the stock single shifter
- Made of 6061 billet aluminum and available in chrome or black anodize with off-set cut
- Coordinate with CBD Elite floorboards and brake arms for Indian models
- Mounting hardware included
- Made in the U.S.A.

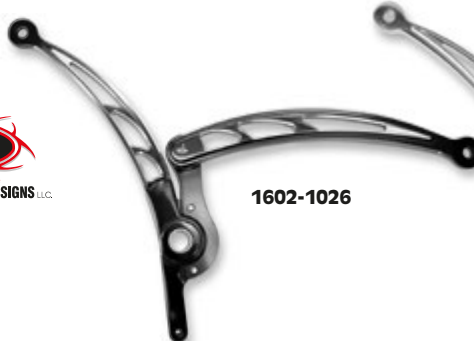

1602-1026



1602-1027

PART #	DESCRIPTION	SUG. RETAIL
FOR 14-19 CHIEFTAIN, ROADMASTER, CHIEF CLASSIC, CHIEF VINTAGE		
1602-1026	Black anodize w/ off-set cut	\$298.95

PART #	DESCRIPTION	SUG. RETAIL
FOR 14-19 CHIEFTAIN, ROADMASTER, CHIEF CLASSIC, CHIEF VINTAGE (CONT)		
1602-1027	Chrome	\$298.95



1602-1129



1602-1130

KURYAKYN HEEL SHIFT LEVERS

- Feature an ergonomic design that extends past the rear of the floorboard for effortless shifting
- Accepts Kuryakyn Spear, Kinetic and ISO shift pegs, or any Indian OEM shift peg (all sold separately)
- Easy bolt-on install to the factory toe shift location with included hardware and spacer
- Does not include shift peg
- Durable aluminum construction available in chrome or gloss black finish

PART #	DESCRIPTION	SUG. RETAIL
FOR 14-19 INDIAN MODELS (EXCEPT SCOUT)		
1602-1129	Chrome	\$69.99

PART #	DESCRIPTION	SUG. RETAIL
FOR 14-19 INDIAN MODELS (EXCEPT SCOUT) (CONT)		
1602-1130	Gloss black	\$69.99

All part numbers in **BLUE** are new for 2019.

WINDSHIELDS & FAIRINGS

AUDIO, COMMUNICATION & MOUNTS

SADDLEBAGS & LUGGAGE

SEATS & SISSY BARS

EXHAUST

FUEL/AIR SYSTEMS

ENGINE

TRANSMISSION & DRIVELINE

GASKETS & SEALS

ELECTRICAL

LIGHTING

HANDLEBARS, CONTROLS & MIRRORS

CABLES

BRAKES

TANKS & OIL FILTERS

DASHES & GAUGES

FRAMES & SUSPENSION

FENDERS & LICENSE PLATE FRAMES

FOOTRESTS & FLOORBOARDS

WHEELS & AXLES

HARDWARE, COVERS & GENERAL



1620-0158



1620-0157



1620-0159



ISO®-PEGS

- Give you a custom look and dampen vibration
- Hollow-core neoprene inserts are long lasting
- Small peg measures 1 1/4" in diameter x 4 5/8" long
- Large peg measures 1 1/2" in diameter x 4 7/8" long
- Dually peg measures 2 1/2" wide x 5" long
- Pegs without adapters require the use of Kuryakyn tapered footpeg adapters; see page 121
- Sold in pairs

PART #	DESCRIPTION	SUG. RETAIL
1620-0158	Large ISO®-Pegs w/o adapters	\$40.99
1620-0157	Small ISO®-Pegs w/o adapters	40.99
1620-0159	Dually ISO®-Pegs w/o adapters	71.99

ISO®-SWEPTWING PEGS

- Simple, stylish design adds a sleek, streamlined look to your bike
- Feature the traditional ISO® design to reduce vibration and provide long-distance comfort
- Pegs without adapters require Kuryakyn tapered footpeg adapters; see page 121
- Sold in pairs

PART #	DESCRIPTION	SUG. RETAIL
1620-0370	ISO® Sweptwing pegs w/o adapters	\$71.99

1620-0924



1620-1082



1620-1084

TRIDENT ISO®-PEGS

- An updated design of the original ISO®-Pegs
- Look great with stock or custom footrests
- Footpegs without adapters require the use of Kuryakyn tapered footpeg adapters; see page 121
- All styles sold in pairs

PART #	DESCRIPTION	SUG. RETAIL
CHROME		
1620-0923	Small Trident pegs (4 5/8" x 1 1/4") w/o adapters	\$40.99
1620-0924	Large Trident pegs (4 7/8" x 1 1/2") w/o adapters	40.99
1620-0925	Dually Trident pegs (4 1/2" x 1 1/4") w/o adapters	71.99
GLOSS BLACK		
1620-1082	Small Trident pegs w/o w/o adapters	40.99
1620-1083	Large Trident pegs w/o w/o adapters	40.99
1620-1084	Dually Trident pegs w/o w/o adapters	71.99

SWINGWING PEGS

- A convenient alternative to forward controls
- Our clever cruise pegs feature a fold-forward design
- Secondary fold-out peg extends 3" forward and locks into place for added legroom and comfort
- Pegs require the use of Kuryakyn splined footpeg adapters; see page 121
- Sold in pairs

PART #	DESCRIPTION	SUG. RETAIL
1620-0423	SwingWing pegs w/o adapters	\$163.99



FLAMIN' SWITCHBLADE PEGS

- Flip-out heel rest adds comfort
- Heel rests have curb feeler tabs underneath
- Flip-out arm is designed only to be used as a heel rest



- Available without male-mount ends
- Pegs without adapters require the use of Kuryakyn tapered footpeg adapters (sold separately; see page 121)
- Sold in pairs

PART #	DESCRIPTION	SUG. RETAIL
1620-1145	Flamin' switchblade pegs w/o adapters	\$163.99



ZOMBIETM PEGS

- Feature a sinister chrome spire point and a skull nestled between the rubber pads
- Chrome bodies with rubber pads
- Sturdy, rugged pegs design
- Sold in pairs
- Require Kuryakyn tapered footpeg adapters; see page 121

PART #	DESCRIPTION	SUG. RETAIL
1620-0278	Footpegs w/o adapters	\$112.99

All part numbers in **BLUE** are new for 2019.

WINDSHIELDS & FAIRINGS

AUDIO, COMMUNICATION & MOUNTS

SADDLEBAGS & LUGGAGE

SEATS & Sissy BARS

EXHAUST

FUEL/AIR SYSTEMS

ENGINE

TRANSMISSION & DRIVELINE

GASKETS & SEALS

ELECTRICAL

LIGHTING

HANDLEBARS, CONTROLS & MIRRORS

CABLES

BRAKES

TANKS & OIL FILTERS

DASHES & GAUGES

FRAMES & SUSPENSION

FENDERS & LICENSE PLATE FRAMES

FOOTRESTS & FLOORBOARDS

WHEELS & AXLES

HARDWARE, COVERS & GENERAL



1620-1867



1620-1868



1603-0358



1603-0354

PHANTOM FOOTPEGS

- Constructed from quality A380 aluminum
- Durable EPDM rubber pads provide traction, vibration dampening, and will not harden, crack or wear over time
- Available splined adapters (sold separately) allow peg angle adjustability to dial in your preferred placement
- Available in chrome or gloss black
- Sold in pairs

PART #	DESCRIPTION	SUG. RETAIL
1620-1867	Chrome	\$99.99
1620-1868	Gloss black	99.99

PHANTOM SHIFT/BRAKE PEGS

- Constructed from A380 aluminum
- Durable EPDM rubber provides traction and will not harden, crack or wear over time
- Direct replacement for the stock shift peg on all Indian models, and also replaces the brake peg on Indian Scout models
- Available in chrome or gloss black

PART #	DESCRIPTION	SUG. RETAIL
FOR 14-19 CHIEF CLASSIC/VINTAGE, CHIEFTAIN, ROADMASTER, DARK HORSE (SHIFT PEG ONLY) AND 15-19 SCOUT (SHIFT AND BRAKE PEG)		
1603-0358	Chrome	\$49.99
1603-0354	Gloss black	49.99



1620-1788

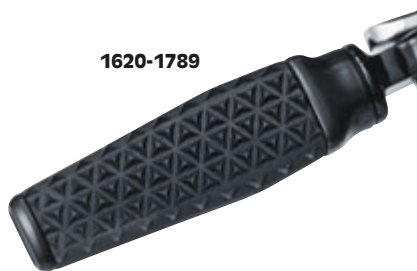

1620-1789



1603-0340



1603-0341

THRESHER FOOTPEGS

- Sleek and subtly aggressive with a unique, shark tooth-inspired, knurled rubber surface that delivers sharp style, excellent grip, and all-day vibration-dampening comfort
- Streamlined aluminum housings combined with soft, EPDM rubber and sturdy steel adapters
- Available without adapters for a wide range of fitments using model-specific splined adapters (sold separately)
- Chrome or satin black finish
- Sold in pairs

PART #	DESCRIPTION	SUG. RETAIL
1620-1788	Chrome	\$69.99
1620-1789	Satin black	69.99

THRESHER SHIFT AND BRAKE PEGS

- Streamlined aluminum housings wrapped in soft EPDM rubber
- Knurled rubber features a shark tooth-inspired design and offers ideal traction
- Available in chrome or satin black trim

PART #	DESCRIPTION	SUG. RETAIL
FOR 14-19 CHIEF CLASSIC/VINTAGE, CHIEFTAIN, ROADMASTER, DARK HORSE (SHIFT PEG ONLY) AND 15-19 SCOUT (SHIFT AND BRAKE PEG)		
1603-0340	Chrome	\$34.99
1603-0341	Satin black	34.99



WIDOW PEGS

- Full custom footpeg design
- Ominous black widow design nestled in the rubber pads
- Footpegs without adapters require the use of Kuryakyn tapered footpeg adapters, see page 121
- Sold in pairs

PART #	DESCRIPTION	SUG. RETAIL
1611-0016	Widow pegs w/o adapters	\$101.99



1620-1873



1620-1874

DILLINGER FOOTPEGS

- Multi-piece construction with contrasting finishes and a unique pass-through design for an aggressive look and feel
- Cast from high-quality aluminum with steel splined adapters
- Multi-piece housing blends textured and smooth surface finishes for a killer look
- Raised features on the top surface provide traction

PART #	DESCRIPTION	SUG. RETAIL
1620-1873	Silver	\$89.99

PART #	DESCRIPTION	SUG. RETAIL
1620-1874	Satin black	\$89.99

All part numbers in **BLUE** are new for 2019.

KURYAKYN



1620-1871



1620-1872

HEX FOOTPEGS

- Hex Pegs are a perfect blend of form and function
- Heavy-duty aluminum housings showcase an angular design with smooth beveled edges that provide depth
- Premium EPDM rubber inserts feature the same geometric pattern to deliver traction, style, and vibration-dampening comfort
- A380 aluminum housings

- Durable EPDM rubber inserts will not harden, crack or wear over time
- Styled to match the complete line of Kuryakyn Hex accessories
- Pegs without splined adapters require model-specific adapters, sold separately
- Splined adapters allow precise peg angle adjustability to dial in preferred placement
- Chrome or satin black finishes

PART #	DESCRIPTION	SUG. RETAIL
FOOTPEGS W/O ADAPTERS		
1620-1871	Chrome	\$79.99
1620-1872	Satin black	79.99



1603-0346



1603-0347

HEX SHIFT PEGS

- Hex Pegs are a perfect blend of form and function
- Heavy-duty aluminum housings showcase an angular design with smooth beveled edges that provide depth
- Premium EPDM rubber inserts feature the same geometric pattern to deliver traction, style, and vibration-dampening comfort
- A380 aluminum housings
- Durable EPDM rubber inserts will not harden, crack or wear over time
- Styled to match the complete line of Kuryakyn Hex accessories
- Pegs without splined adapters require model-specific adapters, sold separately
- Splined adapters allow precise peg angle adjustability to dial in preferred placement
- Chrome or satin black finishes

PART #	DESCRIPTION	SUG. RETAIL
FOR 14-19 CHIEF CLASSIC/VINTAGE, CHIEFTAIN, ROADMASTER, DARK HORSE (SHIFT PEG ONLY) AND 15-19 SCOUT (SHIFT AND BRAKE PEG)		
1603-0346	Chrome	\$34.99
1603-0347	Satin black	34.99

1620-1706



1620-1707

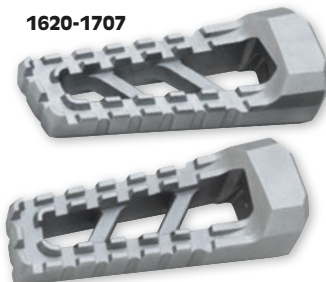

1603-0322



RIOT FOOTPEGS

- Industrial MX-style pegs
- Durable cast aluminum construction
- Serrated, toothed footpeg top surface provides non-slip traction during aggressive riding

- Require Kuryakyn model-specific splined adapters for installation (sold separately)
- Measure 4.6" L x 1.64" W x 1.29" thick
- Sold in pairs

PART #	DESCRIPTION	SUG. RETAIL
FOOTPEGS		
1620-1706	Satin black textured	\$69.99
1620-1707	Bead-blasted silver	69.99

RIOT SHIFT/BRAKE PEGS

- Industrial MX-style pegs
- Durable cast aluminum construction
- Serrated, toothed footpeg top surface provides non-slip traction during aggressive riding
- Require Kuryakyn model-specific splined adapters for installation (sold separately)
- Measure 2 1/2" L x 1 1/4" W
- Do not include mounting hardware
- Sold each

PART #	DESCRIPTION	SUG. RETAIL
FOR 14-19 CHIEF CLASSIC/VINTAGE, CHIEFTAIN, ROADMASTER, DARK HORSE (SHIFT PEG ONLY) AND 15-19 SCOUT (SHIFT AND BRAKE PEG)		
1603-0322	Satin black textured	\$34.99
1603-0323	Bead-blasted silver	34.99



1602-1044



1602-1045



TOE-REST CRUISE PEGS

- Minimalist toe rest mounts attach directly to engine guard to allow heel to sit on floorboard with front of foot resting just behind engine guard
- Fit stock 1 1/4" round engine guards
- Sold in pairs

PART #	DESCRIPTION	SUG. RETAIL
1624-0309	Toe rest cruise pegs	\$101.99

KINETIC SHIFT AND BRAKE PEG

- Shift through gears or stop on a dime in style
- Direct replacement and includes a 3/8" spacer to adjust the position during installation

PART #	DESCRIPTION	SUG. RETAIL
FOR 14-19 CHIEF CLASSIC/VINTAGE, CHIEFTAIN, ROADMASTER, DARK HORSE (SHIFT PEG ONLY) AND 15-19 SCOUT (SHIFT AND BRAKE PEG)		
1602-1044	Chrome	\$35.99
1602-1045	Gloss black	35.99

All part numbers in **BLUE** are new for 2019.

- WINDSHIELDS & FAIRINGS
- AUDIO, COMMUNICATION & MOUNTS
- SADDLEBAGS & LUGGAGE
- SEATS & SISSY BARS
- EXHAUST
- FUEL/AIR SYSTEMS
- ENGINE
- TRANSMISSION & DRIVELINE
- GASKETS & SEALS
- ELECTRICAL
- LIGHTING
- HANDLEBARS, CONTROLS & MIRRORS
- CABLES
- BRAKES
- TANKS & OIL FILTERS
- DASHES & GAUGES
- FRAMES & SUSPENSION
- FENDERS & LICENSE PLATE FRAMES
- FOOTRESTS & FLOORBOARDS
- WHEELS & AXLES
- HARDWARE, COVERS & GENERAL

WINDSHIELDS & FAIRINGS

AUDIO, COMMUNICATION & MOUNTS

SADDLEBAGS & LUGGAGE

SEATS & SISSY BARS

EXHAUST

FUEL/AIR SYSTEMS

ENGINE

TRANSMISSION & DRIVELINE

GASKETS & SEALS

ELECTRICAL

LIGHTING

HANDLEBARS, CONTROLS & MIRRORS

CABLES

BRAKES

TANKS & OIL FILTERS

DASHES & GAUGES

FRAMES & SUSPENSION

FENDERS & LICENSE PLATE FRAMES

FOOTRESTS & FLOORBOARDS

WHEELS & AXLES

HARDWARE, COVERS & GENERAL



1603-0329



1603-0330



HEAVY INDUSTRY SHIFT AND BRAKE PEG

- Direct replacement for stock with rugged style and durable construction
- Cast from quality aluminum with premium EPDM rubber
- Coordinated style with the complete line of Kuryakyn Heavy Industry accessories
- Available in chrome or satin black

PART #	DESCRIPTION	SUG. RETAIL
FOR 14-19 CHIEF CLASSIC/VINTAGE, CHIEFTAIN, ROADMASTER, DARK HORSE (SHIFT PEG ONLY) AND 15-19 SCOUT (SHIFT AND BRAKE PEG)		
1603-0329	Chrome	\$29.99
1603-0330	Satin black	29.99



ROAD RACING FOOTPEGS

- Footrests feature an intricately CNC-machined tread pattern in the top surface for optimal footing
- Much lighter than stock and have an angled design for better road clearance when cornering
- Machined from solid blocks of 6061-T6 billet aluminum
- Full 360° footpeg rotation makes these footpegs perfect for any application
- Male-mount footpegs have Joker's exclusive pitch adjustment screw to maintain the proper upward angle of the peg
- Dimensions 3 1/4" L x 1 1/4" W
- Available in hard black anodized or raw aluminum finish
- Made in the U.S.A.

PART #	DESCRIPTION	SUG. RETAIL
FOR 15-19 SCOUT MODELS (FRONT)		
1620-1718	Raw aluminum	\$124.95
1620-1719	Black	124.95



1620-1718



1620-1719



ADJUSTABLE SERRATED FOOTPEGS

- Fully CNC-machined from solid 6061-T6 bar
- Super strong, yet lightweight two-piece construction
- Wider foot surface for a comfortable ride
- Serrated surface provides a good bite to the bottom of your shoe
- Full 360° footpeg rotation makes these footpegs perfect for any application
- Pitch adjustment screw always keeps them in a good riding position
- Available in your choice of raw billet aluminum or our hard black anodized finish
- Available in many different shapes and sizes
- Made in the U.S.A.



1620-1708



1620-1711



1620-1712



1620-1715



1620-1716

FOR 15-19 SCOUT MODELS (FRONT)					
PART #	DESCRIPTION	SUG. RETAIL	PART #	DESCRIPTION	SUG. RETAIL
LONG: 4 1/2" LONG X 2 1/2" WIDE X 1" THICK					
1620-1708	Raw aluminum	\$164.95	NARROW: 4 5/16" LONG X 1 1/2" WIDE X 1 5/16" THICK (CONT)		
1620-1709	Black anodized	164.95	1620-1713	Black anodized	\$154.95
SHORT: 3 5/16" LONG X 2 1/2" WIDE X 1" THICK					
1620-1710	Raw aluminum	154.95	HEEL: 4 5/16" LONG X 3 7/8" WIDE X 1 5/16" THICK		
1620-1711	Black anodized	154.95	1620-1714	Raw aluminum	179.95
NARROW: 4 5/16" LONG X 1 1/2" WIDE X 1 5/16" THICK					
1620-1712	Raw aluminum	154.95	1620-1715	Black anodized	179.95
STUBBY: 3" LONG X 1 1/2" WIDE X 1 5/16" THICK					
NARROW: 4 5/16" LONG X 1 1/2" WIDE X 1 5/16" THICK					
1620-1716	Raw aluminum	144.95	STUBBY: 3" LONG X 1 1/2" WIDE X 1 5/16" THICK		
1620-1717	Black anodized	144.95	1620-1716	Raw aluminum	144.95
NARROW: 4 5/16" LONG X 1 1/2" WIDE X 1 5/16" THICK					
1620-1717	Black anodized	144.95	1620-1717	Black anodized	144.95



V-LINE FOOTPEGS AND PASSENGER PEG RELOCATION KIT

- Complement the rest of the V-line billet products
- Include mounting hardware
- Available in chrome or Reverse Cut gloss black powder-coated finish
- Made in the U.S.A.



1620-1646



1620-1645



1620-1644

FOR 15-19 SCOUT MODELS					
PART #	DESCRIPTION	SUG. RETAIL	PART #	DESCRIPTION	SUG. RETAIL
DRIVER FOOTPEGS			PASSENGER PEG RELOCATION KIT		
1620-1646	Reverse Cut	\$139.95	1620-1644	Universal kit, black	\$179.95
1620-1645	Chrome	139.95			

All part numbers in **BLUE** are new for 2019.



CARL BROUHARD DESIGNS LLC

SHIFTER PEGS

- Constructed of 6061-T6 billet aluminum
- Install using 5/16"-24 stud
- Pyramid rubber for added traction
- Available with chrome or black-anodized finish

PART #	DESCRIPTION	SUG. RETAIL
1603-0134	Black	\$73.95



1603-0134



1603-0135

- Fits CBD shift arms (see page 115)
- Easy to install
- Made in the U.S.A.

PART #	DESCRIPTION	SUG. RETAIL
1603-0135	Chrome	\$73.95



SHIFT PEG EXTENDER

- Manufactured from billet stainless steel with a highly polished finish
- Extends shift peg out 1 1/2"

PART #	DESCRIPTION	SUG. RETAIL
1603-0359	14-19 Chief/Chieftain/ Roadmaster/ Springfield Models	\$56.95



SHIFTER PEG COVER

- Chrome-plated, die-cast shifter peg cover with rubber inserts
- Secures with setscrews
- Fits 8mm pegs found on Indian models listed

PART #	DESCRIPTION	SUG. RETAIL
1603-0321	For 14-17 Chief, 15-17 Roadmaster	\$39.95



KURYAKYN

TAPERED FOOTPEG ADAPTERS

- For use with Kuryakyn footpegs and floorboards that do not have male-mount ends
- Beautiful chrome finish
- Sold in pairs

PART #	FITS MODEL	SUG. RETAIL
1620-1557	For 15-19 Scout (front only)	\$27.99



1620-1245



1620-1246



REAR FOLDING FOOTPEG ADAPTERS

- CNC-machined 6061-T6 billet aluminum with a brilliant chrome or black anodized finish
- 1 1/4" diameter, and attached with the stock footpeg pin and then attached with a 5/16" bolt to the adapters
- Allow the use of standard H-D male-mount style footpegs to be used on Indian models
- Sold in pairs
- Made in the U.S.A.

DESCRIPTION	PART #	SUG. RETAIL
FOR 14-18 CHIEF/CHIEFTAIN		
Chrome	1620-1245	\$77.95
Black anodized	1620-1246	77.95

KURYAKYN

SPLINED ADAPTER MOUNTS

- Provide slip-free mounting of Kuryakyn ISO®-Boards™ and other Kuryakyn footpeg and foot control accessories that require splined peg adapter mounts
- Sold in pairs

PART #	FITS MODEL	SUG. RETAIL
1620-1558	For 15-19 Scout (front only)	\$27.99



REAR PASSENGER FOOT PEG MOUNTS

- Steel construction
- Available in wrinkle black powder-coated finish
- Include all necessary mounting hardware
- Sold in pairs

PART #	DESCRIPTION	SUG. RETAIL
1620-1650	For 15-19 Scout	\$124.95



All part numbers in **BLUE** are new for 2019.

- WINDSHIELDS & FAIRINGS
- AUDIO, COMMUNICATION & MOUNTS
- SADDLEBAGS & LUGGAGE
- SEATS & SISSY BARS
- EXHAUST
- FUEL/AIR SYSTEMS
- ENGINE
- TRANSMISSION & DRIVELINE
- GASKETS & SEALS
- ELECTRICAL
- LIGHTING
- HANDLEBARS, CONTROLS & MIRRORS
- CABLES
- BRAKES
- TANKS & OIL FILTERS
- DASHES & GAUGES
- FRAMES & SUSPENSION
- FENDERS & LICENSE PLATE FRAMES
- FOOTRESTS & FLOORBOARDS
- WHEELS & AXLES
- HARDWARE, COVERS & GENERAL

WINDSHIELDS & FAIRINGS

AUDIO, COMMUNICATION & MOUNTS

SADDLEBAGS & LUGGAGE

SEATS & SISSY BARS

EXHAUST

FUEL/AIR SYSTEMS

ENGINE

TRANSMISSION & DRIVELINE

GASKETS & SEALS

ELECTRICAL

LIGHTING

HANDLEBARS, CONTROLS & MIRRORS

CABLES

BRAKES

TANKS & OIL FILTERS

DASHES & GAUGES

FRAMES & SUSPENSION

FENDERS & LICENSE PLATE FRAMES

FOOTRESTS & FLOORBOARDS

WHEELS & AXLES

HARDWARE, COVERS & GENERAL



0203-0603



0204-0502



0203-0610



LACED WHEEL ASSEMBLIES

- Classic spoke design
- Available in 50 or 60 spoke styles
- Chrome billet aluminum hubs with polished stainless steel spokes and polished stainless steel nipples
- Chrome-plated steel rims
- Wheels come completely assembled and are trued to less than .005" runout
- DOT approved

- Accept CMV tubes (except 16"x3.5" wheels, which use an SMV tube)
- Sealed design allows tubeless tires to be used
- Stock pulleys and rotors can be used
- Front and rear applications for most popular models
- Sizes available for custom applications
- Made in the U.S.A. by RideWright Wheels

NOTE: 21" front wheel applications cannot use factory front fender. It is the installer's responsibility to determine the required changes.

FRONT WHEELS

SIZE	RADIAL LACED 50-SPOKE	SUG. RETAIL	CROSS LACED 60-SPOKE	SUG. RETAIL
16 x 3.50 for all 14-19 models (except Scout)	0203-0603	\$943.95	0203-0604	\$943.95
18 x 3.50 for all 14-19 models (except Scout)	0203-0605	962.95	0203-0606	962.95
21 x 3.50 for all 14-19 models (except Scout)	0203-0607	1,096.95	0203-0608	1,096.95
16 x 3.50 for 15-19 Scout	0203-0609	943.95	0203-0610	943.95

REAR WHEELS

SIZE	RADIAL LACED 50-SPOKE	SUG. RETAIL	CROSS LACED 60-SPOKE	SUG. RETAIL
16 x 5.50 for all 14-19 models (except Scout)	0204-0502	\$1,171.95	0204-0503	\$1,171.95
18 x 5.50 for all 14-19 models (except Scout)	0204-0504	1,324.95	0204-0505	1,324.95
16 x 3.50 for 15-19 Scout	0204-0506	943.95	0204-0507	943.95



FRONT WHEEL BEARING AND SEAL KIT

- High-speed bearings are manufactured to ABEC 3 precision levels
- Triple-lip rubber seals keep the grease in and the water and dirt out
- Chevron SRI 2 grease contains rust and oxidation inhibitors (-20°-350°F)
- Double-lip type TC seals with stainless steel garter springs



PART #	FITS MODEL	SUG. RETAIL
0215-0092	For 14-17 Chief Classic/Vintage, Chieftain, 15-17 Roadmaster, Scout, Scout Sixty, 16-17 Springfield	\$24.95

SAFETY WARNING: WHEN SELECTING CUSTOM WHEELS, THE TIRES USED FOR YOUR APPLICATION MUST HAVE A LOAD INDEX AND SPEED RATING EQUAL TO OR GREATER THAN THE TIRES FITTED AS ORIGINAL EQUIPMENT. CONSULT MANUFACTURER'S PUBLICATION(S) AND/OR WEBSITE(S) FOR COMPLETE TIRE INFORMATION.

All part numbers in **BLUE** are new for 2019.



0210-0333
Shown w/cartridge
hubs installed



0210-0351
Shown w/cartridge
hubs installed



0210-0338
Shown w/cartridge
hubs installed



0210-0344
Shown w/cartridge
hubs installed

FORGED BILLET RIMS

- Choose from Procross and 7-Valve style forged billet rims
- All rims are CNC machined from radial forged 6061-T6 aluminum for maximum road durability and strength-to-weight ratio
- Features a rolled rim lip for the custom look and detailed CNC machine work from the center of the hub to the edge of the rim
- Each rim can be used on both front and/or rear of the motorcycle when correct hub kit is installed
- Rims accept Arlen Ness hub kits, which allows full wheels to be assembled in minutes with basic tools
- Structurally tested to meet or exceed DOT, JAS and TUV international load ratings

NOTE: Rims do not include hubs. Hubs are purchased separately.

DESCRIPTION	PROCCROSS CHROME	SUG. RETAIL	PROCCROSS BLACK	SUG. RETAIL	7 VALVE CHROME	SUG. RETAIL	7 VALVE BLACK	SUG. RETAIL
FRONT								
21" x 3.50"	0210-0339	\$999.95	0210-0333	\$899.95	0210-0351	\$899.95	0210-0345	\$699.95
REAR								
18" x 5.50"	0210-0338	1,099.95	0210-0332	1,099.95	0210-0350	1,049.95	0210-0344	799.95

CARTRIDGE HUBS KITS

- These billet aluminum hub kits are designed for Arlen Ness forged billet rims
- Cartridge hub design features wheel bearings pre-set in one hub for optimum radial and lateral runout accuracy
- Lightweight coped design provides form and function
- Each hub kit includes everything you need for Indian Bagger applications with TPMS or without TPMS; regardless of your wheel diameter
- Hub kits mount to your Arlen Ness forged rims in minutes with basic tools offering excellent flexibility for stock or custom applications, and allowing all sizes to be available for most applications
- Available in chrome or black anodized finish, each hub kit includes everything needed for simple installation

NOTE: Hubs listed accept factory or aftermarket hub mounted 5-bolt hub mounted rotors (3.25" bolt circle).



0213-0823



0213-0828

DESCRIPTION	CHROME	SUG. RETAIL	BLACK	SUG. RETAIL
FRONT				
For 14-18 Chieftain/Chief/Road Master/Classic/Vintage/Dark Horse/Springfield (with TPMS)	0213-0823	\$299.95	0213-0822	\$299.95
For 14-18 Chieftain/Chief/Road Master/Classic/Vintage/Dark Horse/Springfield (without TPMS)	0213-0825	299.95	0213-0824	299.95
REAR				
For 14-18 Chieftain/Chief/Road Master/Classic/Vintage/Dark Horse/Springfield (with TPMS)	0213-0827	299.95	0213-0826	299.95
For 14-18 Chieftain/Chief/Road Master/Classic/Vintage/Dark Horse/Springfield (without TPMS)	0213-0829	299.95	0213-0828	299.95

SAFETY WARNING: WHEN SELECTING CUSTOM WHEELS, THE TIRES USED FOR YOUR APPLICATION MUST HAVE A LOAD INDEX AND SPEED RATING EQUAL TO OR GREATER THAN THE TIRES FITTED AS ORIGINAL EQUIPMENT. CONSULT MANUFACTURER'S PUBLICATION(S) AND/OR WEBSITE(S) FOR COMPLETE TIRE INFORMATION.

All part numbers in **BLUE** are new for 2019.

WINDSHIELDS & FAIRINGS

AUDIO, COMMUNICATION & MOUNTS

SADDLEBAGS & LUGGAGE

SEATS & SISSY BARS

EXHAUST

FUEL/AIR SYSTEMS

ENGINE

TRANSMISSION & DRIVELINE

GASKETS & SEALS

ELECTRICAL

LIGHTING

HANDLEBARS, CONTROLS & MIRRORS

CABLES

BRAKES

TANKS & OIL FILTERS

DASHES & GAUGES

FRAMES & SUSPENSION

FENDERS & LICENSE PLATE FRAMES

FOOTRESTS & FLOORBOARDS

WHEELS & AXLES

HARDWARE, COVERS & GENERAL

WINDSHIELDS & FAIRINGS

AUDIO, COMMUNICATION & MOUNTS

SADDLEBAGS & LUGGAGE

SEATS & SISSY BARS

EXHAUST

FUEL/AIR SYSTEMS

ENGINE

TRANSMISSION & DRIVELINE

GASKETS & SEALS

ELECTRICAL

LIGHTING

HANDLEBARS, CONTROLS & MIRRORS

CABLES

BRAKES

TANKS & OIL FILTERS

DASHES & GAUGES

FRAMES & SUSPENSION

FENDERS & LICENSE PLATE FRAMES

FOOTRESTS & FLOORBOARDS

WHEELS & AXLES

HARDWARE, COVERS & GENERAL



SCORPIO

SRX-950 HANDS-FREE SECURITY SYSTEM

- Simplified 3-Wire Universal Installation
- Auto or manual arming and disarming
- Ignition circuit sensor
- Compact design (3¹¹/₁₆" x 2³/₄" x 7⁷/₈")
- Dual-axis accelerometer for detecting impact/inclination
- Built-in 120 dB multi-tone siren
- Includes adjustable perimeter sensor
- Smart Battery Safeguard with sleep mode
- RFID hands-free technology links the included remote to the alarm unit
- Remote motorcycle finder/panic alarm
- Built-in battery backup system allows the pager to operate even if wires are cut or circumvented
- Has multiple remote capability
- Remote has a long-range rechargeable FM transceiver (up to a 1/2 mile)
- Remote features include audible/vibrating alert, alert violation display direct to your remote, motorcycle battery voltage display and range/signal status display
- Includes charging cord for remote receiver

PART #	DESCRIPTION	SUG. RETAIL
4020-0093	SRX-950 security system w/ remote	\$349.95



LAYDOWN LICENSE PLATE AND DOUBLE FLAG HOLDER

- Designed for a custom "laydown" look; replaces plastic OEM part
- Made of high-quality stainless steel that is hand polished to a brilliant finish
- Flagpoles are topped with chrome finials and include clips to keep flags in place at pole tops
- Mounts easily and will remain sturdy, even at highway speeds
- Accommodates 6" x 9" flags (not included)
- Made in the U.S.A.

PART #	DESCRIPTION	SUG. RETAIL
2030-1017	For 14-19 Chief/Chieftain, 15-19 Roadmaster	\$79.95



FLAG MOUNTS WITH U.S.A. FLAG

- Extends flag pole out approximately 1.25"
- High-quality stainless steel
- Includes Allen keys for easy installation
- Made in the U.S.A.

PART #	DESCRIPTION	SUG. RETAIL
FITS .51" HORIZONTAL ROUND BAR (FOR PINNACLE LUGGAGE RACK)		
0521-1469	9" Pole, 6" x 9" Flag	\$59.95
0521-1472	13" Pole, 10" x 15" Flag	74.95
FITS .765" HORIZONTAL ROUND BAR (FOR LUGGAGE ON DETACHABLE SISSY BAR)		
0521-1470	9" Pole, 6" x 9" Flag	59.95
0521-1473	13" Pole, 10" x 15" Flag	74.95



0521-1472



0521-1474

PART #	DESCRIPTION	SUG. RETAIL
FITS .765" VERTICAL ROUND BAR FOR CHIEF CLASSIC AND CHIEF VINTAGE QUICK RELEASE (PASSENGER SISSY BAR)		
0521-1471	9" Pole, 6" x 9" Flag	\$59.95
0521-1474	13" Pole, 10" x 15" Flag	74.95



12" FLAG POLE WITH FLAG AND FINIAL

- Flag pole mounts to any 1/2" tubular rack or rail; does not fold down
- O-rings keep the flag in place
- Include heavy-duty polyester 6" x 9" American flag
- Available with Acorn finial



PART #	DESCRIPTION	SUG. RETAIL
0521-1581	12" flag pole w/flag	\$29.95



KURYAKYN

PASSENGER DRINK HOLDER

- Mounts to the right side of the factory Tour Trunk
- Quick-detach design leaves only a small satin black bracket visible when holder is removed
- Mesh basket has rubber "fingers" that grip to hold a variety of cup or bottle shapes/sizes securely in place

PART #	DESCRIPTION	SUG. RETAIL
0603-0739	For 15-19 Roadmaster (except 17-19 Roadmaster Classic) and 14-19 Chieftains with a Tour Trunk	\$81.99

All part numbers in **BLUE** are new for 2019.

OEM CROSS-REFERENCE

	YEAR	BATTERY	SPARKPLUG NGK	SPARKPLUG CHAMPION	CHAIN/BELT	SPROCKET FRONT	SPROCKET REAR	TIRE SIZE/LOAD INDEX FRONT	TIRE SIZE/LOAD INDEX REAR
INDIAN									
FTR1200/S	2019	N/A	N/A	N/A	Chain	N/A	N/A	120/70R19 60V	150/80R18 70V
Scout	2015-2019	YTX14AH-BS	MR7F	RG4PHP	22mm x 141T	28T	66T	130-90B16 67H	150/80B16 67H
Scout Sixty	2016-2019	YTX14AH-BS	MR7F	RG4PHP	22mm x 141T	28T	66T	130/90-16 72H	150/80-16 71H
Scout Bobber	2018-2019	YTX14AH-BS	MR7F	RG4PHP	22mm x 141T	28T	66T	130/90-16 73H	150/80-16 71H
Chief Dark Horse	2016-2019	YTX20HL-BS	DCPR8E	RA4HC	24mm x 152T	30T	66T	130/90B16 73H	180/65B16 81H
Chief	2018	YTX20HL-BS	DCPR8E	RA4HC	24mm x 152T	30T	66T	130/90B16 73H	180/65B16 81H
Chief Classic	2014-2018	YTX20HL-BS	DCPR8E	RA4HC	24mm x 152T	30T	66T	130/90B16 73H	180/65B16 81H
Chief Vintage	2014-2019	YTX20HL-BS	DCPR8E	RA4HC	24mm x 152T	30T	66T	130/90B16 73H	180/65B16 81H
Springfield Dark Horse	2018-2019	YTX20HL-BS	DCPR8E	RA4HC	24mm x 152T	30T	66T	130/60B19 61H	180/60R16 80H
Springfield	2016-2019	YTX20HL-BS	DCPR8E	RA4HC	24mm x 152T	30T	66T	130/90B16 73H	180/60R16 80H
Chieftain	2014-2019	YTX20HL-BS	DCPR8E	RA4HC	24mm x 152T	30T	66T	130/60B19 61H	180/60R16 80H
Chieftain Dark Horse	2016-2019	YTX20HL-BS	DCPR8E	RA4HC	24mm x 152T	30T	66T	130/60B19 61H	180/60R16 80H
Chieftain Classic	2018-2019	YTX20HL-BS	DCPR8E	RA4HC	24mm x 152T	30T	66T	130/90B16 73H	180/60R16 80H
Chieftain Limited	2017-2019	YTX20HL-BS	DCPR8E	RA4HC	24mm x 152T	30T	66T	130/60B19 61H	180/60R16 80H
Chieftain Elite	2017-2018	YTX20HL-BS	DCPR8E	RA4HC	24mm x 152T	30T	66T	130/60B19 61H	180/60R16 80H
Roadmaster Classic	2017-2018	YTX20HL-BS	DCPR8E	RA4HC	24mm x 152T	30T	66T	130/90B16 73H	180/60R16 80H
Roadmaster	2015-2019	YTX20HL-BS	DCPR8E	RA4HC	24mm x 152T	30T	66T	130/90B16 73H	180/60R16 80H
Roadmaster Elite	2018	YTX20HL-BS	DCPR8E	RA4HC	24mm x 152T	30T	66T	130/90B16 73H	180/60R16 80H

2019 DRAG SPECIALTIES INDIAN CATALOG

PART #

9901-2323

DESCRIPTION

2019 Drag Specialties Indian catalog



A

Accent lights/kits	81
Accents	104
Accutronix	
Floorboards	112
Folding rear footpeg adapters	121
Side-mount license plate frames	111
Adaptive headlights	76
Adjustable mount passenger floorboards	114
Air cleaner covers	64
Air cleaners/kits	64-65
Air filter pre-filter	64
Air filters	65
Air horns	73
Air intake assemblies emission control regulatory information	4
Alarms	124
All Balls	
Steering stem bearings	86
Wheel bearings/seals	122
Alto	
Clutch plate kits	69
Antennas	41
Arlen Ness	
Brake rotors	95
Cam covers	66
Derby covers	69
Fairings	21
Front pulley covers	70
Handlebars	85
Horn covers	74
Key switch cover	74
Rims	123
Shock absorber	108
Wheel hubs	123
Armrests	42, 48

AUDIO, COMMUNICATION & MOUNTS 22-41

Avon	
Grips	91

B

Backrest mount kits	51
Backrest pads	48
Backrests	51-52
Badlands	
Illuminator module	83
Run/turn/brake light control modules	79
Baffle	59
Bags, duffl	44
Barnett	
Cables	93
Clutch shaft arm	69
Clutches/kits	69
Bassani	
Exhaust end caps	55

Bassani (CONT)

Exhaust systems	54
Muffler	55-56
Batteries	71-73
Battery vent tube	72
Bearings, steering stem	86
Bearings/seals, wheel	122
Beverage holders	124
Blue Streak	
Spark plug wires	71
Bluetooth audio controller	39
Bluetooth communicators/accessories	22-34, 36-38
Bluetooth headsets/accessories	33
Bluetooth microphone kits	31
Bluetooth RC remote control units	35
Bluetooth transmitter	36
Bolts/nuts, batteries	72
Booster wings	7

BRAKES 95-100

Brake arms	115
Brake cables	94
Brake levers	88
Brake light flasher module	82
Brake lights	82
Brake lines/fittings junctions, hydraulic	100
Brake master cylinder covers	87
Brake pads	95-100
Brake pedal covers	116
Brake pedal pads	116
Brake pedals	115
Brake pegs	118-120
Brake rotors	95
Builders kit	40
Bulbs	83

C

CABLES 93-94

Cables, clutch	93
Cam cover accents	66
Cam covers	66
Camera/camcorder mounts	40-41
Cameras	26-27
CAM's emission control regulatory information	4
CANbus module	82
CARB emission control regulatory information	4
Carburetors and part kits emission control regulatory information	4

Carl Brouhard Designs

Brake arms	115
Brake pedal covers	116
Brake pedals	115
Derby covers	67
Drive pulleys	70
Floorboards	112
Fork slider covers	106

Carl Brouhard Designs (CONT)

Grips	89
Heel/toe shift levers	116
License plate mounts	111
Master cylinder covers	87
Shift arms	115
Shift levers	116
Shift pegs	121
Shift rods	70
Stator covers	67
Catalogs	125
CB helmet clamp kit	35
Charging mount for iPhone/Smartphone/GPS	37
Chin spoiler	104
Clutch cables	93-94
Clutch cover accent	68
Clutch kits	69
Clutch levers	88
Clutch shaft arm	69
Clutches/kits	69

Cobra

Fuel injection controllers	62
Muffler	61

Communicator systems/accessories 34

Communicators/accessories 22-34, 36-38

Control cables 94

Control levers 88

Coolant hose covers 67

Cooler bags 43

Covers, horn 74

Covers, lever 88

Cruise pegs 119

Crusher

Muffler 60

Cup holders 124

Custom Dynamics

Accent lights/kits 81

Brake light flasher module 82

Brake lights 82

Isolator modules 74

LED accent lights/light kits 80-81

LED headlamps 75

LED passing lamps 77

Magical Wizards Indian War Bonnet accent light kits 81

Cycle Visions

Rear passenger footpeg mounts 121

Sissy bar side plates 52

Cylinder base cover 67

D

DASHES & GAUGES 102-103

Dash accents 103

Dash accents/trims 103

Dash pouches 102

Data monitor 63

Derby covers 67, 69

Digital display for Power Commander	63
Digital video cameras	26-27
Dipsticks	101
Dipsticks, oil	101
Double flag license plate holder	124
DP Brakes	
Brake pads	97
Drag Specialties	
Air filters	65
Batteries	71
Brake pads	95-96
Catalog	125
Grip covers	88
Handlebar lever covers	88
Ignition coils	71
Laced wheel assemblies	122
Oil filter	66
Spark plug wires	71
Drag Specialties Seats	
Backrests	52
Seats	46-47
Drink holders	124
Drive pulley covers	70
Drive pulleys	70
Driving light bezels	78
Driving lights	77-78
Duffle bag	44
Dynamat Beat the Heat kit	52
Dynamat sound control kits	41
Dynojet	
Digital display for Power Commander	63
Power Commander V map switch	63
Power Commanders	62
Power Vision CX	63
E	
EBC	
Brake pads	99
ELECTRICAL	71-74
Electric easy shift speed shifter kit	70
Electrical emission control regulatory information	4
Electronics mounts	40-41
Emission control regulatory information	4
Emissions Information	4
ENGINE	66-67
Engine emission control regulatory information	4
EXHAUST	53-61
Exhaust baffle	59
Exhaust emission control regulatory information	4
Exhaust end caps/tips	55

Exhaust products emission control regulatory information	4
Exhaust systems/muffler	53-61
F	
Fairing mounting hardware	19
Fairing turn signal trim	21
Fairings	16, 19, 21
Fairings, batwing	17-18
Fairings/mounting hardware	19-20
FENDERS & LICENSE PLATE FRAMES	109-111
Fender accents	110
Fender bibs	52
Fender skirt	110
Fenders	109-110
Filler panel lights	78
Filters, air	65
Filters, oil	66
Flag mounts/bases/poles	124
Flag/license plate holder	124
Flags/poles	124
Flare windshields	5
Flo	
Oil filter	66
Floorboard inserts	114
Floorboard mount spreader kit	114
Floorboards	112-114
Folding footpeg adapters	121
FOOTRESTS & FLOORBOARDS	112-121
Foot/shifter pegs	117
Footpeg adapter mounts	121
Footpeg adapters	121
Footpeg mounts	121
Footpegs	117-120
Fork slider covers	106
Fork springs	107
Fork tube accents	106
Fram	
Oil filter	66
FRAMES & SUSPENSION	104-108
Frame accents	104
Frames, license plate/mounts	111
Front end lowering kits	107
Front end suspension systems	106
Front fender skirt	110
Front fenders	109-110
Front fork lowering kits	107
Front pulley covers	70
FUEL/AIR SYSTEMS	62-65
Fuel caps	101
Fuel controllers/modules emission control regulatory information	4
Fuel flow programmers emission control regulatory information	4
Fuel flow tuners emission control regulatory information	4
Fuel injection controllers	62

Fuel/air systems emission control regulatory information	4
Fuelpak	62
G	
Galfer	
Brake pads	100
Brake rotors	95
Gas tank mini bras	102
Gauge accents	103
GPS battery charger	37
GPS mount w/ charger	37
GPS mounts	40-41
Grip covers	88
Grips	89-91
H	
Half helmet intercom systems/accessories	31
Hand guards	91
Handgrips	89-90
HANDLEBARS, CONTROLS & MIRRORS	84-92
Handlebar grips	89, 91
Handlebar kits	84
Handlebar lever covers	88
Handlebar risers	86
Handlebar wiring harnesses/extensions	74
Handlebars	84-86
HardBagger	
LED lights	79
HARDWARE, COVERS & GENERAL	124
Harness kits, handlebar wiring	74
Headlight adapter kit	76
Headlights	75-76, 83
Headsets/accessories	33
Heated grip wire extension harness	91
Heated seats	48
Heel/toe shift levers	116
Hidden trailer hitch	105
Highway bars	105
Hopnel	
Dash pouches	102
Gas tank mini bras	102
Highway bars	105
Lever fringe	88
Luggage rack bags	45
Phone pouches	41
Saddlebag cooler	43
Tuxedo Ties	102
Horn covers	74
Horns	73
Hot Wings	7
Hubs, wheel	123
Hydraulic brake lines/fittings junctions	100
Hydraulic master cylinder covers	87

I

Ignition coils	71
Ignition switch covers	74
Illuminator modules	83
Illuminators	83
Indian War Bonnet accent light kits	81
Intercom headsets/accessories	33
Intercom microphone kits	31
Intercom systems/accessories	22-38
iPhone battery charger	37
iPhone mount w/ charger	37
iPhone mounts	40-41
Isolator modules	74

J

J&M	
Headsets/accessories	38
J.W. Speaker	
Adaptive LED headlights	75-76
Headlights	75-76
Jacket roll	44
Joker Machine	
Brake/clutch levers	88
Floorboards	113
Footpegs	120
Master cylinder covers	87
Pulley covers	70
Rear turn signal adapters	79
Shift rods	70
Steering stem nuts	86

K

K&N	
Air filters	65
Key switch cover	74
Khrome Werks	
Muffler	60
Klock Werks	
Builders kit	40
Dynamat Beat the Heat kit	52
Dynamat sound control kits	41
Fenders	109-110
Flare windshields	5
Handlebar kits	84
Handlebars	84
iOadapt disc	40
iOmounts	40-41
iOskin	40
Nomad device mount	41
Number plate kit	110
Radiator guard	67
Seat cooling mat	52
Seat pan kits	51

Kuryakyn	
Air cleaners	64
Backrest mount kits	51
Bluetooth audio controller	39
Brake pedal pads	116
Brake pegs	118-120
Cam cover accents	66
Chin spoiler	104
Clutch cover accent	68
Clutch/brake levers	88
Coolant hose covers	67
Cruise pegs	119
Cylinder base cover	67
Dipsticks	101
Drink holders/beverage carriers	124
Driving light bezels	78
Fairing turn signal trim	21
Fairings	21
Fenders	110
Floorboard inserts	114
Floorboards	113-114
Footpeg adapters	121
Footpegs	117-120
Fork tube accents	106
Frame accents	104
Front fender skirt	110
Front fender top accents	110
Front pulley covers	70
Fuel caps	101
Gauge accents	103
Grips	89-90
Headlight adapter kit	76
Horn covers	74
Instrument/stereo/switch panel accents	103
Jacket roll	44
License plate frames	111
License plate mounts	111
License plate mounts/frames/components	111
Luggage	44-45
Mechanical cruise assist	87
Mini floorboards	113
Mirror adapters	92
Mirrors/components	92
Oil cooler cover	101
Passing lamp adapter harness	82
Primary cover accents	68
Primary cover caps	68
Primary covers	68
Rear fender side accents	110
Rear fender strip lights/light bars	78
Rear fender tip	110
Rear master cylinder covers	87
Rear swingarm covers	104
Saddle shields	52
Saddlebag cooler	43

Kuryakyn (CONT)	
Saddlebag top trim	43
Saddlebags	45
Shift levers	116
Shift pegs	117-120
Sound bars	39
Speaker grilles	103
Speaker pods	39
Splined footpeg adapter mounts	121
Starter covers	74
Stator covers	67
Stereo accents	103
Swingarm pivot accents	104
Taillight trim	21
Tank side scoops	101
Tappet block accent	66
Tie-down brackets	105
Toe rest cruise pegs	119
Top dash accents	103
Transmission center cover	68
Trunk lid organizer	42
Trunk light accent	79
Trunk relocater	42
Windshield trim	21

L

Laced wheel assemblies	122
LED accent lighting	81
LED accent lights/light kits	80-81
LED bulbs	83
LED headlamp	75
LED headlights	75-76, 83
LED license plate frames	111
LED lights	79
LED passing lamps	77
Legend Suspension	
Front end suspension systems	106
Shock absorbers	107
Lever covers	88
Levers	88
Levers fringe	88
License plate frames	111
License plate frames w/ LEDs	111
License plate frames/mounts	111
License plate mounts	111
License plate/double flag holder	124
Lindby	
Highway bars	105
LIGHTING 75-83	
Los Angeles Choppers	
Control cables	94
Handlebars	85
Suspension lowering kits	108
Lower fork tube accents	106
Luggage rack bags	45
Luggage racks	45

M

Magical Wizards Indian War Bonnet accent light kits	81
Magnum	
Brake lines/fitting	100
Control cables/kits	93
Master cylinder covers	87
Mechanical cruise assist	87
Memphis Shades	
Batwing fairing	17-18
Booster wings	7
Bullet fairing	19
Cafe fairing	20
Fairing mounting hardware	19
Gauntlet fairings	20
Hand guards	91
Hot Wings	7
Quick change windshield mounting hardware	11
Road Warrior fairing	19
Windshield lowers	7
Windshield lowers mounting hardware	7
Windshield mounting hardware	5-6, 8-10
Windshields	5-6, 8-10
Windshields/mounting hardware	18
Microphone kits	31
Mini floorboards	113
Mirror adapters	92
Mirror stems	92
Mirrors	92
Muffler	53, 55-61
Mustang	
Fender bibs	52
Seats	48-50
Sissy bar pads	51

N

NAMZ	
Handlebar wiring harness/extensions	74
Heated grip wire extension harness	91
Illuminator	83
Trailer output harness	105
Turn signal wire adapters	82
Nash	
Handlebars	86
Neck accents	104
Number plates	110

O

Oil cooler cover	101
Oil dipsticks	101
Oil filters	66
OEM CROSS REFERENCE	125

Oversize brake rotor kits	95
Oxygen sensors emission control regulatory information	4
O ₂ eliminators emission control regulatory information	4

P

Parts Unlimited

Batteries	73
Passenger armrests	42
Passenger floorboards	114
Passing lamp adapter	82
Passing lamp harnesses	82

PC Racing

Shock absorbers	108
Pegs, foot/shifter	117

Performance Machine

Air cleaners/kits	65
Performance tuner	63
Phone pouches	41

PIAA

Bulbs	83
-------	----

Pingel

Electric easy shift speed shifter kit	70
Floorboard mount spreader kit	114
Shift peg extender	121
Pivot accents, swingarm	104
Pivoting handlebar risers	86
POD-300 digital display for Power Commander	63
Portable chargers iPhone/Smartphone/GPS	37
Power Commander V map switch	63
Power Commanders	62

Power Max

Batteries	73
Power Vision CX	63
Pre-filter for air cleaners	64
Primary cover accents	68
Primary cover caps	68
Primary covers	68

Pro Pad Inc.

Flags/mounts/bases	124
--------------------	-----

Progressive Suspension

Fork lowering kits	107
Fork springs	107
Pulley covers	70
Pulley covers, front	70

R

Rack bags	44
Radiator grilles/covers	67
Radiator guard	67
Radiator side accents	104
RC remote control units	35
Rear fender accents	104, 110
Rear fender side accents	110

Rear fender tip	110
Rear fenders	110
Rear master cylinder covers	87
Rear swingarm covers	104
Rear turn signal adapters	79
Rectifiers regulators	71
Regulators/rectifier	71

Rick's Motorsport

Rectifiers regulators	71
Rims	123
Risers, handlebar, pivoting	86

Rivco

Air horns	73
CANbus module	82
Driving lights	78
Floorboards	114
Hidden trailer hitch	105
LED bulbs	83
License plate/double flag holder	124
Passenger armrests	42
Trailer wiring harness	105
Trunk relocation brackets	42
Rocker switches	74

Roland Sands Design

Muffler	59
Seats	50
Roll bags	44

Rox Speed FX

Pivoting handlebar risers	86
Run/turn/brake light control modules	79
Run/turn/brake light modules	83

S

S&S

Air cleaner covers	64
Air cleaners/kits	64
Pre-filter for air cleaners	64
Saddle shields	52

SADDLEBAGS & LUGGAGE 42-45

Saddlebag coolers	43
Saddlebag fasteners	43
Saddlebag filler panel light	78
Saddlebag lid bras	43
Saddlebag top trim	43
Saddlebags	45

SBS

Brake pads	98
------------	----

Scorpio

Alarms	124
--------	-----

SEATS & SISSY BARS 46-52

Seat bags	44
Seat cooling mat	52
Seat pan kits	51
Seats	46-51

Sena	
Bluetooth transmitter	36
Camera/intercom system/ accessories	27
CB helmet clamp kit	35
Charging mount for iPhone/ Smartphone/GPS	37
Freewire adapter	37
Half helmet intercom systems/accessories	31
Headsets/accessories	33
Intercom microphone kits	31
Intercom systems/ accessories	22-32, 33, 35-37
Intercoms/components	34
Portable chargers, iPhone/ Smartphone/GPS	37
Prism tube	26
Pro Sena Camera	26
RC remotes	35
Two-way radio adapters	36
Shift arms	115
Shift kits, electric	70
Shift levers	116
Shift peg extender	121
Shift pegs	117-121
Shift rods	70
Shifter peg covers	121
Shifter/footpegs	117
Shock absorbers	107-108
Show Chrome	
Antennas	41
Armrests	42
Backrests	51
Bulbs	83
Driving lights	77-78
Flags/poles	124
Luggage racks	45
Rocker switches	74
Saddlebag fasteners	43
Saddlebag lid bras	43
Shifter peg cover	121
Tank pouches	102
Tour trunk rack risers	45
Trailer hitch	105
Windshield	16
Side cover accents	104
Side-mount license plate frames	111
Sissy bar pads	51
Sissy bar side plates	52
Slip-on muffler	53, 55-61
Slipstreamer	
Fairings	16
Windshield application chart	16

Slipstreamer (CONT)	
Windshield mounting hardware	12-15
Windshields	12-16
Smartphone battery charger	37
Smartphone mount w/ charter	37
Smartphone mounts	40-41
Sound bars	39
Spark plug wires	71
Speaker grilles	103
Speaker pods	39
Speed shifter kit, electric	70
Splined footpeg adapter mounts	121
Springs, fork	107
Starter covers	74
Stator covers	67
Steering stem bearings	86
Steering stem nuts	86
Stereo accents	103
SuperTrapp	
Muffler	61
Suspension lowering kits	108
Suspension systems, front end	106
Swingarm accents	104
Swingarm covers	104
Swingarm covers, rear	104
Swingarm pivot accents	104
Switch covers, ignition	74

T	
Tail bags	45
Taillight trim	21
TANKS & OIL FILTERS	101
Tank pouches	102
Tank side scoops	101
Tappet block accent	66
Throw-over saddlebags	45
Tie-down brackets	105
Timing covers	66
Toe rest cruise pegs	119
Tour trunk rack risers	45
Trailer hitch, hidden	105
Trailer hitches	105
Trailer output harnesses	105
Trailer wiring harnesses	105
TRANSMISSION & DRIVELINE	68-70
Transmission center cover	68

Trask	
Air cleaner	65
Exhaust systems	53
Footpegs	120
Grips	89
Handlebars	85

Trask (CONT)	
Muffler	53
Trumpet horns	73
Trunk lid organizer	42
Trunk light accent	79
Trunk relocation brackets	42
Trunk relocater	42
Turn signal adapters	79
Turn signal wire adapters	82
Tuxedo ties	102

V

Vance & Hines	
Exhaust baffle	59
Exhaust systems	57-58
Fuelpak LCD	62
Muffler	57-59
Vent tube, battery	72
Video cameras	26-27
Voltage regulators	71

W

WHEELS & AXLES	122-123
Wheel bearings/seals	122
Wheel hubs	123
Wheel rims	123
Wheels	122
Wheels, laced	122
WINDSHIELDS & FAIRINGS	5-21
Windshield hardware/kits	15
Windshield lowers	7
Windshield lowers mounting hardware	7
Windshield mounting hardware	5-6, 8-15
Windshield trim	21
Windshields	5-6, 8-10, 12-16
Windshields/hardware	18
Windvest	
Windshields	16
Wire extension harness for heated grips	91
Wire harness kits, handlebar	74
Wireless intercom/ communicator adapter	37
Wiring harnesses/extensions, handlebar	74

Y

Yuasa	
Batteries	72
Battery bolts/nuts	72
Spare parts	72



We Support The Sport!®

We are the #1 resource for powersports products. We support our dealers, vendors and fans at races, rallies, special events and showcases across the country. You can find out more by checking out the nationally known brands listed below and featured in our catalogs.

DEALER POLICIES: Please visit: partsnetweb.com/DealerPolicy and [dragnetweb.com/DealersPolicy](http://dragnetweb.com/DealerPolicy)

CATALOG CONTENTS

We believe the contents and specifications of this catalog are correct. We assume no liability for errors in listings, specifications, part numbers, prices or model applications. We reserve the right to change specifications, product descriptions, product quality, pricing and application at any time without further notice and without further obligation. The reproduction of any material from this catalog is forbidden without our written approval.

iPad®, iPhone®, iPhoto®, iPod®, iPod classic®, iPod nano®, iPod shuffle®, iPod touch®, MacBook®, MacBook Air® and PowerBook® are registered trademarks of Apple Inc.

DuPont™ and Kevlar® are trademarks or registered trademarks of E.I. du Pont de Nemours and Company.

All model designations and applications used herein are determined by the manufacturer as USA-specific. Contact the individual manufacturer for additional international model information.

WARRANTIES AND GUARANTEES

We do not guarantee the items sold by us or warrant the merchantability or fitness of purpose. Manufacturers supply their own warranties and guarantees and most of them do not permit a wholesaler or distributor to make any adjustment, replace any part or accept for return or exchange any defective or unsatisfactory item. Please follow the guarantee instructions when provided by the manufacturer. Any damages arising from the design or manufacturing of any item are the sole responsibility of the manufacturer.



dragspecialties.com
inventory.dragnetweb.com

parts-unlimited.com
inventory.partsnetweb.com



A DIVISION OF LEMANS CORPORATION
PO Box 5222, Janesville, WI 53547-5222 • 608-758-1111

COPYRIGHT 2018 • LeMans Corporation • ALL RIGHTS RESERVED
These materials may not be copied or reproduced in any manner without written permission of LeMans Corporation.

2019 PARTS & ACCESSORIES For Indian Motorcycles

Indian® is a registered trademark of Indian Motorcycle International, LLC



DRAG
Specialties

PARTS
UNLIMITED

