



DV604i

QUICK START GUIDE

Multimedia DVD Receiver
featuring a 6.2" digital TFT LCD

This Quick Start Guide gives you the basics to start using your DV604i. Please visit www.dualav.com/support/manuals.pdf to download a complete owner's manual or call customer service at 1-866-382-5476 (Monday-Friday, 9AM-5PM EST).



Customer Service Toll Free: 1-866-382-5476

Safety Notes:
The DVD video display of the in-dash unit will not operate while the vehicle is moving. This is a safety feature to prevent driver distraction. In-dash DVD video functions will only operate when vehicle is in Park and the parking brake is engaged. It is illegal in most states for the driver to view video while the vehicle is in motion.

Installation

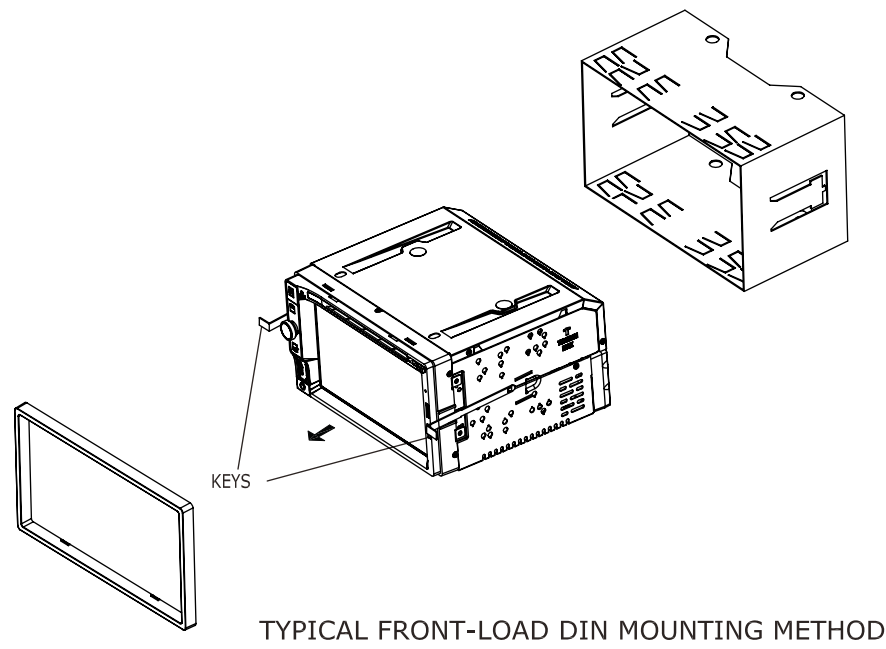

Copyright and Trademark Notes
This product incorporates copyright protection technology that is protected by method claims of certain U.S. patents and other intellectual property rights owned by Macrovision Corporation and other rights owners. Use of this copyright protection technology must be authorized by Macrovision Corporation, and is intended for home and other limited viewing uses only unless otherwise authorized by Macrovision Corporation. Reverse engineering or disassembly is prohibited. Manufactured under license from Dolby Laboratories. Dolby and the double-D symbol are trademarks of Dolby Laboratories. DVD Logo is a trademark of DVD Format/Logo Licensing Corporation registered in the U.S., Japan and other countries. SD Logo is a trademark of SD-3C, LLC. iPod and iPhone are trademarks of Apple Inc., registered in the U.S. and other countries. Dual Electronics Corporation is not affiliated with Apple, Inc. Other trademarks and trade names are those of their respective owners.

Wiring Diagram - Inputs/Outputs

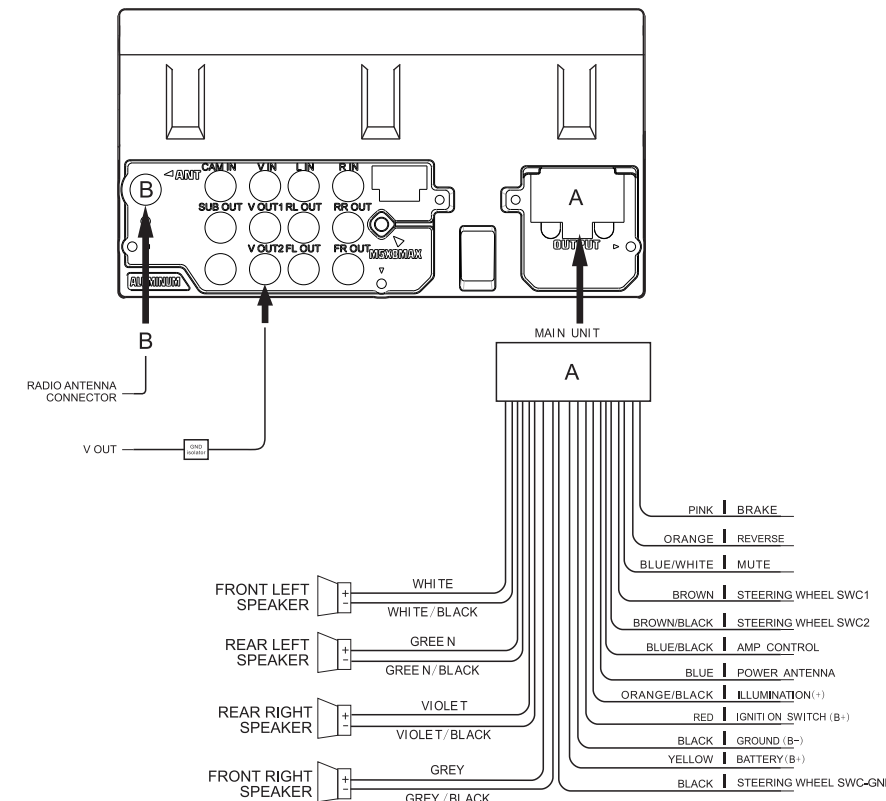

Control Locations



- | | |
|--------------------------------|----------------------|
| 1. Eject - Press to eject disc | 6. Power/Volume/Mute |
| 2. MicroSD Card | 7. Tune/Track Down |
| 3. Reset | 8. USB Slot |
| 4. Mode | 9. AV Input |
| 5. Tune/Track Up | |

Remote Control

- | | |
|------------------------|------------------------------|
| 1. Power | 15. Audio |
| 2. Mode | 16. Goto |
| 3. Play/Pause | 17. EQ/Loud |
| 4. Mute | 18. Number keys |
| 5. Title | 19. Root |
| 6. Sub Title | 20. OSD (On Screen Display) |
| 7. Setup | 21. Local/Random |
| 8. Angle | 22. Seek Down/Previous Track |
| 9. Slow | 23. AS/PS/Repeat |
| 10. Volume UP | 24. Stereo/Program |
| 11. Zoom | 25. Stop |
| 12. Select | 26. Enter |
| 13. Seek UP/Next Track | 27. Band |
| 14. Volume Down | |

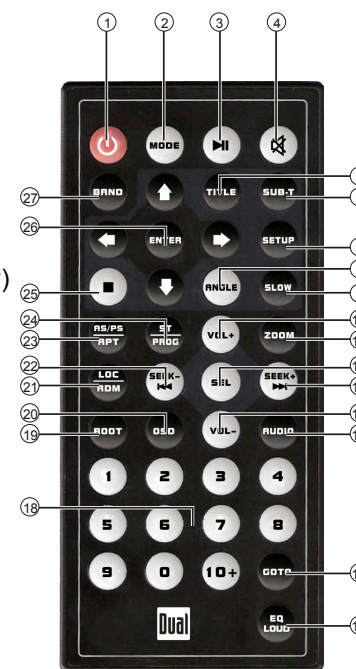

Audio Control

Tap VOL to select between Volume, Bass, Treble, Balance and Fader. You can adjust the level for each audio option by turning the rotary left and right.

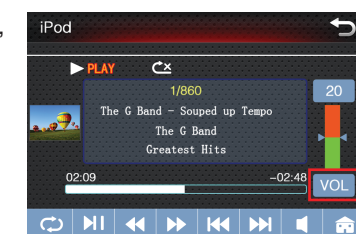

Main Menu

In the Menu mode, press the desired icon to enter the corresponding mode: Tuner, Disc, USB, iPod, microSD Card, AV Front, AV Rear, Camera or Setup.



Tuner Operation

Select the Tuner icon from the Main Menu screen or press MODE until Tuner is selected.

1. Current Mode Indicator
2. Information Display
3. Tune Up
4. Tune Down
5. Mute On/OFF
6. Setup
7. EQ(Pop/Rock/Classic/Jazz)
8. Preset Station Display
9. LOC
10. LOUD
11. AS/PS



DVD Operations

Insert a DVD in the disc slot for playback.

1. Play/Pause
2. Stop
3. Rewind
4. Fast Forward
5. Previous Track
6. Next Track
7. Volume Adjustment
8. Next Menu
9. Playback/Remaining Time
10. Language Options for Sound
11. Return to Playlists/Previous Folder
12. Return to Title Menu
13. Repeat Play
14. Language Options for Subtitle
15. Numeric Keyboard
16. Picture Zoom In/Out
17. TFT Screen Off



CD Operations

Insert a CD in the disc slot, and the unit will read the disc.

1. Play/Pause
2. Stop
3. Rewind
4. Fast Forward
5. Previous Track
6. Next Track
7. Volume Adjustment
8. Next Menu
9. Playback/Remaining Time
10. Repeat Play
11. Numeric Keyboard
12. Random Play
13. Info
14. TFT Screen Off

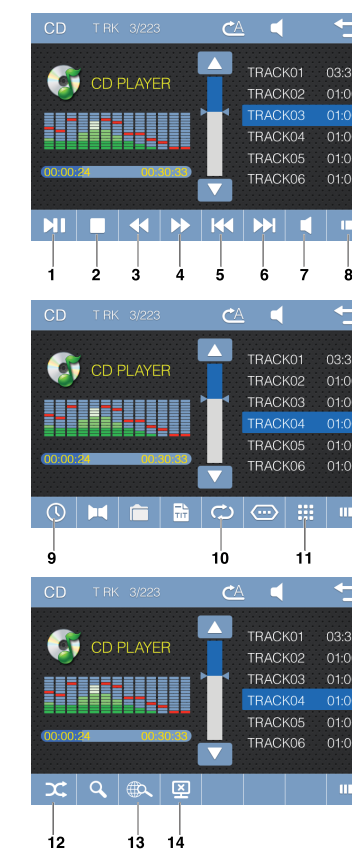

iPod® Operation

Select iPod on the Main Menu

1. Repeat
2. Play/Pause
3. Rewind
4. Fast Forward
5. Previous Track
6. Next Track
7. Volume Adjustment
8. Back to Main Menu
9. Album Art

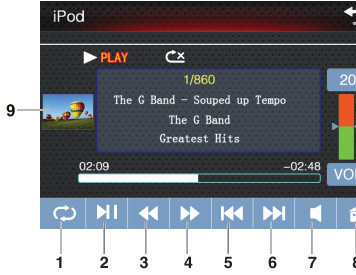

General Operation

Setup Menu

From the Main Menu screen, press Setup to enter the Setup Menu. The first 7 setup options will be displayed on the screen.

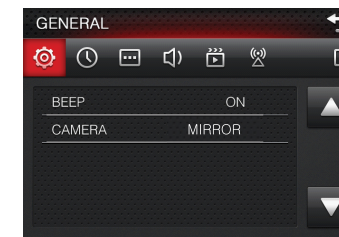

One-Year Limited Warranty

This warranty gives you specific legal rights. You may also have other rights which vary from state to state.

Dual Electronics Corp. warrants this product to the original purchaser to be free from defects in material and workmanship for a period of one year from the date of the original purchase.

Dual Electronics Corp. agrees, at our option, during the warranty period, to repair any defect in material or workmanship or to furnish an equal new, renewed or comparable product (whichever is deemed necessary) in exchange without charges, subject to verification of the defect or malfunction and proof of the date of purchase. Subsequent replacement products are warranted for the balance of the original warranty period.

Who is covered? This warranty is extended to the original retail purchaser for products purchased from an authorized Dual dealer and used in the U.S.A.

What is covered? This warranty covers all defects in material and workmanship in this product. The following are not covered: software, installation/removal costs, damage resulting from accident, misuse, abuse, neglect, product modification, improper installation, incorrect line voltage, unauthorized repair or failure to follow instructions supplied with the product, or damage occurring during return shipment of the product. Specific license conditions and copyright notices for the software can be found via www.dualav.com.

What to do?

1. Before you call for service, check the troubleshooting guide in your owner's manual. A slight adjustment of any custom controls may save you a service call.

2. If you require service during the warranty period, you must carefully pack the product (preferably in the original package) and ship it by prepaid transportation with a copy of the original receipt from the retailer to an authorized service center.

3. Please describe your problem in writing and include your name, a return UPS shipping address (P.O. Box not acceptable), and a daytime phone number with your shipment.

4. For more information and for the location of the nearest authorized service center please contact us by one of the following methods:

- Call us toll-free at 1-866-382-5476 (Monday-Friday, 9:00 a.m. to 5:00 p.m. EST)
- E-mail us at cs@dualav.com

Exclusion of Certain Damages: This warranty is exclusive and in lieu of any and all other warranties, expressed or implied, including without limitation the implied warranties of merchantability and fitness for a particular purpose and any obligation, liability, right, claim or remedy in contract or tort, whether or not arising from the company's negligence, actual or imputed. No person or representative is authorized to assume for the company any other liability in connection with the sale of this product. In no event shall the company be liable for indirect, incidental or consequential damages.