

Compact AV System

Operating Instructions



DAV-SA30

WARNING

To prevent fire or shock hazard, do not expose the unit to rain or moisture.

Do not install the appliance in a confined space, such as a bookcase or built-in cabinet.

To prevent fire, do not cover the ventilation of the apparatus with news papers, table-cloths, curtains, etc. And don't place lighted candles on the apparatus.

To prevent fire or shock hazard, do not place objects filled with liquids, such as vases, on the apparatus.



Don't throw away the battery with general house waste, dispose of it correctly as chemical waste.

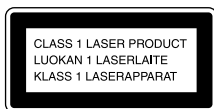

This appliance is classified as a CLASS 1 LASER product. The label is located on the rear of the unit.

Precautions

Safety

- If anything falls into the cabinet, unplug the unit and have it checked by qualified personnel before operating it any further.
- The unit is not disconnected from the AC power source (mains) as long as it is connected to the mains outlet, even if the unit itself has been turned off.
- Unplug the unit from the wall outlet if you do not intend to use it for an extended period of time. To disconnect the cord, pull it out by the plug, never by the cord.

Installing

- Allow adequate air circulation to prevent internal heat buildup.
- Do not place the unit on surfaces (rugs, blankets, etc.) or near materials (curtains, draperies) that may block the ventilation slots.
- Do not install the unit near heat sources such as radiators, or air ducts, or in a place subject to direct sunlight, excessive dust, mechanical vibration, or shock.
- Do not install the unit in an inclined position. It is designed to be operated in a horizontal position only.
- Keep the unit and discs away from equipment with strong magnets, such as microwave ovens, or large loudspeakers.
- Do not place heavy objects on the unit.

- If the unit is brought directly from a cold to a warm location, moisture may condense inside the Compact AV System and cause damage to the lenses. When you first install the unit, or when you move it from a cold to a warm location, wait for about 30 minutes before operating the unit.

Welcome!

Thank you for purchasing Sony Compact AV System. Before operating this system, please read this manual thoroughly and retain it for future reference.

Precautions

On power sources

AC power cord must be changed only at the qualified service shop.

On placement

- Place the system in a location with adequate ventilation to prevent heat build-up in the system.
- At high volume, over long periods of time, the cabinet becomes hot to the touch. This is not a malfunction. However, touching the cabinet should be avoided. Do not place the unit in a confined space where ventilation is poor as this may cause overheating.
- Do not block the ventilation slots by putting anything on the system. The system is equipped with a high power amplifier. If the ventilation slots on the top surface are blocked, the unit can overheat and malfunction.
- Do not place the system on a soft surface such as a rug that might block the ventilation holes on the bottom.
- Do not place the system in a location near heat sources, or in a place subject to direct sunlight, excessive dust, or mechanical shock.

On operation

- If the system is brought directly from a cold to a warm location, or is placed in a very damp room, moisture may condense on the lenses inside the system. Should this occur, the system may not operate properly. In this case, remove the disc and leave the system turned on for about half an hour until the moisture evaporates.
- When you move the system, take out any discs. If you don't, the disc may be damaged.
- For power saving purposes, the system can be completely turned off by the  button on the system. Though the LED remains lit for a while, the system is completely off.

On adjusting volume

Do not turn up the volume while listening to a section with very low level inputs or no audio signals. If you do, the speakers may be damaged when a peak level section is suddenly played.

On cleaning

Clean the cabinet, panel, and controls with a soft cloth slightly moistened with a mild detergent solution. Do not use any type of abrasive pad, scouring powder or solvent such as alcohol or benzene.

If you have any questions or problems concerning your system, please consult your nearest Sony dealer.

On cleaning discs

Do not use a commercially available CD/DVD cleaning disc. It may cause a malfunction.

On your TV's colour

If the speakers should cause the TV screen to have colour irregularity, turn off the TV at once then turn it on after 15 to 30 minutes. If colour irregularity should persist, place the speakers farther away from the set.

The nameplate is located on the rear of the unit.

IMPORTANT NOTICE

Caution: This system is capable of holding a still video image or on-screen display image on your television screen indefinitely. If you leave the still video image or on-screen display image displayed on your TV for an extended period of time you risk permanent damage to your television screen. Projection televisions are especially susceptible to this.

On moving the system

Before you move the system, remove the disc and turn off the power. The STANDBY indicator lights up in red and "STBY" blinks on and off in the front panel display momentarily and then stays lit. You can then unplug the mains lead. Do not unplug while "STBY" is blinking on and off.

Table of Contents







About this Manual.....	6
This System Can Play the Following	
Discs	6
Terms for discs.....	6
Notes about the Discs.....	8
Guide to the Control Menu Display	9
<hr/>	
Getting Started	
Unpacking	11
Inserting Batteries into the Remote.....	11
Step 1: Speaker System Hookup.....	12
Step 2: Aerial Hookups.....	15
Step 3: TV and Video Component	
Hookups.....	17
Speaker Setup.....	20
<hr/>	
Playing Discs	
Playing Discs	21
Resuming Playback from the Point Where	
You Stopped the Disc	22
(Resume Play)	
Using the DVD's Menu	23
Playing VIDEO CDs with PBC	
Functions	23
(PBC Playback)	
Playing an MP3 Audio Track	24
Playing JPEG Image Files	26
To rotate the current image	27
Creating Your Own Program	28
(Program Play)	
Playing in Random Order	29
(Shuffle Play)	
Playing Repeatedly	30
(Repeat Play)	
Searching for a Particular Point on a	
Disc.....	31
(Scan, Slow-motion Play, Slide	
show)	
Searching for a Title/Chapter/Track/	
Index/Album/File.....	33
Viewing Information About the Disc ...	35
<hr/>	
Sound Adjustments	
Changing the Sound	39
Enjoying Surround Sound	41
Using the Sound Effect.....	43
<hr/>	
Using Various Additional Functions	
Changing the Angles	44
Displaying the Subtitles.....	45
Locking Discs	46
(CUSTOM PARENTAL	
CONTROL, PARENTAL	
CONTROL)	
<hr/>	
Other Operations	
Controlling the TV with the Supplied	
Remote	51
Using the Video or Other Unit	52
Enjoying the Radio	53
Using the Radio Data System (RDS) ...	55
Using the Sleep Timer	55
<hr/>	
Settings and Adjustments	
Using the Setup Display	57
Setting the Display or Sound Track	
Language	58
(LANGUAGE SETUP)	
Settings for the Display	59
(SCREEN SETUP)	
Custom Settings	60
(CUSTOM SETUP)	
Settings for the Speakers	61
(SPEAKER SETUP)	

Additional Information

Troubleshooting	64
Specifications	66
Glossary	67
Index to Parts and Controls.....	70
Language code list	75
DVD Setup Menu List	76
Index	77
Quick reference for Remote Commander	Back cover

About this Manual

- The instructions in this manual describe the controls on the remote. You can also use the controls on the system if they have the same or similar names as those on the remote.
- The following symbols are used in this manual.

Symbol	Meaning
	Functions available in DVD video mode
	Functions available in VIDEO CD mode
	Functions available in CD mode
	Functions available in Super Audio CD and Audio CD mode
	Functions available for MP3* audio tracks
	Functions available for JPEG files

* MP3 (MPEG1 Audio Layer 3) is a standard format defined by ISO/MPEG which compresses audio data.

This System Can Play the Following Discs

Format of discs	Disc logo
DVD VIDEO	
Super Audio CD	 SUPER AUDIO CD
VIDEO CD	
Audio CD	

The “DVD VIDEO” logo is a trademark.

Terms for discs

- **Title**
The longest section of a picture or music feature on a DVD, movie, etc., in video software, or the entire album in audio software.
- **Chapter**
Section of a picture or a music piece that are smaller than titles. A title is composed of several chapters. Depending on the disc, no chapters may be recorded.
- **Album**
Section of a music piece or an image on a data CD containing MP3 audio tracks or JPEG files.
- **Track**
Section of a picture or a music piece on a VIDEO CD, Super Audio CD, CD, or MP3.
- **Index (Super Audio CD, CD) / Video Index (VIDEO CD)**
A number that divides a track into sections to easily locate the point you want on a VIDEO CD or Super Audio CD. Depending on the disc, no indexes may be recorded.
- **Scene**
On a VIDEO CD with PBC functions (page 23), the menu screens, moving pictures and still pictures are divided into sections called “scenes.”
- **File**
Section of a picture on a data CD containing JPEG image files.

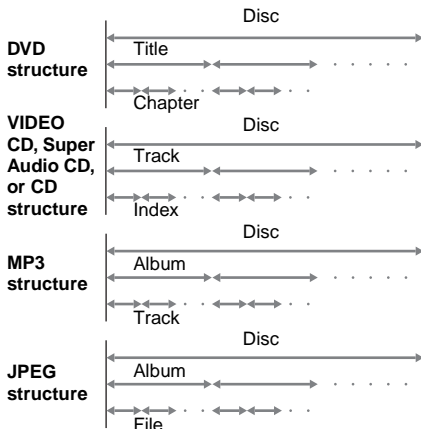

Note on PBC (Playback Control) (VIDEO CDs)

This system conforms to Ver. 1.1 and Ver. 2.0 of VIDEO CD standards. You can enjoy two kinds of playback depending on the disc type.

Disc type	You can
VIDEO CDs without PBC functions (Ver. 1.1 discs)	Enjoy video playback (moving pictures) as well as music.
VIDEO CDs with PBC functions (Ver. 2.0 discs)	Play interactive software using menu screens displayed on the TV screen (PBC Playback), in addition to the video playback functions of Ver. 1.1 discs. Moreover, you can play high-resolution still pictures, if they are included on the disc.

About Multi Session CD

- This system can play Multi Session CDs when an MP3 audio track is contained in the first session. Any subsequent MP3 audio tracks recorded in later sessions can also be played back.
- This system can play Multi Session CDs when a JPEG image file is contained in the first session. Any subsequent JPEG image files recorded in later sessions can also be played back.
- If audio tracks and images in music CD format or video CD format are recorded in the first session, only the first session will be played back.

Region code

Your system has a region code printed on the back of the unit and will only play DVDs labelled with the same region code.

DVDs labelled  will also play on this system. If you try to play any other DVD, the message "Playback prohibited by area limitations." will appear on the TV screen. Depending on the DVD, no region code indication may be given even though playing the DVD is prohibited by area restrictions.

Examples of discs that the system cannot play

The system cannot play the following discs:

- CD-ROMs (except for extension ".MP3," ".JPG," or ".JPEG")
 - CD-Rs/CD-RWs other than those recorded in the following formats:
 - music CD format
 - video CD format
 - MP3/JPEG format that conforms to ISO9660* Level 1/Level 2, or its extended format, Joliet
 - Data part of CD-Extras
 - DVD-ROMs
 - DVD Audio discs
- * A logical format of files and folders on CD-ROMs, defined by ISO (International Standard Organization)

Do not load the following discs:

- A DVD with a different region code (page 7, 68).
- A disc that is neither standard nor circular (e.g., card, heart, or star shape).
- A disc with paper or stickers on it.
- A disc that has adhesive or cellophane tape still left on it.

Notes about CD-R/CD-RW/DVD-R/DVD-RW (Video mode)

In some cases, CD-R/CD-RW/DVD-R/DVD-RW (Video mode) cannot be played on this player due to the recording quality or physical condition of the disc,

or the characteristics of the recording device and authoring software.

The disc will not play if it has not been correctly finalized. For more information, see the operating instructions for the recording device.

Note that discs created in the Packet Write format cannot be played.

Music discs encoded with copyright protection technologies

This product is designed to play back discs that conform to the Compact Disc (CD) standard.

Recently, various music discs encoded with copyright protection technologies are marketed by some record companies. Please be aware that among those discs, there are some that do not conform to the CD standard and may not be playable by this product.

Note on playback operations of DVDs and VIDEO CDs

Some playback operations of DVDs and VIDEO CDs may be intentionally set by software producers. Since this system plays DVDs and VIDEO CDs according to the disc contents the software producers designed, some playback features may not be available. Also, refer to the instructions supplied with the DVDs or VIDEO CDs.

Copyrights

This product incorporates copyright protection technology that is protected by method claims of certain U.S. patents, other intellectual property rights owned by Macrovision Corporation, and other rights owners. Use of this copyright protection technology must be authorized by Macrovision Corporation, and is intended for home and other limited viewing uses only unless otherwise authorized by Macrovision Corporation. Reverse engineering or disassembly is prohibited.

This system incorporates with Dolby* Digital and Dolby Pro Logic (II) adaptive matrix surround decoder and the DTS** Digital Surround System.

* Manufactured under license from Dolby Laboratories.
“Dolby”, “Pro Logic” and the double-D symbol are trademarks of Dolby Laboratories.

** Manufactured under license from Digital Theater Systems, Inc.

“DTS” and “DTS Digital Surround” are trademarks of Digital Theater Systems, Inc.

Notes about the Discs

On handling discs

- To keep the disc clean, handle the disc by its edge. Do not touch the surface.
- Do not stick paper or tape on the disc.



- Do not expose the disc to direct sunlight or heat sources such as hot air ducts, or leave it in a car parked in direct sunlight as the temperature may rise considerably inside the car.
- After playing, store the disc in its case.

On cleaning

- Before playing, clean the disc with a cleaning cloth.
Wipe the disc from the centre out.



- Do not use solvents such as benzine, thinner, commercially available cleaners, or anti-static spray intended for vinyl LPs.

This system can only play back a standard circular disc. Using neither standard nor circular discs (e.g., card, heart, or star shape) may cause a malfunction.







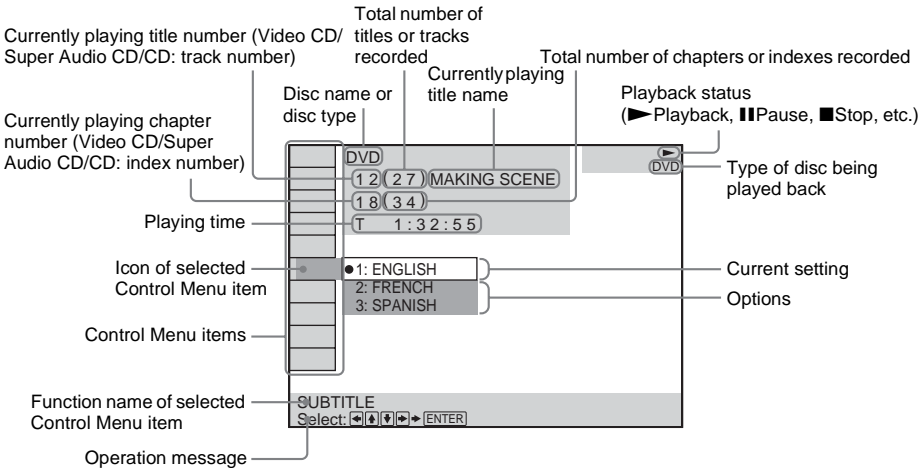



Do not use a disc that has a commercially available accessory attached, such as a label or ring.







Guide to the Control Menu Display

Use the Control Menu to select a function that you'd like to use. The Control Menu display appears when the DVD DISPLAY button is pressed. For details, refer to the page in parentheses.



List of Control Menu Items

	DISC	Displays the disc name or the disc type inserted into the system.
	TITLE (DVD only) (page 33)/ SCENE (only VIDEO CD in PBC playback) / TRACK (VIDEO CD only) (page 33)	Selects the title (DVD), or the track (VIDEO CD) to be played. Displays the scene (VIDEO CD in PBC playback).
	CHAPTER (DVD only) (page 34)/ INDEX (VIDEO CD only) (page 34)	Selects the chapter (DVD) or the index (VIDEO CD) to be played.
	ALBUM (MP3 only) (page 25, 33)	Selects the album (MP3) to be played.
	TRACK (Super Audio CD/CD/ MP3 only) (page 25, 33)	Selects the track (Super Audio CD/CD/MP3) to be played.
	INDEX (Super Audio CD/CD only) (page 34)	Displays the index and selects the index (Super Audio CD) to be played.
	TIME (page 34)	Checks the elapsed time and the remaining playback time. Inputs the time code for picture and music searching.
	AUDIO (DVD/VIDEO CD/Super Audio CD/CD/MP3 only) (page 39)	Changes the audio setting.
	SUBTITLE (DVD only) (page 45)	Displays the subtitles. Changes the subtitle language.
	ALBUM (JPEG only) (page 26)	Selects the album (JPEG) to be played.

	FILE (JPEG only) (page 26)	Selects the file (JPEG) to be played
	DATE (JPEG only) (page 38)	Displays the date information.
	ANGLE (DVD only) (page 44)	Changes the angle.
	PLAYMODE (VIDEO CD/Super Audio CD/CD/MP3/JPEG only) (page 30)	Selects the play mode.
	REPEAT (page 30)	Plays the entire disc (all titles/all tracks), one title/chapter/track/album, or contents of program repeatedly.
	CUSTOM PARENTAL CONTROL (page 46)	Sets the disc to prohibit playing.

Tips

- Each time you press DVD DISPLAY, the Control Menu display changes as follows:

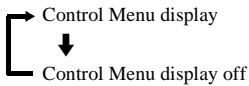

The Control Menu items are different depending on the disc.

- The Control Menu icon indicator lights up in green  →  unless you set the REPEAT setting to “OFF.”
- The “ANGLE” indicator lights up in green only when multiple angles are recorded on the disc.

Check that you have the following items:

- Speakers (5)
- Subwoofer (1)
- AM loop aerial (1)
- FM wire aerial (1)
- Speaker cords (5m × 4, 15m × 2)
- Remote Commander (remote) (1)
- R6 (size AA) batteries (2)
- Foot pads (20)
- Speakers-connection and Installation (card) (1)

Inserting Batteries into the Remote

You can control the system using the supplied remote. Insert two R6 (size AA) batteries by matching the ⊕ and ⊖ ends on the batteries to the markings inside the compartment. When using the remote, point it at the remote sensor  on the system.

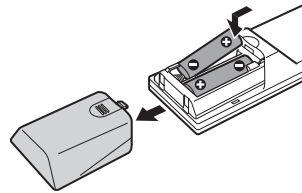

Notes

- Do not leave the remote in an extremely hot or humid place.
- Do not use a new battery with an old one.
- Do not drop any foreign object into the remote casing, particularly when replacing the batteries.
- Do not expose the remote sensor to direct light from the sun or lighting apparatus. Doing so may cause a malfunction.
- If you do not use the remote for an extended period of time, remove the batteries to avoid possible damage from battery leakage and corrosion.

Using the Remote

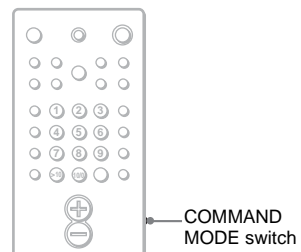

When you use the system, ensure that you have the COMMAND MODE switch set to SYSTEM. When setting to TV, you can control the TV (page 51).

Step 1: Speaker System Hookup

Connect the supplied speaker system using the supplied speaker cords by matching the colours of the jacks to those of the cords. Do not connect any speakers other than those supplied with this system. To obtain the best possible surround sound, specify the speaker parameters (distance, level, etc.) on page 20.

Required cords

Speaker cords

The connector and the colour tube of the speaker cords are the same colour as the label of the jacks to be connected.

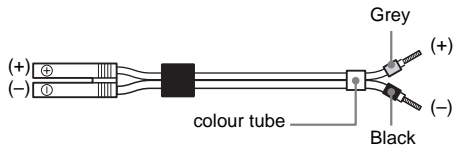

Terminals for connecting the speakers

Connect the	To the
Front speakers	SPEAKER FRONT L (white) and R (red) jacks
Surround speakers	SPEAKER SURR L (blue) and R (grey) jacks
Center speaker	SPEAKER CENTER (green) jack
Subwoofer	SPEAKER WOOFER (purple) jack

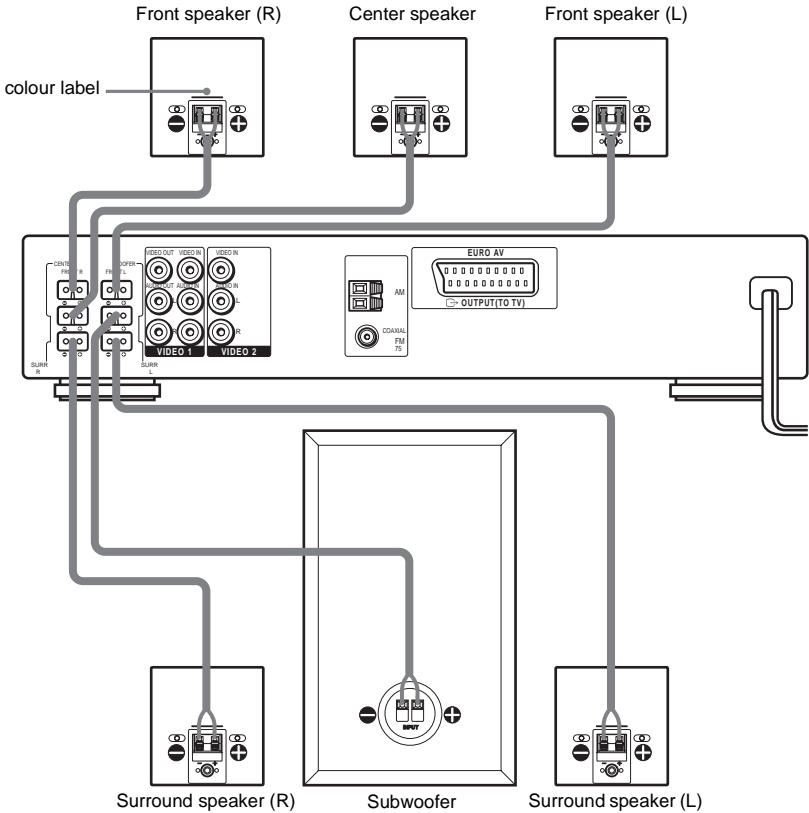

Note on placing speakers

Use caution when placing the subwoofer or a speaker stand (not supplied) that is attached with the front/surround speakers on a specially treated (waxed, oiled, polished, etc.) floor, as staining or discoloration may result.

To avoid short-circuiting the speakers

Short-circuiting of the speakers may damage the system. To prevent this, be sure to follow these precautions when connecting the speakers. Make sure the bare wire of each speaker cord does not touch another speaker jack or the bare wire of another speaker cord.

Examples of poor conditions of the speaker cord

Stripped speaker cord is touching another speaker terminal.

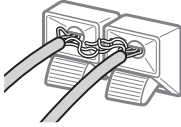

Stripped cords are touching each other due to excessive removal of insulation.

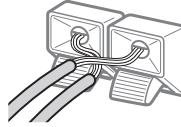

After connecting all the components, speakers, and mains lead, output a test tone to check that all the speakers are connected correctly. For details on outputting a test tone, see page 62.

If no sound is heard from a speaker while outputting a test tone, or a test tone is output from a speaker other than the one currently displayed in the front panel display, the speaker may be short-circuited. If this happens, check the speaker connection again.

Note

Be sure to match the speaker cord to the appropriate terminal on the components: \oplus to \oplus , and \ominus to \ominus . If the cords are reversed, the sound will lack bass and may be distorted.

Step 2: Aerial Hookups

Connect the supplied AM/FM aerials for listening to the radio.

Terminals for connecting the aerials

Connect the	To the
AM loop aerial	AM terminals
FM wire aerial	FM 75Ω COAXIAL jack

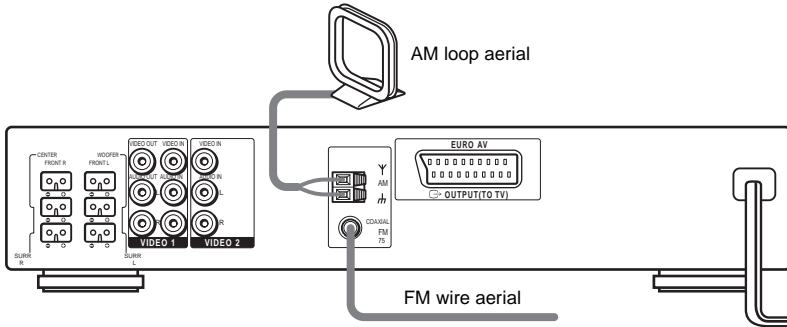

Notes

- To prevent noise pickup, keep the AM loop aerial away from the system and other components.
- Be sure to fully extend the FM wire aerial.
- After connecting the FM wire aerial, keep it as horizontal as possible.
- When you connect the supplied AM loop aerial, connect the black cord (B) to the h terminal, and the white cord (A) to the other terminal.

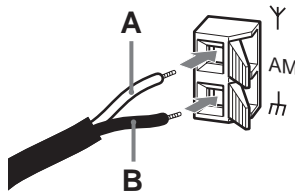

- If you connect the system to an outdoor aerial, ground it to protect against lightning. To prevent a gas explosion, do not connect the earth wire to a gas pipe.

Tip

If you have poor FM reception, use a 75-ohms coaxial cable (not supplied) to connect the system to an outdoor FM aerial as shown below.

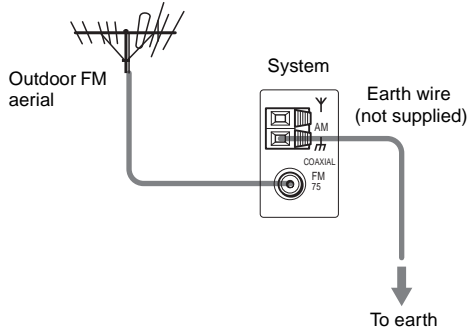

Step 3: TV and Video Component Hookups

Required cords

SCART (EURO AV) cord for connecting a TV (not supplied)



Audio/video cords (not supplied)

When connecting a cord, be sure to match the colour-coded sleeves to the appropriate jacks on the components.

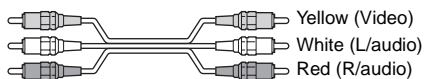

Terminals for connecting video components

Connect the	To the
TV	↪ EURO AV OUTPUT (TO TV) jack
VCR	VIDEO 1 jacks
Digital satellite receiver	VIDEO 2 jacks

Connecting the system to a TV

Connect the system to your TV using the SCART (EURO AV) cord. Be sure to connect the SCART (EURO AV) cord to the ↪ EURO AV OUTPUT (TO TV) jack on the system.

When you connect using the SCART (EURO AV) cord, check that the TV conforms to S video or RGB signals. If the TV conforms to S video, change the input mode of the TV to RGB signals. Refer to the operating instructions supplied with the TV to be connected.

Note

When recording on another unit connected to the VIDEO 1 AUDIO OUT jacks, do not change the Sound Field (page 41) or connect/disconnect headphones.

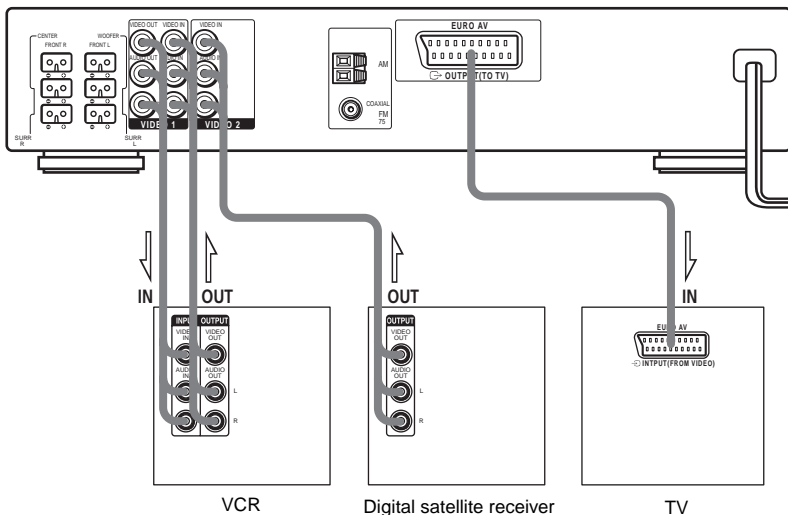

Notes

- Make connections securely to prevent unwanted noise.
- Refer to the instructions supplied with the TV.
- The system cannot output component video signals.
- The system cannot output an audio signal to the connected TV. Only the audio signal of the TV is output from the system speakers.

When connecting to a standard 4:3 screen TV

Depending on the disc, the image may not fit your TV screen.

If you want to change the aspect ratio, please refer to page 59.

Connecting a VCR to the system

Connect the VCR to the VIDEO IN and AUDIO IN L/R jacks of the system. Be sure to make the connections securely to avoid hum and noise. If using VIDEO1 distorts the sound, reconnect the VCR to VIDEO2.

Notes

- Do not connect the system to a VCR. If you pass video signals from the system via a VCR, you may not receive a clear image on the TV screen.
- If you cannot view the picture from a VCR through this system which is connected to a TV with RGB component jacks, set \rightarrow to \rightarrow (Audio/Video) on your TV. If you select \rightarrow (RGB), the TV cannot receive the signal from the VCR.
- If you want to use your VCR's SmartLink function, connect the VCR to your TV's SmartLink jack.
- The SmartLink function may not work properly if your VCR is connected to your TV via this system.
- If you connect the system to your TV via the SCART (EURO AV) jacks, the TV's input source synchronizes with the system automatically when you start playback or press any button except for \mathbb{I}/\mathbb{O} on the system or \mathbb{I}/\mathbb{O} on the remote. In this case, select the COMMAND MODE switch to TV.
- The system does not output S video signals.
- When you select "DVD" by pressing FUNCTION (page 52), the video signal and RGB signal are not output from the VIDEO IN jacks. Also, the system cannot output the component video signal.
- When you select VIDEO 1 or VIDEO 2 by pressing FUNCTION (page 52), the audio signal from the AUDIO L/R jack is output to the connected speakers. The audio signal is not output from the \rightarrow EURO AV OUTPUT (TO TV) jack.

Connecting the Mains Leads

Before connecting the mains leads of this system to a wall outlet, connect the speakers to the system (see page 12).

Speaker Setup

For the best possible surround sound, all the speakers other than the subwoofer should be the same distance from the listening position (A). However, this system allows you to place the center speaker up to 1.6 metres closer (B) and the surround speakers up to 4.6 metres closer (C) to the listening position.

The front speakers can be placed from 1.0 to 7.0 metres (A) from the listening position.

Place speakers as illustrated below

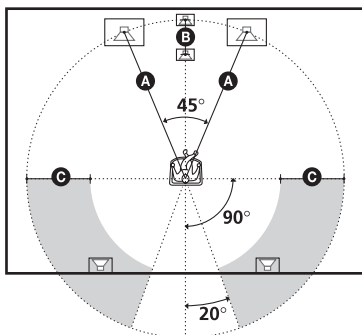

Note

Do not place the center and surround speakers farther away from the listening position than the front speakers.

About magnetically shielded speakers (to prevent colour irregularity occurring on the TV screen)

The subwoofer in this system is magnetically shielded to prevent magnetic leakage. However, some leakage may occur, as a high-strength magnet is employed. If the subwoofer is used with a CRT-based TV or projector, install the subwoofer at least 0.3 metre from the TV set. If it is installed too close, colour irregularity may occur on the screen. If colour irregularity occurs, turn off the TV set once, then turn it on after 15 to 30 minutes. If colour irregularity occurs again, place the subwoofer farther away from the TV set. If colour irregularity still occurs after performing the above, make sure that no magnetic object is placed near the subwoofer. Colour irregularity may occur as a result of interaction between the subwoofer and the magnetic object.

Examples of possible sources of magnetic interference include: magnetic latches on a TV stand, etc., healthcare devices, toys, etc.

Specifying the speaker parameters

To obtain the best possible surround sound, first specify the distance of the speakers from your listening position, then set the level and balance. Use the test tone to adjust the speaker level and balance to the same level.

Select "SPEAKER SETUP" in the setup display. For details, see "Setting for the Speakers" (page 61).

Playing Discs

Playing Discs

DVD

VIDEO CD

SA-CD CD

MP3

JPEG

Depending on the DVD or VIDEO CD, some operations may be different or restricted. Refer to the operation details supplied with your disc.

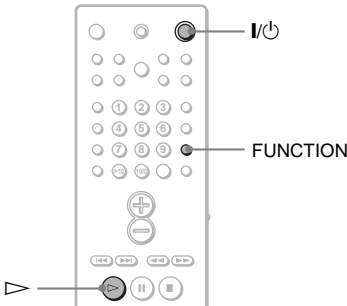
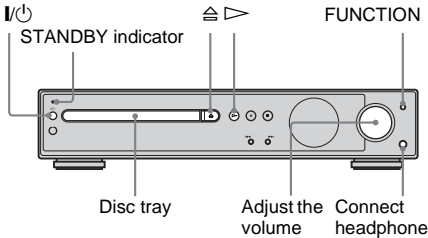

- 1 Turn on your TV.**
- 2 Switch the input selector on the TV to this system.**
- 3 Press I/⏻ on the system.**

The system turns on.
Unless the mode of the system is set to "DVD," press FUNCTION to select "DVD."
- 4 Press ⏪ on the system and place a disc with the label side up on the disc tray.**

Press ⏪ again to close the disc tray.

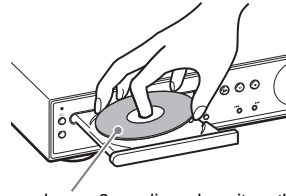

When you play an 8 cm disc, place it on the inner circle of the tray.

5 Press ▷.

The system starts playback (continuous play).
Adjust the volume on the system.

After following Step 5

Depending on the disc, a menu may appear on the TV screen. You can play the disc interactively by following the instructions on the menu. (DVD: page 23), (VIDEO CD: page 23).

To remove the disc

Press ⏪ on the system. "OPEN" appears in the front panel display. Remove the disc after disc tray slides out from the system.

To turn on the system

Press I/⏻ on the remote or press I/⏻ on the system. The system turns on.

To turn off the system

Press I/⏻ on the remote or press I/⏻ on the system. The system enters standby mode and the STANDBY indicator lights up in red.

In standby mode, you can reduce the power consumption to minimum (Power Saving mode) and save energy in standby mode.

Additional operations

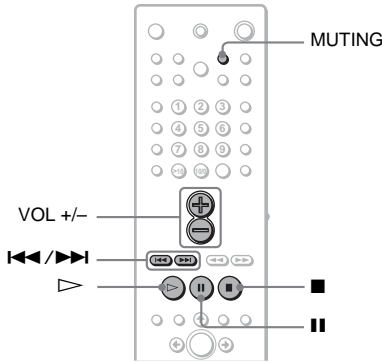

To	Press
Stop	■
Pause*	⏸
Resume play after pause	⏸ or ▷
Go to the next chapter, track, scene, or file in continuous play mode	▶▶
Go back to the preceding chapter, track, scene, or file in continuous play mode	◀◀
Mute the sound	MUTING. To cancel muting, press it again or VOL + to adjust the sound volume.

* You cannot pause during JPEG playback.

Note

If DVD playback is paused for approximately one hour, the system automatically turns off.

Tip

If a DVD has more than two titles, you cannot go to the next title or go back to the preceding title by pressing ◀◀ or ▶▶. These buttons work only within a single title. If you want to go to the next title or go back to preceding title, press DVD TOP MENU or DVD MENU and then select the title you want to go to from the control menu.

Resuming Playback from the Point Where You Stopped the Disc

(Resume Play)



When you stop the disc, the system remembers the point where you pressed ■ and “RESUME” appears in the front panel display. As long as you do not remove the disc, Resume Play will work even if the system enters standby mode by pressing I/⏻.

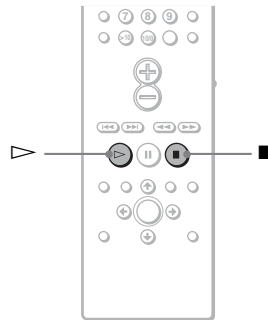

1 While playing a disc, press ■ to stop playback.

“RESUME” appears in the front panel display, so you can restart the disc from the point where you stopped the disc.

If “RESUME” does not appear, Resume Play is not available.

2 Press ▷.

The system starts playback from the point where you stopped the disc in Step 1.

Notes

- Depending on where you stopped the disc, the system may not resume playback from exactly the same point.
- The point where you stopped playing is cleared when:
 - you change the play mode.
 - you change the setting on the Setup Menu.

Tip

To play from the beginning of the disc, press ■ twice, then press ▷.

Using the DVD's Menu

DVD

A DVD is divided into main sections, which make up a picture or music feature. These sections are called "titles." When you play a DVD which contains several titles, you can select the title you want using DVD TOP MENU/ALBUM-.

When you play DVDs that allow you to select items such as the language for the subtitles and the language for the sound, select these items using DVD MENU/ALBUM+.

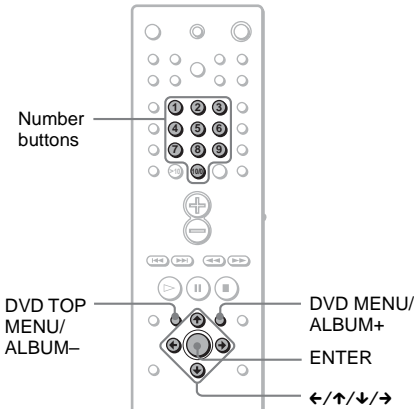

- 1 Press DVD TOP MENU/ALBUM- or DVD MENU/ALBUM+.**
The disc's menu appears on the TV screen. The contents of the menu vary from disc to disc.
- 2 Press </>/</>/</> or the number buttons to select the item you want to play or change.**
- 3 Press ENTER.**

Note

If the DVD top menu or a DVD menu is displayed during DVD playback for approximately one hour, the system automatically turns off.

Playing VIDEO CDs with PBC Functions

(PBC Playback)

VIDEO CD

With PBC (Playback Control) functions, you can enjoy simple interactive operations, search functions, and other such operations. PBC playback allows you to play VIDEO CDs interactively by following the menu on the TV screen.

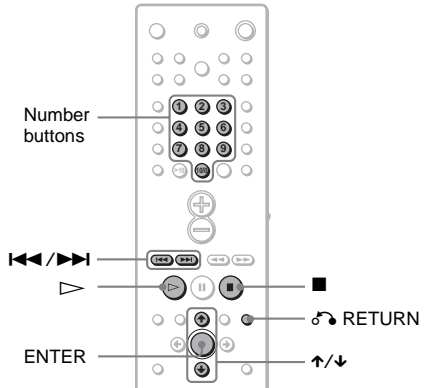

- 1 Start playing a VIDEO CD with PBC functions.**
The menu for your selection appears.
- 2 Select the item number you want by pressing </> or the number buttons.**
- 3 Press ENTER.**
- 4 Follow the instructions in the menu for interactive operations.**
Refer to the operation details supplied with the disc, as the operating procedure may differ according to the VIDEO CD.

To go back to the menu

Press RETURN.

Notes

- Depending on the VIDEO CD, the menu does not appear in Step 1.
- Depending on the VIDEO CD, “Press ENTER” in Step 3 may appear as “Press SELECT” in the instructions supplied with the disc. In this case, press \triangleright .

Tip

To play without using PBC, press \lll/\ggg or the number buttons while the system is stopped to select a track, then press \triangleright or ENTER.

“Play without PBC” appears on the TV screen and the system starts continuous play. You cannot play still pictures such as a menu. To return to PBC playback, press \blacksquare twice, then press \triangleright .

Playing an MP3 Audio Track

MP3

You can play MP3 audio tracks on CD-ROMs, CD-Rs, or CD-RWs. However, the discs must be recorded according to ISO9660 level 1, level 2, or Joliet format for the system to recognize the tracks. You can also play discs recorded in Multi Session. See the instructions of the CD-R/RW device or recording software (not supplied) for details on the recording format.

1 Load a data disc recorded in MP3 into the system.

2 Press \triangleright .

The system starts to play the first MP3 audio track in the first album on the disc.

Notes

- The system can play MP3 (MPEG1 Audio Layer3) audio. The system cannot play audio tracks in MP3PRO format.
- This system can play Multi Session CDs when an MP3 audio track is located in the first session. Any subsequent MP3 audio tracks, recorded in the later sessions, can also be played back.
- Maximum number of albums on a disc: 99 (The maximum number of MP3 audio tracks that can be contained on an album is 250.)
- An album that does not include an MP3 audio track is skipped.
- If you put the extension “.MP3” to data not in MP3 format, the system cannot recognize the data properly and will generate a loud noise which could damage your speaker system.
- When the system cannot play MP3, remove the disc and select “CUSTOM SETUP” from the setup items. Then select “DATA CD PRIORITY” and set to “MP3” (page 61) and insert the disc again.
- The system can play to a depth of 8 directories, including a ROOT directory.

Selecting an album and track

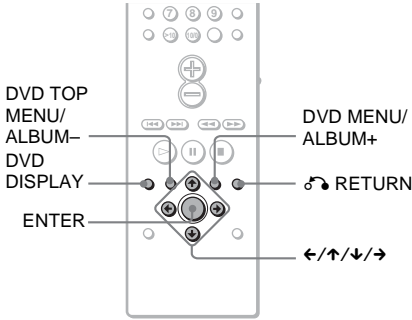

1 Press DVD DISPLAY.

The Control Menu and disc name of MP3 data disc appear.

2 Press ↑/↓ to select (ALBUM) then press ENTER or →.

The list of albums contained in the disc appears.

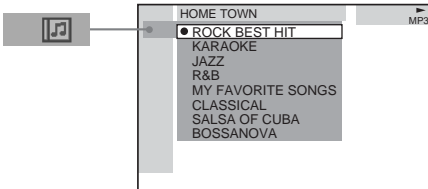

3 Select an album you want to play using ↑/↓ and press ENTER.

4 Select (TRACK) using ↑/↓ and press ENTER.

The list of tracks contained in the current album appears.

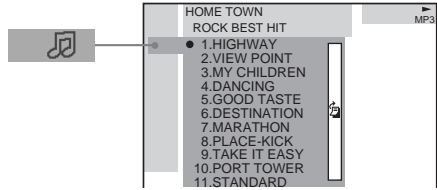

When the list of all tracks or albums cannot be displayed on the window, the jump bar appears. Press → to select the jump bar icon, and then scroll the jump bar to display the rest of the list using ↑/↓. Press ← or RETURN to return to the track or the album list.

5 Select a track using ↑/↓ and press ENTER.

The selected track starts playing.

To return to the previous display
Press RETURN or ←.

To turn off the display
Press DVD DISPLAY.

Notes

- Only the letters in the alphabet and numbers can be used for album or track names. Anything else is displayed as “ ”.
- If the MP3 file you play back has an ID3 tag, the ID3 tag information is displayed as a track name.
- ID3 tag applies only to version 1.

Tip

When an MP3 data disc is inserted, you can select an album using the DVD MENU/ALBUM+ or DVD TOP MENU/ALBUM- on the remote.

Playing JPEG Image Files

JPEG

You can play JPEG image files on CD-ROMs, CD-Rs, or CD-RWs. However, the discs must be recorded according to ISO9660 level 1, level 2 or Joliet format for the system to recognize the files. You can also play discs recorded in Multi Session. See the instructions of the CD-R/RW device or recording software (not supplied) for details on the recording format.

1 Load a data disc recorded in JPEG into the system.

2 Press \blacktriangleright .

The system starts to play the first JPEG image file in the first album on the disc.

Notes

- The system can play the extension “.JPG” or “.JPEG.”
- Some CD-Rs or CD-RWs cannot be played on this system depending on file format.
- The system can play to a depth of 8 directories, including a ROOT directory.

Selecting an album and file

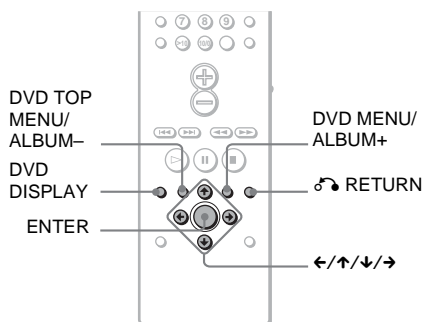

1 Press DVD DISPLAY.

The Control Menu and disc name of JPEG data disc appears.

2 Press \uparrow/\downarrow to select  (ALBUM) then press ENTER or \rightarrow .

The list of albums contained in the disc appears.

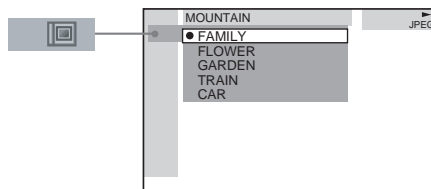

3 Select an album you want to play using \uparrow/\downarrow and press ENTER.

4 Select  (FILE) using \uparrow/\downarrow and press ENTER.

The list of files contained in the current album appears.

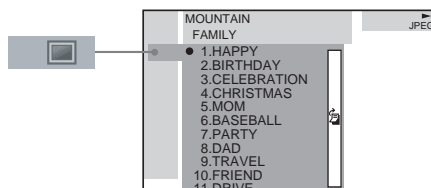

When the list of all files or albums cannot be displayed on the window, the jump bar appears. Press \rightarrow to select the jump bar icon, and then scroll the jump bar to display the rest of the list using \uparrow/\downarrow . Press \leftarrow or \curvearrowright RETURN to return to the file or the album list.

5 Select a file using \uparrow/\downarrow and press ENTER.

The selected file starts playing.

To return the previous display Press \curvearrowright RETURN or \leftarrow .

To turn off the display Press DVD DISPLAY.

Notes

- Only the letters in the alphabet and numbers can be used for album or file names. Anything else is displayed as “ ”.
- Maximum number of albums on a disc: 99 (The maximum number of JPEG image files that can be contained on an album is 250.)

Tip

When a JPEG data disc is inserted, you can select an album using the DVD MENU/ALBUM+ or DVD TOP MENU/ALBUM- on the remote.

To rotate the current image

JPEG

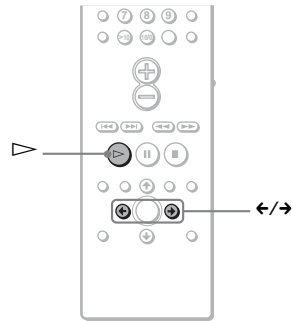

Rotate the current image using ↔

Each time you press ▶, the image turns clockwise by 90°.

Each time you press ◀, the image turns counterclockwise by 90°.

Note

You cannot rotate the image during Slide show. Press ▶ to return to normal play before this operation.

Creating Your Own Program

(Program Play)



You can play the contents of a disc in the order you want by arranging the order of the tracks on the disc to create your own program. You can program up to 25 tracks.

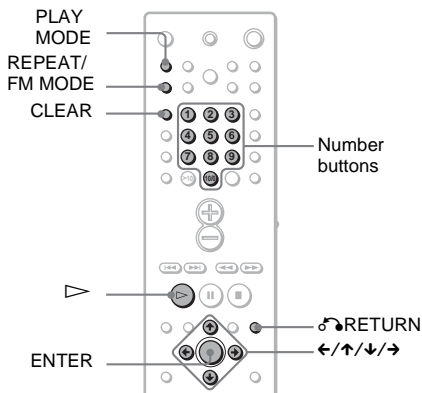

- 1 In stop mode, press PLAY MODE repeatedly until "PGM" appears in the front panel display.**

The program menu appears on the TV screen.

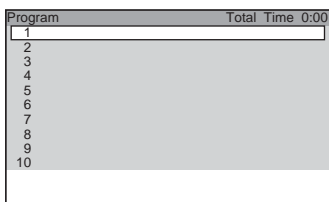

- 2 Press →.**

The cursor moves to the track (in this case, "1"). Before programming the MP3 tracks, it is required to select the album.

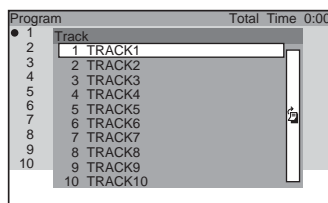

When the list of all tracks or albums cannot be displayed on the window, the jump bar appears. Press → to select the jump bar icon, and then scroll the jump bar to display the rest of the list using ↑/↓. Press ← or ⏪ RETURN to return to the track or the album list.

- 3 Select the track you want to program.**

For example, select track "7."

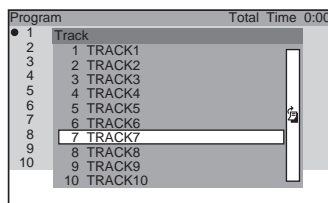

- 4 Press ↑/↓ or the number buttons to select "7" then press ENTER.**

Total time of the programmed tracks (except MP3)

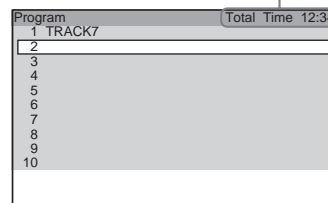

- 5 To program other tracks, repeat Steps 2 to 4.**

The programmed tracks are displayed in the selected order.

6 Press \blacktriangleright to start Program Play.

Program Play begins.

When the program ends, you can restart the same program again by pressing \blacktriangleright .

Other Operations

To	Do this
Return to normal play	Press CLEAR during playback.
Turn off the program menu	In stop mode, press PLAY MODE to turn off the program menu.
Cancel the programmed order	Press CLEAR in Step 5, and the last program is cancelled one by one.

Notes

- This Program Play function is not available for DVDs and JPEG.
- When you program MP3 tracks, "--:--" is displayed as the total time of the programmed tracks.

Tip

You can perform Repeat Play of the programmed tracks. Press REPEAT/FM MODE, or set "REPEAT" to "ALL" in the Control Menu display during Program Play (page 30).

Playing in Random Order

(Shuffle Play)



You can have the system "shuffle" tracks and play them in random order. Subsequent "shuffling" will produce a different playing order.

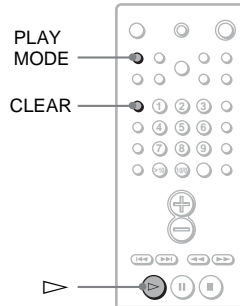

- 1 In stop mode, press PLAY MODE repeatedly until "SHUF" appears in the front panel display.**

When you play an MP3 disc, you can play all tracks in albums in a random order.

For details on playing album shuffle, see page 30.

- 2 Press \blacktriangleright .**

To return to normal play

In stop mode, press PLAY MODE three times to cancel SHUFFLE or twice to cancel SHUFFLE (ALBUM). Or during playback, press CLEAR to return to normal play.

Setting the shuffle mode on the Control Menu

You can select either normal shuffle or album shuffle (MP3 only).

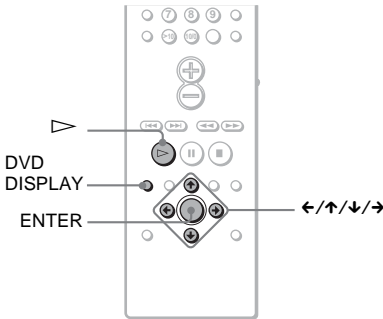

- 1 Press DVD DISPLAY.**
The Control Menu appears.
- 2 Press \uparrow/\downarrow to select **PLAY MODE** (PLAY MODE), then press ENTER or \rightarrow .**

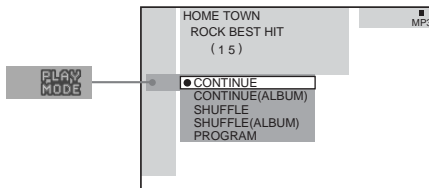

- 3 Select SHUFFLE or SHUFFLE (ALBUM) using \uparrow/\downarrow and press ENTER.**

SHUFFLE: Play tracks on the disc in random order.

SHUFFLE (ALBUM): Play tracks from selected album in random order.

- 4 Press \triangleright .**

The selected Shuffle Play begins.

Note

Shuffle Play is cancelled when you eject the disc. The play mode changes in the following sequence:

SHUFFLE \rightarrow CONTINUE

SHUFFLE (ALBUM) \rightarrow CONTINUE (ALBUM)

Playing Repeatedly

(Repeat Play)



You can play all the titles/tracks/files or a single title/chapter/track on a disc.

In Shuffle or Program Play mode, the system repeats tracks in the shuffled or programmed order.

You cannot perform Repeat Play during PBC playback of VIDEO CDs (page 23).

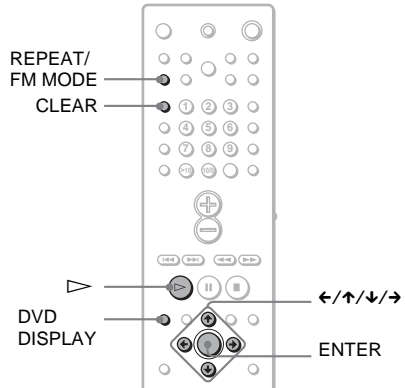

- 1 Press DVD DISPLAY.**
The Control Menu appears.
- 2 Press \uparrow/\downarrow to select **REPEAT** (REPEAT), then press ENTER.**

If you do not select "OFF," the indicator of "REPEAT" lights in green.

- 3 Select the Repeat Play setting, then press ENTER.**

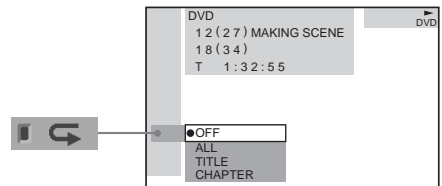

■ **When playing a DVD**

- **OFF**: does not play repeatedly.
- **ALL**: repeats all the titles.
- **TITLE**: repeats the current title on a disc.
- **CHAPTER**: repeats the current chapter.

■ **When playing a VIDEO CD/Super Audio CD/CD/MP3 and when Program Play is set to OFF**

- **OFF**: does not play repeatedly.
- **ALL**: repeats all the tracks on the disc, or repeats the current album (only when **CONTINUE (ALBUM)** or **SHUFFLE (ALBUM)** in the play mode is selected).
- **TRACK**: repeats the current track.

■ **When playing a JPEG**

- **OFF**: does not play repeatedly.
- **ALL**: repeats all the files on the disc (when **CONTINUE** is selected in the play mode), or repeats the current album (when **CONTINUE (ALBUM)** is selected in the play mode).

■ **When Program Play is set to ON**

- **OFF**: does not play repeatedly.
- **ALL**: repeats Program Play.

To cancel Repeat Play

Press **CLEAR**.

Notes

- Depending on the DVD disc, repeat play does not work.
- Repeat Play is cancelled when you eject the disc.
- If the “**ALL**” is selected, repeat play is limited to 5 times.

Tips

- You can set Repeat Play during stop mode. After selecting the “**REPEAT**” item, press **▷**. The system starts Repeat Play.
- You can quickly display the “**REPEAT**” status. Press **REPEAT/FM MODE** on the remote.
- You can perform Repeat Play for DVD titles that contain chapters.

Searching for a Particular Point on a Disc

(Scan, Slow-motion Play, Slide show)



You can locate a particular point on a disc quickly by monitoring the picture or playing back slowly.

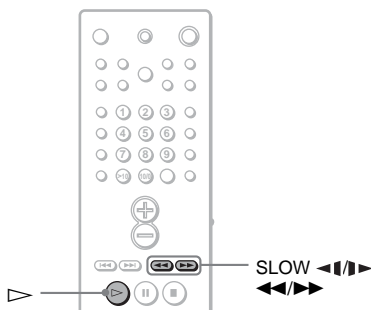

Notes

- Depending on the DVD/VIDEO CD, you may not be able to perform some of the operations described.
- During scan or slow-motion play, no sound is output.

Locating a point quickly by playing a disc in fast forward or fast reverse (Scan) (except for JPEG)

- 1** Press **◀◀** or **▶▶** while playing a disc.
- 2** When you find the point you want, press **▷** to return to normal speed.

To change the scan speed (DVD/VIDEO CD only)

Each time you press ◀◀ or ▶▶ during scan, the playback speed changes. Two speeds are available. With each press, the indication changes as follows:

Playback direction
FF1 ▶▶ → FF2 ▶▶



Opposite direction
FR1 ◀◀ → FR2 ◀◀



The FF2 ▶▶/FR2 ◀◀ playback speed is faster than FF1 ▶▶/FR1 ◀◀.

Watching frame by frame
(Slow-motion play)
(DVD/VIDEO CD only)

Press ◀◀ or ▶▶ when the system is in the pause mode.

To return to normal speed, press ▷.

To change the speed of Slow-motion play

Each time you press ◀◀ or ▶▶ during Slow-motion play, the playback speed changes. Two speeds are available. With each press, the indication changes as follows:

Playback direction
SLOW 2▶▶ → SLOW 1▶▶

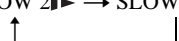

Opposite direction (DVD only)
SLOW 2◀◀ → SLOW 1◀◀



The SLOW 2▶▶/SLOW 2◀◀ playback speed is slower than SLOW 1▶▶/SLOW 1◀◀.

Enjoying the Slide show on
JPEG data disc (JPEG only)

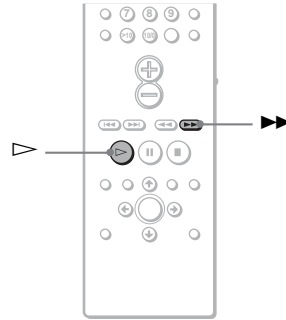

- 1 Press ▶▶ while displaying a JPEG image.**
Slide show starts from the current image.
- 2 Press ▷ when you want to exit Slide show.**
Return to normal play from the current image.

To change the interval time of
Slide show

Each time you press ▶▶ during Slide show, the interval time changes. With each press, the indication changes as follows:

FF1 ▶▶ → FF2 ▶▶ → FF3 ▶▶

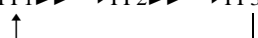

The FF3 ▶▶ interval time is faster than FF2 ▶▶.

Note

Slide show can play in only one direction.

Searching for a Title/ Chapter/Track/Index/ Album/File



You can search a title (DVD), chapter (DVD), track (CD, VIDEO CD, Super Audio CD, MP3), index (VIDEO CD, Super Audio CD), album (MP3, JPEG), and file (JPEG). As titles, tracks albums and files are assigned unique names on the disc, you can select the desired one from the Control Menu. Also chapters and indexes are assigned unique numbers on the disc, so you select the desired one by entering its number. Or you can search a particular point using the time code. (TIME SEARCH)

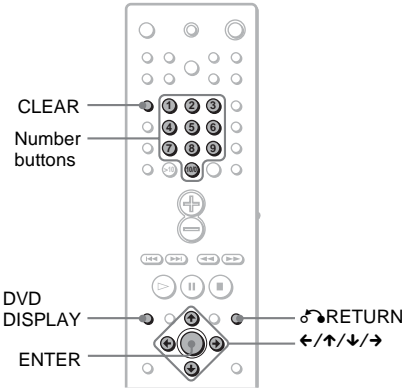

■ When playing a DVD



■ When playing a VIDEO CD



■ When playing a Super Audio CD



■ When playing a CD



■ When playing an MP3

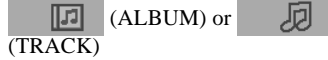

■ When displaying a JPEG file

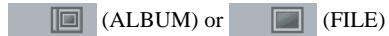

Example: when you select (TRACK)

The list of tracks contained in the disc appears.

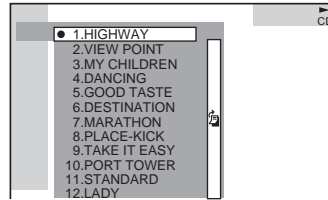

When the list of all tracks or albums cannot be displayed on the window, the jump bar appears. Press to select the jump bar icon, and then scroll the jump bar to display the rest of the list using . Press or RETURN to return to the track or the album list.

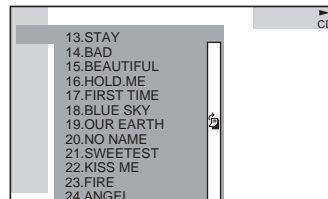

Searching for a title/track/ album/File

- 1 Press DVD DISPLAY.**
The Control Menu appears.
- 2 Press to select the search method, then press ENTER.**

- 3 Press to select the desired track, then press ENTER.**

The system starts playback from the selected track.

Searching for a chapter/index

1 Press DVD DISPLAY.

The Control Menu appears.

2 Press \uparrow/\downarrow to select the search method.

■ When playing a DVD



(CHAPTER)

■ When playing a VIDEO CD



(INDEX)

■ When playing a Super Audio CD



(INDEX)

Example: when you select



(CHAPTER)

“** (**)” is selected (** refers to a number).

The number in parentheses indicates the total number of titles, chapters, tracks, or indexes.

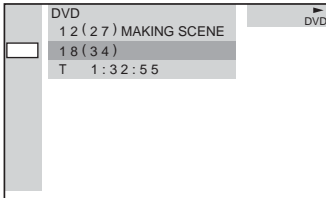

3 Press ENTER.

“** (**)” changes to “-- (**).”

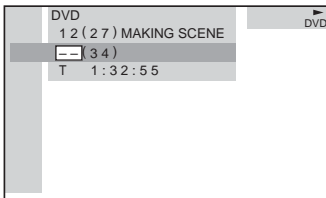

4 Press \uparrow/\downarrow or the number buttons to select the chapter or index number you want to search.

If you make a mistake

Cancel the number by pressing CLEAR, then select another number.

5 Press ENTER.

The system starts playback from the selected number.

To turn off the Control Menu

Press DVD DISPLAY repeatedly until the Control Menu is turned off.

To search for a particular point using the time code (TIME SEARCH)

Example: If you search for the playing time of the current title on a DVD

1 In Step 2, select



(TIME).

“T **: **: **” (playing time of the current title) is selected.

2 Press ENTER.

“T--:--:--” appears above “T **: **: **.”

3 Input the time code using the number buttons, then press ENTER.

For example, to find the desired point at 2 hours, 10 minutes, and 20 seconds after the beginning, just enter “2:10:20.”

Notes

- The title, chapter or track number displayed is the same number recorded on the disc.
- You cannot search a scene of a VIDEO CD.
- If you play a DVD, input the playing time of the current title using the time code. If you play a CD, Super Audio CD, VIDEO CD, or MP3, input the playing time of the current track using the time code.

Tip

You can change the display to show playing time or remaining time. For details, see “Checking the Playing Time and Remaining time” (page 37).

Viewing Information About the Disc

DVD VIDEO CD SA-CD CD MP3 JPEG

Viewing the Playing Time and Remaining Time in the Front Panel Display

You can check disc information, such as the remaining time, total number of titles in a DVD, or tracks in a Super Audio CD, CD, VIDEO CD or MP3, using the front panel display (page 71).

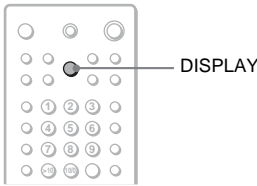

Press DISPLAY.

Each time you press DISPLAY while playing the disc, the display changes as shown in the charts.

When playing a DVD

Playing time and number of the current title

TITLE CHAP
1 46.18

Remaining time of the current title

TITLE CHAP
- 1 12.29

Playing time and number of the current chapter

CHAP
0 17.53

Remaining time of the current chapter

CHAP
- 0 03.51

Title name and playing time a)

50114
146.18

Current sound field b)

MATRIX

Volume b)

VOLUME
5

When playing a VIDEO CD
(without PBC functions), Super
Audio CD or CD

Playing time and current track number

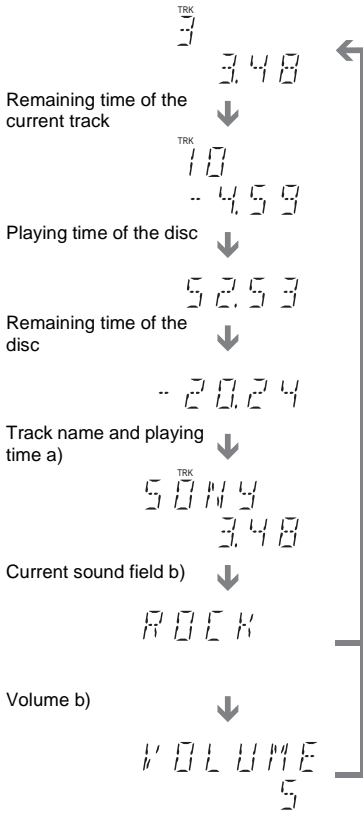

When playing an MP3
Playing time and current track number

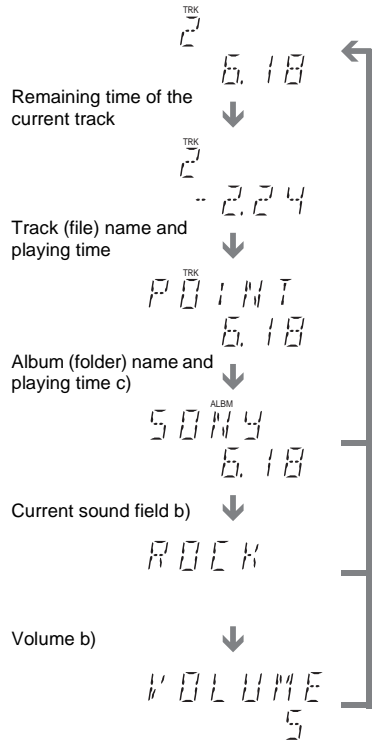

When playing a JPEG

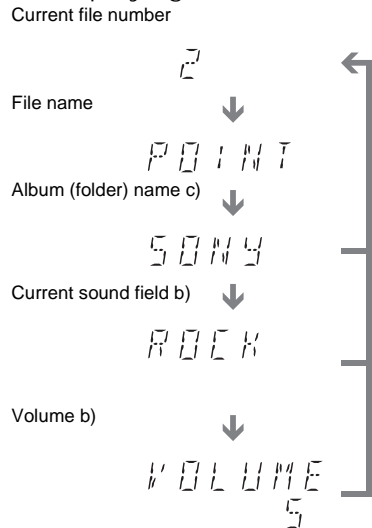

- a) This information is skipped if name information does not exist.
- b) Returns to the first information when indication time completes.
- c) Returns to the first information when the text scrolling is finished.

Notes

- Depending on the type of disc being played and the playing mode, the disc information may not be displayed.
- ID3 tag applies only to version 1.
- If the MP3 file you play back has an ID3 tag, the ID3 tag information is displayed as a track (file) name.
- Only the letters in the alphabet and numbers can be used for album or file names. Anything else is displayed as “ ”.
- In the following cases, elapsed playing time and time of the track remaining may not be displayed accurately.
 - when an MP3 file of VBR (variable bit rate) is played.
 - during fast-forward/reverse.

Tips

- When playing VIDEO CDs with PBC functions, only the playing time of the scene is displayed.
- The playing time and remaining time of the current chapter, title, track, scene, or disc will also appear on your TV screen. See the following section “Checking the Playing Time and Remaining Time” for details on how to read this information.

Checking the Playing Time and Remaining Time

You can check the playing time and remaining time of the current title, chapter, or track, and the total playing time or remaining time of the disc. You can also check the DVD/CD/Super Audio CD text and MP3 folder name/file name/ID3 tag (only song title) recorded on the disc.

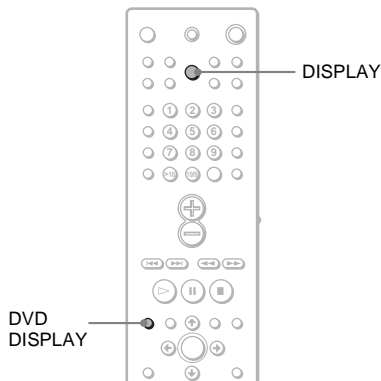

1 Press DVD DISPLAY during playback.

The Control Menu appears.

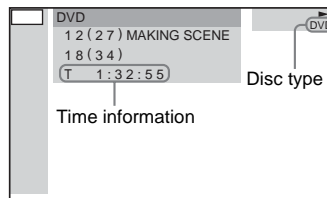

2 Press DISPLAY repeatedly to change the time information.

The display and the kinds of time that you can change depend on the disc you are playing.

■ **When playing a DVD**

- T **:**:**
 - Playing time of the current title
- T_**:**:**
 - Remaining time of the current title
- C **:**:**
 - Playing time of the current chapter

- C_**.*.*.*
- Remaining time of the current chapter
- **.*.*.*
- Playing time of the menu or current title without a chapter

■ **When playing a VIDEO CD (with PBC functions)**

- **.*.*
- Playing time of the current scene

■ **When playing a VIDEO CD (without PBC functions), Super Audio CD or CD**

- T **.*.*
- Playing time of the current track
- T_**.*.*
- Remaining time of the current track
- D **.*.*
- Playing time of the current disc
- D_**.*.*
- Remaining time of the current disc

■ **When playing an MP3**

- T **.*.*
- Playing time of the current track
- T_**.*.*
- Remaining time of the current track

To turn off the Control Menu

Press DVD DISPLAY repeatedly until the Control Menu is turned off.

Notes

- Only letters of the alphabet can be displayed.
- Depending on the type of disc being played, the system can only display a limited number of characters. Also, depending on the disc, not all text characters will be displayed.

Checking the date information (JPEG only)

You can check the date information during playback when the Exif* tag is recorded in the JPEG image data.

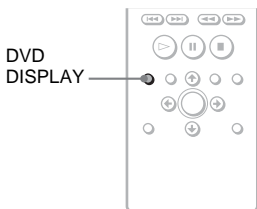

Press DVD DISPLAY during playback.

The Control Menu appears.

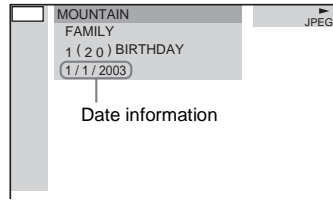

* “Exchangeable Image File Format” is a digital camera image format defined by the Japan Electronics & Information technology Industries Association.

Note

If there is no date information or data is damaged on the disc, the system cannot display the date information.

Tip

You can change the date information order in JPEG DATE of CUSTOM SETUP (page 61).

Sound Adjustments

Changing the Sound



If a DVD is recorded with multilingual tracks, you can select the language you want while playing the DVD.

If the DVD is recorded in multiple audio formats (PCM, Dolby Digital, MPEG audio, or DTS), you can select the audio format you want while playing the DVD.

With stereo CDs, VIDEO CDs, or MP3, you can select the sound from the right or left channel and listen to the sound of the selected channel through both the right and left speakers. (In this case, the sound loses its stereo effect.) For example, when playing a disc containing a song with the vocals on the right channel and the instruments on the left channel, you can select the left channel and hear only the instruments from both speakers.

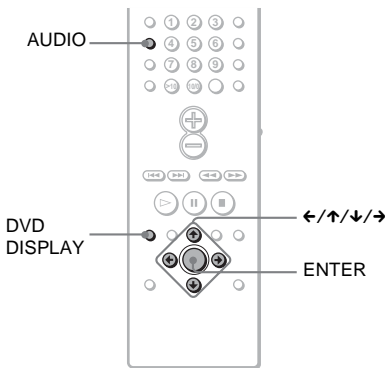

1 Press DVD DISPLAY during playback.

The Control Menu is displayed.

2 Press \uparrow/\downarrow to select (AUDIO), then press ENTER.

The options for AUDIO appear.

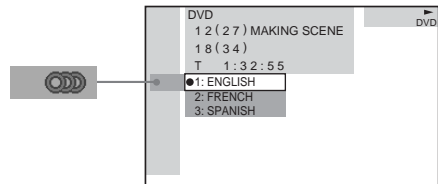

3 Press \uparrow/\downarrow to select the desired audio signal.

■ When playing a DVD

Depending on the DVD, the choice of language varies.

When 4 digits are displayed, they represent the language code. Refer to the language code list on page 75 to see which language the code represents. When the same language is displayed two or more times, the DVD is recorded in multiple audio formats.

■ When playing a VIDEO CD, CD, or MP3

The default setting is underlined.

- STEREO: The standard stereo sound
- 1/L: The sound of the left channel (monaural)
- 2/R: The sound of the right channel (monaural)

■ When playing a Super Audio CD

In stop mode, depending on the Super Audio CD, the choice of settings varies.

- MULTI: The disc has multi-channel playback area.
- 2CH: The disc has 2 channel playback area.
- CD: When you want to play the disc as a conventional CD.

Note

Not all discs give you the three choices above when in Super Audio CD playback. It all depends on the layer configuration of the Super Audio CD to be played.

4 Press ENTER.

To turn off the Control Menu

Press DVD DISPLAY repeatedly until the Control Menu is turned off.

Notes

- For discs not in multiple audio format, you cannot change the sound.
- During DVD playback, the sound may change automatically.

Tip

You can select AUDIO directly by pressing AUDIO. Each time you press the button, the item changes.

Displaying the audio information of the disc (DVD only)

When you select "AUDIO," the channels being played are displayed on the screen. For example, in Dolby Digital format, multiple signals ranging from monaural to 5.1 channel signals can be recorded on a DVD. Depending on the DVD, the number of recorded channels may differ.

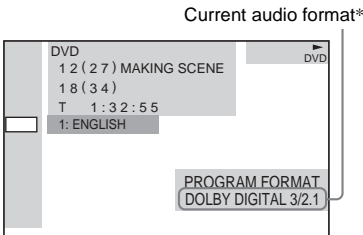

* "PCM," "MPEG," "DTS," or "DOLBY DIGITAL" is displayed.

For "DOLBY DIGITAL," the channels in the playing track are displayed numerically as follows:

For Dolby Digital 5.1 ch:

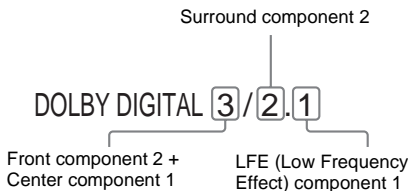

The display examples are as follows:

- PCM (stereo)

PROGRAM FORMAT
PCM 48kHz 24bit

- Dolby Surround

PROGRAM FORMAT
DOLBY DIGITAL 2/0
DOLBY SURROUND

- Dolby Digital 5.1ch

PROGRAM FORMAT
DOLBY DIGITAL 3/2.1

- DTS

PROGRAM FORMAT
DTS 3/2.1

Tips

- When the signal contains surround signal components such as LS, RS, or S, the surround effect is enhanced.
- If you play MPEG AUDIO sound tracks, the system outputs PCM (stereo) signals.

Enjoying Surround Sound



You can take advantage of surround sound simply by selecting one of system's pre-programmed sound fields. They bring the exciting and powerful sound of movie theatres into your home.

Sound field	Display
AUTO FORMAT DIRECT AUTO	A.F.D. AUTO
AUTO FORMAT DIRECT PRO LOGIC	DOLBY_PL
AUTO FORMAT DIRECT PRO LOGICII MOVIE	PLII_MOV
AUTO FORMAT DIRECT PRO LOGICII MUSIC	PLII_MUS
ROCK	ROCK
POP	POP
JAZZ	JAZZ
CLASSIC	CLASSIC
NEWS	NEWS
SPORTS	SPORTS
MOVIE	MOVIE
2 CHANNEL STEREO	2CH ST

When using the headphones

Sound field	Display
HEADPHONE 2 CHANNEL STEREO	HP 2CH
HEADPHONE SURROUND	HP SURR

Automatic decoding of the audio input signal (AUTO FORMAT DIRECT AUTO)

The auto decoding function automatically detects the type of audio signal being input (Dolby Digital, DTS, or standard 2 channel stereo) and performs the proper decoding if necessary. This mode presents the sound as it was recorded/encoded, without adding any effects (e.g. reverberation).

However, if there are no low frequency signals (Dolby Digital LFE, etc.), it will generate a low frequency signal for output to the subwoofer.

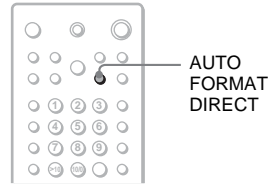

Press **AUTO FORMAT DIRECT** on the remote. "A.F.D. AUTO" appears in the front panel display.

Using only the front speaker and subwoofer (2 CHANNEL STEREO)

This mode outputs the sound from the front left and right speakers and subwoofer. Standard two channel (stereo) sources completely bypass the sound field processing. Multi channel surround formats are downmixed to two channels. This allows you to play any source using only the front left and right speakers and subwoofer.

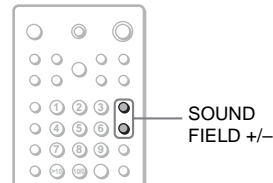

Press **SOUND FIELD +/-** on the remote repeatedly until "2CH ST" appears in the front panel display.

Selecting other sound fields

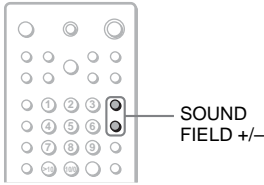

Press SOUND FIELD +/- on the remote repeatedly until the sound field you want appears in the front panel display.

■ AUTO FORMAT DIRECT PRO LOGIC

Dolby Pro Logic produces five output channels from two-channel sources. This mode performs Pro Logic decoding to the input signal and output to front, centre, and surround speakers. Meanwhile, the surround channel becomes monaural.

■ AUTO FORMAT DIRECT PRO LOGICII MOVIE/MUSIC

Dolby Pro LogicII produces five full-bandwidth output channels from two-channel sources. This is done using an advanced, high-purity matrix surround decoder that extracts the spatial properties of the original recording without adding any new sounds or tonal colorations.

■ ROCK, JAZZ, POP, CLASSIC, NEWS, SPORTS, MOVIE

The each mode provided sound to suit the source.

■ HEADPHONE 2CHANNEL STEREO

This mode outputs the sound from the headphone L/R. Standard 2 channel (stereo) sources completely bypass the sound field processing. Multi channel surround formats are downmixed to two channels.

■ HEADPHONE SURROUND

This mode outputs the sound as surround from headphone L/R.

To turn the sound field

Press AUTO FORMAT DIRECT on the remote. "A.F.D. AUTO" appears in the front panel display.

When you press AUTO FORMAT DIRECT on the remote again, the sound field function is activated.

When connecting the headphone to the PHONE jack

Press SOUND FIELD +/- on the remote until "HP 2CH" appears in the front panel display.

Notes

- This function is unavailable when playing Super Audio CDs.
- When the input signal is multi channel source, AUTO FORMAT DIRECT PRO LOGIC, AUTO FORMAT DIRECT PRO LOGICII MOVIE/MUSIC are cancelled and the multi channel source is output directly.

Using the Sound Effect

DVD

VIDEO
CD

CD

MP3

This system provides you with 2 types of sound effect, simply by pressing a button. Choose the sound to suit your needs.

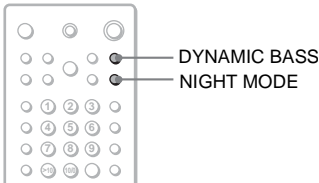

Press NIGHT MODE or DYNAMIC BASS on the remote.

The sound effect is activated

■ NIGHT MODE

In this mode, you can enjoy sound effects or dialogue in a movie, as you would a movie theatre, even at low volume. It is useful for watching movies at night.

■ DYNAMIC BASS

With DYNAMIC BASS on, bass frequencies are effectively reinforced.

To turn off the sound effect

Press NIGHT MODE or DYNAMIC BASS on the remote again.

Notes

- These two types of sound effect cannot be activated at the same time.
- When playing a Super Audio CD, this function does not work.

Using Various Additional Functions

Changing the Angles

DVD

If various angles (multi-angles) for a scene are recorded on the DVD, you can change the viewing angle.

For example, while playing a scene of a train in motion, you can display the view from either the front of the train, the left window of the train, or from the right window without having the train's movement interrupted.

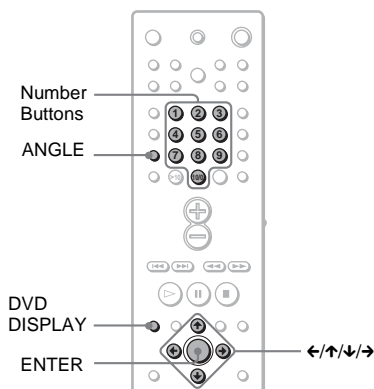

1 Press DVD DISPLAY during playback.

The Control Menu appears.

2 Press \uparrow/\downarrow to select (ANGLE).

The angle number appears.

The number in parentheses indicates the total number of angles. The "ANGLE" indicator lights up in green when angles are recorded on the disc.

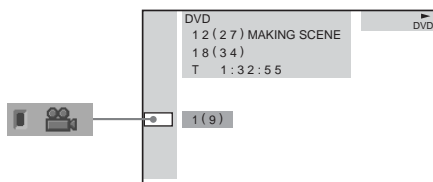

3 Press \rightarrow or ENTER.

The angle number changes to "-."

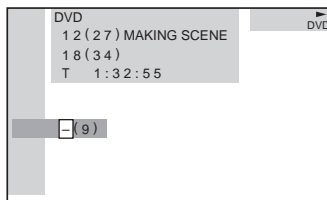

4 Select the angle number using the number buttons or \uparrow/\downarrow, then press ENTER.

The angle is changed to the selected angle.

To turn off the Control Menu

Press DVD DISPLAY repeatedly until the Control Menu is turned off.

Note

Depending on the DVD, you may not be able to change the angles, even if multi-angles are recorded on the DVD.

Tip

You can select the angle directly by pressing ANGLE. Each time you press the button, the angle changes.

Displaying the Subtitles

DVD

If subtitles are recorded on the discs, you can turn the subtitles on or off while playing. If multilingual subtitles are recorded on the disc, you can change the subtitle language while playing, or turn the subtitles on or off whenever you want. For example, you can select the language you want to practice and turn the subtitles on for better understanding.

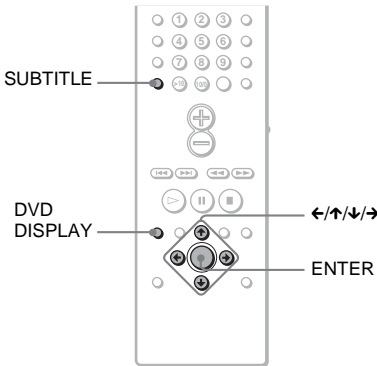

1 Press DVD DISPLAY during playback.

The Control Menu appears.

2 Press \uparrow/\downarrow to select (SUBTITLE), then press ENTER.

The options for SUBTITLE appear.

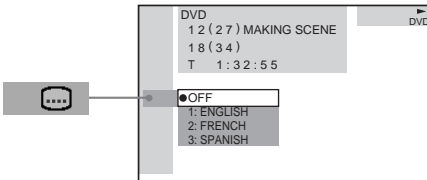

3 Press \uparrow/\downarrow to select the language.

Depending on the DVD, the choice of language varies.

When 4 digits are displayed, they indicate the language code. Refer to the language code list on page 75 to see which language the code represents.

4 Press ENTER.

To cancel the SUBTITLE setting
Select "OFF" in Step 3.

To turn off the Control Menu

Press DVD DISPLAY repeatedly until the Control Menu is turned off.

Note

Depending on the DVD, you may not be able to change the subtitles even if multilingual subtitles are recorded on it.

Tip

You can select Subtitles directly by pressing SUBTITLE. Each time you press the button, the item changes.

Locking Discs

(CUSTOM PARENTAL CONTROL, PARENTAL CONTROL)



You can set two kinds of playback restrictions for a disc.

- Custom Parental Control
You can set the playback restrictions so that the system will not play inappropriate discs.
- Parental Control
Playback of some DVDs can be limited according to a predetermined level such as the age of the users.
The same password is used for both Parental Control and Custom Parental Control.

Custom Parental Control

You can set the same Custom Parental Control password for up to 25 discs. When you set the 26th disc, the playback restriction of the disc for which you first set the password is cancelled.

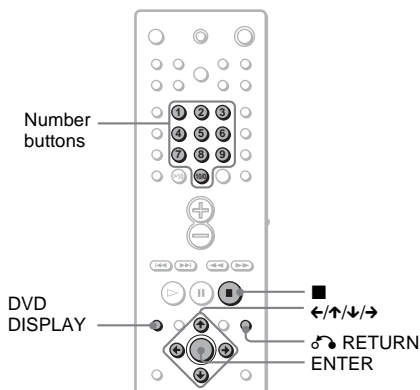

- 1 Insert the disc you want to lock.**
If the disc is playing, press ■ to stop playback.
- 2 In stop mode, press DVD DISPLAY.**
The Control Menu appears.

- 3 Press ↑/↓ to select (CUSTOM PARENTAL CONTROL), then press ENTER.**

“CUSTOM PARENTAL CONTROL” is selected.

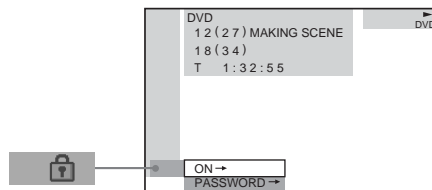

- 4 Press ↑/↓ to select “ON →,” then press ENTER.**

■ When you have not entered a password

The display for registering a new password appears.

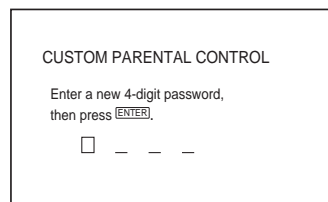

Enter a 4-digit password by using the number buttons, then press ENTER.

The display for confirming the password appears.

■ When you have already registered a password

The display for entering the password appears.

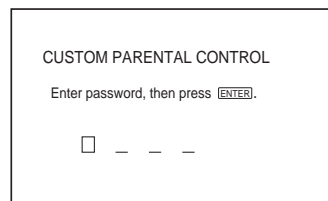

5 Enter or re-enter your 4-digit password by using the number buttons, then press ENTER.

“Custom parental control is set.” appears and the screen returns to the Control Menu display.

If you make a mistake entering your password

Press **←** before you press ENTER and input the correct number.

If you make a mistake

Press **↶** RETURN, then start from Step 3 again.

To turn off the Control Menu

Press DVD DISPLAY repeatedly until the Control Menu is turned off.

To turn off the Custom Parental Control function

1 In Step 4, select “OFF →,” then press ENTER.

2 Enter your 4-digit password using the number buttons, then press ENTER.

To change the password

1 In Step 4, press **↑/↓** to select “PASSWORD →,” then press ENTER.

The display for entering the password appears.

2 Enter your 4-digit password using the number buttons, then press ENTER.

3 Enter a new 4-digit password using the number buttons, then press ENTER.

4 To confirm your password, re-enter it using the number buttons, then press ENTER.

Playing the disc for which Custom Parental Control is set

1 Insert the disc for which Custom Parental Control is set.

The CUSTOM PARENTAL CONTROL display appears.

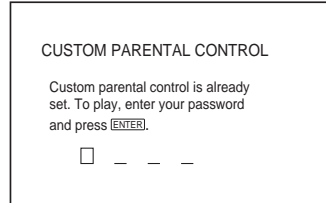

2 Enter your 4-digit password using the number buttons, then press ENTER.

The system is ready for playback.

Notes

- When you change the layer or area in a Super Audio CD which has Custom Parental Control set, the display for entering the password may appear.
- When you set the Custom Parental Control password for a Hybrid Super Audio CD, the Custom Parental Control setting only works for the current layer.

Tip

If you forget your password, enter the 6-digit number “199703” using the number buttons when the CUSTOM PARENTAL CONTROL display asks you for your password, then press ENTER. The display will ask you to enter a new 4-digit password.

Limiting playback for children (Parental Control) (DVD only)

Playback of some DVDs can be limited according to a predetermined level such as the age of the users. The “Parental Control” function allows you to set a playback limitation level. A scene that is limited is not played, or it is replaced by a different scene.

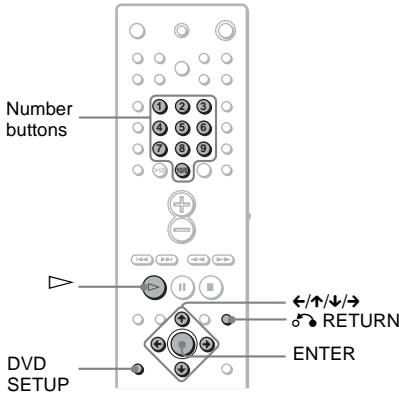

- 1 In stop mode, press DVD SETUP.**
The Setup Display appears.
- 2 Press ↑/↓ to select “CUSTOM SETUP,” then press ENTER.**
“CUSTOM SETUP” is displayed.

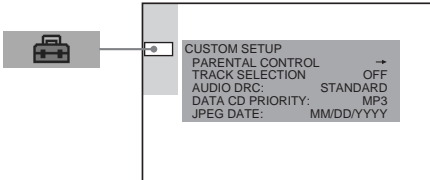

- 3 Press ↑/↓ to select “PARENTAL CONTROL →,” then press ENTER.**
 - **If you have not entered a password**
The display for registering a new password appears.

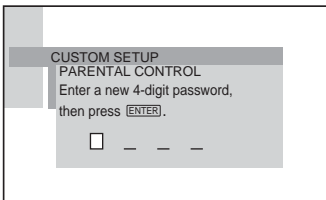

Enter a 4-digit password using the number buttons, then press ENTER.
The display for confirming the password appears.

- **When you have already registered a password**
The display for entering the password appears.

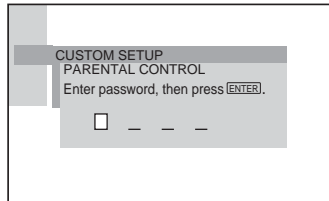

- 4 Enter or re-enter your password using the number buttons, then press ENTER.**
The display for setting the playback limitation level and changing the password appears.

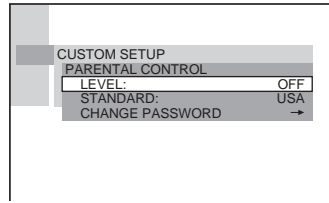

- 5 Press ↑/↓ to select “STANDARD,” then press ENTER.**
The selection items for “STANDARD” are displayed.

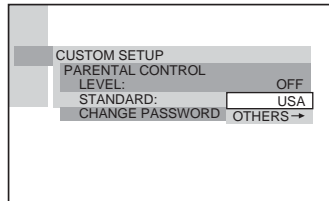

- 6 Press ↑/↓ to select a geographic area as the playback limitation level, then press ENTER.**
The area is selected.

If you select “OTHERS →,” select and enter the standard code in the table on page 50 using the number buttons.

7 Press \uparrow/\downarrow to select “LEVEL,” then press ENTER.

The selection items for “LEVEL” are displayed.

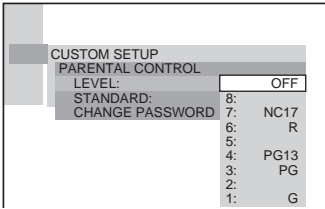

8 Select the level you want using \uparrow/\downarrow , then press ENTER.

Parental Control setting is complete.

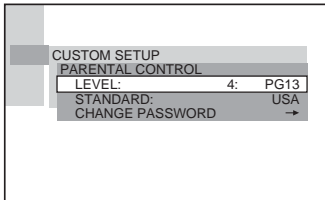

The lower the value, the more strict the limitation.

If you make a mistake

Press \leftarrow RETURN to go back to the previous screen.

To turn off the Setup Display

Press DVD SETUP repeatedly until the Setup Display is turned off.

To turn off the Parental Control function and play the DVD after entering your password

Set “LEVEL” to “OFF” in Step 8.

To change the password

1 In Step 5, select “CHANGE PASSWORD →” using \downarrow , then press ENTER.

The display for entering the password appears.

2 Follow Step 3 to enter a new password.

Playing the disc for which Parental Control is set

1 Insert the disc and press \triangleright .

The PARENTAL CONTROL display appears.

2 Enter your 4-digit password using the number buttons, then press ENTER.

The system starts playback.

Notes

- When you play DVDs which do not have the Parental Control function, playback cannot be limited on this system.
- Depending on the DVD, you may be asked to change the parental control level while playing the disc. In this case, enter your password, then change the level. If the Resume Play mode is cancelled, the level returns to the original level.

Tip

If you forget your password, remove the disc and repeat Step 1 to 3 of “Limiting playback for children.” When you are asked to enter your password, enter “199703” using the number buttons, then press ENTER. The display will ask you to enter a new 4-digit password. After you enter a new 4-digit password in Step 3, replace the disc in the system and press \triangleright . When the PARENTAL CONTROL display appears, enter your new password.

Area Code

Standard	Code number
Argentina	2044
Australia	2047
Austria	2046
Belgium	2057
Brazil	2070
Canada	2079
Chile	2090
China	2092
Denmark	2115
Finland	2165
France	2174
Germany	2109
Hong Kong	2219
India	2248
Indonesia	2238
Italy	2254
Japan	2276
Korea	2304
Malaysia	2363
Mexico	2362
Netherlands	2376
New Zealand	2390
Norway	2379
Pakistan	2427
Philippines	2424
Portugal	2436
Russia	2489
Singapore	2501
Spain	2149
Sweden	2499
Switzerland	2086
Taiwan	2543
Thailand	2528
United Kingdom	2184

Other Operations

Controlling the TV with the Supplied Remote

By adjusting the remote signal, you can control your TV with the supplied remote.

Notes

- If you enter a new code number, the code number previously entered will be erased.
- When you replace the batteries of the remote, the code number may be reset to the default (SONY) setting. Reset the appropriate code number.

Controlling TVs with the remote

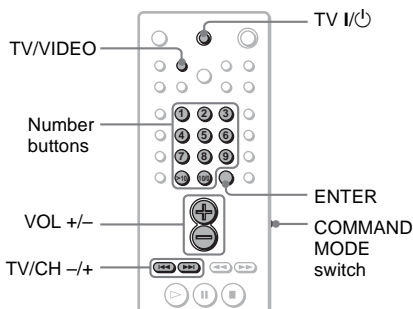

- 1 Set to TV in COMMAND MODE switch on the remote.**
- 2 Press and hold TV I/⏻ while entering your TV's manufacturer's code (see the table) using the number buttons and press ENTER. Then release TV I/⏻.**

Code numbers of controllable TVs

If more than one code number is listed, try entering them one at a time until you find the one that works with your TV.

TV

Manufacturer	Code number
SONY	001
DAEWOO	002, 004, 005, 006, 007, 015
FISHER	008
GRUNDIG	017, 034
HITACHI	002, 013, 014, 015
ITT/NOKIA	021, 022
JVC	016
LG	002, 003, 011, 012, 015, 034
MAGNAVOX	002, 003, 018
MITSUBISHI/MGA	002, 003, 019
NEC	002, 003, 020
PANASONIC	009, 024
PHILIPS	015, 018
PIONEER	009, 025, 026, 040
RCA/PROSCAN	002, 010, 027, 028, 029
SAMSUNG	002, 003, 015, 031, 032, 033, 034
SANYO	008, 044, 045, 046
SHARP	035
TELEFUNKEN	023, 036, 037, 038
THOMSON	030, 037, 039
TOSHIBA	035, 040, 041
ZENITH	042, 043

CATV

Manufacturer	Code number
SONY	101
HAMLIN/REGAL	123, 124, 125, 126, 127
JERROLD/GI	102, 103, 104, 105, 106, 107, 108, 109, 119, 131
OAK	128, 129, 130
PANASONIC	120, 121, 122
PIONEER	115, 116
SCIENTIFIC	110, 111, 112
ATLANTA	
TOCOM	117, 118, 131
ZENITH	113, 114

Controlling the TV

You can control your TV using the buttons below.

By pressing	You can
TV I/⏻	Turn the TV on or off.
TV/VIDEO	Switch the TV's input source between the TV and other input sources.

Button	TV
1~9, 10/0	Selects the TV Channels. (1-10 CH)
⏪	TV CH -*
⏩	TV CH +*
⊕	VOL +
⊖	VOL -

Note

Depending on the TV, you may not be able to control your TV or to use some of the buttons above.

* Use for selecting the channel number greater than 10.

Tip

Depending on the TV manufacture, the following method works. For double-digit number, press -/-- first and then number. (For example, for channel 25, press -/--, then 2 and 5.)

Using the Video or Other Unit

You can use VCRs or other units connected to the VIDEO 1 or VIDEO 2 jacks. Refer to the operation manual supplied with the unit for further information on the operation.

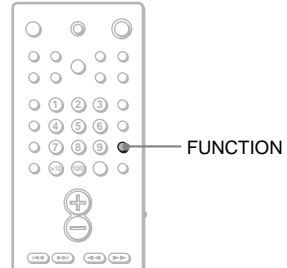

Press FUNCTION repeatedly until VIDEO 1 or VIDEO 2 that you connected the unit to appears in the front panel display.

Each time you press FUNCTION, the mode of the system changes in the following sequence.
TUNER FM → TUNER AM → VIDEO 1 → VIDEO 2 → TV* → DVD → TUNER FM → ...

* When selecting the TV, TV sound is output.

Enjoying the Radio

Presetting Radio Stations

You can preset 20 stations for FM and 10 stations for AM.

Before tuning, make sure to turn down the volume to minimum.

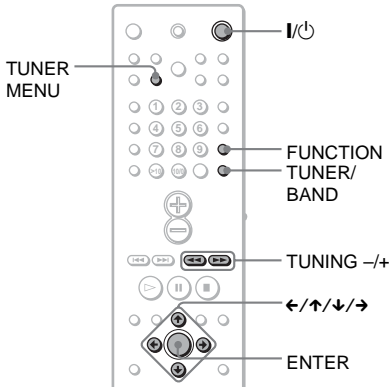

- 1 Press TUNER/BAND repeatedly until the band you want appears in the front panel display.**

Each time you press TUNER/BAND, the band changes to AM or FM alternately.

- 2 Press and hold TUNING + or – until “AUTO” appears in the front panel display, then release.**

Scanning stops when the system tunes in a station. “TUNED” and “STEREO” (for stereo program) appear in the front panel display.



- 3 Press TUNER MENU.**
“MEMORY” appears in the front panel display.

- 4 Press ENTER.**
A preset number appears in the front panel display.

- 5 Press ↑/↓ to select the preset number you want.**



- 6 Press ENTER.**
The station is stored.



- 7 Repeat 1 to 6 to store other stations.**

To change the preset number

Restart from step 1.

Tip

You can preset the stations as in the same way, using the TV screen.

Listening to the Radio

Preset radio stations in the system's memory first (see "Presetting Radio Stations" on page 53).

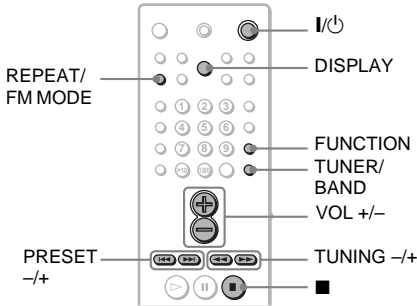

1 Press FUNCTION repeatedly until FM or AM appears in the front panel display.

The last received station is tuned in.

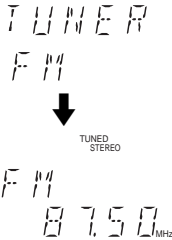

2 Press PRESET + or - repeatedly to select the preset station you want.

Each time you press the button, the system tunes in one preset station.

Every time you press TUNER/BAND, the band changes to AM or FM alternately.

3 Adjust the volume by pressing VOL +/-.

To turn off the radio

Press **I/⏻**.

To listen to non-preset radio stations

Use manual or automatic tuning in Step 2.

For manual tuning, press TUNING + or - on the remote repeatedly.

For automatic tuning, press and hold TUNING + or - on the remote. Press **■** when you stop the automatic tuning.

Tips

- If an FM program is noisy, press REPEAT/FM MODE on the remote so that "MONO" appears in the front panel display. There will be no stereo effect, but the reception will improve. Press the button again to restore the stereo effect.
- To improve reception, reorient the supplied aerials.

To check the frequency or sound field

Press DISPLAY repeatedly.

Each time you press DISPLAY, the front panel display changes as follows:

frequency → sound field → volume → frequency...

To check the station name

Press FUNCTION repeatedly until FM appears in the front display.

The TUNER information appears on the TV screen.



The station name that the Radio Data System (RDS) service (page 55) provides appears in the TUNER information.

Notes

- For AM station, only the frequency (not the station name) appears.
- This system is available only for FM station*.
- * Not all FM stations provide RDS service, nor do they provide the same type of services. If you are not familiar with the RDS system, check with your local radio stations for details on RDS services in your area.

Using the Radio Data System (RDS)

What is the Radio Data System?

The Radio Data System (RDS) is a broadcasting service that allows radio stations to send additional information along with the regular program signal. This tuner offers convenient RDS features, such as station name display. RDS is available only for FM stations.*

Note

RDS may not work properly if the station you are tuned to is not transmitting the RDS signal properly, or if the signal strength is weak.

* Not all FM stations provide RDS service, nor do they provide the same type of services. If you are not familiar with the RDS system, check with your local radio stations for details on RDS services in your area.

Receiving RDS broadcasts

Simply select a station from the FM band. When you tune in a station that provides RDS services, the station name* appears in the TUNER information.

* If an RDS broadcast is not received, the station name may not appear in the display.

Using the Sleep Timer

You can set the system to turn off at a preset time, so you can fall asleep listening to music. You can preset the time in 10 minute decrements.

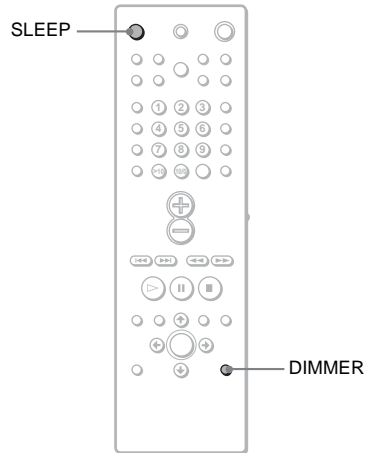

Press SLEEP.

Each time you press this button, the minutes display (the remaining time) changes as follows:

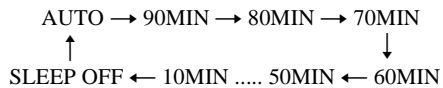

When you choose AUTO

The system turns off when the current disc finishes playback (up to 240 minutes). The system turns off if you manually stop playing a disc.

To check the remaining time

Press SLEEP once. You cannot check the remaining time if you select "AUTO."

To change the remaining time

Press SLEEP repeatedly to select the desired time.

To cancel the Sleep Timer function

Press SLEEP repeatedly until “SLEEP OFF” appears in the display.

To change the brightness of the front panel display

Press DIMMER.

You can change the brightness of the front panel display by two steps.

Settings and Adjustments

Using the Setup Display



By using the Setup Display, you can make various adjustments to items such as picture and sound. You can also set a language for the subtitles and the Setup Display, among other things. For details on each Setup Display item, see page 58-63. For an overall list of Setup Display items, see page 76.

How to use the Setup Display

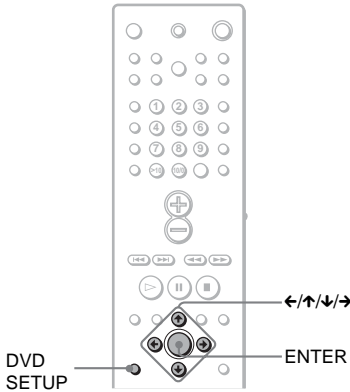

- 1 In stop mode, press DVD SETUP.**
The Setup Display appears.

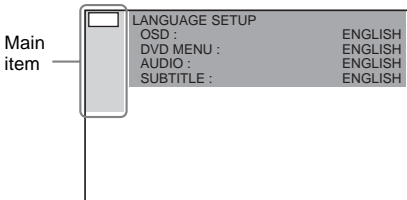

- 2 Press \uparrow/\downarrow to select the setup item from the displayed list: "LANGUAGE SETUP," "SCREEN SETUP," "CUSTOM SETUP," "SPEAKER SETUP," and "RESET*." Then press ENTER or \rightarrow .**

The selected Setup item appears.
Example: "SCREEN SETUP"

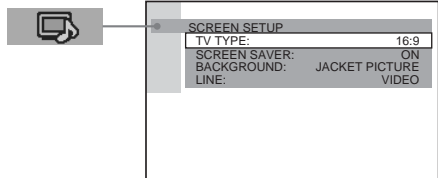

- 3 Select an item using \uparrow/\downarrow , then press ENTER or \rightarrow .**

The options for the selected item appear.
Example: "TV TYPE"

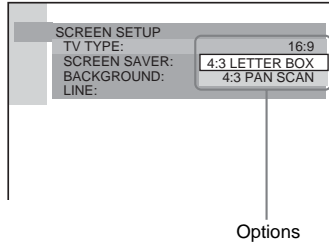

- 4 Select a setting using \uparrow/\downarrow , then press ENTER.**

The setting is selected and setup is complete.
Example: "4:3 PAN SCAN"

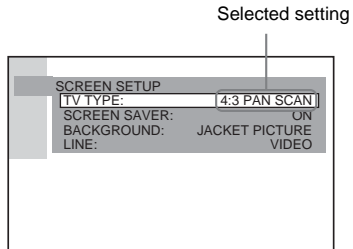

To turn off the Setup Display

Press DVD SETUP repeatedly until the Setup Display is turned off.

- * When you select “RESET”  in step 2, the following items are returned to the default settings.
- Setup Menu (except for the PARENTAL CONTROL) (page 76)

After you select “RESET” and press ENTER, select “YES” to reset the settings (it takes a few seconds to complete). Select “NO” and press ENTER to return to the Control Menu. Do not press  on the system, when resetting the system.

Setting the Display or Sound Track Language

(LANGUAGE SETUP)



“LANGUAGE SETUP” allows you to set various languages for the on-screen display or sound track.

Select “LANGUAGE SETUP” in the Setup Display. For details on using the display, see “Using the Setup Display” (page 57).

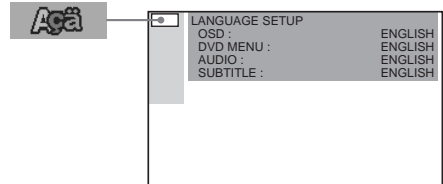

■ OSD (On-Screen Display)

Switches the display language on the screen.
Selects the language from the displayed list.

■ DVD MENU (DVD only)

Selects the desired language for the DVD menu.

■ AUDIO (DVD only)

Switches the language of the sound track.
Selects the language from the displayed list.

■ SUBTITLE (DVD only)

Switches the language of the subtitle.
Selects the language from the displayed list.

Note

If you select a language that is not recorded on the DVD, one of the recorded languages will be automatically selected (except for the “OSD”).

Tip

If you select “OTHERS →” in “DVD MENU,” “SUBTITLE,” or “AUDIO,” select and enter the language code from the list using the number buttons (page 75).

After you have made a selection, the language code (4 digits) is displayed the next time you select “OTHERS →.”

Settings for the Display

(SCREEN SETUP)



Choose settings according to the TV to be connected.

Select "SCREEN SETUP" in the Setup Display. For details on using the display, see "Using the Setup Display" (page 57).

The default settings are underlined.

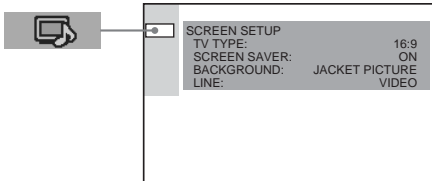

■ TV TYPE (DVD only)

Selects the aspect ratio of the connected TV (4:3 standard or wide).

<u>16:9</u>	Select this when you connect a wide-screen TV or a TV with a wide mode function.
<u>4:3 LETTER BOX</u>	Select this when you connect a 4:3 screen TV. Displays a wide picture with bands on the upper and lower portions of the screen.
<u>4:3 PAN SCAN</u>	Select this when you connect a 4:3 screen TV. Automatically displays the wide picture on the entire screen and cuts off the portions that do not fit.

16:9



4:3 LETTER BOX



4:3 PAN SCAN



Note

Depending on the DVD, "4:3 LETTER BOX" may be selected automatically instead of "4:3 PAN SCAN" or vice versa.

■ SCREEN SAVER

Turns the screen saver on and off so that the screen saver appears when you leave the system in pause or stop mode for 15 minutes, or when you playback a CD, a Super Audio CD, or an MP3 for more than 15 minutes. The screen saver will help prevent your display device from becoming damaged (afterimage). Press \blacktriangleright to turn off the screen saver.

<u>ON</u>	Turns on the screen saver.
<u>OFF</u>	Turns off the screen saver.

■ BACKGROUND

Selects the background colour or picture on the TV screen in stop mode or while playing a CD.

<u>JACKET PICTURE</u>	The jacket picture (still picture) appears in the background, but only when the jacket picture is already recorded on the disc (CD-EXTRA, etc.). If the disc does not contain a jacket picture, the "GRAPHICS" picture appears.
<u>GRAPHICS</u>	A preset picture stored in the system appears in the background.
<u>BLUE</u>	The background colour is blue.
<u>BLACK</u>	The background colour is black.

■ LINE

Select the output method for video signals from the  EURO AV OUTPUT (TO TV) jack on the rear panel of the system.

VIDEO	Outputs video signals.
RGB	Outputs RGB signals.

Note

If your TV does not accept RGB signals, no picture appears on the TV screen even if you select “RGB.” Refer to the instructions supplied with your TV.

Custom Settings

(CUSTOM SETUP)



Allows setting up Parental Control and other settings.

Select “CUSTOM SETUP” in the Setup Display. For details on using the display, see “Using the Setup Display” (page 57). The default settings are underlined.

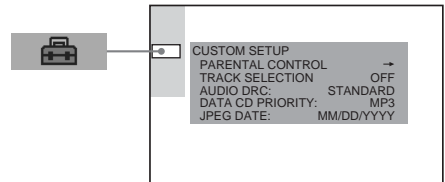

■ PARENTAL CONTROL → (DVD only)

Sets a password and playback limitation level for DVDs with playback limitation for children. For details, see “Limiting playback for children (Parental Control)” (page 47).

■ TRACK SELECTION (DVD only)

Gives the sound track having the highest number of channels priority when you play a DVD on which multiple audio formats (PCM, MPEG audio, DTS, or Dolby Digital format) are recorded.

OFF	No priority given.
AUTO	Priority given.

Notes

- When you set the item to “AUTO,” the language may change. The “TRACK SELECTION” setting has higher priority than the “AUDIO” settings in “LANGUAGE SETUP” (page 58).
- If PCM, DTS, MPEG audio, and Dolby Digital sound tracks have the same number of channels, the system selects PCM, DTS, Dolby Digital, and MPEG audio sound tracks in this order.
- Depending on the DVD, the audio channel with priority may be predetermined. In this case, you cannot give priority to the DTS, Dolby Digital, or MPEG audio format by selecting “AUTO.”

■ AUDIO DRC

Narrows the DYNAMIC range of the sound track.

Useful for watching movies at low volume late at night.

OFF	No compression of DYNAMIC range.
<u>STANDARD</u>	Reproduces the sound track with the kind of DYNAMIC range that the recording engineer intended.
MAX	Narrows the DYNAMIC range fully.

Note

DYNAMIC range compression only works for Dolby Digital sources.

■ DATA CD PRIORITY (MP3, JPEG only)

Set priority data you want to play, when you play the DATA CD (CD-ROM/CD-R/CD-RW) contained MP3 audio tracks and JPEG image files.

<u>MP3</u>	If an MP3 file exists on the disc, the system recognises the disc as an “MP3 Disc.” If only JPEG files exist on the disc, the system recognises the disc as a “JPEG Disc.”
JPEG	If a JPEG file exists on the disc, the system recognises the disc as a “JPEG Disc.” If only MP3 files exist on the disc, the system recognises the disc as an “MP3 Disc.”

Note

When you play Multi Session CDs, the system decides a target to play for last session or session linked with last session.

■ JPEG DATE

Change the date information order of a JPEG image in the Control Menu. The default setting is “MM/DD/YYYY.”

YYYY: Year

MM: Month

DD: Day

Settings for the Speakers

(SPEAKER SETUP)

To obtain the best possible surround sound, set the size of the speakers you have connected and their distance from your listening position. Then use the test tone to adjust the level and the balance of the speakers to the same level.

Select “SPEAKER SETUP” in the setup display. For details, see “Using the Setup Display” (page 57).

The default settings are underlined.

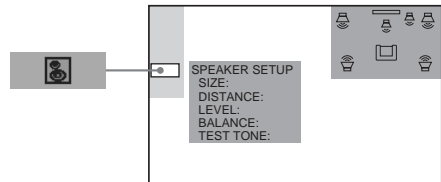

To return to the default setting when changing a setting

Select the item, then press CLEAR.

■ SIZE

When you do not connect center or surround speakers, or move the surround speakers, set the parameters for CENTER and SURROUND. Since the front speaker and subwoofer settings are fixed, you cannot change them.

FRONT	<u>YES</u>
CENTER	<u>YES</u> : Normally select this. NONE: Select this if no center speaker is used.
SURROUND	<u>YES</u> : Normally select this. NONE: Select this if no surround speaker is used.
SUBWOOFER	<u>YES</u>

Notes

- When you select an item, the sound cuts off for a moment.
- Depending on the settings of other speakers, the subwoofer may output excessive sound.

■ DISTANCE

The default distance setting for the speakers in relation to the listening position is shown below.

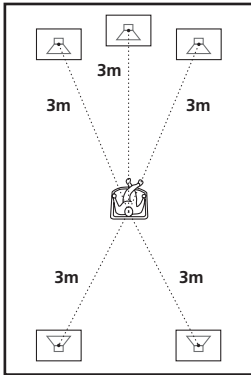

Be sure to change the value in the Setup Display when you move the speakers.

FRONT <u>3 m</u>	Front speaker distance from the listening position can be set in 0.2 metre increments from 1.0 to 7.0 metres.
CENTER <u>3 m</u>	Center speaker distance can be moved up to 1.6 metres forward closer to the listening position, in 0.2 metre increments.
SURROUND <u>3 m</u>	Surround speaker distance can be moved up to 4.6 metres closer to your listening position from the front speaker position, in 0.2 metre increments.

Notes

- When you set the distance, the sound cuts off for a moment.
- If all front and surround speakers are not placed at an equal distance from your listening position, set the distance according to the closest speaker.
- Do not place the surround speakers farther away from your listening position than the front speakers.
- The DISTANCE setting is available except for Super Audio CDs.

■ LEVEL

You can vary the level of each speaker as follows. Be sure to set “TEST TONE” to “ON” for easy adjustment.

CENTER <u>0 dB</u>	Adjusts the level of the center speaker (-6 dB to +6 dB, 1 dB increments).
SURROUND LEFT <u>0 dB</u> SURROUND RIGHT <u>0 dB</u>	Adjusts the level of the surround speakers (-6 dB to +6 dB, 1 dB increments).
SUBWOOFER <u>0 dB</u>	Adjusts the level of the subwoofer (-6 dB to +6 dB, 1 dB increments).

■ BALANCE

You can vary the balance of the left and right speakers as follows. Be sure to set “TEST TONE” to “ON” for easy adjustment.

FRONT CENTER	Adjusts the balance between the front left and right speakers. The center position is shown as “---”. (You can adjust from the center 6 steps left or right.)
---------------------	---------------------------------------------------------------------------------------------------------------------------------------------------------------

To adjust the volume of all the speakers at one time

Use the VOLUME control on the system, or press VOL +/-.

■ TEST TONE

The speakers will emit a test tone to adjust “LEVEL” and “BALANCE.”

OFF	The test tone is not emitted from the speakers.
ON	The test tone is emitted from each speaker in sequence while adjusting balance or level. When you select one of the “SPEAKER SETUP” items, the test tone is emitted from both left and right speakers simultaneously.

Adjusting the speaker balance and level

- 1 Press DVD SETUP in stop mode.**
The Setup Display appears.
- 2 Press ↑ or ↓ repeatedly to select “SPEAKER SETUP”, then press ENTER.**
- 3 Press ↑ or ↓ repeatedly to select “TEST TONE”, then press ENTER.**
- 4 Press ↑ or ↓ repeatedly to select “ON”, then press ENTER.**
You will hear the test tone from each speaker in sequence.
- 5 From your listening position, adjust the value of “BALANCE” and “LEVEL” using ←/↑/↓/→.**
The test tone is emitted from both left and right speakers simultaneously.
- 6 Press ENTER when you have finished making adjustments.**
- 7 Press ↑ or ↓ repeatedly to select “TEST TONE”, then press ENTER.**
- 8 Press ↑ or ↓ repeatedly to select “OFF”, then press ENTER.**

Note

When you adjust the speaker settings, the sound cuts off for a moment.

Tip

To adjust the balance or the level without listening to the test tone, select “BALANCE” or “LEVEL” in step 3 and press ENTER. Then adjust the balance or level using ↑/↓ and press ENTER.

Additional Information

Troubleshooting

If you experience any of the following difficulties while using the system, use this troubleshooting guide to help remedy the problem before requesting repairs. Should any problem persist, consult your nearest Sony dealer.

Power

The power is not turned on.

- Check that the mains lead is connected securely.

When the STANDBY indicator flashes.

Immediately unplug the power cord and check the following items.

- Are the + and – speaker cords short-circuited?
- Are you using only the specified speakers?
- Is anything blocking the ventilation holes on the top of the system?

After checking the above items and fixing any problems, connect the power cord again and turn on the system. If the indicator still flashes, or if the cause of the problem cannot be found even after checking all the above items, consult your nearest Sony dealer.

Picture

There is no picture.

- The SCART (EURO AV) cord is not connected securely.
- The SCART (EURO AV) cord is damaged.
- The system is not connected to the correct  EURO AV INPUT jack (page 17).
- The video input on the TV is not set so that you can view pictures from the system.
- Check the output method on your system (page 60).

Picture noise appears.



- The disc is dirty or flawed.
- If the picture output from your system goes through your VCR to get to your TV, the copy-protection signal applied to some DVD programs could affect picture quality.

Even though you set the aspect ratio in “TV TYPE” or “SCREEN SETUP,” the picture does not fill the screen.

- The aspect ratio on your DVD of the disc is fixed.

Sound

There is no sound.

- The speaker cord is not connected securely.
- Press MUTE on the remote if “MUTING ON” is displayed in the front panel display.
- The system is in pause mode or in Slow-motion Play mode. Press  to return to normal play mode.
- Fast forward or fast reverse is performed. Press  to return to normal play mode.
- Check the speaker settings (pages 20, 61).

The left and right sounds are unbalanced or reversed.

- Check that the speakers and components are connected correctly and securely.
- Adjust the balance parameter in the BALANCE menu (page 62).

Severe hum or noise is heard.

- Check that the speakers and components are connected securely.
- Check that the connecting cords are away from a transformer or motor, and at least 3 metres away from a TV set or fluorescent light.
- Move your TV away from the audio components.
- The plugs and jacks are dirty. Wipe them with a cloth slightly moistened with alcohol.
- Clean the disc.

The sound loses stereo effect when you play a VIDEO CD, a CD, or an MP3.

- Set “AUDIO” to “STEREO” in the Control Menu display (page 39).
- Make sure the system is connected appropriately.

The surround effect is difficult to hear when you are playing a Dolby Digital or MPEG audio sound track.

- Make sure the sound field function is on (page 41).
- Check the speaker connections and settings (pages 20, 61).
- Depending on the DVD, the output signal may not be the entire 5.1 channel. It may be monaural or stereo even if the sound track is recorded in Dolby Digital or MPEG audio format.

The sound comes from the center speaker only.

- Depending on the disc, the sound may come from the center speaker only.

No sound is heard from the center speaker.

- Check the speaker connections and settings.
- Make sure the sound field function is on (page 41).

No sound or only a very low-level sound is heard from the surround speakers.

- Check the speaker connections and settings.
- Make sure the sound field function is on (page 41).

Operation

Radio stations cannot be tuned in.

- Check that the aerials are connected securely. Adjust the aerials and connect an external aerial if necessary.
- The signal strength of the stations is too weak (when tuning in with automatic tuning). Use direct tuning.
- No stations have been preset or the preset stations have been cleared (when tuning by scanning preset stations). Preset the stations (page 53).
- Press DISPLAY so that the frequency appears in the display.

The remote does not function.

- There are obstacles between the remote and the system.
- The distance between the remote and the system is too far.
- The remote is not pointed at the remote sensor on the system.
- The batteries in the remote are weak.
- Check the COMMAND MODE switch.

The disc does not play.

- There is no disc inserted.
- The disc is upside down. Insert the disc with the playback side facing down on the disc tray.
- The disc is skewed on the disc tray.
- The system cannot play CD-ROMs, etc. (page 7).
- The region code on the DVD does not match the system.
- Moisture has condensed inside the system. Remove the disc and leave the system turned on for about half an hour (page 2).

The MP3 audio track cannot be played.

- The DATA CD is not recorded in the MP3 format that conforms to ISO9660 Level 1/Level 2 or Joliet.
- The MP3 audio track does not have the extension “.MP3.”
- The data is not formatted in MP3 even though it has the extension “.MP3.”
- The system can play only MP3 (MPEG1 Audio Layer3) audio.
- Remove the disc and select “CUSTOM SETUP” from the setup items. Then select “DATA CD PRIORITY” and set to “MP3” again.
- Directory level is more than 8.

The title of the MP3 audio album or track is not correctly displayed.

- The system can only display numbers and alphabet. Other characters are displayed as “ ”.

The JPEG image file cannot be played.

- The DATA CD is not recorded in JPEG format that conforms to ISO9660 Level 1/Level 2 or Joliet.
- The JPEG image file does not have the extension “.JPG” or “.JPEG.”
- The data is not formatted in JPEG even though it has the extension “.JPG” or “.JPEG.”
- Image of length or width is more than 4720 dots.
- Remove the disc and select “CUSTOM SETUP” from the setup items. Then select “DATA CD PRIORITY” and set to “JPEG” again.
- Directory level is more than 8.

The title of the JPEG album or file is not correctly displayed.

- The system can only display numbers and alphabet. Other characters are displayed as “ ”.

The display for entering the password does not appear for Super Audio CD, even though Custom Parental Control is set.

- Custom Parental Control is set for different layers of a Super Audio CD.

The disc does not start playing from the beginning.

- Program Play, Shuffle Play, or Repeat Play has been selected (pages 28, 29, 30). Press CLEAR to cancel these functions before playing a disc.
- Resume Play has been selected. During stop, press ■ on the system or the remote and then start playback (page 22).
- The title, DVD or PBC menu automatically appears on the TV screen.

The system starts playing the disc automatically.

- The DVD features an auto playback function.

Playback stops automatically.

- Some discs may contain an auto pause signal. While playing such a disc, the system stops playback at the auto pause signal.

The system turned off during DVD playback.

- If approximately one hour passes with DVD playback paused or with the DVD top menu or a DVD menu displayed during DVD playback, the system automatically turns off.

You cannot perform some functions such as Stop, Search, Slow-motion Play, Repeat Play, Shuffle Play, or Program Play.

- Depending on the disc, you may not be able to perform some of the operations above. See the operating manual that comes with the disc.

Messages do not appear on the screen in the language you want.

- In the Setup Display, select the desired language for the on-screen display in “OSD” under “LANGUAGE SETUP” (page 58).

The language for the sound track cannot be changed.

- Multilingual tracks are not recorded on the DVD being played.
- The DVD prohibits changing the language for the sound track.

The subtitle language cannot be changed.

- Multilingual subtitles are not recorded on the DVD being played.
- The DVD prohibits changing the subtitles.

The subtitle cannot be turned off.

- The DVD prohibits turning off subtitles.

The angles cannot be changed.

- Multi-angles are not recorded on the DVD being played. (44 page)
- The DVD prohibits changing the angles.

A disc cannot be ejected and “LOCKED” appears in the front panel display.

- Contact your Sony dealer or local authorized Sony service facility.

The system does not work normally.

- If the system’s operation becomes effected, press  on the system to turn off the power, then turn on the power again.
-

Specifications

Amplifier section

Stereo mode	44 W + 44 W (6 ohms at 1 kHz, THD 10 %)
Surround mode	Front: 44 W + 44 W Center*: 44 W Surround*: 44 W + 44 W (6 ohms at 1 kHz, THD 10 %) Subwoofer*: 80 W (3 ohms at 100 Hz, THD 10 %)

* Depending on the sound field settings and the source, there may be no sound output.

Inputs	VIDEO 1: Sensitivity: 150 mV Impedance: 50 kilohms VIDEO 2: sensitivity: 300 mV Impedance: 50 kilohms
Outputs	VIDEO 1 (AUDIO OUT): Voltage: 1 V Impedance: 1 kilohm
Phones	Accepts low-and high-impedance headphones.

Super Audio CD/DVD system

Laser	Semiconductor laser (Super Audio CD/DVD: $\lambda = 650 \text{ nm}$) (CD: $\lambda = 780 \text{ nm}$) Emission duration: continuous
Signal format system	NTSC or NTSC/PAL
Frequency response (at 2 CH STEREO mode)	DVD (PCM): 2 Hz to 22 kHz ($\pm 1.0 \text{ dB}$) CD: 2 Hz to 20 kHz ($\pm 1.0 \text{ dB}$)
Harmonic distortion	Less than 0.03 %

Tuner section

System	PLL quartz-locked digital synthesizer system
FM tuner section	
Tuning range	87.5 – 108.0 MHz (50 kHz step)
Aerial	FM wire aerial
Aerial terminals	75 ohms, unbalanced
Intermediate frequency	10.7 MHz
AM tuner section	
Tuning range	531 – 1,602 kHz (with the interval set at 9 kHz)
Aerial	AM loop aerial
Intermediate frequency	450 KHz

Video section (VIDEO 1, 2, EURO AV)

Inputs	Video: 1 V _{p-p} 75 ohms
Outputs	Video: 1 V _{p-p} 75 ohms

Speakers

Front/Center/Surround

Speaker system	Bass reflex
Speaker unit	77 mm dia. cone type,
Rated impedance	6 ohms
Dimensions (approx.)	95 × 100 × 116 mm (w/h/d)
Mass (approx.)	0.8 kg

Subwoofer

Speaker system	Bass reflex
Speaker unit	160 mm dia. cone type,
Rated impedance	3 ohms
Dimensions (approx.)	197 × 335 × 370 mm (w/h/d)
Mass (approx.)	5.6 kg

General

Power requirements	230 V AC, 50/60 Hz
Power consumption	90 W (230 V AC) 0.3 W (230 V AC) (at the Power Saving Mode)
Dimensions (approx.)	355 × 75 × 360 mm (w/h/d) incl. projecting parts
Mass (approx.)	5.9 kg
Operating temperature	5°C to 35°C (41°F to 95°F)
Operating humidity	5 % to 90 %
Supplied accessories	See page 11.

Design and specifications are subject to change without notice.

Glossary

Album

Section of a music piece or an image on a data CD containing MP3 audio tracks or JPEG files.

Chapter

Subdivision of a title on a DVD. A title is composed of several chapters.

Dolby Digital

This sound format for movie theatres is more advanced than Dolby Surround Pro Logic. In this format, the surround speakers output stereo sound with an expanded frequency range and a subwoofer channel for deep bass is independently provided. This format is also called “5.1” because the subwoofer channel is counted as 0.1 channel (since it functions only when a deep bass effect is needed). All six channels in this format are recorded separately to realize superior channel separation. Furthermore, since all the signals are processed digitally, less signal degradation occurs.

Dolby Surround Pro Logic

As one method of decoding Dolby Surround, Dolby Surround Pro Logic produces four channels from two-channel sound. Compared with the former Dolby Surround system, Dolby Surround Pro Logic reproduces left-to-right panning more naturally and localizes sounds more precisely. To take full advantage of Dolby Surround Pro Logic, you should have one pair of surround speakers and a center speaker. The surround speakers output monaural sound.

Dolby Pro Logic II

Dolby Pro Logic II creates five full-bandwidth output channels from two-channel sources. This is done using an advanced, high-purity matrix surround decoder that extracts the spatial properties of the original recording without adding any new sounds or tonal colorations.

■ Movie mode

The Movie mode is for use with stereo television shows and all programs encoded in Dolby Surround. The result is enhanced soundfield directionality that approaches the quality of discrete 5.1-channel sound.

■ Music mode

The Music mode is for use with any stereo music recordings, and provides a wide and deep sound space.

DTS

Digital audio compression technology that the Digital Theater Systems, Inc. developed. This technology conforms to 5.1-channel surround. The rear channel is stereo and there is discrete subwoofer channel in this format. DTS provides the same 5.1 discrete channels of high quality digital audio. The good channel separation is realized because the all channel data is recorded discrete and processed in digital.

DVD

A disc that contains up to 8 hours of moving pictures even though its diameter is the same as a CD.

The data capacity of a single-layer and single-sided DVD, at 4.7 GB (Giga Byte), is 7 times that of a CD. Furthermore, the data capacity of a dual-layer and single-sided DVD is 8.5 GB, a single-layer and double-sided DVD 9.4 GB, and a dual-layer and double-sided DVD 17 GB.

The picture data uses the MPEG 2 format, one of the worldwide standards of digital compression technology. The picture data is compressed to about 1/40 of its original size. The DVD also uses the variable rate coding technology that changes the data to be allocated according to the status of the picture.

The audio data is recorded in Dolby Digital as well as in PCM, allowing you to enjoy more realistic audio presence.

Furthermore, various advanced functions such as the multi-angle, multilingual, and Parental Control functions are provided with the DVD.

File

Section of a picture on a data CD containing JPEG image files.

Film based software, Video based software

DVDs can be classified as Film based or Video based software. Film based DVDs contain the same images (24 frames per second) that are shown at movie theatres. Video based DVDs, such as television dramas or sit-coms, displays images at 30 frames (or 60 fields) per second.

Multi-angle function

Various angles, or viewpoints of the video camera, for a scene are recorded on some DVDs.

Multilingual function

Several languages for the sound or subtitles in a picture are recorded on some DVDs.

Parental Control

A function of the DVD to limit playback of the disc by the age of the users according to the limitation level in each country. The limitation varies from disc to disc; when it is activated, playback is completely prohibited, violent scenes are skipped or replaced with other scenes and so on.

Playback Control (PBC)

Signals encoded on VIDEO CDs (Version 2.0) to control playback.

By using menu screens recorded on VIDEO CDs with PBC functions, you can enjoy playing simple interactive programs, programs with search functions, and so on.

Region Code

This system is used to protect copyrights. A region number is allocated on each DVD system or DVD disc according to the sales region. Each region code is shown on the system as well as on the disc packaging. The system can play the discs that match its region code. The system can also play discs with the “” mark. Even when the region code is not shown on the DVD, the region limit may still be activated.

Scene

On a VIDEO CD with PBC (playback control) functions, the menu screens, moving pictures and still pictures are divided into sections called “scenes.”

Super Audio CD

This audio format is based upon the current audio CD standards but includes a greater amount of information which provides higher quality sound. There are three types of discs: single layer, double layer and hybrid discs. The hybrid disc contains both standard audio CD and Super Audio CD information.

Title

The longest section of a picture or music feature on a DVD, movie, etc., in video software, or the entire album in audio software.

Track

Section of a picture or a music piece on a Super Audio CD, CD, VIDEO CD or MP3. An album is composed of several tracks (MP3 only).

VIDEO CD

A compact disc that contains moving pictures. The picture data uses the MPEG 1 format, one of the worldwide standards of digital compression technology. The picture data is compressed to about 1/140 of its original size. Consequently, a 12 cm VIDEO CD can contain up to 74 minutes of moving pictures.

VIDEO CDs also contain compact audio data. Sounds outside the range of human hearing are compressed while the sounds we can hear are not compressed. VIDEO CDs can hold 6 times the audio information of conventional audio CDs.

There are 2 versions of VIDEO CDs.

- Version 1.1: You can play only moving pictures and sounds.
- Version 2.0: You can play high-resolution still pictures and enjoy PBC functions.

This system conforms to both versions.

Index to Parts and Controls

For more information, refer to the pages indicated in parentheses.

Front Panel

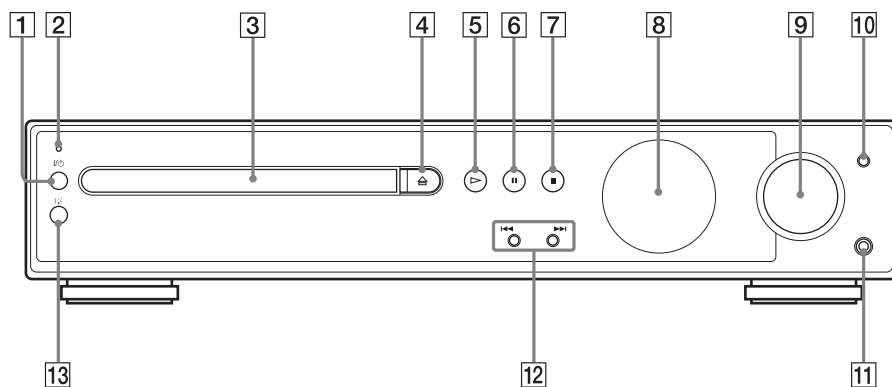

- | | |
|-----------------------------------|-----------------------------------------------|
| 1 I/⏻ (power) (21) | 9 VOLUME control (21, 62) |
| 2 STANDBY indicator (21) | 10 FUNCTION (21, 52, 54) |
| 3 Disc tray (21) | 11 PHONES jack (21) |
| 4 ⇄ (open/close) (21) | 12 ⏮/▶, PREV/NEXT, PRESET -/+ (22, 53) |
| 5 ▶ (play) (21) | 13 📶 (remote sensor) (11) |
| 6 ⏸ (pause) (22) | |
| 7 ■ (stop) (22) | |
| 8 Front panel display (71) | |

Front Panel Display

When playing back a DVD

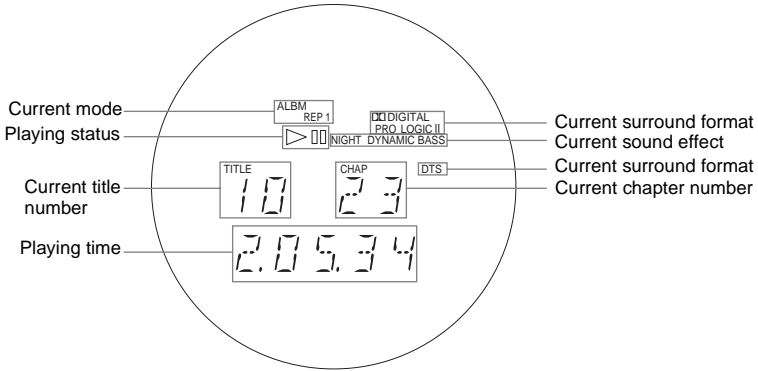

When playing back a Super Audio CD, CD, VIDEO CD, or MP3

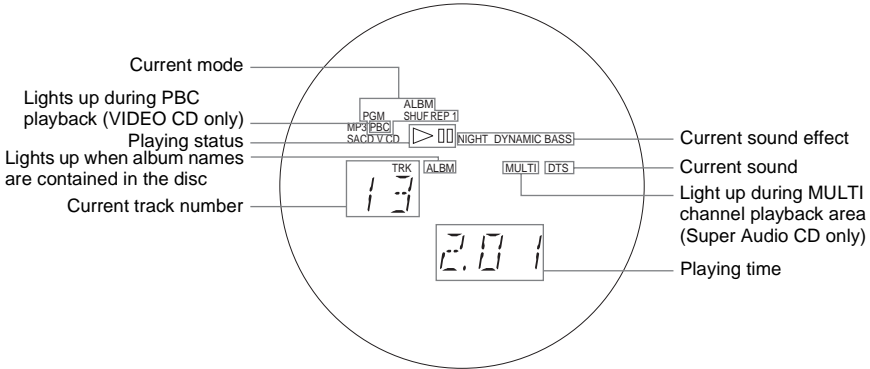

When listening to the radio

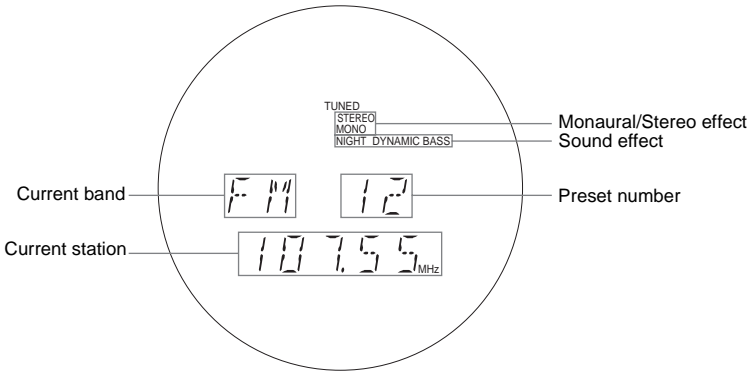

When playing back a JPEG

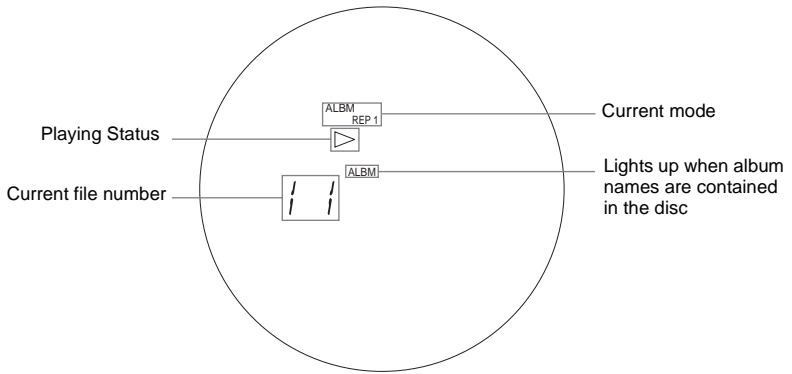

Rear Panel

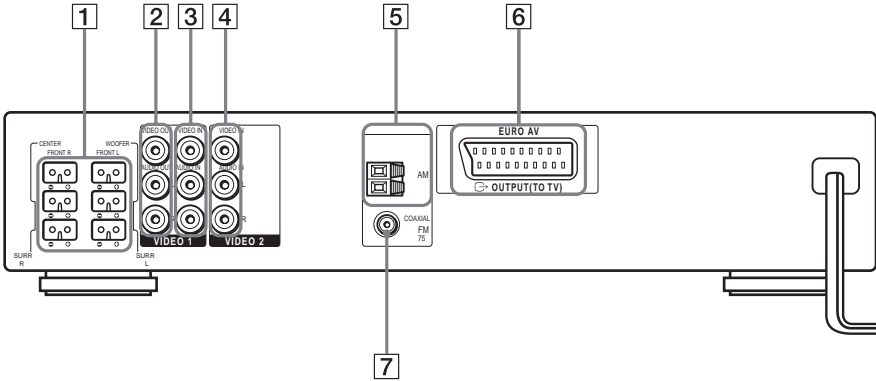

- 1** SPEAKER jacks (12)
- 2** VIDEO 1 ANALOG OUT jack (17)
- 3** VIDEO 1 ANALOG IN jack (17)
- 4** VIDEO 2 ANALOG IN jack (17)
- 5** AM terminals (15)
- 6** EURO AV OUTPUT (TO TV) jacks (17)
- 7** FM 75Ω COAXIAL jack (15)

Remote

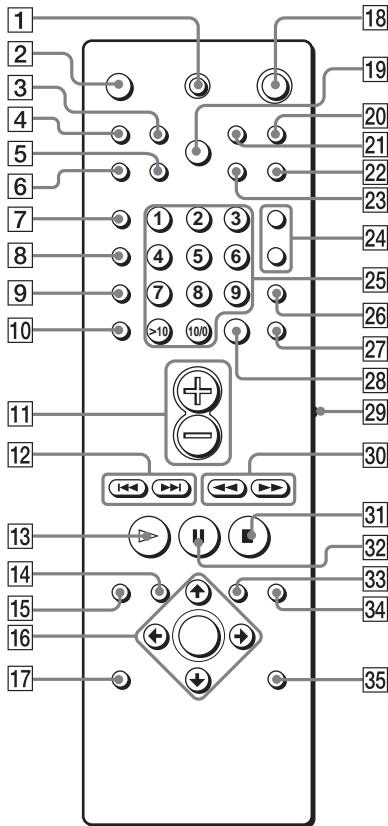

Note

This remote control glows in the dark. However, before glowing, the remote must be exposed to light for awhile.

- 1 TV I/⏻ (on/standby) (51)
- 2 SLEEP (55)
- 3 TV/VIDEO (51)
- 4 PLAY MODE (28, 29)
- 5 TUNER MENU (53)
- 6 REPEAT/FM MODE (28, 30, 54)
- 7 CLEAR (28, 29, 30, 33)
- 8 AUDIO (39)
- 9 ANGLE (44)
- 10 SUBTITLE (45)
- 11 VOL +/- (51, 54)

- 12 ⏪/⏩/⏮/⏭, PREV/NEXT, TV CH +/-, PRESET +/- (23, 51, 54)
- 13 ▷ PLAY/SELECT (21, 23, 28, 29, 30)
- 14 DVD TOP MENU/ALBUM- (23, 25, 26)
- 15 DVD DISPLAY (25, 26, 30, 33, 37, 39, 44, 45)
- 16 ⏪/⏩/⏮/⏭/ENTER (23, 25, 26, 28, 30, 32, 33, 39, 44, 45, 46, 53)
- 17 DVD SETUP (47, 57)
- 18 I/⏻ (standby) (21, 53)
- 19 DISPLAY (35, 37, 54)
- 20 DYNAMIC BASS (43)
- 21 MUTING (22)
- 22 NIGHT MODE (43)
- 23 AUTO FORMAT DIRECT (41)
- 24 SOUND FIELD +/- (41, 42)
- 25 Number buttons (23, 28, 33, 44, 46, 51)
- 26 FUNCTION (21, 52, 54)
- 27 TUNER/BAND (53, 54)
- 28 ENTER (51)
- 29 COMMAND MODE switch (11, 51)
- 30 ⏪/⏩/⏮/⏭ SLOW, TUNING +/- (31, 53)
- 31 ■ STOP (23, 46)
- 32 || PAUSE (22)
- 33 DVD MENU/ALBUM+ (23, 25, 26)
- 34 ↶ RETURN (23, 25, 26, 46, 57)
- 35 DIMMER (55)

Language code list

The language spellings conform to the ISO 639: 1988 (E/F) standard.

Code	Language	Code	Language	Code	Language
1027	Afar	1245	Inupiak	1489	Russian
1028	Abkhazian	1248	Indonesian	1491	Kinyarwanda
1032	Afrikaans	1253	Icelandic	1495	Sanskrit
1039	Amharic	1254	Italian	1498	Sindhi
1044	Arabic	1257	Hebrew	1501	Sangho
1045	Assamese	1261	Japanese	1502	Serbo-Croatian
1051	Aymara	1269	Yiddish	1503	Singhalese
1052	Azerbaijani	1283	Javanese	1505	Slovak
1053	Bashkir	1287	Georgian	1506	Slovenian
1057	Byelorussian	1297	Kazakh	1507	Samoa
1059	Bulgarian	1298	Greenlandic	1508	Shona
1060	Bihari	1299	Cambodian	1509	Somali
1061	Bislama	1300	Kannada	1511	Albanian
1066	Bengali; Bangla	1301	Korean	1512	Serbian
1067	Tibetan	1305	Kashmiri	1513	Siswati
1070	Breton	1307	Kurdish	1514	Sesotho
1079	Catalan	1311	Kirghiz	1515	Sundanese
1093	Corsican	1313	Latin	1516	Swedish
1097	Czech	1326	Lingala	1517	Swahili
1103	Welsh	1327	Laothian	1521	Tamil
1105	Danish	1332	Lithuanian	1525	Telugu
1109	German	1334	Latvian; Lettish	1527	Tajik
1130	Bhutani	1345	Malagasy	1528	Thai
1142	Greek	1347	Maori	1529	Tigrinya
1144	English	1349	Macedonian	1531	Turkmen
1145	Esperanto	1350	Malayalam	1532	Tagalog
1149	Spanish	1352	Mongolian	1534	Setswana
1150	Estonian	1353	Moldavian	1535	Tonga
1151	Basque	1356	Marathi	1538	Turkish
1157	Persian	1357	Malay	1539	Tsonga
1165	Finnish	1358	Maltese	1540	Tatar
1166	Fiji	1363	Burmese	1543	Twi
1171	Faroese	1365	Nauru	1557	Ukrainian
1174	French	1369	Nepali	1564	Urdu
1181	Frisian	1376	Dutch	1572	Uzbek
1183	Irish	1379	Norwegian	1581	Vietnamese
1186	Scots Gaelic	1393	Occitan	1587	Volapük
1194	Galician	1403	(Afan) Oromo	1613	Wolof
1196	Guarani	1408	Oriya	1632	Xhosa
1203	Gujarati	1417	Punjabi	1665	Yoruba
1209	Hausa	1428	Polish	1684	Chinese
1217	Hindi	1435	Pashto; Pushto	1697	Zulu
1226	Croatian	1436	Portuguese		
1229	Hungarian	1463	Quechua	1703	Not specified
1233	Armenian	1481	Rhaeto-Romance		
1235	Interlingua	1482	Kirundi		
1239	Interlingue	1483	Romanian		

DVD Setup Menu List

You can set the following items with the DVD Setup menu.

The order of the displayed items may be different from the actual display.

LANGUAGE SETUP

- OSD — (Select the language you want to use from the displayed language list.)
- DVD MENU — (Select the language you want to use from the displayed language list.)
- AUDIO — (Select the language you want to use from the displayed language list.)
- SUBTITLE — (Select the language you want to use from the displayed language list.)

CUSTOM SETUP

- PARENTAL CONTROL
 - LEVEL
 - 8.
 - 7. NC17
 - 6. R
 - 5.
 - 4. PG13
 - 3. PG
 - 2.
 - 1. G
 - STANDARD
 - USA
 - OTHERS →
 - CHANGE PASSWORD
- TRACK SELECTION
 - OFF
 - AUTO
- AUDIO DRC
 - OFF
 - STANDARD
 - MAX
- DATA CD PRIORITY
 - MP3
 - JPEG
- JPEG DATE
 - MM/DD/YYYY
 - YYYY/MM/DD
 - DD/MM/YYYY
 - YYYY/DD/MM

SCREEN SETUP

- TV TYPE
 - 16:9
 - 4:3 LETTER BOX
 - 4:3 PAN SCAN
- SCREEN SAVER
 - ON
 - OFF
- BACKGROUND
 - JACKET
 - PICTURE
 - GRAPHICS
 - BLUE
 - BLACK
- LINE
 - VIDEO
 - RGB

SPEAKER SETUP

- SIZE
 - FRONT — YES
 - CENTER — YES
 - NONE
 - SURROUND — YES
 - NONE
 - SUBWOOFER — YES
- DISTANCE
 - FRONT — 1.0m - 7.0m
 - CENTER — 1.0m - 7.0m
 - SURROUND — 1.0m - 7.0m
- LEVEL
 - CENTER — -6 dB - +6 dB
 - SURROUND — -6 dB - +6 dB
 - LEFT
 - SURROUND — -6 dB - +6 dB
 - RIGHT
 - SUBWOOFER — -6 dB - +6 dB
- BALANCE — FRONT — 6 steps left or right
- TEST TONE
 - OFF
 - ON

RESET

- YES
- NO

Index

Numerics

16:9 59
4:3 LETTER BOX 59
4:3 PAN SCAN 59

A

Aerial Hookups 15
ALBUM 25, 33
Album 6, 67
ANGLE 44
AUDIO 39, 58
AUDIO DRC 61

B

BACKGROUND 59
BALANCE 62
Batteries 11

C

CHAPTER 34
Chapter 6, 67
Continuous play
 CD/VIDEO CD/Super Audio
 CD/DVD/MP3 21
Control Menu 9
CUSTOM PARENTAL
 CONTROL 46
CUSTOM SETUP 60

D

DATA CD PRIORITY 61
DIMMER 56
DISPLAY 35
DISTANCE 62
Dolby Digital 67
Dolby Surround Pro Logic 67
DTS 68
DVD 68
DVD MENU 58
DYNAMIC BASS 43

F

Fast forward 31
Fast reverse 31
File 6, 68
Front Panel 70
Front panel display 71

H

Handling discs 8

I

INDEX 34
Index 6

J

JPEG 26
JPEG DATE 61

L

LANGUAGE SETUP 58
LEVEL 62
LINE 60

M

MP3 24
Multi-angle function 44, 68
Multilingual function 39, 68
MUTING 22

N

NIGHT MODE 43

O

On-screen display
 Control Menu display 9
OSD 58

P

PARENTAL CONTROL 47, 60,
 68
PBC Playback 23, 68
PLAY MODE 28, 29
Power Saving 21
Preset Station 53
Program Play 28

R

Radio 54
RDS 55
Rear Panel 73
Region Code 7, 68
Remote 11, 51, 74
REPEAT/FM MODE 30, 54
RESET 58
Resume Play 22

S

Scan 31
SCENE 9
Scene 6, 68
SCREEN SAVER 59
SCREEN SETUP 59
Setup Display 57
SHUFFLE 29
Shuffle Play 29
SIZE 61
SLEEP 55
Slide show 32
Slow-motion 31
Sound Field 41
SPEAKER SETUP 61
Speaker System Hookup 12
SUBTITLE 58
Super Audio CD 68

T

TEST TONE 62
TIME SEARCH 33
TITLE 33
Title 6, 69
TRACK 33
Track 6, 69
TRACK SELECTION 60
Troubleshooting 64
TUNER MENU 53
TV and Video Component
 Hookups 17, 19
TV TYPE 59

U

Usable discs 6

V

VIDEO CD 69

Quick reference for Remote Commander

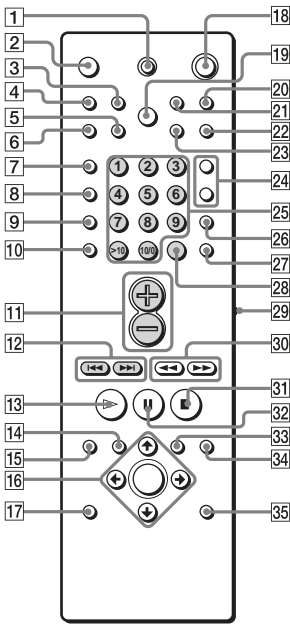

Note

The remote control of the unit employs command signals in common with other Sony DVD products. Thus, depending on the button, other Sony DVD products may respond.

Tip

Shaded parts buttons are affected by the COMMAND MODE switch. Descriptions in *italic* refer to the TV setting of the switch.

- 1** Turns the TV on and off.
- 2** Sets the system to turn off at a preset time.
- 3** Changes the input mode of the TV.
- 4** Selects program or shuffle play mode.
- 5** Press to store a preset station.
- 6** Disc: Displays the "REPEAT" display on the TV screen.
Radio: Switches monaural or stereo of FM stereo reception.
- 7** Press to return to the Continuous play, etc.
- 8** Changes the sound while playing a DVD or VIDEO CD.
- 9** Changes the angles when playing a DVD.
- 10** Displays the "SUBTITLE" menu in the Control Menu display.
- 11** Adjust the SYSTEM volume.
TV : Adjust the TV volume.
- 12** **◀◀/▶▶**, PREV/NEXT : Press to go to the next chapter or track or to go back to the previous chapter or track.
PRESET -/+ : Scan all preset stations.
TV CH -/+ : Select the TV Channel
- 13** Plays a disc.
- 14** Displays the title menu on the TV screen.
MP3/JPEG: Select albums
- 15** Displays the Control Menu display on the TV screen to set or adjust the items.
- 16** Selects and executes the items or settings.
- 17** Displays the setup display on the TV screen to set or adjust the items.
- 18** Turns on and off the power of the system.
- 19** Switches the item displayed on the front panel display.
- 20** Bass sound is effectively reinforced.
- 21** Mutes the sound.
- 22** Makes sound clear at low volume.
- 23** Press to change "A.F.D AUTO" directly.
- 24** Selects the sound field.
- 25** Selects the items of settings.
*TV: Selects channel numbers.**
- 26** Selects the component you want to use.
- 27** Selects AM or FM band.
- 28** Executes the items or settings.
TV : Press after selecting a channel number
- 29** Switches the TV's input source between the TV and SYSTEM.
- 30** **◀◀/▶▶** (SCAN) : Locate a point while monitoring the picture while playing disc.
◀|▶ SLOW : Play a disc in slow motion in the pause mode.
TUNING -/+ : Scan all available radio stations.
- 31** Stops playing a disc.
- 32** Pauses playing a disc.
- 33** Displays the DVD menu on the TV screen.
MP3/JPEG: Select albums
- 34** Press to return to the previously selected screen, etc.
- 35** Changes the brightness of the front panel display by two steps.

* Depending on the TV manufacture, the following method works. For double-digit number, press -/- first and then number. (For example, for channel 25, press -/-, then 2 and 5.)