

# PRIMA

## COMBINATION FLAT COLOR TELEVISION AND DVD/VCD/CD PLAYER

Owner's Manual

DV2018

DV2418

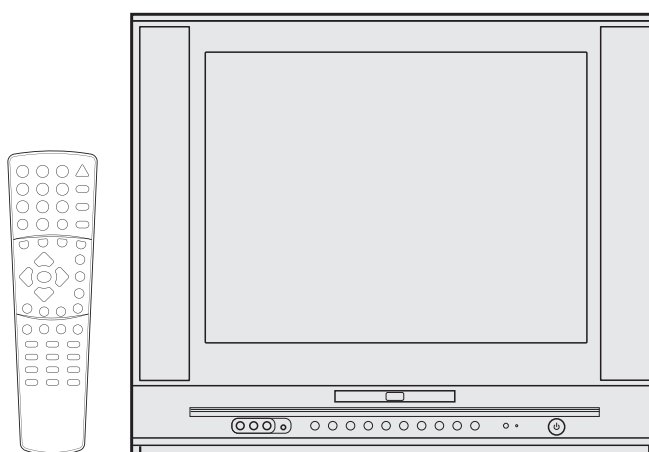

Before operating the unit, please read this manual thoroughly.

---

# Table of Contents

<b>Important Safety Instructions</b> -----	1
<b>Getting Started</b> -----	3
Front -----	3
Back-----	4
Remote Control -----	5
Installing batteries -----	6
Effective range of the Remote-----	6
<b>Installation</b> -----	7
Antenna connections -----	7
Cable (CATV) satellite connections -----	8
Using an Audio Amplifier-----	9
Using an AV Amplifier with built-in digital surround -----	9
Connecting AV1 inputs-----	10
Connecting AV2 inputs-----	10
<b>TV Operation Guide</b>	
<b>Power on/off</b> -----	11
Turning on-----	11
Turning off-----	11
<b>Select the Video Input</b> -----	12
Watching AV program -----	12
Switching from AV to TV -----	12
<b>Tuning</b> -----	13
To enter the TUNING menu -----	13
Setting the TV/Cable option -----	13
Auto Search -----	13
Erasing an unnecessary channel -----	14
Fine tuning -----	14
Setting the Color System-----	15
<b>Channel Selection</b> -----	16
<b>Adjusting Picture</b> -----	17
To enter the PICTURE menu-----	17
Adjusting picture-----	17
Selecting picture mode -----	17
Setting SVM option -----	18
Setting Blue background option -----	18
Setting Noise reducer option -----	18
<b>Sound</b> -----	19
Adjusting volume -----	19
To enter the SOUND menu -----	19
Adjusting sound -----	20
Selecting sound mode -----	20
Setting S.woofer item -----	20
<b>Timer</b> -----	21
To enter the TIMER menu-----	21
Setting Clock -----	21
Setting Sleep timer -----	21
Setting Off Time -----	22
Setting On Time -----	22
<b>System Setup</b> -----	23
To enter the SET UP menu -----	23
Selecting a language-----	23
Menu Demo-----	23
Setting Closed Caption(CCD)-----	24
Selecting audio mode -----	24
Recalling On-screen display -----	24
<b>Parental Control</b> -----	25
<b>Child lock</b> -----	25
To enter Child lock submenu -----	25
Setting Child lock-----	25
Changing password -----	25
<b>Setting V-chip</b> -----	26
To enter V-chip menu -----	26
MPAA RATING SET-UP -----	26
TV RATING SET-UP -----	27
Setting individual Content Categories for TV Rating -----	28
CANADIAN ENGLISH RATING SET-UP -----	28
CANADIAN FRENCH RATING SET-UP -----	29
Changing password -----	29
<b>DVD Operation Guide</b>	
<b>Disc Information</b> -----	31
<b>Basic Playback</b> -----	32
<b>Using On-screen Menu</b> -----	34
<b>Locating Desired Scene</b> -----	35
<b>Displaying Status of Disc</b> -----	36
<b>Special Functions</b> -----	37
Zooming -----	37
Setting soundtrack language -----	37
Repeat playback -----	37
Changing Angles [DVD] -----	38
Changing Subtitle languages [DVD]-----	38
<b>Initial Settings</b> -----	39
GENERAL SETUP-----	39
AUDIO SETUP-----	41
VIDEO SETUP-----	42
PREFERENCE SETUP -----	43
<b>Playing Back MP3 disc</b> -----	45
PLAYBACK OPERATIONS-----	45
PLAY MODE selection -----	46
<b>Playing Back Kodak Picture CD</b> -----	47
PLAYBACK OPERATIONS-----	47
PLAY MODE selection -----	47
Setting picture transition effects -----	48
Zooming picture -----	48
Rotating/Mirroring picture -----	48
Browsing pictures -----	48
<b>Other Information</b>	
Setting the Universal Remote Control Unit ----	49
Troubleshooting Guide-----	55
Reception Disturbances -----	57
Specifications -----	58

## Important Safety Instructions

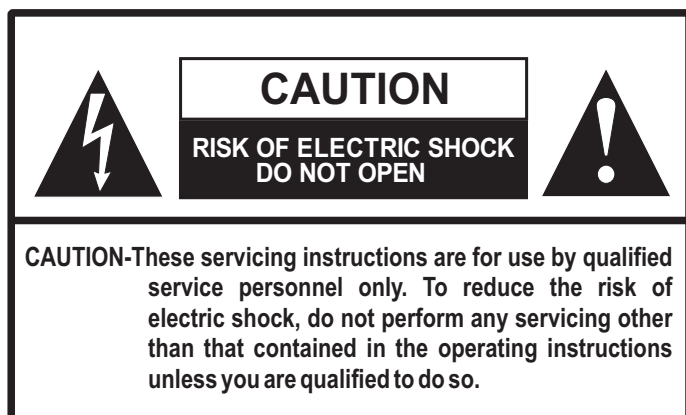

The lightning flash with arrowhead symbol, within an equilateral triangle is intended to alert the user to the presence of uninsulated dangerous voltage within the product's enclosure that may be of sufficient magnitude to constitute a risk of electric shock to persons.

The exclamation point within an equilateral triangle is intended to alert the user to the presence of important operating and maintenance (servicing) instructions in the literature accompanying the appliance.

**WARNING:** To reduce the risk of fire or electric shock, do not expose this apparatus to rain or moisture.

**Before using the unit, be sure to read all operating instructions carefully. Please note that these are general precautions and may not pertain to your particular unit. For example, this unit may not have the capability to be connected to an outdoor antenna.**

1. Read these instructions.
2. Keep these instructions.
3. Heed all warnings.
4. Follow all instructions.
5. Do not use this apparatus near water.
6. Clean only with dry cloth.
7. Do not block any ventilation openings. Install in accordance with the manufacturer instructions.
8. Do not install near any heat sources such as radiators, heat registers, stoves, or other apparatus (including amplifiers) that produce heat.
9. Do not defeat the safety purpose of the polarized or grounding-type plug. A polarized plug has two blades with one wider than the other. A grounding type plug has two blades and a third grounding prong. The wide blade or the third prong are provided for your safety. If the provided plug does not fit into your outlet, consult an electrician for replacement of the obsolete outlet.
10. Protect the power cord from being walked on or pinched particularly at plugs, convenience receptacles, and the point where they exit from the apparatus.
11. Only use attachments/accessories specified by the manufacturer.
12. Use only with the cart, stand, tripod, bracket, or table specified by the manufacturer, or sold with the apparatus. When a cart is used, use caution when moving the cart/apparatus combination to avoid injury from tip-over.
13. Unplug this apparatus during lightning storms or when unused for long periods of time.
14. Refer all servicing to qualified service personnel. Servicing is required when the apparatus has been damaged in any way, such as power-supply cord or plug is damaged, liquid has been spilled or objects have fallen into the apparatus, the apparatus has been exposed to rain or moisture, does not operate normally, or has been dropped.

PORTABLE CART WARNING  
(symbol provided by RETAC)



S3126A

## Important Safety Instructions

15. Do not overload wall outlets and extension cords as this can result in a risk of fire or electric shock.
16. Apparatus shall not be exposed to dripping or splashing and no objects filled with liquids, such as vases, shall be placed on the apparatus.
17. If an outside antenna is connected to the product, be sure the antenna system is grounded so as to provide some protection against voltage surges and built-up static charges. Section 810 of the National Electric Code, ANSI/NFPA 70, provides information with respect to proper grounding of the mast and supporting structure, grounding of the lead-in wire to an antenna discharge product, size of grounding conductors, location of antenna discharge product, connection to grounding electrodes, and requirements for grounding electrodes.
18. Refer all servicing to qualified service personnel. Servicing is required when the apparatus has been damaged in any way, such as power-supply cord or plug is damaged, liquid has been spilled or objects have fallen into the apparatus, the apparatus has been exposed to rain or moisture, does not operate normally, or has been dropped.
19. When replacement parts are required, be sure the service technician uses replacement parts specified by the manufacturer or those that have the same characteristics as the original part. Unauthorized substitutions may result in fire, electric shock or other hazards.
20. Upon completion of any service or repairs to this product, ask the service technician to perform safety checks to determine that the product is in proper operating condition.
21. The product should be mounted to a wall or ceiling only as recommended by the manufacturer.
22. Unplug the product from the wall outlet and refer servicing to qualified service personnel under the following conditions:
  - a. When the power-supply cord or plug is damaged.
  - b. If liquid has been spilled, or objects have fallen into the product.
  - c. If the product has been exposed to rain or water.
  - d. If the product does not operate normally after installation by following the operating instructions. Adjust only those controls that are covered by the operating instructions, as adjustment of other controls may result in damage and will often require extensive work by a qualified technician to restore the product to its normal operation.
  - e. If the product has been dropped or the cabinet has been damaged.
  - f. When the product exhibits a distinct change in performance.
23. This reminder is provided to call the Cable system installer's attention to Article 820-40 of the NEC that provides guidelines for proper grounding and, in particular, specifies that the cable ground shall be connected to the grounding system of the building, as close to the point of cable entry as practical.
24. Product complies with DHHS rule 21 CFR subchapter J in effect at date of manufacture.

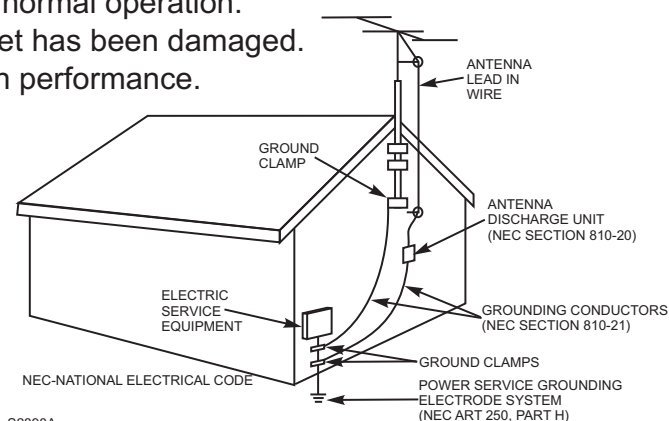

EXAMPLE OF ANTENNA GROUNDING AS PER NATIONAL ELECTRICAL CODE

**CAUTION:** use of any controls, adjustments, or procedures other than those specified herein may result in hazardous radiation exposure.

**WARNING:** FOR CONTINUED SAFETY, REPLACE SAFETY CRITICAL COMPONENTS ONLY WITH MANUFACTURER'S RECOMMENDED PARTS (REFER TO SERVICE LITERATURE).

# Getting Started

## Front

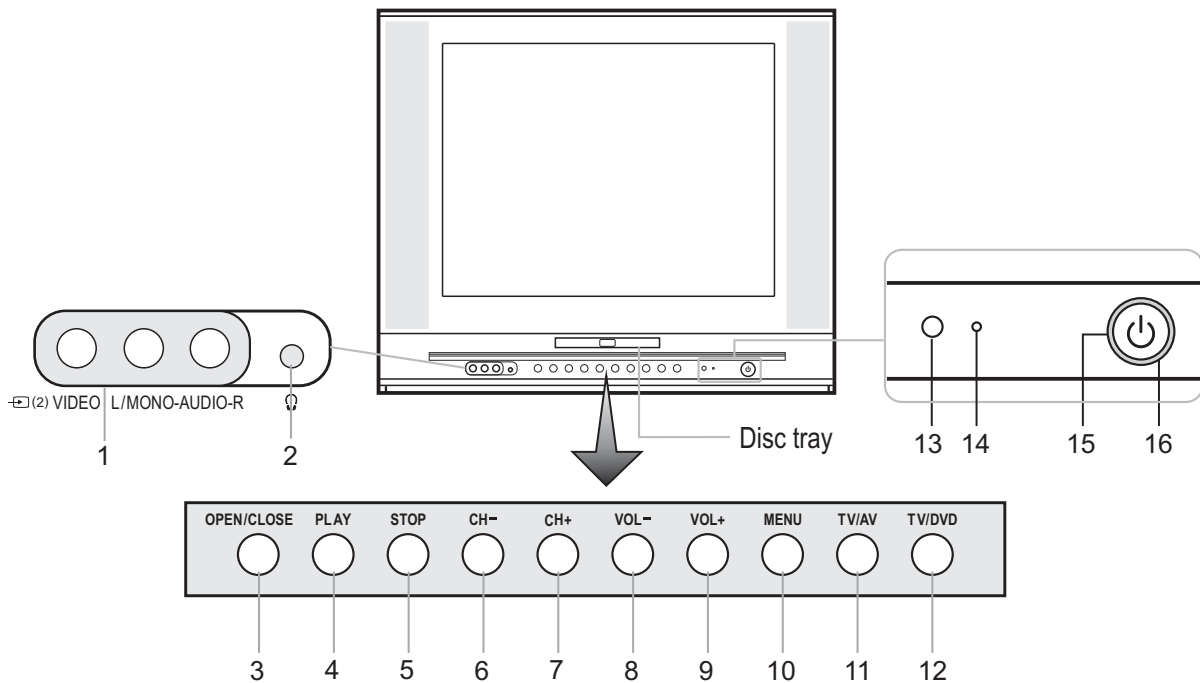

1. AV2 inputs (VIDEO, AUDIO L/MONO, R)
2. Earphone jack
3. Open/close disc tray
4. Playback
5. Stop playback
6. Channel down select; menu item select
7. Channel up select; menu item select
8. Volume down adjust; menu item adjust
9. Volume up adjust; menu item adjust
10. Display MENU of TV
11. Video input select
12. Switch between TV/AV and DVD
13. Remote sensor
14. Power indicator (red)
15. Purple indicator
16. Power button

# Getting Started<sub>(continued)</sub>

Back

DV2018

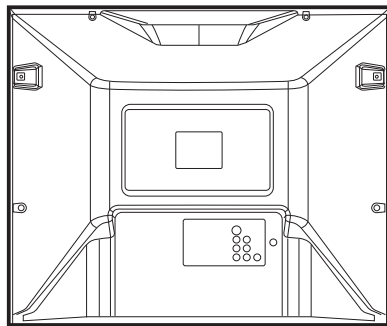

DV2418

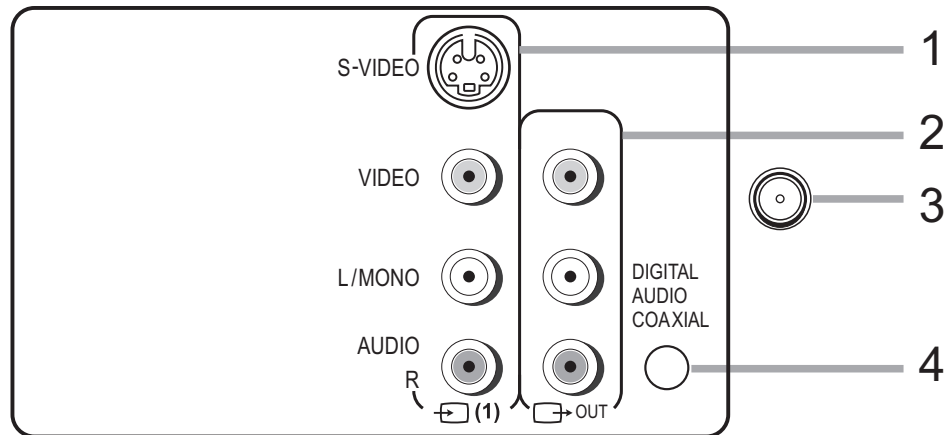
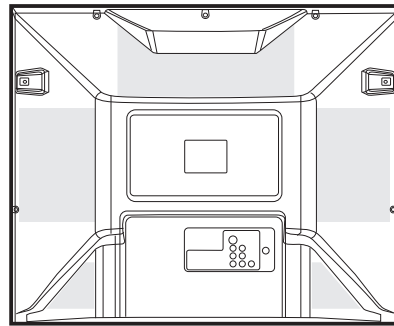

1. AV1 inputs (S-VIDEO, VIDEO, AUDIO L/MONO, R)
2. Monitor outputs (VIDEO, AUDIO L/MONO, R)
3. Antenna input
4. DIGITAL AUDIO COAXIAL OUTPUT jack

# Getting Started<sub>(continued)</sub>

## Remote Control

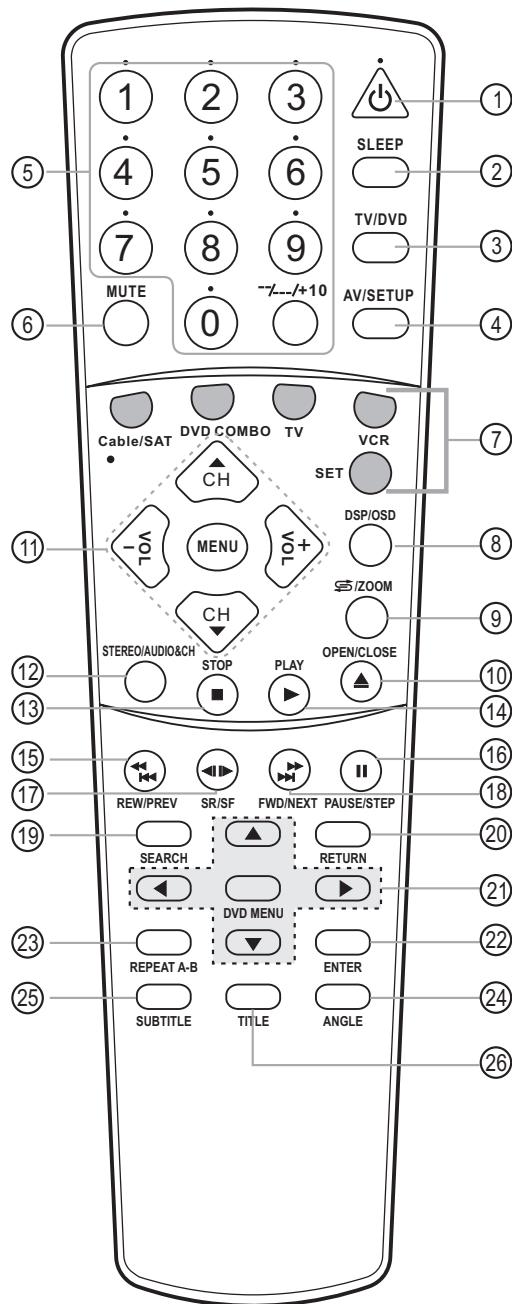

1. Power on/off
2. Sleep timer
3. Switch between TV/AV and DVD
4. Video input select  
Display initial setup menu
5. Number buttons (Keyboard)
6. Mute the sound
7. Remote control unit selection
8. Display TV information  
Display DVD information
9. Switch between present/previous channel  
Zoom (DVD)
10. Open or close the DVD disc tray
11. **VOL+/-**: adjust volume; adjust menu item  
**CH+/-**: Select channel; Select menu item  
**MENU**: Display menu of TV
12. Switch the sound of TV  
Change DVD language selection
13. Stop playback
14. Playback
15. Reverse playback  
Chapter Back
16. Pause playback  
Step playback
17. Forward/Reverse-slow motion
18. Forward playback  
Chapter forward
19. Locate desired scene
20. Return to previous menu screen
21. DVD MENU: Display DVD menu  
▲ ▼ ► ◀ : Cursor buttons
22. Enter information in menu
23. Repeat playback between A and B
24. Change playback angle
25. Set subtitle
26. Go to DVD title menu

# Getting Started<sub>(continued)</sub>

## ! Important:

Your remote control has been preprogrammed. If your remote controller does not work correctly, maybe the setting is wrong, please try the following steps.

1. Press and hold the "SET" button, followed by the "DVD COMBO" button at the same time until the indicator lights up.
2. Press 1, 4, 7 buttons one by one. As a response, the indicator of the remote control will twinkle twice, otherwise please repeat the above 2 steps.

## Installing batteries

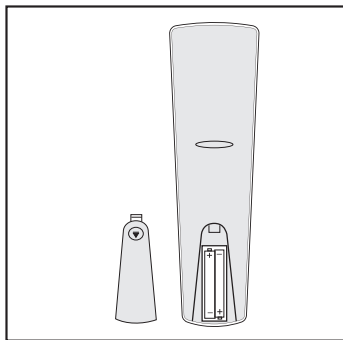

- 1 Slide the battery compartment cover in the direction of the arrow.
- 2 Install two "AAA" batteries matching the +/- polarities of the battery to the +/- marks inside the battery compartment.
- 3 Replace the compartment cover.

## ! Notes:

- \* Do not try to recharge batteries they are not rechargeable.
- \* Use only the size and type of batteries specified. Do not mix different types of batteries together or old batteries with fresh ones.
- \* When the remote control will not be used for a long period of time or when the batteries are worn out, remove the batteries.
- \* Do not throw the batteries into a fire. Do not drop, dampen or disassemble the remote control. Dispose of used batteries in the specified manner.

## Effective range of the Remote

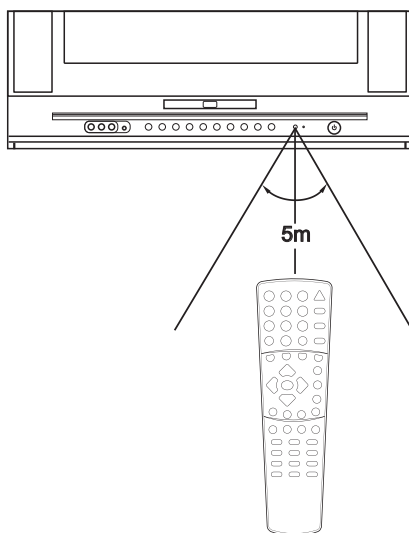

## ! Notes:

- \* Aim the remote control at the remote sensor and press control buttons to operate.
- \* Operate the remote control within 30° angle on either side of the remote sensor, up to a distance of approx. 5 meters or 16 feet.
- \* When there is an obstacle between the TV/DVD and the transmitter, the transmitter may not operate.
- \* When direct sunlight, and incandescent lamp, fluorescent lamp or any other strong light shines on the REMOTE SENSOR of the TV/DVD, the operation of the remote may be unstable.



# Installation

INSTALL the unit in a room where direct light will not fall upon the screen.  
Tip: Total darkness or a reflection on the picture screen may cause eyestrain. For best results, soft, indirect lighting is recommended.

## Antenna connections

### OUTDOOR VHF/UHF ANTENNA CONNECTION (ANTENNA NOT INCLUDED)

Follow the instructions for the type of antenna system you intend to use. If using Cable or satellite, see the next page.

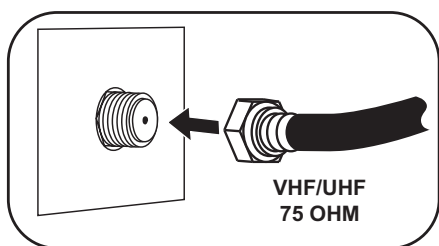

#### Combination VHF/UHF Antenna (Single 75 ohm cable or 300 ohm twin-lead wire)

Connect the 75 ohm cable from combination VHF/UHF antenna to the antenna jack.

**OR**

If your combination antenna has a 300 ohm twin-lead wire, use a 300-75 ohm matching transformer (NOT SUPPLIED).

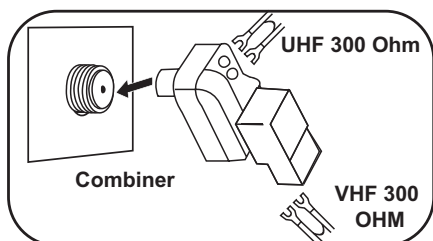

#### Combination VHF/UHF Antenna (Separate VHF and UHF 300 ohm twin-leads)

Connect the UHF twin-lead wire to a combiner (NOT SUPPLIED). Connect the VHF twin-lead to a 300-75 ohm matching transformer (NOT SUPPLIED). Attach the transformer to the combiner. Attach the combiner to the antenna jack.

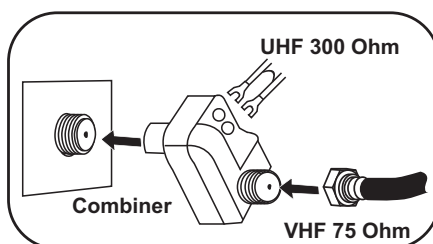

#### Separate VHF/UHF Antennas

Connect the 75 ohm cable from the VHF antenna and the UHF antenna twin-lead wire to a combiner (NOT SUPPLIED). Attach the combiner to the antenna jack.

**NOTE:** If your VHF antenna has a twin-lead wire use a 300-75 ohm matching transformer, then connect the transformer to the combiner.

# Installation (continued)

## Cable (CATV)/satellite connections

This TV has an extended tuning range and can tune most cable channels without using a Cable TV converter box. Some Cable TV companies offer "premium pay channels" in which the signal is scrambled. Descrambling these signals for normal viewing requires the use of a descrambling device and is generally provided by the cable company.

### FOR SUBSCRIBERS TO BASIC CABLE TV SERVICE

For basic cable service not requiring a converter/descrambler box, connect the CATV 75 ohm coaxial cable to the VHF/UHF jack on the rear of the DVD Combo.

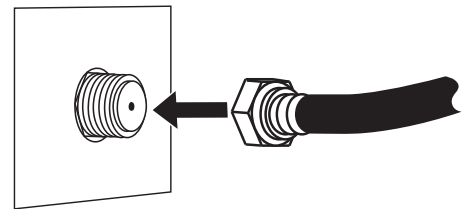

### FOR SUBSCRIBERS TO SCRAMBLED CABLE TV SERVICE OR SATELLITE

If you subscribe to a satellite service or a cable TV service which requires the use of a converter/descrambler box, connect the incoming 75 ohm coaxial cable to the converter/descrambler box. Using another 75 ohm cable, connect the output of the converter/descrambler or satellite box to the antenna jack on the DVD Combo. Follow the connections shown below. Set the DVD Combo to the output channel of the converter/descrambler or satellite box (usually 3 or 4) and use the converter/descrambler or satellite box to select channels.

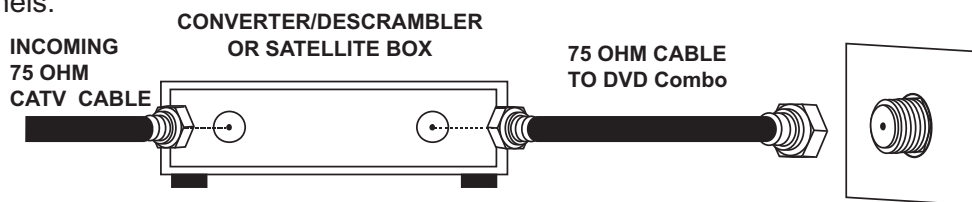

### FOR SUBSCRIBERS TO UNSCRAMBLED BASIC CABLE TV SERVICE WITH SCRAMBLED PREMIUM CHANNELS

If you subscribe to a satellite service or a cable TV service in which basic channels are unscrambled and premium channels require the use of a converter/descrambler box, you may wish to use a signal splitter and an A/B switch box (available from the cable company or an electronic supply store). Follow the connections shown below. With the switch in the "B" position, you can directly tune any unscrambled channels on your DVD Combo. With the switch in the "A" position, tune your DVD Combo to the output of the converter/descrambler box (usually channel 3 or 4) and use the converter/descrambler box to tune scrambled channels.

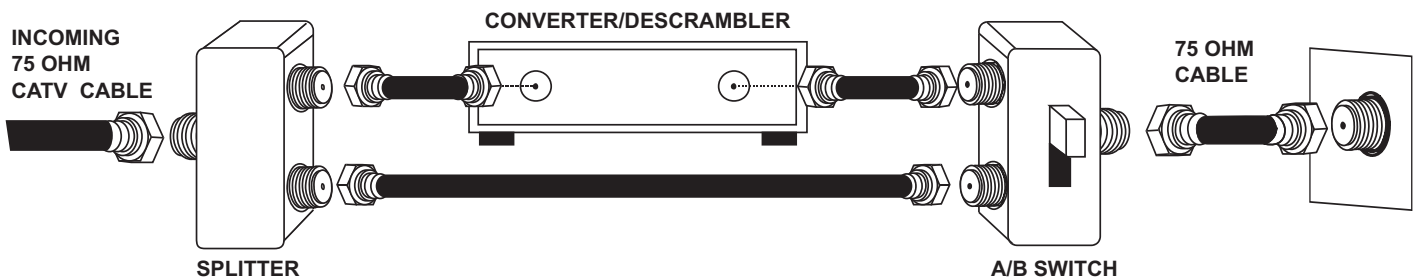

# Installation

This TV set provides 2 groups of AV inputs (including S-VIDEO) and 1 group of MONITOR outputs for your convenient connection to VCR, Camcorder, Amplifier or other equipment. Check the **Owner's Manual** of the equipment to be connected as well.

## Using an Audio Amplifier

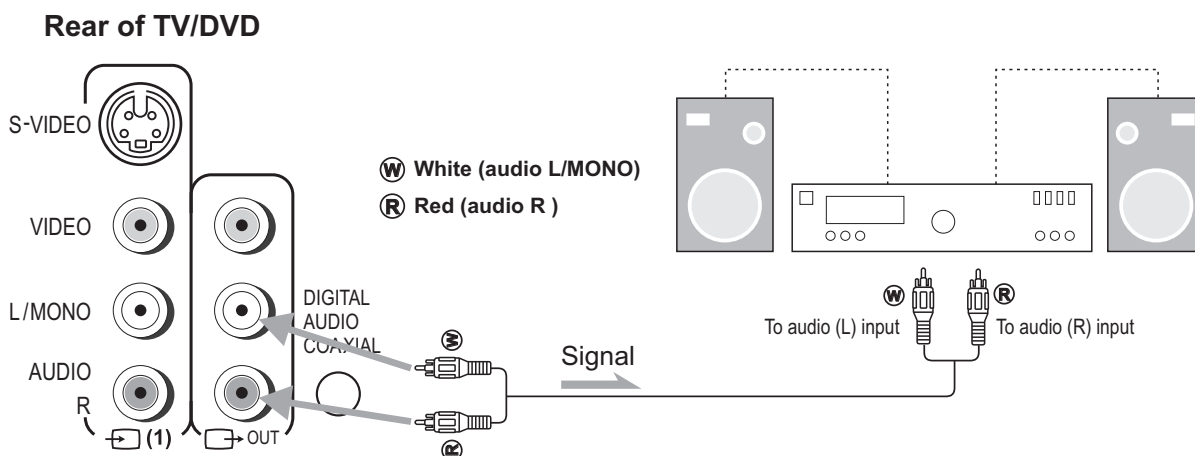

## Using an AV Amplifier with built-in digital surround

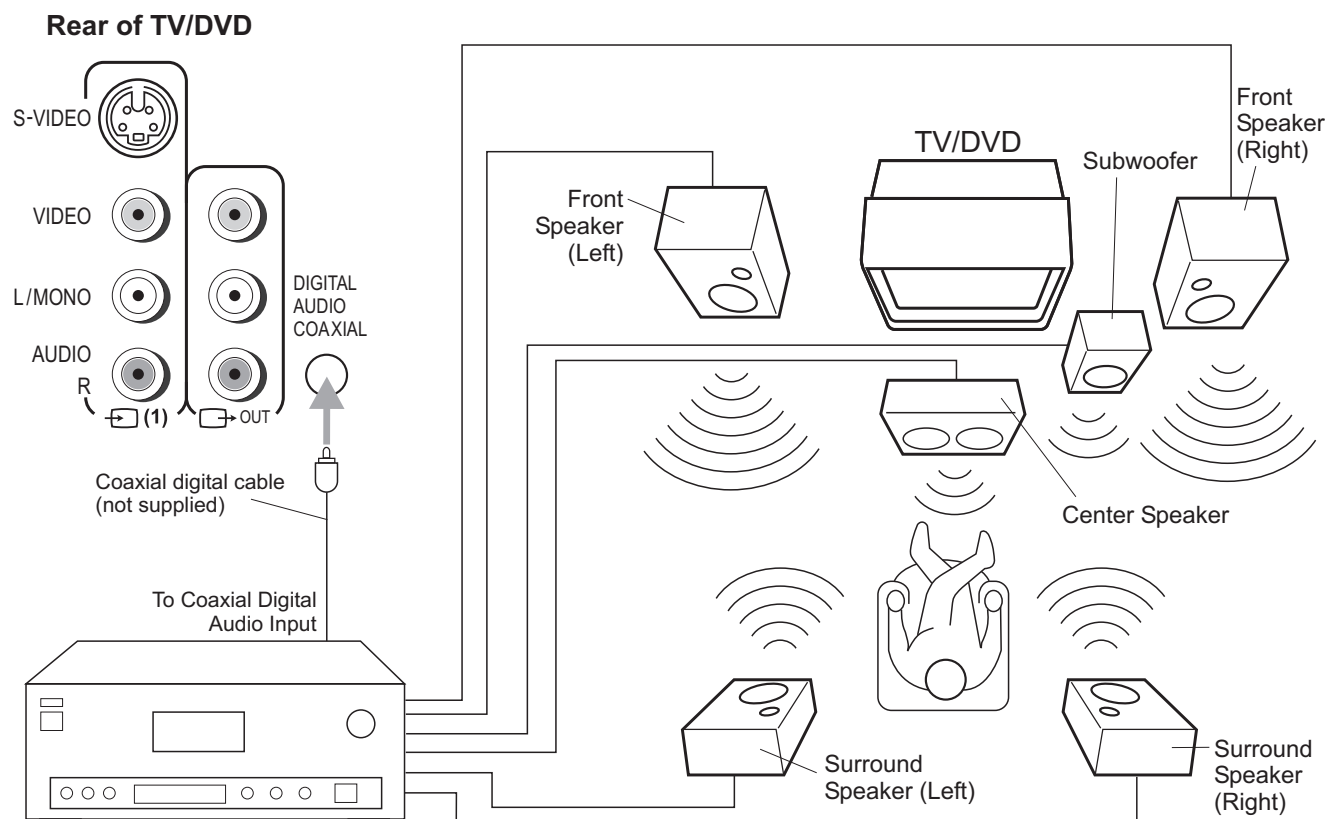

\* Manufactured under license from Dolby Laboratories. "Dolby" and the double-D symbol are trademarks of Dolby Laboratories. Confidential unpublished works. © 1992-1997 Dolby Laboratories, Inc. All rights reserved.

\* "DTS" and "DTS Digital Out" are trademarks of Digital Theater System, Inc.

# Installation (continued)

## Connecting AV1 inputs

If you connect the TV/DVD to VCR or camcorder, you can select by pressing the **AV/SETUP** button. Press this button repeatedly to select the desired mode. "Video 1", "Video 2" or TV channel will display on the screen.

In the DVD mode this button will not operate.

### Rear of TV/DVD

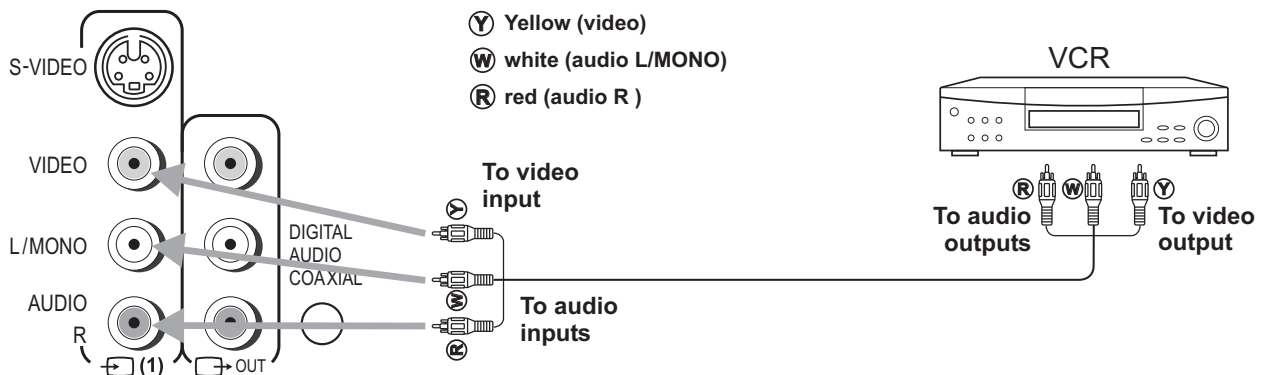

### Notes:

With the AV1 input terminals, the S-VIDEO terminal takes precedence to the Video 1 input. When an S-Video cable is plugged in the AV1 input is disabled. To view the video signal from the AV1 terminals, disconnect the S-VIDEO connection.

## Connecting AV2 inputs

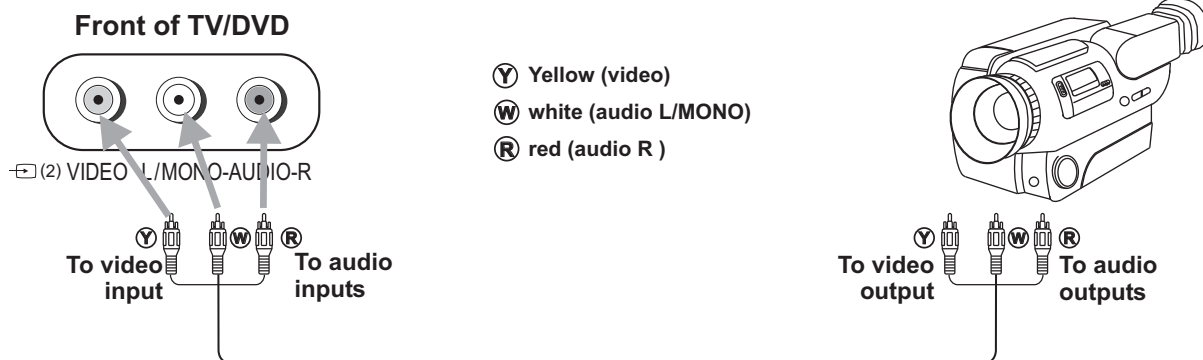

# Power on/off

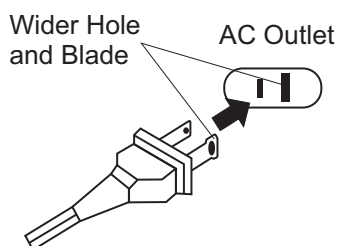

Polarized AC cord plug  
(One blade is wider than the other)

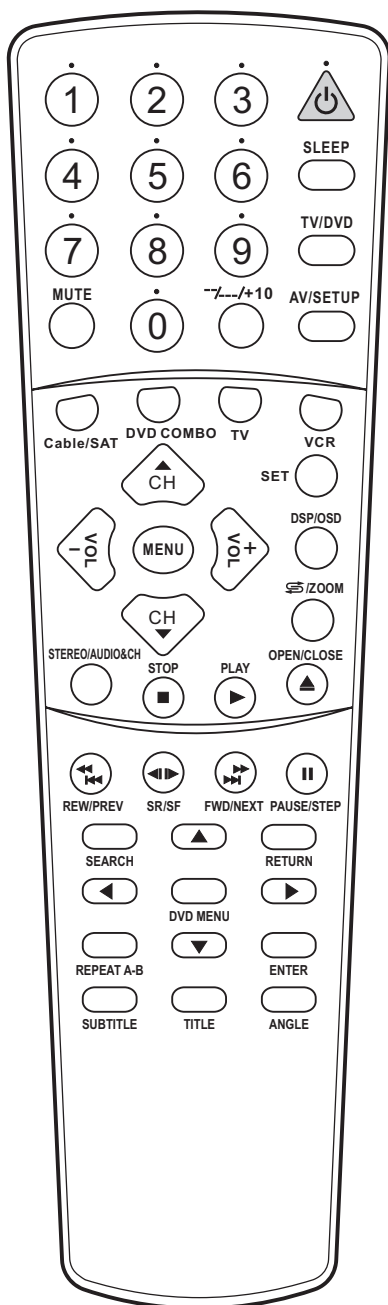

## Turning on

- 1 Insert the AC plug (with the 2 blades) into a conveniently located AC outlet having 120V, 60Hz.

If the red indicator lights up and no picture appears, then the TV set is in STANDBY mode. Now please follow step 2.

### ! Notes:

The AC plug supplied with the unit is polarized to help minimize the possibility of electric shock. If the AC plug does not fit into a non-polarized AC outlet, do not file or cut the wide blade. It is the user's responsibility to have an electrician replace the obsolete outlet.

**To prevent electric shock, do not use a (polarized) plug with an extension cord receptacle or other outlet unless the blades can be fully inserted.**

- 2 In STANDBY mode, press the power  button on the TV set or on the remote controller to turn on the unit.

### ! Notes:

In STANDBY mode, you can also turn on the set by pressing the **TV/AV**, **Channel up/down** or **Volume up/down** button on the set's panel.

If there is no input signal, then a blue background appears.

## Turning off

- 1 Press the Power  button on the remote controller or on the TV set to turn off the TV set.

### ! Notes:

The TV set can turn off automatically by:

- A. **Sleep** timer function (needs to be set in advance).
- B. **OFF** timer function (needs to be set in advance).

# Selecting the Video Input

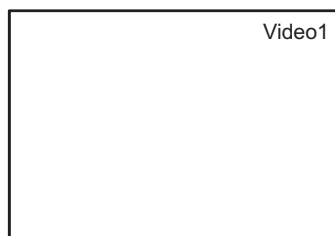

## Watching AV program

- 1 To watch video program from AV inputs, Press **AV/SETUP** repeatedly to select the desired mode.



### ! Notes:

With the AV1 input terminals, the S-VIDEO terminal takes precedence to the Video 1 input. When both S-video and AV1 cables are connected, the S-video signal is automatically selected and the On-screen display is "S-Video". To view the video signal from the AV1 terminals, disconnect the S-VIDEO connection.

## Switching from AV to TV

When the TV set is in AV mode, there are four ways for you to switch back to TV mode.

- 1 Press **AV/SETUP** repeatedly until the **TV** program appears.
- 2 Press digit buttons to switch back to TV mode.
- 3 Press **CH+** or **CH-** to switch back to TV mode.
- 4 Press **S/ZOOM** to switch back to TV mode.

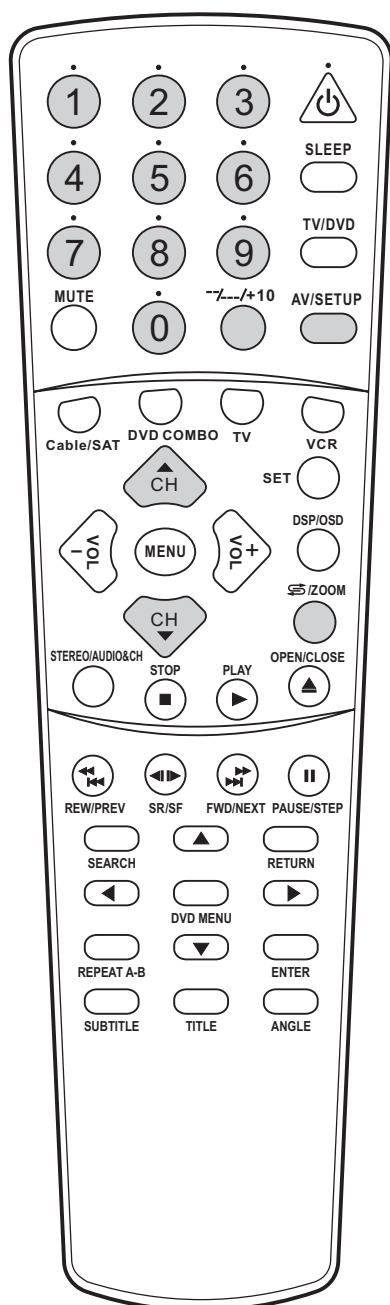

# Tuning

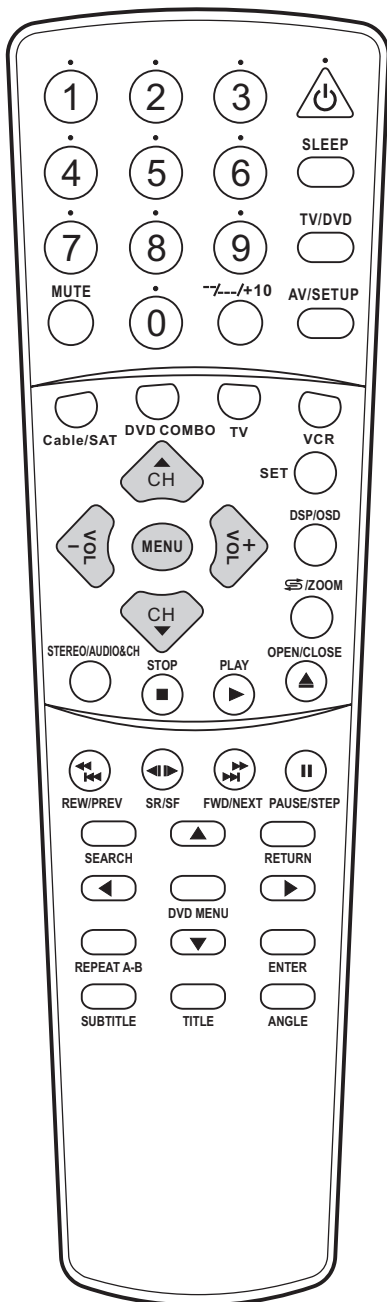
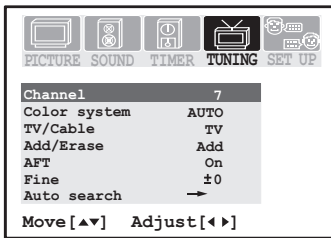

## To enter the TUNING menu

- 1 Press the **MENU** button.
- 2 Press **VOL+** or **VOL-** to select **TUNING** icon.

If the **TUNING** icon is not present on the menu group, the TV/DVD may be in AV mode. Press the **AV/SETUP** button till TV mode appears. Press **MENU** again and the **TUNING** icon should appear.

- 3 Press **CH-** to display the **TUNING** menu.

## Setting the TV/Cable option

- 1 From the **TUNING** menu, press **CH+** or **CH-** repeatedly to highlight **TV/Cable** item.
- 2 Press **VOL+** or **VOL-** to select **TV** or **Cable**.

In TV mode, the set receives antenna signals. In Cable mode the set receives Cable TV programs. Please select:

**TV:** If using VHF/UHF antenna. Only channels received on antenna can be selected.

**Cable:** If using Cable TV. Only channels received on cables can be selected

## Auto Search

- 1 From the **TUNING** menu, press **CH+** or **CH-** repeatedly to highlight **Auto Search** item.
- 2 Press **VOL+** to start **Auto Search**.

All active channels will be preset and stored into the memory automatically. After presetting, the TV will go to the channel before the **Auto Search** started.

### ! Notes:

During the process of **Auto Search**, pressing the **VOL-** button will stop the process and the TV will return to the original channel when **Auto Search** started.

TV 18  
Auto memory  
Stop ←

# Tuning (continued)

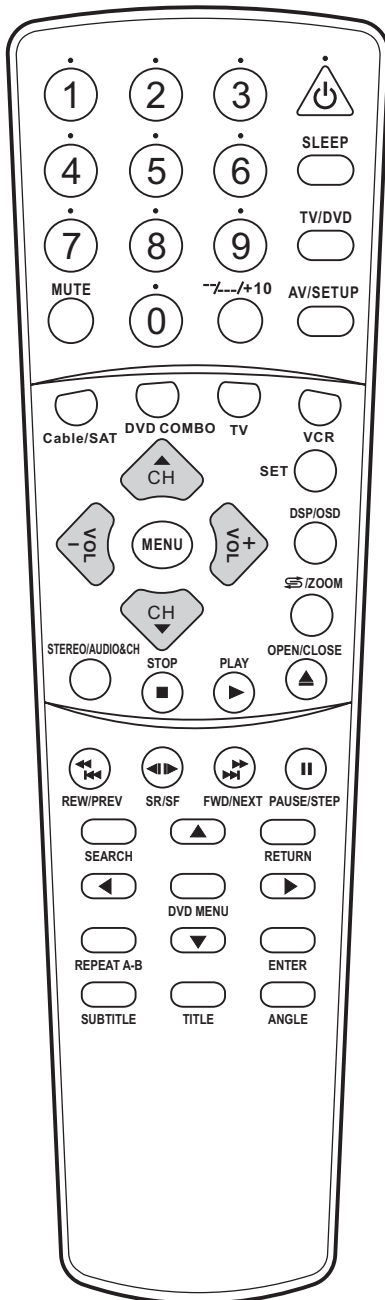
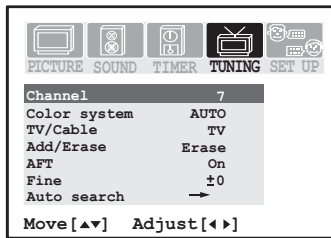

## Erasing an unnecessary channel

- 1 From the TUNING menu, press CH+ or CH- repeatedly to highlight Channel item.
- 2 Press VOL+ or VOL- to select a channel number (for example, channel10)
- 3 Press CH+ or CH- repeatedly to highlight Add/Erase item.
- 4 Press VOL+ or VOL- to set to Erase.

Now channel 10 will be skipped when you browse channels by the CH+ or CH- button.

To restore a skipped channel, please use the digit buttons to select the skipped channel, then repeat the above steps 3 and 4 from above and set the Add/Erase item to Add.

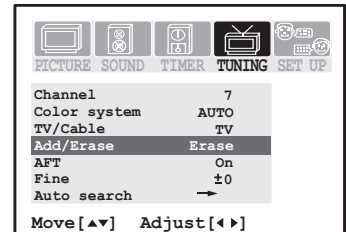

## Fine tuning

Fine tuning is unnecessary under normal conditions. However, in areas of inferior broadcast conditions where adjustment is necessary for a better picture and sound, use Fine tuning.

- 1 From the TUNING menu, press CH+ or CH- repeatedly to highlight Channel item.
- 2 Press VOL+ or VOL- to select a channel number you want to Fine tune (for example, channel10).
- 3 Press CH+ or CH- repeatedly to highlight Fine item.
- 4 Press VOL+ or VOL- to fine tune till the best possible picture and sound are obtained.

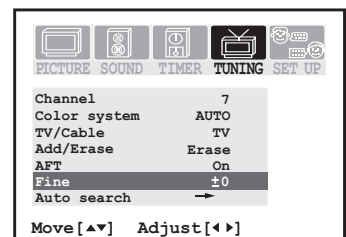

### ! Notes about AFT item:

The AFT can be set to On or Off. When the AFT is set to On, the TV set will automatically tune the program frequency to provide the best possible picture and sound.



# Tuning (continued)

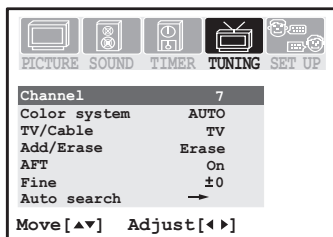

## Setting the Color System

If the picture color is abnormal, maybe the color system setting is wrong. You can select a proper color system as follows.

- 1 From the TUNING menu, press CH+ or CH- repeatedly to highlight Color System item.
- 2 Press VOL+ or VOL- to select a proper color system.

The color system switches between AUTO, NTSC358 and NTSC443.

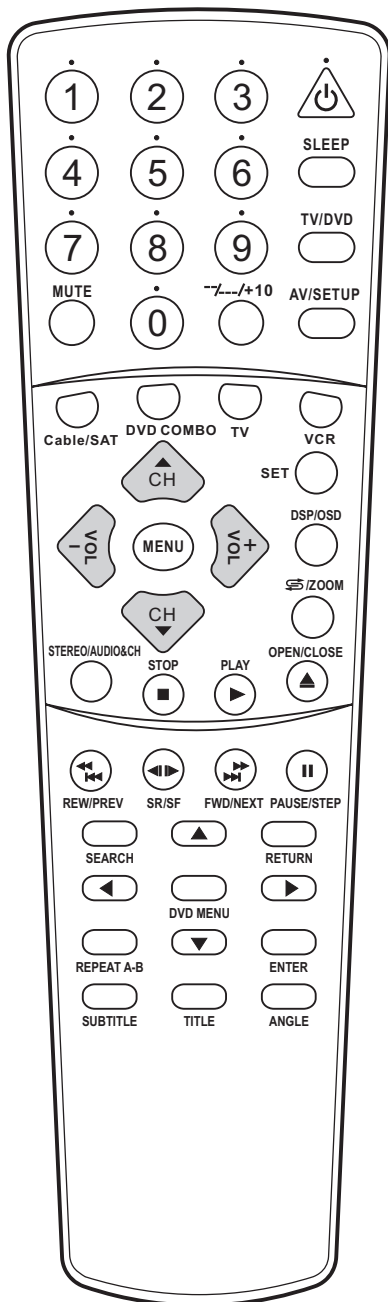
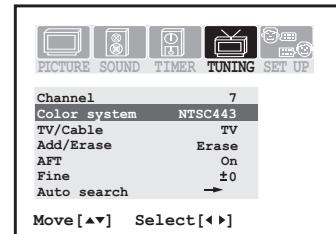

# Channel Selection

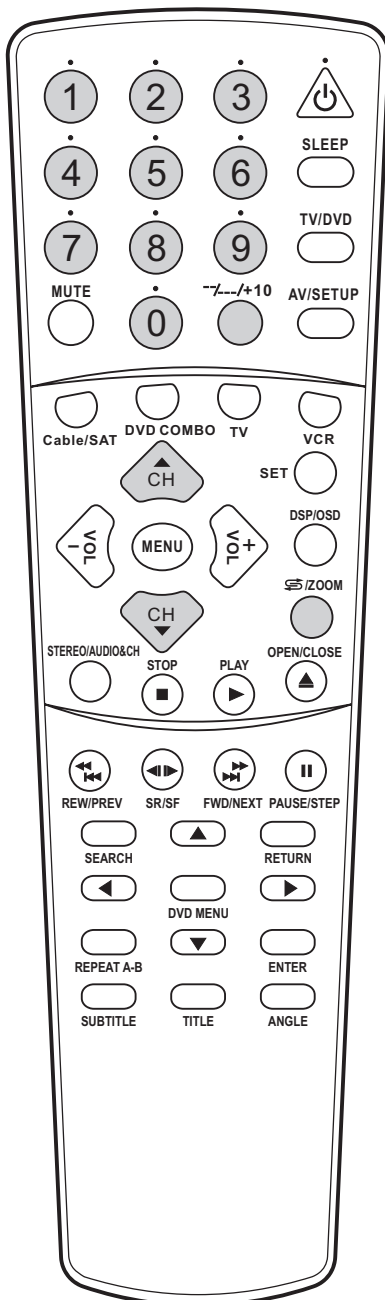
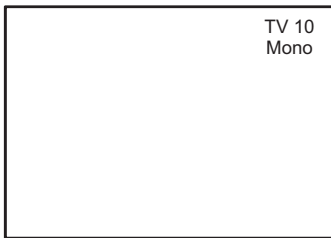

## 1 Use 0~9 digit buttons and the --/---/+10 button

To select one-digit channel:

- Press one of the 0-9 digit buttons and wait for 2 seconds.

To select two-digit channel:

- Input the channel using the digit buttons. Be sure to enter the channel within 2 seconds.

To select three-digit channel:

- Press the "--/---/+10" button to display "1--".
- Press two digit buttons to input the remaining two digits of the channel. For example, to select channel 124, press "--/---/+10", press 2, then press 4.

## 2 Use the CH+ or CH- button

Press the **CH+** button, the channel number increases;  
Press the **CH-** button, the channel number decreases.

## 3 Use the ZOOM button

Press this button to switch between the current channel and the previous channel.

# Adjusting Picture

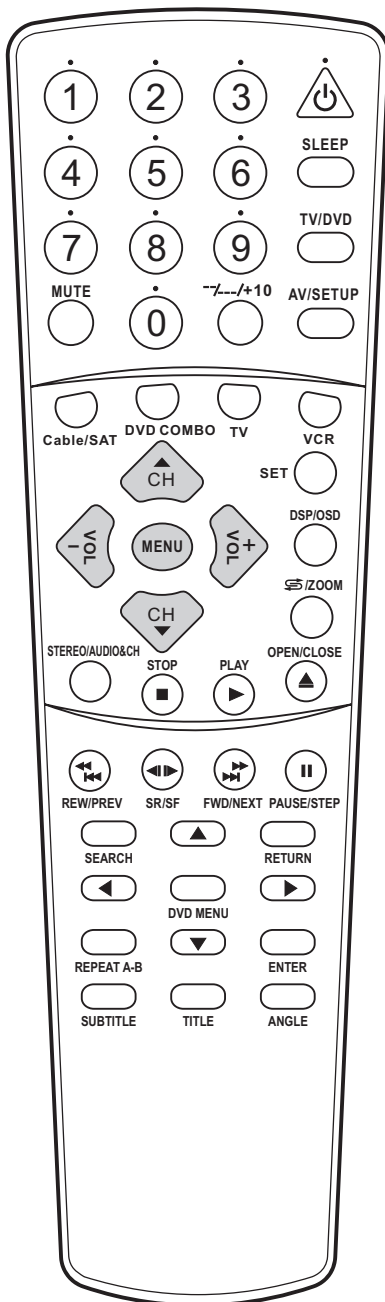
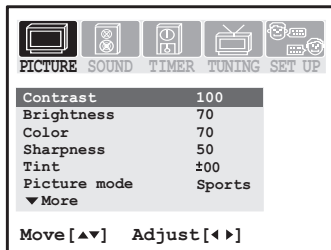

## To enter the PICTURE menu

- 1 Press the MENU button.
- 2 Press VOL+ or VOL- to select PICTURE icon.
- 3 Press CH- to display the PICTURE menu.

## Adjusting picture

- 1 From the PICTURE menu, press CH+ or CH- repeatedly to select item.
- 2 Press VOL+ or VOL- to adjust.

Item	VOL-	VOL+
Contrast	Minus	Plus
Brightness	darker	lighter
Color	paler	deeper
Sharpness	softer	sharper
Tint	purplish	greenish

## Selecting picture mode

- 1 From the PICTURE menu, press CH+ or CH- repeatedly to select Picture Mode item.
- 2 Press VOL+ or VOL- to select.

There are three preset picture modes (**Sports**, **Standard** and **Movie**) and one user-set picture mode (**Personal**).

Each preset mode has its own picture settings (Color, Brightness, Contrast, Sharpness and Tint).

**Sports:** Select for a bright picture.

**Standard:** Select for a standard picture.

**Movie:** Select for a finely detailed picture.

Adjusted settings are stored in **Personal** mode.

# Adjusting Picture (continued)

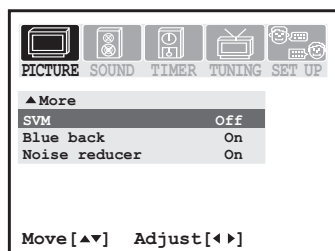

## Setting SVM option

- 1 From the PICTURE menu, press CH+ or CH- repeatedly to select SVM item.
- 2 Press VOL+ or VOL- button to adjust.

This function helps to improve the quality of picture. You can switch between **Off**, **Soft**, **Mild** and **Hard**.

### ! Notes:

Model DV2018 does not have the "SVM" function.

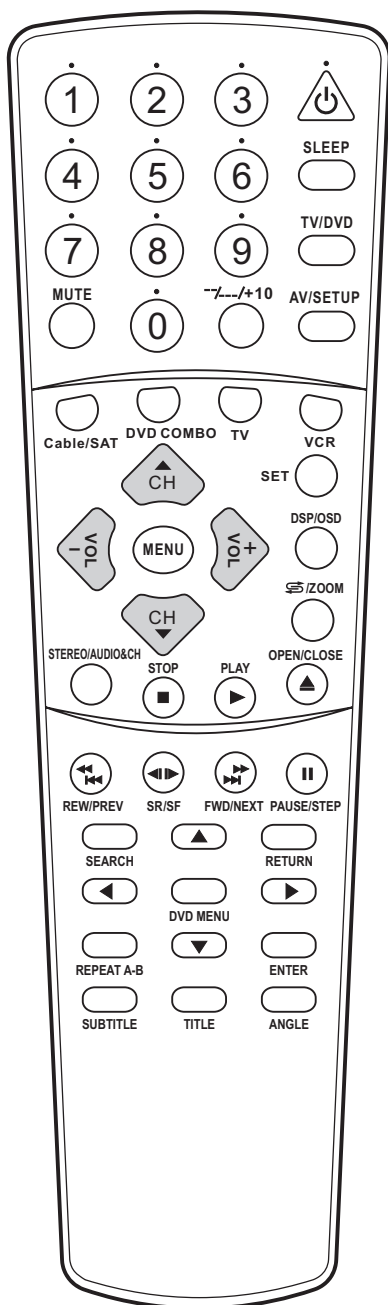

## Setting Blue background option

- 1 From the PICTURE menu, press CH+ or CH- repeatedly to select Blue Back item.
- 2 Press VOL+ or VOL- to select On or Off.

If the **Blue Back** is set to **On**, the TV set will display a blue background when there is no input signal.

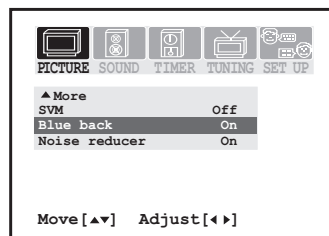

## Setting Noise reducer option

- 1 From the PICTURE menu, press CH+ or CH- repeatedly to select Noise reducer function.
- 2 Press VOL+ or VOL- button to select On or Off.

This function is useful when the picture is snowy because of a poor signal.

If the **Noise reducer** is set to **On**, the picture will be improved.

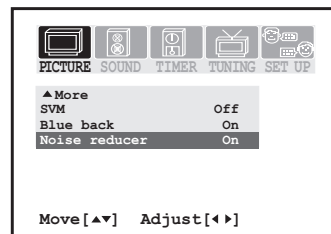

# Sound

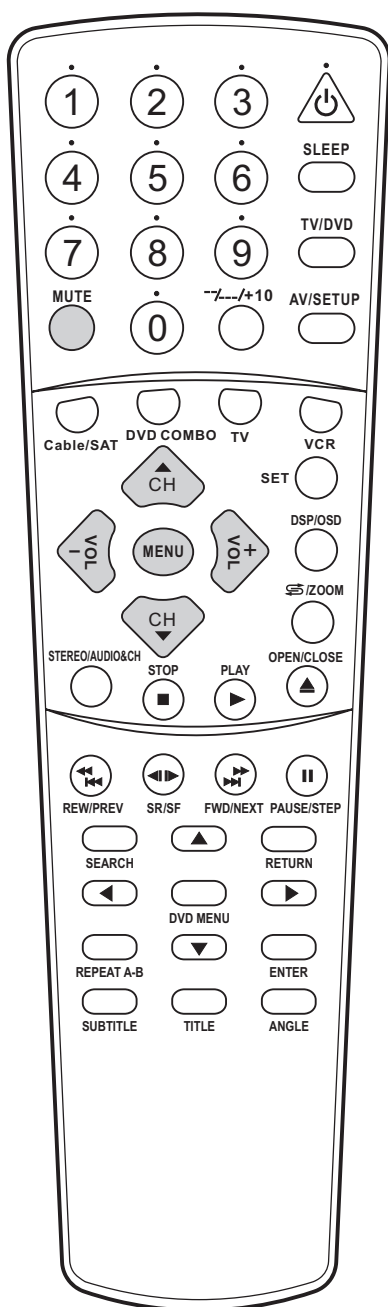
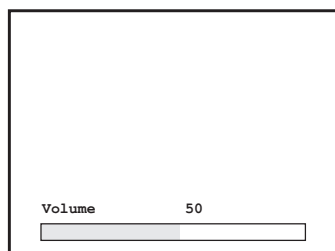

## Adjusting volume

### 1 Use the VOL+ or VOL- button.

Press **VOL+**, the volume increases;  
Press **VOL-**, the volume decreases.  
The minimum volume is 0 and the maximum volume is 100.

### 2 Use the MUTE button.

If you want to mute the sound, press the **MUTE** button on the remote.

To resume the sound, press this button again.

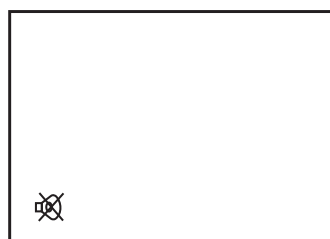

### ! Notes:

You can also resume the sound by pressing the **VOL+** or **VOL-** button.

## To enter the SOUND menu

### 1 Press the MENU button.

### 2 Press VOL+ or VOL- to select SOUND icon.

### 3 Press CH- to display the SOUND menu.

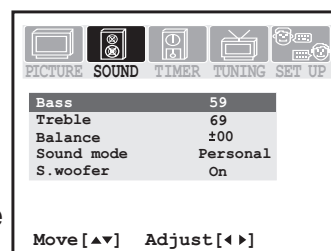

# Sound (Continued)

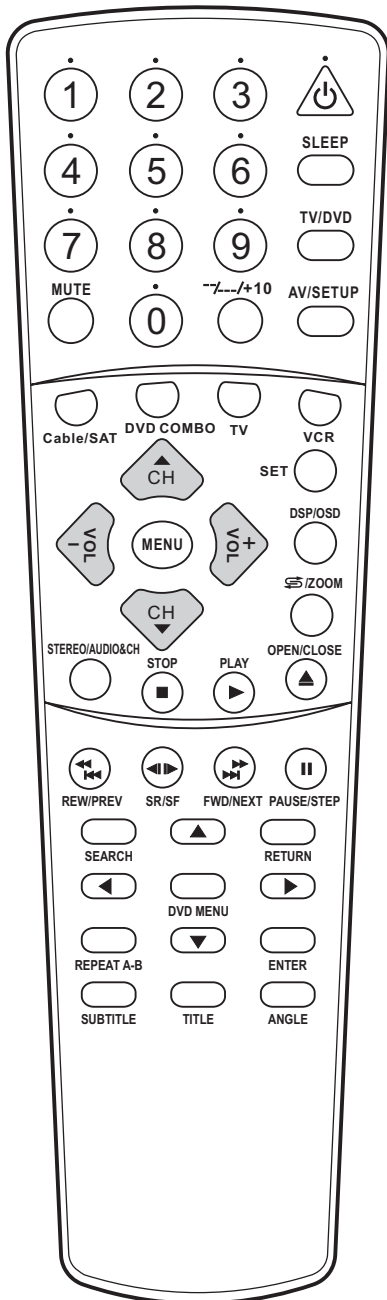
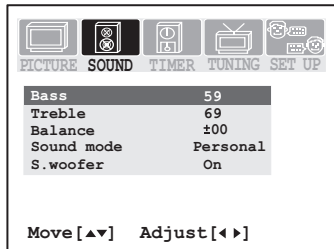

## Adjusting sound

- 1 From the **SOUND** menu, press **CH+** or **CH-** repeatedly to select item.
- 2 Press **VOL+** or **VOL-** to adjust.

Item	VOL-	VOL+
Bass	Minus	Plus
Treble	Minus	Plus
Balance	decreases the right channel	decreases the left channel

## Selecting sound mode

- 1 From the **SOUND** menu, press **CH+** or **CH-** repeatedly to select **Sound Mode** item.
- 2 Press **VOL+** or **VOL-** to select.

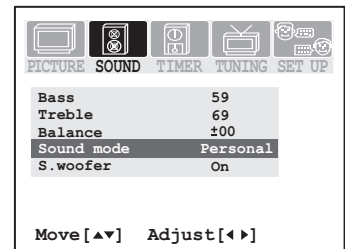

There are two preset sound modes (**News**, and **Music**) and one user-set sound mode (**Personal**).

Each preset mode has its own sound settings (Bass, Treble, and Balance).

**News:** Select for a speech or conversation program.

**Music:** Select for a music program.

The adjusted settings are stored in **Personal** mode.

## Setting S.woofer item

- 1 From the **SOUND** menu, press **CH+** or **CH-** repeatedly to select **S.woofer** item.
- 2 Press **VOL+** or **VOL-** to set **On** or **Off**.

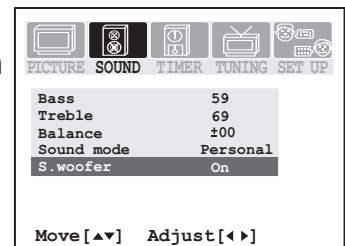

# Timer

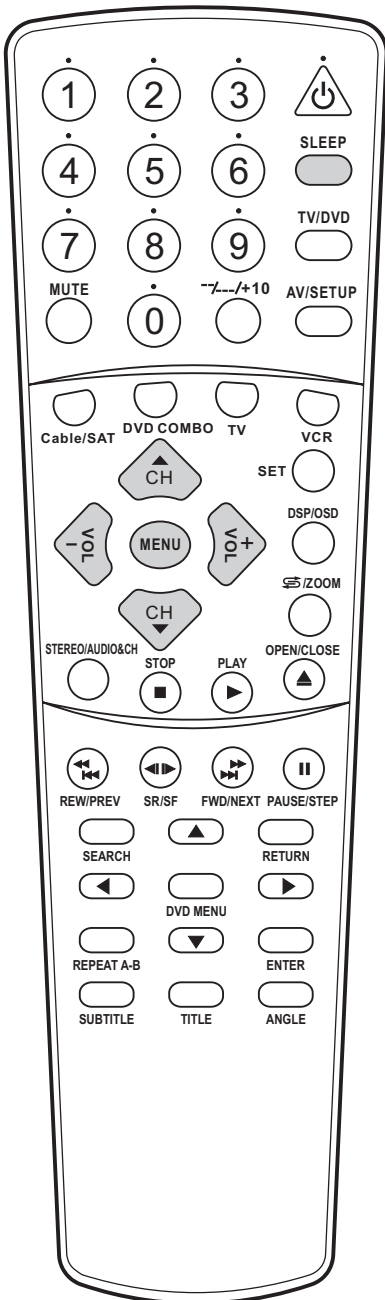
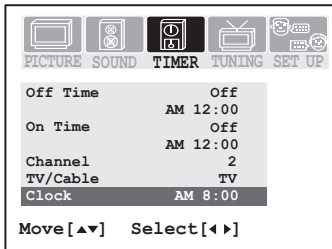

## To enter the TIMER menu

- 1 Press the **MENU** button.
- 2 Press **VOL+** or **VOL-** to select **TIMER** icon.
- 3 Press **CH-** to display the **TIMER** menu.

## Setting Clock

- 1 From the **TIMER** menu, press **CH+** or **CH-** repeatedly to select **CLOCK**.
- 2 Press **VOL+** or **VOL-** button to set the current time.

### ! Notes:

Before setting the **Off Time** or **On Time**, first set the clock. If you disconnect the AC plug, the clock will reset. Please set the clock after disconnecting power.

## Setting Sleep timer

You can quickly set the sleep timer by using the **SLEEP** button on the remote control. With every press of this button the sleep time changes as follows:

OFF → 120 Min. → 110 Min. ----- → 20 Min. → 10 Min.

For example, you would like the TV to turn off in 60 minutes, you can press the **SLEEP** button repeatedly until the screen displays 60 min.

To cancel the sleep timer, you can press the **SLEEP** button repeatedly until "Off" is displayed on the screen.

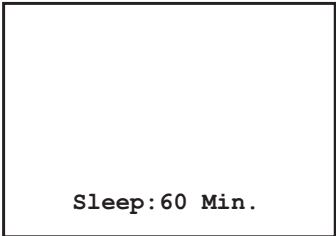

### ! Notes:

When there is no video input signal for 15 minutes, the TV set automatically goes to **STANDBY** mode.

# Timer(continued)

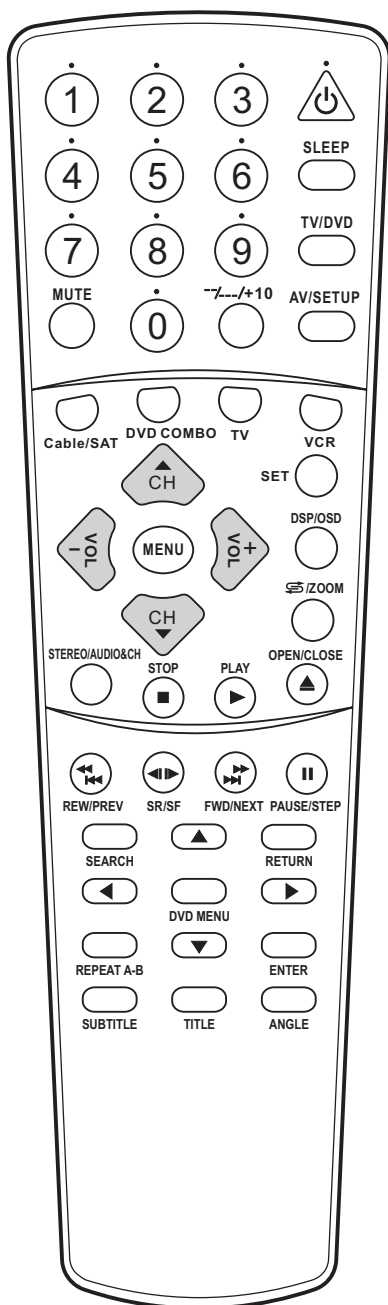
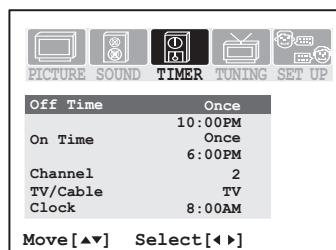

## Setting Off Time

- 1 From the **TIMER** menu, press **CH+** or **CH-** repeatedly to select **OFF TIME**.
- 2 Press **VOL+** or **VOL-** to select **Once** or **Every**. If you set **OFF TIME** to **Once**, this occurs only once; If you set **OFF TIME** to **Every**, this occurs every day. To cancel this function, set **OFF TIME** to **Off**.
- 3 Press **CH-**.
- 4 Press **VOL+** or **VOL-** to set the **OFF time**. The TV will turn off at the designated time.

### ! Notes:

You must first set **OFF TIME** to **Once** or **Every**. When you are setting the time by the **VOL+/-** button, if you press and hold, the time will increase or decrease by 10 minutes.

## Setting On Time

- 1 From the **TIMER** menu, press **CH+** or **CH-** repeatedly to select **ON TIME**.
- 2 Press **VOL+** or **VOL-** to select **Once** or **Every**. If you set **ON TIME** to **Once**, this function occurs once. If you set **ON TIME** to **Every**, this occurs every day. To cancel this function, set **ON TIME** to **Off**.
- 3 Press **CH-**.
- 4 Press **VOL+** or **VOL-** to set the **ON time**. Press and hold to increase/decrease by 10 minutes.
- 5 Press **CH-** to select **Channel** item.
- 6 Press **VOL+** or **VOL-** to select a channel number.
- 7 Press **CH-** to select **TV/Cable**.
- 8 Press **VOL+** or **VOL-** to select **TV** or **Cable**.

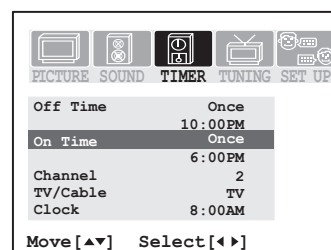

### ! Notes:

If the television automatically turns on and receives no user input (volume adjustment, etc.) for two hours, it will automatically turn off to conserve power. You must set **ON TIME** to **Once** or **Every** prior to setting the time.



# System Setup

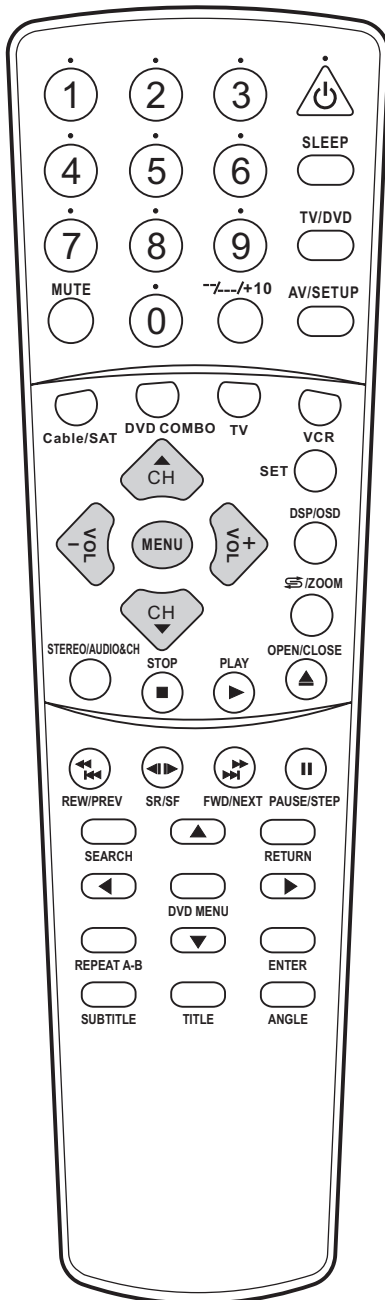
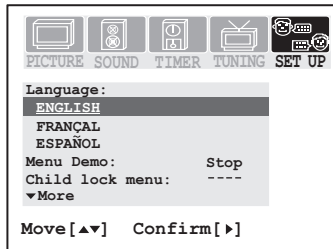

## To enter the SET UP menu

- 1 Press the MENU button.
- 2 Press VOL+ or VOL- to select SETUP icon.
- 3 Press CH- to display the SETUP menu.

## Selecting a Language

- 1 From the SETUP menu, press CH+ or CH- repeatedly to select an on-screen display language.
- 2 Press the VOL+ to confirm.

There are three OSD languages on this TV set: English, French and Spanish.

## Menu Demo

- 1 From the SETUP menu, press CH+ or CH- repeatedly to select MENU DEMO item.
- 2 Press the VOL+ or VOL- to start.

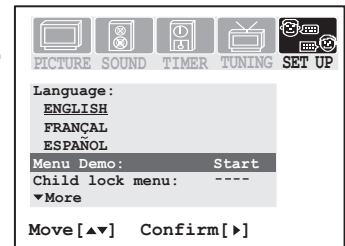

# System Setup<sub>(continued)</sub>

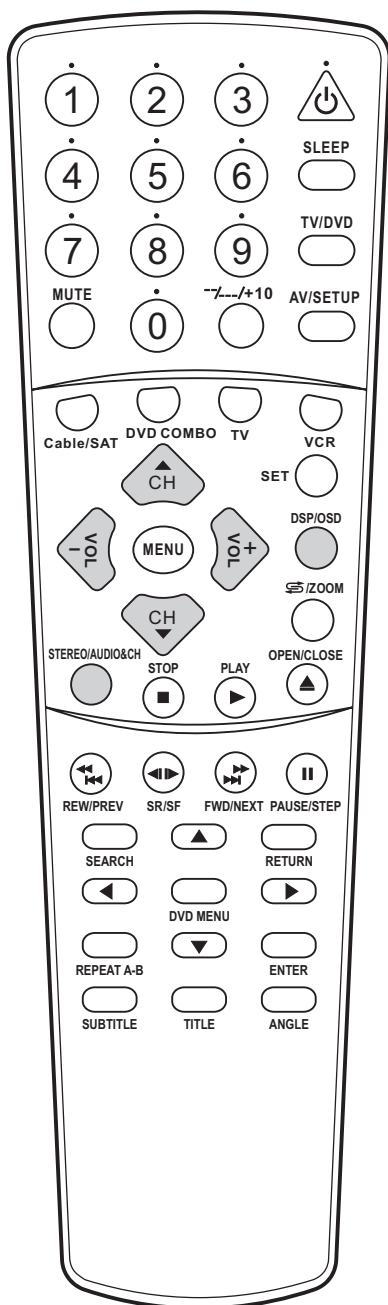
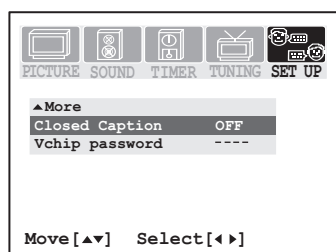

## Setting Closed Caption (CCD)

- 1** From the **SETUP** menu, press **CH+** or **CH-** repeatedly to select **Closed Caption** item.
- 2** Press the **VOL+** or **VOL-** to select.

You can select the caption data channel (**C1/C2/C3/C4**), the text service channel (**T1/T2/T3/T4**) or turn off Closed Captioning (**Off**).

### ! Notes:

1. Some TV programs may not be broadcast with closed caption signals, and therefore, the TV will not be able to display captions. Also, text information is not offered by all stations.
2. Some TV programs only provide one channel caption, one channel text, or only caption without text.

## Selecting audio mode

If the program you are watching is "STEREO" or "SAP", you can change the audio mode by using the **STEREO/AUDIO&CH** button on the remote control. The audio mode changes as follows.

MONO ↔ STEREO (If the audio is **STEREO**)

MONO ↔ SAP (If the audio is **SAP**)

MONO → STEREO → SAP (If the audio is **STEREO & SAP**)

## Recalling On-screen display

You can press the **DSP/OSD** button on the remote control to display the On-screen display.

Press **DSP/OSD** once and the channel and audio mode are displayed for a brief time. Press **DSP/OSD** before the display disappears, and the time will display. To cancel the on-screen display, press the **DSP/OSD** again or wait for it to automatically disappear.

AM 10:00 TV 10  
MONO

# Parental Control

## Child lock

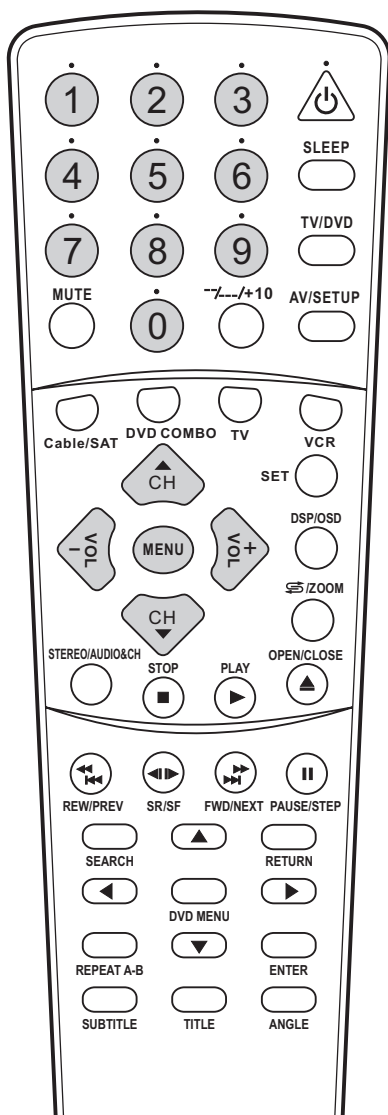

### To enter Child lock submenu

- 1 From the **SETUP** menu, press **CH+** or **CH-** repeatedly to select **Child lock**.
- 2 Input a password for the **Child lock** menu.

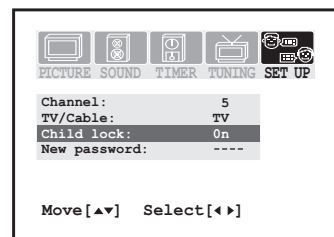

The default password to enter the Child lock menu is **0000** and you can change it in the Child lock submenu.

### Setting Child lock

- 1 From the **Child lock** submenu, press **CH+** or **CH-** repeatedly to select **Channel**.
- 2 Press **VOL+** or **VOL-** to select a channel you want to lock.
- 3 Press **CH-** to select **TV/Cable**.
- 4 Press **VOL+** or **VOL-** to select **TV** or **Cable**.
- 5 Press **CH-** to select **Child Lock**.
- 6 Press **VOL+** or **VOL-** to select **ON** or **OFF**.

Now the **Child lock** is active. When you select a locked channel, a blue box appears with the following: "**Notice: child lock function active**".

### Changing password

- 1 From the **Child lock** submenu, Press **CH+** or **CH-** repeatedly to select **New password** item.
- 2 Input a new password by using **0-9** digit buttons. Press **MENU** button to confirm after you finish inputting the new password.

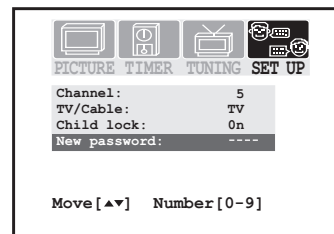

### ! Important:

Be sure to write down your password and retain it for future use.

If you forget the password, press **4 3 2 1** in order to access the Child lock submenu.

# Parental Control(Continued)

## Setting V-chip

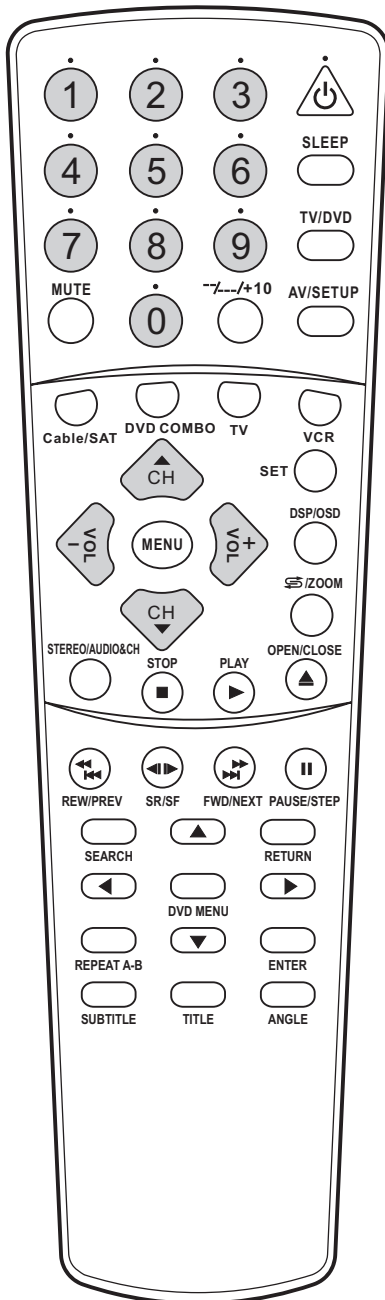
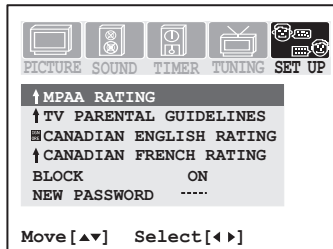

### To enter V-chip menu

V-Chip enables parents to prevent their children from watching inappropriate material on TV. V-Chip reads the ratings for programming (except for news, sports, unedited movies on premium cable and Emergency System signals), then denies access to programming if the program's rating meets the limitations you select.

- From the **SETUP** menu, press **CH+** or **CH-** repeatedly to select **VCHIP PASSWORD**.
- Use digit buttons (0-9) to enter a password (the preset password is 0000).

To enable the V-chip, set **BLOCK** to **ON** in the V-chip menu.

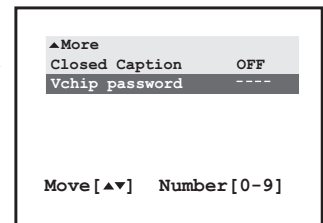

**IMPORTANT:** The password can be changed later by entering the original password and following the above steps.

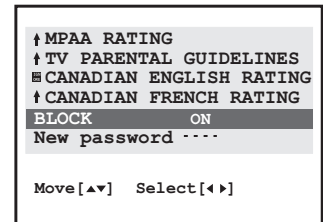

### MPAA RATING SET-UP

Rating guidelines are provided by broadcast stations. Most television programs and television movies can be blocked by TV Rating and/or Individual Categories. Movies that have been shown at the theaters or direct-to-video movies use the Movie Rating System (MPAA) only.

- From the V-chip submenu, press **CH+** or **CH-** repeatedly to select **MPAA RATING**.
- Press **VOL+** or **VOL-** to enter into **MPAA RATING** submenu.
- Use **CH+** or **CH-** repeatedly to select the desired rating.
- Press **VOL+** or **VOL-** button to block a rating ("↑" will appear), or unblock ("IGNORE" will appear).

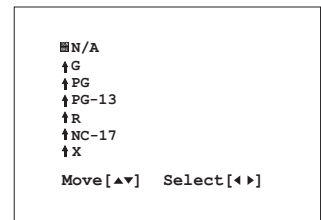

Movie Ratings:

- \* Unblocked
- \* G and Above (general audience)
- \* PG and Above (parental guidance suggested)
- \* PG-13 and Above (13 years and up)
- \* R and Above (restricted)
- \* NC-17 and Above (18 years and up)
- \* X (adult)

# Parental Control

## Setting V-chip

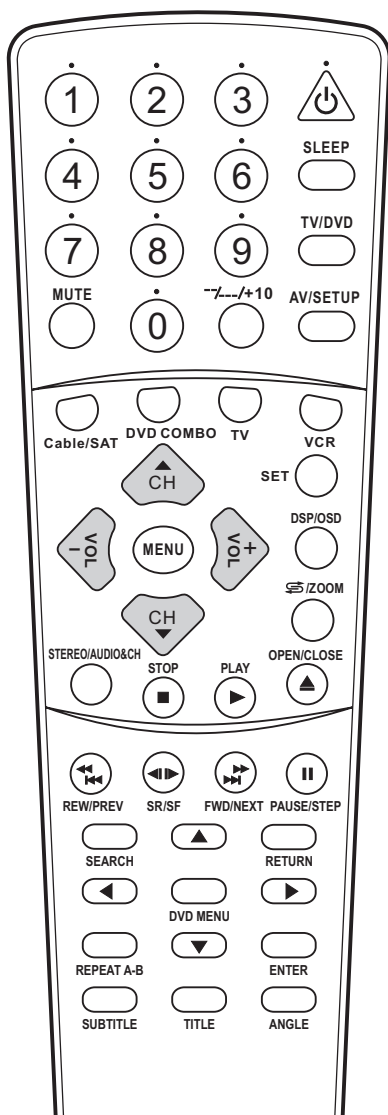
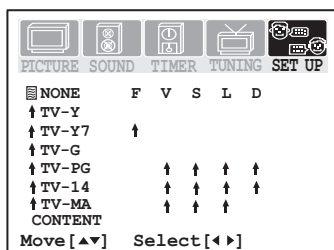

### TV RATING SET-UP

TV Parental Guidelines may have one or more letters added to the basic rating to let parents know when a show contains higher levels of violence, sex, adult language or suggestive dialogue:

- From the V-chip submenu, press CH+ or CH- repeatedly to select TV PARENTAL GUIDELINES.
- Press VOL+ or VOL- to enter into TV PARENTAL GUIDELINES sub-menu.
- Use CH+ or CH- repeatedly to select the desired rating.
- Press VOL+ or VOL- to block the rating (" ↑ " will appear), or unblock ("  " will appear).

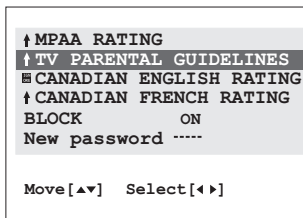

### US TV PROGRAMS RATINGS: (Chart 1)

<b>TV-Y</b>	<b>FOR ALL CHILDREN:</b> Content specifically geared to young viewers ages 2-6.
<b>TV-Y7</b>	<b>FOR AGE 7 AND OLDER:</b> May contain mild physical or comedic violence which may frighten children under 7.
<b>TV-G</b>	<b>GENERAL AUDIENCE:</b> Contains little or no violence, strong language, or sexual dialogue or Situations.
<b>TV-PG</b>	<b>PARENTAL GUIDANCE:</b> May contain infrequent coarse language, limited violence, some suggestive sexual dialogue and Situations.
<b>TV-14</b>	<b>PARENTS CAUTIONED:</b> May contain sophisticated themes, sexual situations, strong language, and more intense violence.
<b>TV-MA</b>	<b>MATURE AUDIENCE:</b> May contain mature themes, profane language, graphic violence, and Sexual situations.

### US TV PROGRAMS RATINGS: (Chart 2)

<b>F Violence</b>	<b>Fantasy Violence</b>
<b>Violence</b>	<b>Violence</b>
<b>Sex scenes</b>	<b>Sexual Situations</b>
<b>Language</b>	<b>Adult Language</b>
<b>Dialog</b>	<b>Sexually Suggestive Dialogue</b>

# Parental Control(Continued)

## Setting V-chip

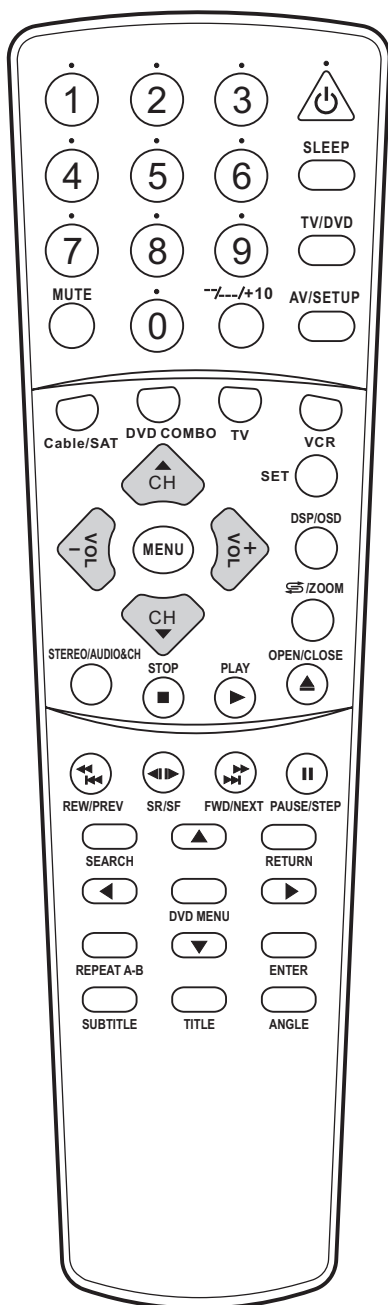
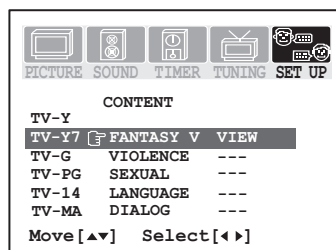

### Setting individual Content Categories for TV Rating

**1** From the PARENTAL GUIDELINES submenu, press CH+ or CH- repeatedly to select CONTENT.

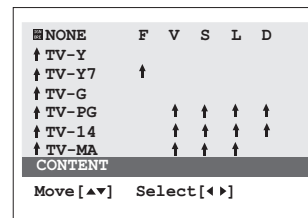

**2** Press VOL+ or VOL- to enter the CONTENT menu.

**3** Press CH+ or CH- repeatedly to select a TV Rating.

**4** Press VOL+ to enter the content categories menu.

**5** Press CH+ or CH- repeatedly to select a content category.

**6** Press VOL+ to set Block or View. If the content category does not apply to the TV rating, - - - will be displayed.

Press VOL- to exit content categories menu.

#### Notes:

If you want to exit the menu, please press the **MENU** button repeatedly.

### CANADIAN ENGLISH RATING SET-UP

**1** From the V-chip submenu, press CH+ or CH- repeatedly to select CANADIAN ENGLISH RATING item.

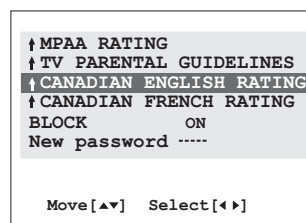

**2** Press VOL+ or VOL- to enter the CANADIAN ENGLISH RATING sub-menu.

**3** Press CH+ or CH- repeatedly to select the desired rating.

**4** Press VOL+ or VOL- to either block the rating ("↑" will appear), or unblock ("IGN" will appear) it.

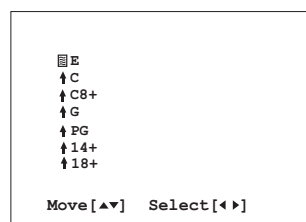

Canadian English Language Ratings:

- \* E: Exempt.
- \* C: Children.
- \* C8+: Children 8 years and older.
- \* G: General programming, suitable for all audiences.
- \* PG: Parental guidance.
- \* 14+: Viewers 14 years and older.
- \* 18+: Adult programming.

# Parental Control<sub>(continued)</sub>

## Setting V-chip

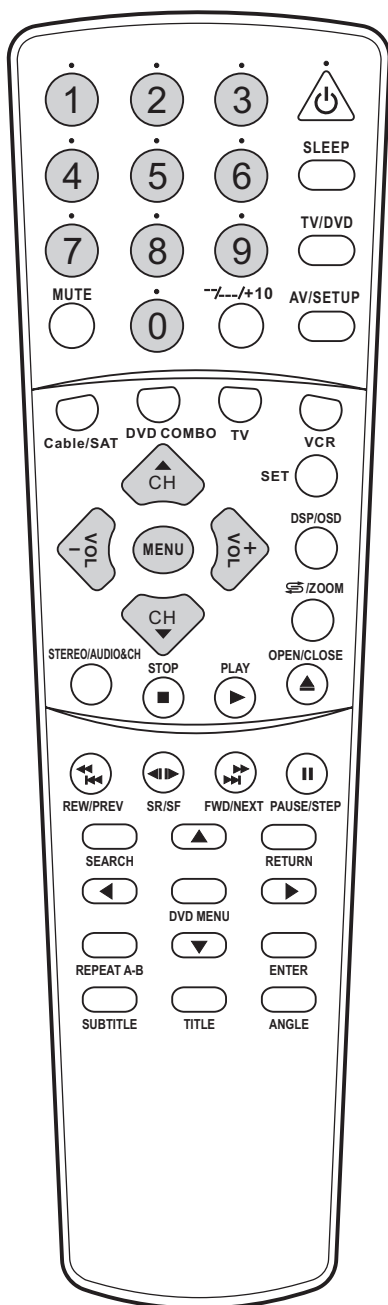
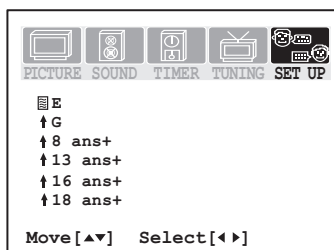

### CANADIAN FRENCH RATING SET-UP

- From the V-CHIP submenu, press CH+ or CH- repeatedly to select **CANADIAN FRENCH RATING**.
- Press VOL+ or VOL- to enter the **CANADIAN FRENCH RATING** sub-menu.
- Press CH+ or CH- repeatedly to select the desired rating.
- Press VOL+ or VOL- to block the rating ("↑" will appear), or unblock ("IGN/ORE" will appear) it.

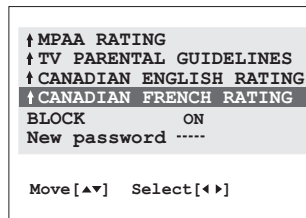

Canadian French Language Ratings:

- \* E: Exempt.
- \* G: Children.
- \* 8 ans+: Children 8 years and older.
- \* 13 ans+: Children 13 years and older.
- \* 16 ans+: Viewers 16 years and older.
- \* 18 ans+: Adult programming.

### Changing password

- From the V-CHIP submenu, press CH+ or CH- repeatedly to select **NEW PASSWORD**.
- Input a new password by using the 0-9 digit buttons. Press MENU to confirm the new password.

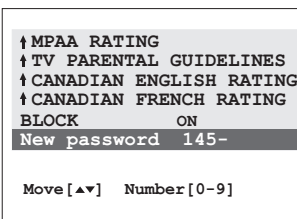

PRESS MENU KEY TO CONFIRM

Next time, you enter the V-chip menu, you must use this new password. Please be sure to remember your passwords.



---

## DVD Operation Guide

---



# Disc Information

## Discs that can be played

This TV/DVD supports DVD, SVCD, VCD, CD-DA, HDCD, KODAK picture CD and CD-R/RW including discs containing MP3 files. Please do not play any disc other than the above formats.

This unit detects the disc loaded and automatically sets the mode.

## Discs that can not be played

Do not play DVD-Audio, DVD-ROM, DVD-RAM, CD-G, CDV, CVD, DVD-RW, CVD, SACD and Divx Video Discs. This unit may not be able to play some CD-R/RW due to the condition of the recording.

This unit has a Dolby Digital decoder and DTS decoder so you can play DVDS with the right symbols.



## Title/Chapter/Track

### Title

When two or more movies are recorded on a disc, the disc is divided into two or more sections. Each section is called a "TITLE".

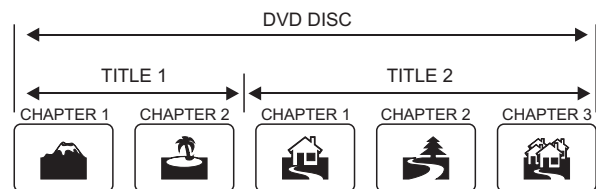

### Chapter

The titles can be subdivided into many sections. Each section is called a "CHAPTER".

### Track

An audio CD can contain audio tracks. These numbers are assigned to each track.



## Disc handling

### Handling precautions

- Hold the disc by the edges so the surface will not be soiled with fingerprints.
- Fingerprints, dirt and scratches can cause skipping and distortion.
- Do not write on the label side.
- Do not use record cleaning sprays, benzene, thinner, static electricity prevention liquids or any other solvent.
- Be careful not to drop or bend the disc.
- Do not install more than 1 disc on the disc tray.
- Do not close the disc tray if the disc is not installed properly.
- Store the disc in its case when not in use.

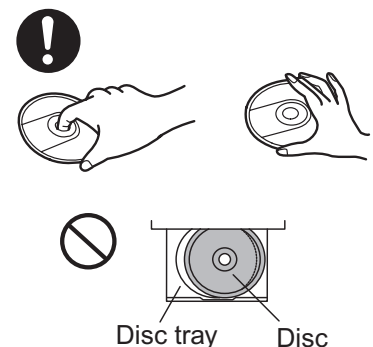

### If the surface is soiled

Wipe gently with a soft, damp (water only) cloth.

When wiping discs, always wipe from the center toward the outer edge.

(If you wipe using a circular motion, circular scratches can occur, which will cause noise.)

### If the disc is brought from a cold to a warm environment, moisture may form on the disc

Wipe with a soft, dry, lint-free cloth before using the disc.

### Improper disc storage

You can damage discs if you store them in the following places:

- Areas exposed to direct sunlight
- Humid or dusty areas
- Areas directly exposed to a heat outlet or heating appliance

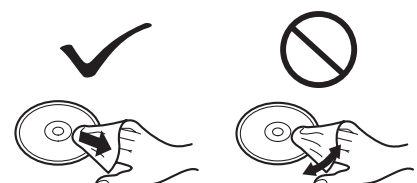

# Basic Playback

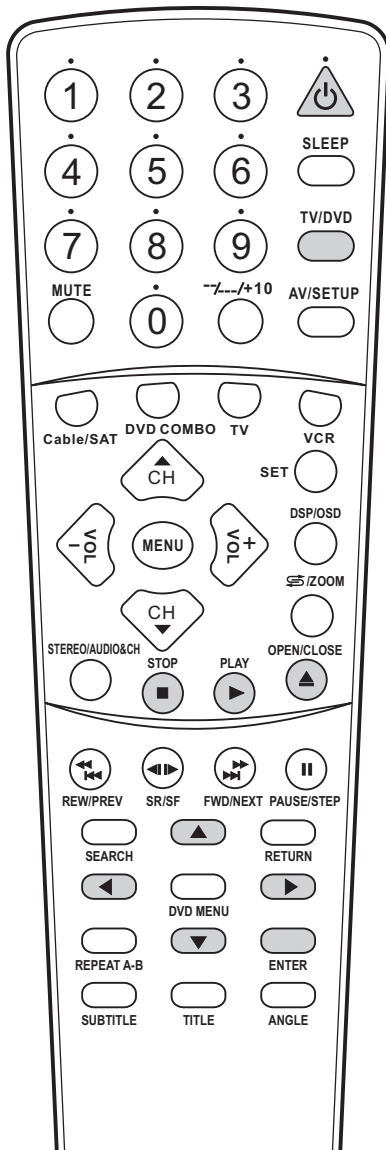

## Preparation

- Insert the AC cord plug into the specified polarized AC outlet.
- Press **POWER** to turn on the unit.
- When using an amplifier, switch on the amplifier.

## Start Playback

- 1 Press **TV/DVD** to select the DVD mode. "LOADING" changes to "NO DISC". (If a DVD disc has already been loaded, the playback will start automatically)

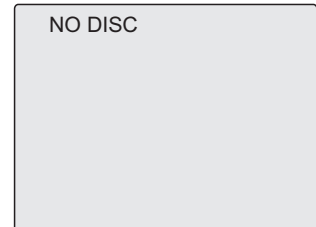

- 2 Press **OPEN/CLOSE** to open the disc tray.

- 3 Place a disc onto the tray. Hold the disc, position it with the printed label side up, align it with the guides, and place it in its proper position.



- 4 Press **PLAY** or **OPEN/CLOSE** to close the disc tray and automatically start the playback.

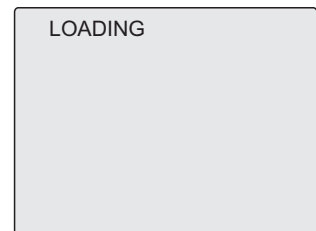

A menu screen will appear on the TV screen if the disc has a menu feature. In case of many movie DVDs, an interactive DVD or Video CD with playback control, a menu screen appears.

- 5 Press **◀ / ▶** or **▲ / ▼** to select title.



- 6 Press **ENTER**.

Title is selected and playback starts.

Example of DVD

## Stop Playback

- 1 Press **STOP** to end playback.

The DVD player will remember where you stopped the playback (depending on type of disc).

"**PRESS PLAY KEY TO CONTINUE**" appears on the screen. Press **PLAY** to resume playback from the stopped point.

If you press **STOP** again or unload the disc, the unit will clear the stopped point.

## After Operation

When the player is not in use, press **OPEN/CLOSE** to open the disc tray. Remove the disc and press **POWER** on the remote or television set. The disc tray closes automatically and unit turns off.

## Switch from DVD to TV or AV

In DVD mode, you can press **TV/DVD** to switch back to TV or AV mode, which depends on the previous mode before the DVD mode is selected. For example, you had switched the unit to DVD mode from AV mode, now if you press **TV/DVD**, the unit goes back to AV mode.

## Note

- The disc continues to rotate while the menu is displayed even after the player has finished playing a particular item. When no further selections are to be played, be sure to press **STOP** to clear the menu display.
- If  $\emptyset$  appears on the screen when a button is pressed, the operation is prohibited by the player or disc.
- In stop mode, if there is no operation for 1 minute, the screen saver starts up (this feature needs to be set in advance). If there is no operation for 5 minutes, the DVD goes to sleep mode automatically.
- In some cases, a blue screen may appear when you press **TV/DVD**. To go back to TV or AV mode, press this button again.

# Basic Playback

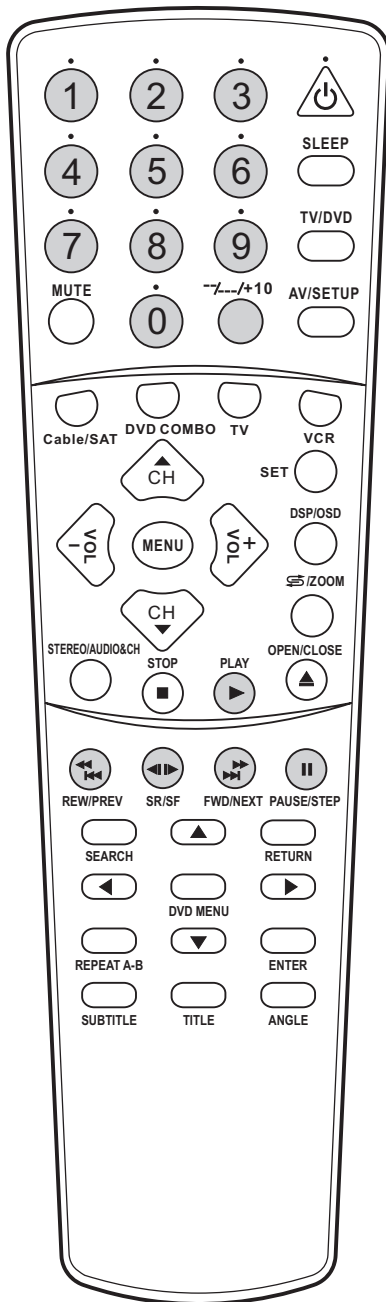

## Quickly select Chapter or Track

You can quickly select chapter or track by using **number buttons**.

### Note

•Some Video-CDs have a PBC feature. When the PBC is ON, you cannot select a track during playback by pressing the number buttons.

#### What is Playback control (PBC)?

If a Video-CD has "Playback control" written on its disc or jacket, it means that particular scenes or information can be selected for viewing interactively using the menu screen.

## Fast Forward Playback / Skipping chapters or tracks forward

Use the **FWD/NEXT** button to view fast forward playback or skip to the next chapter. Press and release to skip chapter, press and hold to fast forward. With each press of this button, the unit operation is:



To resume normal playback, press **PLAY**.

## Reverse Playback / Skipping chapters or tracks reverse

Use the **REW/PREV** button to view reverse playback or skip to the previous chapter. Press and release to skip chapter, press and hold to reverse. With each press of this button, the unit operation is:



To resume normal playback, press **PLAY**.

## Slow motion Playback

Press **SR/SF** repeatedly to view slow motion playback in reverse or forward. With each press of this button, the unit operation is:

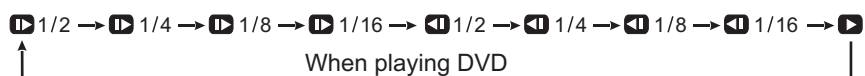

## Still Playback/Frame Advance

Press **PAUSE/STEP** during normal playback to pause playback.

To resume normal playback, press **PLAY**.



Press **PAUSE/STEP** during still playback.

One frame is advanced each time you press **PAUSE/STEP**.

To resume normal playback, press **PLAY**.



### Note

•When playing Audio CD or MP3 CD, the function of Frame Advanced does not work.

# Using On-screen Menu

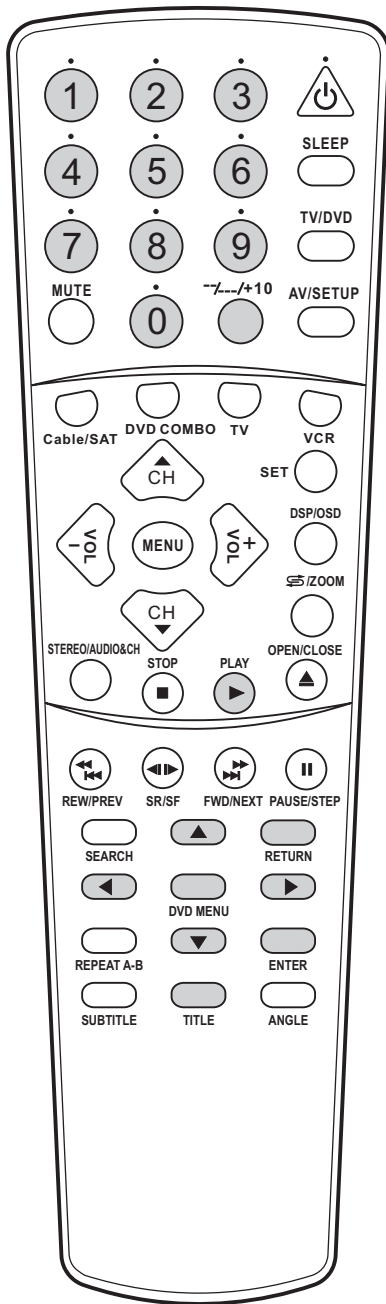

## Using a TITLE MENU [DVD]

Some movie discs may have two or more titles. If the disc has a title menu recorded on it, the TITLE button can be used to select this menu. (The details of operation depend on the disc used.)

- 1 Press **TITLE** during playback.  
A list of the titles on the disc is now displayed.

### Note

- If the disc contains only one movie, the unit plays from the beginning of the disc.



Example of DVD

- 2 Press **◀/▶** or **▲/▼** to select item and press **ENTER** or **PLAY**.



Example

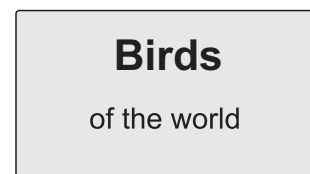

Example

The selected title now starts playing.

## Using a DVD menu [DVD]

Some DVDs have unique menus. These menus can be for language selection, audio output selection and/or subtitle language selection, etc. Although the DVD menu's contents and operation differ from disc to disc, the following explains basic operation when this feature is used.

- 1 Press **DVD MENU** during playback.  
The DVD menu available on the disc is now displayed.

Pressing **RETURN** resumes playback from the scene when MENU was first pressed.

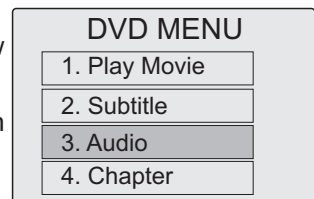

Example

- 2 Press **◀/▶** or **▲/▼** to select item and press **ENTER**, or press **number buttons** to select item.

## Using a PBC menu [VCD]

When playing a VCD with **PBC** features and the **PBC** function is turned on, pressing the **RETURN** will display the **PBC** menu. Now you can select a track by using the **number buttons**.

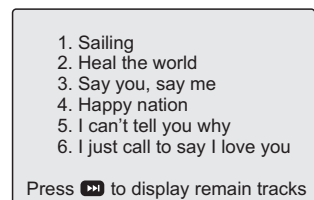

Example

### Note

- Only those VCD discs with PBC features can use this menu feature.
- You can toggle PBC ON and PBC OFF by pressing DVD MENU.

# Locating Desired Scene

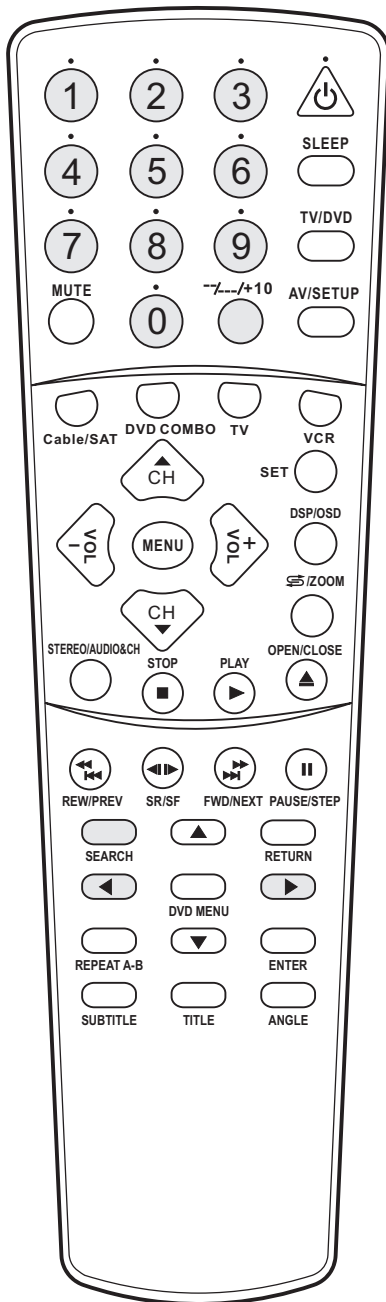

## Note

- The on-screen display maybe different and it depends on the disc you are playing back.

## Locating desired scene [DVD]

You can use the title, chapter and time recorded on the disc to locate a desired point to play back.

### 1 Press **SEARCH** during playback.

Press this button once and the unit allows you to select title or chapter with the **number buttons**.

TITLE 01/02 CHAPTER ■/16

You can toggle **TITLE** and **CHAPTER** with ◀ or ▶.

TITLE ■/02 CHAPTER 00/00

### 2 Press **SEARCH** again to locate desired scene by **TITLE** or **TIME**.

The unit allows you to select title or time with the **number buttons**.

TITLE 01/02 TIME ■:■:■

You can toggle **TITLE** and **TIME** with ◀ or ▶.

TITLE ■/02 TIME 0:00:00

## Note

- The time you input should not longer than the total time of current TITLE.

### 3 Press **SEARCH** third time to locate desired scene by **CHAPTER** or **TIME**.

The unit allows you to select chapter or time with the **number buttons**.

CHAPTER 01/16 TIME ■:■:■

You can toggle **CHAPTER** and **TIME** with ◀ or ▶.

CHAPTER ■/16 TIME 0:00:00

## Note

- The time you input should not longer than the total time of current CHAPTER.

## Locating desired point [Audio CD/VCD]

### 1 Press **SEARCH** during playback.

The unit allows you to locate desired point by time.

DISC GOTO ■:■:■

## Note

- The time you input should not longer than the total time of the disc.

### 2 Press **SEARCH** again.

The unit allows you to locate desired point by time.

TRACK GOTO ■:■:■

## Note

- The time you input should not longer than the total time of the current track.

### 3 Press **SEARCH** third time.

The unit allows you to locate desired point by track.

SELECT TRACK ■/12

# Displaying Status of Disc

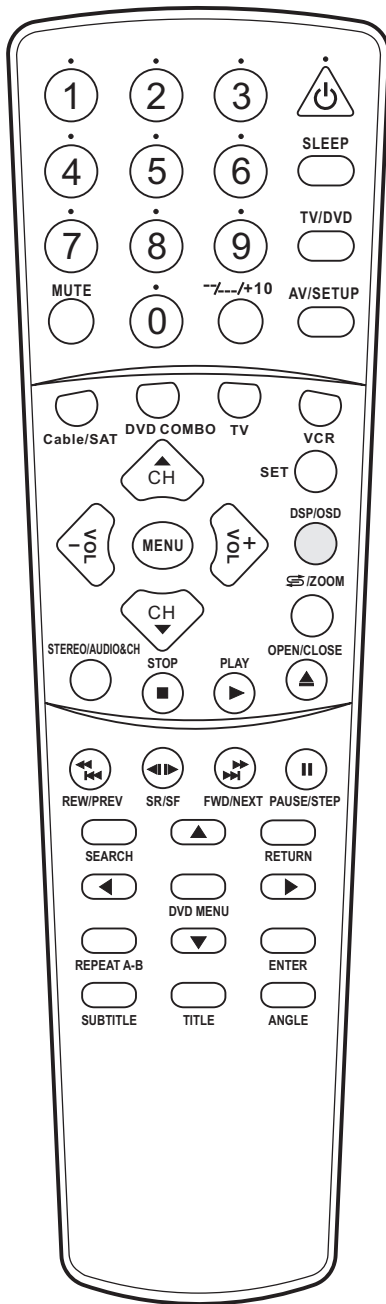

## Note

- The on-screen display may be different than illustrated and dependent on the type of disc being played.

The status of disc can be displayed by pressing **DSP/OSD** repeatedly. The information displayed on the screen is different according to the type of disc you are playing back. Each press of this button displays the following:

## [DVD]

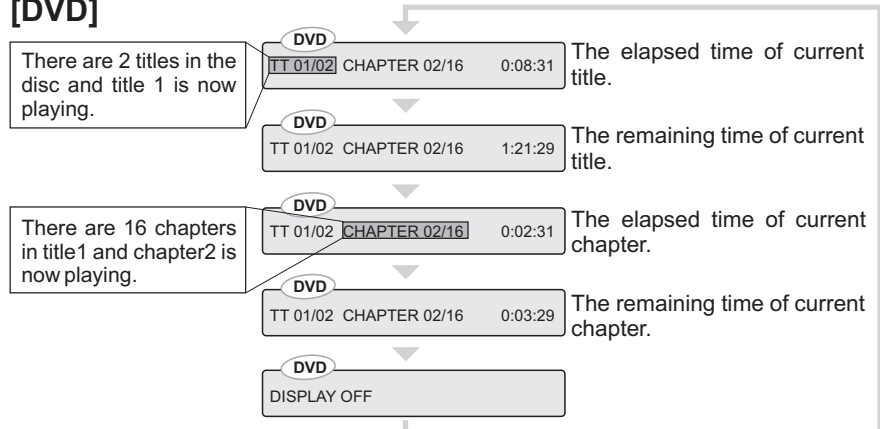

## [VCD]

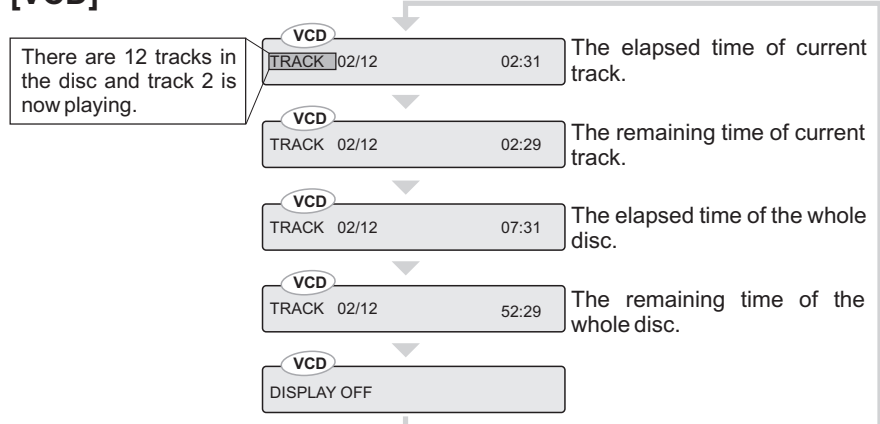

## Note

- When playing VCD or SVCD, the "elapsed time of the whole disc" and "remaining time of the whole disc" can not display unless the **PBC** is turned off.

## [CD]

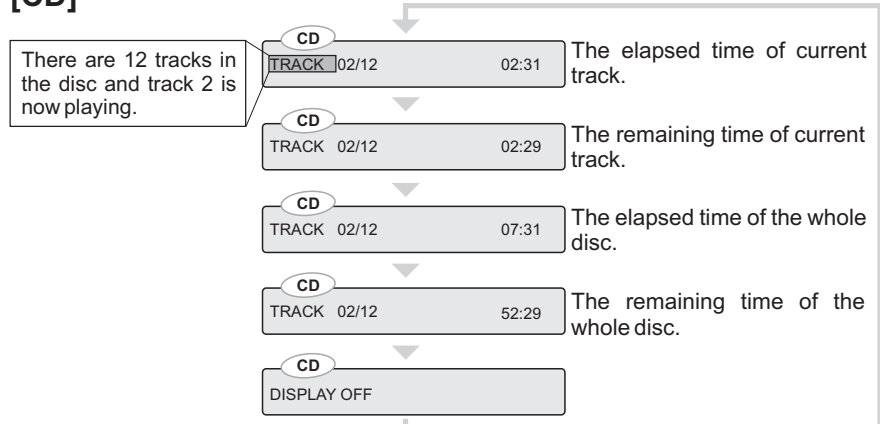

# Special Functions

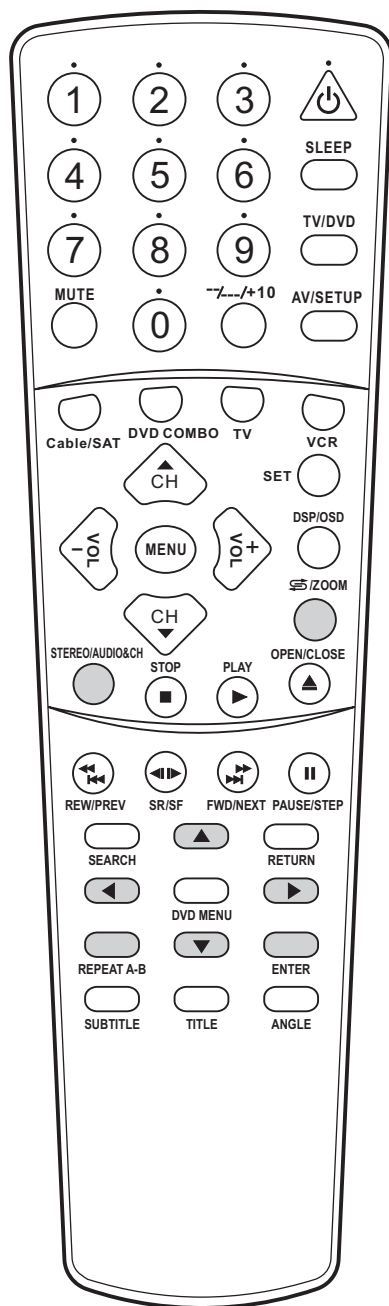

## Zooming

When you play DVD or VCD, this unit allows you to zoom in or zoom out during playback. Each press of the **ZOOM** button, the unit operates as:

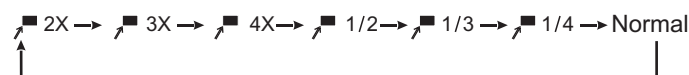

When you zoom in the frame image, you can make selections by switching the position of the frame by using **◀ / ▶** or **▲ / ▼**.

## Setting soundtrack language

You can select the language when you play a multilingual disc.

- 1 Press **STEREO/AUDIO&CH** during playback.

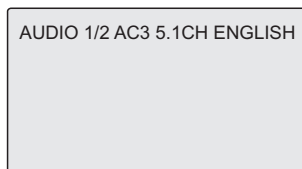

The current soundtrack language will appear.

- 2 Press **STEREO/AUDIO&CH** repeatedly until the desired language is selected.

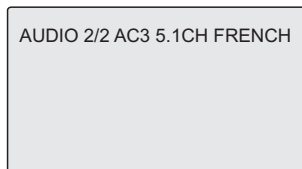

The on-screen display will disappear after a few seconds.

When you play Video CD, press **STEREO/AUDIO&CH** to change the audio channel. With each press of this button, the unit operation is:

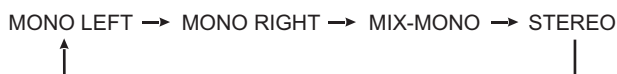

## Note

- This function depends on the disc. If the desired language is not heard after pressing the button several times, the language is not recorded on the disc.
- The soundtrack language selection is cancelled when you open the disc tray or turn the power off. The initial default language or available language will be heard if the disc is played back again.

## Repeat playback

This unit allows you to repeat material between two selected points.

- 1 Press **REPEAT A-B** during playback.

The start point is selected.

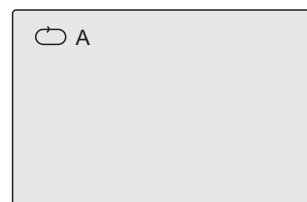

- 2 Press **REPEAT A-B** again.

The end point is selected. Playback starts at the start point you selected and stops at the end point, returns to Point A automatically, then starts again.

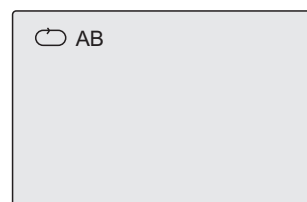

To resume normal playback press **REPEAT A-B** once again.

## Note

- If you play DVD, please set point A and B in the same chapter; If you play VCD or audio CD, please set point A and B in the same track.
- Some discs may not work with the repeat operation.
- You may not be able to set A-B repeat, depending on the scenes of the DVD.

## Special Functions

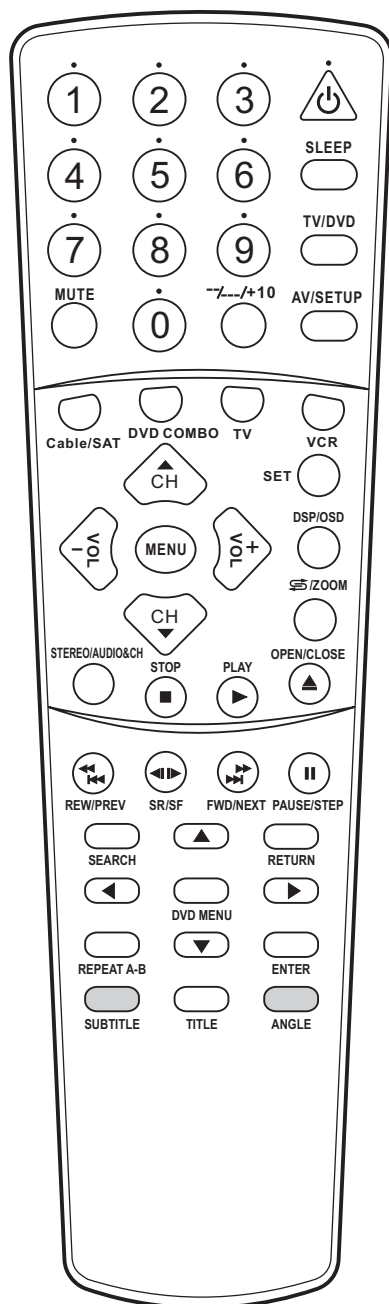

### Changing Angles [DVD]

Some DVDs contain scenes which have been shot simultaneously from a number of different angles. For these discs, the same scene can be viewed from these different angles with the **ANGLE** button. (This feature depends upon inclusion on the disc)

- 1 Press **ANGLE** during playback.  
The current angle will appear.
- 2 Press **ANGLE** repeatedly until the desired angle is selected.

#### Note

- This function only works for titles having scenes recorded at different angles.
- Depending on the DVD, you may not be able to change the angles using this button even if multi-angles are recorded on the DVD.

### Changing Subtitle languages [DVD]

You can select the language when playing back a disc recorded with multi-lingual subtitles.

- 1 Press **SUBTITLE** during playback.  
The current subtitle will appear.

SUBTITLE 1/8: ENGLISH

- 2 Press **SUBTITLE** repeatedly until your desired language appears.

SUBTITLE 3/8: FRENCH

The on-screen display will disappear after a few seconds

- 3 If you want to turn off the subtitle, press **SUBTITLE** repeatedly until "**SUBTITLE OFF**" appears.

SUBTITLE OFF

#### Note

- This operation works only with discs on which multiple subtitle languages are recorded.
- If desired language is not selected after pressing the **SUBTITLE** button several times, the language is not recorded on the disc.
- The selected subtitle language is cancelled when you open the disc tray or turn the power off.
- In some cases, the subtitle language is not changed to the selected one immediately.



# Initial Settings

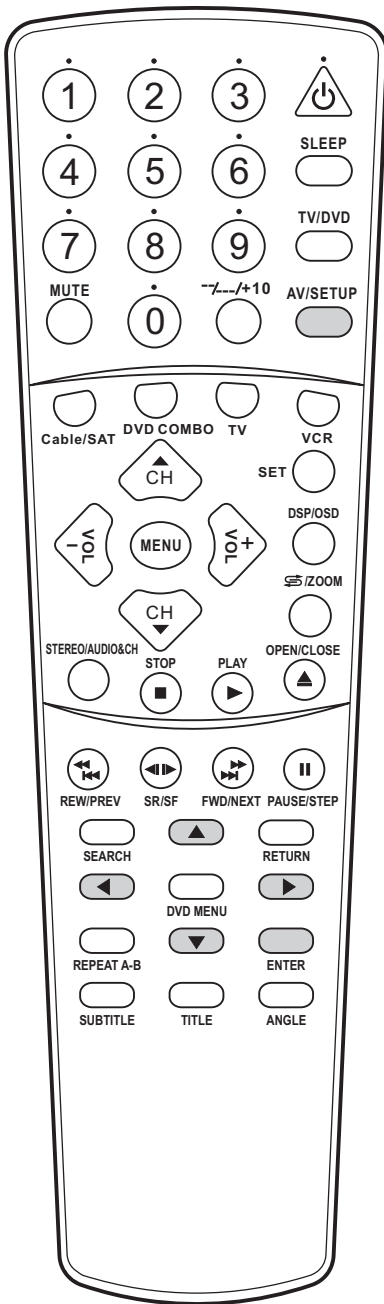

## Note

- Press the AV/SETUP button to exit setup menu after completion of initial settings.
- The "▼" mark on the screen indicates that there are some items that cannot be displayed on screen. To display the concealed items, press the "▼" button.

Once the initial settings have been completed, the player can always be operated under the same conditions (especially DVDs). The settings will be retained in the memory even after switching to standby mode.

## GENERAL SETUP

### Accessing GENERAL SETUP page

- Press **AV/SETUP** to display initial setup menu.
- Press **▲** or **▼** to select **GENERAL SETUP** item.
- Press **ENTER**.

Now you can start **GENERAL SETUP**.

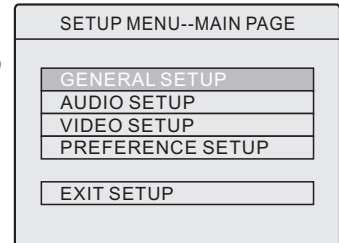

### 1. Setting TV TYPE

- Press **▲** or **▼** to select TV TYPE item.
- Press **▶** to access option item.
- Press **▲** or **▼** to select option item.
- Press **ENTER** to confirm and press **◀** to return.

PAL: force PAL system output.  
 NTSC: force NTSC system output.  
 AUTO: automatically identify system.

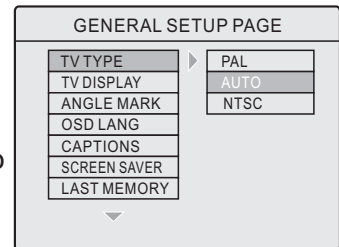

### 2. Setting TV DISPLAY

- Press **▲** or **▼** to select TV DISPLAY item.
- Press **▶** to access option item.
- Press **▲** or **▼** to select option item.
- Press **ENTER** to confirm and press **◀** to return.

NORMAL/PS: It displays the wide screen image as full screen with left and right edges automatically cut off.

NORMAL/LB: Select this mode when connecting to a conventional TV. When playing back a wide screen-DVD disc, it displays the wide picture with black bands at the top and bottom of screen.

WIDE: Select this mode when connecting to wide-screen TV. A wide screen picture is displayed in full size.

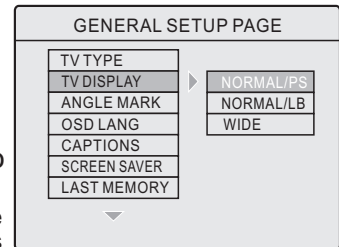

## Note

- This function may not operate on all discs.

### 3. Setting ANGLE MARK

- Press **▲** or **▼** to select ANGLE MARK item.
- Press **▶** to access option item.
- Press **▲** or **▼** to select option item.
- Press **ENTER** to confirm and press **◀** to return.

ON: When playing back a DVD disc recorded with a multi-angle feature, an angle indicator will display on the screen.

OFF: turns off the multi angle display indicator.

## Note

- This function only works for the discs recorded with the multi angle feature.

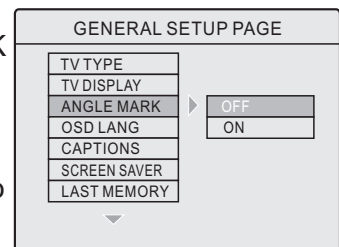

# Initial Settings

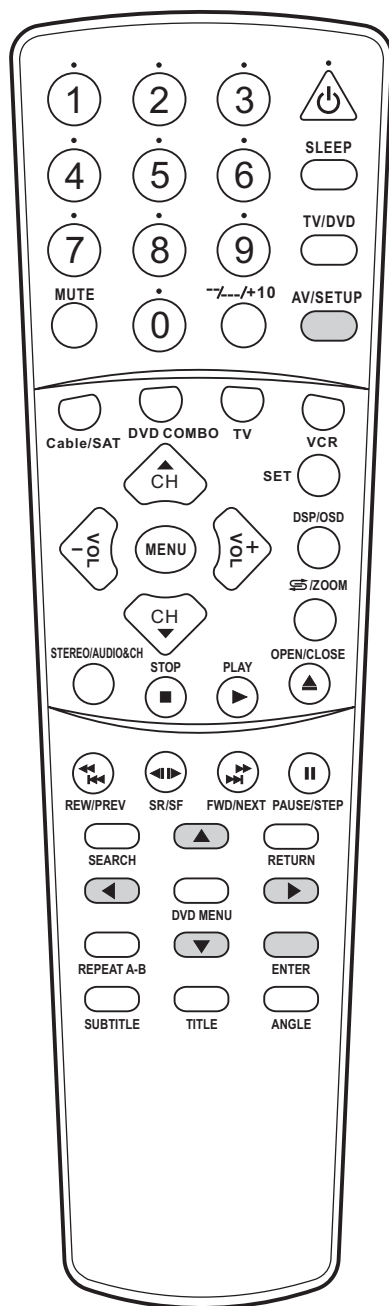

## Note

- Press the AV/SETUP button to exit setup menu after completion of initial settings.

## GENERAL SETUP (continued)

### 4. Setting OSD LANGUAGE

- Press  $\blacktriangle$  or  $\blacktriangledown$  to select OSD LANG item.
- Press  $\blacktriangleright$  to access option item.
- Press  $\blacktriangle$  or  $\blacktriangledown$  to select option item.
- Press ENTER to confirm and press  $\blacktriangleleft$  to return.

This unit provides ENGLISH, FRENCH and SPANISH OSD languages for your selection.

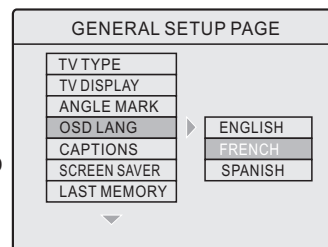

### 5. Setting the CAPTION feature

- Press  $\blacktriangle$  or  $\blacktriangledown$  to select CAPTIONS item.
- Press  $\blacktriangleright$  to access option item.
- Press  $\blacktriangle$  or  $\blacktriangledown$  to select option item.
- Press ENTER to confirm and press  $\blacktriangleleft$  to return.

This function allows you to turn the closed caption feature on or off.

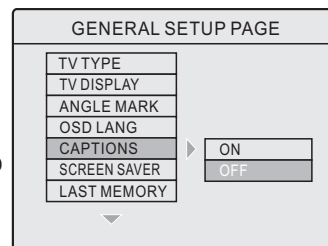

## Note

- This function depends on the discs.

### 6. Setting SCREEN SAVER

- Press  $\blacktriangle$  or  $\blacktriangledown$  to select SCREEN SAVER item.
- Press  $\blacktriangleright$  to access option item.
- Press  $\blacktriangle$  or  $\blacktriangledown$  to select option item.
- Press ENTER to confirm and press  $\blacktriangleleft$  to return.

If you set SCREEN SAVER to ON, the unit will start the screen saver when there is no disc or the DVD is in STOP mode for 1 minute.

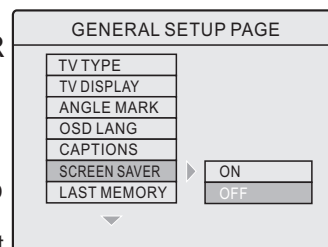

## Note

- This function only works when the TV/DVD is in DVD mode.

### 7. Setting LAST MEMORY

- Press  $\blacktriangle$  or  $\blacktriangledown$  to select LAST MEMORY item.
- Press  $\blacktriangleright$  to access option item.
- Press  $\blacktriangle$  or  $\blacktriangledown$  to select option item.
- Press ENTER to confirm and press  $\blacktriangleleft$  to return.

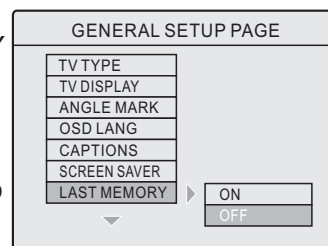

If you set this feature to ON, the unit remembers the stop point on the disc when the DVD component is switched off **by the remote control**. Once the DVD component is switched on again, the unit will play from the last stop point automatically. This function is useful when you are watching movie.

## Note

- This function does not work when the DVD component is switched off by pressing **POWER** or **TV/DVD** button on the **panel** of the unit.

# Initial Settings

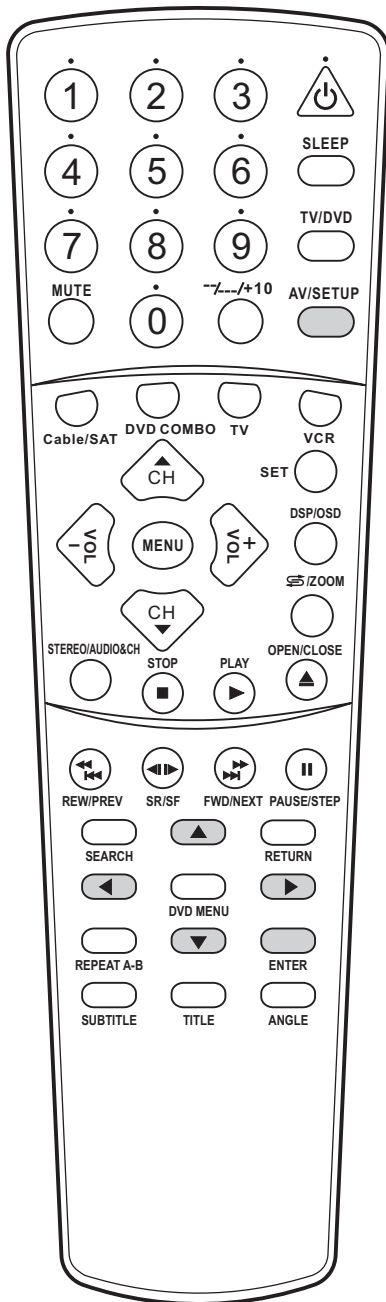

## Note

- Press the AV/SETUP button to exit setup menu after completion of initial settings.

## AUDIO SETUP

### Accessing AUDIO SETUP page

- Press **AV/SETUP** to display initial setup menu.
- Press **▲** or **▼** to select **AUDIO SETUP** item.
- Press **ENTER**.

Now you can start **AUDIO SETUP**.

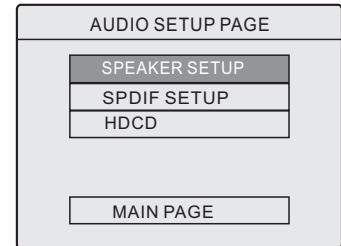

### 1. SPEAKER SETUP

- Press **▲** or **▼** to select **SPEAKER SETUP** item.
- Press **ENTER** to enter.
- Press **▶** to access option item.
- Press **▲** or **▼** to select option item.
- Press **ENTER** to confirm and press **◀** to return.
- Press **▼** to select **AUDIO SETUP** item and press **ENTER** to return to **AUDIO SETUP PAGE**.

LT/RT: output audio signal which is encoded with Dolby surround stereo information so that an amplifier is able to process the signal.  
STEREO: output audio signal in left and right channel.



### 2. SPDIF SETUP

- Press **▲** or **▼** to select **SPDIF SETUP** item.
- Press **ENTER** to enter.

SPDIF: Sony/Philips Digital Interface. The unit outputs a digital signal for the amplifier to decode via SPDIF.

#### ▶ SPDIF OUTPUT

- Press **▲** or **▼** to select **SPDIF OUTPUT** item.
- Press **▶** to access option item.
- Press **▲** or **▼** to select option item.
- Press **ENTER** to confirm and press **◀** to return.

SPDIF OFF: turn off SPDIF output.

SPDIF/PCM: the unit first decodes the disc and then encodes the audio signal as PCM to the output.

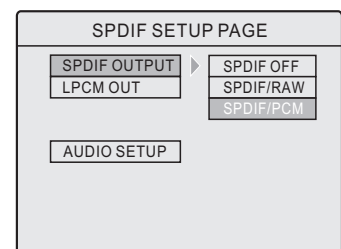

#### ▶ LPCM OUT

- Press **▲** or **▼** to select **LPCM OUT** item.
- Press **▶** to access option item.
- Press **▲** or **▼** to select option item.
- Press **ENTER** to confirm and press **◀** to return.

48k: convert 96K LPCM digital audio to 48K LPCM digital audio and output.

96K: output LPCM digital audio with its original codes.

- Press **▼** to select **AUDIO SETUP** item and press **ENTER** to return to **AUDIO SETUP PAGE**.

## Note

- If the sample rate of the disc is lower than your choice, the audio outputs according to the lower sample rate.

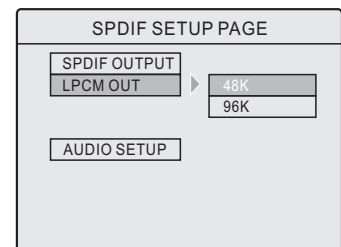

# Initial Settings

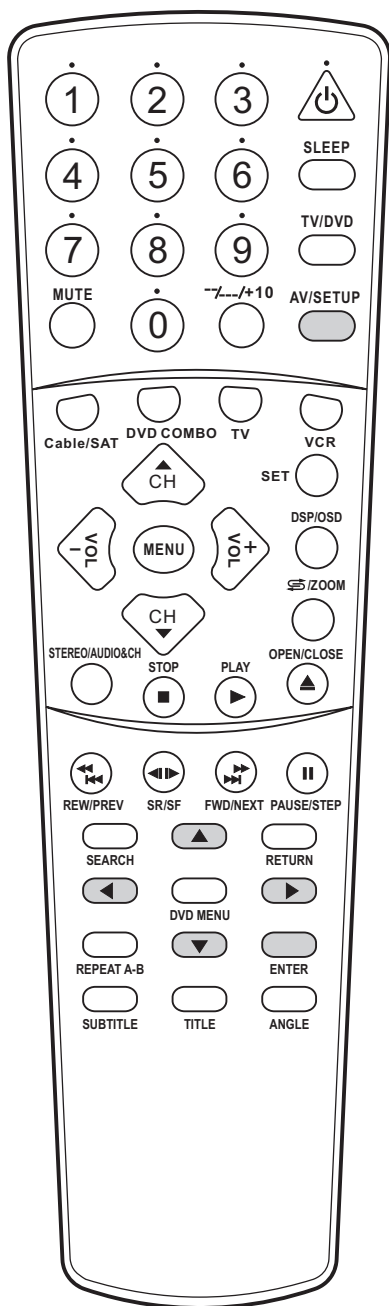

## Note

- Press the AV/SETUP button to exit setup menu after completion of initial settings.

## AUDIO SETUP (continued)

### 3. Setting HDCD

- Press  $\blacktriangle$  or  $\blacktriangledown$  to select HDCD item.
- Press ENTER to confirm.
- Press  $\blacktriangleright$  to access option item.
- Press  $\blacktriangle$  or  $\blacktriangledown$  to select option item.
- Press ENTER to confirm and press  $\blacktriangleleft$  to return.
- Press  $\blacktriangledown$  to select AUDIO SETUP item and press ENTER to return to AUDIO SETUP PAGE.

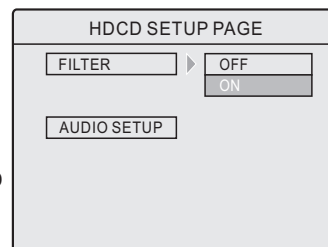

## VIDEO SETUP

### Accessing VIDEO SETUP page

- Press AV/SETUP to display initial setup menu.
  - Press  $\blacktriangle$  or  $\blacktriangledown$  to select VIDEO SETUP item.
  - Press ENTER.
- Now you can start VIDEO SETUP.

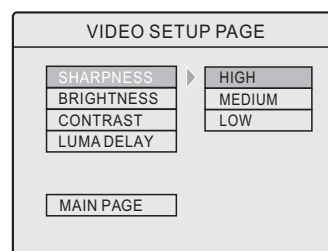

### 1. Setting SHARPNESS

- Press  $\blacktriangle$  or  $\blacktriangledown$  to select SHARPNESS item.
  - Press  $\blacktriangleright$  to access option item.
  - Press  $\blacktriangle$  or  $\blacktriangledown$  to select option item.
  - Press ENTER to confirm and press  $\blacktriangleleft$  to return.
- The unit allows you to set SHARPNESS to HIGH, MEDIUM or LOW.

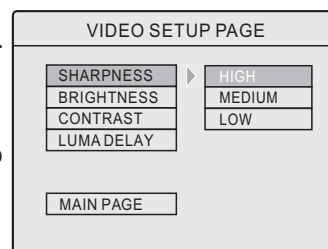

### 2. Setting BRIGHTNESS

- Press  $\blacktriangle$  or  $\blacktriangledown$  to select BRIGHTNESS item.
- Press  $\blacktriangleright$  to access option item.
- Press ENTER to confirm.
- Press  $\blacktriangle$  or  $\blacktriangledown$  to adjust.
- Press  $\blacktriangleleft$  to return.

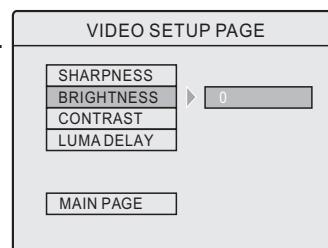

### 3. Setting CONTRAST

- Press  $\blacktriangle$  or  $\blacktriangledown$  to select CONTRAST item.
- Press  $\blacktriangleright$  to access option item.
- Press ENTER to confirm.
- Press  $\blacktriangle$  or  $\blacktriangledown$  to adjust.
- Press  $\blacktriangleleft$  to return.

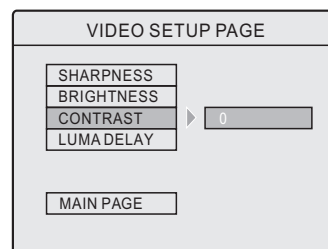

# Initial Settings

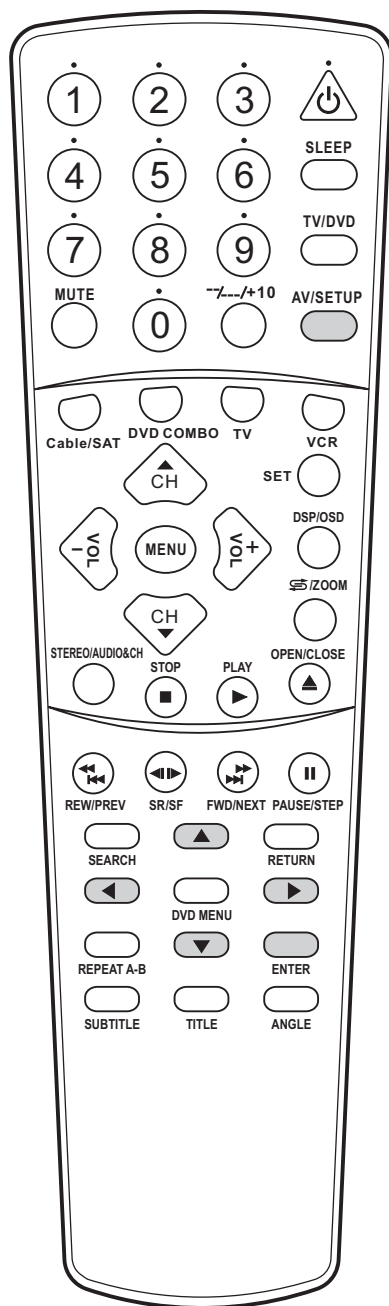

## Note

- Press the AV/SETUP button to exit setup menu after completion of initial settings.
- The AUDIO LANGUAGE, SUBTITLE LANGUAGE and DISC MENU LANGUAGE features are only available if they have been programmed into the DVD.

## VIDEO SETUP (continued)

### 4. Setting LUMA DELAY item

- Press **▲** or **▼** to select LUMA DELAY item.
- Press **▶** to access option item.
- Press **▲** or **▼** to select option item.
- Press **ENTER** to confirm and press **◀** to return.

In most cases, "1T" is recommended when playing DVD material. "0T" is recommended when playing other material.

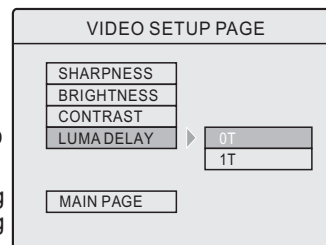

## PREFERENCE SETUP

### Accessing PREFERENCE SETUP page

- Press **AV/SETUP** to display initial setup menu.
- Press **▲** or **▼** to select **PREFERENCE SETUP** item.
- Press **ENTER**.

Now you can start **PREFERENCE SETUP**.

- ❗ The PREFERENCE PAGE can not be accessed unless the DVD is in STOP mode or no disc loaded by the unit.

### 1. Setting Audio Language

- Press **▲** or **▼** to select AUDIO item.
- Press **▶** to access option item.
- Press **▲** or **▼** to select an audio language.
- Press **ENTER** to confirm and press **◀** to return.

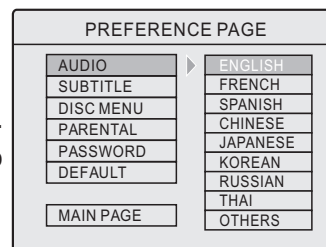
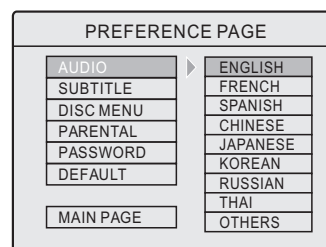

### 2. Setting Subtitle Language

- Press **▲** or **▼** to select SUBTITLE item.
- Press **▶** to access option item.
- Press **▲** or **▼** to select a subtitle language.
- Press **ENTER** to confirm and press **◀** to return.

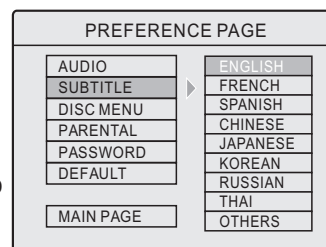

### 3. Setting Disc menu Language

- Press **▲** or **▼** to select DISC MENU item.
- Press **▶** to access option item.
- Press **▲** or **▼** to select a disc menu language.
- Press **ENTER** to confirm and press **◀** to return.

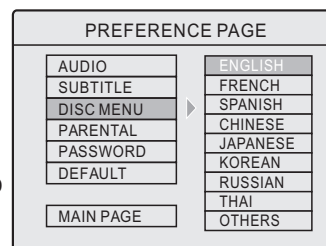

# Initial Settings

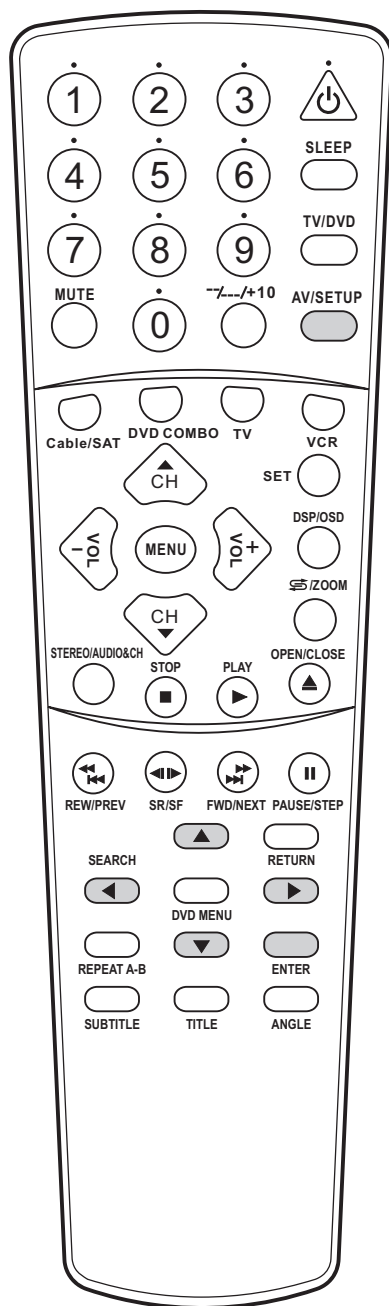

## Note

- Press the AV/SETUP button to exit setup menu after completion of initial settings.

## PREFERENCE SETUP (continued)

### 4. Setting Parental lock level

This is to disable the playing of some DVDs which are unsuitable for some audiences, for example, children. Some DVDs are encoded with a specific rating level. If the rating level of the disc is higher than that preset in the initial settings operation, playback of the disc will be prohibited.

- Press ▲ or ▼ to select PARENTAL item.
- Press ▶ to access option item.
- Press ▲ or ▼ to select a desired rating.
- Press ENTER to confirm.

The unit will display "PASSWORD VERIFY PAGE" and you will need to input your password to finish setting the rating level. Please refer to the "**Setting PASSWORD**" subchapter for information on setting a password for the Parental Lock

- Enter password with **number buttons**.
- Press **ENTER** to confirm.

## Note

- This function depends upon encoding on the disc. Some discs may not be encoded with specific rating level information. For those discs without this encoding the PARENTAL LOCK function may not work.

PREFERENCE PAGE	
AUDIO	1 KID SAF
SUBTITLE	2 G
DISC MENU	3 PG
PARENTAL	4 PG 13
PASSWORD	5 PGR
DEFAULT	6 R
	7 NC 17
	8 ADULT
	OFF
MAIN PAGE	

PASSWORD VERIFY PAGE	
OLD PASSWORD	<input type="text"/>

### 5. Setting 6-digit Password

- Press ▲ or ▼ to select PASSWORD item.
- Press ▶ to access option item.
- Press ENTER to confirm.

Now the unit display "PASSWORD CHANGE PAGE".

- Enter the old password.
- Enter the new password.
- Repeat the new password.

## Be sure to remember your new password!

The default password for the unit is blank. If you are entering a password into the unit for the first time, you will not be asked to enter the OLD PASSWORD.

PREFERENCE PAGE	
AUDIO	
SUBTITLE	
DISC MENU	
PARENTAL	
PASSWORD	CHANGE
DEFAULT	
MAIN PAGE	

PASSWORD CHANGE PAGE	
OLD PASSWORD	<input type="text"/>
NEW PASSWORD	<input type="text"/>
CONFIRM PWD	<input type="text"/>

### 6. Loading Default settings

This function allows you to load the default settings from factory. Please use **CAUTION** when activating this function as all programmed setting will be replaced by the factory default settings.

- Press ▲ or ▼ to select DEFAULT item.
- Press ▶ to access option item.
- Press ENTER to confirm.

PREFERENCE PAGE	
AUDIO	
SUBTITLE	
DISC MENU	
PARENTAL	
PASSWORD	
DEFAULT	RESET
MAIN PAGE	

# Playing Back MP3 disc

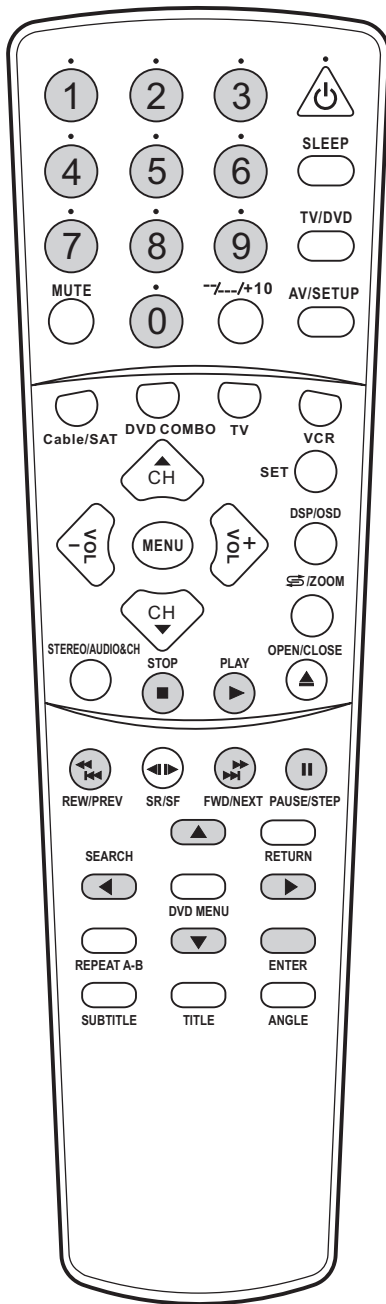

## Note

- The on-screen display may be different depending on the disc you are playing.

This unit is able to playback discs recorded with MP3 files. When a MP3 disc is loaded, a file menu screen displays.

## Note

- This menu screen is for illustration only.
- If all MP3 files are recorded in the root directory, no folder appears.

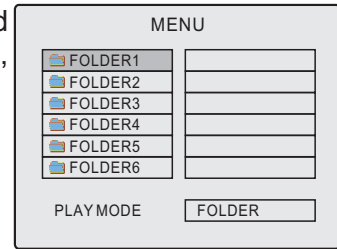

## PLAYBACK OPERATIONS

### 1. Playback

- Press ▲ or ▼ to select your desired folder
- Press ENTER to enter the folder and display MP3 tracks.
- Press ▶ to access MP3 track item.
- Press ▲ or ▼ to select a desired track.
- Press PLAY or ENTER to playback.

#### How do you return to the upper directory?

- Press STOP to stop playback.
- Press ◀ to select <UP DIR> item.
- Press ENTER to confirm.

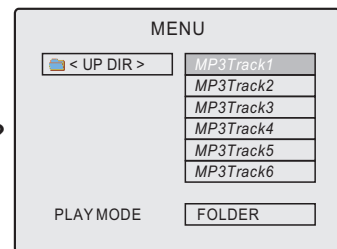

### 2. Music track selection

- Press 0-9 to select a desired track.

You need to input a 3-digit track number by using **number buttons**. For example, you want MP3Track5, press 0 0 5 in order.

**- OR -**

- Press STOP to stop playback.
- Press ▲ or ▼ to select a desired track.
- Press PLAY or ENTER to playback.

### 3. Pause Playback

- Press PAUSE/STEP during playback.
- To resume playback, press PAUSE/STEP again or press PLAY.

### 4. Stop Playback

- Press STOP during playback.

### 5. Fast Forward Playback / Skip tracks forward

Press **FWD/NEXT** repeatedly to playback fast forward or skip to next track. Each press of this button, the unit functions as follows:



To resume normal playback, press **PLAY**.

### 6. Reverse Playback /Skip tracks reverse

Press **REW/PREV** repeatedly to playback reverse or skip to last track. Each press of this button, the unit functions as follows:



To resume normal playback, press **PLAY**.

# Playing Back MP3 disc

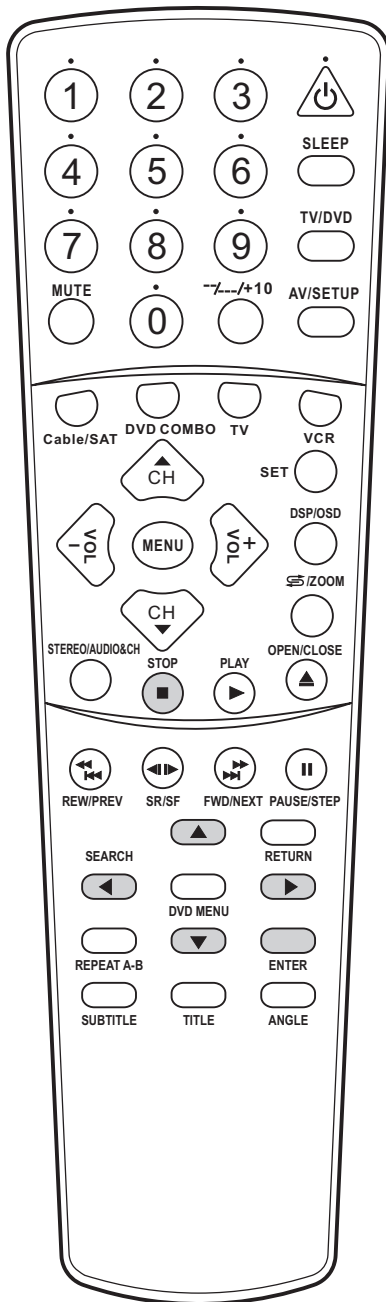

## PLAY MODE selection

You need to stop playback before selecting a play mode.

- Press STOP to stop playback.
- Press ▶ to toggle MP3 track and PLAY MODE

- OR -

Press ◀ to toggle <UP DIR> item and PLAY MODE.

- Press ▲ or ▼ to select desired play mode.

### 1. SINGLE

The unit only plays the selected track and automatically stops when the track is finished.

### 2. REPEAT ONE

The unit plays only the selected track and automatically repeats this track.

### 3. REPEAT FOLDER

The unit plays all tracks in current folder and automatically repeats all tracks in this folder.

### 4. SHUFFLE

The unit only tracks in current folder in random order, regardless of pressing the REW/PREV or FWD/NEXT buttons.

### 5. FOLDER

The unit only plays all tracks in current folder and automatically stops when all tracks have been played.

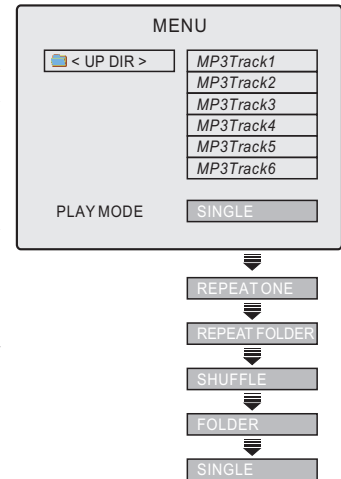

## Note

- The on-screen display may be different depending on the disc you are playing.



# Playing Back Kodak Picture CD

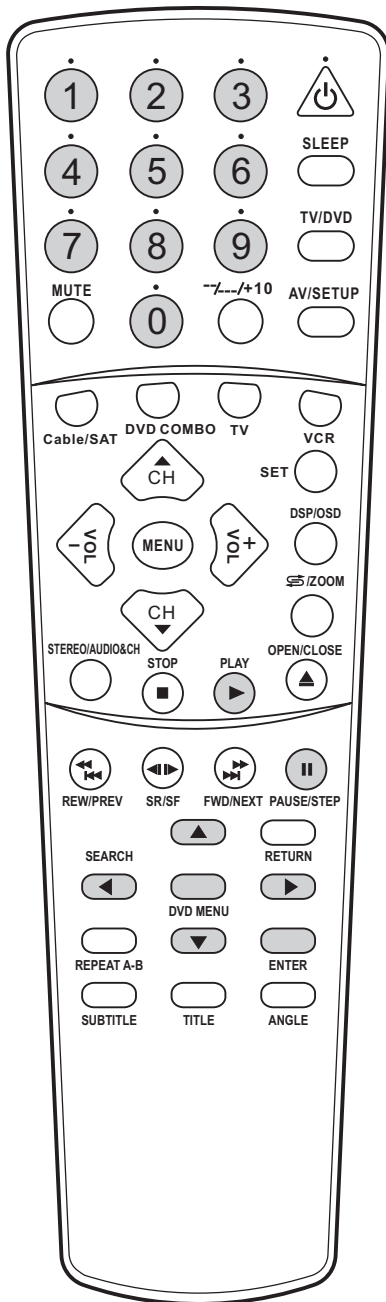

## Note

- The on-screen display may be different depending on the disc you are playing.

This unit is able to playback Kodak picture CDs.

## Supported formats:

- File system: ISO9660, Joliet.
- File extension: JPEG files.
- Max. picture size: 3072 x 3072 pixels

When a Kodak picture CD is loaded, a menu screen displays.

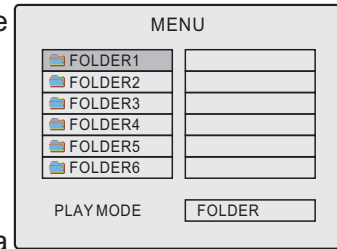

## Note

- This menu screen is for illustration only.
- If all JPEG files are recorded in the root directory, no folder appears.

## PLAYBACK OPERATIONS

### 1. Slide Playback

- Press ▲ or ▼ to select your desired folder
- Press ENTER to enter the folder and display picture files.
- Press ▶ to access picture files.
- Press ▲ or ▼ to select a desired file.
- Press PLAY or ENTER to playback.

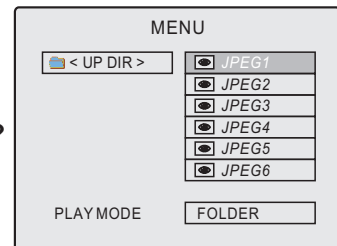

### How do you return to the upper directory?

- Press DVD MENU to stop playback.
- Press ◀ to select <UP DIR> item.
- Press ENTER to confirm.

### 2. Picture selection

- Press 0-9 to select a desired picture.
- You need to input a 3-digit number by using **number buttons**.  
For example, you want JPEG5, press 0 0 5 in order.

**- OR -**

- Press DVD MENU to stop playback.
- Press ▲ or ▼ to select a desired picture.
- Press PLAY or ENTER to playback.

### 3. Pause Slide Playback

- Press PAUSE/STEP during slide playback.
- To resume slide playback, press PAUSE/STEP again or press PLAY or ENTER.

### 4. Stop playback and return to file list

- Press DVD MENU during slide playback.

## PLAY MODE selection

The operation of this feature is similar to the section "PLAY MODE selection" detailed on the previous page.

# Playing Back Kodak Picture CD

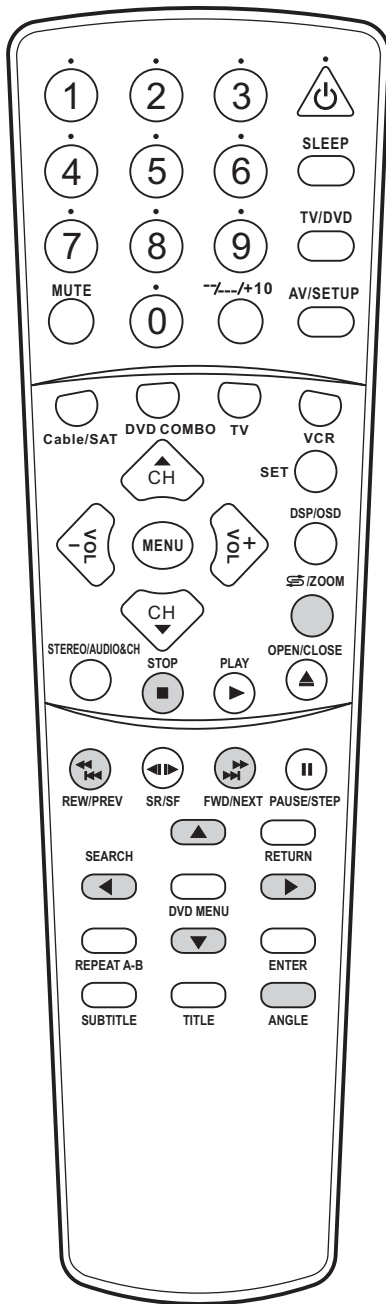

## Note

- The on-screen display may be different depending on the disc you are playing.
- The ZOOM function does not work with progressive scanning pictures.

## Setting picture transition effects

The transition effects is applied at the moment when the current slide image is replaced by the next slide image. This unit provides 17 kinds of transition effects. You can select the transition effect by pressing ANGLE during slide playback.

Transit from top to bottom	Transit from vertical center to left and right
Transit from bottom to top	Transit from bottom and top to horizontal center
Transit from left to right	Transit from left and right to vertical center
Transit from right to left	Transit from top to bottom in four windows
Transit from top left corner to bottom right corner	Transit from left to right in four windows
Transit from top right corner to bottom left corner	Transit periphery top to center
Transit from bottom left corner to top right corner	RANDOM: Apply effects in random
Transit from bottom right corner to top left corner	NONE: No effect is applied
Transit from horizontal center to bottom and top	

## Zooming picture

- Press /ZOOM during slide playback to turn on ZOOM function.
- Press FWD/NEXT to zoom in. Each press of this button, the unit functions as follows:

ZOOM 100% → ZOOM 125% → ZOOM 150% → ZOOM 200%

You can move the picture by pressing / or /.

- Press REW/PREV to zoom out. Each press of this button, the unit operates as:

ZOOM 100% → ZOOM 75% → ZOOM 50%

- Press /ZOOM to turn off ZOOM function.

## Rotating/Mirroring picture

The unit allows you to rotate or mirror picture during slide playback by pressing / or /.

- Press during slide playback to rotate picture anti-clockwise by 90°.
- Press during slide playback to rotate picture clockwise by 90°.
- Press during slide playback to mirror picture vertically.
- Press during slide playback to mirror picture horizontally.

## Browsing pictures

- Press STOP during slide playback to browse pictures. Every screen displays 12 pictures in proportional thumbnails.
- Press / or / to select item.
- Press ENTER or playback to confirm.

# Setting the Universal Remote Control Unit

Your Universal Remote Control has been preprogrammed to operate your TV (just press the TV button). You may also program the Universal Remote Control to operate other devices.

## 1. HOW TO SET THE UNIT

Locate the correct code for the Brand/Model of the device you wish to control from the attached code list.

- 1** Press and hold the SET key and then press the key that corresponds to the device you wish to control (TV, VCR, Cable/SAT, or DVD/VCD/HIFI).
- 2** Enter one of the 3-digit code for your Brand/Model from the list.
- 3** The LED indicator will blink twice.

If the correct code has been entered, all the functions of the device you wish to control should operate. Some of the codes will control most but not all of the functions of your device. If this occurs, repeat the above 3 steps using another 3 digit code from the code list that corresponds to your Brand/Model.

### Note:

- **Do not exceed 5 seconds between each step.**

## 2. HOW TO DETERMINE A 3-DIGIT CODE

- 1** Hold SET and press 1 simultaneously then release. The number of times LED indicator represents the number of the 1<sup>st</sup> digit.
- 2** Hold SET and press 2 simultaneously then release. The number of times LED indicator represents the number of the 2<sup>nd</sup> digit.
- 3** Hold SET and press 3 simultaneously then release. The number of times LED indicator represents the number of the 3<sup>rd</sup> digit.

## 3. HOW TO USE "QUICK SEARCH"

If you can not locate the appropriate code for your Brand/Model, you can try "Quick Search".

- 1** Turn the device you wish to control ON.
- 2** Locate the button on the Universal Remote Control for the device you want to operate (TV, VCR, Cable/SAT, or DVD/VCD/HIFI). Press this key for 3 seconds, then release. The "Quick Search" mode is on when the LED indicator blinks.
- 3** When the device you wish to control shuts off, immediately press the SET key and release.

If the correct code has been found, all the functions of the device you wish to control should operate. If not, repeat the above steps 1 -3.

## 4. HOW TO SWITCH OVER TO DIFFERENT DEVICE

Your Universal Remote Control is already programmed to operate your TV (just press the TV button). If you have programmed the Universal Remote Control to operate other devices, you must press the key that corresponds to the device you wish to control (TV, VCR, Cable/SAT, or DVD/VCD/HIFI).

## 5. CODE LIST ON SETUP MODE OR QUICK SEARCH MODE

DEVICE NAME	FOR DEVICE	TOTAL CODES	ACTIVE DEVICE CODE
TV	TV/CTV/TXT	304	001-304
VCR	VCR	384	001-384
CAB/SAT	CABEL/SATELLITE	270	001-270
DVD/VCD/HIFI	DVD/VCD/HIFI	292	001-292

## 6. MEMO OF BRAND & MODEL

DEVICE	BRAND	MODEL	CODE
TV			
VCR			
CAB/SAT			
DVD/VCD/HIFI			

# Setting the Universal Remote Control Unit

## 7. CODE LIST ON SETUP MODE OR QUICK SEARCH MODE

### TV codes

ADMIRAL	143 146 147 148
ADVENT	001 002 133 134 142 153 155 157
AIKO	026
AIWA	039 058
AKAI	073 079 084 085 101 107 109 111 123 125
AUDIOVOX	026
BLUEHOUSE	150
CCE	126 127 149 150
DAEWOO	026 030 040 080 081 082 086 128 151 152
DIGISTAR	001 002 133 134 142 153 155 157
DISH	146
ELBE	089 130 103 154
EMERSON	030 137 143 153
FINLUX	034 135 155 156 157
FIRSTLINE	136 160 161 162 163
FISHER	088 164 165 166 167
FUNAI	057 059 060 158 159
GINXIN	113
GOLDSTAR	027 171 172 173 174 178 179 180 181
GRADIENTE	024 029 168 169 170
GRUNDIG	028 077 175 176 177
HITACHI	019 099 050 182 183
HUGHES	148
ITT-NOKIA	102 110 112 184 185
JENSEN	001 002 133 134 142 153 155 157
JVC	011 012 032 033 045 066 095 186 187 188
KASEIKYOU	047 189 190 191 192
LG	027 193 194 195 196
LG-GOLDSTAR	092 104 106 205 206
LOEWE	129 201 202 203 204
LUXOR	125 197 198 199 200

MAGNAVOX	013 207 208 209 210
METZ	132 217 218 219 220 221
MITSUBISHI	014 048 211 212 213
MIVAR	070 131 214 215 216
NEC	029 056 227 228 229 230
NIKKO	026 222 223 224 225 226
NOBLEX	031 231 232 233 234 235
NOKIA	035 036 236 237 238 239
OPTA	129 240 241 242 243 244
PANASONIC	015 020 046 047 061 062 078 096 097 122 245 246
PEONY	038 042 260 261 262 263
PHILCO	026 030 247 248 249 250
PHILIPS	013 072 124 251 252 253 254 255 256 257 258 259
PIONEER	055 151 264 265 266 267 268
PRIMA	001 002 133 134 142 153 155 157
RCA	068 147 269 270 271 272 273
SAMSUNG	021 037 038 071 094 285
SANYO	022 025 052 053 064 090 108 138 139 140 286 287
SEARS	064 288 289 290
SELECO	087 105
SHARP	016 054 063 274 275 276
SINUDYNE	074 075 076 091
SONY	017 049 069 098 277 278 279 280 281 282 283 284
TEKNIKA	026
THOMSON	067 083 093
TOBO	119
TOSHIBA	018 023 051 065 100 298 299 300
WHITE-WESTING HOUSE	001 002 133 134 142 153 155 157
YAMAHA	145
ZENITH	026 030 143 144 301 302

# Setting the Universal Remote Control Unit

## *DVD/VCD/HIFI codes*

ADVENT	147
AIWA	021
AKAI	145
ALCO	145
BLUEHOUSE	123
DENON	018 061 062 107 108 121
DMTECH	050 096 122 123 124 125
FISHER	143
GRUNDIG	016 050 126 127 128 129 130 131 132 241 242 243 244 245
HARMAN	063 109 138 139 140 141 142 143 246 247 248 249 250
HITACHI	024 025 133 134 135 136 137 142 251 252 253 254
IRT	050 255 256 257 258 259 260
JENSEN	147
JVC	006 017 047 048 051 054 060 064 065 093 094 097 100 106 110 111
JX2033G	122 261 262 263 264 265 266
KARDON	063 109 144 145 146 147 148
KENWOOD	008 029 030 031 032 039 043 066 075 076 078 085 089 112 138 140 141
LENCO	136 137 138 139 140 149 150
MAGNAT	050 235 236 237
MAGNAVOX	067 113 154 155 156 157 158
MATSUI	013 159 160 161 162 163 164
MICROMEGA	009 174 175 176 177 178 179
MITSUBISHI	010 045 068 091 114 165 166 167 168 169 170 171 172 173

NORDMENDE	144 267 268 269 270 271 272
ONKYO	022 067 069 113 115 134 135 187 188
OPTIMUS	004 181 182 183 184 185 186
ORION	042 044 059 088 090 105 120 180
PANASONIC	002 018 019 020 052 061 098 107 133 189 190 191 192 193 194
PHILIPS	023 067 070 113 116 195 196 197
PIONEER	004 034 041 080 087 132 198 199 200 201
PRIMA	147
PROSCAN	071 117 202 203 204 205 206 207 208
RCA	071 117 209 210 211 212 213 214
SAMSUNG	011 014 015 049 095 226 227 228
SANYO	007 033 040 056 057 079 086 102 103 121 131 229 230 231 232 233 234
SHARP	026 130 215 216 217 218 219 220 221
SHERWOOD	072 118 126 127 128 129 238 239
SONY	001 054 055 101 125 222 223 224 225
TECHNICS	004 061 107 124 273 274 275
THOMSON	012 046 092 240
TOSHIBA	003 005 031 042 053 058 059 067 077 088 099 104 105 113
VIDEOWAY	060 276 277 278 279 280 281
WANLIDE	119 282 283 284 285 286 287
YAMAHA	035 036 037 038 061 081 082 083 084 107 288
ZENITH	067 113 289 290

# Setting the Universal Remote Control Unit

## **CABLE/SATELLITE codes**

ALPHASTIR	097
AMSTRAD	029 030 031 032 065 066 067 068 092
AMWAY	098
ATLANTA	059 097 098 099 140 141 142 143
ATRANTA	055 094 095 096 136 137 138 139
BT	074 100 101 102 144 145 146 147
CABLE INNOVATIONS	114
CABLEVIEW	011 014 017 103 148 149
CENTURY	100
CHANNEL MASTER	101 150 151 152 153
CHAPANAL	102 133 158 159 160
CHEYENNE	133 154 155 156 157
CI SATELLITE	099 167 168 169
CINAL+	044 081 170 171 172
CITIZEN	011 014 017 104 165 166
CITOH	134 161 162 163 164
CONILER	103 173 174 175 176
CURTIS-MATHES	001 006 055 059 104
D-BOX	085 110 111 112 177 178 179 180
DEHAN	019 107 108 109 181 182 183 184
DIRECTV	105 106 107 108 109 110 111
DISH	095
DISHPLAYER	135 185 186 187 188
DRAHE	112
DX ANTENNA	025 123
ECHOSTAR	026 041 042 043 045 078 079 080 189 190
FORCE	050 089 113 114 191 192 193
FUJITSU	113 194 195 196 197
GALAXIS	035 049 088 123 124
GENERAL INSTRUMENT	025 114 124
GI	002 004 020 056 082 122
GI/JERROLD	056 125 126 127 128
GOLDSTAR	018 115 116 117 118 198 199 200 201

GRUNDIG	033 069 119 120 121 202 203 204
HAMLIN KARDON	008 012 015 061 129 205
HEME CABLE	115 206 207 208 209
HITACHI	105 210 211 212 213
HOUSTON TRACKER	045 214 215 216 217
HUGHES	096 105 106 107 108 109 110 111
INNTERSAT	117 218 219 220 221
IO	116 222 223 224 225
JANEIL	113 226 227 228 229
JERROLD	002 004 020 056 077 082 138 139 140 141 142 143 230 231 232 233
JVC	038 039 074 075 130 131 132 133 134 135 136 137 234
KATHREIN	036 037 072 073
LEGEND	132
LG	018 144 145 146 147 148 235 236 237 238
MAGNAVOX	023 024 130 149 150 151 152 245 246
MASCOM	053 093 119 153 154 155 156 157 239 240
MASPRO	036 158 159 160 161 162 241 242 243 244
MEMGREX	130 247 248 249 250
NOKIA	087 163 164 165 166 167 251 252 253 254
NORSAT	103
OAK	005 013 058 168 169 170 255 256
OPTIMUS	130 257 258 259 260
ORB	120
PACE	048 052 086 261 262
PANASONIC	009 010 040 062 063 076 171 172 173 174 175 176
PANSAT	121
PHILIPS	034 047 070 084 130 177 178 179 180 181 182 183 184
PHONOTREND	035
PICO	122
PIONEER	003 057 185 186 263 264 265

PRIMESTAR	025
PROSCAN	131
QUICK ORAW	123 266 267 268 269
RADIO SHACK	114 124
RAMSEY	122
RCA	009 010 021 062 063 094 131 270
REALISTIC	129
REGAL	008 012 015 061
RFT	035
RURAL CABLE	124
SAGEM	046
SAMSUNG	003 016 027 057 125
SATLANTA	001 006
SELECTOR	090
SIERRA	133
SIGMA	005 013 058
SKY	028 064
SKYMASTER	035 071
SL MARX	016
SONY	022
STAR SIGHT	131
STAR TRAK	120
STRONG	126
STS	116
SUPER GUIDE	127
TAIHAN	019
TCE	131
TEECOM	128
THOMSON	019
TOSHIBA	104 119
TPS	046 083
TRIAx	051 054 091
UNIDEN	114 115 129 130
VIDEO CIPHER II	113
VIDEOWAY	060
ZENITH	007 060 104 112 113

# Setting the Universal Remote Control Unit

## VCR codes

ADMIRAL	024
ADVENT	138 139
ADVENTURE	138139
AIKO	138
AIWA	111 114 136 025 031 051 085 096 138 139 140 141 184
AKAI	003 026 029 030 089 090 098 099 101 108 132 137 139 142 175 177 185 186 187 188
ALLEGRO	188
ALOSTAY	113 157 158 159 160 161
AMERICAN HIGH	173 174
ANITECH	118 131 148 149 150 151
ASHA	041
AUDIO DYNAMICS	074
AUDIOVOX	032
AUSTAR	117 143 144 145 146 147
AUTOVOX	119 152 153 154 155 156
BAIRD	102 162 163 164 165 166
BEAUMAİK	041
BELL&HOWELL	035
BIOKSONIC	056
BROKSONIC	140 141 144
BSR	108 128 133 134 167 168 169 170
CALIX	032
CANDLE	032 037 041 074 160 164 189
CANON	165 172 173 174
CAPEHART	161
CARVER	180
CCE	145 166
CITIZEN	032 037 041 074 160 164 166 189
COLORTYME	074
COLT	145
CRAIG	032 041 145 147
CURTIS-MATHES	041 074 139 146 174 171 172 189
CYBERNEX	041
DAEWOO	037 042 043 069 138 141 160 161 164 166 171 172 173 174 175 176 177 178 179
DAYTRON	161 162
DBX	014 074
DIMENSIA	171
DUAL-TEC	120 180 181 182 183 184

DYNATECH	138 139
ELBE	100 185 186 187 188 189
ELECTROHOME	032 177
ELECTROPHONIC	032
EMERSON	032 037 056 138 139 140 141 156 158 162 173 174 176 177 184 186 191
FERGUSON	104 190 191 192 193 194
FISHER	035 074 095 103 142 147 154 180 195 196 197 198
FUJI	003 173 174
FUNAI	138 139
GARRARD	138
GE	152 171 172 173 174
GOLDSTAR	032 074
GO-VIDEO	039 148
GRADIENTE	138
GRANDA	094 110 199 200 201 202
GRUNDIG	055 070 071 091 092 093
HARMAN	074 138
HARWOOD	145
HEADQUARTER	035
HINARI	097 130 206 207 208 209
HI-Q	147
HITACHI	027 033 034 139 149 150 175 204 205
INNOHT	105 210 211 212 213 214
INSTANT REPLAY	139 173 174
INTEQ	032
IRRADIO	082 215 216 217 218 219
JC PENNEY	014 032 035 041 074 149 150 172 174 175
JCL	173 174
JENSEN	149 175
JVC	014 015 022 044 048 049 052 053 054 074 077 078 079 080 115 116 175 188
KATHREIN	036 037 072 073 220 221
KENWOOD	014 074 175 189
KLH	145 151
KODAK	032 173 174
LG	038 222 223 224 225 226
LG-GOLDSTAR	032 106 107 231 232 233
LLOYD	138 139
LOEWE	020 127 227 228 229 230
LOGIK	145
LXI	032
MAGNAVOX	172 173 174 180

# Setting the Universal Remote Control Unit

## VCR codes

MAGNIN	041
MARANTZ	014 035 074 121 144 174 180 189 242 243 244 245 246
MARDS	173
MARTA	032
MASUSHITA	173 174
MATSUI	056 057 234 235 236 237
MEI	173 174
MEMGREX	024 032 035 041 138 139 147 173 174 185
MGA	176 177
MGN TECHNOLOGY	041
MIDLAND	152
MINOLTA	149
mitsubishi	014 046 047 063 149 176 177 183 191 238 239 240
MOTOROLA	024173 174
MTC	041 138 139
MULTITECH	041 138 139 142 152
NEC	014 035 074 075 144 146 175 189 248 249 250 251
NIKKO	032
NOBLEX	041
NORDMENDE	083 252 253 254 255
OLYMPUS	173 174
OPTIMUS	021 024 032 153
OPTONICA	039 157
ORION	028 056 084 112 135
PANASONIC	021 023 060 061 062 172 173 174
PENTAX	149 150 189
PENTEX RESEARCH	074
PHILCO	172 173 174
PHILIPS	011 012 013 016 017 018 058 059 173 174 180
PILOT	032
PIONEER	014 086 149 163
PORTLAND	160 161 164 189
PROTEC	145
QUARTER	035
QUARTZ	035
QUASAR	172 173 174
RADIO SHACK	021 024 032 035 041 138 139 142 147 153 154 171 172 173 174 177 185
RADIX	032
RANDEX	032
RCA	143 149 150 167 168 169 170 171 172 173 174 181 187
RICOH	002
RRADIO	109
SAMSUNG	039 037 040 041 045 057 149 152 155 185 256 257 258
SANSUI	175 181
SANYO	035 036 041 067 068 134 147 259 260 261
SCOTT	141 156 176 191
SEARS	032 035 142 147 149 150 154 173 174
SHARP	024 064 139 164 262 263 264 265 266
SHINTOM	002 003 145 149 190
SHOGUN	041
SIGNATURE	139
SINGER	145 173 174
SINUDYNE	087 088
SONY	001 002 003 004 005 006 007 008 009 010 178 179 267 268 269 270
STS	173 174
SYLVANIA	138 139 176
SYMPHONIC	139
TANDY	035 139
TASHIKO	032
TATUNG	175
TEAC	138 139 175 181
TECHNICS	021 173
TEKNIKA	032 138 174
THOMSON	019 050 066 072 073 076 123 124 125 126
THORN	104 122
TMK	041 146 158
TOSHIBA	037 050 065 081 154 271 272 273 274
TOTEVSION	032 041
UNITECH	041
VECTOR RESEARCH	014 037 074 189
VICTOR	014
VIDEO CONCEPTS	037 074 177 189
VIDEOSONIC	014 041
WARDS	024 032 037 041 138 139 145 147 149 150 174 177
WHITE WEST	139
XR-1000	138 145 173 174
YAMAHA	014 035 074 175
ZENITH	002 003 014 039 159 188



# Troubleshooting Guide

Check the following before requesting service.

SYMPTOM	POSSIBLE CAUSE	POSSIBLE SOLUTION
<b>Power</b>		
No power	The AC power cord is not connected.	Connect the AC power cord to the AC outlet
<b>TV broadcast reception</b>		
Poor or no picture.	TV station experiencing problems.	Try another channel.
	Picture control is not adjusted.	Check picture control adjustments.
	Possible local interference.	Check for source of reception disturbance
	Antenna/Cable connector is not connected.	Check Cable connection or VHF/UHF ant.
Picture wobbles or drifts.	TV station experiencing problems.	Try another channel.
	Cable TV channel is scrambled.	A Cable box needs to be used (if desired).
	Possible local interference.	Check for source of reception disturbance
No Cable reception.	Cable connected or not connected.	Check all Cable connections.
	TV/Cable set to TV.	Set TV/Cable to Cable
	Cable TV service interrupted.	Contact your Cable TV company.
No reception above CH13.	TV/Cable set to TV.	Set TV/Cable to Cable.
Poor or no sound.	TV station experiencing problems.	Try another channel.
	MUTE button is pressed.	Press MUTE button again.
	Possible local interference.	Check for source of reception disturbance.
	Antenna/Cable connector is not connected.	Check Cable connection or VHF/UHF ant.
	Volume is set to minimum.	Increase volume.
TV Shuts off.	Sleep Timer is set.	Set Sleep Timer to "Off".
	Off Timer is set.	Clear Off Timer.
Closed Captioning not working.	TV Signal is weak.	Check Cable or VHF/UHF antenna.
	TV station experiencing problems or program tuned is not closed captioned.	Try another channel.
<b>Remote Control</b>		
Remote control does not operate.	The remote control is not aimed at the sensor.	Aim the remote control at the Remote sensor.
	Distance is too far or too much light in the room.	Operate within 23 feet or reduce the light in the room.
	There is an obstacle in the path of the beam.	Clear the path of the beam.
	The batteries are weak.	Replace the batteries.
	The batteries are not inserted correctly.	Insert correctly.
<b>V-CHIP</b>		
Parental Control not Working properly.	Block item is set to "Off".	Set the block item "On".
	News or sports event being broadcast.	Parental Control does not work with News or sporting events.
	Ratings not set.	Set ratings as desired.

## Troubleshooting Guide

SYMPTOM	POSSIBLE SOLUTIONS
<b>DVD</b>	
Playback does not start	<ul style="list-style-type: none"> <li>• No disc is inserted.</li> <li>• The disc may be dirty. Clean up the disc.</li> <li>• The disc is badly distorted.</li> </ul>
No picture	<ul style="list-style-type: none"> <li>• TV/DVD selector is not set correctly.</li> </ul>
No sound	<ul style="list-style-type: none"> <li>• Check the input selector of the amplifier is set properly.</li> <li>• The unit is in the Special playback mode.</li> <li>• Select the correct Audio Output position on AV amplifier.</li> </ul>
Picture is distorted during REVIEW.	<ul style="list-style-type: none"> <li>• The picture will be distorted occasionally.</li> </ul>
Stopping playback, search, slow-motion play or repeat play, etc. cannot be performed.	<ul style="list-style-type: none"> <li>• Some discs may not do some of the functions.</li> </ul>
No 4:3 (16:9) picture	<ul style="list-style-type: none"> <li>• The setup does not match your TV.</li> </ul>
No on-screen display	<ul style="list-style-type: none"> <li>• Turn on on-screen display.</li> </ul>
no surround sound	<ul style="list-style-type: none"> <li>• The setup does not match your stereo system.</li> </ul>
The unit or remote operation key is not functioning.	<ul style="list-style-type: none"> <li>• Turn off the unit and unplug the AC power cord for several minutes, then replug it.</li> </ul>
Playback does not start when the title is selected.	<ul style="list-style-type: none"> <li>• Check the "parental Lock Level" setup.</li> </ul>
Audio soundtrack and/or subtitle language is not changed when you playback a DVD.	<ul style="list-style-type: none"> <li>• Multilingual language is not recorded on the DVD disc.</li> </ul>
No subtitle	<ul style="list-style-type: none"> <li>• Some discs have no subtitles.</li> <li>• Subtitles are cleared. Press SUBTITLE.</li> </ul>
Angle cannot be changed.	<ul style="list-style-type: none"> <li>• Multi-angles are not recorded on the DVD disc.</li> </ul>
⊘ appears on the screen	<ul style="list-style-type: none"> <li>• The function is prohibited with the unit or the disc.</li> </ul>

## Reception Disturbances

Most types of television interference can be remedied by adjusting the height and position of the VHF/UHF antenna. Outdoor antennas are recommended for best results if not using cable or a satellite. The most common types of television interference are shown below. If one of these symptoms appear when the TV is connected to a Cable TV system, the disturbance may be caused by the local cable company broadcast.

### IGNITION:

Black spots or horizontal streaks may appear, picture may flutter or drift. Usually caused by interference from automobile ignition systems, neon lamps, electric drills and other electric appliances.



### GHOSTS:

Ghosts are caused by the television signal following two paths. One is the direct path and the other is reflected from tall buildings, hills or other objects. Changing the direction or position of the antenna may improve the reception.



### SNOW:

If your receiver is located in the fringe area of a television station where the signal is weak, your picture may be marred by the appearance of small dots. When the signal is extremely weak, it may be necessary to install an external antenna to improve the picture.



### RADIO FREQUENCY INTERFERENCE:

This interference produces moving ripples or diagonal streaks, and in some cases, causes loss of contrast in the picture.



### PICTURE SIZE VARIATION:

A slight picture size variation is quite normal when you adjust the CONTRAST or BRIGHTNESS setting.

## CARE AND MAINTENANCE

To prevent fire or shock hazard, disconnect your unit from the AC power source when cleaning. The finish on the receiver may be cleaned with a dust cloth and cared for as other furniture. Use caution when cleaning and wiping the plastic parts. Mild soap and a soft, damp cloth may be used.

## Specifications

GENERAL	DV2018	DV2418
Power Supply:	AC 120V, 60Hz	AC 120V, 60Hz
Power Consumption:	120W	150W
Dimensions:	23.2(W)×19.5(H)×18.5(D) inch	26.9(W)×21.9(H)×18.9(D) inch
Weight(kg/lb):	27 kg/60 lb	40 kg/88 lb
CRT:	20" SCREEN	24" SCREEN
Audio Output:	2.5W×2	3W×2
TELEVISION		
Color System:	TV: NTSC-M AV: NTSC 3.58/4.43, PAL 4.43	
Receiving channel:	VHF            2-13 UHF            14-69 Cable        2-69, (A-6)-(A-1), A-W, (W+1)-(W+28) Total        181 channels	
Antenna Impedance:	VHF/UHF 75 ohm	
DVD/VCD/CD player		
Video out:	CVBS	
Audio out:	2 channels	
Digital out:	Coaxial	
Disc diameter:	120mm, 80mm	
Pickup:	1-Lens 2-Beams System	
<b>Accessories:</b>	Remote controller×1	

⚠ Design and specifications are subject to change without notice.