

# GENERAL MANUAL FOR DeVilbiss/Ex-Cell Pressure Washers

---

SAFETY

## Pressure Washer Service Policy

- Congratulations! You have purchased a high quality product from America's leading manufacturer of pressure washers. This pressure washer, when properly used and maintained, will provide trouble free service. Please read and follow these instructions for proper use and maintenance.
- All sales of pressure washers are final. Do not return this product to the retailer.
- If you experience any problems and need assistance, please call us at our toll free number 1-800-888-2468, Ext 2. Monday through Saturday, 8:00 a.m. To 8:00 p.m. E.S.T.
- If repair or service part purchase is required, our many Authorized Warranty Service Centers are conveniently located and equipped to handle all in-warranty and out-of-warranty service.
- To locate an Authorized Warranty Service Center near you, call

**1-800-888-2468, Ext. 2**  
**24 hours a day, 7 days a week**

- All pressure washers carry a manufacturer's one year warranty from date of purchase for consumer use and a 90 day warranty for commercial use.
- Retain sales receipt as proof of purchase for warranty service.

ASSEMBLY

OPERATION

MAINTENANCE

TROUBLESHOOTING



# INDEX

<b>FREQUENTLY ASKED QUESTIONS</b> .....	3
<b>SAFETY GUIDELINES</b> .....	4
<b>WARNING CHART</b> .....	4-6
<b>OWNER'S RESPONSIBILITIES</b> .....	6
<b>GLOSSARY</b> .....	6
<b>BOX CONTENTS</b> .....	7
<b>ASSEMBLY</b> .....	7-9
<b>OPERATING PROCEDURES</b> .....	9-15
Start Up .....	9-10
Pre-Start Checklist .....	10
High Pressure Operation .....	11-12
Low Pressure Operation .....	13
Pressure Adjustment .....	14
Chemical Flow Adjustment.....	15
Thermal Relief Valve .....	15
Shut-off Procedure .....	15
<b>MAINTENANCE</b> .....	16-18
Checking and Changing Oil.....	16-17
Nozzle Cleaning .....	18
Water Inlet Screen Cleaning.....	19
<b>STORAGE/WINTER STORAGE</b> .....	20
<b>TROUBLESHOOTING GUIDE</b> .....	21-22
<b>WARRANTY STATEMENT</b> .....	23
<b>QUICK FACTS</b> .....	Back Cover

## SAFETY GUIDELINES - DEFINITIONS

This manual contains information that is important for you to know and understand. This information relates to protecting **YOUR SAFETY** and **PREVENTING EQUIPMENT PROBLEMS**. To help you recognize this information, we use the symbols below. Please read the manual and pay attention to these sections.

<p style="text-align: center;"><b>⚠ DANGER</b></p> <p><b>DANGER</b> indicates an imminently hazardous situation which, if not avoided, <b>will</b> result in <b>death or serious injury</b>.</p>	<p style="text-align: center;"><b>⚠ CAUTION</b></p> <p><b>CAUTION</b> indicates a potentially hazardous situation which, if not avoided, <b>may</b> result in <b>minor or moderate injury</b>.</p>
<p style="text-align: center;"><b>⚠ WARNING</b></p> <p><b>WARNING</b> indicates a potentially hazardous situation which, if not avoided, <b>could</b> result in <b>death or serious injury</b>.</p>	<p style="text-align: center;"><b>CAUTION</b></p> <p><b>CAUTION</b> used without the safety alert symbol indicates a potentially hazardous situation which, if not avoided, <b>may</b> result in <b>property damage</b>.</p> <p style="text-align: right; font-size: small;">10/2/97</p>

## Frequently Asked Questions:

### ***What kind of oil do I use?***

- Engine: Refer to Engine manual for oil recommendations.
- Pump: See page 16 and 17.

### ***My Pressure Washer won't start..(See Engine manual for starting instructions)***

- Has gasoline been added to the engine?
- Is engine on/off switch in "on" position? (If applicable)
- Has engine been primed or choked?
- Adequate amount of oil in engine? (Some models are equipped with a "Low Oil Shut Down" switch)
- Is fuel valve in the "Open" position. (if applicable)
- Pull trigger on spray gun to release pressure.

### ***How do I apply chemicals?***

- Wand/Lance must be in the low pressure setting. See page 13.
- Chemical hose must be attached to pump and fully submerged in chemical/soap-See page 8 and 13.
- Chemical adjustment knob must be in open position. See page 15.

### ***How do I adjust the pressure?***

- The pressure unloader is factory pre-set at the maximum pressure and should not be increased. The pressure can be lowered by following the instructions on page 14. **Do not** attempt to increase the engine speed to achieve a higher pressure. Excessive pressure will damage the pump.

### ***I don't have enough pressure...***

- Do you have an adequate water supply(5 gallons per minute at 20 p.s.i.)?
- All hoses free of kinks and leaks?
- Is wand in high pressure setting? See page 11 & 12.
- Is spray nozzle blocked or partially obstructed? If so, clear and replace. See page 18.
- Is the high pressure hose longer than 100 feet?
- Has unit ran for a long period of time without pulling the spray gun trigger?

### ***What type of chemicals/soaps can I use?***

- Use only chemicals/soap designed for use in pressure washers.
- Do not use chlorine bleach or any other corrosive compound; this will cause damage to the pump.

### ***Who can I call if I have questions or any problems?***

- Call us at 1-800-888-2468, Extension 2, Monday through Saturday, 8:00 a.m. to 8:00 p.m., E.S.T.

### ***How do I drain the oil?***

- Engine: Refer to the Engine manual for this information.
- Pump: See page 16 and 17.



### ***Where can I purchase parts and/or accessories?***

- Service parts can only be obtained through our many Authorized Warranty Service Centers. For a location nearest you, call us at 1-800-888-2468, Extension 2.
- Accessories can be purchased at an Authorized Warranty Service Center or at one of the many local retailers.





# IMPORTANT SAFETY INSTRUCTIONS

## ⚠ WARNING

**IMPROPER OPERATION OR MAINTENANCE OF THIS PRODUCT COULD RESULT IN SERIOUS INJURY AND PROPERTY DAMAGE. READ AND UNDERSTAND ALL WARNINGS AND OPERATING INSTRUCTIONS BEFORE USING.**

HAZARD	WHAT CAN HAPPEN	HOW TO PREVENT IT
<p style="text-align: center;"><b>⚠ DANGER</b> <b>RISK OF EXPLOSION OR FIRE</b></p> 	<ul style="list-style-type: none"> <li>• Spilled gasoline and its vapors can become ignited from cigarette sparks, electrical arcing, exhaust gases, and hot engine components such as the muffler.</li> <li>• Heat will expand fuel in the tank which could result in spillage and possible fire explosion.</li> <li>• Operating the pressure washer in an explosive environment could result in a fire.</li> <li>• Materials placed against or near the pressure washer can interfere with its proper ventilation features causing overheating and possible ignition of the materials.</li> <li>• Muffler exhaust heat can damage painted surfaces, melt any material sensitive to heat (such as siding, plastic, rubber, or vinyl), and damage live plants.</li> <li>• Improperly stored fuel could lead to accidental ignition. Fuel improperly secured could get into the hands of children or other unqualified persons.</li> <li>• Use of acids, toxic or corrosive chemicals, poisons, insecticides, or any kind of flammable solvent with this product could result in serious injury or death.</li> </ul>	<ul style="list-style-type: none"> <li>• Shut off engine and allow it to cool before adding fuel to the tank.</li> <li>• Use care in filling tank to avoid spilling fuel. Move pressure washer away from fueling area before starting engine.</li> <li>• Keep maximum fuel level ½" below top of tank to allow for expansion.</li> <li>• Operate and fuel equipment in well ventilated areas free from obstructions. Equip areas with fire extinguishers suitable for gasoline fires.</li> <li>• Never operate pressure washer in an area containing dry brush or weeds.</li> <li>• Always keep pressure washer a minimum of four feet away from surfaces (such as houses, automobiles, or live plants) that could be damaged from muffler exhaust heat.</li> <li>• Store fuel in an OSHA approved container, in a secure location away from work area.</li> <li>• Do not spray flammable liquids</li> </ul>
<p style="text-align: center;"><b>⚠ DANGER</b> <b>RISK TO BREATHING</b></p> 	<ul style="list-style-type: none"> <li>• Breathing exhaust fumes will cause serious injury or death.</li> <li>• Some cleaning fluids contain substances which could cause injury to skin, eyes, or lungs.</li> </ul>	<ul style="list-style-type: none"> <li>• Operate pressure washer in a well ventilated area. Avoid enclosed areas such as garages, basements, etc.</li> <li>• Never operate unit in a location occupied by humans or animals.</li> <li>• Use only cleaning fluids specifically recommended for high pressure washers. Follow manufacturers recommendations. Do not use chlorine bleach or any other corrosive compound</li> </ul>
<p style="text-align: center;"><b>⚠ WARNING</b> <b>RISK OF UNSAFE OPERATION</b></p> 	<ul style="list-style-type: none"> <li>• Unsafe operation of your pressure washer could lead to serious injury or death to you or others.</li> <li>• <b>If proper starting procedure is not followed, engine can kickback causing serious hand and arm injury.</b></li> <li>• The spray gun/wand is a powerful cleaning tool that could look like a toy to a child.</li> <li>• Reactive force of spray will cause gun/wand to move, and could cause the operator to slip or fall, or misdirect the spray. Improper control of gun/wand can result in injuries to self and others.</li> </ul>	<ul style="list-style-type: none"> <li>• Become familiar with the operation and controls of the pressure washer.</li> <li>• Keep operating area clear of all persons, pets, and obstacles.</li> <li>• Do not operate the product when fatigued or under the influence of alcohol or drugs. Stay alert at all times.</li> <li>• Never defeat the safety features of this product.</li> <li>• Do not operate machine with missing, broken, or unauthorized parts.</li> <li>• Never leave wand unattended while unit is running.</li> <li>• <b>If engine does not start after two pulls, squeeze trigger of gun to relieve pump pressure. Pull starter cord slowly until resistance is felt. Then pull cord rapidly to avoid kickback and prevent hand or arm injury.</b></li> <li>• Keep children away from the pressure washer at all times.</li> <li>• Do not overreach or stand on an unstable support. Grip gun/wand firmly with both hands. Expect the gun to kick when triggered.</li> </ul>

# IMPORTANT SAFETY INSTRUCTIONS

HAZARD	WHAT CAN HAPPEN	HOW TO PREVENT IT
<p style="text-align: center;"><b>⚠ WARNING</b></p> <p style="text-align: center;"><b>RISK OF ELECTRICAL SHOCK</b></p> 	<ul style="list-style-type: none"> <li>Spray directed at electrical outlets or switches, or objects connected to an electrical circuit, could result in a fatal electrical shock.</li> </ul>	<ul style="list-style-type: none"> <li>Unplug any electrically operated product before attempting to clean it. Direct spray away from electric outlets and switches.</li> </ul>
<p style="text-align: center;"><b>⚠ WARNING</b></p> <p style="text-align: center;"><b>RISK TO FLUID INJECTION</b></p> 	<ul style="list-style-type: none"> <li>Your washer operates at fluid pressures and velocities high enough to penetrate human and animal flesh, which could result in amputation or other serious injury. Leaks caused by loose fittings or worn or damaged hoses can result in injection injuries. <b>DO NOT TREAT FLUID INJECTION AS A SIMPLE CUT!</b> See a physician immediately!</li> <li>Relieve system pressure before attempting maintenance or disassembly of equipment.</li> </ul>	<ul style="list-style-type: none"> <li>Never place hands in front of nozzle.</li> <li>Direct spray away from self and others.</li> <li>Make sure hose and fittings are tightened and in good condition. Never hold onto the hose or fittings during operation.</li> <li>Do not allow hose to contact muffler.</li> <li>Never attach or remove wand or hose fittings while system is pressurized.</li> <li>Use only hose and high pressure accessories rated for pressure higher than your pressure washer's p.s.i.</li> <li>To relieve system pressure, shut off engine, turn off water supply, and pull gun trigger until water stops flowing.</li> </ul>
<p style="text-align: center;"><b>⚠ WARNING</b></p> <p style="text-align: center;"><b>RISK OF CHEMICAL BURN</b></p> 	<ul style="list-style-type: none"> <li>Use of acids, toxic or corrosive chemicals, poisons, insecticides, or any kind of flammable solvent with this product could result in serious injury or death.</li> </ul>	<ul style="list-style-type: none"> <li>Do not use acids, gasoline, kerosene, or any other flammable materials in this product. Use only household detergents, cleaners and degreasers recommended for use in pressure washers.</li> <li>Wear protective clothing to protect eyes and skin from contact with sprayed materials.</li> <li>Do not use chlorine bleach or any other corrosive compound</li> </ul>
<p style="text-align: center;"><b>⚠ WARNING</b></p> <p style="text-align: center;"><b>RISK OF HOT SURFACES</b></p> 	<ul style="list-style-type: none"> <li>Contact with hot surfaces, such as engines exhaust components, could result in serious burn.</li> </ul>	<ul style="list-style-type: none"> <li>During operation, touch only the control surfaces of the pressure washer. Keep children away from the pressure washer at all times. They may not be able to recognize the hazards of this product.</li> </ul>
<p style="text-align: center;"><b>⚠ DANGER</b></p> <p style="text-align: center;"><b>RISK OF INJURY AND PROPERTY DAMAGE WHEN TRANSPORTING OR STORING</b></p> 	<ul style="list-style-type: none"> <li>Fuel or oil can leak or spill and could result in fire or breathing hazard, serious injury or death can result. Fuel or oil leaks will damage carpet, paint or other surfaces in vehicles or trailers.</li> </ul>	<ul style="list-style-type: none"> <li>If pressure washer is equipped with a fuel shut-off valve, turn the valve to the off position before transporting to avoid fuel leaks. If pressure washer is not equipped with a fuel shut-off valve, drain the fuel from tank before transporting. Only transport fuel in an OSHA approved container. Always place pressure washer on a protective mat when transporting to protect against damage to vehicle from leaks. Remove pressure washer from vehicle immediately upon arrival at your destination.</li> </ul>

**⚠ CAUTION**

The powerful spray from your pressure washer is capable of causing damage to surfaces such as wood, glass, automobile paint, auto striping and trim, and delicate objects such as flowers and shrubs. Before spraying, check the item to be cleaned to assure yourself that it is strong enough to resist damage from the force of the spray. Avoid the use of the concentrated spray stream except for very strong surfaces like concrete and steel.

Operating unit with water supply shutoff without flow of water will result in equipment damage. Operating the pressure washer with water supply shutoff will void your warranty. You should never run this pressure washer for more than 2 minutes without pulling the trigger to allow cool water to enter the pump and the heated (recirculated) water to exit.



Read Owner's Manual. Do not operate equipment until you have read Owner's Manual for **Safety, Operation, and Maintenance Instructions.**

This product is not equipped with a spark arresting muffler. If the product will be used around flammable materials, or on land covered with materials such as agricultural crops, forest, brush, grass, or other similar items, then an approved spark arrester must be installed and is legally required in the state of California. It is a violation of California statutes section 130050 and/or sections 4442 and 4443 of the California Public Resources Code, unless the engine is equipped with a spark arrester, as defined in section 4442, and maintained in effective working order. Spark arresters are also required on some U.S. Forest Service land and may also be legally required under other statutes and ordinances.

Engine exhaust contains chemicals known, in certain quantities, to cause cancer, birth defects or other reproductive harm.

## OWNER'S RESPONSIBILITIES

- **DO NOT RETURN THIS PRODUCT TO THE RETAILER!**
- Read and understand all safety warnings.
- **Read this Owner's Manual.**
- Do not operate this unit until you have read this Owners Manual for Safety, Operation, and Maintenance Instructions.
- **Read the Engine Owner's Manual supplied with this unit.**
- Do not operate this unit until you have read the Engine Owners Manual for Safety, Operation, and Maintenance Instructions.
- Check for visible shipping damage. Shipping damage will cause problems in operation of this unit.
- If you experience any problems and need assistance, please call us at our toll free number **1-800-888-2468, Ext 2**, 8:00 a.m. to 8:00 p.m. E.S.T.
- If you need warranty repair or service part purchase, you can locate an Authorized Warranty Service Center nearest you by calling us at **1-800-888-2468, Ext 2**, 24 hours a day, 7 days a week.

## GLOSSARY

**PSI:** Pounds per square inch is a unit of measure for pressure.

**GPM:** Gallons Per Minute (Flow Rate)

**Cleaning Units:** GPM x PSI

**Vertical:** A vertical pressure washer has the pump located underneath the engine.

**Horizontal:** A horizontal pressure washer has the pump located behind the engine.

**Multi-Reg wand/lance:** This type of wand/lance is black and has a spray nozzle which is adjustable from a pencil stream (0°) to a wide angle fan spray (60°). The spray can be adjusted by twisting the nozzle clockwise and/or counterclockwise. Also, the high and low pressure settings can be controlled by moving the nozzle in and out. See page 11.

**Hi-Low:** This type of lance has one chrome tube with a black knob on the nozzle end. The knob can be turned clockwise and counterclockwise to control the high and low pressure settings. It comes with a ¼" NPT, 15° nozzle. To obtain different spray patterns, the nozzle must be removed and replaced with one of the desired degree. The available patterns are 0°, 25°, and 40°. When replacing nozzles, be sure to use one of the same flow rating. Be sure to apply teflon tape to nozzle threads to prevent leaks. See page 11.

**Dual Lance:** This type of lance has two chrome tubes with a handle grip near the gun/lance connection and two nozzles on the end. The handle grip can be turned clockwise and counter clockwise to control the high and low pressure settings. It also comes with a ¼" NPT, 15° high pressure nozzle. To obtain different spray patterns, the nozzle must be removed and replace with one of the desired degree. The available patterns are 0°, 25°, and 40°. NOTE: Be sure not to remove the chemical nozzle. It is the nozzle with the larger hole in it. When replacing nozzles, be sure to use one of the same flow rating. Be sure to apply teflon tape to nozzle threads to prevent leaks. See page 11.

**Quick Connect:** This type of lance is equipped with a female quick connect coupler on the end. This allows the user to quickly change out high-pressure nozzles for different spray patterns and change to the soap nozzle for low pressure and chemical/soap applications. See page 12.

**By Pass Mode:** During normal operation, a continuous flow of cold water is needed to keep the pressure washer pump operating at a safe temperature. If the pressure washer is operated without an adequate water supply, or operated for more than two (2) minutes without pulling the trigger, the pump will overheat and cause serious damage. Any damage to the pump due to these causes **will not** be covered under warranty.

# BOX CONTENTS

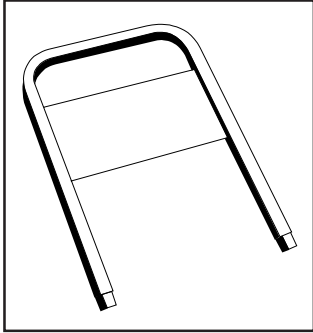

Handle

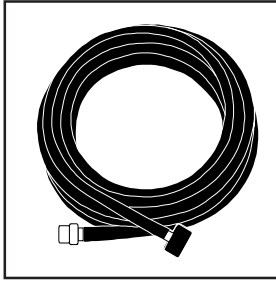

High Pressure Hose

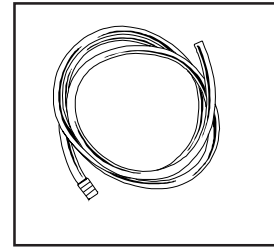

Chemical Hose

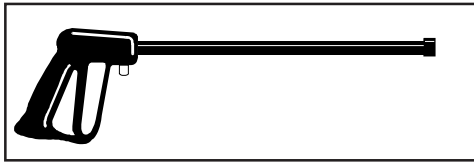

Gun

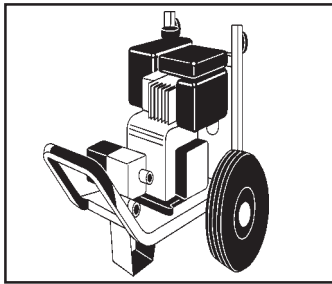

Engine Frame and Wheel Assembly

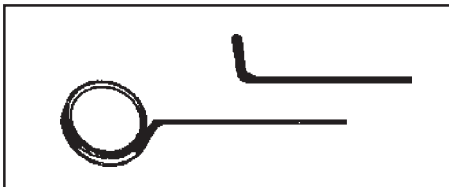

Nozzle Cleaning Kit

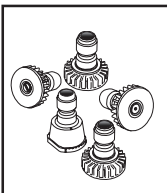

Quick Connect Nozzle - only on units equipped with the quick connect lance

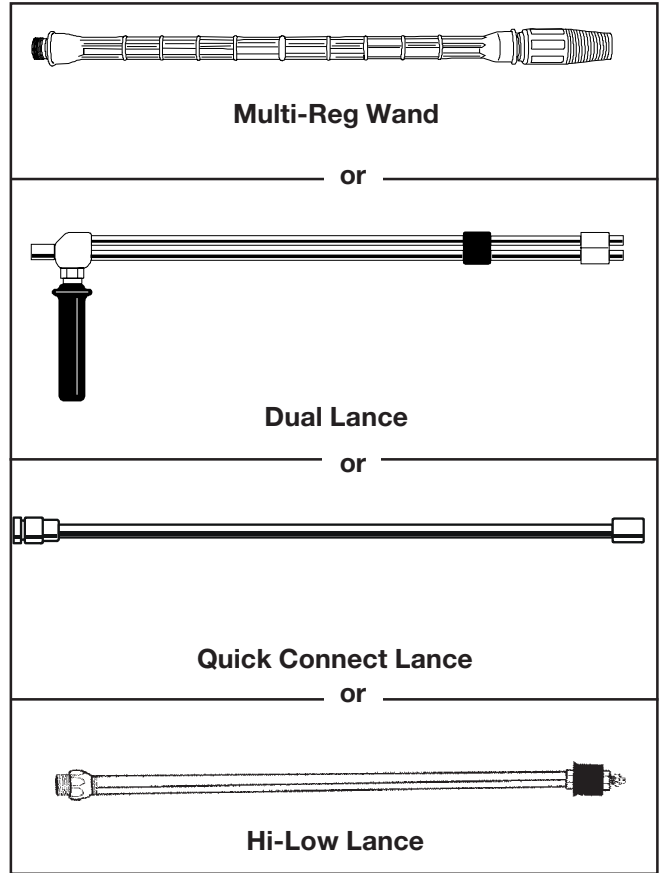

Multi-Reg Wand

or

Dual Lance

or

Quick Connect Lance

or

Hi-Low Lance

Wand/Lance Assemblies

ASSEMBLY

# ASSEMBLY

1. Connect handle to frame.

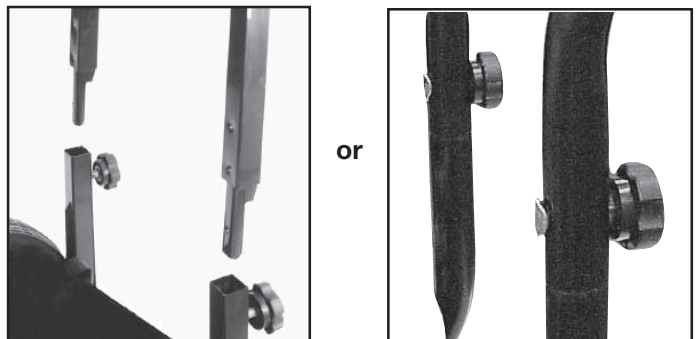

or

Attaching Handle

---

## ASSEMBLY

---

2. Connect wand to gun. Tighten securely.

**Dual Lance**

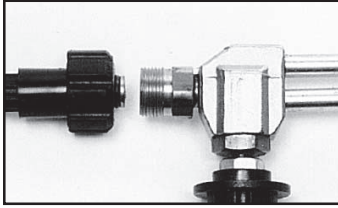

**Multi-Reg**



**Hi-Low/Quick Connect**

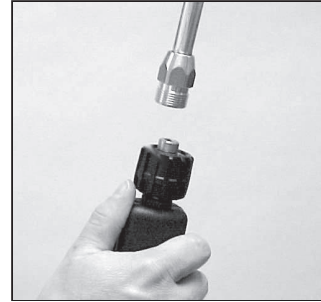

3. Attach high pressure hose to gun. The point of attachment for the high pressure hose will differ depending on the model purchased. Tighten securely.



OR



OR

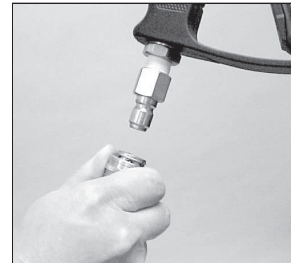

4. Connect chemical hose to the pump by one of the following methods:

- a. Press the chemical hose onto the barb fitting located near the high pressure hose connection-see illustration A.

OR

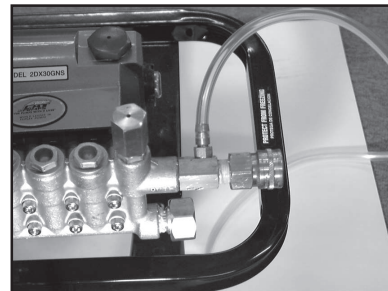

**Illustration A**

- b. Place chemical hose with fitting into chemical injector (black elbow)-see illustration B.

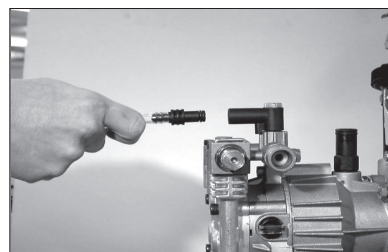

**Illustration B**



**⚠ WARNING**

5.  Some pumps are shipped from the factory with a red shipping plug. Refer to page 16 and 17 to identify your pump. The Annovi Reverberi pump can also be identified by its name printed on top of the pump. The shipping plug prevents any oil from leaking out of the pump in shipping. Attached to the shipping plug is a plastic bag which contains the new oil plug. The shipping plug must be removed and the new oil plug installed before the pressure washer is operated—see illustration C. To remove the shipping plug, turn counterclockwise and discard. Remove the new oil plug from the plastic bag and insert into the pump. Tighten securely.



**Illustration C**

---

## OPERATING PROCEDURES

---

**ATTENTION:** Become familiar with the operating procedures before starting your unit.

### Start-Up

1. Add fresh high quality unleaded gasoline—Figure 1.
2. Check engine oil level. See Engine Operator's Manual for correct amount and type.

**Add Gas**

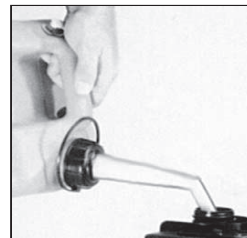
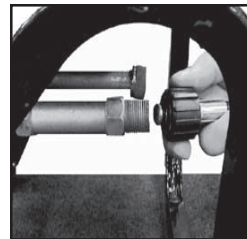

**Figure 1**

**NOTE:** Some engines are equipped with a low oil sensor and the correct amount of oil must be added or the engine will not start.

3. Check pump oil level (if applicable—See Maintenance Section.)

**Twist Connect**



**Figure 2**

**OR**

**Quick Connect**

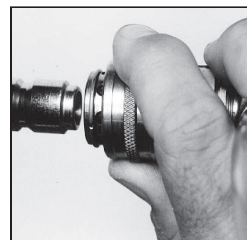

**Figure 3**

**⚠ CAUTION**

**Never pull water supply hose to move pressure washer. This could damage hose and/or pump inlet.**

## OPERATING PROCEDURES (cont'd)

5. Connect water source to pump inlet — Figure 4.

**NOTE: Water source must provide a minimum of 5 gallons per minute at 20 p.s.i.**

6. Turn water source on — Figure 5.

**NOTE: Make sure water supply is turned on.**

### **⚠ CAUTION**

**Never turn water supply off while pressure washer engine is running or damage to pump will result.**

7. Start engine according to the engine owners' manual.

### **⚠ WARNING**

**SOME UNITS ARE NOT EQUIPPED WITH AN E-Z START VALVE. ON THESE UNITS PRESSURE WILL BUILD IN THE HOSE IF THE ENGINE DOES NOT START AFTER TWO PULLS. IF THE ENGINE DOES NOT START AFTER TWO PULLS, PULL THE TRIGGER TO RELIEVE THE PRESSURE. FAILURE TO DO SO MAY CAUSE DAMAGE TO THE RECOIL MECHANISM.**

### **⚠ WARNING**

**NEVER RUN ENGINE INDOORS OR IN ENCLOSED, POORLY VENTILATED AREAS. ENGINE EXHAUST CONTAINS CARBON MONOXIDE, AN ODORLESS AND DEADLY GAS.**

8. Depress trigger on gun to start water flow.  
Release trigger to stop water flow.

### **⚠ WARNING**

**STAND ON A STABLE SURFACE AND GRIP GUN/WAND FIRMLY WITH BOTH HANDS. EXPECT THE GUN TO KICK WHEN TRIGGERED.**

9. Adjust nozzle spray for the task being performed. See **High Pressure Operation** instructions in the **Operating Procedures** section.

### **Connect Water**

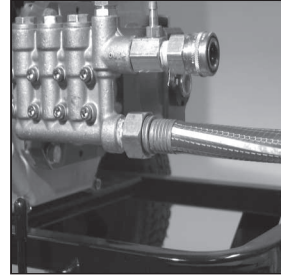

**Figure 4**

### **Turn on Water**

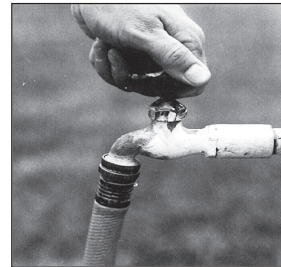

**Figure 5**

## **PRE START CHECKLIST**

Once you reach this point, insure you have completed the following:

- ✓ All safety instructions read and understood?
- ✓ All hose connections are tightened and free of any kinks, damage, or leaks?
- ✓ Adequate amount of oil and gasoline added to pressure washer?
- ✓ Water source (garden hose) turned on?
- ✓ All operation instructions read and understood?

## High Pressure Operation:

### ⚠ CAUTION

DO NOT let hoses come in contact with very hot engine muffler during or immediately after use of your pressure washer.

### ⚠ WARNING

RISK OF INJECTION OR INJURY TO PERSON. DO NOT DIRECT DISCHARGE STREAM TOWARD PERSONS.

### ⚠ DANGER

WHEN USING THE HIGH PRESSURE SETTING, DO NOT ALLOW THE JET-LIKE SPRAY TO COME IN CONTACT WITH UNPROTECTED SKIN, EYES, OR WITH ANY PETS OR ANIMALS. SERIOUS INJURY CAN OCCUR.

**Multi-Reg** — Pull back nozzle for high pressure—Figure 7.

**Hi-Low** — Turn knob clockwise until it stops—Figure 8.

**Dual Lance** — Turn black handle grip clockwise until it stops—Figure 9.

**NOTE:** 0°, 15°, 25°, and 40° nozzles will change the fan spray. The size of the nozzle will determine the size of the fan spray. To change nozzles:

1. Shut off the pressure washer and turn off the water supply.
2. Pull trigger on gun handle to relieve any water pressure.
3. Remove the nozzle on the end of the wand.
4. Insert new nozzle and tighten securely.

**Note:** Be sure to teflon tape nozzle prior to assembly. Maintain at least one thread away from the end when applying the tape. You must wrap teflon tape in the direction of the threads. Two wraps only required.

Multi-Reg (High Pressure Setting)



Figure 7

Hi-Low

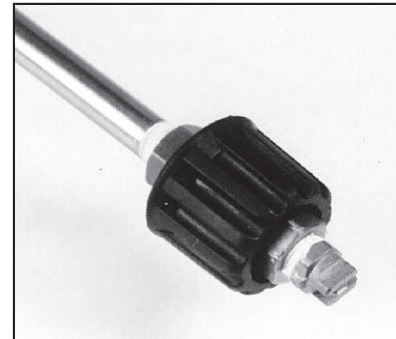

Figure 8

Dual Lance



Figure 9

---

## OPERATING PROCEDURES (cont'd)

---

**Quick Connect** – Use the 0°, 15°, 25°, and 40° nozzles for high pressure-Figure 10. The size of the nozzle will determine the size of the fan spray. To change nozzles:

1. Shut off the pressure washer and turn off the water supply.
2. Pull trigger on gun handle to relieve any water pressure.
3. Pull quick connect coupler back and remove nozzle-Figure 11.
4. Pull quick connect coupler back and insert nozzle.
5. Release quick connect coupler and insure nozzle is secure.

To siphon chemicals/soaps, refer to low pressure operation below. Chemicals/soaps **will not** siphon in high pressure setting.

**NOTE: On the Dual and Quick Connect wands the different degree nozzles will change the fan spray to be used in different applications.**

**0° nozzle** – Used for a pinpoint stream. This nozzle stream is very powerful and covers a very small area of cleaning. This nozzle should only be used on surfaces that can withstand this high pressure such as metal or concrete.

**15° and 25° nozzle** – Used for less powerful stream which can cover a wider area. This nozzle is also very powerful and should only be used on surfaces that can withstand this high pressure.

**40° nozzle** – Used for the least powerful stream and covers a wide area of cleaning. This nozzle should be used for most general cleaning jobs.

**Quick Connect with Nozzles**

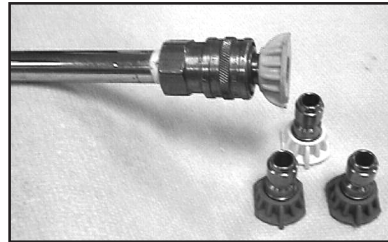

**Figure 10**

**Quick Connect Coupler**

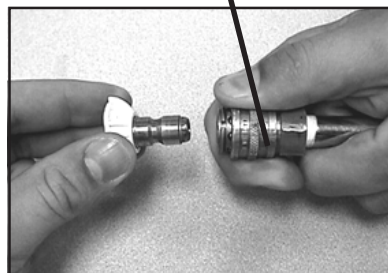

**Figure 11**

**Low Pressure Operation:  
(to siphon chemicals/soaps)**

**NOTE: Use only soaps and chemicals designed for pressure washer use. Do not use bleach.**

1. Connect chemical hose to the pump by one of the following methods:

- a. Press the chemical hose onto the barb fitting located near the high pressure hose connection- see illustration A.

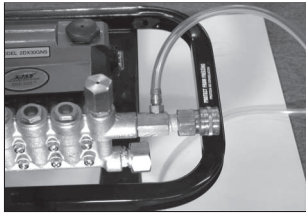

**Illustration A**

- b. Place chemical hose with fitting into chemical injector (black elbow)-see illustration B.

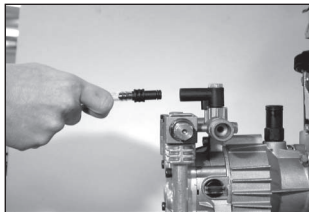

**Illustration B**

2. Place chemical hose filter into desired chemical. Place the wand/lance into low pressure by one of the following methods.

**Multi-Reg** — Push nozzle forward for low pressure— Figure 12.

**Hi-Low** — Turn knob counter clockwise until it stops—Figure 13.

**Dual Lance** — Turn black handle grip counter clockwise until it stops—Figure 14.

**Quick Connect** – Change to the soap nozzle for low pressure. The soap nozzle can be identified as having the larger hole in the nozzle. The soap nozzle is to be used for drawing all chemicals and soaps—Figure 15.

3. After use of chemical, siphon clean water through chemical hose. Chemicals which remain in the pump can damage and/or clog the pressure valves and chemical injector assembly. Damage to the pump due to this will not be covered under warranty.

**Multi-Reg (Low Pressure Setting)**



**Figure 12**

**Hi-Low**

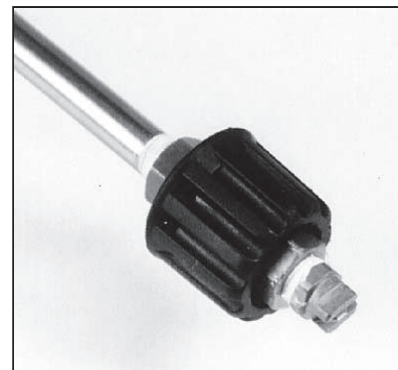

**Figure 13**

**Dual Lance**

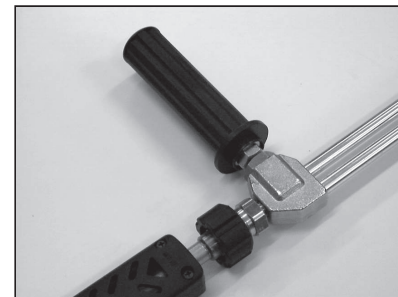

**Figure 14**

**Quick Connect with Soap Nozzle for Low Pressure**

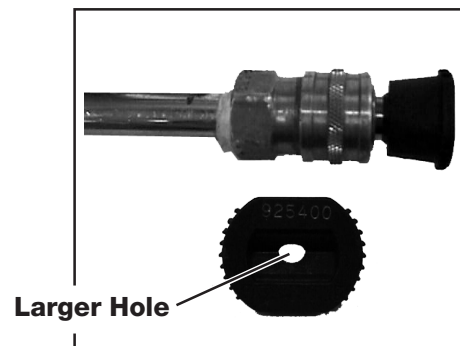

**Figure 15**

## OPERATING PROCEDURES (cont'd)

### Pressure adjustment:

The pressure setting is preset at the factory to achieve optimum pressure and cleaning. If you need to lower the pressure, it can be accomplished by two methods.

The first method is to back away from the surface to be cleaned. The further away you are, the less the pressure will be on the surface to be cleaned.

The second method is to adjust the pressure regulator on the pump. Please read the following instructions for adjusting the pressure regulator:

Refer to page 16 and 17 to identify the pump that is on your pressure washer. The pressure is not adjustable on DAPC, Faip, Karcher, or smaller Giant pumps.

The Annovi Reverberi, Cat, General and larger Giant pumps pressure can be lowered by turning the pressure regulator counterclockwise. Refer to the illustrations to the right to identify your pressure regulator.

Once you have finished using your pressure washer, return the pressure regulator to its original position by turning it clockwise.

### ⚠ CAUTION

**DO NOT attempt to increase pump pressure. A higher pressure setting than the factory set pressure will damage pump.**

Annovi Reverberi

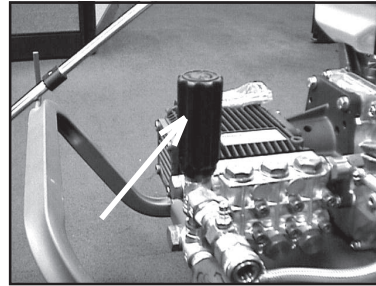

General

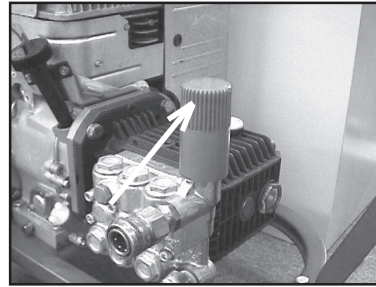

CAT

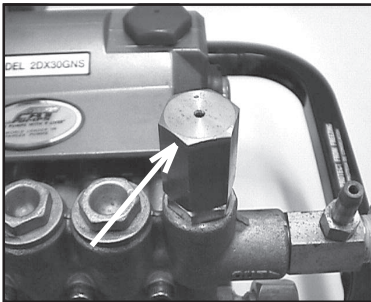

Giant (beltdriven) P316

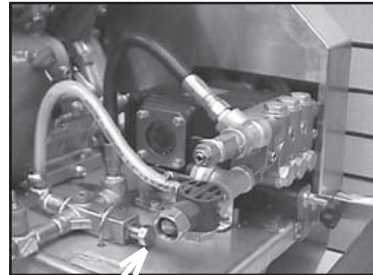

(unloader mounted on frame)

Giant P303

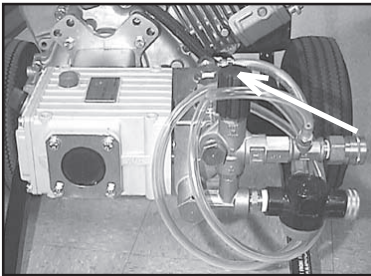

Giant (beltdriven) P316

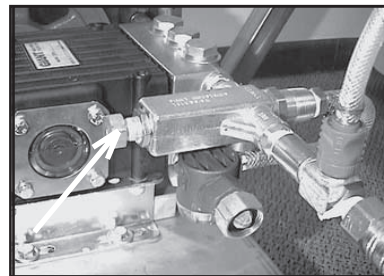

(unloader mounted on pump)

## Chemical Flow Adjustment

Some pumps are equipped with an adjustable chemical injector as shown here. Turn the chemical adjustment knob counterclockwise to increase the amount of chemical used and clockwise to decrease the amount of chemical used. If the knob is turned clockwise until it stops, the chemical injector will close and will not draw any chemicals/soaps.

Chemical Adjustment

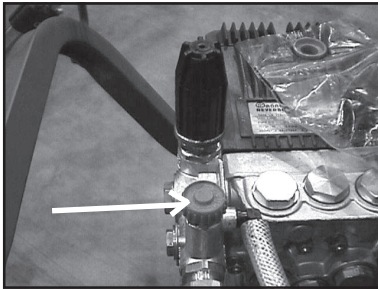

or

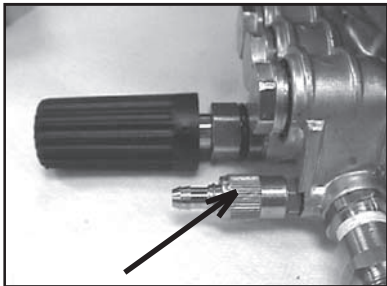

## CAUTION

**DO NOT** allow your unit to operate in bypass mode for more than two minutes at any time. Overheating of pump will cause damage to pump.

Thermal Relief Valve

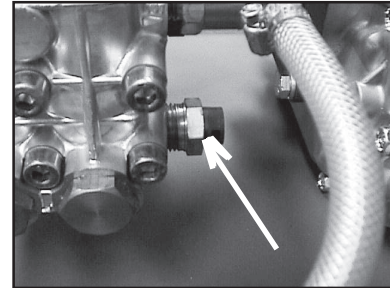

or

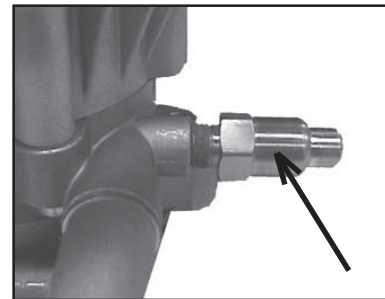

## Thermal Relief Valve:

During normal operation, the water from your cold water supply circulates inside the pressure washer pump allowing the pump to maintain a desired operating temperature. When you stop spraying water through your wand/lance and the engine is still running, this is considered the by-pass mode.

When the unit is in the by-pass mode, the water circulation inside the pump begins to heat up. If the unit is left in the by-pass mode for more than two (2) minutes, the water temperature will rise to a dangerous level and damage the internal components of the pump.

In an effort to prevent damage, pumps are equipped with a thermal relief valve. This valve will open when the temperature rises too high. This valve will then release a gush of water in an effort to lower the temperature inside the pump. Immediately after this occurs, the valve will close.

## Shut Down Procedure:

1. If you have siphoned chemicals, siphon a bucket of clean water through the chemical hose. **NOTE:** Failure to do so will cause damage to the pump.
2. Turn engine off. See Engine Owner's Manual. **NOTE: NEVER turn the water off with the engine running.**
3. Turn water source off.
4. See Storage section in this manual for proper storage procedures.

Turn off Water

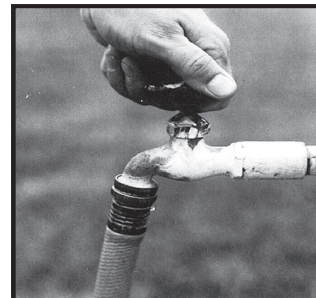

## MAINTENANCE

### ⚠ DANGER

**WHEN DOING MAINTENANCE, YOU MAY BE EXPOSED TO HOT SURFACES, WATER PRESSURE, MOVING PARTS, OR FIRE RESULTING IN DEATH. BEFORE PERFORMING ANY MAINTENANCE OR REPAIR, DISCONNECT SPARK PLUG WIRE, LET ENGINE COOL AND RELEASE ALL WATER PRESSURE. THE ENGINE CONTAINS FLAMMABLE FUEL. DO NOT SMOKE OR WORK NEAR OPEN FLAMES WHILE PERFORMING MAINTENANCE.**

To ensure efficient operation and longer life of your pressure washer, a routine maintenance schedule should be prepared and followed. The following routine maintenance schedule is geared to an unit in a normal working environment. If necessary, the schedule should be modified to suit the conditions under which your pressure washer is used. The modifications will depend upon the hours of operation and the working environment. If the pressure washer is in an extremely dirty and/or hostile environment it will require a greater frequency of all maintenance checks.

1. Consult the Engine Owners Manual for the manufacturer's recommendations for any and all maintenance.
2. Pump oil (checking and changing). Refer to the following illustrations to identify which pump is on your pressure washer. Refer to the chart for oil type, oil capacity, and maintenance schedule (if applicable).

Pump	Oil Type	Oil Capacity	Change Oil		
			First 10 hours	after every 50 hours	* never
Annovi Reverberi (XJV)	10W30 synthetic	5.25 oz			x
Annovi Reverberi (XJW)	10W30 synthetic	5.25 oz			x
Annovi Reverberi (XMV)	30W non detergent	13.5 oz	x	x	
Annovi Reverberi (XRV)	30W non detergent	18.54 oz	x	x	
Annovi Reverberi (XTV)	30W non detergent	9.92 oz	x	x	
Cat	30W non detergent	bottom of sight glass	x	x	
DeVilbiss (horizontal)	** R&O 150	8 oz	x	x	
DeVilbiss (vertical)	** R&O 150	10 oz	x	x	
Faip	15W-50 synthetic	4 oz			x
Giant (HR series)	***20W50 synthetic	4.5 oz			x
Giant (model P316)	***20W50 synthetic	17 oz	x	x	
Giant (model P303)	***20W50 synthetic	14 oz	x	x	
General	30W non detergent	4 oz	x	x	
Karcher	**15W40 non detergent	4 oz			x

\* These pumps do not require the oil to be changed, the oil will last the lifetime of the pump. In the unlikely event of an oil leak, remove all oil and add the correct amount.

\*\* If unable to find use 30W non detergent

\*\*\* If unable to find use 15W50 synthetic

**The following pump (1500-2200 psi) is shipped from the factory with 15W40 non detergent oil:**

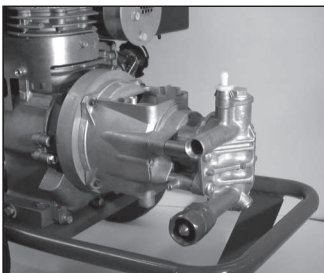

**Karcher**

**The following pumps (1500-2200 psi) are shipped from the factory with 15W-50 synthetic oil:**

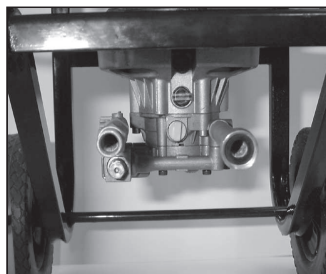

**Faip (Vertical)**

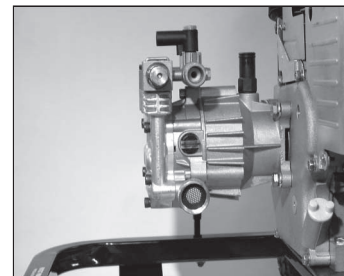

**Faip (Horizontal)**



## MAINTENANCE (cont'd)

The following pump (2200 psi) was shipped from the factory with 10W30 synthetic oil:



**Annovi Reverberi (XJV)**

The following pump (2400 psi) was shipped from the factory with 10W30 synthetic oil:

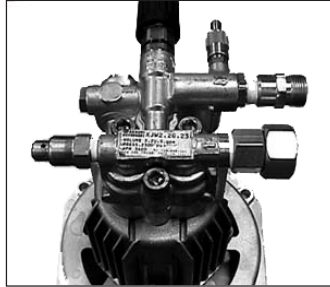

**Annovi Reverberi (XJW)**

The following pump (2000-3500 psi) was shipped from the factory with R&O 150 oil:

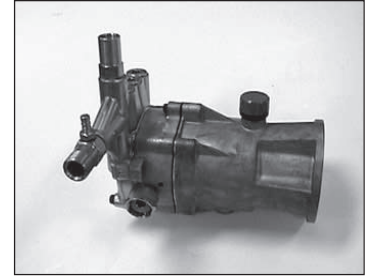

**DeVilbiss (DAPC)**

The following pumps (2000-3500 psi) are shipped from the factory with 30W non-detergent oil:

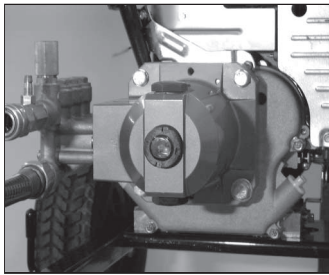

**Cat**

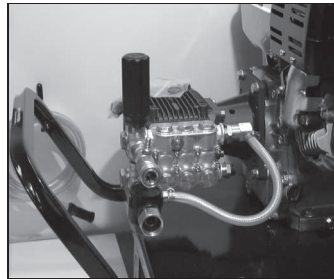

**Annovi Reverberi (Horizontal)**

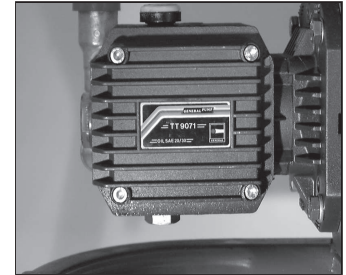

**General**

The following pumps (2000-3500 psi) are shipped from the factory with 20w50 non-detergent oil:

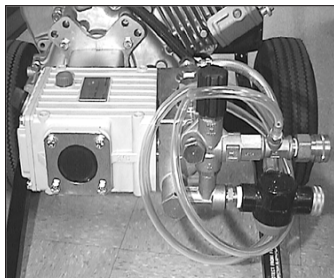

**Giant P303**

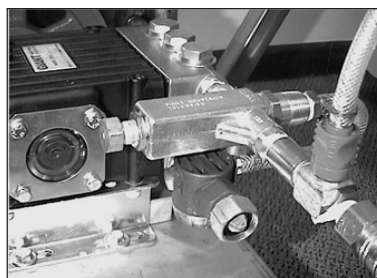

**Giant (beltdriven) P316 (unloader mounted on frame)**



**Giant (beltdriven) P316 (unloader mounted on pump)**

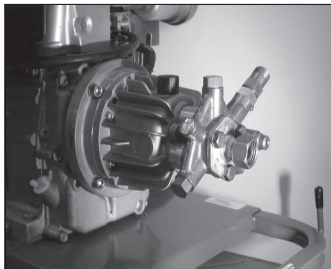

**Giant (PHR Series)**

**MAINTENANCE**

### Nozzle cleaning:

If the nozzle becomes clogged with foreign materials, such as dirt, excessive pressure may develop. If the nozzle becomes partially clogged or restricted, the pump pressure will pulsate. Clean the nozzle immediately using the nozzle kit supplied and the following instructions:

#### Multi-Reg Wand/Lance:

1. Shut off the pressure washer and turn off the water supply.
2. Disconnect spark plug wire.
3. Pull trigger on gun handle to relieve any water pressure.
4. Disconnect the wand/lance from the gun.
5. Remove the nozzle from the end of the wand with the 2mm allen wrench provided as shown in Figure 16.
6. Clean the nozzle using the nozzle cleaner provided or a straightened paper clip. Insert into the nozzle end and work back and forth until obstruction is removed. See Figure 17.
7. Direct water supply into nozzle end to backflush loosened particles for 30 seconds. See Figure 18.
8. Reassemble the nozzle to the wand. Tighten securely to prevent leaks.
9. Reconnect wand/lance to gun and turn on water supply.
10. Start pressure washer and place wand/lance into high pressure setting to test.



Figure 16

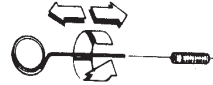

Figure 17

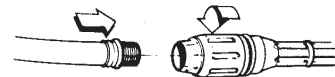

Figure 18

#### Dual Lance/Hi-Low Lance/Quick Connect Lance:

1. Shut off the pressure washer and turn off the water supply.
2. Disconnect spark plug wire.
3. Pull trigger on gun handle to relieve any water pressure.
4. Disconnect the wand/lance from the gun.
5. Remove the high-pressure nozzle from the lance. Remove any obstructions with the nozzle cleaning tool provided and backflush with clean water.

**Note: For pressure washers with Dual-Lance wands as shown here, do not remove the soap nozzle. The soap nozzle can be identified as having the larger hole in the nozzle. See Figure 19.**

6. Direct water supply into nozzle end to backflush loosened particles for 30 seconds.
7. Reassemble the nozzle to the lance using teflon tape to prevent leaks. **Note: Teflon tape is only needed on nozzles for dual-lance and hi/low wands. Tighten securely.**
8. Reconnect wand/lance to gun and turn on water supply.
9. Start pressure washer and place wand/lance into high pressure setting to test.

Dual Lance

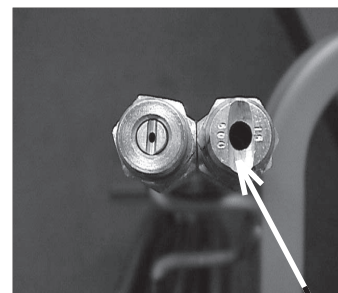

Figure 19

Soap  
Nozzle

### Water Inlet Screen Cleaning:

All pumps are equipped with some type of water filter screen. This screen should be checked periodically and cleaned if necessary. Refer to the illustrations to the right to determine which filter screen your pump has. The filter in Figure 20 and 22 can be removed and cleaned by flushing it with water on both sides. The filter in Figure 21 can be cleaned using the following instructions:

1. Insert a 10 mm allen wrench into the bottom of the filter housing.
2. Turn the housing counterclockwise to remove.
3. Remove the filter screen from the housing and flush with clean water.
4. Clean any dirt/debris from the filter housing.
5. Place the cleaned filter screen into the housing.
6. Reinstall and tighten securely with a 10 mm allen wrench.

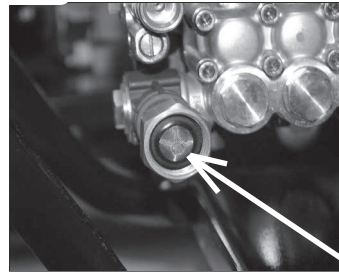

**Figure 20**

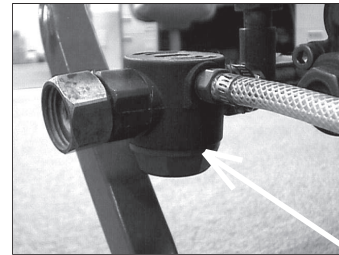

**Figure 21**

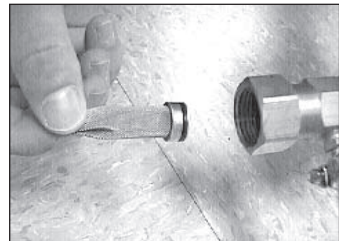

**Figure 22**

---

## STORAGE & WINTER STORAGE

---

### PREPARATION FOR STORAGE

It is recommended that you follow these steps to protect the internal seals of the pressure washer when **storing the unit for an extended period and WHEN FREEZING TEMPERATURES ARE EXPECTED.**

#### ENGINE

1. Remove gasoline from engine or add fuel stabilizer, such as "Sta-Bil" to gasoline to prevent gumming
2. If you are adding fuel stabilizer, connect water supply and high pressure hose to pump and spray gun.
3. Turn water supply on and start engine.
4. Squeeze spray gun trigger while engine is running to avoid operating the pump in "bypass mode".
5. Run engine for five minutes, then shut engine off.
6. Disconnect water supply.
7. Disconnect spark plug wire and remove spark plug.
8. Pour one teaspoon of engine oil into spark plug hole.
9. Place a rag over spark plug hole and pull starter rope slowly several times to lubricate internal cylinder wall.

#### PUMP

**NOTE: If storing the unit for more than 30 days RV antifreeze needs to be ran through the pump. This helps prevent damage within the pump head. RV antifreeze is not only added for winterizing, but for proper lubrication regardless of temperature or environment. Storing the pump less than 30 days does not require the RV antifreeze.**

1. Obtain a funnel, six ounces of RV antifreeze, and approximately 12 inches of garden hose with a male hose connector attached to one end.

### ⚠ CAUTION

**Use only RV antifreeze. Any other antifreeze is corrosive and can damage pump.**

2. Disconnect spark plug wire.
3. Disconnect high pressure hose from pump and from spray gun.
4. Connect 12 inch length of hose to water inlet of pump.
5. Add RV antifreeze to hose as shown.

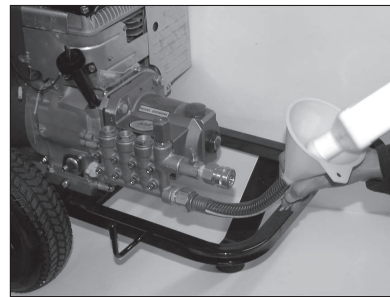

6. Pull engine starter rope slowly several times until antifreeze comes out of high pressure hose connection of pump.
7. Remove short hose from water inlet of pump.
8. Install spark plug into spark plug hole and tighten securely, then reconnect spark plug wire.
9. Drain all water from high pressure hose, coil it, and store it in cradle of the pressure washer handle.
10. Drain all water from spray gun and wand by holding spray gun in a vertical position with nozzle end pointing down and squeezing trigger. Store in gun/hose holder.
11. Store chemical hose, high pressure hose, spray gun, and wand so they are protected from damage, such as being run over.

## TROUBLESHOOTING GUIDE

PROBLEM	CAUSE	CORRECTION
<p>Engine will not start (see Engine Manual for further engine troubleshooting)</p>	<ol style="list-style-type: none"> <li>1. No fuel.</li> <li>2. Low oil (if oil-alert equipped).</li> <li>3. Pressure builds up after two pulls on the recoil starter or after initial use.</li> <li>4. Not primed or choked.</li> <li>5. Spark plug wire not attached.</li> <li>6. Engine <b>ON/OFF</b> switch in <b>OFF</b> position (If equipped.)</li> <li>7. Choke lever in the "Choke" position on a "hot" engine or an engine that has been exposed to thermal heat for a long period of time.</li> <li>8. Fuel valve closed (if equipped)</li> </ol>	<ol style="list-style-type: none"> <li>1. Add Fuel.</li> <li>2. Add required amount of oil.</li> <li>3. Squeeze gun trigger to relieve pressure.</li> <li>4. Push primer bulb 3 times or choke engine.</li> <li>5. Attach spark plug wire.</li> <li>6. Place engine ON/OFF switch in <b>ON</b> position.</li> <li>7. Move choke to the "No Choke" position.</li> <li>8. Move the fuel valve lever to the "Open" position.</li> </ol>
<p>No or low pressure (initial use)</p>	<ol style="list-style-type: none"> <li>1. Wand not in high pressure.</li> <li>2. Low water supply.</li> <li>3. Leak at high pressure hose.</li> <li>4. Nozzle obstructed.</li> <li>5. Water filter screen clogged.</li> <li>6. Defective E-Z start valve. (If applicable)</li> <li>7. Air in hose.</li> <li>8. Choke lever in the "Choke" position.</li> <li>9. Throttle control lever is not in the "Fast" position.</li> <li>10. High pressure hose is too long.</li> </ol>	<ol style="list-style-type: none"> <li>1. See page 11 and 12 for high pressure operation.</li> <li>2. Water supply must be at least 5 GPM @ 20 PSI (See page 3).</li> <li>3. Repair leak. Apply Teflon tape if necessary.</li> <li>4. Clean nozzle with paper clip or nozzle cleaning tool, pour water into nozzle end to flush out obstruction.</li> <li>5. Remove and clean filter.</li> <li>6. Check with Authorized Warranty Service Center (AWSC.)</li> <li>7. Turn off the engine, then the water source. Disconnect the water source from the pump inlet and turn the water source on to remove all air from the hose. When there is a steady stream of water present, turn water source off. Reconnect water source to pump inlet and turn on water source. Squeeze trigger to remove remaining air.</li> <li>8. Move choke to the "No Choke" position.</li> <li>9. Move throttle control lever to the "Fast" position.</li> <li>10. Use high pressure hose under 100 feet.</li> </ol>
<p>Will not draw chemicals</p>	<ol style="list-style-type: none"> <li>1. Wand not in low pressure.</li> <li>2. Chemical filter clogged.</li> <li>3. Chemical screen not in chemical.</li> <li>4. Chemical adjustment knob closed.</li> <li>5. Chemical too thick</li> <li>6. Pressure hose is too long</li> <li>7. Chemical build up in chemical injector.</li> </ol>	<ol style="list-style-type: none"> <li>1. See page 13 for low pressure operation.</li> <li>2. Clean filter.</li> <li>3. Insure end of chemical hose is fully submerged into chemical.</li> <li>4. Turn knob fully counterclockwise to open.</li> <li>5. Dilute chemical. Chemical should be the same consistency as water.</li> <li>6. Lengthen water supply hose instead of pressure hose.</li> <li>7. Have parts cleaned or replaced by AWSC.</li> </ol>

## TROUBLESHOOTING GUIDE

<b>PROBLEM</b>	<b>CAUSE</b>	<b>CORRECTION</b>
No or low pressure (after period of normal use.)	<ol style="list-style-type: none"> <li>1. Worn seal or packing.</li> <li>2. Worn or obstructed valves.</li> <li>3. Worn unloader piston.</li> <li>4. Worn E-Z start valve.</li> </ol>	<ol style="list-style-type: none"> <li>1. Have replaced by AWSC.</li> <li>2. Have replaced by AWSC.</li> <li>3. Have replaced by AWSC.</li> <li>4. Have replaced by AWSC.</li> </ol>
Water leaking at gun/wand connection	<ol style="list-style-type: none"> <li>1. Worn o-ring.</li> <li>2. Loose hose connection.</li> </ol>	<ol style="list-style-type: none"> <li>1. Check and replace.</li> <li>2. Tighten.</li> </ol>
Water leaking at pump	<ol style="list-style-type: none"> <li>1. Loose connections.</li> <li>2. Piston packings worn.</li> <li>3. Worn o-rings.</li> <li>4. Pump head or tubes damaged from freezing.</li> </ol>	<ol style="list-style-type: none"> <li>1. Tighten.</li> <li>2. Have replaced by AWSC.</li> <li>3. Have replaced by AWSC.</li> <li>4. Have replaced by AWSC.</li> </ol>
Oil leaking at pump	<ol style="list-style-type: none"> <li>1. Oil seals worn.</li> <li>2. Loose drain plug.</li> <li>3. Worn drain plug, o-ring (if applicable).</li> <li>4. Worn fill plug o-ring.</li> <li>5. Pump overfilled.</li> <li>6. Incorrect oil used.</li> <li>7. Vent plug is clogged.</li> </ol>	<ol style="list-style-type: none"> <li>1. Have replaced by AWSC.</li> <li>2. Tighten.</li> <li>3. Check and replace.</li> <li>4. Check and replace.</li> <li>5. Check for correct amount.</li> <li>6. Drain and fill with correct amount and type of oil.</li> <li>7. Clean vent plug; blow air through it to remove any blockage. If problem persists, replace plug.</li> </ol>
Engine will not idle down (if equipped with Idle down assembly)	<ol style="list-style-type: none"> <li>1. Cable is loose from idle down assembly.</li> <li>2. Piston is separated from stem in piston/stem assembly.</li> <li>3. Piston Stem is bent.</li> <li>4. Lack of water supply.</li> </ol>	<ol style="list-style-type: none"> <li>1. Reattach cable.</li> <li>2. Have replaced by AWSC.</li> <li>3. Have replaced by AWSC.</li> <li>4. Water supply must be at least 5 GPM @ 20 PSI</li> </ol>
Water leaking from stem on idle down assembly (if equipped)	<ol style="list-style-type: none"> <li>1. O-rings damaged in idle body assembly.</li> <li>2. Damaged stem.</li> </ol>	<ol style="list-style-type: none"> <li>1. Have replaced by AWSC.</li> <li>2. Have replaced by AWSC.</li> </ol>

## LIMITED WARRANTY

All merchandise manufactured by DeVilbiss Air Power Company Manufacturing is warranted to be free of defects in workmanship and material which occur during the first year from the date of purchase by the original purchaser (initial user). Products covered under this warranty include: air compressors, \*air tools, accessories, service parts, pressure washers, and generators used in consumer applications (i.e., personal residential household usage only).

Air compressors, \*air tools, accessories, service parts, pressure washers, and generators used in commercial applications (income producing) are covered by a 90 day warranty.

DeVilbiss Air Power Manufacturing will repair or replace, at DeVilbiss' option, products or components which have failed within the warranty period. Repair or replacement, and service calls on 60 and 80 gallon air compressors, will be handled by Authorized Warranty Service Centers and will be scheduled and serviced according to the normal work flow and business hours at the service center location, and depending on the availability of replacement parts.

All decisions of DeVilbiss Air Power Company Manufacturing with regard to this policy shall be final.

This warranty gives you specific legal rights, and you may also have other rights which vary from state to state.

### RESPONSIBILITY OF ORIGINAL PURCHASER (Initial User):

- To process a warranty claim on this product, DO NOT return it to the retailer. The product must be evaluated by an Authorized Warranty Service Center. For the location of the nearest Authorized Warranty Service Center call 1-800-888-2468, Ext. 2, 24 hours a day, 7 days a week or visit our web site @ devap.com.
- Retain original cash register sales receipt as proof of purchase for warranty work.
- Use reasonable care in the operation and maintenance of the product as described in the Owners Manual(s).
- Deliver or ship the product to the nearest DeVilbiss Air Power Manufacturing Authorized Warranty Service Center. Freight costs, if any, must be paid by the purchaser.
- Air compressors with 60 and 80 gallon tanks only will be inspected at the site of installation. Contact the nearest Authorized Warranty Service Center, that provides on-site service calls, for service call arrangement.
- If the purchaser does not receive satisfactory results from the Authorized Warranty Service Center, the purchaser should contact DeVilbiss Air Power Company Manufacturing.

### THIS WARRANTY DOES NOT COVER:

- Merchandise sold as reconditioned, floor models and/or display models. Any damaged or incomplete equipment sold "as is".
- Merchandise used as "rental" equipment.
- Merchandise that has become inoperative because of ordinary wear, misuse, freeze damage, use of improper chemicals, negligence, accident, improper and/or unauthorized repair or alterations including failure to operate the product in accordance with the instructions provided in the Owners Manual (s) supplied with the product.  
\*Air Tools: O-Rings and driver blades are considered ordinary wear parts, therefore, they are warranted for a period of 45 days from the date of purchase.
- An air compressor that pumps air more than 50% during a one hour period is considered misuse because the air compressor is undersized for the required air demand. Maximum compressor pumping time per hour is 30 minutes.
- Merchandise sold by DeVilbiss Air Power Manufacturing which has been manufactured by and identified as the product of another company. The product manufacturer's warranty will apply.
- Repair and transportation costs of merchandise determined not to be defective.
- Cost associated with assembly, required oil, adjustments or other installation and start-up cost.
- ANY INCIDENTAL, INDIRECT OR CONSEQUENTIAL LOSS, DAMAGE, OR EXPENSE THAT MAY RESULT FROM ANY DEFECT, FAILURE OR MALFUNCTION OF THE PRODUCT.** Some states do not allow the exclusion or limitation of incidental or consequential damages, so the above limitation or exclusion may not apply to you.
- IMPLIED WARRANTIES, INCLUDING THOSE OF MERCHANTABILITY AND FITNESS FOR A PARTICULAR PURPOSE, ARE LIMITED TO ONE YEAR FROM THE DATE OF ORIGINAL PURCHASE.** Some states do not allow limitations on how long an implied warranty lasts, so the above limitations may not apply to you.

 **DeVILBISS AIR POWER COMPANY**  
213 Industrial Drive • Jackson, TN 38301-9615  
Telephone: 1-800-888-2468, Ext. 2  
FAX: 1-800-888-9036

# GENERAL MANUAL FOR

## DeVilbiss/Ex-Cell Pressure Washers

<b>Pressure Washer Quick Facts</b>	
<b>CALL 1-800-888-2468 EXT. 2</b>	
<b>TO FIND A LOCAL AUTHORIZED SERVICE CENTER NEAR YOU FOR REPAIRS AND SERVICE PART PURCHASES.</b>	
GAS	Use fresh high quality gas. Add stabilizer to fuel tank and run engine for 5 minutes before storage.
OIL	Pump oil: Refer to owners manual supplied with this unit. Engine oil: Refer to engine manual supplied with this unit. Some units are equipped with a low oil sensor and adequate oil must be added or the unit will not start.
WATER	Use only cold water. Don't operate unit with clogged or missing water filter/screen. Don't operate unit without adequate water supply to pump. Adequate water supply is a minimum of 20 psi and 5 gpm.
PRESSURE ADJUSTMENT	The pressure setting is preset at the factory to achieve optimum cleaning. If you need to lower the pressure setting, refer to the owners manual for proper procedure.
PUMP	Pull gun trigger every 2 minutes while engine is running. Don't allow water to freeze in pump. Siphon RV antifreeze into pump for cold weather storage or long term storage.
BY-PASS MODE	Never leave unit running for more than 2 minutes without pulling gun trigger; doing so will destroy pump and void warranty.
THERMAL RELIEF VALVE	Pump is equipped with a thermal relief valve. If the water overheats, this valve will open and allow a gush of water to escape. Once the water is released, the valve closes allowing the pump to operate normally.
HOSE	Don't allow hoses to contact the HOT engine muffler during or after use. Never pull the hose to move the unit.
ENGINE	Do not adjust or attempt maintenance without consulting engine manual or an authorized engine service center. Add stabilizer to fuel tank and run engine for 5 minutes before storage. Always turn on the water before starting the engine.
SOAP CHEMICALS	Use only soaps and chemicals designed for pressure washer use.
NOZZLE	Keep nozzle unclogged. Refer to manual for cleaning procedures. Chemical/soap cannot be siphoned in high pressure setting. Only in low setting.
MAINTENANCE SCHEDULE	Follow recommended maintenance schedule for engine & pump. Refer to manuals.
STORAGE	Draw clean water through chemical inlet.
OR WINTER STORAGE	Add stabilizer to fuel tank and run engine for 5 minutes before storage. Don't allow water to freeze in pump, gun, wand or hoses. Siphon RV antifreeze into pump for cold weather storage or long term storage.
<b>ALWAYS REFER TO THE MANUALS SUPPLIED WITH THIS UNIT</b>	