



VENTED DECORATIVE GAS LOG HEATER OWNER'S OPERATION AND INSTALLATION MANUAL



We recommend that our products be installed and serviced by professionals who are certified in the U.S. by NFI (National Fireplace Institute). www.nficertified.org

HARDWOOD ORIGINAL

HCA-18-RFN
HCA-24-RFN
HCA-18-RFP
HCA-24-RFP

CALIFORNIA MAPLE

HCM-18-RFN
HCM-24-RFN
HCM-18-RFP
HCM-24-RFP

KENTUCKY ELM

HKE-18-RFN
HKE-24-RFN
HKE-18-RFP
HKE-24-RFP

WARNING: If the information in this manual is not followed exactly, a fire or explosion may result causing property damage, personal injury or loss of life.

- Do not store or use gasoline or other flammable vapors and liquids in the vicinity of this or any other appliance.
- **WHAT TO DO IF YOU SMELL GAS**
 - Do not try to light any appliance.
 - Do not touch any electrical switch; do not use any phone in your building.
 - Immediately call your gas supplier from a neighbor's phone. Follow the gas supplier's instructions.
 - If you cannot reach your gas supplier, call the fire department.
- Installation and service must be performed by a qualified installer, service agency or the gas supplier.

WARNING: Improper installation, adjustment, alteration, service or maintenance can cause injury or property damage. Refer to this manual for correct installation and operational procedures. For assistance or additional information consult a qualified installer, service agency or the gas supplier.

WARNING: This appliance is for installation only in a solid-fuel burning masonry or UL127 factory-built fireplace, constructed of noncombustible material and connected to a working flue. (See page 6 for minimum flue opening.)

WARNING: This is a gas-fired heater. It uses air (oxygen) from the room in which it is installed. Provisions for adequate combustion and ventilation air must be provided. Refer to the *National Fuel Gas Codes, ANSI Z233.1/NFPA 54, Section 5.3, Air for Combustion and Ventilation.*

This appliance may be installed in an aftermarket,* permanently located, manufactured (mobile) home, where not prohibited by local codes.

This appliance is only for use with the type of gas indicated on the rating plate. This appliance is not convertible for use with other gases.

* Aftermarket: Completion of sale, not for purpose of resale, from the manufacturer

State of Massachusetts: The installation must be made by a licensed plumber or gas fitter in the Commonwealth of Massachusetts.

TABLE OF CONTENTS

Safety Information	3	Technical Service	12
Product Identification	4	Replacement Parts	12
Local Codes	4	Troubleshooting	13
Unpacking	5	Specifications	15
General Information	5	Wiring Diagram	15
Installation	5	Illustrated Parts Breakdown and Parts List	16
Operating Appliance	9	Accessories	18
Inspecting Burners	11	Warranty Information	Back Page
Cleaning and Maintenance	12		

SAFETY INFORMATION

⚠ WARNING: This product contains and/or generates chemicals known to the State of California to cause cancer or birth defects or other reproductive harm.

⚠ WARNING: Keep flue open when operating unit.

IMPORTANT: Read this owner's manual carefully and completely before trying to assemble, operate or service this log set. Improper use of this log set can cause serious injury or death from burns, fire, explosion, electrical shock and carbon monoxide poisoning.

⚠ DANGER: Carbon monoxide poisoning may lead to death!

Carbon Monoxide Poisoning: Early signs of carbon monoxide poisoning resemble the flu, with headaches, dizziness or nausea. If you have these signs, the log set may not be working properly. **Get fresh air at once!** Have log set serviced. Some people are more affected by carbon monoxide than others. These include pregnant women, people with heart or lung disease or anemia, those under the influence of alcohol and those at high altitudes.

Natural & LP Gas: Natural & LP gas are odorless. An odor-making agent is added to the gas. The odor helps you detect a gas leak. However, the odor added to the gas can fade. Gas may be present even though no odor exists.

Make certain you read and understand all warnings. Keep this manual for reference. It is your guide to safe and proper operation of this log set.

⚠ WARNING: Any change to this log set or its controls can be dangerous.

⚠ WARNING: Do not use a blower insert, heat exchanger insert or other accessory not approved for use with this appliance.

⚠ WARNING: This appliance is equipped for (natural or propane/LP) gas. Field conversion is not permitted.

⚠ WARNING: Do not allow fans to blow directly into the fireplace. Avoid any drafts that alter burner flame patterns.

⚠ WARNING: Installed decorative glass door enclosures must be fully opened when operating this gas appliance.

Due to high temperatures, the appliance should be located out of traffic and away from furniture and draperies.

Do not place clothing or other flammable material on or near the appliance. Never place any objects on the heater.

Heater assembly becomes very hot when running heater. Keep children and adults away from hot surface to avoid burns or clothing ignition. Heater will remain hot for a time after shutdown. Allow surface to cool before touching.

Carefully supervise young children when they are in the room with appliance.

You must operate this heater with a fireplace screen in place. Make sure fireplace screen is closed before running heater.

Keep the appliance area clear and free from combustible materials, gasoline and other flammable vapors and liquids.

SAFETY INFORMATION

Continued

Children and adults should be alerted to the hazard of high temperature and should stay away to avoid burns or clothing ignition.

1. This appliance, as supplied, is only for use with the type of gas indicated on the rating plate. This appliance is not convertible for use with other gases.
2. Do not place propane/LP supply tank(s) inside the structure. Locate propane/LP supply tank(s) outdoors (propane/LP units only).
3. If you smell gas
 - shut off gas supply
 - do not try to light any appliance
 - do not touch any electrical switch; do not use any phone in your building
 - immediately call your gas supplier from a neighbor's phone. Follow the gas supplier's instructions
 - if you cannot reach your gas supplier, call the fire department
4. Never install the log set
 - in a recreational vehicle
 - where curtains, furniture, clothing or other flammable objects are less than 42 inches from the front, top or sides of the log set.
 - in high traffic areas
 - in windy or drafty areas
5. Before installing in a solid fuel burning fireplace, the chimney flue and firebox must be cleaned of soot, creosote, ashes and loose paint by a qualified chimney cleaner. Creosote will ignite if highly heated. Inspect chimney flue for damage. If damaged, repair flue before operating appliance.
6. If fireplace has glass doors, never operate with glass doors closed. If you operate heater with doors closed, heat buildup inside fireplace will cause glass to burst. Also if fireplace opening has vents at the bottom, you must open the vents before operating heater.
7. To reduce the creation of soot, follow the instructions in *Cleaning and Maintenance*, page 12.
8. Do not run heater
 - where flammable liquids or vapors are used or stored
 - under dusty conditions
9. Do not burn solid fuel in the fireplace after installing the log set. Do not use this log set to cook food or burn paper or other objects.

10. Log set becomes very hot when in use. Keep children and adults away from hot surface to avoid burns or clothing ignition. Log set will remain hot for a time after shutdown. Allow surface to cool before touching.
11. Carefully supervise young children when they are in the room with the log set.
12. Do not use heater if any part has been exposed to or under water. Immediately call a qualified service technician to inspect the room heater and to replace any part of the control system and any gas control which has been under water.
13. Turn log set off and let cool before servicing, installing or repairing. Only a qualified service person should install, service or repair log set.
14. Provide adequate clearances around air openings.

LOCAL CODES

Install and use log set with care. Follow all local codes. In the absence of local codes, use the latest edition of the *National Fuel Gas Code ANSI Z223.1/NFPA 54**

*Available from:

American National Standards Institute, Inc.
1430 Broadway
New York, NY 10018

National Fire Protection Association, Inc.
Battery march park
Quincy, MA 02269

Hardwood Series gas log sets are certified by Omni Test Laboratories to Z21.60A-2000/CGA 2.26A-2000 as a vented decorative gas log set.

PRODUCT IDENTIFICATION

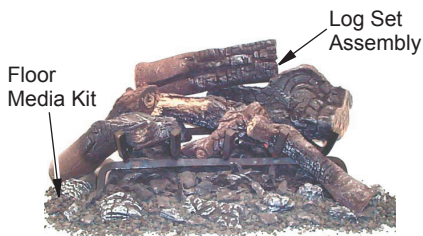

Figure 1 - Product Identification

UNPACKING

CAUTION: Do not remove the data plates from the grate assembly. The data plates contain important warranty and safety information.

1. Remove log set assembly from carton.
2. Remove all protective packaging applied to log set for shipment.
3. Check all items for any shipping damage. If damaged, promptly inform dealer where you bought appliance.

GENERAL INFORMATION

These vented decorative gas log sets incorporate uni-body constructed ceramic fiber logs and ember bed burner which glow realistically when the appliance is in operation.

These units are remote controlled-decorative rated and are equipped with millivolt gas valves. The remote control allows for flame height adjustment, timer and on/off control.

A spark ignition system (piezo) allows the gas pilot to be lit without the use of matches or batteries and permits operation of the heater during a power outage.

These log sets come with a Floor Media Kit included. This kit is used to blend the floor and the log set together for a more natural look.

INSTALLATION

WARNING: A qualified service person must install heater. Follow all local codes.

WARNING: Before installing in a solid fuel burning fireplace, the chimney flue and firebox must be cleaned of soot, creosote, ashes and loose paint by a qualified chimney cleaner. Creosote will ignite if highly heated. A dirty chimney flue may create and distribute soot within the house. Inspect chimney flue for damage. If damaged, repair flue damper before operating appliance.

CAUTION: This heater creates warm air currents. These currents move heat to wall surfaces next to heater. Installing heater next to vinyl or cloth wall coverings or operating heater where impurities (such as, but not limited to, tobacco smoke, aromatic candles, cleaning fluids, oil or kerosene lamps, etc.) in the air exist, may discolor walls or cause odors.

WARNING: Special care is required if you are installing the unit into a sunken fireplace. You must raise the fireplace floor to allow access to gas log controls. This will insure adequate air flow and guard against sooting. Raise the fireplace floor using noncombustible material.

CHECK GAS TYPE

Use the correct gas type (natural or propane/LP) for your unit. If your gas supply is not correct, do not instal in fireplace. Call dealer where you bought the appliance for proper type of appliance.

WARNING: This appliance is equipped for (natural or propane/LP) gas. Field conversion is not permitted.

FLUE OPENING SPECIFICATIONS

Note: This vented appliance must be installed only in a solid-fuel burning fireplace with a working flue and constructed of noncombustible material. The fireplace chimney must have a permanent vent opening to outside of not less than 29 square inches or as determined from manufacturer's installation instructions.

LOG SIZING REQUIREMENTS				
LOG SIZE	MINIMUM FIREBOX SIZE			
	HEIGHT	DEPTH	FRONT WIDTH	REAR WIDTH
18"	14"	16"	30"	20"
24"	18"	18"	34"	24"

INSTALLATION

Continued

VENTING SPECIFICATIONS FOR INSTALLATION

The fireplace chimney flue and vent must be drafting properly. To check the vent for proper drafting: Light a tightly rolled newspaper on one end and place it at the inside front edge of the fireplace. Observe the smoke and be sure the vent is properly drawing it up the chimney. If the smoke spills out into the room, extinguish the flame and remove any obstruction until proper venting is achieved.

The chimney flue damper must be fixed open to provide a minimum of 29 square inch flue opening at all times during operation of the log set. A damper clamp can be used to secure the damper (see Accessories, page 18). See the *National Fuel Gas Code ANSI Z223.1/NFPA 54, Section 6.6* for details about minimum flue size.

INSTALLING DAMPER CLAMP

Secure the damper stop clamp to the edge of the damper as shown in Figure 2. If for any reason this clamp doesn't work on your fireplace, another suitable clamp or permanent stop must be installed, or the damper blade must be cut or removed.

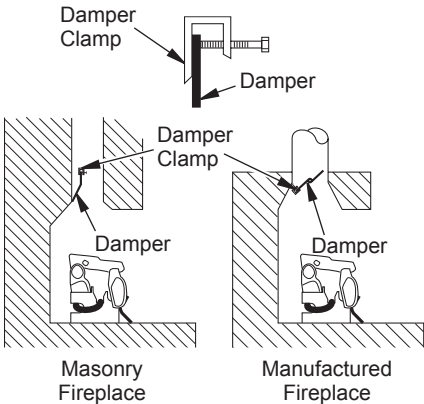

Figure 2 - Attaching Damper Clamp

PLACEMENT OF APPLIANCE

Center the appliance in the fireplace. Make certain the grate front feet sit inside the front edge of the fireplace and that there is adequate clearance around the appliance for access and operation.

CONNECTING TO GAS SUPPLY

⚠ WARNING: A qualified service person must connect heater to gas supply. Follow all local codes.

Installation Items Needed

Before installing heater, make sure you have the items listed below.

- external regulator (propane/LP models only)
- piping (check local codes)
- sealant (resistant to propane/LP gas)
- equipment shutoff valve
- test gauge connection
- sediment trap
- tee joint
- pipe wrench

For propane/LP units, the installer must supply an external regulator. The external regulator will reduce incoming gas pressure. You must reduce incoming gas pressure to between 11 and 14 inches of water. If you do not reduce incoming gas pressure, heater regulator damage could occur. Install external regulator with the vent pointing down as shown in Figure 3. Pointing the vent down protects it from freezing rain or sleet.

⚠ WARNING: Connecting directly to an unregulated propane/LP tank may cause an explosion.

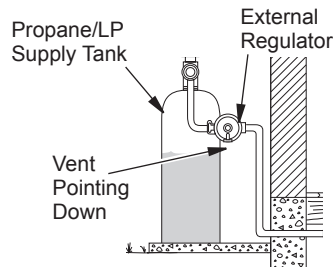

Figure 3 - External Regulator with Vent Pointing Down

INSTALLATION

Continued

The appliance gas inlet connection is 3/8" NPT at the regulator, located at the rear of the appliance. **IMPORTANT:** Hold appliance regulator with a wrench to prevent movement when connecting to inlet piping.

CAUTION: Use only new, black iron or steel pipe. Internally-tinned copper tubing may be used in certain areas. Check your local codes. Use pipe of 1/2" diameter or greater to allow proper gas volume to heater. If pipe is too small, undue loss of volume will occur.

Installation must include an equipment shutoff valve, union and plugged 1/8" NPT tap. Locate NPT tap within reach for test gauge hook up. NPT tap must be upstream from log set (see Figure 4).

IMPORTANT: Install equipment shutoff valve in an accessible location. The equipment shutoff valve is for turning on or shutting off the gas to the appliance.

Apply pipe joint sealant lightly to male NPT threads. This will prevent excess sealant from going into pipe. Excess sealant in pipe could result in clogged heater valves.

WARNING: Use pipe joint sealant that is resistant to liquid petroleum (LP) gas.

Install a sediment trap where it is within reach for cleaning. Install in piping system between fuel supply and heater. Locate sediment trap where trapped matter is not likely to freeze. A sediment trap traps moisture and contaminants. This keeps them from going into heater controls. If sediment trap is not installed or is installed wrong, heater may not run properly.

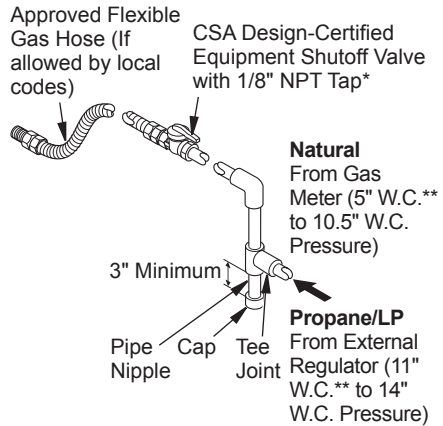

Figure 4 - Gas Connection

* Purchase the optional CSA design-certified shutoff valve from your dealer. See *Accessories*, page 18.

** Minimum inlet pressure for purpose of input adjustment.

CHECKING GAS CONNECTIONS

WARNING: Test all gas piping and connections for leaks after installing or servicing. Correct all leaks at once.

WARNING: Never use an open flame to check for a leak. Apply a noncorrosive leak detection fluid to all joints. Bubbles forming show a leak. Correct all leaks at once.

PRESSURE TESTING GAS SUPPLY PIPING SYSTEM

Test Pressures In Excess Of 1/2 PSIG (3.5 kPa)

1. Disconnect appliance with its appliance main gas valve (control valve) and equipment shutoff valve from gas supply piping system. Pressures in excess of 1/2 psig will damage heater regulator.
2. Cap off open end of gas pipe where equipment shutoff valve was connected.
3. Pressurize supply piping system by either opening propane/LP supply tank valve for propane/LP gas or opening main gas valve located on or near gas meter for natural gas or using compressed air.

INSTALLATION

Continued

4. Check all joints of gas supply piping system. Apply noncorrosive leak detection fluid to all joints. Bubbles forming show a leak.
5. Correct all leaks at once.
6. Reconnect heater and equipment shutoff valve to gas supply. Check reconnected fittings for leaks.

Test Pressures Equal To or Less Than 1/2 PSIG (3.5 kPa)

1. Close equipment shutoff valve (see Figure 5).
2. Pressurize supply piping system by either opening propane/LP supply tank valve for propane/LP gas or opening main gas valve located on or near gas meter for natural gas or using compressed air.
3. Check all joints from gas meter to equipment shutoff valve for natural gas or propane/LP supply to equipment shutoff valve for propane/LP (see Figure 6 or 7). Apply noncorrosive leak detection fluid to all joints. Bubbles forming show a leak.
4. Correct all leaks at once.

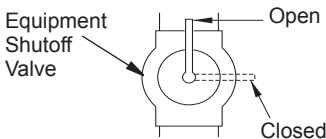

Figure 5 - Equipment Shutoff Valve

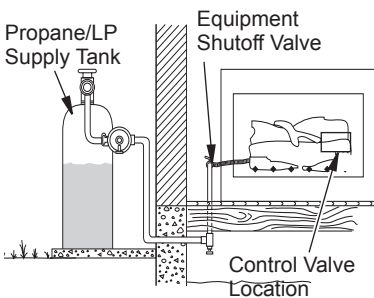

Figure 6 - Checking Gas Joints (Propane/LP Gas Only)

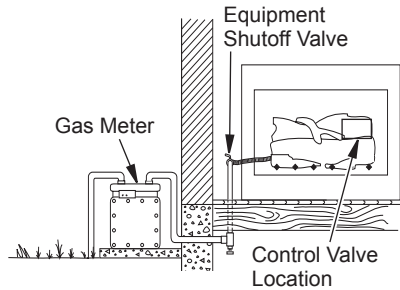

Figure 7 - Checking Gas Joints (Natural Gas Only)

Gas Pressure Check

The appliance regulator controls the burner pressure which should be checked at the pressure test point (1/8" NPT plugged tap) located near the on the control valve identified OUT for the manifold side and IN for inlet pressure. Make sure operating pressures are within the limits shown in *Specifications*, page 15.

The pressure should be checked with the unit burning and set to High. Replace test point plug or tighten test screw after pressure measurement ensuring no gas leaks.

PLACEMENT OF FLOOR MEDIA

WARNING: Do not add extra logs or ornaments such as pine cones, vermiculite or rock wool. Using these added items can cause sooting. Use only the material included in the kits.

WARNING: Do not place lava rock, embers or fiber log pieces on logs or burners. This may cause sooting. Place floor media material only on the fireplace floor.

1. Place lava rock around base of unit making sure the burner ports and valve access are not blocked (see Figure 8, page 9). Retain a small amount of lava rock to be used in step 4, page 9.
2. Place ember material around front and sides of unit close to (but NOT on) the burner (see Figure 9, page 9). Embers will "glow" when heated to enhance the realistic look of your log set.

INSTALLATION

Continued

3. Place fiber log pieces randomly on lava rock and ember material around unit (see Figure 10).
4. Use remaining lava rock to blend the floor media together. Your finished effect should resemble Figure 11.

⚠ WARNING: Failure to position the floor media as shown in Figures 8 through 11 or failure to use only parts specifically approved with this appliance may result in property damage or personal injury.



Figure 8 - Placing Lava Rock



Figure 9 - Placing Ember Material



Figure 10 - Placing Fiber Log Pieces



Figure 11 - Floor Media Kits Installed

OPERATING APPLIANCE

The RF Millivolt valve control used on these appliances allows you to turn the gas log set on or off; use a timer to automatically operate the log set; increase or decrease flame height, fan speed or timing. An easy-to-read display gives you information about room temperature, set temperature, flame height level, fan speed level and a countdown timer, as well as a low battery indication. Figure 12 shows the location of the controls and indicators for the transmitter (remote) and the receiver (valve).

Note: Fan operations are not applicable to these Hardwood Series.

TRANSMITTER/REMOTE

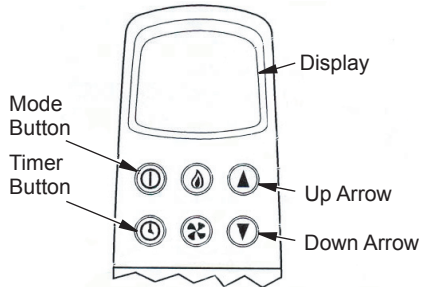

RECEIVER/VALVE

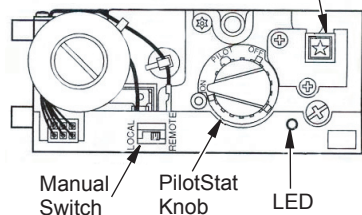



Figure 12 - RF Millivolt Valve Controls with Transmitter/Remote

OPERATING HEATER

Continued

FOR YOUR SAFETY READ BEFORE LIGHTING

 **WARNING:** Keep flue open when operating unit.

 **WARNING:** If you do not follow these instructions exactly, a fire or explosion may result causing property damage, personal injury or loss of life.

- A. This appliance has a pilot which must be lighted with a piezo ignitor. When lighting the pilot, follow these instructions exactly.
- B. **BEFORE LIGHTING** smell all around the appliance area for gas. Be sure to smell next to the floor because some gas is heavier than air and will settle on the floor.

WHAT TO DO IF YOU SMELL GAS

- Do not try to light any appliance.
 - Do not touch any electric switch; do not use any phone in your building.
 - Immediately call your gas supplier from a neighbor's phone. Follow the gas supplier's instructions.
 - If you cannot reach your gas supplier, call the fire department.
- C. Use only your hand to push in or turn gas control knob. Never use tools. If the knob will not push in or turn by hand, do not try to repair it, call a qualified technician. Force or attempted repair may result in a fire.
- D. Do not use this appliance if any part has been under water. Immediately call a qualified service technician to inspect the appliance and to replace any part of the control system and any gas control which has been under water.



LIGHTING INSTRUCTIONS

NOTICE: During initial operation the appliance will emit a slight odor for an hour or two. This is due to the "burn-in" of the internal paints and lubricants used in manufacturing. For the first few hours, operate the appliance with doors and windows open to encourage dissipation of odor.

1. **STOP!** Read the safety information, column 1.
2. Make sure equipment shutoff valve is fully open.
3. Set switch in the Local position.
4. Wait five (5) minutes to clear out any gas. If you then smell gas **STOP!** Follow the safety information above. If you don't smell gas, go on to the next step.
5. Turn PilotStat knob to **PILOT**. Push in on PilotStat knob and press Piezo button  until the pilot is lit.
6. Continue to hold PilotStat knob in until LED blinks (one brief blink every two seconds) then release knob. **Note:** You will need to hold the knob in for about one minute.
7. Turn PilotStat knob to **ON** See Figure 12, page 9.

 **WARNING:** Moving the Local/Remote switch can cause the main burner to come on immediately. Stand away from the main burner when moving the local/remote switch to avoid possible injury.

USING TRANSMITTER/ REMOTE

1. Move switch to **REMOTE** position (see Figure 12, page 9).
2. Press **FAN**  or **FLAME**  key within 30 seconds.
3. Make sure LED turns on for one second.

OPERATING HEATER

Continued

4. Press MODE (ⓘ) button until mode shows in display window of transmitter/remote. Press up or down key to change set temperature.
5. To set delay timer, press TIMER (⌚) button followed by either the up or down key.
6. To change the flame height, press the MODE (ⓘ) button until mode is ON. Press the FLAME (🔥) button and press the up or down arrow key.
7. To change between Fahrenheit and Celsius, press the up and down arrow keys at the same time and hold for at least three seconds.

TO TURN OFF GAS TO APPLIANCE

Shut Off Main Burner Using Remote

Press MODE (ⓘ) button until mode is OFF. Pilot stays lit.

Shut Off Main Burner Without Remote

Turn PilotStat knob to PILOT. Pilot stays lit.

Shut Off Main Burner and Pilot

Turn PilotStat knob to OFF.

⚠ CAUTION: During normal shutdown of this unit, a flash may be observed due to the nature of the burner components. Remain clear of the unit during the shutdown process.

INSPECTING BURNERS

Check pilot flame pattern and burner flame patterns often.

Flames from the pilot should always be present when the appliance is in operation (see Figure 13).

The flame should look similar to those in Figure 14. The flames should look random in appearance with the ember bed glowing red-orange in color.

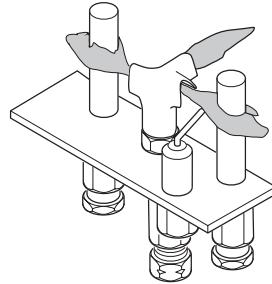

Figure 13 - Correct Pilot Flame Pattern



Hardwood Original Log Set



California Maple Log Set



Kentucky Elm Log Set

Figure 14 - Log Sets with Flame Patterns

CLEANING AND MAINTENANCE

⚠ WARNING: Turn off the appliance and allow to cool before cleaning.

⚠ CAUTION: You must keep control areas, burners and circulating air passageways of fireplace clean. Inspect these areas of fireplace before each use. Have fireplace and chimney (if applicable) inspected yearly by a qualified service person. Fireplace may need more frequent cleaning due to excessive lint from carpeting, bedding material, etc.

Only limited cleaning will be required under normal use of this appliance. Dust the front grate and top of receiver/valve. Do not use cleaning fluids to clean logs or any other part of the appliance.

If, after a period of use, the flames start to exhibit unusual shapes and behavior or the burner fails to ignite smoothly, then the burner holes may require some cleaning. If this happens, we recommend that you contact your nearest authorized service technician to get the appliance serviced.

TRANSMITTER

If the battery light is on or the display is blank, you will need to replace the three AAA batteries in transmitter/remote. To change batteries in the transmitter/remote, slide the battery compartment door off to expose old batteries. Place new batteries into housing and reattach door. See Figure 15.

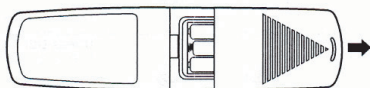

Figure 15 - Bottom of Transmitter, Showing Battery Compartment and Door

TECHNICAL SERVICE

You may have further questions about installation, operation or troubleshooting. If so, contact DESA's Technical Service Department at 1-866-672-6040. When calling please have your model and serial numbers of your heater ready.

You can also visit DESA's technical services web site at www.desatech.com.

REPLACEMENT PARTS

Note: Use only original replacement parts. This will protect your warranty coverage for parts replaced under warranty.

PARTS UNDER WARRANTY

Contact authorized dealers of this product. If they can't supply original replacement part(s), call DESA's Technical Service Department at 1-866-672-6040. When calling DESA, have ready

- your name and address
- model and serial numbers of your log set
- how log set was malfunctioning
- type of gas used (propane/LP or natural gas)
- purchase date

Usually, we will ask you to return the part to the factory.

PARTS NOT UNDER WARRANTY

Contact authorized dealers of this product. If they can't supply original replacement part(s), call DESA at 1-866-672-6040 for referral information. When calling DESA, have ready

- model number of your log set
- the replacement part number

TROUBLESHOOTING

Note: In normal operation, LED blinks once every two seconds; also, LED will be on for one second after every valid command received by the receiver/valve' these are not error codes.

Failure codes can occur anytime after the pilot burner is lit. Failure code timing is 1/4 second on, 1/2 second off.

Sequence is failure code followed by LED not blinking for four seconds.

In the event of multiple failure codes, the next failure code follows the previous failure code by approximately 3 seconds.

LED Failure Code (No. of Blinks)	Service Action
8	Replace valve.
7	Confirm stepper motor connection exists.
5	Confirm fan connection exists and works.
3	Replace thermopiles.
2	Device too hot. Turn on fan or if applicable, open glass doors.
1 short blink	Normal operation

LED Failure Codes and Service Action



WARNING: Turn off and unplug heater and let cool before servicing. Only a qualified service person should service and repair heater.

IMPORTANT: Valve system troubleshooting should only be accomplished by a qualified service technician.

Note: Before troubleshooting the gas control system, be sure external gas shut off valve (located at gas supply inlet) is in the "ON" position.

OBSERVED PROBLEM	POSSIBLE CAUSE	REMEDY
Spark ignitor will not light pilot after repeated triggering of ignitor button	<ol style="list-style-type: none"> Defective ignitor (no spark at electrode) Defective or misaligned electrode at pilot (spark at electrode) Gas supply pressure errant Pilot orifice plugged 	<ol style="list-style-type: none"> Check for spark at electrode and pilot; if no spark and electrode wire is properly connected, replace ignitor Using a match, light pilot. If pilot lights, turn off pilot and trigger the ignitor button again. If pilot lights, an improper gas mixture caused the bad lighting and a longer purge period is recommended. If pilot will not light, check gap at electrode and pilot - gap should be 1/8" to have a strong spark. If gap measures 1/8", replace pilot Check inlet gas pressure. It should be within the limits as marked on the rating plate Clean or replace pilot orifice
Pilot will not stay lit after carefully following the lighting instructions	<ol style="list-style-type: none"> Defective pilot generator (thermocouple) 	<ol style="list-style-type: none"> Check pilot flame, it must impinge on thermocouple (see Figure 13, page 11). Clean and/or adjust pilot for maximum flame impingement on thermocouple. Ensure that the connection between the valve and thermocouple are tight and secure.

TROUBLESHOOTING

Continued

OBSERVED PROBLEM	POSSIBLE CAUSE	REMEDY
Pilot burning, no gas to burner, valve knob "ON", wall switch "ON"	1. Wall switch or wires defective	1. Check wall switch and wires for proper connections. Jumper wire across terminals at wall switch. If burner comes on, replace defective wall switch. If okay, jumper wires across wall switch wires at valve. If burner comes on, wires are faulty or connections are bad
	2. Thermopile may not be generating sufficient millivoltage.	2. Check thermopile with millivolt meter. Take reading at thermopile terminals of gas valve. It should read 325 millivolts minimum with optional wall switch "OFF". Replace faulty thermopile if reading is below specified minimum.
	3. Plugged burner orifice	3. Check burner orifice for stoppage and remove
Frequent pilot/burner outage problem	1. Pilot flame may be too low or blowing (high) causing the pilot/valve safety to drop out	1. Clean and/or adjust pilot flame for maximum flame impingement on thermocouple (see Figure 13, page 11)

SPECIFICATIONS

	HCA-24-RFN HCM-24-RFN HKE-24-RFN	HCA-24-RFP HCM-24-RFP HKE-24-RFP	HCA-18-RFN HCM-18-RFN HKE-18-RFN	HCA-18-RFP HCM-18-RFP HKE-18-RFP
Btu (Variable)	45,000/67,000	43,000/65,000	41,000/56,000	42,000/51,000
Type Gas	Natural Gas Only	Propane/LP Only	Natural Gas Only	Propane/LP Only
Ignition	Piezo	Piezo	Piezo	Piezo
Manifold Pressure	3.5" - 1.6"W.C.	10" - 6.3"W.C.	3.5" - 1.6"W.C.	10" - 6.3"W.C.
Inlet Gas Pressure (in. of water)				
Maximum	10.5" W.C.	13" W.C.	10.5" W.C.	13" W.C.
Minimum*	5.0" W.C.	11" W.C.	5.0" W.C.	11" W.C.
Valve Operation	RF Millivolt	RF Millivolt	RF Millivolt	RF Millivolt
Orifice Size	#21	#42	#28	#45

* For purpose of input adjustment

WIRING DIAGRAM

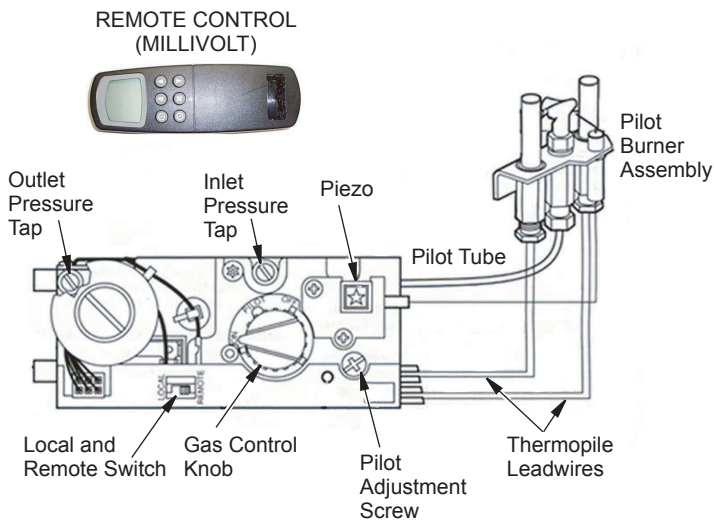

⚠ POWER SUPPLY. PROVIDE DISCONNECT MEANS AND OVERLOAD PROTECTION AS REQUIRED.

Figure 16 - Millivolt System Wiring Diagram

ILLUSTRATED PARTS BREAKDOWN

HCA-24-RFN, HCA-24-RFP, HCA-18-RFN, HCA-18-RFP, HCM-24-RFN,
HCM-24-RFP, HCM-18-RFN, HCM-18-RFP, HKE-24-RFN, HKE-24-RFP,
HKE-18-RFN, HKE-18-RFP

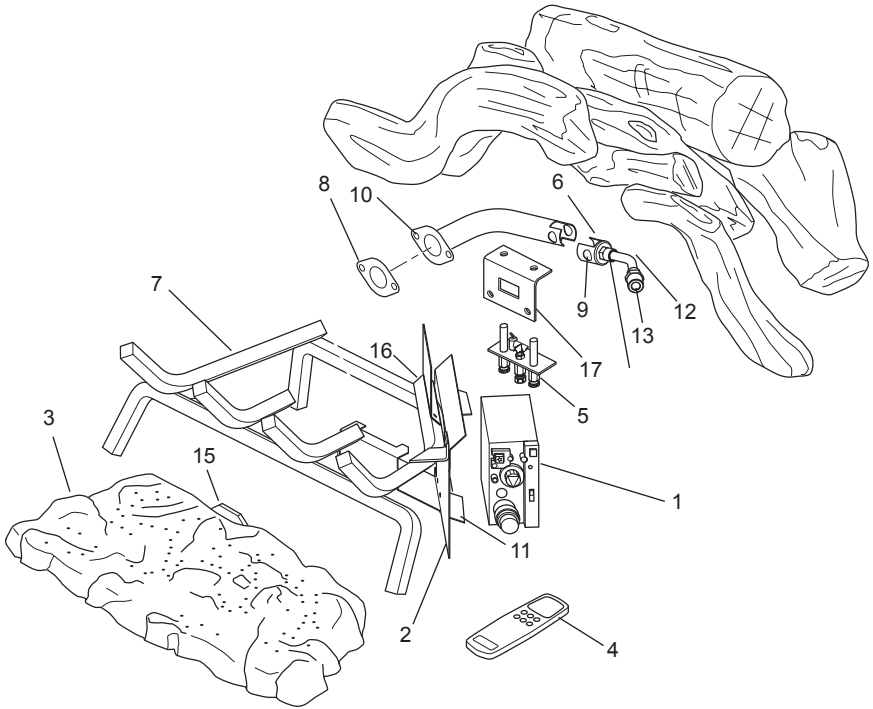

PARTS LIST

This list contains replaceable parts used in your heater. When ordering parts, follow the instructions listed under *Replacement Parts* on page 12 of this manual.

KEY NO.	PART NUMBER				DESCRIPTION	QTY.
	HCA-24-RFN	HCA-24-RFP	HCA-18-RFN	HCA-18-RFP		
	HCM-24-RFN	HCM-24-RFP	HCM-18-RFN	HCM-18-RFP		
1	111814-01	111814-02	111814-01	111814-02	Gas Valve	1
2	115453-01	115453-01	115453-01	115453-01	Valve/Pilot Bracket	1
3	115457-01	115457-01	115458-01	115458-01	Log Burner	1
4	111815-01	111815-01	111815-01	111815-01	Transmitter/Remote	1
5	111809-01	111809-02	111809-01	111809-02	Pilot	1
6	115490-01	115490-02	115490-03	115490-04	Orifice	1
7	115449-01	115449-01	115448-01	115448-01	Grate	1
8	104489-01	104489-01	104489-01	104489-01	Gasket	1
9	115491-01	115492-01	115492-01	115493-01	Air Shutter	1
10	115454-01	115454-01	115454-01	115454-02	Venturi	1
11	115452-01	115452-01	115452-01	115452-01	Valve Bracket	1
12	115488-01	115488-01	115488-01	115488-01	Tube	1
13	14396	14396	14396	14396	Adapter Valve	1
14	115489-01	115489-01	115489-01	115489-01	Adapter Orifice	1
15	115450-01	115450-01	115451-01	115451-01	Burner Plate	1
16	115456-01	115456-01	115456-01	115456-01	Log Support Plate	1
17	114394-01	114394-01	114394-01	114394-01	Pilot Shield	1
PARTS AVAILABLE NOT SHOWN						
	111288-02	111288-02	111288-02	111288-02	Flex Gas Line	1
	112363-01	112363-01	112363-01	112363-01	Ember Chunk Kit #1 (3 Pieces)	1
	112364-01	112364-01	112364-01	112364-01	Ember Chunk Kit #2 (2 Pieces)	1
	112799-01	112799-01	112799-01	112799-01	Ember Flakes Kit	1
	GA6060	GA6060	GA6060	GA6060	Lava Rock	1

LOG SET ASSEMBLIES	
MODELS	PART NO.
HCA-24-RFN/P	115474-01
HCM-24-RFN/P	115471-01
HKE-24-RFN/P	115473-01
HCA-18-RFN/P	115469-01
HCM-18-RFN/P	115470-01
HKE-18-RFN/P	115472-01

ACCESSORIES

Purchase these appliances from your local dealer. If they can not supply these accessories, call DESA at 1-866-672-6040 for referral information. You can also write to the address listed on the back page of this manual.

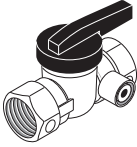

EQUIPMENT SHUTOFF VALVE

GA5010

Equipment shutoff valve with 1/8" NPT tap. Fits 1/2" pipe.

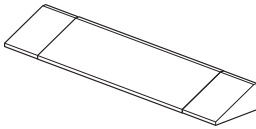

FIREPLACE HOOD

Black - GA6050

Brass-GA6052

Antique Brss - GA6053

Helps deflect heat away from mantel or wall above fireplace. Fits opening 28" to 4" wide.

DAMPER CLAMP - GA6080

(Not Shown)

Permanently opens chimney flue damper for vented operation.

LAVA ROCK - GA6060

(Not Shown)

Order when additional rock is desired (1.8 lb. bag)

WARRANTY INFORMATION

KEEP THIS WARRANTY

Model _____
Serial No. _____
Date Purchased _____

Always specify model and serial numbers when communicating with the factory.

We reserve the right to amend these specifications at any time without notice. The only warranty applicable is our standard written warranty. We make no other warranty, expressed or implied.

LIMITED WARRANTY

VENT-FREE FIREBOX

DESA warrants this product to be free from defects in materials and components for four (4) years from the date of first purchase, provided that the product has been properly installed, operated and maintained in accordance with all applicable instructions. To make a claim under this warranty the Bill of Sale or cancelled check must be presented.

This warranty is extended only to the original retail purchaser. This warranty covers the cost of part(s) required to restore this heater to proper operating condition and an allowance for labor when provided by a DESA Authorized Service Center. Warranty part(s) MUST be obtained through authorized dealers of this product and/or DESA who will provide original factory replacement parts. Failure to use original factory replacement parts voids this warranty. The heater MUST be installed by a qualified installer in accordance with all local codes and instructions furnished with the unit.

This warranty does not apply to parts that are not in original condition because of normal wear and tear or parts that fail or become damaged as a result of misuse, accidents, lack of proper maintenance or defects caused by improper installation. As with all concrete liners, this liner may develop slight cracks when exposed to heat. This cracking is considered normal. Travel, diagnostic cost, labor, transportation and any and all such other costs related to repairing a defective heater will be the responsibility of the owner.

TO THE FULL EXTENT ALLOWED BY THE LAW OF THE JURISDICTION THAT GOVERNS THE SALE OF THE PRODUCT; THIS EXPRESS WARRANTY EXCLUDES ANY AND ALL OTHER EXPRESSED WARRANTIES AND LIMITS THE DURATION OF ANY AND ALL IMPLIED WARRANTIES, INCLUDING WARRANTIES OF MERCHANTABILITY AND FITNESS FOR A PARTICULAR PURPOSE TO FOUR (4) YEARS ON ALL COMPONENTS FROM THE DATE OF FIRST PURCHASE; AND DESA'S LIABILITY IS HEREBY LIMITED TO THE PURCHASE PRICE OF THE PRODUCT AND DESA SHALL NOT BE LIABLE FOR ANY OTHER DAMAGES WHATSOEVER INCLUDING INDIRECT, INCIDENTAL OR CONSEQUENTIAL DAMAGES.

Some states do not allow a limitation on how long an implied warranty lasts or an exclusion or limitation of incidental or consequential damages, so the above limitation on implied warranties or exclusion or limitation on damages may not apply to you.

This warranty gives you specific legal rights and you may also have other rights that vary from state to state.

For information about this warranty write:



2701 Industrial Drive
P.O. Box 90004
Bowling Green, KY 42102-9004
www.desatech.com



115481-01
NOT A UPC

115481-01
Rev. A
02/05