

INSTALLATION AND OPERATING INSTRUCTIONS

FAN / LED LIGHT / LED NIGHT LIGHT

READ AND SAVE THESE INSTRUCTIONS

GENERAL SAFETY INFORMATION

1. Make sure that the electric service supply voltage is AC 120V, 60Hz.
2. Follow all local electrical and safety codes, as well as the Nation Electrical Code (NEC) and the Occupation Safety and Healthy Act (OSHA).
3. Always disconnect the power source before working on or near the ventilating fan, motor or junction box.
4. Protect the power cord from sharp edges, oil, grease, hot surfaces, chemicals or other objects.
5. Do not kink the power cord.
6. Do not install the unit where ducts are configured as shown in Fig. A.
7. Provide suction parts with proper ventilation.
8. This unit is UL listed for use over a bathtub or shower when installed in a GFCI protected branch circuit.
9. These ventilating fans are intended for residential usage only.
10. Do not install this ventilating fan where air temperature may exceed 40°C (104°F).

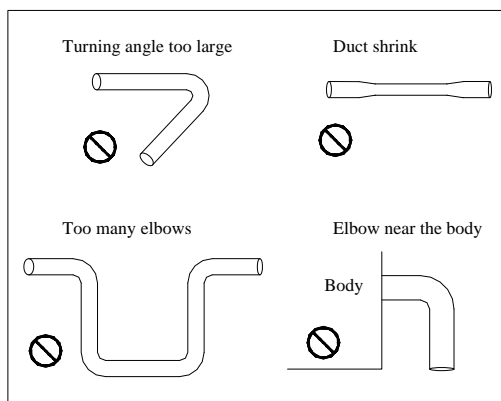
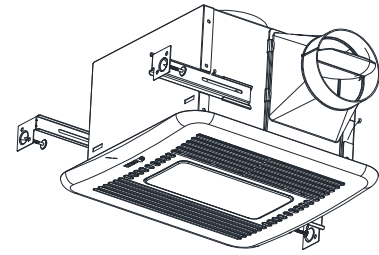

Fig. A

WARNING

TO REDUCE THE RISK OF FIRE, ELECTRIC SHOCK, OR INJURY TO PERSONS, OBSERVE THE FOLLOWING:

1. Use this unit only in the manner intended by the manufacturer. If you have questions, contact the manufacturer.
2. Before servicing or cleaning unit, switch power off at service panel and lock the service disconnecting means to prevent power from being switched on accidentally. When the service disconnecting means cannot be locked, securely fasten a prominent warning device, such as a tag, to the service panel.
3. Installation work and electrical wiring must be done by qualified person(s) in accordance with all applicable codes



- and standards, including fire-rated construction.
4. Sufficient air is needed for proper combustion and exhausting of gases through the flue (chimney) of fuel burning equipment to prevent back drafting. Follow the heating equipment manufacturer's guideline and safety standards such as those published by the National Fire Protection Association (NFPA), and the American Society of Heating, Refrigeration and Air Conditioning Engineers (ASHRAE) and local code authorities.
5. When cutting or drilling into wall or ceiling, do not damage electrical wiring and other hidden utilities.
6. Ducted ventilating fan must always be vented to the outdoors.
7. If this unit is to be installed over a tub or shower, it must be marked as appropriate for the application and be connected to a GFCI (Ground Fault Circuit Interrupter) – protected branch circuit.
8. Do not use this unit with any other solid-state control device. Solid-state controls may cause harmonic distortion, which can cause motor humming noise.
9. NEVER place a switch where it can be reached from a tub or shower.
10. Not to be installed in a ceiling thermally insulated to a value greater than R40. (This is required for installation in Canada only)
11. Do not open/disassemble the LED light engine or tear off the warranty label for protect the life and performance.

CAUTION

1. To reduce the risk of electric shock, please disconnect the electrical supply circuit to the fan before installing light kit.
2. For general ventilating use only. Do not use to exhaust hazardous or explosive materials and vapors.
3. Not for use in cooking area. (Fig. B)
4. This product must be properly connect to the grounding conductor of the supply circuit.

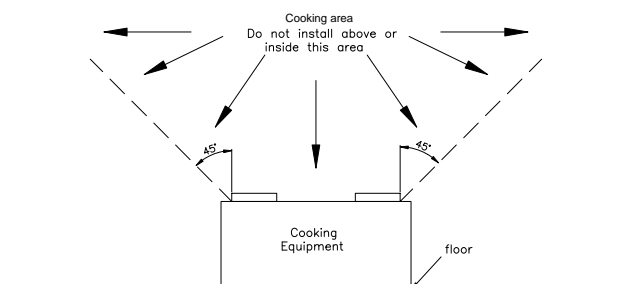
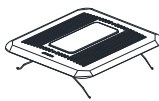
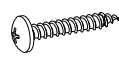





Fig. B

SUPPLIED ACCESSORIES

| Part name | Appearance | Quantity |
|---|---|----------|
| Grille (Include LED Light Engine) |  | 1 |
| Long Screw (M4×25) |  | 6 |
| Screw (M4×12) |  | 3 |
| Suspension bracket I (6.10 inch) |  | 1 |
| Suspension bracket II (11.81 inch) |  | 1 |
| Suspension bracket III (13.98 inch) |  | 1 |

INSTALLATIONS
A. Install with wood frame

| | |
|--------------------|--------------|
| Model No. | VFB080D4LED1 |
| Install Dim. (in.) | 10.2 × 10.2 |

1. Body installation

1-1. Construct the wood frame(not provided) with 30mm square bar and attach it to the ceiling joist.

1-2. Attach the duct connector to the wood frame with taping screw.

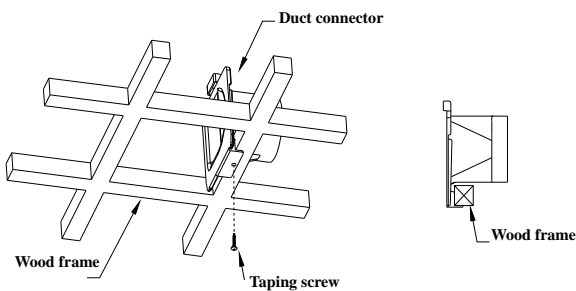

1-3. Insert the body into the wood frame and connect it to the duct connector. Secure the body on wood frame with taping screws.

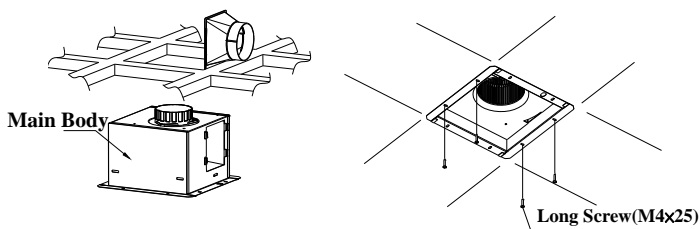

B. Install with joist

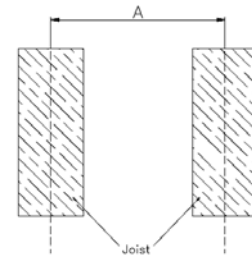
1. Choose the installation type according to the fig as below:

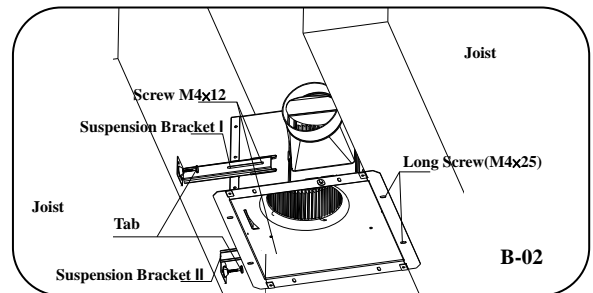
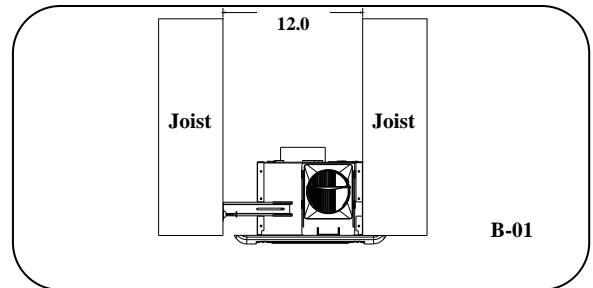

| Spacing A on center joists | Insert Suspension bracket | Suspension bracket No. |
|----------------------------|---------------------------|------------------------|
| 12.0 inch | Refer to Fig B-01, B-02 | I,II |
| 16.0 inch | Refer to Fig B-03, B-04 | I,II,III |
| 19.2 inch | Refer to Fig B-03, B-04 | I,II,III |
| 24.0 inch | Refer to Fig B-03, B-04 | I,II,III |

1-1 Type I – 12 inches between joists



1-1.1 Insert the suspension bracket I into the bracket cover of adaptor side and select one of suspension bracket II of the back of the fan body.

1-1.2 Insert the fan between joists. Make sure the fan body is level and perpendicular with the joist.

1-1.3. Ensure the distance between ceiling and fan body for the thickness of grille.

1-1.4 Secure the all suspension bracket to joists by using taping screw on the tab.

1-1.5 Secure the suspension bracket I and II to fan body by using screw(M4×12-2pce each).

1-2 Type II – 16/19.2/24 inches between joists

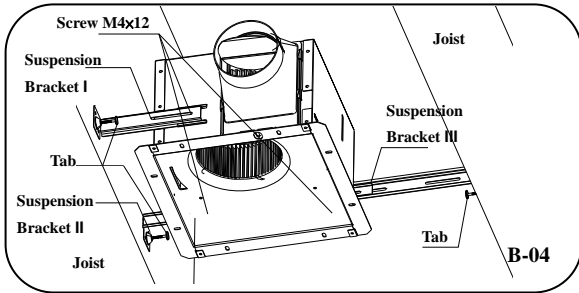
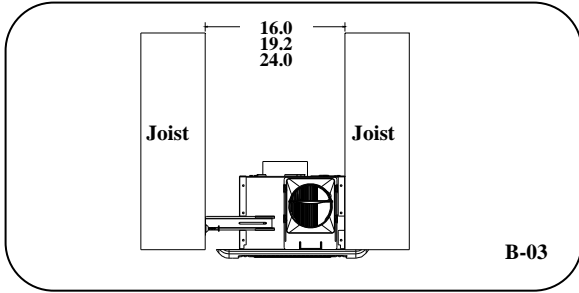

- 1-2.1 Insert the suspension bracket I into the bracket cover of adaptor side and insert the suspension bracket II and III into the back of the fan body.
- 1-2.2 Insert the fan between joists. Make sure the fan body is level and perpendicular with the joist.
- 1-2.3 Ensure the distance between ceiling and fan body for the thickness of grille.
- 1-2.4 Secure the all suspension bracket to joists by using tapping screw on the tab.
- 1-2.5 Secure the suspension bracket I to fan body by using screw(M4×12).
- 1-2.6 Secure the suspension bracket to fan body by using screw(M4×12) between II and III.

2. Duct connection

- 2-1. Insert the duct into the duct connector and tape all ductworks connection to make them secure and air tight.
- 2-2. Install the duct with a gradient 1°~2° to the outside.

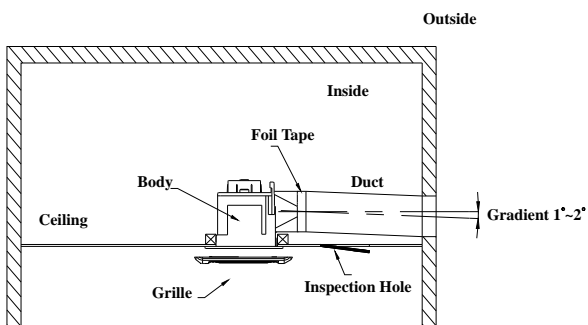

3. Connect wiring

- 3-1. Follow all local electrical and safety codes.
- 3-2. NEVER place a switch where it can be reached from a tub or shower.

3-3. Connect wires as shown in wiring diagrams.

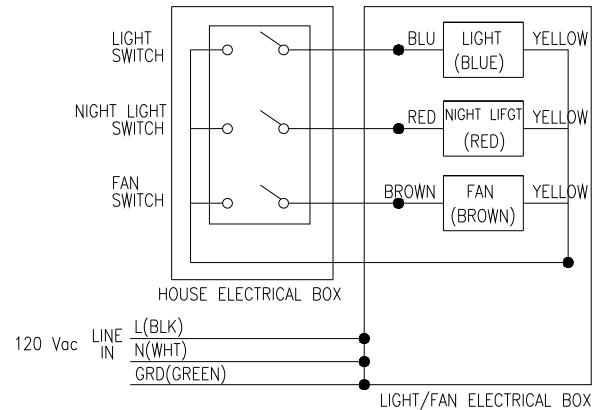

- BROWN, CONNECT TO SWITCH PANEL(FAN).
- BLUE, CONNECT TO ON/OFF SWITCH PANEL(MAIN LIGHT).
- RED, CONNECT TO ON/OFF SWITCH PANEL(NIGHT LIGHT).
- YELLOW, CONNECT TO ON/OFF SWITCH PANEL(COMMON).
- BLACK, CONNECT TO SWITCH BOX(L).
- WHITE, CONNECT TO SWITCH BOX(N).
- GROUND, CONNECT TO SWITCH BOX(EARTH GROUND).

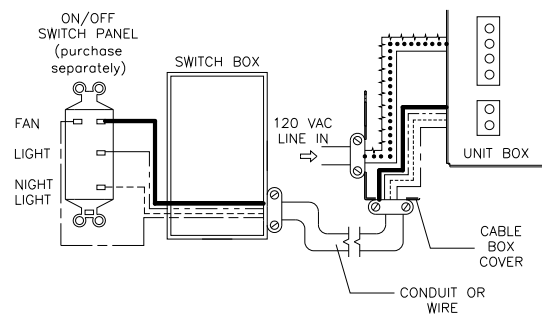

3-4. Using wire nuts, connect house power cable to ventilating fan, light and night light wires.

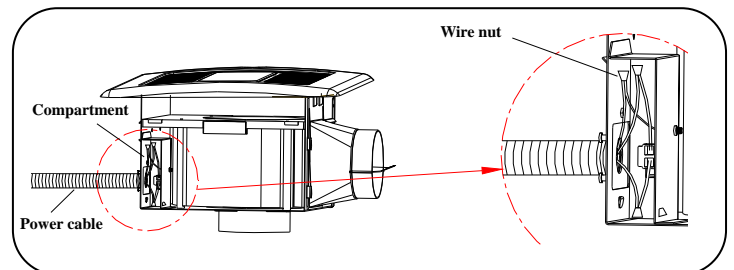

3-5. 14 AWG (2.1 mm²) is the smallest conductor that shall be used for branch-circuit wiring.

4. Test run and grille attachment

- 4-1. Insert the LED light engine power source connect into the installation location of main body.
- 4-2. When the power on, check for abnormal vibration or sound.
- 4-3. Insert the mounting springs into the slots and mount the grille to the body.

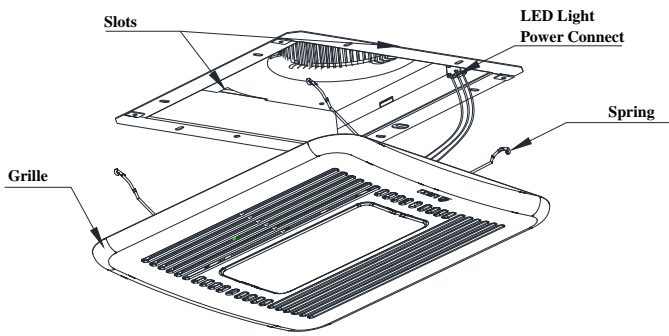

SPECIFICATIONS-LED LIGHT ENGINE (AT FULL LIGHT OUTOUT)

| ITEM | SPEC. |
|------------------------------------|----------------|
| DIMENSION (INCH) | 8Lx4.4Wx1.4H |
| POWER CONSUMPTION (W) | 16 |
| CORRELATED COLOR TEMPERATURE (K) | 4000 |
| LIGHT SOURCE LIFE (HOURS) | 25000 (MIN.) |
| TRANSIENT PROTECTION | CLASS A |
| OPERATING FREQUENCY (HZ) | 120 |
| FCC QUALIFIED | YES |
| ENERGY QUALIFIED | YES |
| ROHS QUALIFIED | YES |
| SAFETY REQUIREMENTS | UL/cUL |

5. Operation

Model: VFB080D4LED1

Turn on/off the power to operate fan / light / night light on/off.

MAINTENANCE

WARNING:

Disconnect power source before working on unit. Routine maintenance must be done every year.

CAUTION:

1. Never use gasoline, benzene, thinner or any other such chemicals for cleaning the ventilating fan.
2. Do not allow water to enter motor.
3. Do not soak resin parts in water over 60°C.

CLEANING :

1. Remove the LED light engine from grille module carefully. Disassemble the light power connections to remove grille.
2. Wash and clean grille. CAUTION: Do not let water into the LED light engine. (Use non-abrasive kitchen detergent, wipe dry with a new cloth.)
3. Remove dust and dirt from ventilating fan using a cleaner.
4. Replace grille.

DIMENSION

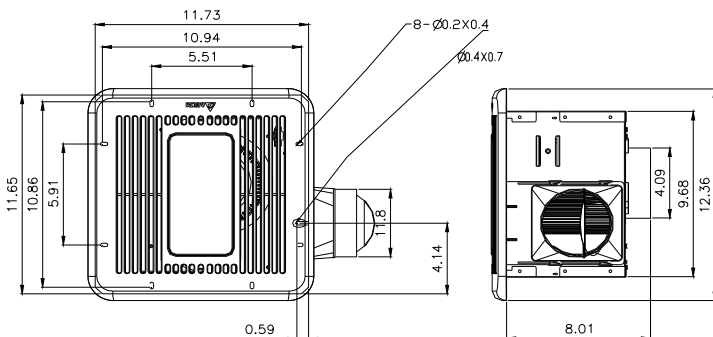

SPECIFICATIONS-VENTOLATION FAN

| Model No. | Voltage (V) | Frequency (Hz) | Power (W) | Air Flow @ 0.1SP (CFM) | Weight (lb.) | Note |
|--------------|-------------|----------------|-----------|------------------------|--------------|-----------------------------|
| VFB080D4LED1 | 120 | 60 | 25 | 80 | 8 | LED Light / LED Night Light |

WARRANTY

DELTA ELECTRONICS THREE YEAR LIMITED WARRANTY

Delta Electronics Inc. ("Delta Electronics") warrants to the original consumer purchaser in the USA that the Breez ventilation fan products will be free from defects in material or workmanship. This warranty is limited to three (3) years from the original date of purchase.

Limitations and Exclusions

1. During the warranty period, a replacement for any defective product will be supplied free of charge for installation by the consumer. The warranty provided herein does not cover charges for labor or other costs incurred in the troubleshooting, repair, removal, and installation service.
2. All returns of defective parts or products must include the product model number, and must be made through an authorized Delta Electronics distributor. Authorized returns must be shipped prepaid. Repaired or replacement products will be shipped by Delta Electronics F.O.B. shipping point.
3. Delta Electronics shall not be liable for any indirect, incidental, consequential, punitive, or special damages arising out of or in connection with products use or performance, regardless of the form of action whether in contract, tort (including negligence), strict product liability or otherwise.
4. This warranty does not extend to fluorescent lamp starters and tubes.
5. The warranty does not cover if user does not comply with manufacture's installation manual.
6. To qualify for warranty service, you must notify Delta Electronics at the address or telephone number below.
7. Delta Electronics shall have no liability to the original owner-user with respect to any defect caused by abuse, misuse, neglect, improper transportation or storage, improper testing, improper installation, improper operation, improper use, improper maintenance, improper repair, improper alteration, improper modification, tampering or accident of products or parts thereof, or unusual deterioration or degradation of products or parts thereof due to a physical environment beyond the requirements of products' specifications.

Address: 4405 Cushing Parkway, Fremont, CA 94538

US Toll Free Number: 1-888-979-9889