



---

**Magellan<sup>®</sup> 1000i**  
***Omni-Directional Imaging Scanner***



***Product Reference Guide***

---

## **Datalogic Scanning, Inc.**

959 Terry Street  
Eugene, Oregon 97402  
Telephone: (541) 683-5700  
Fax: (541) 345-7140

An Unpublished Work - All rights reserved. No part of the contents of this documentation or the procedures described therein may be reproduced or transmitted in any form or by any means without prior written permission of Datalogic Scanning, Inc. or its subsidiaries or affiliates ("Datalogic" or "Datalogic Scanning"). Owners of Datalogic products are hereby granted a non-exclusive, revocable license to reproduce and transmit this documentation for the purchaser's own internal business purposes. Purchaser shall not remove or alter any proprietary notices, including copyright notices, contained in this documentation and shall ensure that all notices appear on any reproductions of the documentation.

Should future revisions of this manual be published, you can acquire printed versions by contacting your Datalogic representative. Electronic versions may either be downloadable from the Datalogic website ([www.scanning.datalogic.com](http://www.scanning.datalogic.com)) or provided on appropriate media. If you visit our website and would like to make comments or suggestions about this or other Datalogic publications, please let us know via the "Contact Datalogic" page.

### **Disclaimer**

Datalogic has taken reasonable measures to provide information in this manual that is complete and accurate, however, Datalogic reserves the right to change any specification at any time without prior notice.

Datalogic is a registered trademark of Datalogic S.p.A. and the Datalogic logo is a trademark of Datalogic S.p.A. all licensed to Datalogic Scanning, Inc. All other trademarks and trade names referred to herein are property of their respective owners.

This product may be covered by one or more of the following patents: 4603262 • 4639606 • 4652750 • 4672215 • 4699447 • 4709369 • 4749879 • 4786798 • 4792666 • 4794240 • 4798943 • 4799164 • 4820911 • 4845349 • 4861972 • 4861973 • 4866257 • 4868836 • 4879456 • 4939355 • 4939356 • 4943127 • 4963719 • 4971176 • 4971177 • 4991692 • 5001406 • 5015831 • 5019697 • 5019698 • 5086879 • 5115120 • 5144118 • 5146463 • 5179270 • 5198649 • 5200597 • 5202784 • 5208449 • 5210397 • 5212371 • 5212372 • 5214270 • 5229590 • 5231293 • 5232185 • 5233169 • 5235168 • 5237161 • 5237162 • 5239165 • 5247161 • 5256864 • 5258604 • 5258699 • 5260554 • 5274219 • 5296689 • 5298728 • 5311000 • 5327451 • 5329103 • 5330370 • 5347113 • 5347121 • 5371361 • 5382783 • 5386105 • 5389917 • 5410108 • 5420410 • 5422472 • 5426507 • 5438187 • 5440110 • 5440111 • 5446271 • 5446749 • 5448050 • 5463211 • 5475206 • 5475207 • 5479011 • 5481098 • 5491328 • 5493108 • 5504350 • 5508505 • 5512740 • 5541397 • 5552593 • 5557095 • 5563402 • 5565668 • 5576531 • 5581707 • 5594231 • 5594441 • 5598070 • 5602376 • 5608201 • 5608399 • 5612529 • 5629510 • 5635699 • 5641958 • 5646391 • 5661435 • 5664231 • 5666045 • 5671374 • 5675138 • 5682028 • 5686716 • 5696370 • 5703347 • 5705802 • 5714750 • 5717194 • 5723852 • 5750976 • 5767502 • 5770847 • 5786581 • 5786585 • 5787103 • 5789732 • 5796222 • 5804809 • 5814803 • 5814804 • 5821721 • 5822343 • 5825009 • 5834708 • 5834750 • 5837983 • 5837988 • 5852286 • 5864129 • 5869827 • 5874722 • 5883370 • 5905249 • 5907147 • 5923023 • 5925868 • 5929421 • 5945670 • 5959284 • 5962838 • 5979769 • 6000619 • 6006991 • 6012639 • 6016135 • 6024284 • 6041374 • 6042012 • 6045044 • 6047889 • 6047894 • 6056198 • 6065676 • 6069696 • 6073849 • 6073851 • 6094288 • 6112993 • 6129279 • 6129282 • 6134039 • 6142376 • 6152368 • 6152372 • 6155488 • 6166375 • 6169614 • 6173894 • 6176429 • 6188500 • 6189784 • 6213397 • 6223986 • 6230975 • 6230976 • 6237852 • 6244510 • 6259545 • 6260763 • 6266175 • 6273336 • 6276605 • 6279829 • 6290134 • 6290135 • 6293467 • 6303927 • 6311895 • 6318634 • 6328216 • 6332576 • 6332577 • 6343741 • 6454168 • 6478224 • 6568598 • 6578765 • 6705527 • 6974084 • 6991169 • 7051940 • 7170414 • 7172123 • 7201322 • 7204422 • 7215493 • 7224540 • 601 26 118.6 • AU703547 • D312631 • D313590 • D320011 • D320012 • D323492 • D330707 • D330708 • D349109 • D350127 • D350735 • D351149 • D351150 • D352936 • D352937 • D352938 • D352939 • D358588 • D361565 • D372234 • D374630 • D374869 • D375493 • D376357 • D377345 • D377346 • D377347 • D377348 • D388075 • D446524 • EP0256296 • EP0260155 • EP0260156 • EP0295936 • EP0325469 • EP0349770 • EP0368254 • EP0442215 • EP0498366 • EP0531645 • EP0663643 • EP0698251 • EP01330772 • GB2252333 • GB2284086 • GB2301691 • GB2304954 • GB2307093 • GB2308267 • GB2308678 • GB2319103 • GB2333163 • GB2343079 • GB2344486 • GB2345568 • GB2354340 • ISR107546 • ISR118507 • ISR118508 • JP1962823 • JP1971216 • JP2513442 • JP2732459 • JP2829331 • JP2953593 • JP2964278 • MEX185552 • MEX187245 • RE37166 • Other Patents Pending

# Table of Contents

About This Manual .....	1-1
Manual Conventions .....	1-1
Connecting the Scanner .....	1-2
Programming .....	1-3
Using the Programming Bar Codes .....	1-3
Resetting the Standard Product Defaults .....	1-3
LED and Beeper Indicators .....	1-4
Error Codes .....	1-5
Double Read Timeout .....	2-1
Label Gone Timeout .....	2-3
Productivity Index Reporting (PIR) .....	2-3
Sleep Mode .....	2-4
LED and Beeper Indicators .....	2-6
Power On Alert .....	2-6
Good Read: When to Indicate .....	2-7
Good Read Beep Control .....	2-8
Good Read Beep Frequency .....	2-8
Good Read Beep Length .....	2-9
Good Read Beep Volume .....	2-10
Scanning Features .....	2-11
Targeted Scanning Mode .....	2-11
Target Mode Active Time .....	2-11
Target Mode Linger Time .....	2-12
Wake Up Intensity .....	2-13
Interface Selection .....	3-3
Interface Features .....	3-7
Obey/Ignore Host Commands .....	3-7
Host Transmission Buffers .....	3-8
RS-232 Interface Features .....	3-9
Hardware Flow Control .....	3-11
Intercharacter Delay .....	3-12
Intercharacter Delay — cont. ....	3-13
Software Flow Control .....	3-13
Host Echo .....	3-14
Host Echo Quiet Interval .....	3-15
Signal Voltage: Normal/TTL .....	3-16
RS-232 Invert .....	3-17
Beep on ASCII BEL .....	3-17
Beep on Not on File .....	3-18
ACK NAK Options .....	3-19
ACK Character .....	3-20
NAK Character .....	3-20
Retry on ACK NAK Timeout .....	3-21
ACK NAK Timeout Value .....	3-21
ACK NAK Retry Count .....	3-22
ACK NAK Error Handling .....	3-23
Transmission Failure Indication .....	3-24
IBM-USB Interface Features .....	3-24
IBM-USB Device usage .....	3-24
IBM .....	3-25
IBM Transmit Labels in Code 39 Format .....	3-25
Wand Emulation .....	3-26
Supported Symbologies .....	3-26
Wand Emulation Bar Code Format .....	3-26

Bar/Space Polarity .....	3-27
Wand Idle State .....	3-27
Signal Speed .....	3-28
Transmit Trailing Noise .....	3-28
Transmit Leading Noise .....	3-29
Symbology Conversion .....	3-29
Keyboard Wedge .....	3-30
USB Keyboard .....	3-30
Caps Lock State .....	3-32
Data Editing Overview .....	4-1
Please Keep In Mind... .....	4-1
Global Prefix/Suffix .....	4-2
AIM ID .....	4-4
Label ID .....	4-5
Case Conversion .....	4-11
Character Conversion .....	4-12
UPC-A .....	5-1
Disable/Enable UPC-A .....	5-1
Check Digit Transmission .....	5-2
Expand UPC-A to EAN-13 .....	5-2
Number System Transmission .....	5-3
UPC-A Minimum Reads .....	5-3
UPC-A In-store Minimum Reads .....	5-4
UPC-E .....	5-5
Disable/Enable UPC-E .....	5-5
Check Digit Transmission .....	5-5
Number System Digit .....	5-6
Expand to UPC-E to UPC-A .....	5-6
Expand UPC-E to EAN13 .....	5-7
Minimum Reads .....	5-7
GTIN .....	5-8
Expand UPC/EAN to GTIN .....	5-8
EAN-13 .....	5-9
Disable/Enable EAN-13 .....	5-9
Check Digit Transmission .....	5-9
EAN-13 Flag 1 Character .....	5-10
ISBN .....	5-10
Minimum Reads .....	5-11
EAN-8 .....	5-12
Disable/Enable EAN-8 .....	5-12
Check Digit Transmission .....	5-12
Minimum Reads .....	5-13
Enable EAN Two-Label .....	5-14
Add-ons .....	5-15
RSS-14 .....	5-17
Disable/Enable RSS-14 .....	5-17
UCC/EAN 128 Emulation .....	5-17
RSS-14 — continued .....	5-18
Minimum Reads .....	5-18
RSS Expanded .....	5-19
Disable/Enable RSS Expanded .....	5-19
UCC/EAN 128 Emulation .....	5-19
RSS Expanded — continued .....	5-20
Length Control .....	5-20
RSS Expanded — continued .....	5-21
RSS Expanded Length 1, Length 2 Programming Instructions .....	5-21
Minimum Reads .....	5-22
Code 39 .....	5-23
Disable/Enable Code 39 .....	5-23
Check Character Calculation .....	5-23
Check Character Transmit .....	5-24
Start/Stop Characters .....	5-24

Code 39 Full ASCII .....	5-25
Length Control .....	5-26
Code 39 Length 1, Length 2 Programming Instructions .....	5-27
Quiet Zones .....	5-27
Code 39 Stitching .....	5-28
Minimum Reads .....	5-28
Pharmacode 39 .....	5-29
Disable/Enable Pharmacode 39 .....	5-29
Start/Stop Characters .....	5-29
Check Character Transmit .....	5-30
Code 128 .....	5-31
Disable/Enable Code 128 .....	5-31
Transmit Function Characters .....	5-31
Length Control .....	5-32
Code 128 — continued .....	5-33
Code 128 Length 1, Length 2 Programming Instructions .....	5-33
Code 128 Conversion to Code 39 .....	5-33
Code 128 Stitching .....	5-34
Minimum Reads .....	5-34
Interleaved 2 of 5 .....	5-35
Disable/Enable Interleaved 2 of 5 .....	5-35
Check Digit Calculation .....	5-35
Check Digit Transmit .....	5-36
Length Control .....	5-37
Interleaved 2 of 5 Length 1, Length 2 Programming Instructions .....	5-38
Interleaved 2 of 5 — continued .....	5-39
Interleaved 2 of 5 Stitching .....	5-39
Minimum Reads .....	5-40
Codabar .....	5-41
Disable/Enable Codabar .....	5-41
Check Character Verification .....	5-41
Check Character Transmit .....	5-42
Length Control .....	5-43
Codabar Length 1, Length 2 Programming Instructions .....	5-44
Quiet Zones .....	5-44
Start/Stop Character Type .....	5-45
Start/Stop Character Transmission .....	5-45
Start/Stop Character Match .....	5-46
Codabar Stitching .....	5-46
Minimum Reads .....	5-47
Code 93 .....	5-48
Disable/Enable Code 93 .....	5-48
Length Control .....	5-49
Code 93 Length 1, Length 2 Programming Instructions .....	5-50
Code 93 Stitching .....	5-51
Minimum Reads .....	5-51
MSI/Plessey .....	5-52
Disable/Enable MSI/Plessey .....	5-52
Check Digit Verification .....	5-52
Check Digit Transmit .....	5-53
Number of Check Characters .....	5-53
Length Control .....	5-54
MSI/Plessey Length 1, Length 2 Programming Instructions .....	5-55
MSI/Plessey Stitching .....	5-56
Minimum Reads .....	5-57
Standard 2 of 5 .....	5-58
Disable/Enable Standard 2 of 5 .....	5-58
Check Digit Verification .....	5-58
Check Digit Transmit .....	5-59
Length Control .....	5-60
Standard 2 of 5 Length 1, Length 2 Programming Instructions .....	5-61
Standard 2 of 5 Stitching .....	5-62

Minimum Reads .....	5-63
Optical and Read Performance Parameters .....	A-1
Scanner Dimensions .....	A-1
Physical Properties .....	A-2
Electrical Parameters .....	A-2
Environmental Parameters .....	A-2
Other Parameters .....	A-2
Standard Cable Pinouts (Primary Interface Cables) .....	B-1
RS-232 .....	B-1
IBM Port 5B/9B/17 .....	B-1
IBM USB .....	B-2
USB & USB Keyboard .....	B-2
Wand Emulation .....	B-2
Keyboard Wedge .....	B-2
Defaults by Symbology .....	D-1
Interface Default Exceptions .....	D-1
IBM Interfaces .....	D-2
RS-232 Wincor/Nixdorf .....	D-2
Wand Emulation .....	D-3
Keyboards .....	D-3
Keyboard Model Cross Reference .....	E-1
Accepting RS-232 Commands .....	F-1

# Chapter 1

## Getting Started

---

The Magellan® 1000i Omni-Directional Imaging Scanner offers hands-free scanning for small, easily handled items and handheld scanning for bulkier items. Its aggressive imaging performance and intuitive operation reduces user training and speeds checkout for better customer service.

### About This Manual

This manual presents advanced user information which includes connection, programming, product and cable specifications, and other useful references. For additional information, such as installation, maintenance, troubleshooting and warranty information, see the Quick Reference Guide (QRG). Copies of other publications for this product are downloadable free of charge from the website listed on the back cover of this manual.

On leaving the factory, units are programmed for the most common terminal and communications settings. If you need to change these settings, custom programming can be accomplished by scanning the bar codes in this guide.

Bold text and a yellow-highlighted background indicates the most common default setting for a feature/option.

### Manual Conventions

The symbols listed below are used in this manual to notify the reader of key issues or procedures that must be observed when using the scanner:



**NOTE**

**Notes contain information necessary for properly diagnosing, repairing and operating the scanner.**



**CAUTION**

**The CAUTION symbol advises you of actions that could damage equipment or property.**

## Connecting the Scanner

The scanner kit you ordered to match your interface should provide a compatible cable for your installation. Use the appropriate instructions below to connect the scanner to the terminal, PC or other host device.

Upon completing the connection via the appropriate interface instructions below, proceed to the [Interface Related Features](#) section of this manual and scan the bar code to select the correct interface type.

**RS-232 Serial Connection** — Turn off power to the terminal/PC and connect the scanner to the terminal/PC serial port via the RS-232 cable as shown in [Figure 1](#). If the terminal will not support POT (Power Off the Terminal) to supply scanner power, use the approved power supply (AC Adapter). Plug the AC Adapter barrel connector into the socket on the RS-232 cable connector and the AC Adapter plug into a standard power outlet.

**Figure 1. RS-232 Serial or USB Connection using A/C Adapter**

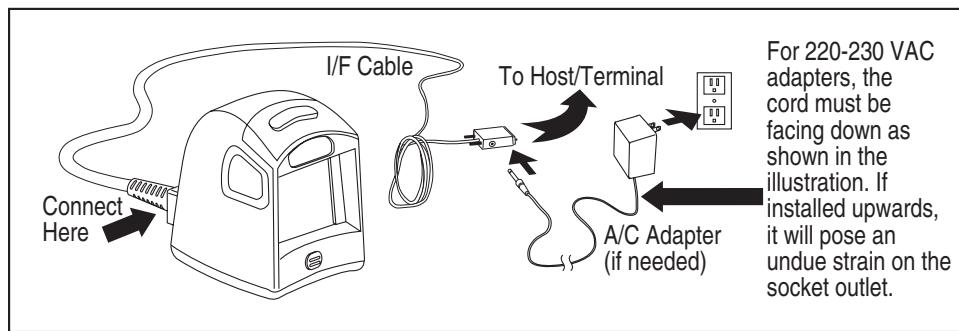

**USB Connection** — Connect the scanner to a USB port on the terminal/PC using the correct USB cable for the interface type you ordered. Reference [Figure 1](#) and [Figure 2](#).



**NOTE**

USB installations may require a power connection via an approved A/C Adapter as shown in [Figure 1](#). For example, this would be the case if the scanner is connected along with a number of other devices to a non-powered USB hub.

**Figure 2. Other Connection Types**

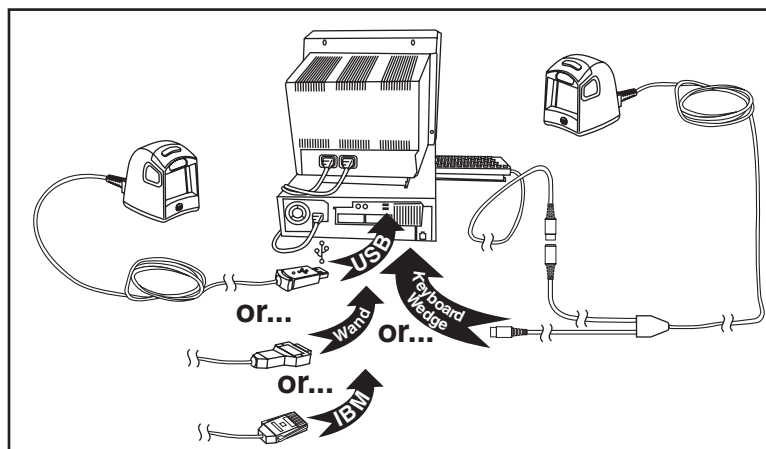



**Wand Emulation Connection** — Connect the scanner to the appropriated port on the terminal/PC using the correct cable for the interface type you ordered. Reference [Figure 2](#).

**IBM Connection** — Connect the scanner to the IBM port on the terminal/PC using the correct IBM cable. Reference [Figure 2](#).

**Keyboard Wedge Connection** — Before connection, turn off power to the terminal/PC. The Keyboard Wedge cable has a ‘Y’ connection from the scanner. Connect the female to the male end from the keyboard and the remaining end at the keyboard port at the terminal/PC. Reference [Figure 2](#).

## Programming

The scanner is typically factory-configured with a set of default features standard to the interface type you ordered. After scanning the interface bar code from the [Interface Related Features](#) section, you can select other options and customize your scanner through use of the instructions and programming bar codes available in that section and also the [Data Editing](#) and [Symbologies](#) chapters of this manual.

### Using the Programming Bar Codes

This manual contains feature descriptions and bar codes which allow you to reconfigure your scanner. Some programming bar code labels, like the label below for resetting defaults, require only the scan of that single label to enact the change. Most of the programming labels in this manual, however, require the scanner to be placed in Programming Mode prior to scanning them. Scan a START/END bar code once to enter Programming Mode. Once the scanner is in Programming Mode, you can scan a number of parameter settings before scanning the START/END bar code a second time, which will then accept your changes, exit Programming Mode and return the scanner to normal operation.

### Resetting the Standard Product Defaults

If you are unsure of what programming options are in your scanner, or you’ve changed some options and want the factory settings restored, scan the *Standard Product Default Settings* bar code below. This will copy the factory configuration for the currently active interface to the current configuration.



Standard Product Default Settings

The programming section lists the factory default settings for each of the menu commands for the standard RS-232 interface in **BOLD** text on the following pages. Exceptions to default settings for the other interfaces can be found in [Appendix D, Default Settings](#).

## LED and Beeper Indicators

The scanner's beeper sounds and its green LED illuminates to indicate various functions or errors on the scanner. The tables below list these indications. One exception to the behaviors listed in the tables is that the scanner's functions are programmable, and may or may not be turned on. For example, certain indications, such as the power-up beep can be disabled using programming bar code labels.

### Green LED Indications

LED INDICATION	INDICATION	COMMENT
Power-on indication	Bright green flash	Indicates the scanner has finished all its power up tests and is now ready for operation.
Good Read Indication	Bright green flash	Indicates a bar code has been read and decoded.
Scanner Ready	Constant dim green	The scanner is ready for operation.
Sleep Mode	Constant green flash (100mS on, 1900mS off)	The scanner is in Sleep Mode. To wake the scanner up, move an object in front of its window or press the button atop the unit.
Host Disable	Constant green flash at 1 Hz (100mS on, 900mS off)	The scanner is disabled due to receiving a disable command from the POS terminal.
Diagnostics	Varies (see "Error Codes" on page 1-5 for more information)	The LED can provide diagnostic feedback if the scanner discovers a problem during SelfTest.

### BEEPER FUNCTIONS

BEEPER INDICATION	INDICATION	COMMENT
Power On Beep	Single beep	The Power-On LED indication is a configurable feature which can be enabled or disabled. When enabled, this beep indicates the scanner has finished all its power up tests and is now ready for operation.
Good Read Indication	Single beep	The good read beep indication is configurable. Options include: Enable/disable, frequency, duration and volume. See the Product Reference Guide (PRG) for more information.
Diagnostics	Varies (see "Error Codes" on page 1-5 for more information)	The Beeper can provide diagnostic feedback if the scanner discovers a problem during SelfTest.
Programming Mode Indications	Varies (see the Product Reference Guide for more information about scanner programming)	The Beeper will sound as programming bar code labels are scanned, indicating progress during scanner configuration.

## Error Codes

Upon startup, if the scanner flashes its indicator LED or sounds an unexpected series of beep tones (other than normal power-up indications), this means the scanner has not passed its automatic Selftest and has entered FRU<sup>1</sup> isolation mode. If the scanner is reset or the trigger is pulled, the sequence will be repeated. The following table describes the LED flashes/beep codes associated with an error found.

NUMBER OF LED FLASHES/ BEEPS	ERROR	CORRECTIVE ACTION
1	Configuration	Contact Helpdesk for assistance
2	Interface PCB	
6	Main PCB	
10	Button Error	
12	Imager Module	
13	Software ID Failure	
14	CPLD/Code Mismatch	

1. Field Replaceable Unit (FRU)

# NOTES

# Chapter 2





## General Features

### Double Read Timeout

The Double Read Timeout feature sets a time limit that determines how much time must pass before reading the same label again (e.g. two identical items in succession).



	START / END
PROGRAMMING BARCODES	
0.1 Second	
	0.2 Second
0.3 Second	
	<b>0.4 Second DEFAULT</b>
0.5 Second	
	0.6 Second

## Double Read Timeout – cont.

	START / END
PROGRAMMING BARCODES	
0.7 Second	
	0.8 Second
0.9 Second	
	1 Second

## Label Gone Timeout

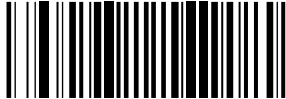
This feature sets the time after the last label segment is seen before the scanner prepares for a new label.

START / END	
PROGRAMMING BARCODES	
Sets the label gone timeout duration using hex values from 000 to 255 in increments of ten milliseconds (10ms or 0.01 seconds). To configure this feature, scan the "START/END" bar code above to place the unit in Programming Mode, then the "Set Label Gone Timeout," followed by the three digits (zero padded) from the Alphanumeric table in <a href="#">Appendix C, Alpha-Numeric Pad</a> representing the desired time value. Exit programming mode by scanning the "START/END" bar code again.	
<b>DEFAULT SETTING FOR THIS FEATURE: 320 milliseconds (032)</b>	
	Set Label Gone Timeout



## Productivity Index Reporting (PIR)

When PIR is enabled, label quality data is appended to decoded data before being presented to the POS. The PIR feature allows the scanner to provide information to an external computer, indicating how easy the label was to read.

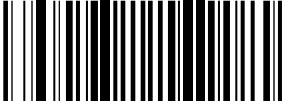

**NOTE**

This value-added feature is a factory-programmed option. Contact your dealer for information about upgrading your system to include this advanced capability.

	START / END
PROGRAMMING BARCODES	
Disable DEFAULT	
	Enable

# Sleep Mode

This feature specifies the amount of time with no bar code reads before the scanner enters sleep mode.

	START / END
PROGRAMMING BARCODES	
15 Seconds	
	30 Seconds
1 Minute	
	2 Minutes
3 Minutes	
	4 Minutes
5 Minutes	





## Sleep Mode – cont.

START / END	
PROGRAMMING BARCODES	
	6 Minutes
7 Minutes	
	8 Minutes
9 Minutes	
	<b>10 Minutes</b> <b>DEFAULT</b>
12 Minutes	
	15 Minutes
30 Minutes	
	1 Hour

# LED and Beeper Indicators

## Power On Alert

Disables or enables the indication (a single beep) that the scanner has finished all its power up tests and is now ready for operation.

	START / END
PROGRAMMING BARCODES	
Disable	
	<b>Enable</b> DEFAULT

## Good Read: When to Indicate





This feature specifies when the scanner will provide indication (beep and/or flash its green LED) upon successfully reading a bar code. Choices are:

- Good Read = Indicate after decode
- Good Read = Indicate after transmit
- Good Read = Indicate after CTS goes inactive, then active



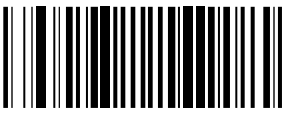

This option (Indicate after CTS goes inactive, then active), which uses CTS, is only valid for RS-232 interfaces.

**NOTE**

	START / END
PROGRAMMING BARCODES	
After Decode DEFAULT	
	After Transmit
After CTS goes inactive, then active	



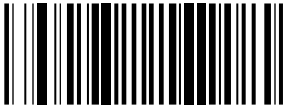

## Good Read Beep Control

This feature enables/disables the scanner's ability to beep upon a successful decode of a bar code.

	START / END
PROGRAMMING BARCODES	
Disable	
	<b>Enable DEFAULT</b>



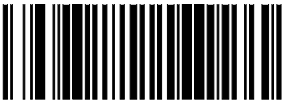

## Good Read Beep Frequency

Adjusts the good read beep to sound at a selectable low, medium or high frequency, selectable from the list below. (Controls the beeper's pitch/tone.)

	START / END
PROGRAMMING BARCODES	
Low	
	<b>Medium DEFAULT</b>
High	

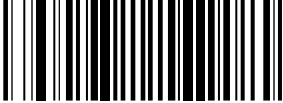



# Good Read Beep Length

Specifies the duration of a good read beep.

	START / END
PROGRAMMING BARCODES	
60msec	
	<b>80msec DEFAULT</b>
100msec	
	120msec
140msec	
	160msec
180msec	
	200msec

## Good Read Beep Volume

Selects the beeper volume (loudness) upon a good read beep. There are three selectable volume levels.

	START / END
PROGRAMMING BARCODES	
Low	
	Medium
High DEFAULT	

# Scanning Features

## Targeted Scanning Mode

Upon pressing the button, the scanner will project an aiming pattern to assist in centering over the bar code. Scanning then takes place as soon as the button is released.



When add-ons are enabled and a bar code is being read while in Targeted Mode, position the pointer at or near the end of the base label to ensure the scanner will read both the base and add-on label.

**NOTE**

Targeted Scanning Mode will read bar codes in any orientation.





The scanner will return to full pattern Omni-directional Mode after [Target Mode Active Time](#) has elapsed.

Configuration options for Targeted Scanning Mode are:

- Target Mode Active Time
- Target Mode Linger Time



## Target Mode Active Time

Specifies the time duration the scanner attempts to decode labels while in the targeted mode of operation.

	START / END
PROGRAMMING BARCODES	
Extra Short Duration	
	Short Duration
<b>Medium Duration DEFAULT</b>	
	Long Duration

## Target Mode Linger Time

Specifies the time duration the scanner remains in the targeted mode of operation after reading a bar code before reverting to Omni-directional Mode.

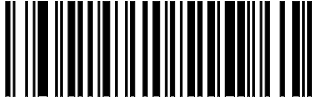
START / END		
PROGRAMMING BARCODES		
		Short Duration
Medium Duration DEFAULT		
		Long Duration







## Wake Up Intensity

This feature indicates the percentage of ambient light change which will trigger the scanner to wake up from Sleep Mode. Lower settings provide greater sensitivity. The selectable range for this setting is 5% to 15%.

	START / END
PROGRAMMING BARCODES	
5%	
	6%
7%	
	8%
9%	
	<b>10% DEFAULT</b>
11%	
	12%

## Wake Up Intensity – cont.

	START / END
PROGRAMMING BARCODES	
13%	
	14%
15%	

# Chapter 3

## Interface Related Features

At the time of this writing, the Scanner supports the interfaces listed in [Table 3-1](#). Select the desired interface type from the table, then reference the page number given for the customizable features section associated with each interface. See [Table 3-2](#) for a description of each Keyboard Wedge interface type (A through Y as listed).

**Table 3-1. Interfaces Supported**

RS-232	Page	Keyboard Wedge	Page
<a href="#">RS-232 Standard</a>	3-9	<a href="#">Keyboard Wedge H<sup>a</sup></a>	
<a href="#">RS-232 Wincor-Nixdorf</a>	3-9	<a href="#">Keyboard Wedge I<sup>a</sup></a>	3-30
IBM		<a href="#">Keyboard Wedge J<sup>a</sup></a>	3-30
<a href="#">IBM 4683 Port 5B</a>	3-24	<a href="#">Keyboard Wedge K<sup>a</sup></a>	3-30
<a href="#">IBM 4683 Port 9B</a>	3-24	<a href="#">Keyboard Wedge L<sup>a</sup></a>	3-30
<a href="#">IBM 4683 Port 17</a>	3-24	<a href="#">Keyboard Wedge M<sup>a</sup></a>	3-30
USB		<a href="#">Keyboard Wedge N<sup>a</sup></a>	3-30
<a href="#">IBM USB</a>	3-24	<a href="#">Keyboard Wedge N<sup>a</sup></a>	3-30
<a href="#">USB Keyboard</a>	3-24	<a href="#">Keyboard Wedge O<sup>a</sup></a>	3-30
Wand Emulation		<a href="#">Keyboard Wedge P<sup>a</sup></a>	3-30
<a href="#">Wand Emulation</a>	3-26	<a href="#">Keyboard Wedge Q<sup>a</sup></a>	3-30
Keyboard Wedge	3-30	<a href="#">Keyboard Wedge R<sup>a</sup></a>	3-30
<a href="#">Keyboard Wedge A<sup>a</sup></a>	3-30	<a href="#">Keyboard Wedge S<sup>a</sup></a>	3-30
<a href="#">Keyboard Wedge B<sup>a</sup></a>	3-30	<a href="#">Keyboard Wedge T<sup>a</sup></a>	3-30
<a href="#">Keyboard Wedge C<sup>a</sup></a>	3-30	<a href="#">Keyboard Wedge U<sup>a</sup></a>	3-30
<a href="#">Keyboard Wedge D<sup>a</sup></a>	3-30	<a href="#">Keyboard Wedge V<sup>a</sup></a>	3-30
<a href="#">Keyboard Wedge E<sup>a</sup></a>	3-30	<a href="#">Keyboard Wedge W<sup>a</sup></a>	3-30
<a href="#">Keyboard Wedge F<sup>a</sup></a>	3-30	<a href="#">Keyboard Wedge X<sup>a</sup></a>	3-30
<a href="#">Keyboard Wedge G<sup>a</sup></a>	3-30	<a href="#">Keyboard Wedge Y<sup>a</sup></a>	3-30

a. Consult [Table](#) for more information regarding keyboard interface types.



**NOTE**

The correct interface cable is included for the scanner interface type you ordered.

**Table 3-2. Keyboard Wedge Interface Reference**

I/F Type	PCs Supported
A	PC/XT w/Alternate Key Encoding
B	AT, PS/2 25-286, 30-286, 50, 50Z, 60, 70, 80, 90 & 95 w/Alternate Key Encoding
C	PS/2 25 and 30 w/Alternate Key Encoding
D	PC/XT w/Standard Key Encoding
E	AT, PS/2 25-286, 30-286, 50, 50Z, 60, 70, 80, 90 & 95 w/Standard Key Encoding
F	PS/2 25 and 30 w/Standard Key Encoding
G	IBM 3xxx w/122 keyboard
H	IBM 3xxx w/102 keyboard
I	PS/55 5530T w/104 keyboard
J	NEC 9801
K	WYSE 30/30+ WY-30 Keyboard 83 Keys
L	WYSE 60/85/99 GT/150/160/285 Style IBM Enhanced PC, 520/520ES Style IBM Enhanced PC FR WYSE 55/65/65 ES/120/185/325 Style IBM Enhanced PC
M	WYSE 60/85/99 GT/150/160/285 ANSI Keyboard 105 Keys, 520/520 ES ANSI Keyboard 105 Keys WYSE 55/65/65 ES/120/185/325 ANSI Keyboard 105 Keys
N	WYSE 60/85/99 GT/150/160/285 ASCII Kbd, 520/520 ES ASCII Kbd WYSE 55/65/65 ES/120/185/325 ASCII Keyboard
O	WYSE 60/85/99 GT/150/160/285 ANSI W285 Keyboard 105 Keys, 520/ 520 ES ANSI W285 Keyboard 105 Keys WYSE 55/65/65 ES/120/185/325 ANSI W285 Keyboard 105 Keys
P	WYSE WINTERM 3320 SE
Q	IBM 3153 IBM 316X, 3179/3180/319X/3270
R	IBM 3151/3152-010, 347X/348X
S	DIGITAL VT 220/320/330/340/350/382
T	DIGITAL VT420
U	DIGITAL VT 510/520 IBM ANSI Style Keyboard
V	DIGITAL VT 510/520 IBM PC Style Keyboard
W	SUN SPARC 5/10
X	SUN 420/440, ITX
Y	WYSE 370/355 Style Enhanced IBM PC

**NOTE**

Reference [Appendix E, Keyboard Function Key Mappings](#) for more information about keyboards.











## Interface Selection

START / END	
PROGRAMMING BARCODES	
	RS-232 Standard
RS-232 Wincor-Nixdorf	
	IBM 4683 Port 5B
IBM 4683 Port 9B	
	IBM 4683 Port 17
IBM USB	
	USB Keyboard
Wand Emulation	
	Keyboard Wedge A

## Interface Selection — cont.

START / END	
PROGRAMMING BARCODES	
	Keyboard Wedge B
Keyboard Wedge C	
	Keyboard Wedge D
Keyboard Wedge E	
	Keyboard Wedge F
Keyboard Wedge G	
	Keyboard Wedge H
Keyboard Wedge I	
	Keyboard Wedge J

## Interface Selection — cont.

	START / END
PROGRAMMING BARCODES	
Keyboard Wedge K	
	Keyboard Wedge L
Keyboard Wedge M	
	Keyboard Wedge N
Keyboard Wedge O	
	Keyboard Wedge P
Keyboard Wedge Q	
	Keyboard Wedge R
Keyboard Wedge S	

## Interface Selection – cont.



	START / END
PROGRAMMING BARCODES	
Keyboard Wedge T	
	Keyboard Wedge U
Keyboard Wedge V	
	Keyboard Wedge W
Keyboard Wedge X	
	Keyboard Wedge Y



## Interface Features

### Obey/Ignore Host Commands

When set to ignore host commands, the scanner will ignore all host commands except for the minimum set necessary to keep the interface active and transmit labels. For normal operation of the interface, select Obey Host Commands.

START / END	
PROGRAMMING BARCODES	
	Obey Host Commands DEFAULT
Ignore Host Commands	

## Interface Features – cont.









### Host Transmission Buffers

Specifies the number of host transmission(s) that may be buffered. By buffering data from a bar code, the scanner can continue to read a new bar code while the old one is being transmitted to the host. Selecting BUFFERS = 1 means that the first bar code must be transmitted before a new one can be read. A selection of BUFFERS = 2 means that a new bar code can be read while data from the first bar code is transmitted.







When a DISABLE SCANNER command is received from the host, the scanner will continue to transmit all data that is buffered.

START / END	
PROGRAMMING BARCODES	
	Host Transmission Buffers = 1
Host Transmission Buffers = 2 DEFAULT	

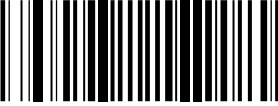
## RS-232 Interface Features

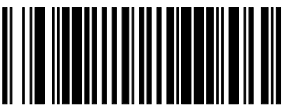
START / END	
PROGRAMMING BARCODES	
	1200 Baud
2400 Baud	
	4800 Baud
<b>9600 Baud DEFAULT</b>	
	19200 Baud
38400 Baud	
	57600 Baud
115200 Baud	

## RS-232 Interface Features – cont.

START / END	
PROGRAMMING BARCODES	
	7 Data Bits
8 Data Bits DEFAULT	
	1 Stop Bit DEFAULT
2 Stop Bits	
	Parity = None DEFAULT
Parity = Even	
	Parity = Odd





## RS-232 Interface Features — cont.

### Hardware Flow Control

**Disable Hardware Control**— The scanner transmits to the host regardless of any activity on the CTS line.

**Enable CTS Flow Control**— The CTS signal controls transmission of data to the host.

**Enable CTS Scan Control**— The CTS line must be active for the scanner to read and transmit data. While the CTS line is inactive, the scanner remains in a host-disabled state; following a successful label transmission, the CTS signal must transition to inactive and then to active to enable scanning for the next label.

START / END	
PROGRAMMING BARCODES	
	<b>Disable Hardware Control</b> <b>DEFAULT</b>
Enable CTS Flow Control	
	Enable CTS Scan Control



## RS-232 Interface Features – cont.

### Intercharacter Delay

This delay is inserted after each data character transmitted. If the transmission speed is too high, the system may not be able to receive all characters. You may need to adjust the delay to make the system work properly.



START / END	
PROGRAMMING BARCODES	
	Inter-Char Delay = No Delay DEFAULT
Interchar Delay = 10 msec	
	Interchar Delay = 20 msec
Interchar Delay = 30 msec	
	Interchar Delay = 40 msec
Interchar Delay = 50 msec	
	Interchar Delay = 60 msec
Interchar Delay = 70 msec	

### Intercharacter Delay – cont.

START / END	
PROGRAMMING BARCODES	
	Interchar Delay = 80 msec
Interchar Delay = 90 msec	

### Software Flow Control



Disables/Enables software control using XON/XOFF characters.

START / END	
PROGRAMMING BARCODES	
	<b>Disable Software Flow Control DEFAULT</b>
Enable Software Flow Control	

## RS-232 Interface Features – cont.

### Host Echo

When enabled, this feature passes all data through the scanner to the host as it comes in. This feature is used for applications where “daisy chaining” of RS-232 devices onto the same cable is necessary. If, for example, one of the devices in the chain is a terminal where someone is entering data while another person is simultaneously scanning a bar code requiring transmission to the host, the scanner will wait for the RS-232 channel to be quiet for a specified period of time (set via *RS-232 Host Echo Quiet Interval*). The scanner can be set to observe this delay before sending its data in order to avoid RS-232 transmission conflicts.

START / END	
PROGRAMMING BARCODES	
	Disable Host Echo DEFAULT
Enable Host Echo	







## RS-232 Interface Features – cont.

### Host Echo Quiet Interval

This setting specifies the time interval of RS-232 channel inactivity which must transpire before the scanner will break the host echo loop to transmit the bar code data that has just been scanned to the host.

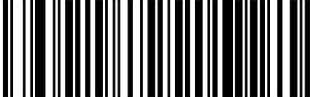

START / END	
PROGRAMMING BARCODES	
	Host Echo Quiet Interval = 0msec
Host Echo Quiet Interval = 10msec DEFAULT	
	Host Echo Quiet Interval = 20msec
Host Echo Quiet Interval = 30msec	
	Host Echo Quiet Interval = 40msec
Host Echo Quiet Interval = 50msec	
	Host Echo Quiet Interval = 60msec
Host Echo Quiet Interval = 70msec	

**Host Echo Quiet Interval – cont.**

START / END	
PROGRAMMING BARCODES	
	Host Echo Quiet Interval = 80msec
Host Echo Quiet Interval = 90msec	
	Host Echo Quiet Interval = 100msec



**Signal Voltage: Normal/TTL**

Specifies whether the RS-232 interface provides TTL levels on the output pins TxD and RTS.

START / END	
PROGRAMMING BARCODES	
	<b>Signal Voltage: Normal RS-232 DEFAULT</b>
Signal Voltage: TTL	

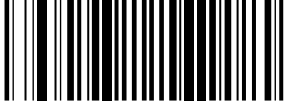

## RS-232 Invert

Enables/disables inversion of RS-232 TXD and RXD signals.

START / END	
PROGRAMMING BARCODES	
	Disable RS-232 Invert DEFAULT
Enable RS-232 Invert	

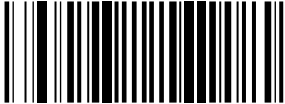

## Beep on ASCII BEL

Enables/disables ability of scanner to beep (sound a good read tone) on receiving an ASCII BEL (07 hex).

START / END	
PROGRAMMING BARCODES	
	Enable Beep on ASCII BEL DEFAULT
Disable Beep on ASCII BEL	

## Beep on Not on File





Select for the host to beep (or not) when a not-on-file (host command) condition is detected by the host.

START / END	
PROGRAMMING BARCODES	
	Disable Beep on Not On File
Enable Beep on Not On File DEFAULT	

## ACK NAK Options

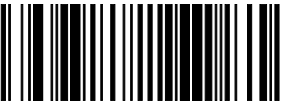

This enables/disables the ability of the scanner to support the RS-232 ACK/NAK protocol. When configured, the scanner and/or host sends an “ACK” when it receives data properly, and sends “NAK” when the data is in error. Selections for this option are:

- Disable
- Enable for label transmission — the scanner expects an ACK/NAK response from the host when a label is sent
- Enable for host-command acknowledge — the scanner will respond with ACK/NAK when the host sends a command
- Enable for label transmission and host-command acknowledge



START / END	
PROGRAMMING BARCODES	
	<b>Disable ACK NAK DEFAULT</b>
Enable ACK NAK for Transmission	
	Enable ACK NAK for host command acknowledge
Enable ACK NAK for transmission and host command	

## RS-232 Interface Features – cont. – cont.

### ACK Character

START / END	
<b>PROGRAMMING BARCODES</b>	
<p>Sets the ACK character from the set of ASCII characters or any decimal value from 000 to 255. Pad entries of less than three digits with zeros, as in "005". To configure this feature, scan the "START/END" bar code above to place the unit in Programming Mode, then the "Set ACK Character," followed by the digits from the Alphanumeric table in <a href="#">Appendix C, Alpha-Numeric Pad</a> representing your desired character. Exit programming mode by again scanning the "START/END" barcode above.</p> <p style="text-align: center;"><b>DEFAULT SETTING FOR THIS FEATURE: 006</b></p>	
	Set ACK Character



### NAK Character

START / END	
<b>PROGRAMMING BARCODES</b>	
<p>Sets the NAK character from the set of ASCII characters or any decimal value from 000 to 255. Pad entries of less than three digits with zeros, as in "005". To configure this feature, scan the "START/END" bar code above to place the unit in Programming Mode, then the "Set NAK Character," followed by the digits from the Alphanumeric table in <a href="#">Appendix C, Alpha-Numeric Pad</a> representing your desired character. Exit programming mode by again scanning the "START/END" barcode above.</p> <p style="text-align: center;"><b>DEFAULT SETTING FOR THIS FEATURE: 021</b></p>	
	Set NAK Character



## RS-232 Interface Features – cont.

### Retry on ACK NAK Timeout

Enables/disables retry after the configurable ACK NAK Timeout Value (set in the following feature) has expired.

START / END	
PROGRAMMING BARCODES	
	Disable Retry on ACK NAK Timeout
Enable Retry on ACK NAK Timeout DEFAULT	

### ACK NAK Timeout Value

START / END	
PROGRAMMING BARCODES	
<p>This item specifies the time the scanner will wait for an ACK character from the host following a label transmission.</p> <p>000 = Infinite timeout  001 - 075 = Timeout in 200-millisecond increments</p> <p>To configure this feature, scan the “START/END” bar code above to place the unit in Programming Mode, then the “Set ACK NAK Timeout Value,” followed by the three digits (zero padded) from the Alphanumeric table in <a href="#">Appendix C, Alpha-Numeric Pad</a> representing your desired value. Exit programming mode by again scanning the “START/END” barcode above.</p> <p style="text-align: center;"><b>DEFAULT SETTING FOR THIS FEATURE: 001 (200 msec)</b></p>	
	Set ACK NAK Timeout Value

## RS-232 Interface Features – cont.

### ACK NAK Retry Count

START / END



#### PROGRAMMING BARCODES

This feature sets the number of times for the scanner to retry a label transmission under a retry condition.

000 = No retry

001 - 254 = Retry for the specified number of times

255 = Retry forever

To configure this feature, scan the “START/END” bar code above to place the unit in Programming Mode, then the “Set ACK NAK Retry Count,” followed by the three digits (zero padded) from the Alphanumeric table in [Appendix C, Alpha-Numeric Pad](#) representing your desired retry count. Exit programming mode by again scanning the “START/END” barcode above

**DEFAULT SETTING FOR THIS FEATURE: 003**



Set ACK NAK Timeout Value







## ACK NAK Error Handling

This item specifies the method the scanner will use to handle errors detected while waiting to receive the ACK character from the host. Errors include unrecognized host commands and communication errors such as parity or framing errors. Choices are:

00 = Ignore errors detected (recommended setting)

01 = Process error as valid ACK character (risk of lost label data)



02 = Process error as valid NAK character (risk of duplicate label data)

START / END	
PROGRAMMING BARCODES	
	<b>Ignore Errors Detected DEFAULT</b>
Process error as valid ACK character	
	Process error as valid NAK character

## RS-232 Interface Features – cont.

### Transmission Failure Indication

Enables/disables bad-label indication upon transmission failure.

START / END	
PROGRAMMING BARCODES	
	Disable Transmission Error Indication
Enable Transmission Error Indication DEFAULT	



## IBM-USB Interface Features

### IBM-USB Device usage

The IBM-USB protocol allows for the scanner to be identified as one of two different types of bar code scanners. Depending on what other scanners you may already have connected to a IBM-USB POS, you may need to change this setting to enable all devices to communicate.

Options are:



- Table Top Scanner
- Handheld Scanner

START / END	
PROGRAMMING BARCODES	
	Configure as Table Top Scanner
Configure as Handheld Scanner DEFAULT	

## IBM

### IBM Transmit Labels in Code 39 Format

This feature enables/disables scanner's ability to set a symbology identifier for a specified label to Code 39 before transmitting that label data to an IBM host. This applies to: Code 128, Codabar and Code 93 for IBM USB; Code 128, Codabar and Code 93 for IBM Port 5B; and Codabar and Code 93 for IBM Port 9B.

START / END	
PROGRAMMING BARCODES	
	Disable Convert to Code 39 DEFAULT
Enable Convert to Code 39	

## Wand Emulation

### Supported Symbologies

The Wand Emulation interface will transmit bar code data as a wand device would. This interface will transmit the following bar code symbologies:

- UPC/EAN
- UPC/EAN with add-ons
- Code 39
- Full ASCII Code 39
- Interleaved 2 of 5
- Codabar
- Code 128

Pharmacode 39 is transmitted as Code 39. All other bar code symbology types read by the scanner will be transmitted as Code 128.

### Wand Emulation Bar Code Format

The following format settings are required for the wand emulation interface. These settings have been pre-configured at the factory for Wand Emulation scanners.



- UPC-A bar codes must include all 12 digits.
- UPC-E bar codes must contain 8 digits, including a system digit, 6 data digits, and the check digit.
- EAN-13 bar codes must have all 13 digits.
- EAN-8 bar codes must include all 8 digits.
- Code 39, Code 39 Full ASCII, and Pharmacode 39 bar codes must NOT contain start / stop characters.
- Codabar bar codes must include the start / stop characters, presented in the ABCD format.
- Interleaved 2 of 5 bar codes must have an even number of digits.

## Wand Emulation – cont.

### Bar/Space Polarity

Low/High — Black will be transmitted as a low voltage level (0 to +0.7V) and space as high level (+2.4 to +5.25V).

High/Low — Black will be transmitted as a high voltage level (+2.4 to +5.25V) and space as low level (0 to +0.7V).



START / END	
PROGRAMMING BARCODES	
	Bar/Space = Low/High
Bar/Space = High/Low DEFAULT	

### Wand Idle State

This feature specifies the level of the wand output signal when idle. TTL logic levels:

High voltage level (+2.4 to +5.25V)

Low voltage level (0 to +0.7V).

START / END	
PROGRAMMING BARCODES	
	Wand Idle State = Low DEFAULT
Wand Idle State = High	



## Wand Emulation – cont.

### Signal Speed

The speed of the transmission can be set. This selects the width of the minimum narrow bar.

330 microseconds

660 microseconds

START / END	
PROGRAMMING BARCODES	
	Signal Speed = 330mS
Signal Speed = 660mS DEFAULT	

### Transmit Trailing Noise

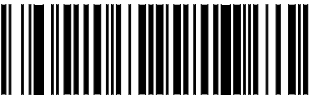

The transmission of noise pulses after the label may be enabled or disabled.

START / END	
PROGRAMMING BARCODES	
	Disable Trailing Noise
Enable Trailing Noise DEFAULT	

## Wand Emulation – cont.

### Transmit Leading Noise

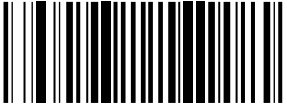
The transmission of noise pulses before the bar code may be enabled or disabled.

START / END	
PROGRAMMING BARCODES	
	Disable Leading Noise
Enable Leading Noise DEFAULT	





### Symbology Conversion

Wand Emulation can convert all bar codes to a single symbology. Choices are:

No Conversion

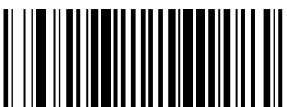
Convert to Code 39

Convert to Code 128

START / END	
PROGRAMMING BARCODES	
	No Symbology Conversion DEFAULT
Convert to C39	
	Convert to C128

# Keyboard Wedge and USB Keyboard

As a keyboard interface, the scanner supports most popular PCs and IBM terminals. The installation of the wedge is a fairly simple process that doesn't require any changes of software or hardware.



**NOTE**

All of the options in this section apply to the Keyboard Wedge, however, only some apply to USB Keyboard.

### Keyboard Layout

The Keyboard Layout option supports many countries. For details about Keyboard Layout, please refer to your operating system manual.

START / END		
PROGRAMMING BARCODES		
		USA DEFAULT
Belgium		
		Britain
Denmark		
		France
Germany		



## Keyboard Wedge – cont.



START / END	
PROGRAMMING BARCODES	
	Italy
Norway	
	Portugal
Spain	
	Sweden
Switzerland	
	Japan 106 Key
Hungary	
	Czech

## Keyboard Wedge – cont.

START / END	
PROGRAMMING BARCODES	
	Slovakia
Romania	
	Croatia
Poland	

### Caps Lock State

Specifies the format in which the scanner sends character data.

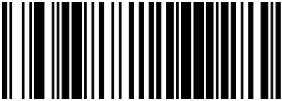
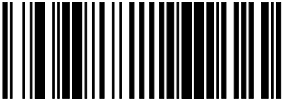
START / END	
PROGRAMMING BARCODES	
	<b>Disable Caps Lock DEFAULT</b>
Caps Lock "ON"	
	Shift Lock "ON"

## Keyboard Wedge – cont.



### Power-On Simulation



This feature does not apply to the USB Keyboard interface.

#### NOTE



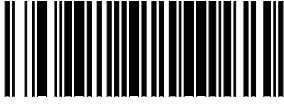

All PCs check the keyboard status during the power-on Selftest. It is recommended that you enable this function if you are working without a keyboard installation. It simulates keyboard timing and passes the keyboard status to the PC during power-on.

START / END	
PROGRAMMING BARCODES	
	Disable Power-on Simulation DEFAULT
Enable Power-on Simulation	

**Control Characters**

Specifies how the scanner transmits ASCII control characters to the host. Choices are:

- Disable Control Characters
- Enable transmission of control characters to host
- Send characters between 00H and 1FH according to a special function-key mapping table. (This is used to send keys that are not in the normal ASCII set; a unique set is provided for each available scancode set. Reference [Appendix E, Keyboard Function Key Mappings.](#))

START / END	
PROGRAMMING BARCODES	
	<b>Disable Control Characters</b> <b>DEFAULT</b>
Enable Transmission of Control Characters	
	Enable Function Key Mapping

## Keyboard Wedge – cont.



### Wedge Quiet Interval



#### NOTE

This feature does not apply to the USB Keyboard interface.

Quiet Interval is the amount of time to look for keyboard activity before the scanner breaks the keyboard connection in order to transmit data to the host.

START / END	
<b>PROGRAMMING BARCODES</b>	
<p>Selectable from 000 (no interval) to 255 in 10 msec increments. To configure this feature, scan the “START/END” bar code above to place the unit in Programming Mode, then the <a href="#">Set Wedge Quiet Interval</a> bar code followed by the three digits (zero padded) from the Alphanumeric table in <a href="#">Appendix C. Alpha-Numeric Pad</a> representing your desired length. Exit programming mode by again scanning the “START/END” barcode above.</p>	
<p><b>DEFAULT SETTING FOR THIS FEATURE:</b> 010 (100 msec)</p>	
	Set Wedge Quiet Interval

## Keyboard Wedge – cont.

### Intercharacter Delay



**NOTE**

This feature does not apply to the USB Keyboard interface.

START / END



#### PROGRAMMING BARCODES

One-half of the delay specified below is inserted between scancodes within each character. If the transmission speed is too high, the system may not be able to receive all characters. You may need to adjust the delay to make the system work properly. Selectable from 000 to 255 in 10msec increments.

To configure this feature, scan the “START/END” bar code above to place the unit in Programming Mode, then the “Set Intercharacter Delay,” followed by the three digits (zero padded) from the Alphanumeric table in [Appendix C. Alpha-Numeric Pad](#) representing your desired length. Exit programming mode by again scanning the “START/END” barcode above/

#### **DEFAULT SETTING FOR THIS FEATURE:**

**000 (No Delay)**

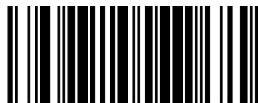

Set Intercharacter Delay

# Chapter 4

## Data Editing

### Data Editing Overview



CAUTION

It is not recommended to use these features with IBM or Wand Emulation interfaces.

When a bar code is scanned, additional information can be sent to the host computer along with the bar code data. This combination of bar code data and supplementary user-defined data is called a “message string.” The features in this chapter can be used to build specific user-defined data into a message string.

There are several types of selectable data characters that can be sent before and after scanned data. You can specify if they should be sent with all symbologies, or only with specific symbologies. [Figure 4-1](#) shows the available elements you can add to a message string:

**Figure 4-1. Breakdown of a Message String**

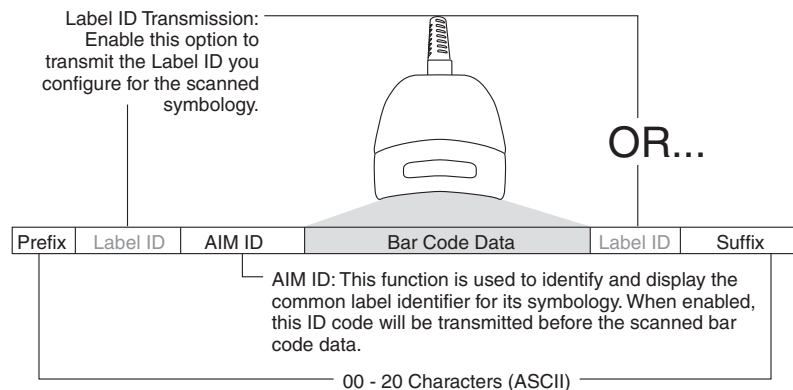

### Please Keep In Mind...

- Modifying a message string is not a mandatory requirement. Data editing is sophisticated feature allowing highly customizable output for advanced users. Factory default settings for data editing is typically set to NONE.
- A prefix or suffix may be applied (reference the [Symbologies](#) chapter for these settings) across all symbologies (set via the Global features in this chapter).
- You can add any character from the [ASCII Chart](#) (from 00-FF) on the inside back cover of this manual as a prefix, suffix or Label ID.

- Enter prefixes and suffixes in the order in which you want them to appear on the output.

## Global Prefix/Suffix

Up to 20 ASCII characters may be added as a prefix (in a position before the bar code data) and/or as a suffix (in a position following the bar code data) as indicated in [Figure 4-2](#).

**Figure 4-2. Prefix and Suffix Positions**

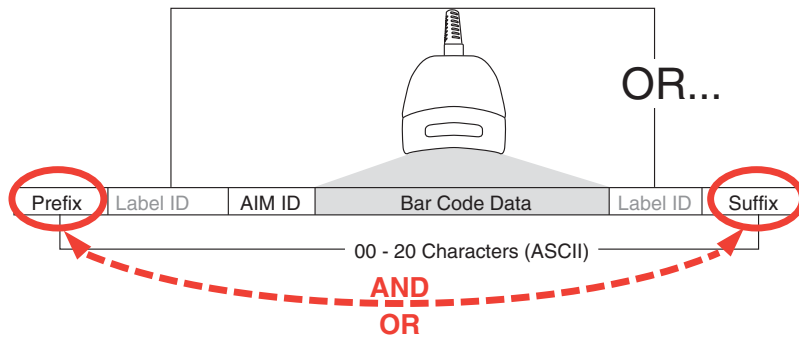

### Example: Setting a Prefix

In this example, we'll set a prefix for all symbologies.

1. Determine which ASCII character(s) are to be added to scanned bar code data. In this example, we'll add a dollar sign ('\$') as a prefix.
2. Scan the START bar code.
3. Scan the SET PREFIX bar code.
4. Reference the [ASCII Chart](#) on the inside back cover of this manual, to find the hex value assigned to the desired character. The corresponding hex number for the '\$' character is 24. To enter this selection code, scan the '2' and '4' bar codes from [Appendix C, Alpha-Numeric Pad](#).
5. Scan the END bar code to exit Programming Mode.





**If less than the expected string of 20 characters are selected, scan the END bar code twice to accept the selections and exit Programming Mode.**

#### NOTE

6. The resulting message string would appear as follows:  
Scanned bar code data:12345  
Resulting message string output: \$12345



## Global Prefix/Suffix – cont.

START / END	
<b>PROGRAMMING BARCODES</b>	
<p>Sets up to 20 characters each from the set of ASCII characters or any hex value from 0 to FF. To configure this feature, scan the “START/END” bar code above to place the unit in Programming Mode, then the “Set Prefix” or “Set Suffix,” followed by the digits from the Alphanumeric table in <a href="#">Appendix C, Alpha-Numeric Pad</a> representing your desired character(s). Reference the section, <a href="#">"Example: Setting a Prefix"</a>, for more information. Exit programming mode by scanning the “START/END” barcode again (scan “START/END” twice if less than 20 characters have been selected).</p> <p style="text-align: center;"><b>DEFAULT SETTING PREFIX: 00 (None)</b> <b>DEFAULT SETTING SUFFIX: 0D (CR)</b></p>	
	Set Prefix
Set Suffix	

# AIM ID

AIM (Automatic Identification Manufacturers) label identifiers are assigned from a globally standardized list — as opposed to custom label ID characters you select yourself — and can be included with scanned bar code data. AIM label identifiers consist of three characters as follows:



- A close brace character (ASCII ‘}’), followed by...
- A code character (see the table below), followed by...
- A modifier character (the modifier character is symbol dependent)

SYMBOLGY	CHAR	SYMBOLGY	CHAR
UPC/EAN	E	Code 128/EAN 128	C
Code 39	A	MSI/Plessey	M
Codabar	F	RSS (RSS-14, RSS Expanded)	e
Interleaved 2 of 5	I	Standard 2 of 5	S
Code 93	G	ISBN	X <sup>a</sup>

a. ISBN (X with a 0 modifier character)

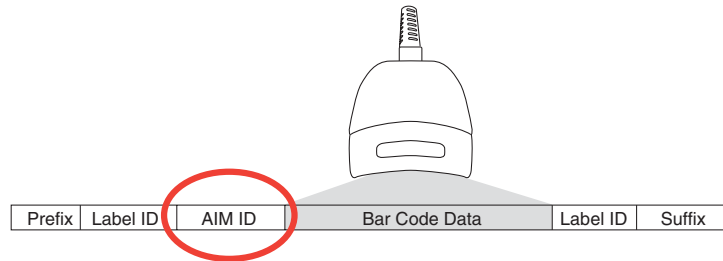
**Figure 4-3. AIM ID**



START / END	
<b>PROGRAMMING BARCODES</b>	
	<b>Disable AIM ID DEFAULT</b>
Enable AIM ID	

## Label ID

A Label ID is a customizable code of up to two ASCII characters (00-FF), used to identify a bar code (symbology) type. See [Appendix D, Default Settings](#), for a listing for common symbologies. It can be appended previous to or following the transmitted bar code data depending upon how this option is enabled. This feature provides options for configuring custom Label IDs individually per symbology. If you wish to program the scanner to always include an industry standard label identifier for ALL symbology types, see the previous feature, [AIM ID](#).

To configure a Label ID:

1. Scan the START bar code.
2. Select Label ID position as either BEFORE or AFTER by scanning the appropriate bar code.
3. Scan a bar code to select the symbology for which you wish to configure a custom Label ID.
4. Determine the desired character(s) (you may choose either one or two) which will represent the Label ID for the selected symbology. Next, turn to the [ASCII Chart](#) on the inside back cover of this manual and find the equivalent hex digits associated with your choice of Label ID. For example, if you wish to select an equal sign (=) as a Label ID, the chart indicates its associated hex characters as 3D.
5. Turn to [Appendix C, Alpha-Numeric Pad](#) and scan the bar codes representing the hex characters determined in the previous step. For the example given, the characters '3' and 'D' would be scanned.
6. Scan the END bar code to exit programming mode.

**Figure 4-4. Label ID Position Options**

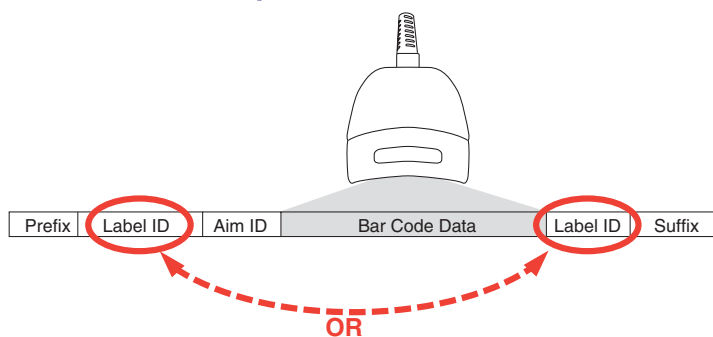

## Label ID – cont.

START / END	
PROGRAMMING BARCODES	
	Label ID Transmission: Disable
Label ID Position: Before Bar Code Data DEFAULT	
	Label ID Position: After Bar Code Data
Set UPC-A Label ID Character(s)	 DEFAULT SETTING FOR THIS FEATURE: A (41 hex)
 DEFAULT SETTING FOR THIS FEATURE: A (41 hex)	Set UPC-A w/P2 Addon Label ID Character(s)
Set UPC-A w/P5 Addon Label ID Character(s)	 DEFAULT SETTING FOR THIS FEATURE: A (41 hex)
 DEFAULT SETTING FOR THIS FEATURE: A (41 hex)	Set UPC-A w/C128 Addon Label ID Character(s)
Set UPC-E Label ID Character(s)	 DEFAULT SETTING FOR THIS FEATURE: E (45 hex)

## Label ID – cont.

START / END	
PROGRAMMING BARCODES	
 <b>DEFAULT SETTING FOR THIS FEATURE: E (45 hex)</b>	Set UPC-E w/P2 Addon Label ID Character(s)
Set UPC-E w/P5 Addon Label ID Character(s)	 <b>DEFAULT SETTING FOR THIS FEATURE: E (45 hex)</b>
 <b>DEFAULT SETTING FOR THIS FEATURE: E (45 hex)</b>	Set UPC-E w/C128 Addon Label ID Character(s)
Set EAN-8 Label ID Character(s)	 <b>DEFAULT SETTING FOR THIS FEATURE: FF (4646 hex)</b>
 <b>DEFAULT SETTING FOR THIS FEATURE: FF (4646 hex)</b>	Set EAN-8 w/P2 Addon Label ID Character(s)
Set EAN-8 w/P5 Addon Label ID Character(s)	 <b>DEFAULT SETTING FOR THIS FEATURE: FF (4646 hex)</b>
 <b>DEFAULT SETTING FOR THIS FEATURE: FF (4646 hex)</b>	Set EAN-8 w/C128 Addon Label ID Character(s)
Set EAN-13 Label ID Character(s)	 <b>DEFAULT SETTING FOR THIS FEATURE: F (46 hex)</b>

## Label ID – cont.

START / END	
<b>PROGRAMMING BARCODES</b>	
 <b>DEFAULT SETTING FOR THIS FEATURE: F (46 hex)</b>	Set EAN-13 w/P2 Addon Label ID Character(s)
Set EAN-13 w/P5 Addon Label ID Character(s)	 <b>DEFAULT SETTING FOR THIS FEATURE: F (46 hex)</b>
 <b>DEFAULT SETTING FOR THIS FEATURE: F (46 hex)</b>	Set EAN-13 w/C128 Addon Label ID Character(s)
Set ISBN Label ID Character(s)	 <b>DEFAULT SETTING FOR THIS FEATURE: I (49 hex)</b>
 <b>DEFAULT SETTING FOR THIS FEATURE: IA (4941 hex)</b>	Set IATA Label ID Character(s)
Set GTIN Label ID Character(s)	 <b>DEFAULT SETTING FOR THIS FEATURE: G (47 hex)</b>
 <b>DEFAULT SETTING FOR THIS FEATURE: G2 (4732 hex)</b>	Set GTIN w/P2 addon Label ID Character(s)
Set GTIN w/P5 addon Label ID Character(s)	 <b>DEFAULT SETTING FOR THIS FEATURE: G5 (4735 hex)</b>

## Label ID – cont.

START / END	
PROGRAMMING BARCODES	
 <b>DEFAULT SETTING FOR THIS FEATURE: G8 (4738 hex)</b>	Set GTIN w/C128 addon Label ID Character(s)
Set RSS-14 Label ID Character(s)	 <b>DEFAULT SETTING FOR THIS FEATURE: R4 (5234 hex)</b>
 <b>DEFAULT SETTING FOR THIS FEATURE: RX (5258 hex)</b>	Set RSS Expanded Label ID Character(s)
Set Code 39 Label ID Character(s)	 <b>DEFAULT SETTING FOR THIS FEATURE: * (2A hex)</b>
 <b>DEFAULT SETTING FOR THIS FEATURE: A (41 hex)</b>	Set Pharmacode 39 Label ID Character(s)
Set Code 128 Label ID Character(s)	 <b>DEFAULT SETTING FOR THIS FEATURE: # (23 hex)</b>
 <b>DEFAULT SETTING FOR THIS FEATURE: i (69 hex)</b>	Set I 2 of 5 Label ID Character(s)

## Label ID – cont.

START / END	
PROGRAMMING BARCODES	
 <b>DEFAULT SETTING FOR THIS FEATURE: % (25 hex)</b>	Set Codabar Label ID Character(s)
Set Code 93 Label ID Character(s)	 <b>DEFAULT SETTING FOR THIS FEATURE: &amp; (26 hex)</b>
 <b>DEFAULT SETTING FOR THIS FEATURE: @ (40 hex)</b>	Set Code 11 Label ID Character(s)
Set MSI/Plessey Label ID Character(s)	 <b>DEFAULT SETTING FOR THIS FEATURE: @ (40 hex)</b>
 <b>DEFAULT SETTING FOR THIS FEATURE: s (73 hex)</b>	Set Std 2 of 5 Label ID Character(s)
Set EAN UCC Composite Label ID Character(s)	 <b>DEFAULT SETTING FOR THIS FEATURE: 0</b>







## Case Conversion

This feature can convert scanned bar code data to either all lower case (a through z) or all upper case (A through Z) characters.



### NOTE

Case conversion affects **ONLY** scanned bar code data, and does not affect Label ID, Prefix, Suffix, or other appended data.

START / END	
PROGRAMMING BARCODES	
	Disable DEFAULT
Convert to Upper Case	
	Convert to Lower Case

# Character Conversion

Character conversion is an eight byte configuration item. The eight bytes are 4 character pairs represented in hexadecimal ASCII values. The first character in the pair is the character that will be converted. The second character in the pair is the character to convert to. If the character to convert in a pair is **FE**, then no conversion is done.

For example, if you have the character conversion configuration item set to the following:

**41423132FFFFFF**

The first pair is **4142** or AB (**41** hex is an ASCII capital A, **42** hex is an ASCII capital B) and the second pair is **3132** or 12 (**31** hex is an ASCII 1, **32** is an ASCII 2). The other two pairs are **FFFF** and **FFFF**.

With the label, AG15TA81, it would look as follows after the character conversion:  
BG25TB82.

The A characters were converted to the B character and the 1 characters were converted to the numeral 2 character. Nothing is done with the last two character pairs, since they are all **FE**.



To set Character Conversion:

1. Scan the START/END bar code.
2. Scan the Character Conversion bar code.
3. Determine the desired string. Up to sixteen positions can be determined as in the above example. Next, turn to the [ASCII Chart](#) on the inside back cover of this manual and find the equivalent hex digits needed to fulfill the string.
4. Turn to [Appendix C, Alpha-Numeric Pad](#) and scan the bar codes representing the hex characters determined in the previous step.
5. Scan the START/END bar code to exit Programming Mode.



**If less than the expected string of 16 characters are selected, scan the START/END bar code twice to accept the selections and exit Programming Mode.**

**NOTE**

START / END	
<b>PROGRAMMING BARCODES</b>	
 <b>DEFAULT SETTING FOR THIS FEATURE:</b> <b>FFFFFFFFFFFFFFFF hex (no conversion)</b>	Character Conversion

# Chapter 5

## Symbologies

The scanner supports the following symbologies (bar code types). Options for each symbology are included in this chapter.



- UPC-A
- UPC-E
- EAN-13
- EAN-8
- RSS-14
- RSS Expanded
- Code 39
- Pharmacode 39
- Code 128
- Interleaved 2 of 5
- Codabar
- Code 93
- MSI/Plessey
- Standard 2 of 5

**Factory Defaults** — for the standard RS-232 interface are indicated in bold text throughout this section. Reference [Appendix D, Default Settings](#) for default exceptions for your interface.

### UPC-A

#### Disable/Enable UPC-A

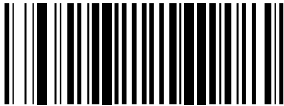

When disabled, the scanner will not read UPC-A bar codes.

START / END	
PROGRAMMING BARCODES	
	Disable UPC-A
Enable UPC-A DEFAULT	

## UPC-A — continued



### Check Digit Transmission

Enable this option to transmit the check digit along with UPC-A bar code data.

START / END	
PROGRAMMING BARCODES	
	Don't Send Check Digit
Send Check Digit DEFAULT	

### Expand UPC-A to EAN-13

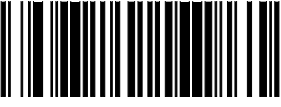

Expands UPC-A data to the EAN-13 data format. Selecting this feature also changes the symbology ID to match those required for EAN-13.

START / END	
PROGRAMMING BARCODES	
	Don't Expand to EAN-13 DEFAULT
Expand to EAN-13	

## UPC-A – continued



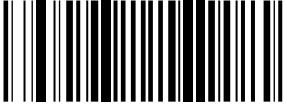

### Number System Transmission

This feature enables/disables transmission of UPC-A System Number.

START / END	
PROGRAMMING BARCODES	
	Disable Number System Transmission
Enable Number System Transmission DEFAULT	

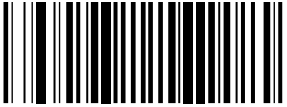
### UPC-A Minimum Reads





This feature specifies the minimum number of consecutive times a UPC-A label must be decoded before it is accepted as good read.

START / END	
PROGRAMMING BARCODES	
	Minimum = 1 Read DEFAULT
Minimum = 2 Reads	
	Minimum = 3 Reads
Minimum = 4 Reads	

# UPC-A — continued

## UPC-A In-store Minimum Reads

This feature specifies the minimum number of consecutive times an in-store printed label must be decoded before it is accepted as good read.



START / END	
PROGRAMMING BARCODES	
	Minimum = 1 Read DEFAULT
Minimum = 2 Reads	
	Minimum = 3 Reads
Minimum = 4 Reads	

## UPC-E

The following options apply to the UPC-E symbology.

### Disable/Enable UPC-E

When disabled, the scanner will not read UPC-E bar codes.

START / END	
PROGRAMMING BARCODES	
	Disable UPC-E
Enable UPC-E DEFAULT	

### Check Digit Transmission

Enable this option to transmit the check digit along with UPC-E bar code data.

START / END	
PROGRAMMING BARCODES	
	Don't Send Check Digit
Send Check Digit DEFAULT	

## UPC-E — continued

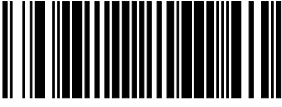
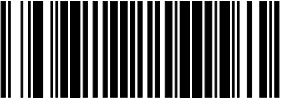

### Number System Digit

The Number System Digit (NSD) which is always a zero (0) in the leading position can be optionally included (or not) with scanned bar code data.

START / END	
PROGRAMMING BARCODES	
	Exclude Number System Digit DEFAULT
Include Number System Digit	

### Expand to UPC-E to UPC-A

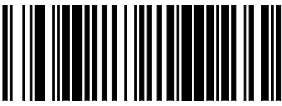
Enables/disables expansion of UPC-E labels to UPC-A. Selecting this feature also changes the symbology ID to match those required for UPC-A.



START / END	
PROGRAMMING BARCODES	
	Don't Expand UPC-E to UPC-A DEFAULT
Expand UPC-E to UPC-A	



## UPC-E – continued



### Expand UPC-E to EAN13

Enables/disables expansion of UPC-E labels to EAN-13. Selecting this feature also changes the symbology ID to match those required for EAN-13.

START / END	
PROGRAMMING BARCODES	
	<b>Don't Expand UPC-E to EAN-13 DEFAULT</b>
Expand UPC-E to EAN-13	

### Minimum Reads

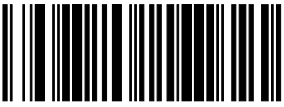
This feature specifies the minimum number of consecutive times a UPC-E label must be decoded before it is accepted as good read.



START / END	
PROGRAMMING BARCODES	
	Minimum = 1 Read
<b>Minimum = 2 Reads DEFAULT</b>	
	Minimum = 3 Reads
Minimum = 4 Reads	

## GTIN

The following options apply to the GTIN label data format.

### Expand UPC/EAN to GTIN

When this feature is enabled, the scanner will translate UPC/EAN labels to the 14 digit GTIN format.



START / END	
PROGRAMMING BARCODES	
	Don't Expand to GTIN DEFAULT
Expand to GTIN	

## EAN-13

The following options apply to the EAN-13 symbology.



### Disable/Enable EAN-13

When disabled, the scanner will not read EAN-13 bar codes.

START / END	
PROGRAMMING BARCODES	
	Disable EAN-13
Enable EAN-13 DEFAULT	

### Check Digit Transmission



Enable this option to transmit the check digit along with EAN-13 bar code data.

START / END	
PROGRAMMING BARCODES	
	Don't Send Check Digit
Send Check Digit DEFAULT	

# EAN-13 – continued

## EAN-13 Flag 1 Character

Enables/disables transmission of an EAN/JAN13 Flag1 character.

START / END	
PROGRAMMING BARCODES	
	Don't Transmit EAN-13 Flag 1 Char
Transmit EAN-13 Flag 1 Char DEFAULT	



## ISBN

When enabled, this feature truncates the leading three digits from labels that contain ISBN (International Standard Book Number) and appends an ISBN check character to the end of the label. These codes are used for books and magazines. Labels with ISBN codes start with "978".

**Example:**

Bar code data: "9789572222720"





Output: "9572222724"

START / END	
PROGRAMMING BARCODES	
	Disable ISBN DEFAULT
Enable ISBN	

## EAN-13 – continued

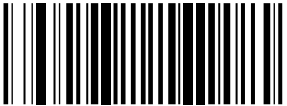
### Minimum Reads

This feature specifies the minimum number of consecutive times an EAN-13 label must be decoded before it is accepted as good read.



START / END	
PROGRAMMING BARCODES	
	<b>Minimum = 1 Read DEFAULT</b>
Minimum = 2 Reads	
	Minimum = 3 Reads
Minimum = 4 Reads	

# EAN-8

The following options apply to the EAN-8 symbology.



## Disable/Enable EAN-8

When disabled, the scanner will not read EAN-8 bar codes.

START / END	
PROGRAMMING BARCODES	
	Disable EAN-8
Enable EAN-8 DEFAULT	

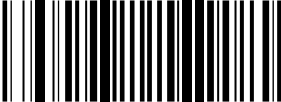

## Check Digit Transmission

Enable this option to transmit the check Digit along with EAN-8 bar code data.

START / END	
PROGRAMMING BARCODES	
	Don't Send Check Digit
Send Check Digit DEFAULT	



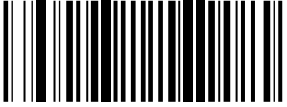

## EAN-8 – continued

**Expand EAN-8 to EAN-13** – Expands EAN-8 data to the EAN-13 data format. Selecting this feature also changes the symbology ID to match those required for EAN-13.

START / END	
PROGRAMMING BARCODES	
	<b>Don't Expand to EAN-13 DEFAULT</b>
Expand to EAN-13	

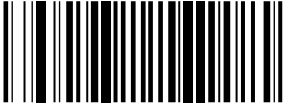

## Minimum Reads

This feature specifies the minimum number of consecutive times an EAN-8 label must be decoded before it is accepted as good read.

START / END	
PROGRAMMING BARCODES	
	<b>Minimum = 1 Read DEFAULT</b>
Minimum = 2 Reads	
	Minimum = 3 Reads
Minimum = 4 Reads	

## Enable EAN Two-Label

Enables/disables the ability of the scanner to decode EAN two-label pairs.

START / END	
PROGRAMMING BARCODES	
	Disable EAN Two-Label
Enable EAN Two-Label	



---

## Add-ons

Add-ons (or supplemental characters) are commonly added to the end of UPC/EAN bar codes. The scanner will read the add-ons if they are enabled and in the field of view. Three add-on types are supported: 2-digit, 5-digit and Code 128 add-ons. Supported options are:

**None** — This option directs the scanner to ignore add-on portion of a UPC/EAN bar code but still read the main portion of the bar code.

**2 Digits** — The scanner will optionally read 2-digit add-ons with the UPC/EAN label.

**5 Digits** — The scanner will optionally read 5-digit add-ons with the UPC/EAN label.

**Code 128 Add-on** — The scanner will optionally read Code 128 add-ons with the UPC/EAN label.



NOTE

**Contact Customer Support for advanced programming of optional and conditional add-ons.**

# Add-ons — continued



START / END	
<b>PROGRAMMING BARCODES</b>	
	<b>Disable Optional 2-Digit Add-ons DEFAULT</b>
Enable Optional 2-Digit Add-ons	
	<b>Disable Optional 5-Digit Add-ons DEFAULT</b>
Enable Optional 5-Digit Add-ons	
	<b>Disable Optional Code 128 Add-ons DEFAULT</b>
Enable Optional Code 128 Add-ons	

## RSS-14

The following options apply to the RSS-14 symbology.



### Disable/Enable RSS-14

When this feature is disabled, the scanner will not read RSS-14 bar codes.

START / END	
PROGRAMMING BARCODES	
	Disable RSS-14 DEFAULT
Enable RSS-14	

### UCC/EAN 128 Emulation

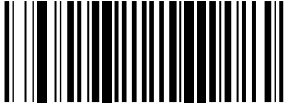



When enabled, RSS-14 bar codes will be translated to the UCC/EAN 128 label data format.

START / END	
PROGRAMMING BARCODES	
	Disable UCC/EAN 128 Emulation DEFAULT
Enable UCC/EAN 128 Emulation	

# RSS-14 – continued

## Minimum Reads

This feature specifies the minimum number of consecutive times an RSS-14 label must be decoded before it is accepted as good read.

START / END	
PROGRAMMING BARCODES	
	Minimum = 1 Read DEFAULT
Minimum = 2 Reads	
	Minimum = 3 Reads
Minimum = 4 Reads	

## RSS Expanded

The following options apply to the RSS Expanded symbology.



### Disable/Enable RSS Expanded

When this feature is disabled, the scanner will not read RSS Expanded bar codes.

START / END	
PROGRAMMING BARCODES	
	Disable RSS Expanded DEFAULT
Enable RSS Expanded	

### UCC/EAN 128 Emulation

When enabled, RSS Expanded bar codes will be translated to the UCC/EAN 128 label data format.

START / END	
PROGRAMMING BARCODES	
	Disable UCC/EAN 128 Emulation DEFAULT
Enable UCC/EAN 128 Emulation	

# RSS Expanded — continued

## Length Control

**Fixed Length Decoding** — When fixed length decoding is enabled, the scanner will decode a bar code if the label length matches one of the configurable fixed lengths.



**Variable Length Decoding** — When variable length decoding is enabled, the scanner will decode a bar code if the label length falls in the range of the configurable minimum and maximum length.

Configuring Fixed Length Decoding:

1. Scan the START/END bar code.
2. Scan the Fixed Length Decoding bar code.
3. Scan the START/END bar code.
4. Set Length 1 to the first fixed length by following the [RSS Expanded Length 1, Length 2 Programming Instructions](#) below.
5. Set Length 2 to the second fixed length (or to '000' if there is only one fixed length) by following the [RSS Expanded Length 1, Length 2 Programming Instructions](#) below.

Configuring Variable Length Decoding:

1. Scan the START/END bar code.
2. Scan the Variable Length Decoding bar code.
3. Scan the START/END bar code.
4. Set Length 1 to the first variable length by following the [RSS Expanded Length 1, Length 2 Programming Instructions](#) below.
5. Set Length 2 to the second variable length by following the [RSS Expanded Length 1, Length 2 Programming Instructions](#) below.

START / END	
PROGRAMMING BARCODES	
	<b>Variable Length Decoding DEFAULT</b>
Fixed Length Decoding	

## RSS Expanded – continued

### RSS Expanded Length 1, Length 2 Programming Instructions



1. Scan the START/END bar code.
2. Scan either the Set Length 1 or Set Length 2 bar code.
3. Turn to [Appendix C, Alpha-Numeric Pad](#) and scan the three digits (zero padded) representing the length in decimal notation.



For RSS Expanded bar codes, only the data characters are included in the length calculations.

#### NOTE





4. Scan the START/END bar code.

START / END	
PROGRAMMING BARCODES	
 <b>DEFAULT SETTING FOR THIS FEATURE: 008</b>	Set Length 1
Set Length 2	 <b>DEFAULT SETTING FOR THIS FEATURE: 014</b>

# RSS Expanded – continued

## Minimum Reads

This feature specifies the minimum number of consecutive times an RSS Expanded label must be decoded before it is accepted as good read.

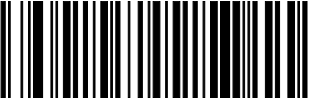
START / END	
PROGRAMMING BARCODES	
	Minimum = 1 Read DEFAULT
Minimum = 2 Reads	
	Minimum = 3 Reads
Minimum = 4 Reads	





## Code 39

The following options apply to the Code 39 symbology.



### Disable/Enable Code 39

When this feature is disabled, the scanner will not read Code 39 bar codes.

START / END	
PROGRAMMING BARCODES	
	Disable Code 39
Enable Code 39 DEFAULT	



### Check Character Calculation

When enabled, the scanner will calculate the check character of the labels. Turn this option on only when a checksum is present in the Code 39 labels.

START / END	
PROGRAMMING BARCODES	
	Disable Check Char Calculation DEFAULT
Enable Check Char Calculation	



## Check Character Transmit

Enable this option to transmit the check character with scanned bar code data.

START / END	
PROGRAMMING BARCODES	
	Disable Check Char Transmission
Enable Check Char Transmission DEFAULT	

## Start/Stop Characters

Enables/disables transmission of Code39 start and stop characters.

START / END	
PROGRAMMING BARCODES	
	Don't Transmit Start/Stop Characters DEFAULT
Transmit Start/Stop Characters	

## Code 39 Full ASCII

Enables/disables the translation of Code 39 characters to Code 39 full-ASCII characters.

START / END	
PROGRAMMING BARCODES	
	Disable Code 39 Full ASCII DEFAULT
Enable Code 39 Full ASCII	

## Code 39 – continued

### Length Control

**Fixed Length Decoding** – When fixed length decoding is enabled, the scanner will decode a bar code if the label length matches one of the configurable fixed lengths.



**Variable Length Decoding** – When variable length decoding is enabled, the scanner will decode a bar code if the label length falls in the range of the configurable minimum and maximum length.

Configuring Fixed Length Decoding:

1. Scan the START/END bar code.
2. Scan the Fixed Length Decoding bar code.
3. Scan the START/END bar code.
4. Set Length 1 to the first fixed length by following the [Code 39 Length 1, Length 2 Programming Instructions](#) below.
5. Set Length 2 to the second fixed length (or to '000' if there is only one fixed length) by following the [Code 39 Length 1, Length 2 Programming Instructions](#) below.

Configuring Variable Length Decoding:

1. Scan the START/END bar code.
2. Scan the Variable Length Decoding bar code.
3. Scan the START/END bar code.
4. Set Length 1 to the first variable length by following the [Code 39 Length 1, Length 2 Programming Instructions](#) below.
5. Set Length 2 to the second variable length by following the [Code 39 Length 1, Length 2 Programming Instructions](#) below.

START / END	
PROGRAMMING BARCODES	
	<b>Variable Length Decoding DEFAULT</b>
Fixed Length Decoding	

## Code 39 Length 1, Length 2 Programming Instructions



1. Scan the START/END bar code.
2. Scan either the Set Length 1 or Set Length 2 bar code.
3. Turn to [Appendix C, Alpha-Numeric Pad](#) and scan the three digits (zero padded) representing the length in decimal notation.



**For Code 39 bar codes, all check, data and full ASCII shift characters are included in the length calculations. Start/Stop characters are not included.**



### NOTE

4. Scan the START/END bar code.

START / END	
PROGRAMMING BARCODES	
 DEFAULT SETTING FOR THIS FEATURE: 003	Set Length 1
Set Length 2	 DEFAULT SETTING FOR THIS FEATURE: 050

## Quiet Zones



This feature enables/disables the requirement that quiet zones must be present for Code 39 bar codes.

START / END	
PROGRAMMING BARCODES	
	Don't require Quiet Zones DEFAULT
Require Quiet Zones	

## Code 39 – continued





### Code 39 Stitching

Enables/disables stitching for Code 39 labels. When parts of a Code 39 bar code are presented to the scanner with this feature enabled, the bar code parts will be assembled by the scanner's software, and the data will be decoded if all bar code proofing requirements are met.

START / END	
PROGRAMMING BARCODES	
	<b>Disable Code 39 Stitching DEFAULT</b>
Enable Code 39 Stitching	

### Minimum Reads

This feature specifies the minimum number of consecutive times a Code 39 label must be decoded before it is accepted as good read.



START / END	
PROGRAMMING BARCODES	
	<b>Minimum = 1 Read DEFAULT</b>
Minimum = 2 Reads	
	Minimum = 3 Reads
Minimum = 4 Reads	

## Pharmacode 39

The following options apply to the Pharmacode 39 symbology.

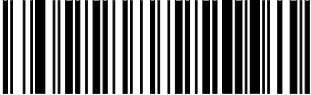

### Disable/Enable Pharmacode 39

When this feature is disabled, the scanner will not read Pharmacode 39 bar codes.

START / END	
PROGRAMMING BARCODES	
	<b>Disable Pharmacode 39 DEFAULT</b>
Enable Pharmacode 39	



### Start/Stop Characters

Enables or disables transmission of Pharmacode 39 start/stop characters.

START / END	
PROGRAMMING BARCODES	
	<b>Don't Transmit Start/Stop Characters DEFAULT</b>
Transmit Start/Stop Characters	

## Check Character Transmit

Enable this option to transmit the check character with scanned bar code data.

START / END	
PROGRAMMING BARCODES	
	Disable Check Char Transmission
Enable Check Char Transmission DEFAULT	





## Code 128

The following options apply to the Code 128 symbology.

### Disable/Enable Code 128

When this feature is disabled, the scanner will not read Code 128 bar codes.



START / END	
PROGRAMMING BARCODES	
	Disable Code 128
Enable Code 128 DEFAULT	

### Transmit Function Characters

Enables/disables transmission of Code128 function characters 1, 2, 3, and 4.

Function codes are transmitted as follows:

- FNC1 = 80 hex
- FNC2 = 81 hex
- FNC3 = 82 hex
- FNC4 = 83 hex

START / END	
PROGRAMMING BARCODES	
	Don't Transmit Function Characters DEFAULT
Transmit Function Characters	

## Code 128 – continued

### Length Control

**Fixed Length Decoding** – When fixed length decoding is enabled, the scanner will decode a bar code if the label length matches one of the configurable fixed lengths.



**Variable Length Decoding** – When variable length decoding is enabled, the scanner will decode a bar code if the label length falls in the range of the configurable minimum and maximum length.

Configuring Fixed Length Decoding:

1. Scan the START bar code.
2. Scan the Fixed Length Decoding bar code.
3. Scan the END bar code.
4. Set Length 1 to the first fixed length by following the [Code 128 Length 1, Length 2 Programming Instructions](#) below.
5. Set Length 2 to the second fixed length (or to '000' if there is only one fixed length) by following the [Code 128 Length 1, Length 2 Programming Instructions](#) below.

Configuring Variable Length Decoding:

1. Scan the START bar code.
2. Scan the Variable Length Decoding bar code.
3. Scan the END bar code.
4. Set Length 1 to the first variable length by following the [Code 128 Length 1, Length 2 Programming Instructions](#) below.
5. Set Length 2 to the second variable length by following the [Code 128 Length 1, Length 2 Programming Instructions](#) below.

START / END	
PROGRAMMING BARCODES	
	<b>Variable Length Decoding DEFAULT</b>
Fixed Length Decoding	

## Code 128 – continued

### Code 128 Length 1, Length 2 Programming Instructions



1. Scan the START bar code.
2. Scan either the Set Length 1 or Set Length 2 bar code.
3. Turn to [Appendix C, Alpha-Numeric Pad](#) and scan the three digits (zero padded) representing the length in decimal notation.



For Code 128 bar codes, only the data characters are included in the length calculations.



#### NOTE

4. Scan the END bar code.

START / END	
PROGRAMMING BARCODES	
 DEFAULT SETTING FOR THIS FEATURE: 001	Set Length 1
Set Length 2	 DEFAULT SETTING FOR THIS FEATURE: 080

### Code 128 Conversion to Code 39

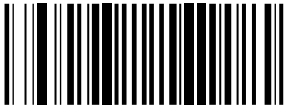

Enables/disables expansion of Code 128 labels to Code 39.

START / END	
PROGRAMMING BARCODES	
 Disable DEFAULT	Disable DEFAULT
Enable	

## Code 128 – continued

### Code 128 Stitching

Enables/disables stitching for Code 128 labels. When parts of a Code 128 bar code are presented to the scanner with this feature enabled, the bar code parts will be assembled by the scanner's software, and the data will be decoded if all bar code proofing requirements are met.

START / END	
PROGRAMMING BARCODES	
	<b>Disable Code 128 Stitching DEFAULT</b>
Enable Code 128 Stitching	

### Minimum Reads

This feature specifies the minimum number of consecutive times a Code 128 label must be decoded before it is accepted as good read.

START / END	
PROGRAMMING BARCODES	
	<b>Minimum = 1 Read DEFAULT</b>
Minimum = 2 Reads	
	Minimum = 3 Reads
Minimum = 4 Reads	

## Interleaved 2 of 5

The following options apply to the Interleaved 2 of 5 (I 2 of 5) symbology.



### Disable/Enable Interleaved 2 of 5

When this feature is disabled, the scanner will not read Interleaved 2 of 5 bar codes.

START / END	
PROGRAMMING BARCODES	
	Disable Interleaved 2 of 5 DEFAULT
Enable Interleaved 2 of 5	

### Check Digit Calculation



When enabled, the scanner will calculate the check digit of the labels.

START / END	
PROGRAMMING BARCODES	
	Disable Check Digit Calculation DEFAULT
Enable Check Digit Calculation	

## Interleaved 2 of 5 – continued

### Check Digit Transmit

Enable this option to transmit the check digit with scanned bar code data.

START / END	
PROGRAMMING BARCODES	
	Disable Check Digit Calculation DEFAULT
Enable Check Digit Calculation	

## Interleaved 2 of 5 – continued

### Length Control

**Fixed Length Decoding** — When fixed length decoding is enabled, the scanner will decode a bar code if the label length matches one of the configurable fixed lengths.



**Variable Length Decoding** — When variable length decoding is enabled, the scanner will decode a bar code if the label length falls in the range of the configurable minimum and maximum length.

Configuring Fixed Length Decoding:

1. Scan the START bar code.
2. Scan the Fixed Length Decoding bar code.
3. Scan the END bar code.
4. Set Length 1 to the first fixed length by following the [Interleaved 2 of 5 Length 1, Length 2 Programming Instructions](#) below.
5. Set Length 2 to the second fixed length (or to '000' if there is only one fixed length) by following the [Interleaved 2 of 5 Length 1, Length 2 Programming Instructions](#) below.

Configuring Variable Length Decoding:

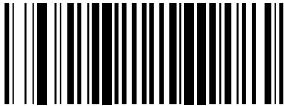
1. Scan the START bar code.
2. Scan the Variable Length Decoding bar code.
3. Scan the END bar code.
4. Set Length 1 to the first variable length by following the [Interleaved 2 of 5 Length 1, Length 2 Programming Instructions](#) below.
5. Set Length 2 to the second variable length by following the [Interleaved 2 of 5 Length 1, Length 2 Programming Instructions](#) below.

START / END	
PROGRAMMING BARCODES	
	<b>Variable Length Decoding DEFAULT</b>
Fixed Length Decoding	

## Interleaved 2 of 5 – continued

### Interleaved 2 of 5 Length 1, Length 2 Programming Instructions



1. Scan the START bar code.
2. Scan either the Set Length 1 or Set Length 2 bar code.
3. Turn to [Appendix C, Alpha-Numeric Pad](#) and scan the three digits (zero padded) representing the length in decimal notation.



**NOTE**

For Interleaved 2 of 5 bar codes, lengths must be an even number. Additionally, all check and data characters are included in the length calculations.

4. Scan the END bar code.

START / END	
PROGRAMMING BARCODES	
 DEFAULT SETTING FOR THIS FEATURE: 006	Set Length 1
Set Length 2	 DEFAULT SETTING FOR THIS FEATURE: 050



## Interleaved 2 of 5 – continued

### Interleaved 2 of 5 Stitching

Enables/disables stitching for Interleaved 2 of 5 labels. When parts of an Interleaved 2 of 5 bar code are presented to the scanner with this feature enabled, the bar code parts will be assembled by the scanner's software, and the data will be decoded if all bar code proofing requirements are met.



Only functions when **Fixed Length Decoding** is enabled.





#### NOTE

START / END	
PROGRAMMING BARCODES	
	Disable Interleaved 2 of 5 Stitching DEFAULT
Enable Interleaved 2 of 5 Stitching	

# Interleaved 2 of 5 – continued

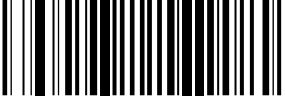
## Minimum Reads

This feature specifies the minimum number of consecutive times an Interleaved 2 of 5 label must be decoded before it is accepted as good read.



START / END	
PROGRAMMING BARCODES	
	Minimum = 1 Read DEFAULT
Minimum = 2 Reads	
	Minimum = 3 Reads
Minimum = 4 Reads	

## Codabar

The following options apply to the Codabar symbology.

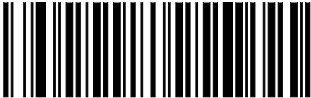

### Disable/Enable Codabar

When this feature is disabled, the scanner will not read Codabar bar codes.

START / END	
PROGRAMMING BARCODES	
	Disable Codabar DEFAULT
Enable Codabar	

### Check Character Verification

When enabled, the scanner will verify the check character of the labels.

START / END	
PROGRAMMING BARCODES	
	Disable Check Char Verification DEFAULT
Enable Check Char Verification	

## Check Character Transmit

Enable this option to transmit the check character with scanned bar code data.

START / END	
PROGRAMMING BARCODES	
	Disable Check Char Transmission
Enable Check Char Transmission DEFAULT	

## Codabar — continued

### Length Control

**Fixed Length Decoding** — When fixed length decoding is enabled, the scanner will decode a bar code if the label length matches one of the configurable fixed lengths.



**Variable Length Decoding** — When variable length decoding is enabled, the scanner will decode a bar code if the label length falls in the range of the configurable minimum and maximum length.

Configuring Fixed Length Decoding:

1. Scan the START bar code.
2. Scan the Fixed Length Decoding bar code.
3. Scan the END bar code.
4. Set Length 1 to the first fixed length by following the [Codabar Length 1, Length 2 Programming Instructions](#) below.
5. Set Length 2 to the second fixed length (or to '000' if there is only one fixed length) by following the [Codabar Length 1, Length 2 Programming Instructions](#) below.

Configuring Variable Length Decoding:

1. Scan the START bar code.
2. Scan the Variable Length Decoding bar code.
3. Scan the END bar code.
4. Set Length 1 to the first variable length by following the [Codabar Length 1, Length 2 Programming Instructions](#) below.
5. Set Length 2 to the second variable length by following the [Codabar Length 1, Length 2 Programming Instructions](#) below.

START / END	
PROGRAMMING BARCODES	
	<b>Variable Length Decoding DEFAULT</b>
Fixed Length Decoding	

# Codabar – continued

## Codabar Length 1, Length 2 Programming Instructions



1. Scan the START bar code.
2. Scan either the Set Length 1 or Set Length 2 bar code.
3. Turn to [Appendix C, Alpha-Numeric Pad](#) and scan the three digits (zero padded) representing the length in decimal notation.



**For Codabar bar codes, all start, stop, check and data characters are included in the length calculations.**



**NOTE**

4. Scan the END bar code.

START / END	
PROGRAMMING BARCODES	
 <b>DEFAULT SETTING FOR THIS FEATURE: 003</b>	Set Length 1
Set Length 2	 <b>DEFAULT SETTING FOR THIS FEATURE: 050</b>

### Quiet Zones





This feature enable/disables the requirement that quiet zones must be present for Codabar bar codes.

START / END	
PROGRAMMING BARCODES	
	<b>Don't require Quiet Zones DEFAULT</b>
Require Quiet Zones	

## Codabar – continued



### Start/Stop Character Type

Codabar has four pairs of Start/Stop patterns. Select one pair to match your application.

START / END		
PROGRAMMING BARCODES		
	Start/Stop Type: ABCD/TN*E	
Start/Stop Type: ABCD/ABCD		
	Start/Stop Type: abcd/tn*e	
Start/Stop Type: abcd/abcd DEFAULT		



### Start/Stop Character Transmission

The transmission of start and end characters of Codabar is selected below.

START / END		
PROGRAMMING BARCODES		
	Disable Start/Stop Char Transmission	
Enable Start/Stop Char Transmission DEFAULT		

## Start/Stop Character Match

This feature enables/disables the requirement that start and stop characters match.

START / END	
PROGRAMMING BARCODES	
	<b>Disable Start/Stop Char Match DEFAULT</b>
Enable Start/Stop Char Match	



## Codabar Stitching

Enables/disables stitching for Codabar labels. When parts of a Codabar label are presented to the scanner with this feature enabled, the bar code parts will be assembled by the scanner's software, and the data will be decoded if all bar code proofing requirements are met.



Only functions when **Fixed Length Decoding** is enabled.

**NOTE**





START / END	
PROGRAMMING BARCODES	
	<b>Disable Codabar Stitching DEFAULT</b>
Enable Codabar Stitching	



## Codabar – continued

### Minimum Reads

This feature specifies the minimum number of consecutive times a Codabar label must be decoded before it is accepted as a good read.



START / END	
PROGRAMMING BARCODES	
	<b>Minimum = 1 Read</b> <b>DEFAULT</b>
Minimum = 2 Reads	
	Minimum = 3 Reads
Minimum = 4 Reads	

## Code 93

The following options apply to the Code 93 symbology.

### Disable/Enable Code 93

When this feature is disabled, the scanner will not read Code 93 bar codes.

START / END	
PROGRAMMING BARCODES	
	Disable Code 93 DEFAULT
Enable Code 93	

## Code 93 — continued

### Length Control

**Fixed Length Decoding** — When fixed length decoding is enabled, the scanner will decode a bar code if the label length matches one of the configurable fixed lengths.



**Variable Length Decoding** — When variable length decoding is enabled, the scanner will decode a bar code if the label length falls in the range of the configurable minimum and maximum length.

Configuring Fixed Length Decoding:

1. Scan the START/END bar code.
2. Scan the Fixed Length Decoding bar code.
3. Scan the START/END bar code.
4. Set Length 1 to the first fixed length by following the [Code 93 Length 1, Length 2 Programming Instructions](#) below.
5. Set Length 2 to the second fixed length (or to '000' if there is only one fixed length) by following the [Code 93 Length 1, Length 2 Programming Instructions](#) below.

Configuring Variable Length Decoding:

1. Scan the START/END bar code.
2. Scan the Variable Length Decoding bar code.
3. Scan the START/END bar code.
4. Set Length 1 to the first variable length by following the [Code 93 Length 1, Length 2 Programming Instructions](#) below.
5. Set Length 2 to the second variable length by following the [Code 93 Length 1, Length 2 Programming Instructions](#) below.

START / END	
PROGRAMMING BARCODES	
	Variable Length Decoding DEFAULT
Fixed Length Decoding	

## Code 93 – continued

### Code 93 Length 1, Length 2 Programming Instructions

1. Scan the START bar code.
2. Scan either the Set Length 1 or Set Length 2 bar code.
3. Turn to [Appendix C, Alpha-Numeric Pad](#) and scan the three digits (zero padded) representing the length in decimal notation.



For Code 93 bar codes, only the data characters are included in the length calculations.

**NOTE**

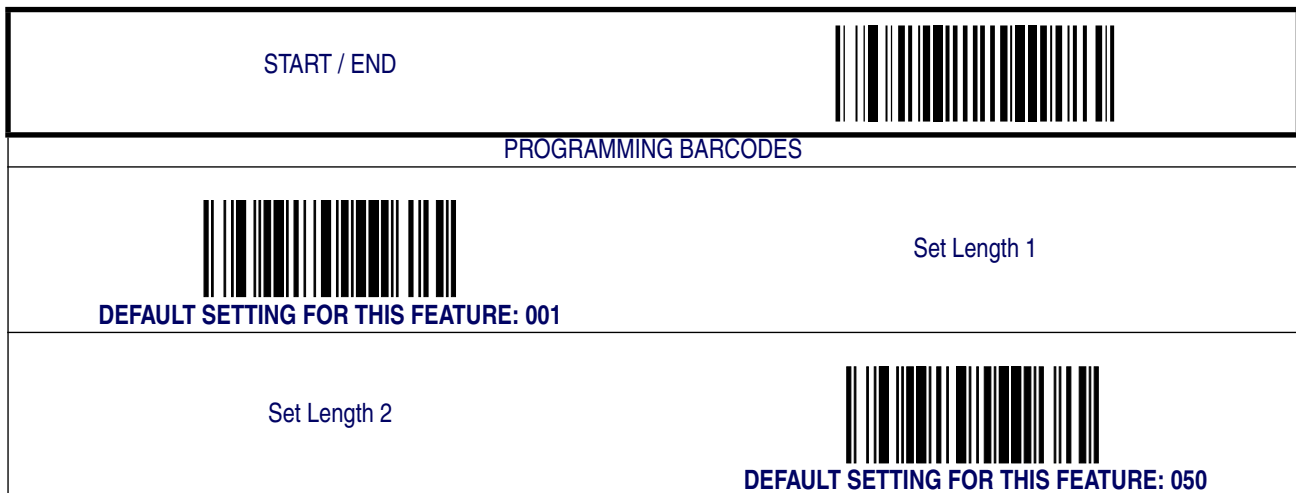

4. Scan the END bar code.



## Code 93 — continued



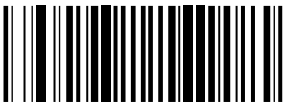

### Code 93 Stitching

Enables/disables stitching for Code 93 bar codes. When parts of a Code 93 label are presented to the scanner with this feature enabled, the bar code parts will be assembled by the scanner's software, and the data will be decoded if all bar code proofing requirements are met.

START / END	
PROGRAMMING BARCODES	
	<b>Disable Code 93 Stitching</b> <b>DEFAULT</b>
Enable Code 93 Stitching	

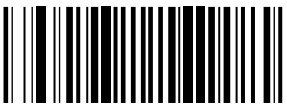
### Minimum Reads

This feature specifies the minimum number of consecutive times a Code 93 label must be decoded before it is accepted as a good read.



START / END	
PROGRAMMING BARCODES	
	<b>Minimum = 1 Read</b> <b>DEFAULT</b>
Minimum = 2 Reads	
	Minimum = 3 Reads
Minimum = 4 Reads	

## MSI/Plessey

The following options apply to the MSI/Plessey symbology.



### Disable/Enable MSI/Plessey

When this feature is disabled, the scanner will not read MSI/Plessey bar codes.

START / END	
PROGRAMMING BARCODES	
	<b>Disable MSI/Plessey DEFAULT</b>
Enable MSI/Plessey	

### Check Digit Verification

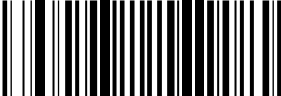
This feature specifies whether one or two check digits are to be calculated and verified.

START / END	
PROGRAMMING BARCODES	
	<b>Disable Check Digit Verification DEFAULT</b>
Enable Check Digit Verification	

## MSI/Plessey – continued



### Check Digit Transmit

When this option is enabled, the scanner will transmit one-digit or two-digit check digits, depending upon the setting for check digit verification.

START / END	
PROGRAMMING BARCODES	
	Disable Check Digit Transmission
Enable Check Digit Transmission DEFAULT	

### Number of Check Characters

Specifies number of MSI/Plessey check characters to be calculated and verified

START / END	
PROGRAMMING BARCODES	
	1 Check Character DEFAULT
2 Check Characters	

## MSI/Plessey — continued

### Length Control

**Fixed Length Decoding** — When fixed length decoding is enabled, the scanner will decode a bar code if the label length matches one of the configurable fixed lengths.



**Variable Length Decoding** — When variable length decoding is enabled, the scanner will decode a bar code if the label length falls in the range of the configurable minimum and maximum length.

Configuring Fixed Length Decoding:

1. Scan the START/END bar code.
2. Scan the Fixed Length Decoding bar code.
3. Scan the START/END bar code.
4. Set Length 1 to the first fixed length by following the [MSI/Plessey Length 1, Length 2 Programming Instructions](#) below.
5. Set Length 2 to the second fixed length (or to '000' if there is only one fixed length) by following the [MSI/Plessey Length 1, Length 2 Programming Instructions](#) below.

Configuring Variable Length Decoding:

1. Scan the START/END bar code.
2. Scan the Variable Length Decoding bar code.
3. Scan the START/END bar code.
4. Set Length 1 to the first variable length by following the [MSI/Plessey Length 1, Length 2 Programming Instructions](#) below.
5. Set Length 2 to the second variable length by following the [MSI/Plessey Length 1, Length 2 Programming Instructions](#) below.

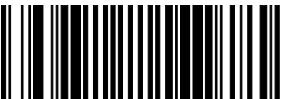
START / END	
PROGRAMMING BARCODES	
	<b>Variable Length Decoding DEFAULT</b>
Fixed Length Decoding	



## MSI/Plessey – continued

### MSI/Plessey Length 1, Length 2 Programming Instructions



1. Scan the START bar code.
2. Scan either the Set Length 1 or Set Length 2 bar code.
3. Turn to [Appendix C, Alpha-Numeric Pad](#) and scan the three digits (zero padded) representing the length in decimal notation.



**For MSI/Plessey bar codes, all check and data characters are included in the length calculations.**

#### NOTE

4. Scan the END bar code.

START / END	
PROGRAMMING BARCODES	
 <b>DEFAULT SETTING FOR THIS FEATURE: 004</b>	Set Length 1
Set Length 2	 <b>DEFAULT SETTING FOR THIS FEATURE: 016</b>

# MSI/Plessey – continued



## MSI/Plessey Stitching

Enables/disables stitching for MSI/Plessey bar codes. When parts of an MSI/Plessey label are presented to the scanner with this feature enabled, the bar code parts will be assembled by the scanner’s software, and the data will be decoded if all bar code proofing requirements are met.



Only functions when **Fixed Length Decoding** is enabled.





**NOTE**

START / END	
PROGRAMMING BARCODES	
	<b>Disable MSI/Plessey Stitching</b> <b>DEFAULT</b>
Enable MSI/Plessey Stitching	

## MSI/Plessey – continued

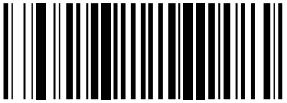
### Minimum Reads

This feature specifies the minimum number of consecutive times an MSI/Plessey label must be decoded before it is accepted as good read.



START / END	
PROGRAMMING BARCODES	
	<b>Minimum = 1 Read DEFAULT</b>
Minimum = 2 Reads	
	Minimum = 3 Reads
Minimum = 4 Reads	

## Standard 2 of 5

The following options apply to the Standard 2 of 5 symbology.



### Disable/Enable Standard 2 of 5

When this feature is disabled, the scanner will not read Standard 2 of 5 bar codes.

START / END	
PROGRAMMING BARCODES	
	<b>Disable Std 2 of 5 DEFAULT</b>
Enable Std 2 of 5	

### Check Digit Verification

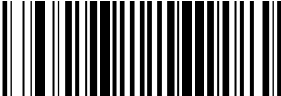

When enabled, the scanner will verify the check digit of the labels.

START / END	
PROGRAMMING BARCODES	
	<b>Disable Check Digit Verification DEFAULT</b>
Enable Check Digit Verification	

## Standard 2 of 5 – continued

### Check Digit Transmit

When this option is enabled, the scanner will transmit the check digit.

START / END	
PROGRAMMING BARCODES	
	Disable Check Digit Transmission
Enable Check Digit Transmission DEFAULT	

## Standard 2 of 5 — continued

### Length Control

**Fixed Length Decoding** — When fixed length decoding is enabled, the scanner will decode a bar code if the label length matches one of the configurable fixed lengths.



**Variable Length Decoding** — When variable length decoding is enabled, the scanner will decode a bar code if the label length falls in the range of the configurable minimum and maximum length.

Configuring Fixed Length Decoding:

1. Scan the START/END bar code.
2. Scan the Fixed Length Decoding bar code.
3. Scan the START/END bar code.
4. Set Length 1 to the first fixed length by following the [Standard 2 of 5 Length 1, Length 2 Programming Instructions](#) below.
5. Set Length 2 to the second fixed length (or to '000' if there is only one fixed length) by following the [Standard 2 of 5 Length 1, Length 2 Programming Instructions](#) below.

Configuring Variable Length Decoding:

1. Scan the START/END bar code.
2. Scan the Variable Length Decoding bar code.
3. Scan the START/END bar code.
4. Set Length 1 to the first variable length by following the [Standard 2 of 5 Length 1, Length 2 Programming Instructions](#) below.
5. Set Length 2 to the second variable length by following the [Standard 2 of 5 Length 1, Length 2 Programming Instructions](#) below.

START / END	
PROGRAMMING BARCODES	
	<b>Variable Length Decoding DEFAULT</b>
Fixed Length Decoding	

## Standard 2 of 5 — continued

### Standard 2 of 5 Length 1, Length 2 Programming Instructions



1. Scan the START bar code.
2. Scan either the Set Length 1 or Set Length 2 bar code.
3. Turn to [Appendix C, Alpha-Numeric Pad](#) and scan the three digits (zero padded) representing the length in decimal notation.



**For Standard 2 of 5 bar codes, all check and data characters are included in the length calculations.**

**NOTE**

4. Scan the END bar code.

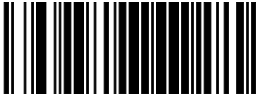
START / END	
PROGRAMMING BARCODES	
 <b>DEFAULT SETTING FOR THIS FEATURE: 008</b>	Set Length 1
Set Length 2	 <b>DEFAULT SETTING FOR THIS FEATURE: 050</b>

## Standard 2 of 5 – continued



### Standard 2 of 5 Stitching

Enables/disables stitching for Standard 2 of 5 bar codes. When parts of a Standard 2 of 5 label are presented to the scanner with this feature enabled, the bar code parts will be assembled by the scanner’s software, and the data will be decoded if all bar code proofing requirements are met.

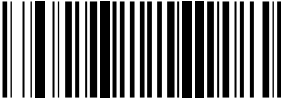

**NOTE**

Only functions when Fixed Length Decoding is enabled.





START / END	
PROGRAMMING BARCODES	
	<p>Disable Std 2 of 5 Stitching DEFAULT</p>
<p>Enable Std 2 of 5 Stitching</p>	



## Standard 2 of 5 — continued

### Minimum Reads

This feature specifies the minimum number of consecutive times a Standard 2 of 5 label must be decoded before it is accepted as good read.

START / END	
PROGRAMMING BARCODES	
	<b>Minimum = 1 Read DEFAULT</b>
Minimum = 2 Reads	
	Minimum = 3 Reads
Minimum = 4 Reads	

# NOTES

# Appendix A

## Product Specifications

### Optical and Read Performance Parameters

Parameter	Specification
Scan Volume	70 cubic inches
Scan Pattern	100 lines
Scan Rate	1,100 digital scan lines
Minimum Resolution	5 mil
Depth of Field (100% UPC Labels)	0 - 6"
Minimum Print Contrast Ratio	25%
Skew (Yaw)	$\pm 75^\circ$
Pitch	$\pm 65^\circ$
Roll	Between 0 and 360°

### Scanner Dimensions

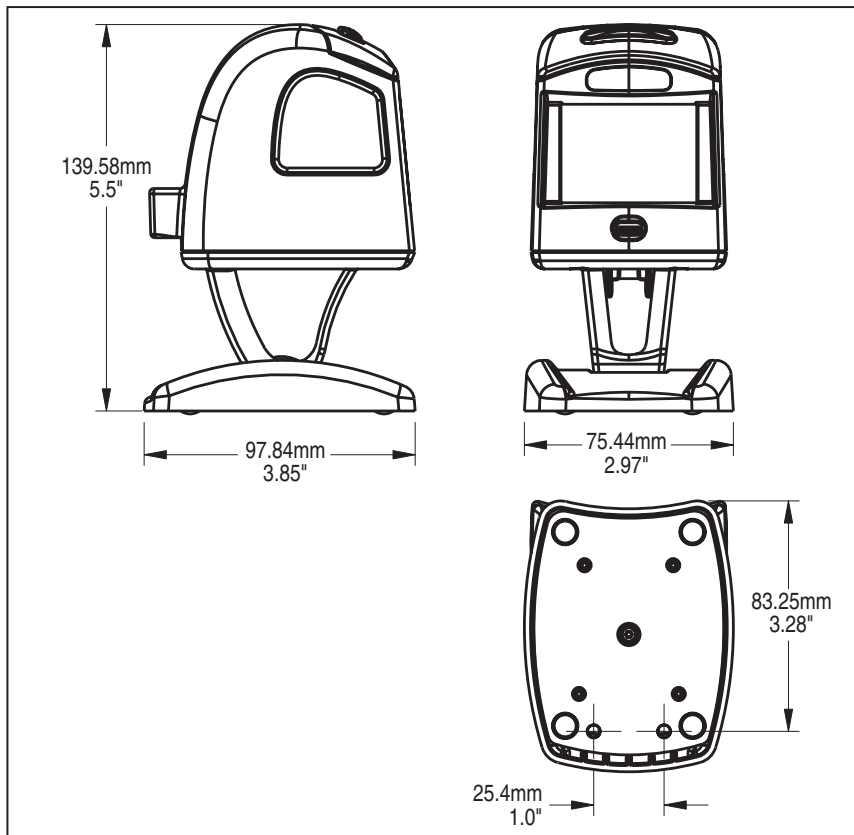

## Physical Properties

Parameter	Specification
Dimensions (Scanner only):	3.3" x2.8" x3.7"
Dimensions (Scanner w/Base Station):	5.5" x2.9" x3.8"
Weight (Scanner)	7.0 oz.
Weight (Base Station)	6.6 oz.

## Electrical Parameters

Parameter	Specification
Operating Voltage	(Two Models) 5V unit = 5.0V ± 5% 12V unit = 7-12V
Input Current Operating (idle) Operating (label read)	<300mA <400 mA

## Environmental Parameters

Parameter	Specification
Mechanical Shock	Multi 1.2m drops
Contaminants Water and Dust	IP52
Temperature Ranges: Operating Storage	32° F to +104° F (0° C to +40° C) -40° F to +158° F (-40° C to + 70°C)
Ambient Light Indoor	<6000 lux
Ambient Light Outdoor	<86,100 lux
Humidity	5 to 95% non-condensing
Beeper/Speaker	70-85dBA at a distance of 3'-3" (1 meter)
Vibration	Retail/Office

## Other Parameters

Parameter	Specification
EAS Support	YES (Checkpoint)

# Appendix B

## Cable Pinouts

### Standard Cable Pinouts (Primary Interface Cables)

#### RS-232

- 1
- 2 CTS
- 3
- 4 RTS
- 5 RXD
- 6 TXD
- 7
- 8 VCC IN
- 9 GND
- 10

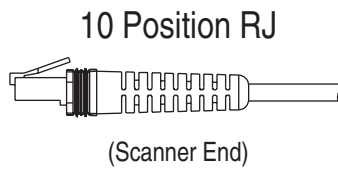
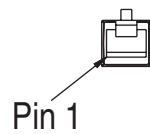

#### IBM Port 5B/9B/17

- 1
- 2
- 3
- 4 DATA -
- 5
- 6 DATA +
- 7
- 8 VCC\_IN
- 9 GND
- 10

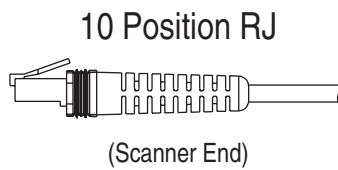
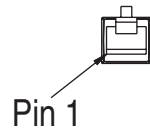

## IBM USB

- 1
- 2
- 3
- 4 D -
- 5
- 6 D +
- 7
- 8 VIN
- 9 GND
- 10

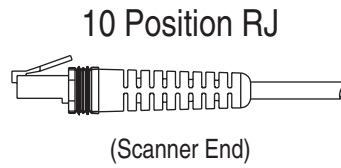
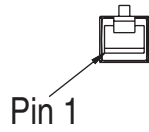

## USB & USB Keyboard

- 1
- 2
- 3
- 4 D -
- 5
- 6 D +
- 7
- 8 VBUS\_VIN
- 9 GND
- 10

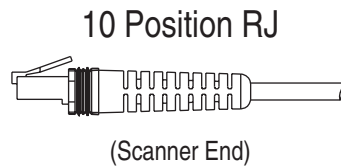
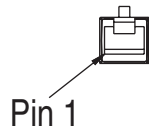

## Wand Emulation

- 1
- 2
- 3 WAND~
- 4
- 5
- 6
- 7
- 8 VCC\_IN
- 9 GND
- 10

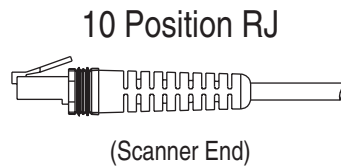
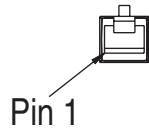

## Keyboard Wedge

- 1
- 2 KB\_DATA
- 3 AT\_CLK
- 4 KB\_CLK
- 5
- 6 AT\_DATA
- 7
- 8 VCC\_IN
- 9 GND
- 10

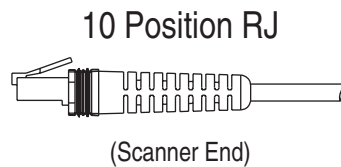
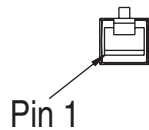

# Appendix C

## Alpha-Numeric Pad

---



A



B



C



D



E



F

---

## Alpha-Numeric Pad





# Appendix D

## Default Settings

### Defaults by Symbology

The following is a partial list of key settings for each symbology type.

Code Type	Read Enable	Checksum Verification Enable	Checksum Transmission Enable	Label ID
UPC-A	✓	✓	✓	A
UPC-E	✓	✓	✓	E
EAN-13	✓	✓	✓	F
EAN-8	✓	✓	✓	FF
RSS-14				R4
RSS Expanded				RX
Code 39	✓		✓	*
PharmaCode 39				A
Code 128	✓			#
Interleaved 2 of 5			✓	i
Codabar			✓	%
Code 93				&
MSI/Plessey			✓	@
Standard 2 of 5			✓	s

### Interface Default Exceptions

The factory default settings indicated in the programming sections (in bold text) reflect factory configuration for the RS-232 standard interface. The following tables list default exceptions by interface for the remaining available interfaces.

---

## IBM Interfaces

IBM Interfaces include IBM-USB, IBM Port 9B, IBM Port5B and IBM Port17.

Parameter	Default Setting
IBM Interface Type	IBM Port 9B
Number of Host Transmit Buffers	One Buffer
Label I.D. Transmission	Disable
Suffix Characters	No Suffix

## RS-232 Wincor/Nixdorf

Parameter	Default Setting
Interface Type	RS-232-WN
Number of Host Transmit Buffers	One Buffer
RS-232 Parity	Odd
RS-232 Hardware Control	CTS Flow Control
UPC-E Check Character Conversion	Disabled
UCC/EAN-128 Label ID	'P'
Code 39 Label ID	'M'
Code 93 Label ID	'L'
Code 128 Label ID	'K'
Codabar Label ID	'N'
EAN-8 Label ID	'B'
EAN-13 Label ID	'A'
ISBN Label ID	'A'
Interleaved 2 of 5 Label ID	'I'
Standard 2 of 5 Label ID	'H'
MSI/Plessey Label ID	'O'
UPC-E Label ID	'C'
RSS-14 Label ID	'E'
RSS Expanded Label ID	'E'

## Wand Emulation

Parameter	Default Setting
Interface Type	Wand Emulation
Code 39 Start/Stop Character Transmission	Enable

## Keyboards

Keyboard interfaces include USB Keyboard and Keyboard Wedge A-Y.

Parameter	Default Setting
Keyboard Wedge Interface Type	USB Keyboard
Label ID Transmission	Disable

---

# NOTES

# Appendix E

# Keyboard Function Key Mappings

## Keyboard Model Cross Reference

Table E-1 summarizes the keyboard models, their defined protocol, scancode set, and some unique features. The remaining tables in this chapter provide the function key maps associated with each of the scancode sets.

**Table E-1. Keyboard Model Cross Reference**

Model Type	I/F ID	Transmission Protocol	Scancode Set	Func. Key Map Support	Use Country Mode
PC/XT Foreign ALT Mode	Wedge A	PC/XT	Scan Set 1	No	No
AT; PS/2 25-286; PS/2 30-286; PS/2 50, 50Z; PS/2 60,70,80,90,95 Foreign ALT Mode	Wedge B	AT/PS2	Scan Set 2	No	No
PS/2 25 and 30 Foreign ALT Mode	Wedge C	AT/PS2	Scan Set 1	No	No
PC/XT U.S. Mode	Wedge D	PC/XT	Scan Set 1	Yes	No
AT; PS/2 25-286; PS/2 30-286; PS/2 50, 50Z; PS/2 60,70,80,90,95 U.S. Mode + specific country support	Wedge E	AT/PS2	Scan Set 2	Yes	Yes
PS/2 25 and 30 U.S. Mode	Wedge F	AT/PS2	Scan Set 1	Yes	No
IBM 3xxx Terminals (122-key keyboard)	Wedge G	AT/PS2	Scan Set 3	Yes	No
IBM 3xxx Terminals (102-key keyboard)	Wedge H	AT/PS2	Scan Set 3	Yes	No
PS55 5530T with JAPANESE DOS (TDOS)	Wedge I	AT/PS2	Japanese DOS	Yes	No
NEC 9801	Wedge J	NEC 9801	NEC 9801	Yes	No

**Table E-2. Scanset 1 Function Key Map**

ASCII (hex)	ASCII code	Key	Scancode
00	NUL	ALT right Make	E0h 38h
01	SOH	ALT right Break	E0h B8h
02	STX	ALT left Make	38h
03	ETX	ALT left Break	B8h
04	EOT	CTRL left Make	1Dh
05	ENQ	CTRL left Break	9Dh
06	ACK	CTRL right Make	E0h 1Dh
07	BEL	CTRL right Break	E0h 9Dh
08	BS	BS	0Eh
09	HT	TAB right	0Fh
0A	LF	RIGHT arrow (inner keypad)	4Dh + E0
0B	VT	TAB left	0Fh + S
0C	FF	Enter (inner keypad)	1Ch + E0
0D	CR	CR	1Ch
0E	SO	INSERT (inner keypad)	52h + E0
0F	SI	PAGE UP (inner keypad)	49h + E0
10	DLE	PAGE DOWN (inner keypad)	51h + E0
11	DC1	HOME (inner keypad)	47h + E0
12	DC2	LEFT arrow (inner keypad)	4Bh + E0
13	DC3	DOWN arrow (inner keypad)	50h + E0
14	DC4	UP arrow (inner keypad)	48h + E0

**Table E-3. Scanset 2 Function Key Map**

ASCII (hex)	ASCII code	Key	Scancode
00	NUL	ALT right Make	E0h 11h
01	SOH	ALT right Break	E0h F0h 11h
02	STX	ALT left Make	11h
03	ETX	ALT left Break	F0h 11h
04	EOT	CTRL left Make	14h
05	ENQ	CTRL left Break	F0h 14h
06	ACK	CTRL right Make	E0h 14h
07	BEL	CTRL right Break	E0h F0h 14h
08	BS	BS	66h
09	HT	TAB right	0Dh
0A	LF	RIGHT arrow (inner keypad)	74h + E0
0B	VT	TAB left	0Dh + S
0C	FF	Enter (right keypad)	5Ah + E0
0D	CR	CR	5Ah
0E	SO	INSERT (inner keypad)	70h + E0
0F	SI	PAGE UP (inner keypad)	7Dh + E0
10	DLE	PAGE DOWN (inner keypad)	7Ah + E0
11	DC1	HOME (inner keypad)	6Ch + E0
12	DC2	LEFT arrow (inner keypad)	6Bh + E0
13	DC3	DOWN arrow (inner keypad)	72h + E0
14	DC4	UP arrow (inner keypad)	75h + E0
15	NAK	F6	0Bh
16	SYN	F1	05h
17	ETB	F2	06h
18	CAN	F3	04h
19	EM	F4	0Ch
1A	SUB	F5	03h

1B	ESC	ESC	76h
1C	FS	F7	83h
1D	GS	F8	0Ah
1E	RS	F9	01h
1F	US	F10	09h

**Table E-4. Scanset 3, 102-Key Function Key Map**

ASCII (hex)	ASCII code	Key	Scancode
00	NUL	ALT right Make	39h
01	SOH	ALT right Break	F0h 39h
02	STX	ALT left Make	19h
03	ETX	ALT left Break	F0h 19h
04	EOT	CTRL left Make	11h
05	ENQ	CTRL left Break	F0h 11h
06	ACK	CTRL right Make	58h
07	BEL	CTRL right Break	F0h 58h
08	BS	BS	66h
09	HT	TAB right	0Dh
0A	LF	RIGHT arrow (inner keypad)	6Ah
0B	VT	TAB left	0Dh + S
0C	FF	Enter (inner keypad)	79h
0D	CR	CR	5Ah
0E	SO	INSERT (inner keypad)	67h
0F	SI	PAGE UP (inner keypad)	6Fh
10	DLE	PAGE DOWN (inner keypad)	6Dh
11	DC1	HOME (inner keypad)	6Eh
12	DC2	LEFT arrow (inner keypad)	61h
13	DC3	DOWN arrow (inner keypad)	60h
14	DC4	UP arrow (inner keypad)	63h
15	NAK	F6	2Fh
16	SYN	F1	07h
17	ETB	F2	0Fh
18	CAN	F3	17h
19	EM	F4	1Fh
1A	SUB	F5	27h
1B	ESC	ESC	08h
1C	FS	F7	37h
1D	GS	F8	3Fh
1E	RS	F9	47h
1F	US	F10	4Fh

**Table E-5. Scanset 3 122-Key Function Key Map**

ASCII (hex)	ASCII code	Key	Scancode
00	NUL	ALT Right Make	39h
01	SOH	ALT Right Break	F0h 39h
02	STX	ALT left Make	19h
03	ETX	ALT left Break	F0h 19h
04	EOT	CTRL left (RESET) Make only	11h
05	ENQ	CTRL left (RESET) Make/Break	11h F0h 11h
06	ACK	ONLINE Enter Make only	58h
07	BEL	ONLINE Enter Make/Break	58h F0h 58h
08	BS	BS	66h
09	HT	TAB right	0Dh
0A	LF	RIGHT arrow (inner keypad)	6Ah
0B	VT	TAB left	0Dh + S
0C	FF	CR (FIELD EXIT) Make only	5Ah F0h 5Ah
0D	CR	CR (FIELD EXIT) Make/Break	5Ah
0E	SO	INSERT (inner keypad)	65h
0F	SI	FIELD +	79h
10	DLE	FIELD -	7Ch
11	DC1	HOME (inner keypad)	62h
12	DC2	LEFT arrow (inner keypad)	61h
13	DC3	DOWN arrow (inner keypad)	60h
14	DC4	UP arrow (inner keypad)	63h
15	NAK	F6	2Fh
16	SYN	F1	07h
17	ETB	F2	0Fh
18	CAN	F3	17h
19	EM	F4	1Fh
1A	SUB	F5	27h
1B	ESC	ESC	08h
1C	FS	F7	37h
1D	GS	F8	3Fh
1E	RS	F9	47h
1F	US	F10	4Fh



**Table E-6. Japanese DOS Function Key Map**

ASCII value	ASCII code	Key	Scancode
00h	NUL	ALT right Make	31h
01h	SOH	ALT right Break	B1h
02h	STX	ALT left Make	31h
03h	ETX	ALT left Break	B1h
04h	EOT	CTRL left Make	41h
05h	ENQ	CTRL left Break	C1h
06h	ACK	CTRL right Make	41h
07h	BEL	CTRL right Break	C1h
08h	BS	BS	3Eh
09h	HT	TAB right	3Ch
0Ah	LF	RIGHT arrow (inner keypad)	4Dh
0Bh	VT	TAB left	3Ch + S
0Ch	FF	Enter (right keypad)	60h
0Dh	CR	CR	3Bh
0Eh	SO	INSERT (inner keypad)	52h
0Fh	SI	PAGE UP (inner keypad)	49h
10h	DLE	PAGE DOWN (inner keypad)	51h
11h	DC1	HOME (inner keypad)	4Ch
12h	DC2	LEFT arrow (inner keypad)	4Bh
13h	DC3	DOWN arrow (inner keypad)	4Ah
14h	DC4	UP arrow (inner keypad)	4Eh
15h	NAK	F6	6Dh
16h	SYN	F1	68h
17h	ETB	F2	69h
18h	CAN	F3	6Ah
19h	EM	F4	6Bh
1Ah	SUB	F5	6Ch
1Bh	ESC	ESC	3Dh
1Ch	FS	F7	6Eh
1Dh	GS	F8	6Fh
1Eh	RS	F9	70h
1Fh	US	F10	71h

**Table E-7. NEC 9801-Key Function Key Map**

ASCII value	ASCII code	Key	Scancode
00h	NUL	unused	n/a
01h	SOH	CR	1Ch
02h	STX	CAPS LOCK ON (make)	71h
03h	ETX	CAPS LOCK OFF (break)	F1h
04h	EOT	CTRL left Make	74h
05h	ENQ	CTRL left Break	F4h
06h	ACK	CTRL-C	60h
07h	BEL	n/a	n/a
08h	BS	BS	0Eh
09h	HT	TAB right	0Fh
0Ah	LF	RIGHT arrow (inner keypad)	3Ch
0Bh	VT	TAB left	0Fh + S
0Ch	FF	DELETE	39h
0Dh	CR	CR	1Ch
0Eh	SO	INSERT (inner keypad)	38h
0Fh	SI	KATAKANA LOCK ON (Make)	72h
10h	DLE	KATAKANA LOCK OFF (Break)	F2h
11h	DC1	HOME (inner keypad)	3Eh
12h	DC2	LEFT arrow (inner keypad)	3Bh
13h	DC3	DOWN arrow (inner keypad)	3Dh
14h	DC4	UP arrow (inner keypad)	3Ah
15h	NAK	F6	67h
16h	SYN	F1	62h
17h	ETB	F2	63h
18h	CAN	F3	64h
19h	EM	F4	65h
1Ah	SUB	F5	66h
1Bh	ESC	ESC	00h
1Ch	FS	F7	68h
1Dh	GS	F8	69h
1Eh	RS	F9	6Ah
1Fh	US	F10	6Bh

# Appendix F

## Host Commands

### Accepting RS-232 Commands

The scanner responds to the following RS-232 commands:

COMMAND	ASCII	HEX	COMMENT
Enable Scanner	E	0x45	
Disable Scanner	D	0x44	
Reset Scanner	R	0x52	
Not On File Indication	F	0x46	Long series of beeps
Beep Good Read Tone	B	0x42	Beeps if Good Read Beep is enabled
Force Good Read Tone	!	0x01	Beeps regardless of beep setting
Bel	'	0x07	Force Good Read Tone
Identification request	i	0x69	Returns long response <sup>a</sup>
Health request	h	0x68	Returns long response <sup>a</sup>
Status request	s	0x73	Returns long response <sup>a</sup>

a. Call Tech Support for information.

If one of the above commands is received, the scanner will perform the steps indicated for the command. Host commands for other interfaces are also available. Contact Tech Support for more details.

---

# NOTES

# Appendix G

## Sample Symbols

---

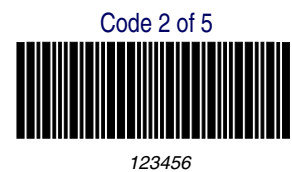
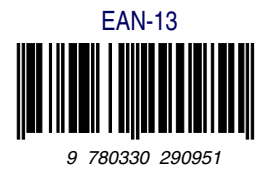

---

# Sample Symbols

RSS-14



(01)00123456789012

RSS Expanded



0100123456789050

## ASCII Chart

ASCII Char.	Hex No.	ASCII Char.	Hex No.	ASCII Char.	Hex No.	ASCII Char.	Hex No.
NUL	00	SP	20	@	40	'	60
SOH	01	!	21	A	41	a	61
STX	02	"	22	B	42	b	62
ETX	03	#	23	C	43	c	63
EOT	04	\$	24	D	44	d	64
ENQ	05	%	25	E	45	e	65
ACK	06	&	26	F	46	f	66
BEL	07	'	27	G	47	g	67
BS	08	(	28	H	48	h	68
HT	09	)	29	I	49	i	69
LF	0A	*	2A	J	4A	j	6A
VT	0B	+	2B	K	4B	k	6B
FF	0C	,	2C	L	4C	l	6C
CR	0D	-	2D	M	4D	m	6D
SO	0E	.	2E	N	4E	n	6E
SI	0F	/	2F	O	4F	o	6F
DLE	10	0	30	P	50	p	70
DC1	11	1	31	Q	51	q	71
DC2	12	2	32	R	52	r	72
DC3	13	3	33	S	53	s	73
DC4	14	4	34	T	54	t	74
NAK	15	5	35	U	55	u	75
SYN	16	6	36	V	56	v	76
ETB	17	7	37	W	57	w	77
CAN	18	8	38	X	58	x	78
EM	19	9	39	Y	59	y	79
SUB	1A	:	3A	Z	5A	z	7A
ESC	1B	;	3B	[	5B	{	7B
FS	1C	<	3C	\	5C		7C
GS	1D	=	3D	]	5D	}	7D
RS	1E	>	3E	^	5E	~	7E
US	1F	?	3F	_	5F	DEL	7F

## **Australia**

Datalogic Scanning Pty Ltd  
North Ryde, Australia  
Telephone: [61] (2) 9870 3200  
Fax: [61] (2) 9878 8688

## **France and Benelux**

Datalogic Scanning Sarl  
LES ULIS Cedex, France  
Telephone: [33].01.64.86.71.00  
Fax: [33].01.64 46.72.44

## **Germany**

Datalogic Scanning GmbH  
Darmstadt, Germany  
Telephone: 49 (0) 61 51/93 58-0  
Fax: 49 (0) 61 51/93 58 58

## **Italy**

Datalogic Scanning SpA  
Vimercate (MI), Italy  
Telephone: [39] (0) 39/62903.1  
Fax: [39] (0) 39/6859496

## **Japan**

Datalogic Scanning KK  
Shinagawa, Tokyo, Japan  
Telephone: 81 (0)3 3491 6761  
Fax: 81 (0)3 3491 6656

## **Latin America**

Datalogic Scanning, Inc  
Miami, Florida, USA  
Telephone: (305) 591-3222  
Fax: (305) 591-3007

## **Spain and Portugal**

Datalogic Scanning Sarl Sucursal en España  
Madrid, Spain  
Telephone: 34 91 746 28 60  
Fax: 34 91 742 35 33

## **United Kingdom**

Datalogic Scanning LTD  
Watford, England  
Telephone: 44 (0) 1923 809500  
Fax: 44 (0) 1923 809 505



[www.scanning.datalogic.com](http://www.scanning.datalogic.com)

### **Datalogic Scanning, Inc.**

959 Terry Street  
Eugene, OR 97402  
Telephone: (541) 683-5700  
Fax: (541) 345-7140

