



INSTRUCTION MANUAL

Before using the TV, please read this manual thoroughly, and retain it for future reference.



Model: LCD2425A

CONTENTS

1	SAFETY PRECAUTION		1
2	IMPORTANT SAFETY INSTRUCTION		2
3	ACCESSORIES		3
4	GETTING STARTED		3
5	CONTROL REFERENCE GUIDE	Remote Control	4
		Front Frame	5
		Back Frame	5
		Side Panel	6
6	CONNECTIONS	Antenna Connection	7
		S-Video Connection	7
		AV Connection	7
		Y Pb Pr Connection	8
		HDMI Connection	8
		VGA Connection	9
		Headphone Connection	9
		Power Cord Connection	9
7	WALL MOUNT INSTALLATION		10
8	INITIAL SETUP	Putting The Unit On A Proper Place	11
		Source Selection	11
		Turning The Unit On For The First Time	11
9	TV SETUP	Picture Menu	13
		Audio Menu	15
		Time Menu	17
		Setup Menu	18
		Parental Menu	21
		TV Menu	24

CONTENTS

10	DISPLAY MODE	PC Formats Video Formats	25 26
11	SPECIFICATION		27
12	TROUBLE- SHOOTING GUIDE		28

SAFETY CLASS :This is an IEC safety class I product
and it must be grounded for safety.

SAFETY PRECAUTION

* CAUTION MARKING WAS LOCATED AT BOTTOM ENCLOSURE OF THE APPARATUS.



WARNING: TO REDUCE THE RISK OF ELECTRIC SHOCK DO NOT REMOVE COVER OR BACK NO USER SERVICEABLE PARTS INSIDE. REFERS SERVICING TO QUALIFIED SERVICE PERSONNEL.



The lightning flash with arrowhead symbol, within an equilateral triangle, is intended to alert the user to the presence of uninsulated "dangerous voltage" within the product's enclosure that may be of sufficient magnitude to constitute a risk of electric shock to persons.



The exclamation point within an equilateral triangle is intended to alert the user to the presence of important operating and maintenance (servicing) instructions in the literature accompanying the appliance.



CAUTION

- DANGER OF EXPLOSION IF BATTERY IS INCORRECTLY REPLACED. REPLACE ONLY WITH THE SAME OR EQUIVALENT TYPE.
- USE OF CONTROLS OR ADJUSTMENTS OR PERFORMANCE OF PROCEDURES OTHER THAN THOSE SPECIFIED MAY RESULT IN HAZARDOUS RADIATION EXPOSURE.



WARNING:

- TO REDUCE THE RISK OF FIRE OR ELECTRIC SHOCK, DO NOT EXPOSE THIS APPLIANCE TO RAIN OR MOISTURE.
- TO PREVENT FIRE OR SHOCK HAZARD, DO NOT EXPOSE THIS UNIT TO RAIN OR MOISTURE. DO NOT PLACE OBJECTS FILLED WITH LIQUIDS ON OR NEAR THIS UNIT.
- SHOULD ANY TROUBLE OCCUR, DISCONNECT THE AC POWER CORD AND REFER SERVICING TO A QUALIFIED TECHNICIAN.

PLACEMENT INFORMATION

- Do not use this unit in places that are extremely hot, cold, dusty or humid.
- Do not restrict the airflow of this unit by placing it somewhere with poor airflow, by covering it with a cloth, by placing it on bedding or carpeting.

SAFETY INFORMATION

- When connecting or disconnecting the AC power cord, grip the plug and not the cord itself. Pulling the cord may damage it and create a hazard.
- When you are not going to use the unit for a long period of time, disconnect the AC power cord.

RATING PLATE LOCATION

The rating plate is located on the rear of the unit.

FCC STATEMENTS

NOTE: This unit has been tested and found to comply with the limits for a Class B digital device, pursuant to Part 15 of the FCC Rules. These limits are designed to provide reasonable protection against harmful interference in a residential installation.

This unit generates, uses and can radiate radio frequency energy and, if not installed and used in accordance with the instructions, may cause harmful interference to radio communication. However, there is no guarantee that interference will not occur in a particular installation. If this unit does cause harmful interference to radio or television reception, which can be determined by turning the unit off and on, the user is encouraged to try to correct the interference by one or more of the following measures:

- Reorient or relocate the receiving antenna.
- Increase the separation between the unit and receiver.
- Connect the unit into an outlet on a circuit different from that to which the receiver is connected.
- Consult the dealer or an experienced radio/TV technician for help.



WARNING:

Changes or modifications to this unit not expressly approved by the party responsible for compliance could void the user authority to operate the unit.

IMPORTANT SAFETY INSTRUCTIONS

- 1) Read these instructions.
- 2) Keep these instructions.
- 3) Heed all warnings.
- 4) Follow all instructions.
- 5) Do not use this apparatus near water.
- 6) Clean only with a dry cloth.
- 7) Do not block any ventilation openings.
Install in accordance with the manufacturer's instructions.
- 8) Do not install near any heat sources such as radiators, heat registers, stoves, or other apparatus (including amplifiers) that produce heat.
- 9) Do not defeat the safety purpose of the polarized or grounding-type plug.
A polarized plug has two blades with one wider than the other.
A grounding type plug has two blades and a third grounding prong.
The wide blade or the third prong is provided for your safety.
If the provided plug does not fit into your wall outlet, consult an electrician for replacement of the obsolete outlet.
- 10) Protect the power cord from being walked on or pinched particularly at plugs, convenience receptacles, and the point where they exit from the apparatus.
- 11) Only use attachments / accessories specified by the manufacturer.

- 12) Use only with the cart, stand, tripod, bracket, or table specified by the manufacturer, or sold with the apparatus.
When a cart is used, use caution when moving the cart / apparatus combination to avoid injury from tip-over.
- 13) Unplug this apparatus during lightning storms or when unused for long periods of time.
- 14) Refer all servicing to qualified service personnel. Servicing is required when the apparatus has been damaged in any way, such as the power cord or plug is damaged, liquid has been spilled or objects have fallen into the apparatus, the apparatus has been exposed to rain or moisture, does not operate normally, or has been dropped.
- 15) To prevent electric shock, ensure the grounding pin on the AC cord power plug is securely connected.



ACCESSORIES

Please check and identify the supplied accessories.

Remote control	x 1
Battery(AA)	x 2
Warranty Card	x 1
Instruction Manual.....	x 1
Power cord	x 1

GETTING STARTED

USING THE REMOTE CONTROL

- Point the remote control at the remote sensor located on the unit.
- When there is a strong ambient light source, the performance of the infrared remote sensor may be degraded, causing unreliable operation.
- The recommended effective distance for remote operation is about 16 feet (5 meters).

TO INSTALL THE BATTERIES

1. Open the battery door.

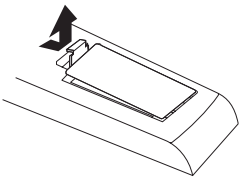

2. Insert 2 "AA" batteries

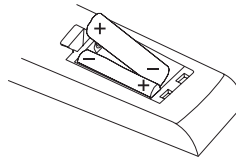

BATTERY REPLACEMENT

When the batteries become weak, the operating distance of the remote control is greatly reduced and you will need to replace the batteries.

CAUTION : Danger of explosion if battery is incorrectly replaced.

NOTES

- If the remote control is not going to be used for a long time, remove the batteries to avoid damage caused by battery leakage corrosion.
- Do not mix old and new batteries. Do not mix ALKALINE, standard (CARBON-ZINC) or rechargeable (NICKEL-CADMIUM) batteries.
- Always remove batteries as soon as they become weak.
- Weak batteries can leak and severely damage the remote control.

WARNING :
Do not dispose batteries in a fire. Batteries may explode or leak.
Batteries shall not be exposed to excessive heat such as sunshine, fire or the like.

REMOTE CONTROL

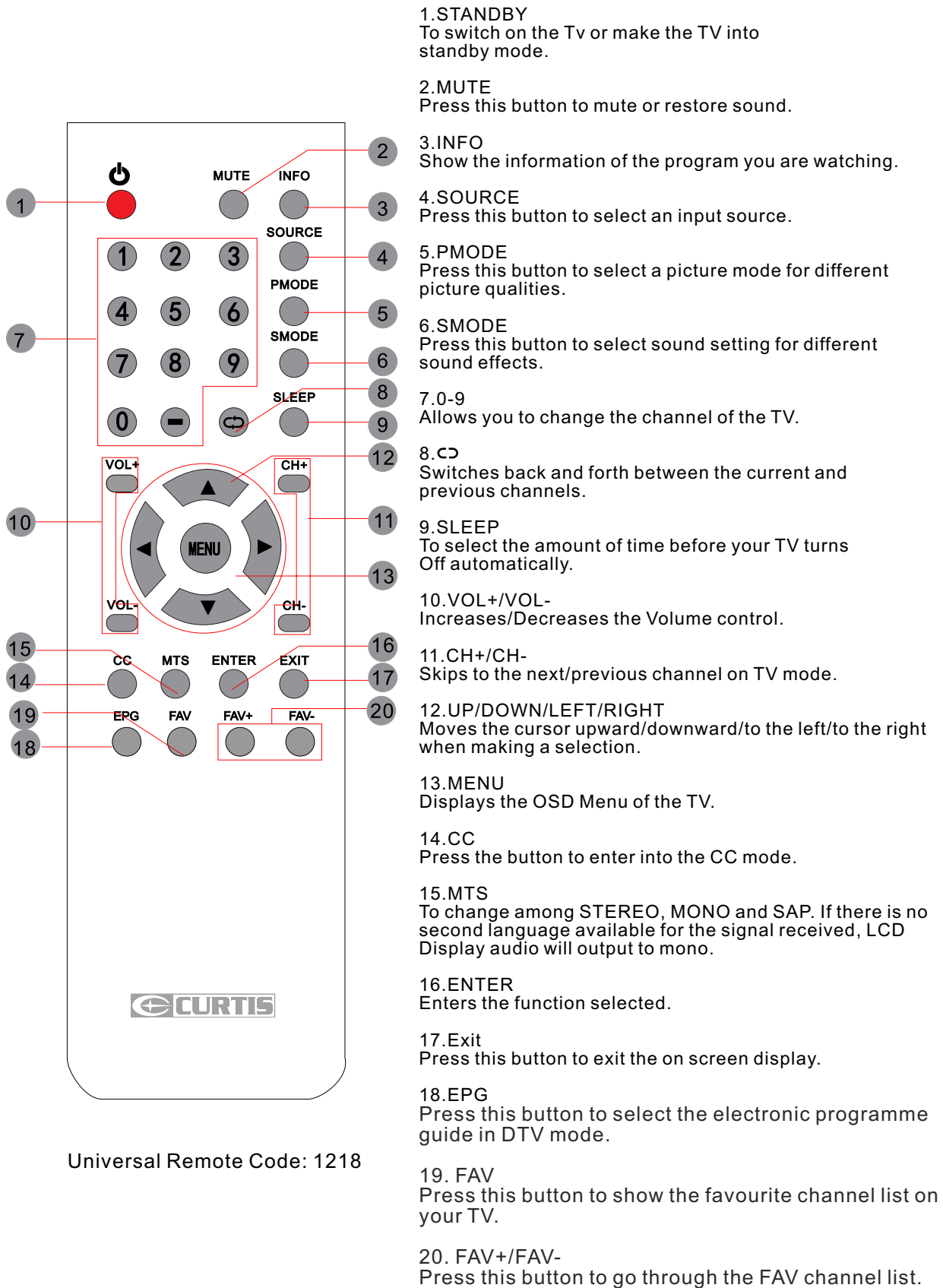

CONTROL REFERENCE GUIDE

FRONT VIEW



- 1.Color LCD Screen
- 2.Remote Sensor
Do not block this sensor or the remote control will not work.
- 3.Standby Indicator
Indicates whether the unit is ON or in STANDBY (OFF) mode.
Light in red: The unit is in STANDBY.
Light in green:The unit is turned ON.
4. Speakers

BACK VIEW

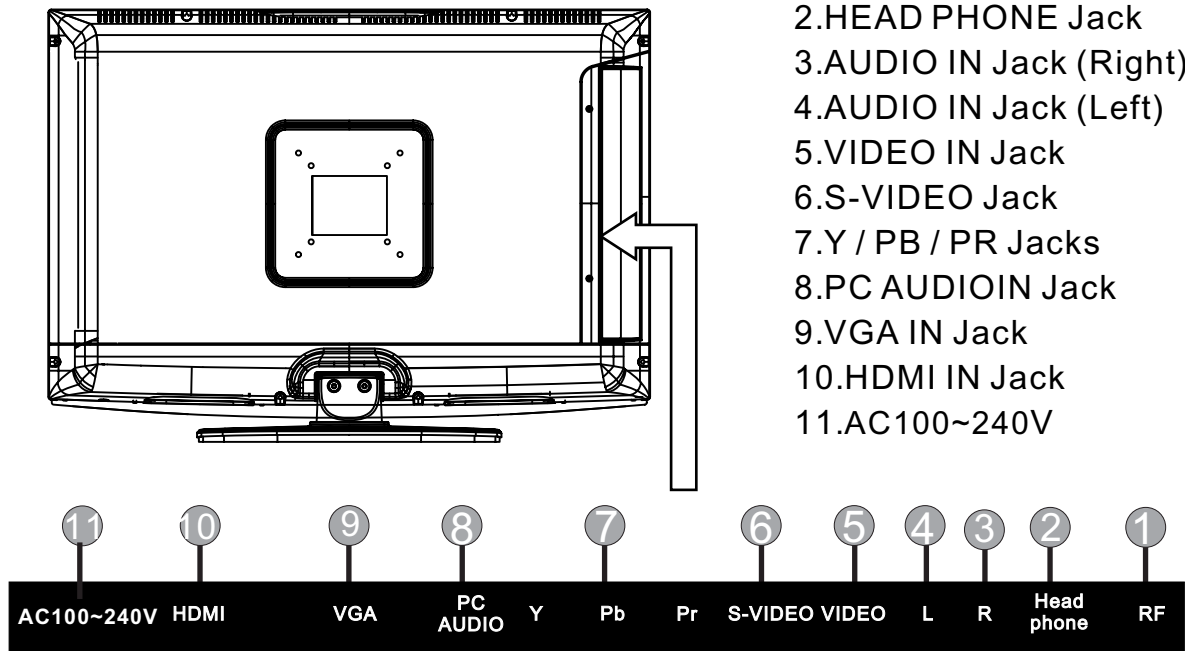

FRONT VIEW

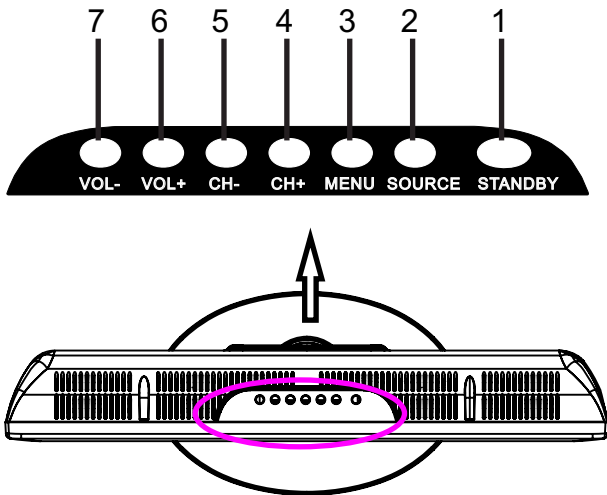

1. STANDBY Button

Press to turn the unit on and off.

2. SOURCE Button

Press to select the input source of the TV.

3. Menu Button

Press to display the on-screen TV menu.

4. CH+ Button

Press to change the TV channels and up highlight selections on the menu screen.

5. CH- Button

Press to change the TV channels and down highlight selections on the menu screen.

6. VOL+ Button

Press to adjust the volume up.

7. VOL- Button

Press to adjust the volume down.

CONNECTIONS

CONNECTING A TV ANTENNA / CABLE / SATELLITE

To view television channels correctly, a signal must be received from one of the following sources:

- An indoor or outdoor aerial antenna
- A cable system
- A satellite system

NOTE

For receiving over-the-air TV broadcasts, we recommend that you use an external fixed antenna. Should you require the use of a temporary antenna, please ensure that you purchase an antenna with sufficient ability to receive in weak signal areas. Only when you are in close proximity to a transmitter will a temporary antenna reproduce a signal as strongly as a fixed antenna.

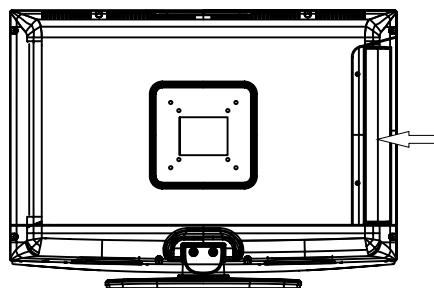

Satellite, cable or TV antenna cable to TV ANTENNA terminal (cable not included)

CONNECTING AN A/V DEVICE

To connect to other equipment such as a VCR, camcorder, satellite system or cable, etc.

Connecting to a VCR / Camcorder / Satellite System / Cable

Connect the AUDIO and S-VIDEO cable (not included) as shown.

Make sure you connect the cable from the other equipment (**AUDIO OUT** and **S-VIDEO OUT**) to this unit (**AUDIO IN** and **S-VIDEO IN**).

NOTE

Please refer to the user manual for the other equipment for more information.

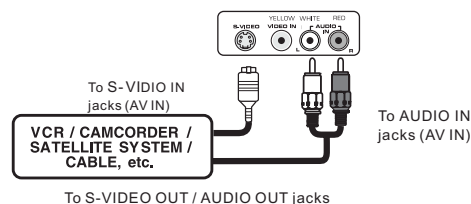
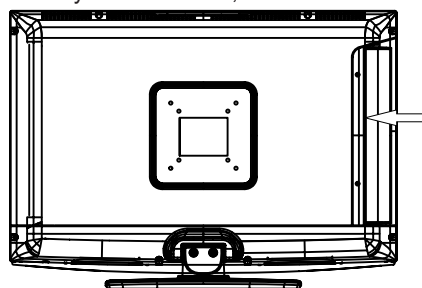

CONNECTING DEVICES WITH A COMPOSITE (YELLOW RCA-TYPE) VIDEO OUTPUT

To connect A/V devices such as a VCR, video game system or camcorder.

Connecting to a VCR / Video Game System / Camcorder

Connect the AUDIO / VIDEO cable (not included) as shown.

Make sure you connect the cable from the other equipment (**AUDIO** and **VIDEO OUT**) to this unit (**AUDIO** and **VIDEO IN**).

NOTE

Please refer to the user manual for the other equipment for more information.

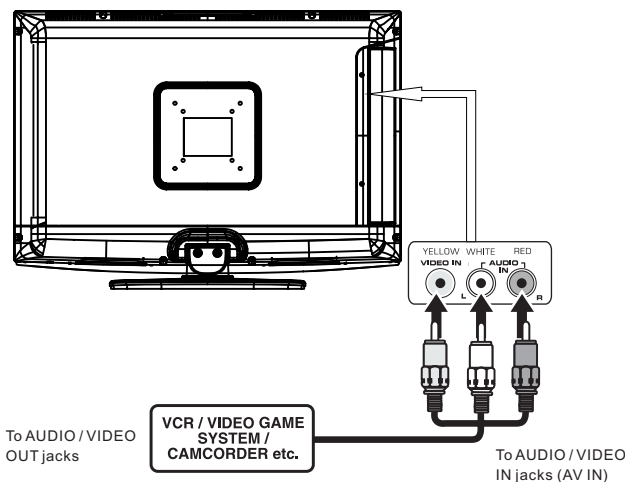

CONNECTIONS

CONNECTING A HIGH-DEFINITION (HD) SOURCE USING COMPONENT CONNECTION

High-Definition (HD) Devices with component video output must be connected to the YPbPr input.

Connect the component video cable and audio cable (not included) as shown.

Make sure you connect the component video cable and audio cable from the other equipment (COMPONENT OUT and AUDIO OUT) to this unit COMPONENT IN and AUDIO IN).

NOTE

When connecting a DVD player to the television, the picture resolution is solely dependent upon the resolution supported by the DVD player attached.

DVD player resolutions vary from 480i to 1080i , and this television can support DVD players up to a maximum resolution of 1080i .

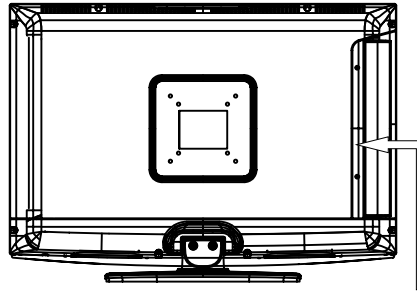

* May require a subscription for receiving HD channels, check with your cable/satellite service provider for details.

To COMPONENT VIDEO IN jacks (COMPONENT IN)

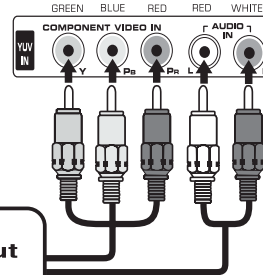

To AUDIO IN jacks (COMPONENT IN)

To COMPONENT VIDEO OUT jacks
To AUDIO OUT jacks

HD SOURCE
With component video output (Digital Cable Box*, Satellite Receiver* or external over-the-air HD-Tuner)

CONNECTING A HIGH-DEFINITION (HD) SOURCE USING HDMI CONNECTION

HDMI (High Definition Multimedia Interface) supports both video and audio on a single digital connection for use with DVD players, DTV, set-top boxes and other digital AV devices. HDMI was developed to provide the technologies of High Bandwidth Digital Content Protection (HDCP) as well as Digital Visual Interface (DVI) in one specification. HDCP is used to protect digital content transmitted and received by DVI-compliant or HDMI-compliant displays.

HDMI has the capability to support standard, enhanced or high-definition video plus standard to multi-channel surround-sound audio. HDMI features include uncompressed digital video, a bandwidth of up to 2.2 gigabytes per second (with HDTV signals), one connector (instead of several cables and connectors), and communication between the AV source and AV devices such as DTVs.

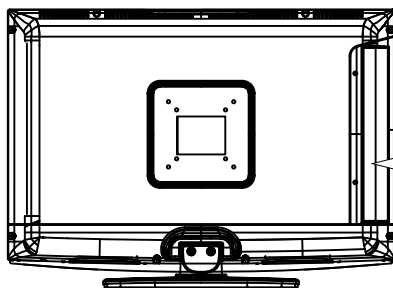

Connect the HDMI cable (not included) as shown:

Make sure you connect the cable from the source equipment (HDMI OUT) to this unit (HDMI IN).

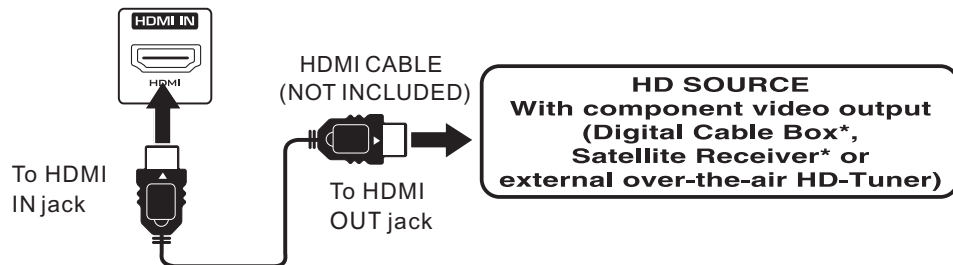

HD SOURCE
With component video output (Digital Cable Box*, Satellite Receiver* or external over-the-air HD-Tuner)

CONNECTIONS

CONNECTING A PC

Connect the 15-pin D-SUB PC/VGA connector from your computer to the 15-pin D-SUB PC/VGA input on this unit using a monitor cable and an audio cable (not included) as shown.

Make sure you connect the cable from the computer (VGA and AUDIO - PC OUT) to this unit (VGA and AUDIO - PC IN).

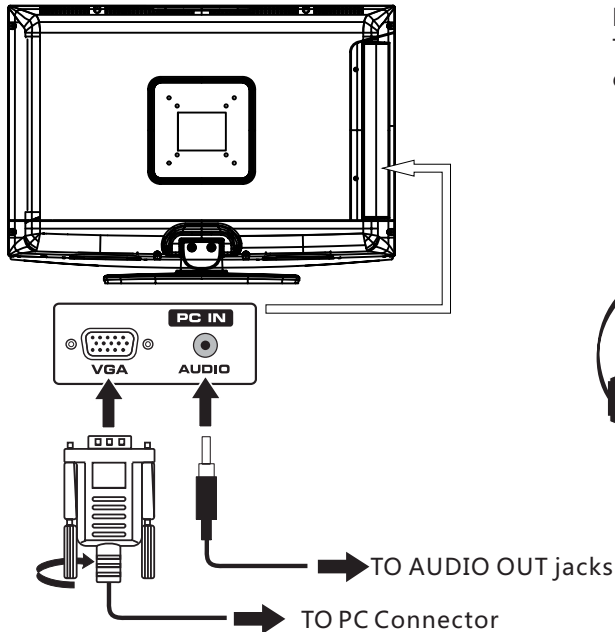

CONNECTING HEADPHONES

- Turn down the volume before connecting headphones to the unit, then adjust the volume to your desired level.
- When headphones are connected, no sound will come from the front speakers.

NOTE

Avoiding listening to sound at high levels for prolonged period of time. This may be harmful to you and may cause hearing loss.

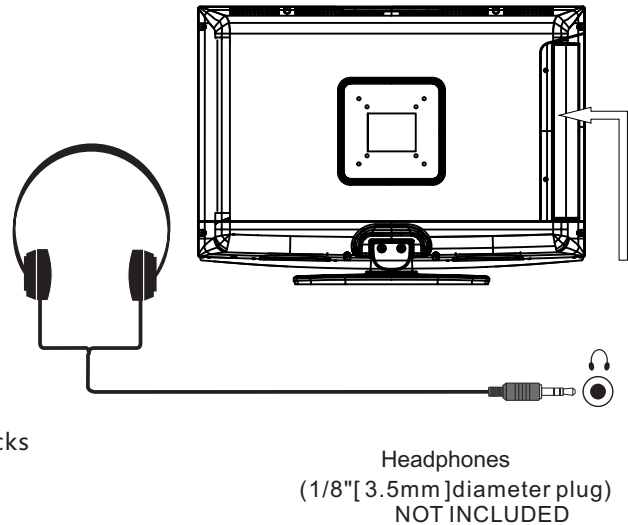

CONNECTING THE POWER CORD

You can power your TV unit by plugging the power cord into the AC socket on the side of the unit and into a wall AC power outlet. Check that the rated voltage of your unit matches your local voltage. Make sure that the switching adapter cord is fully inserted into the unit.

NOTE

- Insert the power plug fully into the socket outlet. (If the power plug is loose, it could generate heat and cause fire.)
- Ensure that the power plug is easily accessible.
- Ensure the earth pin on the power plug is securely connected to prevent electrical shock.
- An apparatus with CLASS I construction shall be connected to a power socket outlet with a protective grounding connection.
- Do not touch the power plug with a wet hand. (This may cause electrical shock.)
- Do not use any power cord other than that provided with this TV. (This may cause fire or electrical shock.)
- Do not damage the power cord. (A damaged cord may cause fire or electrical shock)
- Do not move the TV with the cord plugged in the socket outlet.
- Do not place a heavy object on the cord or place the cord near a high-temperature object.
- Do not twist the cord, bend it excessively, or stretch it.
- Do not pull on the cord. Hold onto the power plug body when disconnecting cord.
- Do not use a damaged power plug or socket outlet.

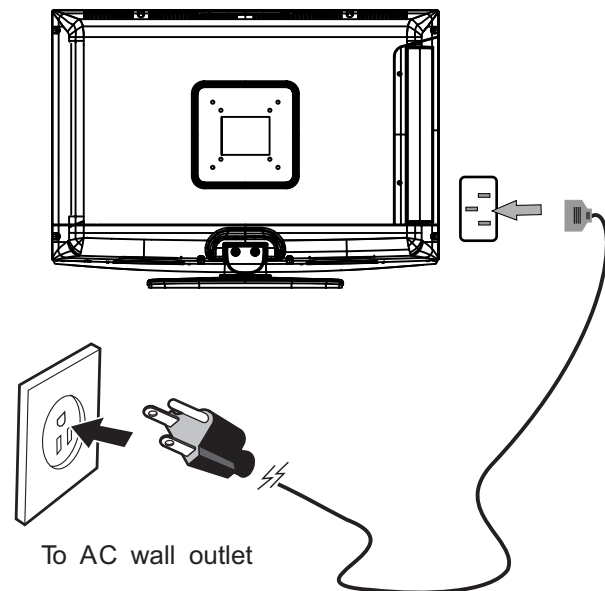

WALL MOUNT INSTALLATION

INSTALLING / REMOVING THE BASE STAND

WARNING : The LCD Display is very fragile, and must be protected at all times when removing the base Stand.

Be sure that no hard or sharp object, or anything that could scratch or damage the LCD display, comes into contact with it. Do NOT exert pressure on the front of the unit at any time because the screen could crack.

1. Disconnect all cables or cords connected to the unit .
2. Lay the unit down on a flat surface with the back side facing up. Please make sure to place a soft cushioned material (such as a pillow or thick piece of foam) beneath the screen.
3. To remove the base stand, loosen screws off the holes then pull downwards to release the base stand.
4. To install the base stand, put the stand into the hole at the bottom of the TV then insert screws to the holes and tighten.

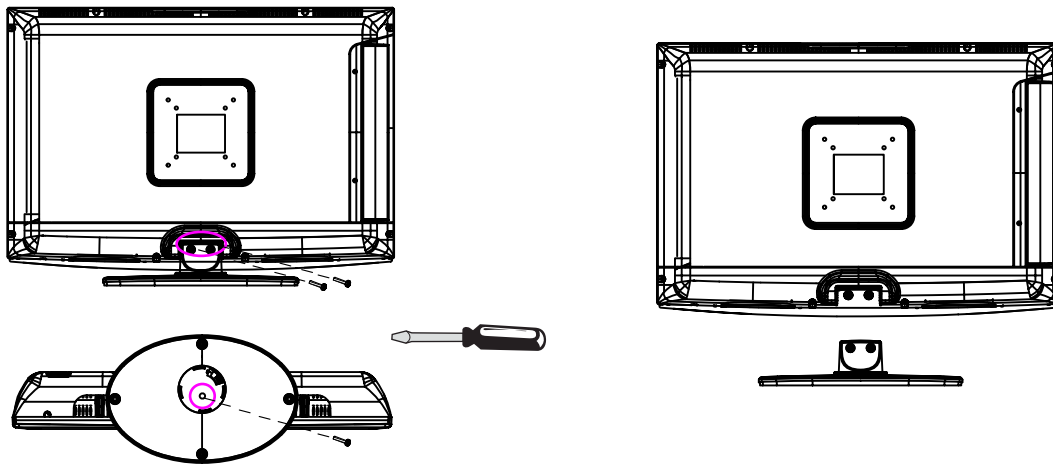

MOUNTING ON THE WALL

This unit is VESA-compliant, and is designed to be wall-mounted with a VESA-compliant 3" x 3" (75mm x 75mm) mounting kit designed for flat-panel TVs (not supplied). Mount this unit according to the instructions included in the mounting kit. Length of screw should not exceed 12 mm.

NOTE

Remove the base stand before mounting the unit on the wall.

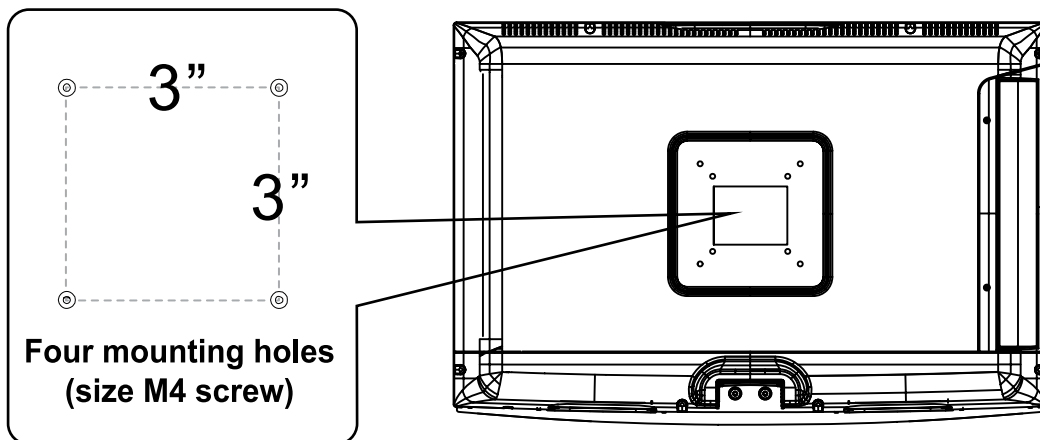

INITIAL SETUP

PUTTING THE UNIT ON A PROPER PLACE

When you turn on your television set for the first time, be sure to place it on a solid stable surface.

To avoid danger, do not expose the TV to water, or a heat source (e.g. lamp, candle, radiator).

Do not obstruct the ventilation grid at the rear and be sure to leave sufficient gaps around the unit.



SOURCE SELECTION

1. Press the **SOURCE** button on the remote control.
2. Use the ▲ or ▼ button to select the options (TV, AV, S-Video, Component, HDMI, VGA) and select any of them using the ► button or the **ENTER** button.
(The screen will change to your desired source).

Note:

Before watching please make sure all necessary cables and devices are connected.

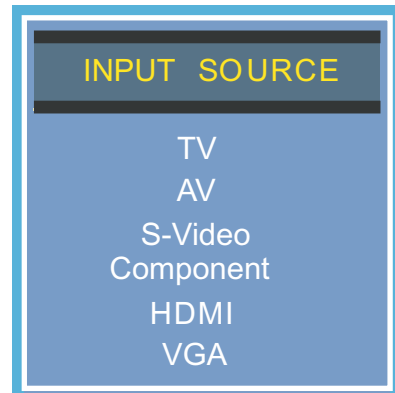

TURNING THE UNIT ON FOR THE FIRST TIME

After you have initially connected your TV antenna or cable (no set top box) turn the television ON.

A screen will display asking you to run a **Channel Auto Scan** to search and receive available local digital channels.

It is here where you will select antenna options and run **Channel Auto Scan**.

Channels will be stored in the TV tuner.

Press the **MENU** button on the remote control.
Using the ◀▶ buttons, scroll to highlight **TV mode**.
Press the ▼ button to highlight **AIR/CABLE**.

**Please run
Channel Auto Scan
in the TV menu**

INITIAL SETUP

How to Navigate

Air Mode: Select **AIR** when connected to an indoor/outdoor antenna.

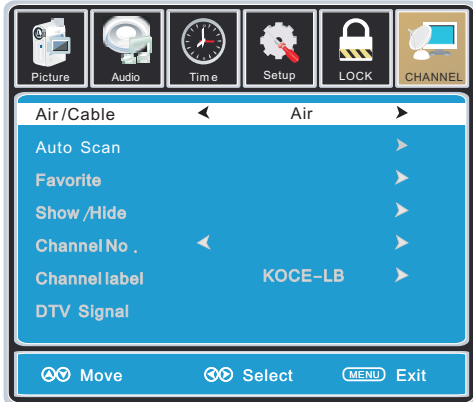

Press the **▼** button to highlight **AIR**.

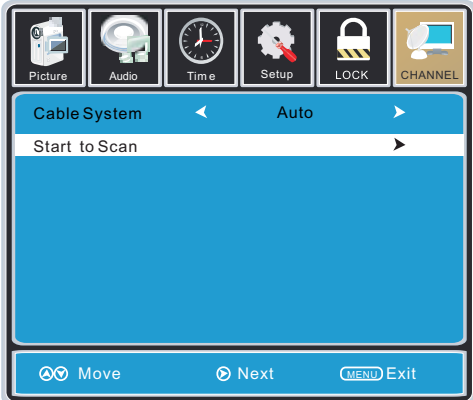

Press the **▶** button to select AUTOSCAN then press the **▶** button to start Channel Auto Scan.



Channel Auto Scan may take several minutes to complete.

Cable Mode: Select **CABLE** if you subscribe to a pay television service including satellite.

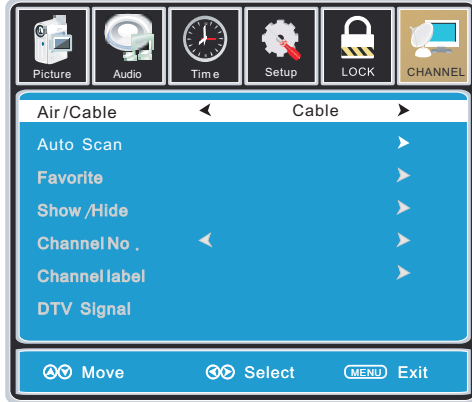

Using the **▶** button to highlight CABLE.

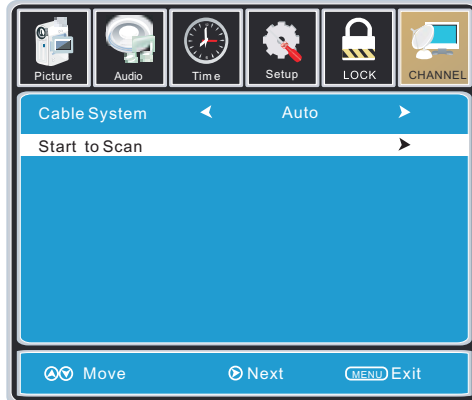

Press the **▶** button to select AUTOSCAN. Press the ENTER button and the cursor will move up and CABLE SYSTEM will be displayed next. Press the **▶** button to select STD > IRC > HRC > Auto (Auto is recommended). Press the **▶** button to select Auto Scan and press ENTER to start Channel Auto Scan.

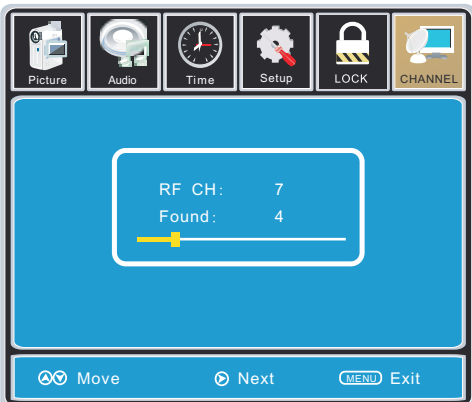

Channel Auto Scan may take several minutes to complete.

NOTE: For cable or satellite users with no TV antenna, there no need to run Channel Auto Scan. Connect your cable or satellite set top box to one of the available inputs on the TV for viewing.

TV SETUP



PICTURE MENU

The **PICTURE** menu offers options to enhance and refine the picture displayed on your TV based on ambient room light and personal preferences. Adjustment options include contrast, brightness, color, sharpness and color temperature.

How to Navigate:

Press the MENU button on the remote control. Navigate using the **Left** and **Right** buttons to select PICTURE.

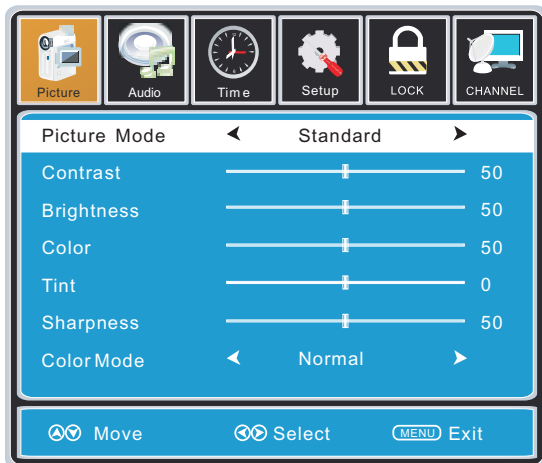

Press the **Left** button to highlight, then press the **Right** button to select your viewing preference from 4 factory options: STANDARD > DYNAMIC > MOIVE > PERSONAL.

The STANDARD setting is recommended for most viewing environments.

Depending on the ambient light level in the room, you may find one of the other options more pleasing.

To make more critical picture adjustments based on your own preferences in PERSONAL:

Use the **Left** button to highlight Contrast. Navigate using the **Left** and **Right** buttons to increase or decrease contrast intensity.



Use the **Left** button to highlight Brightness. Navigate using the **Left** and **Right** buttons to increase or decrease overall brightness.



TV SETUP



PICTURE MENU

The **PICTURE** menu offers options to enhance and refine the picture displayed on your TV based on ambient room light and personal preferences. Adjustment options include contrast, brightness, color, sharpness and color temperature.

Press the MENU button on the remote control. Navigate using the **Left** buttons to select PICTURE.

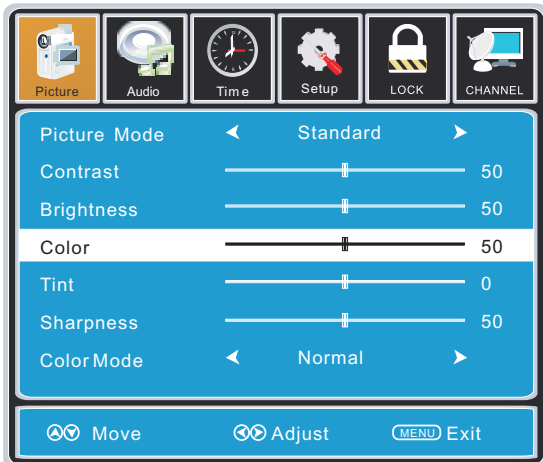

Use the **Left** button to highlight Color. Navigate using the **Left** buttons to increase or decrease color intensity.

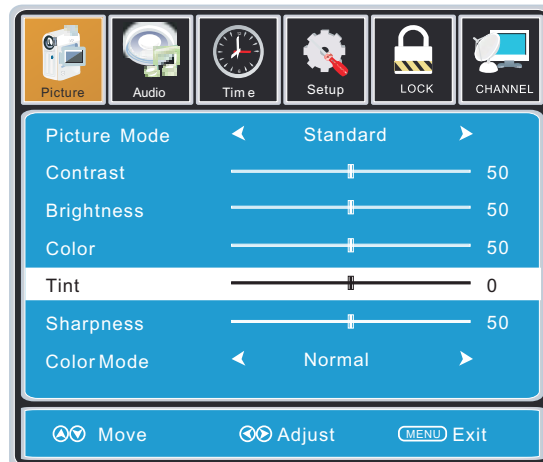

Use the **Left** button to highlight Tint. Navigate using the **Left** buttons to adjust colors toward green or reddish tint.

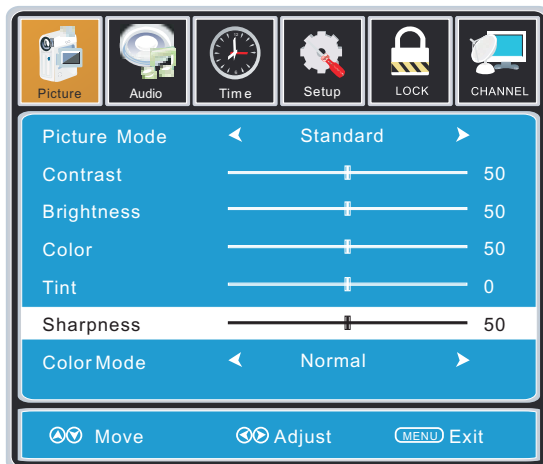

Use the **Left** button to highlight Sharpness. Navigate using the **Left** buttons to soften or view crisper edges in the picture.



Use the **Left** button to highlight Color Temperature. Navigate using the **Left** buttons to select COOL (more bluish tone), NORMAL or WARM. The default setting is NORMAL. WARM mode will provide color that is calibrated to D6500° Kelvin, the standard color that broadcast stations and the Motion Picture industry consider as the most accurate to view programming.

Note:

When adjustments are completed, you may select another menu by pressing the Menu button.

TV SETUP



AUDIO MENU

The **AUDIO** menu offers options to make sound enhancements while listening through the built-in speakers and personal preferences. Adjustment options include bass, treble, balance, surround and audio language.

How to Navigate:

Press the MENU button on the remote control. Navigate using the **Left** buttons to select AUDIO.

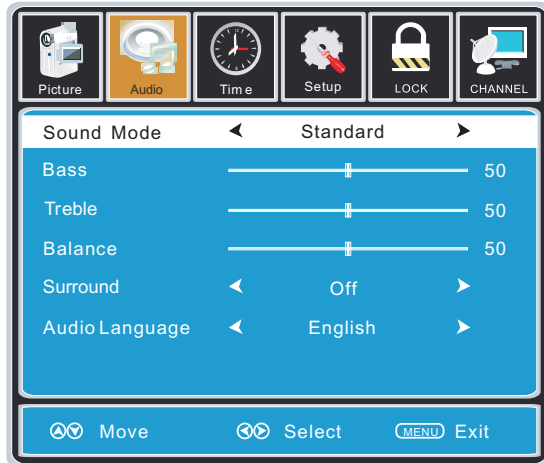

Press the **Left** button to highlight SoundMode, then press the **Left** button to select your sound preference from 4 factory options: STANDARD > MUSIC > MOVIE > PERSONAL.

The STANDARD setting is recommended for most sound environments.

Depending on the surroundings in the room, you may find one of the other options more pleasing.

To make more critical audio adjustments based on your own preferences in PERSONAL:

Use the **Left** button to highlight Bass. Navigate using the **Left** buttons to increase or decrease low frequency intensity.

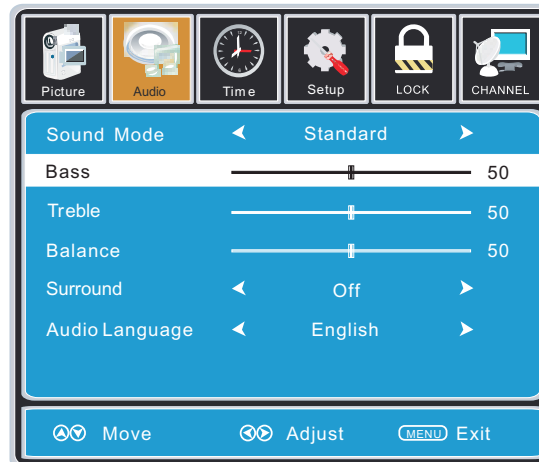

Use the **Left** button to highlight Treble. Navigate using the **Left** buttons to increase or decrease high frequency intensity.



TV SETUP



AUDIO MENU

The **AUDIO** menu offers options to make sound enhancements while listening through the built-in speakers and personal preferences. Adjustment options include bass, treble, balance, surround and audio language.

How to Navigate:

Press the MENU button on the remote control. Navigate using the **▲** buttons to select AUDIO.

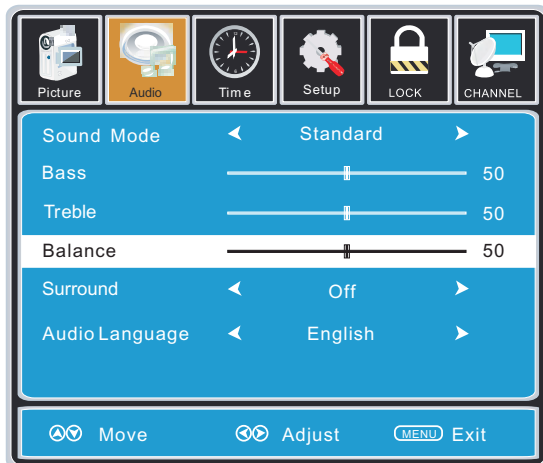

Use the **▲** button to highlight Balance. Navigate using the **◀ ▶** buttons to adjust sound towards the right or left speaker.



Use the **▲** button to highlight Surround. Navigate using the **◀ ▶** button to turn the dimensional surround effect ON or OFF. (for built-in speakers only).



Use the **▲** button to highlight Audio Language. Navigate using the **◀ ▶** buttons to select to listen to an alternative language broadcast (if available) English > Spanish > French. You may select an alternative language using the remote control by pressing MTS)

Note:

When adjustments are completed, you may select another menu by pressing the Menu button.

TV SETUP



TIME MENU

The **TIME** menu includes adjustment of settings for your local time zone and daylight savings time. The clock will adjust automatically after the initial Channel Auto Scan of available broadcast channels in your area.

How to Navigate:

Press the MENU button on the remote control. Navigate using the **Left** buttons to select Time.

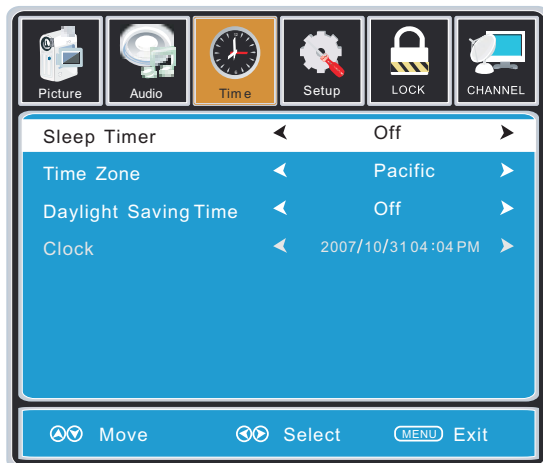

Use the **Left** button to highlight SleepTimer, then press the **Left** button to select among: 5min, 10min, 15min, 30min, 45min, 60min, 90min, 120min, 180min, 240min and off.

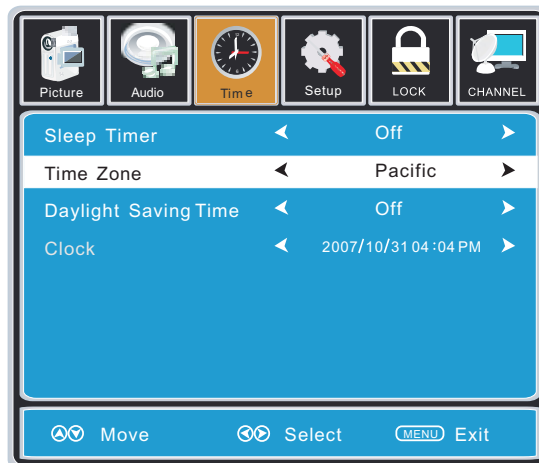

Use the **Left** button to highlight TimeZone, then press the **Left** button to select among: EASTERN > CENTRAL > MOUNTAIN > PACIFIC > ALASKA > HAWAII.

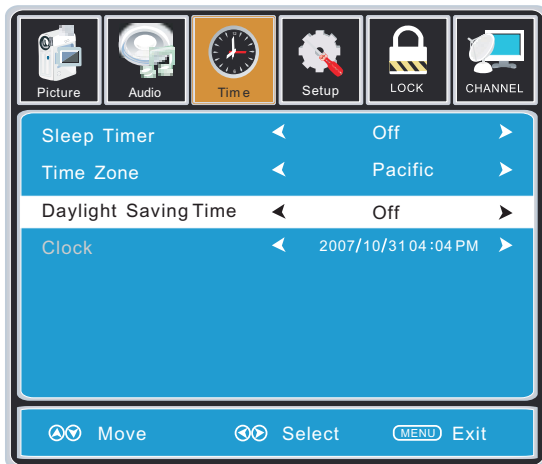

Use the **Left** button to highlight Daylight Saving Time. Navigate using the **Left** buttons to turn this feature on or off.

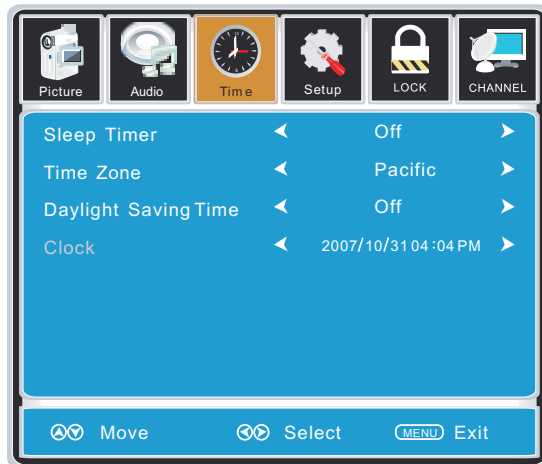

Clock: Display the time at present.

Note:

When adjustments are completed, you may select another menu by pressing the **Menu** button.

TV SETUP



SETUP MENU

In the **SETUP** menu you may change the initial set up of preferences that include settings for language, menu display, computer monitoring, closed captions, enhancement of black detail in the picture and resetting your TV back to its factory default status.

How to Navigate:

Press the MENU button on the remote control. Navigate using the **Left** and **Right** buttons to select **SETUP**.

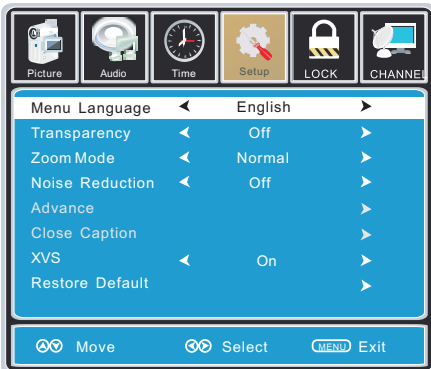

Use the **Left** button to highlight Menu Language. Press the **Left** button to select the language you prefer among English, French and Spanish.

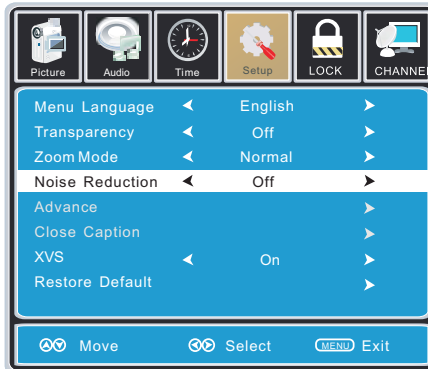

Use the **Left** button to highlight Noise Reduction. Navigate using the **Left** and **Right** buttons to reduce video noise: Off > Low > Medium > High (Default setting: medium)

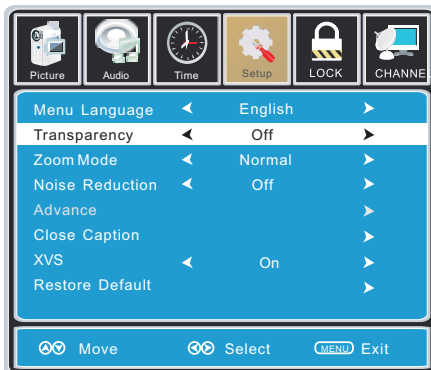

Use the **Left** button to highlight Transparency. Navigate using the **Left** and **Right** buttons to turn Off or On the translucent effect of the OSD.

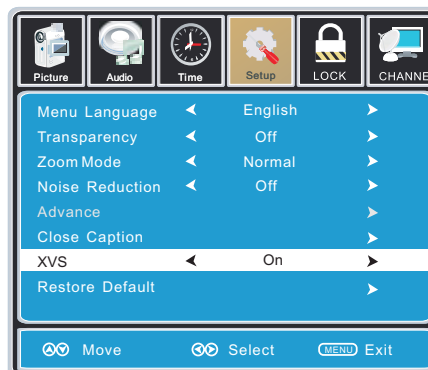

Use the **Left** button to highlight XVS. Navigate using the **Left** and **Right** buttons to select: Off > On. XVS provides noticeable black detail enhancement that may be preferred.

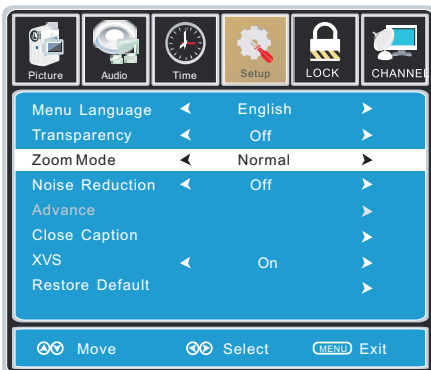

Use the **Left** button to highlight Zoom Mode. Navigate using the **Left** and **Right** buttons to select the viewing mode: Normal > Wide > Zoom > Cinema.

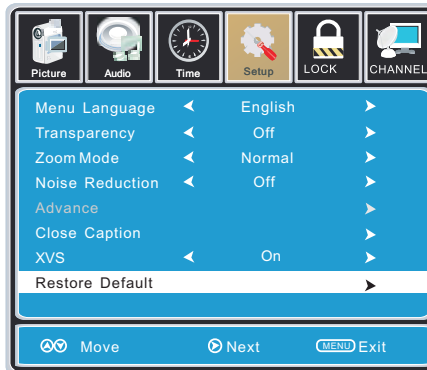

Use the **Left** button to highlight Restore Default. Press the **Left** button to automatically set all adjustments back to their original settings.



When prompted, Select "Yes" to confirm.

TV SETUP



SETUP MENU

The **SETUP** menu includes adjustments for activating the **Closed Caption** feature for display on the television and customizing CC display types and font styles.

How to Navigate:

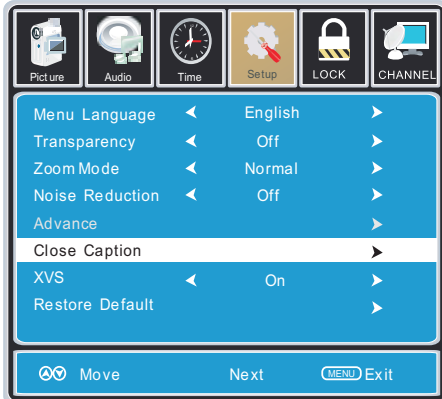

Press the **MENU** button on the remote control. Navigate using the **b**uttons to select **SETUP**. Press the **b**utton to highlight **Closed Caption** then press the **b**utton to select from the following options.

Use the **b**utton to highlight **Advance Selection**. Navigate using the **b**uttons to select **Service 1 - 6**.

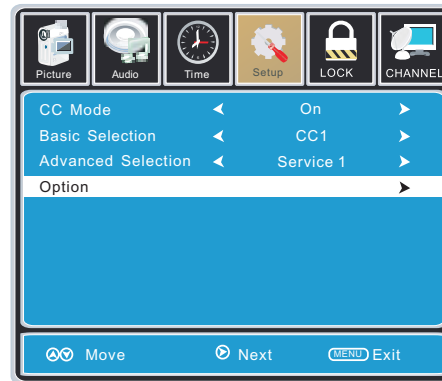
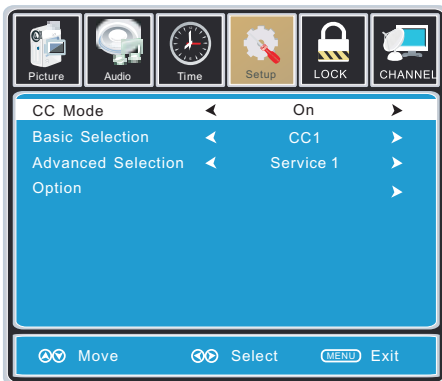

Use the **b**utton to highlight **CC Mode**. Navigate using the **b**uttons to select **Off > On > CC on Mute**.

Use the **b**utton to highlight **Option**. Press the **b**utton to enter a menu with options to customize text fonts, colors and opacities.

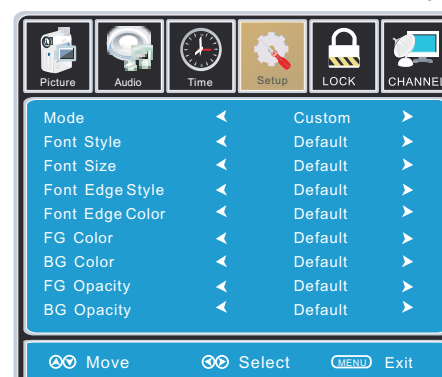
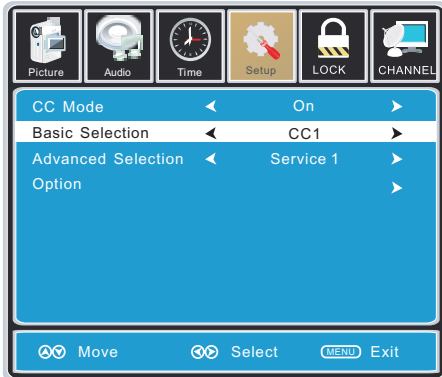

Use the **b**utton to highlight **Basic Selection**. Navigate using the **b**uttons to select **CC 1-4, Text 1-4**.

Note:

When adjustments are completed, you may select another menu by pressing the **Menu** button.

TV SETUP



SETUP MENU

In the **SETUP** menu you may adjust the position of images displayed on screen once you connect an input signal from your PC. Recommended resolution is 1366 x 768.

If your PC system uses a standard signal mode, the screen will adjust automatically.

Connect an optional 3.5mm audio cable for stereo sound.

How to Navigate:

After connecting to a **PC**, press the **SOURCE** button and highlight **VGA**, then press the **ENTER** button.

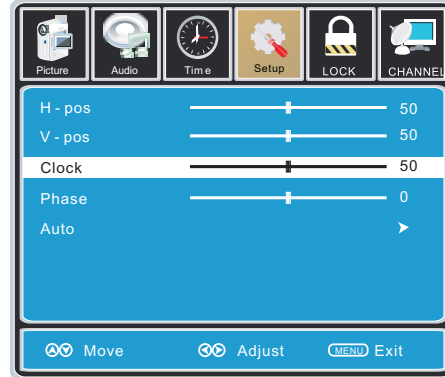
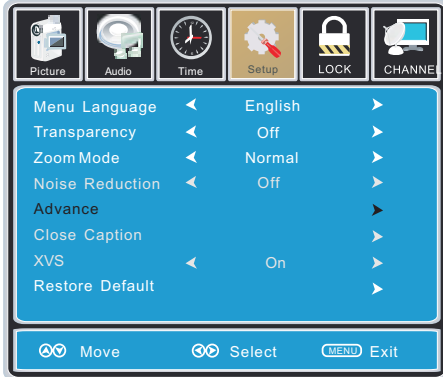

Press the **MENU** button on the remote control and navigate using the **Left** buttons to select **SETUP**. Press the **Right** button to highlight **Advanced**, then press the **Left** button to select from the following options.

Use the **Left** button to highlight **Clock**. Navigate using the **Left** buttons to control the width of the image.

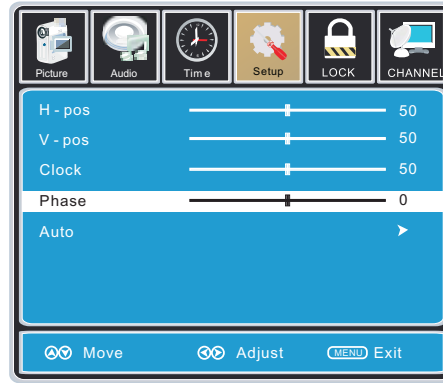
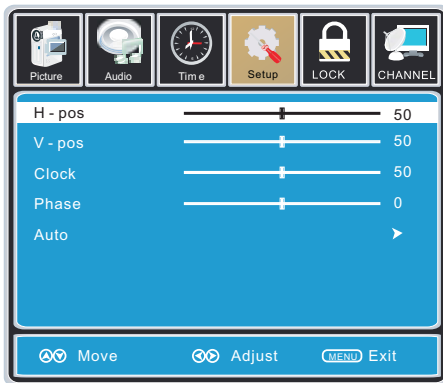

Use the **Left** button to highlight **H-POS**. Navigate using the **Left** buttons to adjust the position of images displayed from side to side.

Use the **Left** button to highlight **Phase**. Navigate using the **Left** buttons to improve focus and image stability.

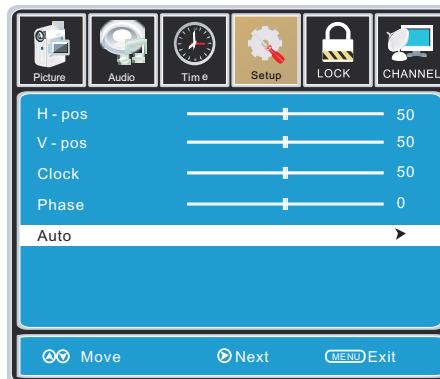
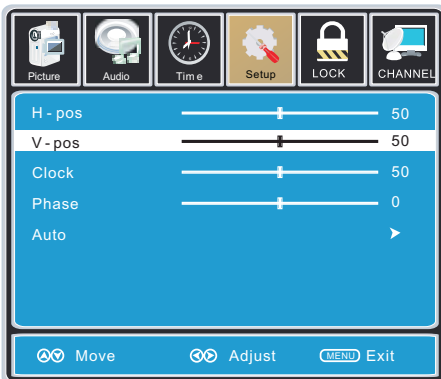

When prompted, Select "Yes" to confirm.

Use the **Left** button to highlight **V-POS**. Navigate using the **Left** buttons to adjust the position of images displayed up and down.

Use the **Left** button to highlight **AUTO**. Press the **Left** button to automatically adjust the display to the best setting.

TV SETUP



PARENTAL MENU

In the **PARENTAL** menu you may block television by inputting passwords. To gain access and select your preferences within the **Parental** menu make certain your input is set to TV.

How to Navigate:

Press the MENU button on the remote control. Navigate using the **Left** buttons to select **Parental**.



Press the **Left** button to highlight Enter Password. Enter your 4 digit code (factory default code is "0000") unless previously changed.



Use the numeric buttons to input a new 4 digit code by two times.



To change the password, press the **Left** button to display a screen to enter your new password, then confirm again.



To make changes to PARENTAL controls, Highlight SYSTEM LOCK then press the **Left** button to ON.

NOTE:

RRT Setting and Reset RRT are not user's adjustable settings.

TV SETUP



PARENTAL MENU

In the PARENTAL menu you may block television and movie programming based on U.S TV and movie rating guidelines. To gain access and select your preferences within the Parental menu make certain your input is set to TV.

How to Navigate:

Press the MENU button on the remote control. Navigate using the **Left** buttons to select Parental. Press the **Right** button to highlight ENTER PASSWORD. Enter your 4 digit code (factory default code is "0000") unless previously changed.

To set parental controls for television programming or DVD movies, press the **LOCK** buttons to highlight US. Navigate using the **Left** buttons to highlight TV/MPAA menu.

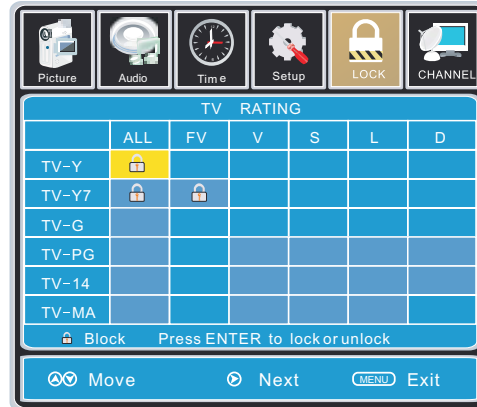
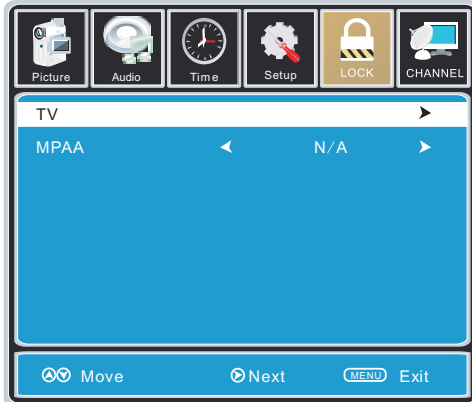

Highlight TV, then press the **Right** button to enter the TV Ratings menu to select your preference.

Age	Defined as
TV-Y	Recommended for all children.
TV-Y7	Directed to older children.
TV-G	General Audience.
TV-PG	Parental Guidance Suggested.
TV-14	Parental Strongly Cautioned.
TV-MA	Mature Audience only.

Contents	Defined as
FV	Fantasy Violence
D	Suggestive Dialogue
L	Strong Language
S	Sexual Situations
V	Violence

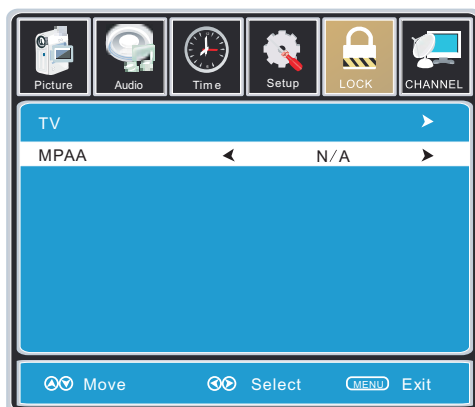

Rating	Defined as
N/A	Not rated.
G	GENERAL AUDIENCES, Suitable for all ages.
PG	PARENTAL GUIDANCE SUGGESTED - Some material may not be suitable for children.
PG-13	PARENTS STRONGLY CAUTIONED - Some material may be inappropriate for children under 13.
R	RESTRICTED, Under 17 requires accompanying parent or adult guardian for viewing in movie theaters.
NC-17	No one 17 or under admitted in movie theater.
X	Adult audience only.

Highlight MPAA then press the **Right** button repeatedly to select your movie rating preference.

TV SETUP



PARENTAL MENU

In the PARENTAL menu you may block television and movie programming based on Canadian TV and movie rating guidelines. To gain access and select your preferences within the Parental menu make certain your input is set to TV.

How to Navigate:

Press the MENU button on the remote control. Navigate using the buttons to select Parental. Press the button to highlight ENTER PASSWORD. Enter your 4 digit code (factory default code is "0000") unless previously changed.

To set parental controls for television programming or DVD movies, press the buttons to highlight Canada. Navigate using the buttons to highlight Canada English/Canada French menu.

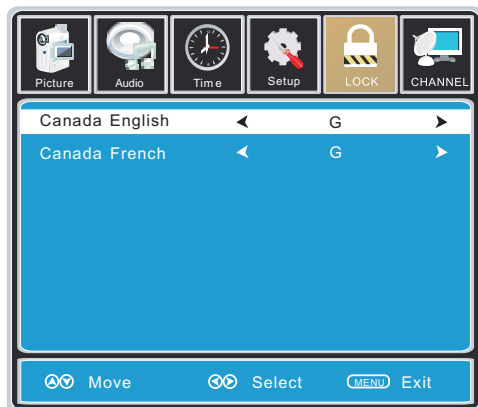

Rating	Description
E	Exempt.
C	Children.
C8 +	Recommended for children age 8 and older.
G	GENERAL AUDIENCES, Suitable for all ages
PG	PARENTAL GUIDANCE SUGGESTED -Some material may not be suitable for children.
14 +	Viewers 14 years and older
18 +	Adult Programming.

Navigate using the button to highlight CANADA ENGLISH, then press the button repeatedly to select your ratings preference.

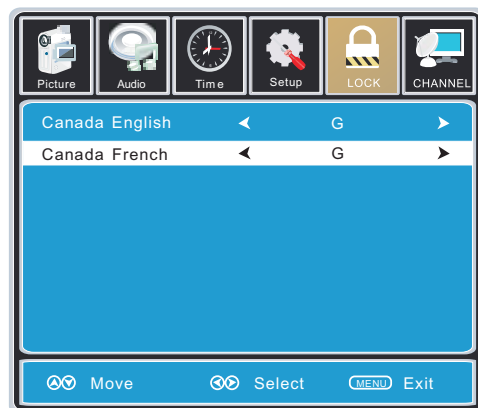

Rating	Description
E	Exempt.
G	GENERAL AUDIENCES, Suitable for all ages.
8 ans+	Not recommended for young children.
13 ans+	Not suitable for children under the age of 13.
16 ans+	Not suitable for children under the age of 16.
18 ans+	Adult Programming.

Navigate using the button to highlight CANADA FRENCH, then press the button repeatedly to select your ratings preference.

NOTE:

When adjustments are completed, you may select another menu by pressing the **Menu** button.

TV SETUP



TV MENU

The TV menu provides for the setup of your television to receive TV channels, store your favorites, add or skip channels and label them by their call letters.

How to Navigate:

Press the MENU button on the remote control. Navigate using the **Left** buttons to select TV. Press the **Right** button to highlight your preferences.

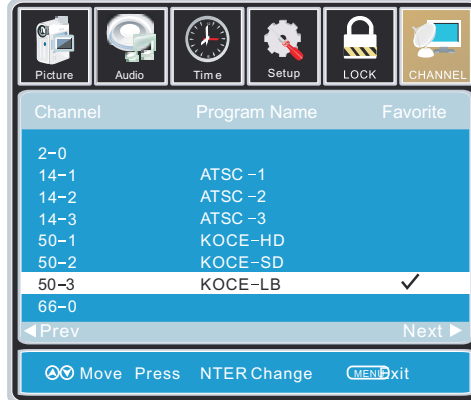
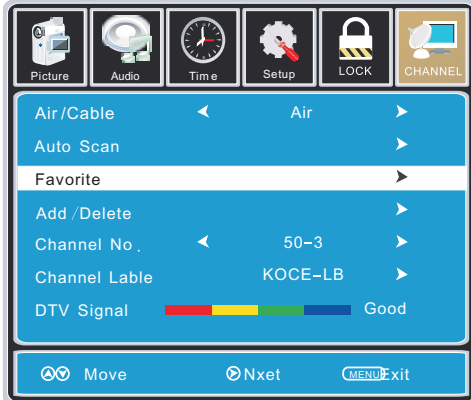

Highlight FAVOURITE to add channels to your Favorites List. Navigate using the **Left** buttons to select channels to be added or deleted from your list. Press the ENTER button to add or delete a channel. A checkmark indicates a channel has been added. You may also display your favourite list from the remote control by pressing FAV.

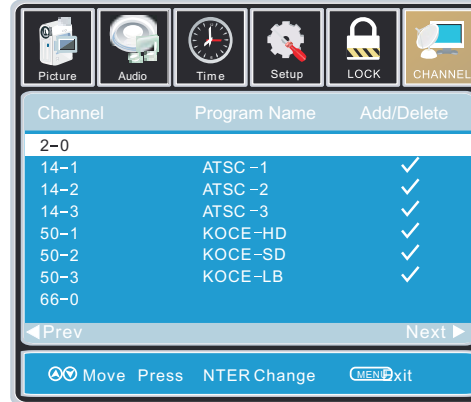
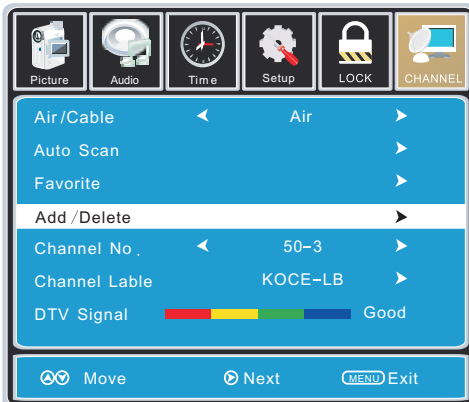

Highlight to select ADD/DELETE or skip channels already in memory. Navigate using the **Left** buttons to access the list of available channels. Press the ENTER button to change the channels status. A checkmark indicates a channel has been added.

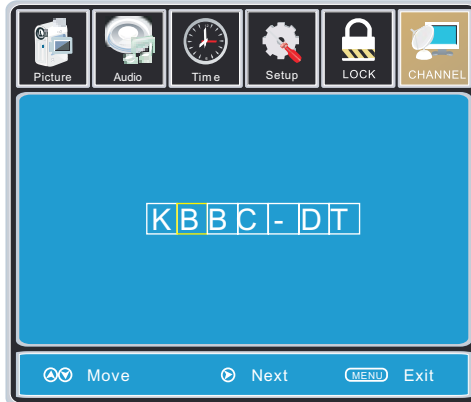
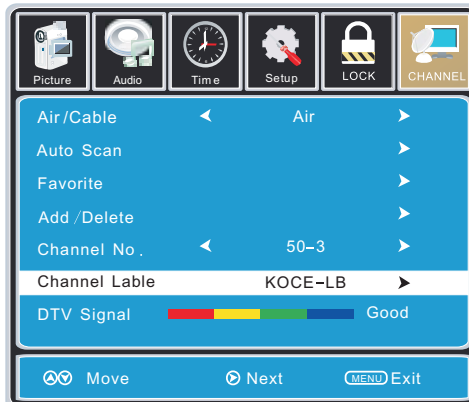

Highlight CHANNEL LABEL to name or rename a broadcast channel. Navigate using the **Left** button to enter the screen menu to re-label a channel. Use the **Left** buttons to spell out each letter, number or character. Use the **Right** buttons to advance to the next space.

DISPLAY MODE

PC FORMATS

SUPPORTED PC INPUT MODE			
Resolution	Horizontal Scanning Frequency (KHz)	Vertical Scanning Frequency (Hz)	Format
640 X 480	31.5	60.0	DOS
640 X 480	37.9	72.0	VESA
640 X 480	37.5	75.0	VESA
800 X 600	35.1	56.2	VESA
800 X 600	37.9	60.0	VESA
800 X 600	48.1	72.0	VESA
800 X 600	46.9	75.0	VESA
1024 X 768	48.4	60.0	VESA
1024 X 768	56.5	70.11	VESA
1024 X 768	60.0	75.0	VESA
1366 X 768	47.7	60.0	VESA
1920 X 1080	66.6	60.0	VESA

NOTE:

This product does not support the display mode not listed above.
In order to achieve the best display effect, please select the above-listed 11 display modes input signal.

Because of the difference of display drivers output signal (especially non-standard signal output), the display image may appear little disturbance which can be adjusted through "AUTO" button on the PC menu.

To prolong this unit's service life, please set your computer to power management mode.

VIDEO FORMATS

SUPPORTED COMPONENT / HDMI INPUT MODE			
Resolution	Horizontal Scanning Frequency (KHz)	Vertical Scanning Frequency (Hz)	Format
720 x 480	31. 47	59. 94	480 i
720 x 480	15. 734	59. 94	480 p
1280 X 720	37. 5	50	720 p
1280 X 720	45	60	720 p
1920 x 1080	31. 25	50	1080 i
1920 x 1080	33. 75	60	1080 i
1920 x 1080	27	24	1080 p
1920 x 1080	56. 25	50	1080 p
1920 x 1080	67. 50	60	1080 p

NOTE:

The above listed formats are also related to the AV devices you are about to connect. Before you connect this unit with others please read all instructions carefully and make sure all necessary cables are connected.

This unit may be incompatible with some other formats which are not meet the above conditions.

SPECIFICATION

Model Description		24"LCD TV
Panel	Panel Type	LCD Panel
	Diagonal Size	24 inches
	Screen Format	16:9
	Resolution	1920 x 1080
	Brightness	300 nit
	Contrast	1000 : 1
	View Angle	170(H)/160(V)
	Response Time	5 ms
	Maximum Color	16.7 M colors
Systems	Color System	ATSC/QAM/NTSC
	Sound System	M
	Audio System	BTSC
	Sound Output	L/R Speaker: 3 W + 3 W
Input / Output Jacks	RF Input	75 ohm external terminal
	HDMI Input	Video: 480i, 480p, 720p, 1080i, 1080p. Audio: Two channel linear PCM 32, 44.1 and 48kHz, 16, 20 and 24 bits
	PC-RGB Input	D-sub 15pin G: 0.7Vp-p, 75ohms B: 0.7Vp-p, 75ohms R: 0.7Vp-p, 75ohms
	S-Video Input	Y: 1.0Vp-p, 75ohms C: 0.3Vp-p, 75ohms
	Composite Video Input	1.0 Vp-p, 75ohms RAC
	Component/Y Pb Pr Input	RAC Y: 1.0 Vp-p, 75ohms, 0.3V negative sync Pb: 0.7Vp-p, 75ohms Pr: 0.7Vp-p, 75ohms
	Sound Input	Phono jack 1: For CVBS/Component Audio input Phono jack 2: For PC-RGB Audio input 500mV rms, Impedance: 20k ohms
	Headphone Output	3.5 mm diameter jack
Power	Power Requirement	100-240V~ 50/60Hz
	Power Consumption	≤ 55 W
	Standby Consumption	≤ 1 W

This manual is only for your reference.
Specifications are subject to update without prior notice.

TROUBLESHOOTING GUIDE

SYMPTOM

CAUSE (AND REMEDY)

TV

Bad Picture (snow, multiple images distortion, blurry)

- Check the location of the antenna and adjust it if necessary.
- Make sure the antenna cable is firmly connected.
- Make sure all input cables are firmly connected.

No sound.

- Increase the volume.
- Check whether the mute function has been activated on the Remote Control.

Black and White picture.

- Check the PICTURE setting within the PICTURE menu.
- Check to make sure the program you are watching is broadcast in Color and not Black & White.

No picture or sound.

- Make sure the unit is plugged in and turned on.
- Make sure that the ATV mode is selected.
- Try a new channel to check for possible station trouble.
- Make sure the antenna is connected properly.
- Increase the volume.
- Make sure the antenna or audio/video source device is working properly.
- Make sure all cables are firmly connected.
- Check for local interference.

Colored patches of picture.

- Make sure there are no unshielded electrical devices nearby that are causing interference.
- Turn the TV off for 30 minutes, then try it again.

Panel function key does not respond correctly.

- Under the influence of electrostatic phenomenon, the product may malfunction and require user power reset.
- Unplug and re-plug the AC power cord.

The display monitor's panel goes hot.

- LCD TV takes inside light phosphor. It may increase the temperature of the screen in some occasions. It's not a defect.

Unusual dots

- Black dots and Bright points may appear on the LCD screen. This is a structural property of the LCD panel and is not a defect.

Stripes on screen

- Adjust the impulse phase may decrease stripes. (RGB IN)

The top of the monitor gets hot.

- It may occur during long-time working. It's not a defect.

Unable to select a certain channel.

- The channel may be skipped. Choose this channel by directly selecting the buttons from the remote control.

Disorder display at power on.

- This may be caused because of a very short interval between POWER OFF and ON.
- Unplug the power and restart.