



OPERATING MANUAL

FIRELARM 2500

4 ZONE FIRE ALARM CONTROL PANEL



Warranty

CPG products are covered by a limited warranty. See CPG's warranty statement for more information (document #780-0762).

Contents

1	Overview	1-1
1.1	General description	1-1
1.2	System features	1-1
1.3	Specifications	1-2
1.3.1	Electrical specifications	1-2
1.3.2	Housing	1-2
1.3.3	Service use: NFPA-72	1-3
1.3.4	Listings and approvals	1-3
2	Operation	2-1
2.1	Touchpad	2-1
2.2	Visual indicators (LEDs)	2-2
2.3	Normal Standby Condition	2-3
2.4	Silence and reset operation	2-3
2.4.1	Silencing a non-normal condition (buzzer or NAC)	2-3
2.4.2	Resetting an alarm condition	2-3
2.4.3	Resetting a trouble condition	2-3
2.5	Alarm, trouble, and supervisory conditions (by panel LED label)	2-3
2.5.1	Ground fault	2-3
2.5.2	Annunciator trouble	2-3
2.5.3	NAC trouble / silence	2-4
2.5.4	Supervisory trouble	2-4
2.5.5	Initiating zone trouble	2-4
2.5.6	2-4
2.5.7	Initiating circuit alarm	2-4
2.5.8	Auxiliary power output conditions	2-5
2.5.9	Battery power conditions	2-5
2.5.10	AC power conditions	2-5
2.5.11	System trouble	2-5
2.5.12	Supervisory initiating device circuit	2-5
3	Installation	3-1
3.1	Safety message to installers	3-1
3.2	NFPA and UL installation requirements	3-1
3.2.1	Requirements for all installations	3-1
3.2.2	Requirements for Local Fire Alarm Systems	3-1
3.2.3	Requirements for Auxiliary Fire Alarm Systems	3-1
3.2.4	Requirements for Remote Station Fire Alarm Systems	3-1
3.2.5	Requirements for Central Station Fire Alarm Systems	3-2
3.3	Installing the cabinet (and optional bezel)	3-2
3.4	Wiring	3-3
3.5	Quick Reference Operating Instructions form	3-3
3.6	Zonal Digital Alarm Communicator Transmitter (optional ZDACT)	3-3
3.7	Battery size requirements	3-3
3.8	Notification Appliance Circuits Connections	3-7
4	Configuration and Programming	4-1
4.1	Selecting connected device options (DIP switches)	4-1

Contents

- 1
- 2
- 3
- 4
- 5
- A
- B
- C
- D

4.1.1 *B1 Strobe device*..... 4-1

4.1.2 *B1 Temporal pattern* 4-1

4.1.3 *Reverse polarity circuits configuration* 4-2

4.1.4 *Annunciator disconnect*..... 4-2

4.1.5 *Waterflow detectors* 4-2

4.1.6 *Alarm verification*..... 4-2

4.1.7 *Style D (Class A) operation*..... 4-2

4.2 Program configuration of the panel..... **4-2**

4.2.1 *ZDACT configuration* 4-4

4.2.2 *Password settings*..... 4-6

5 Maintenance **5-1**

5.1 **Auto Reset feature (One-man test)** **5-1**

5.2 **Inspection and Test procedure** **5-1**

5.2.1 *Testing the control panel*..... 5-1

5.2.2 *Testing the Remote Annunciator* 5-2

5.2.3 *Testing the Zonal Digital Alarm Communicator Transmitter (ZDACT)* 5-2

Appendix A. Optional Accessories **A-1**

A.1 **Remote Annunciator with Liquid Crystal Display (RALCD)**..... A-1

A.2 **Zonal Digital Alarm Communicator Transmitter (ZDACT)**..... A-2

A.3 **Style Z (Class A) Module for NAC circuits (CAM)** A-3

A.4 **Master Box Module (Model MBM)** A-4

Appendix B. Smoke Detector Compatibility **B-1**

Appendix C. NAC Compatibility..... **C-1**

Appendix D. Ordering Information **D-1**

Appendix E. Quick Reference Operating Instructions **E-1**

1 Overview

1.1 General description

The **FIRELARM 2500** is an economical, conventional Fire Alarm Control Panel (FACP) with an extensive list of features. When installed with an appropriate battery backup supply, the **FireLarm 2500** provides a complete fire alarm control system for most applications. Available accessories include liquid crystal display (LCD), zonal digital alarm communicator transmitter (ZDACT), remote annunciators, and NAC Style Z (Class A) modules.

1.2 System features

- UL Listed
- 4 alarm initiating device circuits (IDCs) Style D (Class A) or Style B (Class B) configurable
- 2 Notification Appliance Circuits (NACs), Style Y (Class B) (Optional Style Z (Class A) module available)
- 2.5 Amps total current for NAC and auxiliary power circuits
- 1 supervisory initiating zone
- Reverse polarity output for alarm, or alarm and trouble signals
- Reverse polarity output for trouble and supervisory signals
- Auxiliary power output, up to .5 Amp
- Auxiliary alarm contacts rated 2A@30VDC
- Auxiliary trouble contacts rated 2A@30VDC
- Compatible with 2- and 4-wire smoke detectors
- Power limited circuits
- Custom descriptions for each zone (with optional LCD display or LCD annunciator)
- On-board 2x16 character LCD display (optional)
- Remote annunciator with 2x16 LCD character display (optional), maximum of 2 per panel
- On-board Zonal Digital Alarm Communicator Transmitter (optional)
- Built in piezo-buzzer with distinctive trouble, supervisory and alarm signals
- One-man test feature (Auto Reset)
- Fire drill feature
- 12 hour trouble reminder
- Password protection

1

2

3

4

5

A

B

C

D

E

1.3 Specifications

1.3.1 Electrical specifications

Primary (AC) power: Accessory (battery) voltage	120VAC, 60 Hz, 1.5A max 24VDC; (charging current, 1.0A)
Control Unit Requirements: Standby current Alarm current	110mA, 24VDC (not including auxiliary devices and modules) □ 200mA, 24VDC (not including auxiliary devices and modules)
Output Ratings: System alarm contacts System trouble contacts 4-wire smoke detector power Auxiliary power Max ripple voltage	SPDT, 2A, 30VDC, 0.6 power factor SPDT, 2A, 30VDC, 0.6 power factor 24VDC, .5A power limited, regulated, resetable*** 24VDC, .5A power limited, regulated, resistive load, non-resetable*** 500mV (4-wire smoke and aux. power circuits)
Optional Accessories: Remote annunciator RALCD Max number per panel Style Z (Class A) Module (CAM) ZDACT	Power limited, 100mA, 24VDC per unit, (see Appendix A) 2 0mA standby, 25mA alarm (see Appendix A) 90mA max in alarm (See Appendix A)
Notification Appliance Circuit (Bells): ** Current, nominal Max short circuit current Normal supervisory current □ End of line resistance	24VDC, 2.0A (max) ***, power limited 2.5A, power limited 2.7mA 5.1K ohms
Initiating Device Circuits (Zones): Smoke capacity (24VDC) † Standby voltage Max ripple voltage Max short circuit current Normal standby current Alarm current threshold Max impedance for alarm End of line resistance Max. line resistance	25 detectors, 0.1mA type; 20 detectors, 0.12mA type 27.5 VDC (max) to 16 VDC (min) 500mV 60mA, power limited 4.5mA approx. 20mA 1.5K ohms 5.1K ohms 100 ohms
Supervisory Initiating Circuit: †† Max voltage Max short circuit current Max circuit resistance Normal supervisory current Trouble current End of line resistance	27.5 VDC 10mA, power limited 100 ohms 3.5mA 2mA (low trouble) 5mA (supervisory) 5.1K ohms
Reverse Polarity Outputs: ††† □ Max voltage □ Max line current	24 VDC 15mA

NOTE ■

* All terminals are capable of up to #12 AWG wire.

** Use any UL listed polarized notification appliances rated 24VDC.

***Total system current for auxiliary device powered by the panel not to exceed 2.5 amps. This includes NAC power, auxiliary power, reverse polarity outputs, four wire detector power, and remote annunciator. The latter three are 0.5A max combined.

† Max load: 2.5mA. Use only detectors that are listed in compatibility list.

†† Use supervisory devices with normally open contacts.

††† Power limited

1.3.2 Housing

- Type 18-gauge sheet steel with hinged, removable, locked door.

- Size 18- $\frac{1}{2}$ " x 14- $\frac{1}{4}$ " x 3- $\frac{3}{4}$ "
- Finish Red.
- Knockouts Combination $\frac{1}{2}$ " / $\frac{3}{4}$ ", 2 on each side, top and back.
- Option Bezel trim for semi-flush mounting.

1.3.3 *Service use: NFPA-72*

- Local
- Auxiliary (PPU)
- Remote Station (PPU)
- Central Station (PPU)
- *PPU - Protected Premise Unit.*

1.3.4 *Listings and approvals*

- UL Listed (S6521, Guide UOJZ)
- CSFM Listed (7165-0476:154)

1

2

3

4

5

A

B

C

D

E

2 Operation

2.1 Touchpad

The touchpad provides user control over the operation of the panel. It is readily accessible when the cover is open.

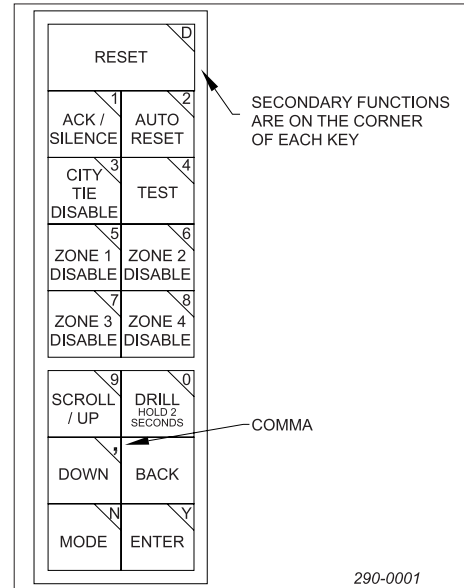

Figure 2-1. FireLarm 2500 Touchpad.

Primary Function	Primary Function Description
	Resets all alarm circuits if condition has been corrected, removes power from initiating device circuit and auxiliary power from smoke detectors for 7 seconds.
	Disables notification appliance circuit and trouble buzzer. Silencing an alarm condition will cause bell trouble LED to flash. If both buzzer and NAC are on, the first press of ACK/SILENCE will silence the buzzer; the second press will silence the NAC. NOTE Silencing an alarm or trouble on one zone will not prevent a subsequent alarm or trouble from another zone.
	Toggles one-man test mode. See section 5.1 Auto Reset.
	Toggles reverse polarity circuits from generating alarm or trouble condition, causes system trouble and trouble at the supervising station
	Turns on all indicators, alarm and trouble outputs.
	Toggles ability for each zone to generate alarm condition. Disabled state causes zone trouble and system trouble. Does not function if configured for waterflow.
	Scrolls through trouble conditions, if present. For configuration mode, scrolls through the character set when entering zone labels.
	Pressing for 2 seconds will initiate a fire drill.
	Used in configuration mode, for saving a configuration and various functions.
	To begin program configuration and change the configuration mode.
	Used in configuration mode; return to the previous screen.
	Used in configuration mode, and various functions.

2

3

4

5

A

B

C

D

E

Secondary Function	Secondary Function Description
(DELETE)	Deletes the value at the cursor location when entering numeric values.
	Numeric entry of 1.
	Numeric entry of 2.
	Numeric entry of 3.
	Numeric entry of 4.
	Numeric entry of 5.
	Numeric entry of 6.
	Numeric entry of 7.
	Numeric entry of 8.
	Numeric entry of 9.
	Numeric entry of 0.
(YES)	Confirm change of data.
(NO)	Abort change of data.
(comma)	Enter 2-second delay for ZDACT phone number.

2.2 Visual indicators (LEDs)

The LED's give immediate visual indication of panel status.

Figure 2-2. FireLarm 2500 LED label

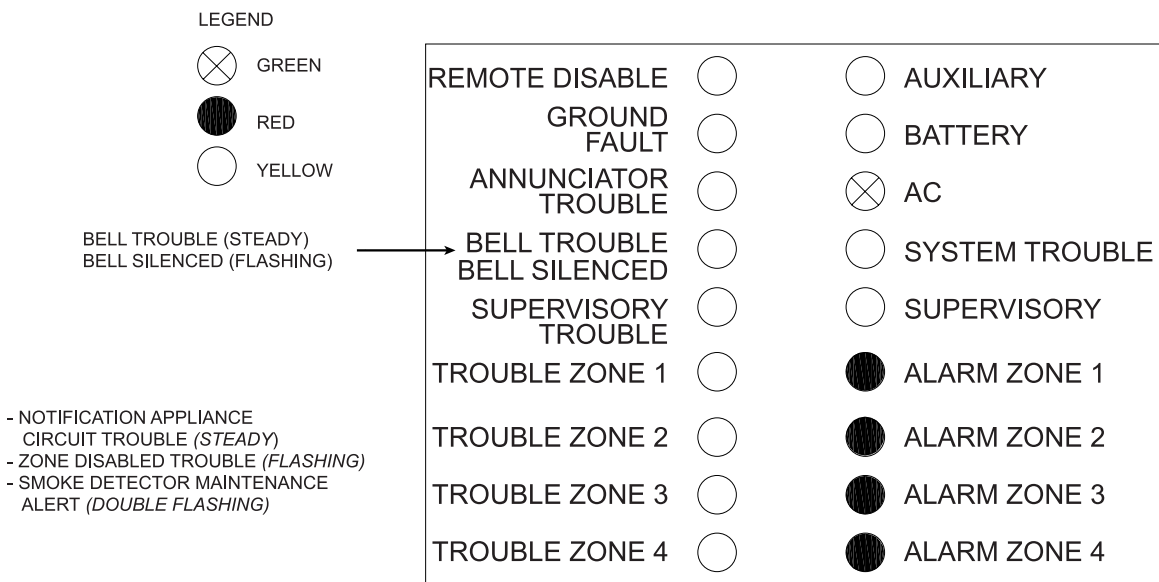

290-0002

2.3 Normal Standby Condition

- The AC LED indicator is on with all other LED's off.
- The fire alarm system is constantly monitoring all circuits for alarm signals, faults and remote communication.
- The panel optional LCD will display **SYSTEM NORMAL** when the system is operating as normal.

2.4 Silence and reset operation.

2.4.1 Silencing a non-normal condition (buzzer or NAC)

- Press **SILENCE**.
- Press **SILENCE** again to silence NAC if buzzer was silenced first.

NOTE Where audible and/or visual indicators are being used as an evacuation signal, do not silence an alarm condition without investigating and determining that an emergency condition does not exist.

WARNING Alarms initiated from zones that are in the waterflow mode cannot be silenced. The panel must be reset to silence audible alarm devices. Silencing an alarm condition will cause the bell trouble LED to flash.

2.4.2 Resetting an alarm condition

- Determine the cause of the alarm condition and if necessary remove the cause.
- Press **RESET**.

2.4.3 Resetting a trouble condition

- Determine the cause of the trouble condition and remove the cause.
- This condition is self-restoring. When all trouble conditions are removed all indications will return to normal.

NOTE When an alarm initiating device zone is operated in a Style D (Class A) mode any trouble condition will require pressing **RESET** to restore the panel to normal after the fault has been corrected. A trouble condition of an indicating circuit that is the result of a current in excess of 2.5 amps requires pressing **RESET**. See Caution in section 2.5.3 NAC trouble / silence.

2.5 Alarm, trouble, and supervisory conditions (by panel LED label)

2.5.1 Ground fault

A ground fault will result in the following:

- Operation of the ground fault LED.
- Operation of all system trouble indications (see section 2.5.11 *System trouble*).
- **GROUND FAULT** is displayed on the optional LCD.

2.5.2 Annunciator trouble

The annunciator trouble is used to indicate a trouble condition on the optional remote annunciator if used. Annunciator trouble is caused by a communication fault from lack of response or incorrect transmission and will result in the following.

- Operation of the annunciator trouble LED
- **REM. ANNUNCIATOR TROUBLE** is displayed on optional LCD

2

3

4

5

A

B

C

D

E

2.5.3 NAC trouble / silence

Notification appliance circuit:

An increase of current to approximately 3.5mA when not in alarm or a decrease in current to approximately 1.5mA on the notification appliance circuit will result in the following:

- Operation of the bell trouble LED.
- Operation of all system trouble indications (section 2.5.11 *System trouble*).
- Trouble zone number and name is displayed on the optional LCD.

NOTE A current in excess of 2.5 amps, when the panel is in the alarm condition will result in a bell trouble. This will require pressing **RESET** to clear.

CAUTION A problem in an audible or visual device may not be apparent when the panel is in a normal standby condition. If a notification device indicates a trouble condition when the panel is in an alarm condition, the problem must be located and corrected.

2.5.4 Supervisory trouble

A decrease of current on the supervisory initiating device circuit to approximately 2mA will result in the following:

- Operation of the supervisory trouble LED.
- Operation of all system trouble indications (see section 2.5.11 *System trouble*).
- **SUPERVISORY TROUBLE CONDITION** is displayed on the optional LCD.

2.5.5 Initiating zone trouble

An increase in current to a level between 7mA to 20mA or a decrease of current to below 3.0mA or pressing **ZONE DISABLE** for any initiating device circuit will result in the following:

- Operation of the zone trouble LED.
- Operation of all system trouble indications (see section 2.5.11 *System trouble*).
- Trouble zone number and name is displayed on the optional LCD.

NOTE When the circuits are operated in the Style D (Class A) mode any trouble condition will require pressing **RESET** to restore the panel to normal after the fault has been removed.

2.5.6 ...

2.5.7 Initiating circuit alarm

An increase of current on any alarm initiating device circuit to approximately 20mA or greater will result in the following (if all the associated touchpad settings are in the normal standby condition).

- Operation of the audible or visual devices on the notification appliance circuit.
- Operation of the zone alarm LED.
- Operation of the auxiliary alarm contacts.
- Operation of the buzzer for alarm (steady tone).
- Reverse the voltage polarity of the remote alarm (RA) circuit.
- Alarm zone number and name is displayed on the optional LCD.

CAUTION *With the exception of the loss of the AC-ON LED and transfer of the auxiliary trouble relay contacts, none of the trouble indicators will operate on loss of AC unless an adequately charged battery is connected to the proper terminals.*

2.5.8 Auxiliary power output conditions

Loss of output of the auxiliary power will result in the following:

- Operation of the auxiliary power LED.
- Operation of all system trouble indications (see section 2.5.11 *System trouble*).
- **AUXILIARY POWER TROUBLE** will be displayed on the optional LCD.

2.5.9 Battery power conditions

The battery circuit is power limited and reverse polarity protection is provided. Loss of or reduction of battery voltage to 23 volts or increase to 29 volts or more will result in the following:

- Operation of the battery trouble LED.
- Operation of all system trouble indications (see section 2.5.11 *System trouble*)
- If batteries are disconnected, the system trouble and battery LEDs will light and the buzzer will sound after 30 seconds.
- **BATTERY TROUBLE** will be displayed on the optional LCD.

NOTE *There is a time delay of approximately 1 minute for battery trouble to restore.*

2.5.10 AC power conditions

Loss or Reduction of AC:

A reduction in the AC input voltage would result in the following:

- Green AC LED will be extinguished.
- Operation of all system trouble indications (see section 2.5.11 *System trouble*).
- **AC TROUBLE** will be displayed on the optional LCD.

2.5.11 System trouble

All the previously listed trouble conditions will, in addition to the specific indication previously shown, result in the following common trouble indications:

- Operation of the system trouble LED.
- Operation of the buzzer for trouble (slow beep - 1 pulse every two seconds).
- Transfer of the auxiliary trouble contacts.
- Opens the circuits of the remote alarm and supervisory outputs.
- A description of the trouble will be displayed on the LCD.

NOTE *This panel incorporates a trouble reminder feature. If a trouble is silenced and the cause of the trouble is not rectified, the trouble buzzer will resound 12 hours after the panel is silenced.*

Pressing **CITY TIE DISABLE**, **TEST** or any **ZONE DISABLE** touchpad, also results in the operation of the system trouble indications listed above.

2.5.12 Supervisory initiating device circuit

Supervisory Condition:

An increase of current to approximately 5mA or greater on the supervisory initiating device circuit will result in the following:

- Operation of the supervisory LED.
- Reverse the voltage polarity of the remote supervisory output (RS).
- Operation of the buzzer for supervisory (fast beep - 1 pulse per second).
- Operation of all system trouble indications except buzzer pattern (see section 2.5.11 *System trouble*)
- **SUPERVISORY CONDITION** is displayed on the optional LCD.

2

3

4

5

A

B

C

D

E

Contents

1

2

3 Installation

3.1 Safety message to installers

⚠ WARNING *People's lives depend on your safe installation of our products. It is important to read, understand, and follow all instructions shipped with this product.*

The Facilities Engineer and the Safety Engineer should make selection of mounting location for this product, its controls, and routing of wire. Listed below are some other important safety instructions and precautions you should follow.

- Read and understand the entire manual before attempting to install this panel.
- System wiring should be installed and maintained in accordance with section 70 (Fire Protection Signaling Systems) and all other applicable sections of the National Electrical Code, all Local Code, all applicable NFPA Codes and Standards and the Authority Having Jurisdiction. Review the circuit parameters listed under “Electrical specifications” before installing the panel.
- Do not connect devices or system wiring when circuits are energized.
- After installation, be sure all threaded joints are securely tightened.
- After installation and completion of initial system test, a program for periodic testing of this system must be established. Refer to NFPA 72, local fire codes, and the authority having jurisdiction for this information.
- After installation and completion of final test, provide a copy of this instruction manual to all personnel responsible for operation, periodic testing, and maintenance of this system.

3.2 NFPA and UL installation requirements

3.2.1 *Requirements for all installations*

This section describes general installation requirements. Refer to the appropriate section(s) for additional requirements for more specific installation.

- Read and follow all items in the safety message to installers above.
- Use appropriate secondary power supply (battery, see section 3.7).
- Use compatible smoke detectors listed in Appendix B.
- Use UL listed notification appliances with compatible ratings.
- A full system check must be performed any time the panel is programmed.

3.2.2 *Requirements for Local Fire Alarm Systems*

- At least one notification appliance must be used.

3.2.3 *Requirements for Auxiliary Fire Alarm Systems*

- Use the MBM and a municipal city tie box as the interface between the local control panel and the public fire service communications center (see Appendix A for wiring and more information).

3.2.4 *Requirements for Remote Station Fire Alarm Systems*

- A UL497A Listed Secondary Protector for Communications Circuits must be used on the remote station terminals.
- Either the reverse polarity outputs or the DACT may be used for Remote Station. See section 4.1.3 for configuration of the reverse polarity outputs. Or install optional ZDACT and OPLCD (see sections 3-3, 4-4, and A-2).
- Set the AC trouble report delay from 15 to 30 hours.

3

4

5

A

B

C

D

E

3.2.5 Requirements for Central Station Fire Alarm Systems

- Connect both phone lines to the optional ZDACT and OPLCD and program the telephone numbers for the reporting station.
- Set the AC trouble report delay from 6 to 12 hours.

3.3 Installing the cabinet (and optional bezel)

Figure 3-1. Surface mounting dimensions

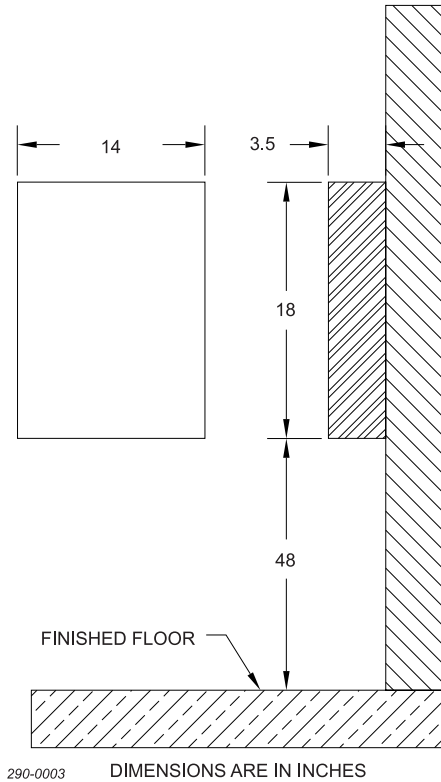
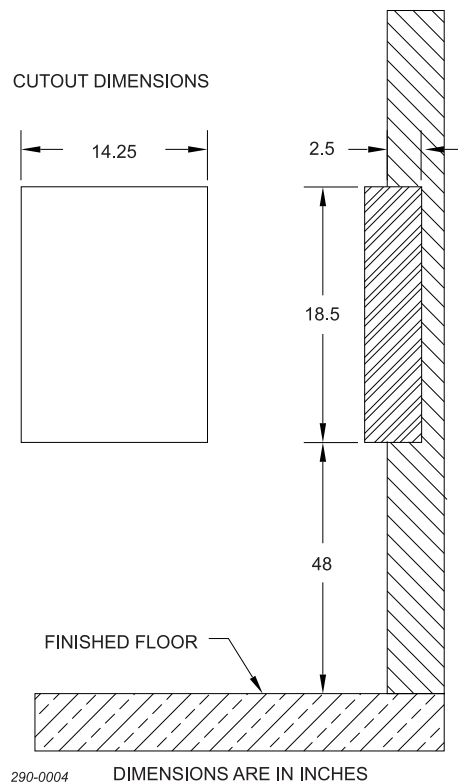
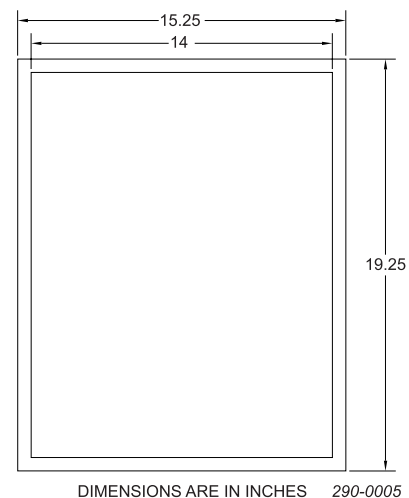

Figure 3-2. Semi-flush mounting dimensions



1. The **FIRELARM 2500** unit may be surface mounted or semi-flush mounted using the optional trim bezel.
2. The unit should be mounted in a convenient location, approximately 4 feet from the floor where it will be accessible for testing and servicing.
3. The main circuit board module can be removed before attempting to mount the cabinet. Disconnect the two wires of the transformer from P2 on the main board. Remove the eight Philips head screws and lock washers. Remove the circuit board.
4. For semi-flush installations mount the housing so that the front edge protrudes 1" from the finished wall surface.
5. After all conduits and wiring are in place and the wall surface is completely finished, slide the trim bezel in place and fasten with four #6-32 x 1/4" machine screws and nuts.

Figure 3-3. Trim bezel dimensions



3.4 Wiring

Refer to Figures 3-5 through 3-7 for wiring information.

1. Install all required conduits, external wiring. With the AC power turned off at the circuit breaker panel, connect the 120VAC hot (black), neutral (white) and ground (green) wire to the panel as shown on the power supply connection drawing (Figure 3-7).
2. If not already done, install the main board into the cabinet and connect the transformer secondary leads to connector P2. Turn the AC power on and connect the standby batteries with the cable provided to connector BAT 1, while observing polarity. Verify that the panel goes into normal standby condition.
3. Connect each circuit individually and verify the operation of the circuit as outlined in section 5.2 *Inspection and test procedure*.
4. Inactive circuits: All inactive initiating device and indicating circuits must have the end of line test resistor on the panel terminals. On circuits that have four terminals the resistor must be on the outside two terminals.

3.5 Quick Reference Operating Instructions form

Make a photocopy of the form in Appendix E. Fill in the name, address and telephone number of the servicing agency on the bottom of the form and post in a prominent place.

3.6 Zonal Digital Alarm Communicator Transmitter (optional ZDACT)

Remove AC power and battery power from the panel. Line up the electrical contact socket on the ZDACT with the pins on connector J8 on the panel. Firmly insert the ZDACT into the pins.

Connect the primary and secondary phone lines to the phone jacks. Peel off the small adhesive label at the edge of the large black plastic LED label so that the ZDACT LED's can be viewed from the front. Reconnect AC power and battery power.

3.7 Battery size requirements

Using the Calculation Table (Table 3-3):

1. List in column #1 all devices used in the system; include all modules, NAC, horns, strobes, door holders, and 4-wire smoke detectors (see Table 3-1 or manufacturer's specifications).
2. List in column #2 the quantity of each device.
3. List in column #3 the standby current of each device (exclude all signal notification appliance circuits).
4. List in column #5 the alarm current of each device.
5. For each line multiply the figure in column #2 by the figure in column #3 and enter the product in column #4. Then multiply the figure in column #2 by the figure in column #5 and enter the product in column #6.
6. Add the figures in column #3 and #6 and enter the sums in the appropriate total mA box.
7. Convert these figures from milliamperes to amperes by multiplying by .001 and enter the product in the appropriate total A box.
8. Multiply the standby total amperes by required time in hours from Table 3-2.
9. Divide the alarm total amperes by 12 (5 minutes).
10. Add the standby AH and the alarm AH and divide this sum by .85 (efficiency factor). Select a battery that has an AH rating above this figure but not less than 6.5AH.

NOTE *The FireLarm 2500 cabinet can hold batteries up to 7AH. If a larger battery is needed, use a separate battery cabinet (must be UL Listed for Fire Protective Signaling Use). Any auxiliary battery cabinets must be mounted adjacent and close-coupled to the FireLarm 2500 cabinet. All battery power wiring must be securely segregated from nonpower-limited wiring (see Figure 3-7). The maximum battery capacity that can be used is 44AH.*

3

4

5

A

B

C

D

E

Table 3-1: Current Requirements.

Module/Device	Standby mA	Alarm mA
2500 with LCD display	170	310*
2500 without LCD display	105	250
CAM (Class A module)	0	25
RALCD (Remote Annunciator)	95	115
ZDACT (Digital Alarm Communicator)	30	50
MBM module	30	15 (250 momentary)
PAM-1 or PAM-2 Relay	15	15

*Includes one zone short circuit current.

Table 3-2: Secondary Power Requirements.

NFPA-72 National Fire Alarm Code	Standby Time	Alarm Time
Local Systems	24 hrs.	5 min.
Auxiliary Systems	60 hrs.	5 min.
Remote Station Systems	60 hrs.	5 min.
Central Station Systems	24 hrs.	5 min.

Table 3-3: Calculation Table.

1	2	3	4	5	6
Module/Device	Qty.	Standby mA Per Unit	Total Standby Current	Alarm mA Per Unit	Total Alarm Current
		Total mA		Total mA	
		Convert to A	X 0.001	Convert to A	X 0.001
		Total A		Total A	
		Multiply by hours	X	AH for 5 mins.	÷ 12
		from table 2			
		Total Standby AH		Total Alarm AH	
				+ Total Standby AH	
				Total AH	
				Efficiency Factor	÷ 0.85
				Required AH	

NOTE Select a battery such that the battery's amp hour rating meets or exceeds the calculated amp hour requirement (44AH maximum).

Contents

1

2

3

Figure 3-4. Motherboard.

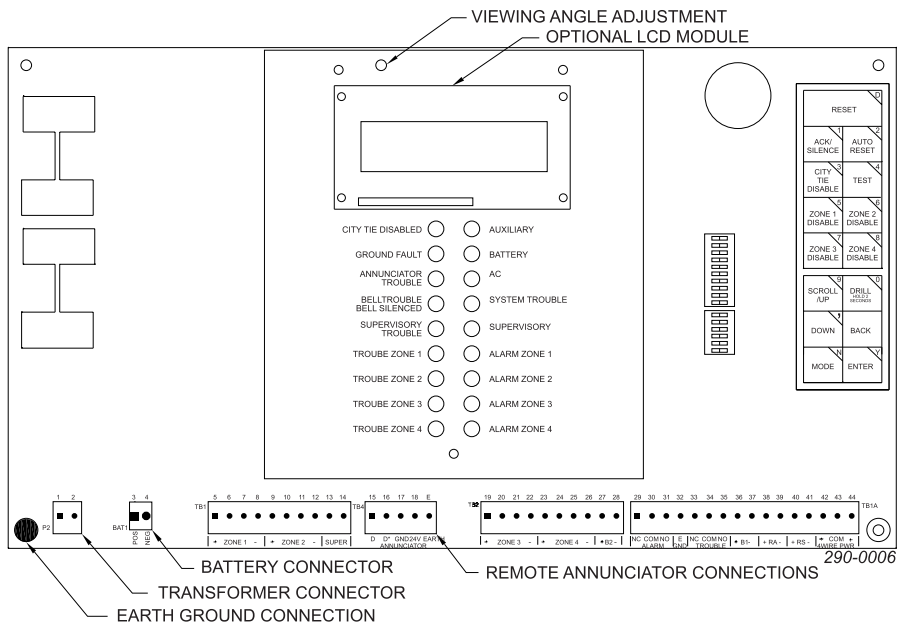
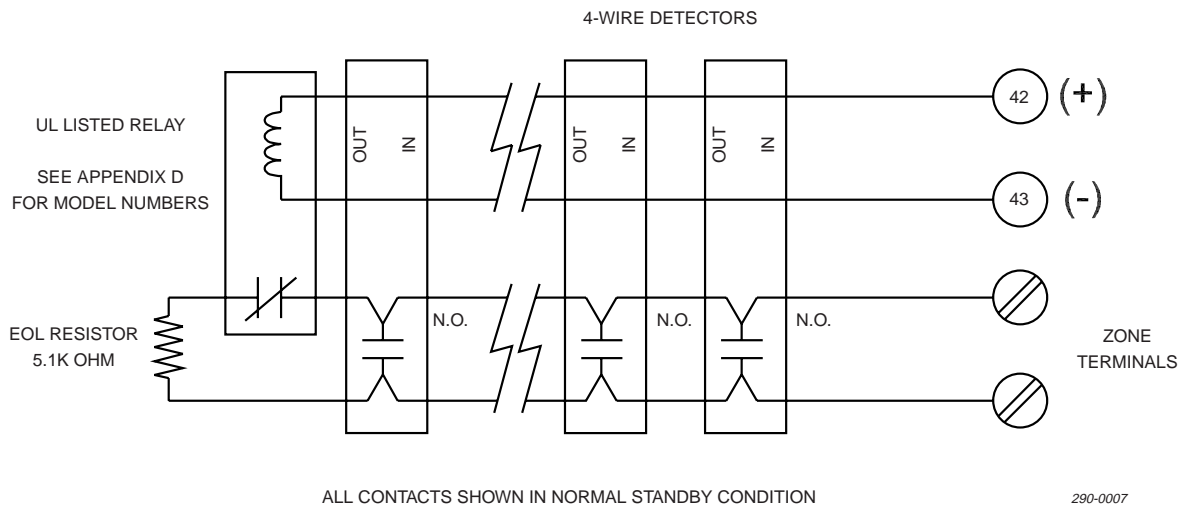

Figure 3-5. Four-wire detector connections (Style B, Class B circuit)



3

4

5

A

B

C

D

E

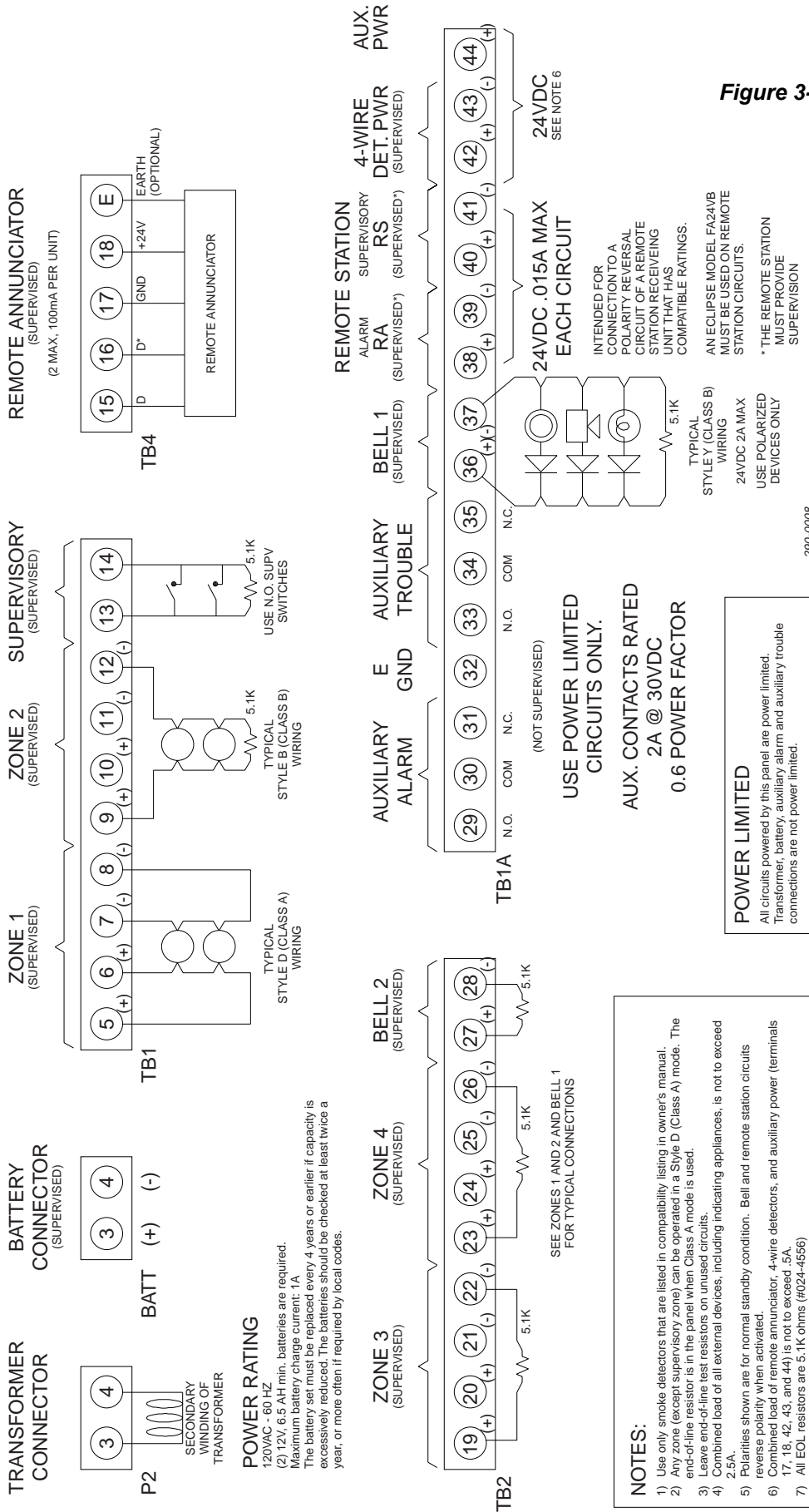

Figure 3-6. Device Wiring

290-0008

3.8 Notification Appliance Circuits Connections

The control panel has two Style Y (Class B) notification appliance circuits which can be upgraded to Style Z (class A) by the addition of a model CAM (Class A Module). One module is required for each circuit that is to be upgraded. See Appendix A for more information.

The notification appliance circuits are power limited, regulated 24 VDC rated at 2.0 amperes max each. (Total system current not to exceed 2.5 A.)

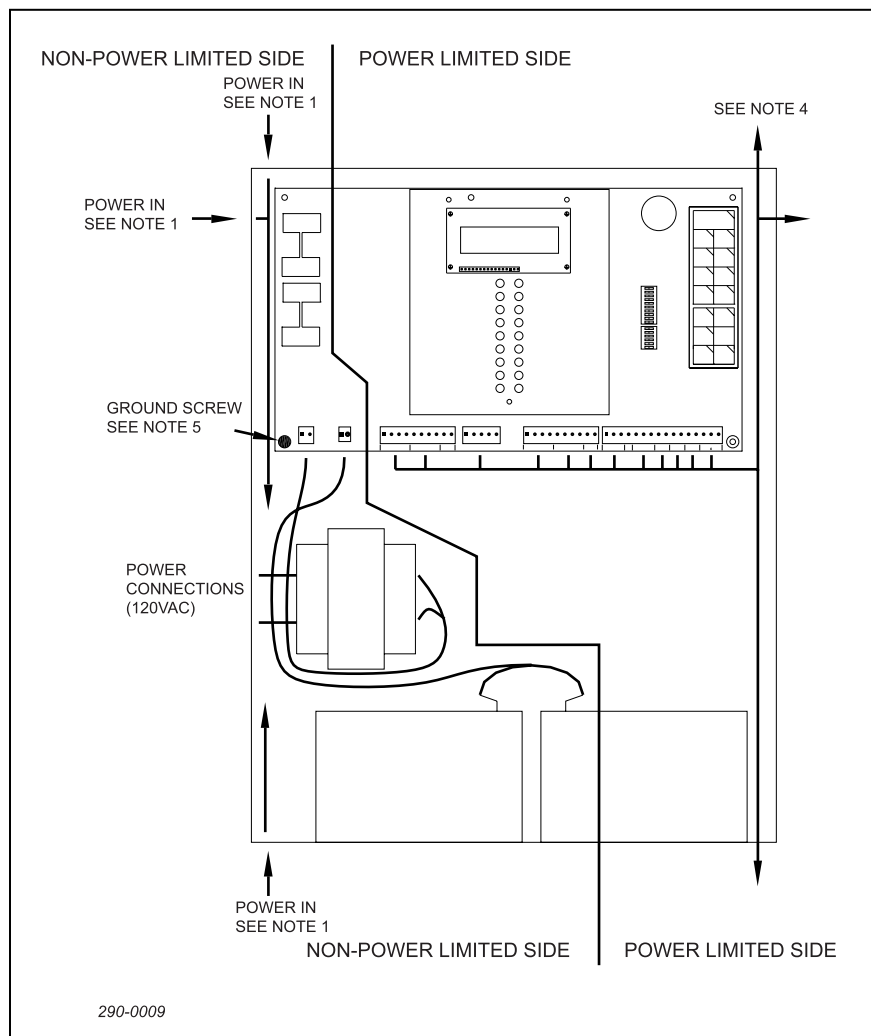

Figure 3-7. Wire Routing Diagram

NOTE Notes for Figure 3-7:

1. Power inputs (not power limited). Wire wrap to standoff for strain relief.
2. Battery leads (not power limited).
3. Use left hand knockouts for non-power limited wiring.
4. Use right hand knockouts for power limited wiring.
5. Connect earth ground to corner of main board using a #6 ring terminal or wire and ring provided.
6. All wiring must be wire-wrapped to a standoff or other mechanically secure location.

NOTE All field-installed wiring connected to this panel must maintain a spacing of $\frac{1}{4}$ inch between all power-limited conductors and all electrical light, power, Class 1, or non-power limited conductors.

3

4

5

A

B

C

D

E

Contents

1

2

3

4 Configuration and Programming

4.1 Selecting connected device options (DIP switches)

A series of DIP switches are used to configure devices connected to the fire alarm control panel. DIP switches are located in the lower right corner of the panel.

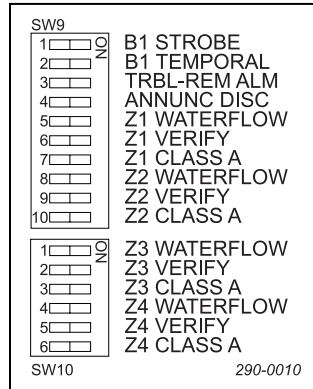

Figure 4-1. DIP Switches

DIP Switch 9	Description of Disabled States (Switch to left side)	Description of Enabled States (Switch to right side)
1. B1 Strobe	NAC 1 devices are silenceable.	NAC 1 devices are non-silenceable – requires panel reset to silence.
2. B1 Temporal	NAC 1 rings constant	NAC 1 rings for 3 pulses and then stops for 1 pulse (1/2 second per pulse)
3. TRBL-REM ALM	Remote alarm trouble disabled.	Remote alarm trouble enabled.
4. ANNUNC DISC	Remote annunciator is not used or annunciator input is ignored.	Remote annunciator is used and annunciator input is accepted.
5. Z1- Waterflow	Zone not waterflow switch (silenceable)	Zone waterflow switch (not silenceable)
6. Z1- Verify	Zone not verify	Zone verify
7. Z1- Class A	Zone Style B (Class B)	Zone Style D (Class A)
8. Z2- Waterflow	Zone not waterflow switch (silenceable)	Zone waterflow switch (not silenceable)
9. Z2-Verify	Zone not verify	Zone Verify
10. Z2- Class A	Zone Style B (Class B)	Zone Style D (Class A)

DIP Switch 10	Description of Disabled States (Switch to left side)	Description of Enabled States (Switch to right side)
1. Z3- Waterflow	Zone not waterflow switch (silenceable)	Zone waterflow switch (not silenceable)
2. Z3- Verify	Zone not verify	Zone verify
3. Z3- Class A	Zone Style B (Class B)	Zone Style D (Class A)
4. Z4- Waterflow	Zone not waterflow switch (silenceable)	Zone waterflow switch (not silenceable)
5. Z4- Verify	Zone not verify	Zone verify
6. Z4-Class A	Zone Style B (Class B)	Zone Style D (Class A)

4.1.1 B1 Strobe device

Place the **B1 STROBE** switch in the “on” position (right side of the switch) when NAC 1 is a non-silenceable circuit (for devices such as strobes). When enabled, the circuit cannot be silenced during alarm except by resetting the panel.

4.1.2 B1 Temporal pattern

Place the **B1 TEMPORAL** switch in the “on” position (right side of the switch) when you wish NAC 1 to ring a temporal pattern. A temporal signal consists of three rings and one pause as defined by NFPA 72, Section A-3-7.2 (2).

4
5
A
B
C
D
E

4.1.3 Reverse polarity circuits configuration

This panel is equipped with two polarity reversal-type outputs. This permits alarm and trouble signals to be transmitted to one location and supervisory and trouble signals to be transmitted to a second location.

If trouble signals are to be transmitted to the alarm location or if only the remote alarm circuit is used, place the **TRBL-REM ALM** switch in the “off” position (left side of the switch). When configured in this manner, supervisory alarms are sent as trouble signals on the remote alarm circuit.

CAUTION *When the remote alarm output is programmed to transmit a trouble condition, the control panel is not suitable for remote station protected premises service where separate transmission circuits are required for fire, supervisory, and trouble signals. This should not be done unless approved by the Authority Having Jurisdiction*

4.1.4 Annunciator disconnect

Place the **ANNUNC DISC** switch in the “on” position (right side of the switch) when you wish to ignore commands sent from the remote annunciator or when an annunciator is not connected.

4.1.5 Waterflow detectors

Place the **WATERFLOW** switch in the “on” position (right side of the switch) for all zones that are to be used with waterflow detectors. The SILENCE and ZONE DISABLE keypads can not be used for zones configured for waterflow. Instead, the panel must be reset to silence the alarm notification device.

4.1.6 Alarm verification

Place the **VERIFY** switch in the “on” position (right side of the switch) to place a zone in the alarm verification mode.

This mode should only be used with smoke detectors that do not include an alarm verification feature. When a smoke detector operates on a zone that has been selected for alarm verification, the panel will not immediately go into an alarm condition.

Power will be removed for a period of 6 to 8 seconds, which will reset the detector. Power is then reapplied, but alarms are inhibited for the next 3 to 6 seconds.

If any detector operates within the following confirmation period of approximately 120 seconds, an alarm condition will result.

4.1.7 Style D (Class A) operation

Any initiating device zone (except the supervisory zone) can be operated in a Style D (Class A) mode.

To place a zone in the Style D (Class A) mode, place the **CLASS A** switch in the “on” position (right side of the switch). Zones that are selected to be Style D (Class A) require a four wire, double loop, configuration. This permits detection of an alarm condition from any detector on the zone when a single open fault is present.

4.2 Program configuration of the panel

The optional LCD is used to display system status during operation, show a description of each zone, and allows configuration of the optional ZDACT. The prompts and possible key presses for configuring the control panel are shown below to help with configuration. Words in **BOLD ALL CAPS** print appear in the LCD.

NOTE *An LCD display is required for programming the panel. If you do not have an LCD output, see Appendix C for ordering optional LCD (Model OPLCD) or remote annunciator (Model RALCD).*

To enter the configuration mode when no alarms are present, press **MODE** and enter the four digit password. If no password has been entered, the default password is required (2402). If no touchpad is pressed for 30 seconds while in configuration mode, the panel returns to normal standby condition. The configuration mode cannot be entered if alarms are present. Zone labeling

SETUP ZONES?



To program zone descriptions



To exit configuration



To skip zone setup and go to password setup



To skip zone setup and go to ZDACT setup, if used

ENTER ZONE 1 DESCRIPTION?



To program the label for zone 1



To exit to SET UP ZONES? Screen



To cycle forward or backward through zone configuration screens

DESCRIPTION



To select a character. Press and hold to scroll quickly through the character set. See below for order of characters



To set the selected letter and advance the cursor



To save the zone description or cancel changes

SAVE? (Y/N/BACK)



To save changes and advance to next zone



To keep previous setting and advance to next zone



To modify the zone description

ENTER ZONE 2 DESCRIPTION?

Similar to ENTER ZONE 1 DESCRIPTION above.

ENTER ZONE 3 DESCRIPTION?

Similar to ENTER ZONE 1 DESCRIPTION above.

ENTER ZONE 4 DESCRIPTION?

Similar to ENTER ZONE 1 DESCRIPTION above.

Order of characters





← **DOWN** key **SCROLL /UP** key →
 ! " # \$ % & ' () * + , - . / 0 1 2 3 4 5 6 7 8 9 : ; < = > ? ~
 A B C D E F G H I J K L M N O P Q R S T U V W X Y Z [\] ^ _ '
 a b c d e f g h i j k l m n o p q r s t u v w x y z { | } ← → (space)

4
5
A
B
C
D
E





4.2.1 ZDACT configuration

NOTE ■ The following programming options occur only when a ZDACT is mounted on the FireLarm 2500. These options are skipped if no ZDACT is used.







SETUP ZDACT?

-  To configure ZDACT options
-  To exit configuration mode
-  To skip ZDACT configuration and go to zone configuration
-  To skip ZDACT configuration and go to AC trouble reporting delay configuration



ENTER PHONE NUMBER 1?

-  To enter phone number 1.
-  To exit to SETUP ZDACT? screen
-  or  To cycle forward or backward through ZDACT configuration options.

PHONE NUMBER 1:

-  through  To enter phone number digits.
-  To enter a comma for a 2 second pause in dialing sequence.
-  To advance the cursor.
-  To delete the character at the cursor.
-  To move the cursor back.
-  To save the zone description or cancel changes.

SAVE? (Y/N/BACK)

-  To save changes and advance to next phone number.
-  To keep previous setting and advance to next phone number.
-  To return to the phone number.



ENTER PHONE NUMBER 2?

Similar to PHONE NUMBER 1

ENTER ACCOUNT NUMBER?

Similar to PHONE NUMBER 1. Up to four digits.

Order of characters

←  key  key →

!"#\$%&'()*+,-./0123456789:;<=>?~

ABCDEFGHIJKLMNOPQRSTUVWXYZ[\]^_'

abcdefghijklmnopqrstuvwxyz{|}←→(space)

AC DELAY (HR)?

When an AC trouble condition occurs, the panel will delay the number of hours programmed under this option. The delay can be set from 6 to 30 hours.



To enter AC trouble reporting delay.



To exit configuration mode.



To skip AC trouble reporting configuration and go to ZDACT configuration, if used.



To skip AC trouble reporting configuration and go to password configuration.

AC DELAY (HR):



or



To change the value.



To save the value or cancel changes.

SAVE? (Y/N/BACK)



To save changes and advance to password configuration.



To keep previous setting and advance to password configuration.



To reenter the delay value.

OFFSET TIMER (HR)?

This will set a time delay starting from the entry of the offset timer value for a phone line check. The check will be performed every 24 hours thereafter. The 24-hour time delay starts from zero on a power cycle of the panel. Keypresses are similar to AC DELAY (HR)?





Order of characters

← key key →
 ! " # \$ % & ' () * + , - . / 0 1 2 3 4 5 6 7 8 9 : ; < = > ? ~
 A B C D E F G H I J K L M N O P Q R S T U V W X Y Z [\] ^ _ ' `
 a b c d e f g h i j k l m n o p q r s t u v w x y z { | } ← → (space)



4.2.2 Password settings

NOTE Panels from the factory are set to the default password (2402). Change the password, write it down and store in a safe place for optimum protection.



CHANGE PASSWORD?

-  To change the password
-  To exit configuration mode
-  To skip password configuration and go to ZDACT configuration
-  To skip password configuration and go to zone configuration.



PASSWORD:

- NUMBER KEYS To enter a password up to four digits
-  To advance the cursor
-  To move the cursor back
-  To save the password or cancel changes

SAVE? (Y/N/BACK)

-  To save changes
-  To keep previous setting
-  To modify the password

Order of characters

 key  key 

!"#\$%&'()*+,-./0123456789:;<=>?~



ABCDEFGHIJKLMNOPQRSTUVWXYZ[\]^_`

abcdefghijklmnopqrstuvwxyz{|}←→(space)

5 Maintenance

Most modern control units do not require periodic adjustment or field repair other than replacement of a module or printed circuit board assembly. Defective printed circuit board assemblies or modules can best be serviced at the manufacturer's plant or at their authorized service facility. Where the control unit uses printed circuit boards, care should be taken to clean off excessive dust. The boards should be maintained clean and dry to ensure proper operation.

5.1 Auto Reset feature (One-man test)





This function only works when the panel is in the standby mode. Pressing  sets the panel into one-man test mode. When a zone goes into alarm, the audible circuits are pulsed ½ second for identification of the zone; i.e. zone 1 has one pulse, zone 2 has two pulses, etc. After the zone number is pulsed, the panel automatically resets the zones by cycling power. After 15 minutes of no activity, the panel provides 5 pulses on the NAC and goes back into standby condition. Pressing  again (no pulses with this exit) returns the panel to standby condition.

5.2 Inspection and Test procedure

5.2.1 Testing the control panel

Notify the building occupants, the fire department and/or receiving station personnel before and after testing is performed. Notify the fire department and/or other receiving station personnel if alarm, supervisory, and/or trouble signals are transmitted. (Transmissions may be inhibited by pressing .)

⚠ CAUTION *In addition to the testing procedures described below, the **FireLarm 2500** system and all of its associated protective signaling adjuncts should be inspected and tested in accordance with the NFPA-72 National Fire Alarm Code and any requirements of the Authority Having Jurisdiction.*

1. Notify the proper building personnel so audible and/or visual signals can be viewed as a test by building occupants.
2. Press . This will cause all audible and visual indicators on the panel and the NAC outputs to come on. Releasing  will restore the panel to the condition it was in prior to operation of this touchpad.
3. Press each . This will result in a trouble condition and operate all indicators as described in section 2.5.5 *Initiating Zone Trouble*. Repeating  will restore all indicators to normal.
4. Momentarily open each of the following circuits. Observe that each of these results in a trouble condition and appropriate indicators operate as described in the section for the particular circuit that is faulted. (See section 2.5.5 *Initiating Zone Trouble*)
 - Each initiating device zone (there is a brief delay when these circuits are in the Style D (Class A) mode.
 - Supervisory circuit.
 - Notification appliance circuit
5. Momentarily shunt each of the circuits listed in the previous step (except the supervisory circuit) with 4.7K ohm resistor and again observe that a trouble condition is generated for each test. Use 1.5K ohm for the supervisory circuit.
6. Turn off the AC power at the circuit breaker panel. The green AC-ON indicator will be extinguished. Observe that all the trouble indications occur that are described in section 2.5.10 *AC power conditions*.

7. Press **TEST**. All audible and visual indicators on the panel and NAC outputs should operate. Restore AC power and verify panel is in normal standby condition.
8. Press **AUTO RESET** to enter auto reset mode.
9. Operate each initiating device on all zones. All audible and visual notification appliances should operate. NAC devices pulse the zone number. Power is then removed from the initiating device circuit for approximately 7 seconds. No alarms can be initiated during this test. If the initiating device has not been restored the panel will repeat the test pulse.
10. Operate each initiating device on the supervisory circuit. Observe that all the indications occur as described in section 2.5.12 *Supervisory initiating device circuit*.
11. Press **AUTO RESET** to exit auto-reset mode. If **CITY TIE DISABLE** had been pressed to enable it, press it to disable it. All the LEDs on the panel except the green AC ON LED should be off. All audible and visual indicators connected to the notification appliance circuit should be off.
12. The supervising station will also be restored to normal (if applicable).

5.2.2 *Testing the Remote Annunciator*

1. Verify that the control panel is in normal standby condition.
2. Press and hold TEST on the remote annunciator. Verify that all visual and audible indicators on the annunciator are operating. Release TEST.
3. Turn the annunciator keyswitch to the on position. Press RESET. Verify that the annunciator displays the reset countdown

5.2.3 *Testing the Zonal Digital Alarm Communicator Transmitter (ZDACT)*

1. Initiate a signal while the ZDACT is connected to the primary telephone line.
2. Disconnect the primary line from the ZDACT. Verify that the ZDACT trouble signal is indicated on the control panel and that the trouble signal is transmitted to the supervising station.
3. Disconnect the secondary line from the ZDACT. Verify that the ZDACT trouble signal is indicated on the control panel and that the trouble signal is transmitted to the supervising station.
4. Simulate a fault in the primary telephone number. Verify that the ZDACT uses the secondary telephone number to complete the transmission..

Appendix A. Optional Accessories

A.1 Remote Annunciator with Liquid Crystal Display (2500-RALCD)

Part # 2500-RALCD

UL Listed: For use with the **FireLarm 2500**

Dimensions: 4 1/2" W X 4 1/2" H X 7/8" D (approximate)

Weight: 5.5 OZ.

Enclosure: Stainless steel plate. Mounts on standard double-gang switch box or 4" square box using adapter plate.

Power Requirements: 24VDC @ 115mA max. – Obtained from control panel.

Line resistance: 25 ohms max

The Model RALCD is a Remote Annunciator that is designed to operate with the **FireLarm 2500** Fire Control Panel. This unit will mount on a standard 2-gang switch box. The LCD displays the same information as on the main panel. A built in buzzer sounds when a trouble condition exists on the panel.

Two annunciators can be connected in parallel. Jumper SW7 must be shorted to specify annunciator 1, and must be open to specify annunciator 2.

Keypad – operates the same as on the panel except as noted below.

Key	Function	Control	When Active
ACK	Silences buzzer on RALCD only.	Annunciator	Always
TEST	Turns on buzzer, backlight (if off), and scrolls through alphabet.	Annunciator	Always
RESET	Resets all alarm circuits if condition has been corrected, removes power from initiating device circuit and auxiliary power from smoke detectors for 7 seconds.	Panel	Key switch on
DRILL	Pressing for 2 seconds will initiate a fire drill.	Panel	Key switch on
SCROLL	Scrolls through trouble conditions, if present.	Panel	Key switch on
SILENCE	Press once to silence buzzers on panel and annunciators. Press again to silence signal circuits.	Panel	Key switch on

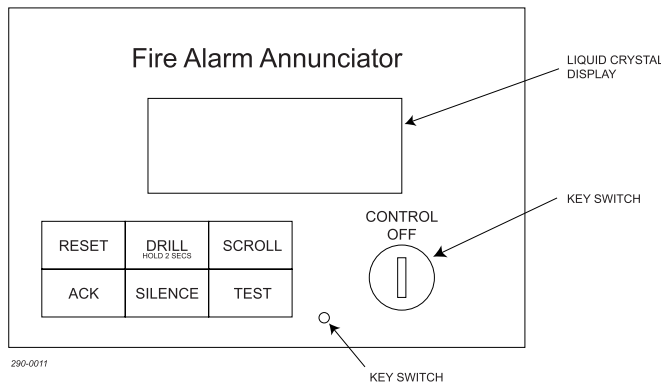

Figure A-1. LCD Remote Annunciator

Electrical Connections

RALCD Terminal	Function of Terminal	FireLarm 2500 Terminal (TB4)
D	Data signal	D
D*	Data inverted signal	D*
GND	Power ground	GND
+24 VDC	Power	+24 VDC
EARTH	Earth ground (optional connection)	E

A
B
C
D
E

A.2 Zonal Digital Alarm Communicator Transmitter (2500-ZDACT)

UL LISTED: For use with the FireLarm 2500

Transient protected

Power requirements:

Input current

Standby: 50mA

Alarm current: 90mA max.

Part # 2500-ZDACT:

The ZDACT is used for off-premises monitoring of the fire alarm control panel. Signals are sent to a Digital Alarm Communicator Receiver (DACR) using either a primary or a secondary telephone line. Both telephone lines are supervised; if one line is operational and the other is in trouble, a report is sent to the supervising station and the Line Fault trouble LED (D3) is illuminated for local indication. The Panel Supervisory trouble LED (D2) will illuminate if communication with the control panel is lost. The ZDACT mounts directly on the FACP main board with earth ground lug screwed under standoff nut at top corner post. Programming is done through the FACP with inputs for two phone numbers and a 4-digit account number. The transmission format is Security Industry Association (SIA) Level 1 and is compatible with the receivers listed below. The ZDACT will transmit a test call every 24 hours to the DACR.

Compatible SIA Level 1 Receivers

Manufacturer	Model Number
Silent Knight	9500 with 9810 Line card

Figure A-2. ZDACT Mounting.

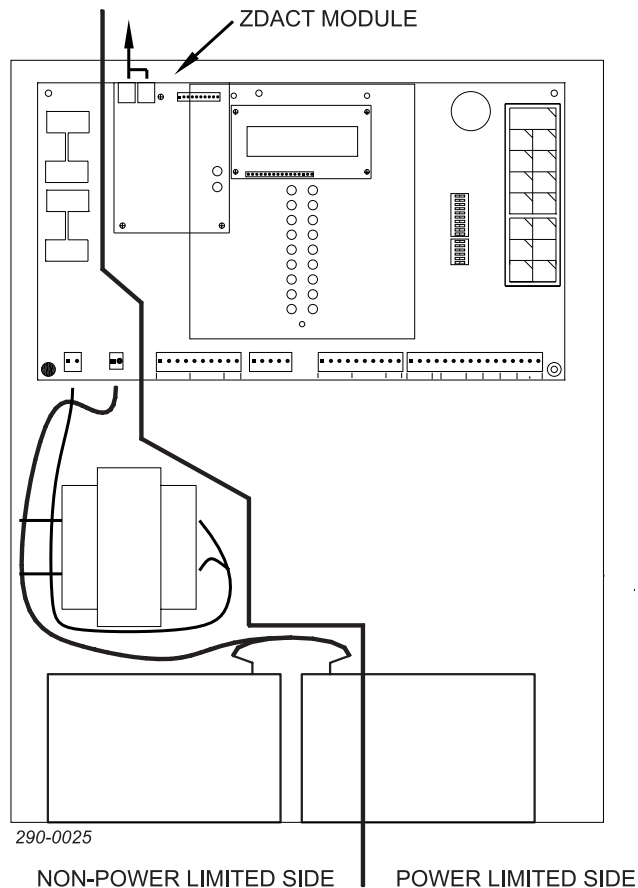

A.3 Style Z (Class A) Module for NAC circuits (CAM)

UL LISTED: For use with the **FireLarm 2500**

Part No. 345-0234

TRANSIENT PROTECTED

BUILT IN 5.1K END OF LINE RESISTOR

POWER REQUIREMENTS IN ALARM: Approx. 25mA @ 24VDC from control panel notification appliance circuit

The Model CAM Style Z (Class A) Module is designed to be used with the **FireLarm 2500** Fire Control Panels to convert a single Style Y (Class B) notification appliance circuit to a Style Z (Class A) circuit (one module is required for each notification appliance circuit). The module is provided with snap track which is mounted to the cabinet via double-sided foam tape and secured by two #6 sheet metal screws. The module should be mounted in the area below the main circuit module as shown below so that the terminals are accessible.

Figure A-3. CAM Module Wiring.

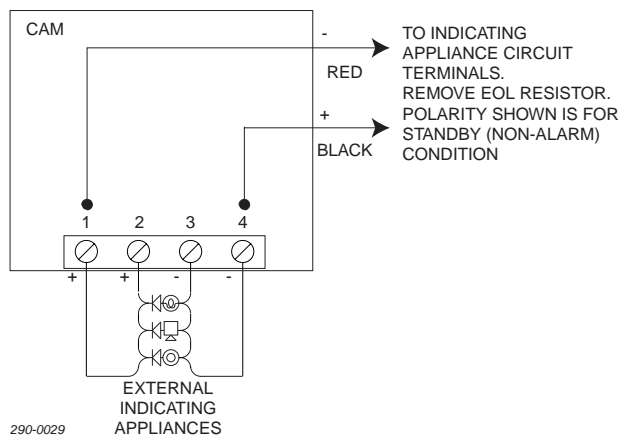
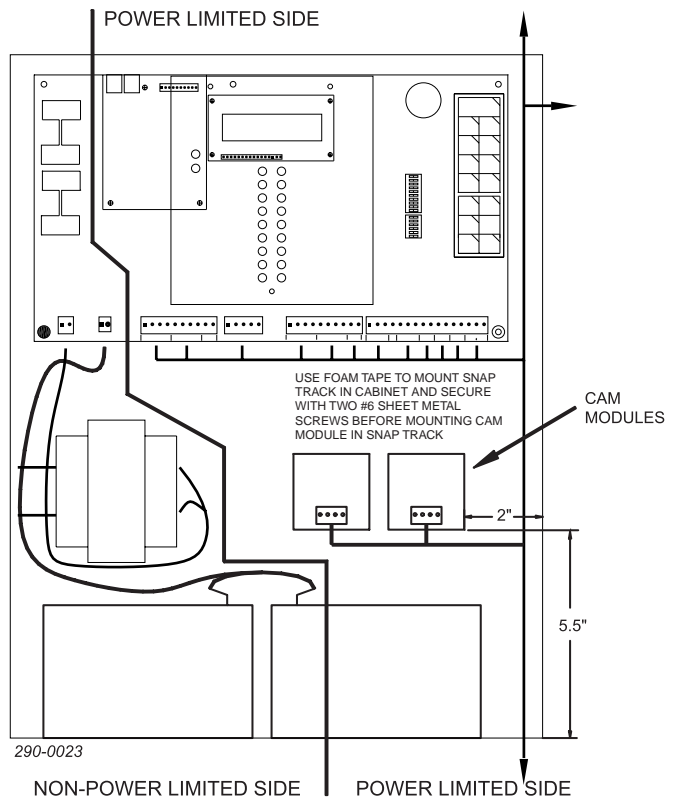

Figure A-4. CAM Module Location.



- A
- B
- C
- D
- E

A.4 Master Box Module (Model MBM)

UL LISTED: For use with the FireLarm 2500

Part No. 345-0235

Power requirements:

Standby: 30mA Max @24VDC

Alarm: 300 mA Max @24VDC

Master Box Coil Resistance: 14.5 ohms

Trouble output: Positive 2.5 V goes low in trouble and SPDT contacts transfer.

Contacts rated 2A@30VDC

Visual indicators: Yellow - Trouble/Disable

Yellow - Reset supervisory/ contacts off normal

Disable capability: Switch provided (can be made inoperative)

Size: 3"x5-1/2"

The Model MBM is a local energy type Master Box actuating module for use with the FireLarm 2500 Fire Control Panel. The unit can be mounted in the control panel housing, if space is available, or in a separate housing (CPG #327-0089). The circuit between the module and the master box is supervised to detect an open circuit. Terminals are provided for the connection of the master box reset supervisory contacts.

A switch is provided to disable the unit so that it will not trip the master box. Operation of this switch will cause LED (D6) to illuminate. To make this switch inoperative, remove R42.

If the master box is provided with reset supervisory contacts, the position of these contacts may be supervised. When these contacts are off normal LED D5 will illuminate and the trouble outputs will be activated.

Figure A-5. MBM.

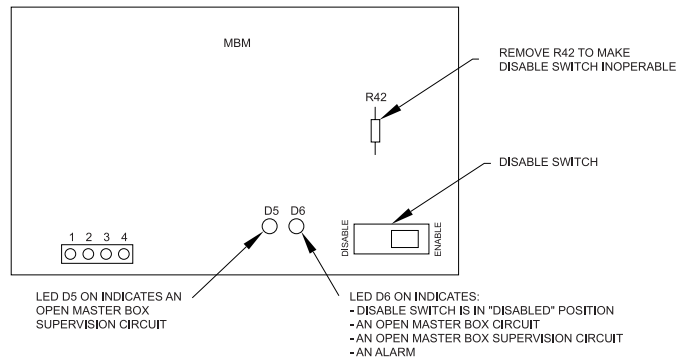

290-0017

Figure A-6. MBM Module Wiring.

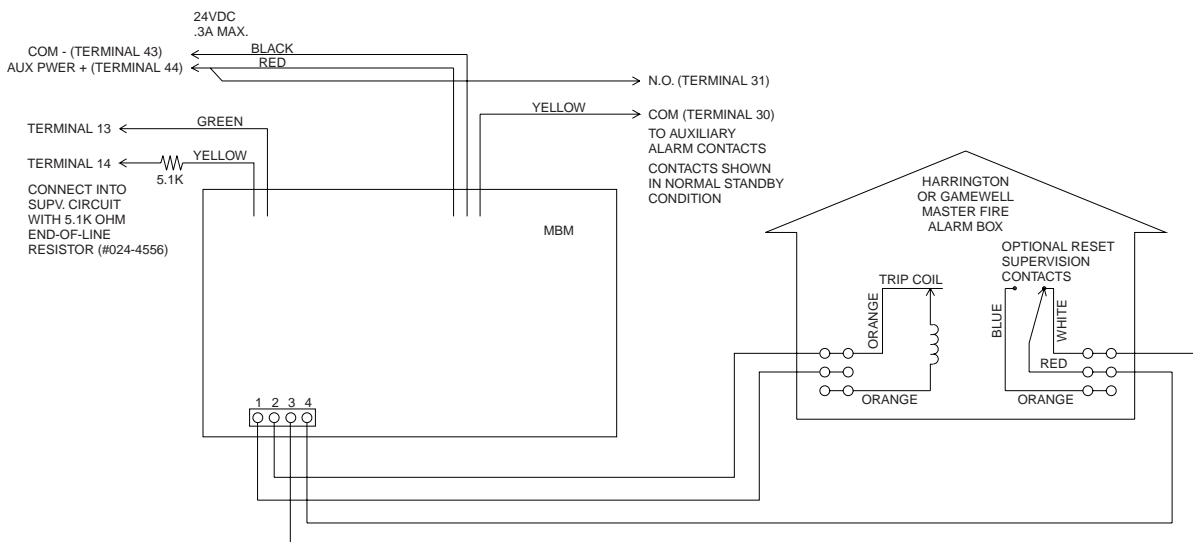

290-0016

INSTALLATION

Mount the snap track with the double-sided tape provided and secure with two #6 sheet metal screws. This module may be installed in a separate housing (HSI #327-0089) that is adjacent to and close-nipped to the fire alarm control panel.

CAUTION:

This module must be installed in accordance with all applicable sections of NFPA 72, the National Electrical Code, all local codes and any authority having jurisdiction.
Appendix normal text

Figure A-7. MBM Module Location.

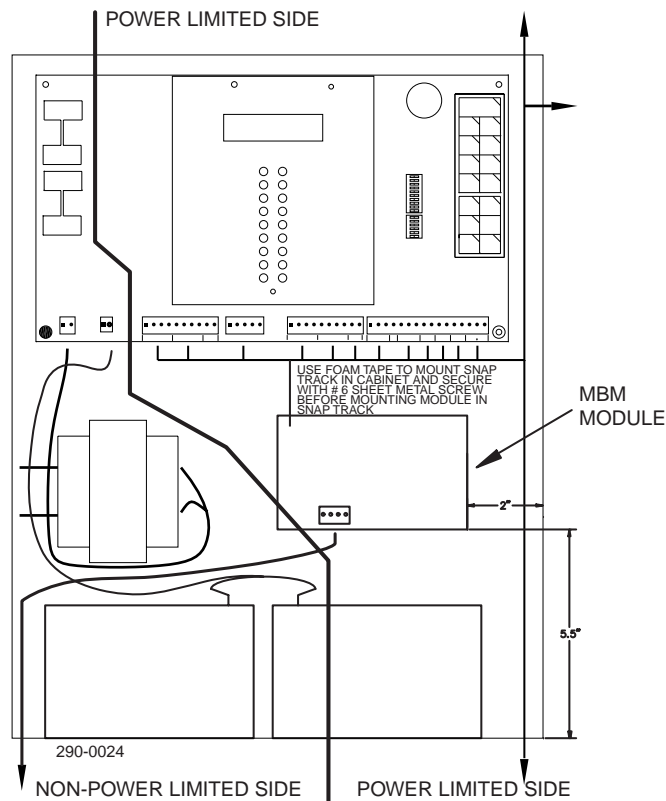

- A
- B
- C
- D
- E

Contents

1

2

3

4

5

A

Appendix B. Smoke Detector Compatibility

HARRINGTON SIGNAL (MAX. NO. OF DETECTORS PER ZONE IS 25)

DET. MODEL	IDENTIFIER	BASE MODEL	IDENTIFIER
H511C	S10A	N/A	N/A
H511CXT	S11A	N/A	

ESL (MAX. NO. OF DETECTORS PER ZONE IS 25)

DET. MODEL	IDENTIFIER	BASE MODEL	IDENTIFIER
429C	S10A	N/A	N/A
429CRT	S11A	N/A	
429CSST	S11A	N/A	
429CST	S11A	N/A	
521B	S10A	N/A	
521CRXT	S10A	N/A	
711U	S10A	702, 702E, 701U, or 701E	S00 for all
711UT	S10A	702, 702E, 701U, or 701E	
712U	S10A	702, 702E, 701U, or 701E	
713-5U	S10A	701U, 702U, or 702E	
713-6U	S10A	701U, 702U, or 702E	
721U	S10A	702U or 702E	
721UD	S10A	702U or 702E	
721UT	S10A	702U or 702E	
722U	S10A	702U or 702E	
731U	S11A	702, 702E, 701RU, or 701RE	
731UD	S11A	702U or 702E	
732U	S11A	702, 702E, 701RU, or 701RE	

SYSTEM SENSOR (BRK) (MAX. NO. OF DETECTORS PER ZONE IS 20)

DET. MODEL	IDENTIFIER	BASE MODEL	IDENTIFIER
1400	A	N/A	N/A
1451	A	B401 B	A
2400	A	N/A	N/A
2400TH	A	N/A	N/A
2451	A	B401 B	A
2451TH	A	B401 B	A

NOTE IF SYSTEM SENSOR DETECTORS ARE MIXED WITH OTHER MANUFACTURERS DETECTORS, DO NOT EXCEED 20 PER ZONE

APOLLO (MAX. NO. OF DETECTORS PER ZONE IS 25)

DET. MODEL	IDENTIFIER	BASE MODEL	IDENTIFIER
55000-150	55000-150	Any of the detectors at the left may use the following: 45681-200	45681-200
55000-151	55000-151	45681-220	45681-220
55000-152	55000-152	45681-227	45681-227
55000-153	55000-153	45681-230	45681-230
55000-250	55000-250	45681-231	45681-231
55000-350	55000-350	45681-232	45681-232
55000-380	55000-380		

NOTE COMPATIBILITY LISTINGS ARE NOT REQUIRED FOR 24 VOLT 4 WIRE DETECTORS

B

C

D

E

Contents

1

2

3

4

5

A

B

Appendix C. NAC Compatibility

The following devices are compatible with the **FireLarm 2500**.

CPG Signals

460 series sounders
 SPLF, SPAF, SPHP, SPHH, SPHX series Powertone® speakers
 ASLP, ASHP, ASHH, ASHX series amplified Powertone® speakers
 MSLP, MSHP series mini speakers
 450E series electronic horn
 VST series strobe lights
 FHEX series explosion proof horn
 FSEX and LSEX series explosion proof strobes
 V1971 series synchronized strobes

Harrington Signal

EMHG0 series mechanical horns
 EHG0 series electronic horns
 EHWPF0 series electro-mechanical outdoor horns
 EMHWPF0 series outdoor electro-mechanical horns
 MHG0 series mini horns
 HSG1, HSG0 series electronic horn strobes
 EHSG0, EMHSG0 series horn strobes
 WEMHSG series outdoor horn strobes
 MHSG0 series mini horn strobes
 SSG1, SSG0, SSTG0, SSF0, SSWPF0 series strobes
 2G1AVCMS, 4G0CMS strobe synchronizers
 SMF0 series strobe synchronizers
 4"LPSPKF0, 8"LPSPKF0 series speakers
 ACVBF0, ACSSF0 series bells (AC)
 DCVBF0 DCVBLCF0 DCSSBF0 series bells (DC)
 ACCH, ACSSCHF0 series chimes (AC)
 DCCHF0, DCCHLCF0, DCSSCHF0 series chimes (DC)

Amseco

SL24C, SDA24, RSD24, SL, CSL CSLB, CSLR series strobes
 SDM10 sync module
 SH, CSH, CSHB, SLB24, SHB24 series horn/strobes
 CSS, SSC, SFH speaker strobes
 FH series speakers

Gentex

GMH24 series mechanical horns
 HG12 series electronic horns
 GX90 series mini horns
 GX90S Series mini horn strobes
 SHG24, HS24, SHG24, GMS24 series horn strobes
 WGMS24 series outdoor horn strobes
 GES24, ST24, GXS, series strobes
 AVS44, 4G0CMS strobe synchronizers

Faraday

6170 series electro-mechanical outdoor horns
 6230, 6235 series outdoor electro-mechanical horns
 2700, 2705 series strobes
 5406 series strobe synchronizers
 2953, 2954, 2955, 2958 series speakers

C

D

E

4415, 4495 series AC chimes
4765, 4775 series DC chimes
3431, 3436, 4496, 4411, 4416 series AC bells
4461, 4464, 4466, 4761, 4764, 4766, 4771, 4774, 4776 series DC bells

Contents

1

2

3

4

5

A

B

C

Appendix D. Ordering Information

Base Components

Model No.	Description	Stock No.
2500-LCD	4 Zone Control Panel (red cabinet) – with LCD	2500-LCD
2500-LED	4 Zone Control Panel (red cabinet) – no LCD	2500-LED
2500-MAN	FireLarm 2500 Installation Instruction Manual	2500-MAN
12V6.5AH	Battery, 12 Volt, 6.5 AH (2 required for 24V)	313-0170
12V8AH	Battery, 12 Volt, 8.0 AH (2 required for 24V)	313-0130
12V10AH	Battery, 12 Volt, 10 AH (2 required for 24V)	313-0254
12V15AH	Battery, 12 Volt, 15 AH (2 required for 24V)	313-0132
12V25AH	Battery, 12 Volt, 25 AH (2 required for 24V)	313-0265

Options

Model No.	Description	Stock No.
BT	Bezel Trim for Semi-Flush Mounting (black)	2500-BT
PAM-1	Relay (for 4-wire detector supervision)	PAM-1
PAM-2	Relay (for 4-wire detector supervision)	PAM-2
OPLCD	LCD Module for FireLarm 2500	2500-OPLCD
RALCD	Remote LCD Annunciator	2500-RALCD
	RALCD Installation Instruction Manual	2500-RALCD-M
CAM	Style Z (Class A) Indicating Circuit Module	2500-CAM
MBM	Master Box Module	2500-MBM
	Enclosure, 6x6x4, 18 gauge	2500-CAB
ZDACT	Zonal Digital Alarm Comm. Transmitter	2500-ZDACT
	ZDACT Installation Instruction Manual	2500-ZDACT-M

Replacement Parts

Model No.	Description	Stock No.
OPLCD	LCD Module for FireLarm 2500	2500-OPLCD
RMB	Main Circuit Board Module for FireLarm 2500	2500-RMB
PWR	Replacement power supply	2500-PWR

D

E

Contents

1

2

3

4

5

A

B

C

D

Appendix E. Quick Reference Operating Instructions

FireLarm 2500

Normal Standby	Green AC indicator on. All other indicators off.
Alarm Conditions	Red zone indicator on. Audible/visual signaling indicator operating
To Silence Alarm	Do not silence alarm until it has been determined that an emergency situation does not exist (panel must be reset to silence waterflow alarms). Open cover and press SILENCE . This will also cause the bell trouble indicator to flash.
To Reset an Alarm	After condition that caused alarm has been corrected, press RESET .
Trouble Conditions	Yellow SYSTEM TROUBLE indicator and buzzer on. Yellow indicator for specific trouble on (battery, zone, trouble, etc.)`
Supervisory Condition	Yellow SYSTEM TROUBLE indicator and buzzer on. Yellow SUPERVISORY indicator on (valve closed, low air, low temperature, etc.)
To Silence Trouble Devices	Open cover and press SILENCE . The panel automatically restores to normal when the trouble condition has been corrected. Some trouble conditions require pressing RESET for restoration. Note: The problem must be corrected as soon as possible as this may make system inoperative. Contact your service organization if necessary.
To Test Alarm	Notify building occupants (if a fire department or other monitoring agency, such as a Central Station alarm company, monitors alarms, they must also be notified). Open cover, press and hold DRILL for 2 seconds.

NOTE *This system should be thoroughly inspected on a regular basis in accordance with the NFPA-72 National Fire Alarm Code and the authority having jurisdiction. Contact the agency listed below for this service.*

For Service, Call

Name: _____

Address: _____

Telephone: _____

INSTALLER: FRAME THIS SHEET AND PLACE ADJACENT TO CONTROL PANEL

CPG Signals
 2519 4th Ave., P.O. Box 590, Moline, IL 61265
 (800) 577-5758 / (309) 762-0731 / FAX (309) 762-8215
 www.cpglifesafety.com

E

Contents

1

2

3

4

5

A

B

C

D

E