

M Series

Audience events
Auditoriums
Boardrooms
Broadcast studios
Conference rooms
Home cinema
Houses of worship
Post-production
Training rooms
And more...



Redefine your expectations.

CHRISTIE®



We didn't just raise the bar. We redefined the entire game.

INTRODUCING THE CHRISTIE M SERIES.

We've designed the M Series, a flexible, efficient line of 3-chip DLP® projectors, with your needs in mind. We've thought of it all, put it into a sleek, compact chassis and provided you with a full set of options.

The most compact in its class, this dual mercury lamp platform provides the high-performance and feature-rich standards you've come to expect from all Christie products. You'll see that we continue to deliver brightness, versatility, reliability and affordability in this latest addition to the Christie family of display solutions.

Ranging from 2500 ANSI lumens (single lamp, 200W) to 9500 ANSI lumens (dual lamp, 350W), each of the M Series projectors offer high efficiency and low cost of ownership by operating

at 1320W – giving you full brightness while using less power. These projectors employ feedback systems to determine the number of lamps and power level used to adjust the fan speed required to cool the system.

The Christie M Series platform includes two resolutions, SX+ (1400 x 1050) and HD (1920 x 1080), and a variable contrast ratio of 2500-10,000:1* (full on / full off) / 650:1 ANSI for crisp, detailed images. Each of the projectors in the series can also be fitted with the broadest range of high-quality lenses – all with true Intelligent Lens System (ILS)™ capabilities.

All this, combined with our world-renowned service, enables the M Series to provide high performance and peace of mind for all users.

* Using dynamic iris.

CHRISTIE®

[1] Dual-lamp system^{1,2}

High-efficiency, dual-lamp system:

- 200W or 350W (two lamp system)
- 120V (operation) for full brightness
- At maximum brightness (9500 ANSI lumens) the unit only draws 1320W
- Stand by power consumption (phantom power draw) is less than 20W
- Lamps can be hot swapped while projector is powered on and in use

Brightness		200W	350W
Dual lamp	max power	5100 ANSI lumens (5560 center lumens)	9500 ANSI lumens (10,450 center lumens)
	min power	3825 ANSI lumens (4210 center lumens)	7125 ANSI lumens (7840 center lumens)
Single lamp	max power	2500 ANSI lumens (2805 center lumens)	4750 ANSI lumens (5225 center lumens)
	min power	1910 ANSI lumens (2100 center lumens)	3560 ANSI lumens (3920 center lumens)

Flexible lumens levels at various lamp powers.
Lamp power is specific to each model and cannot be interchanged.

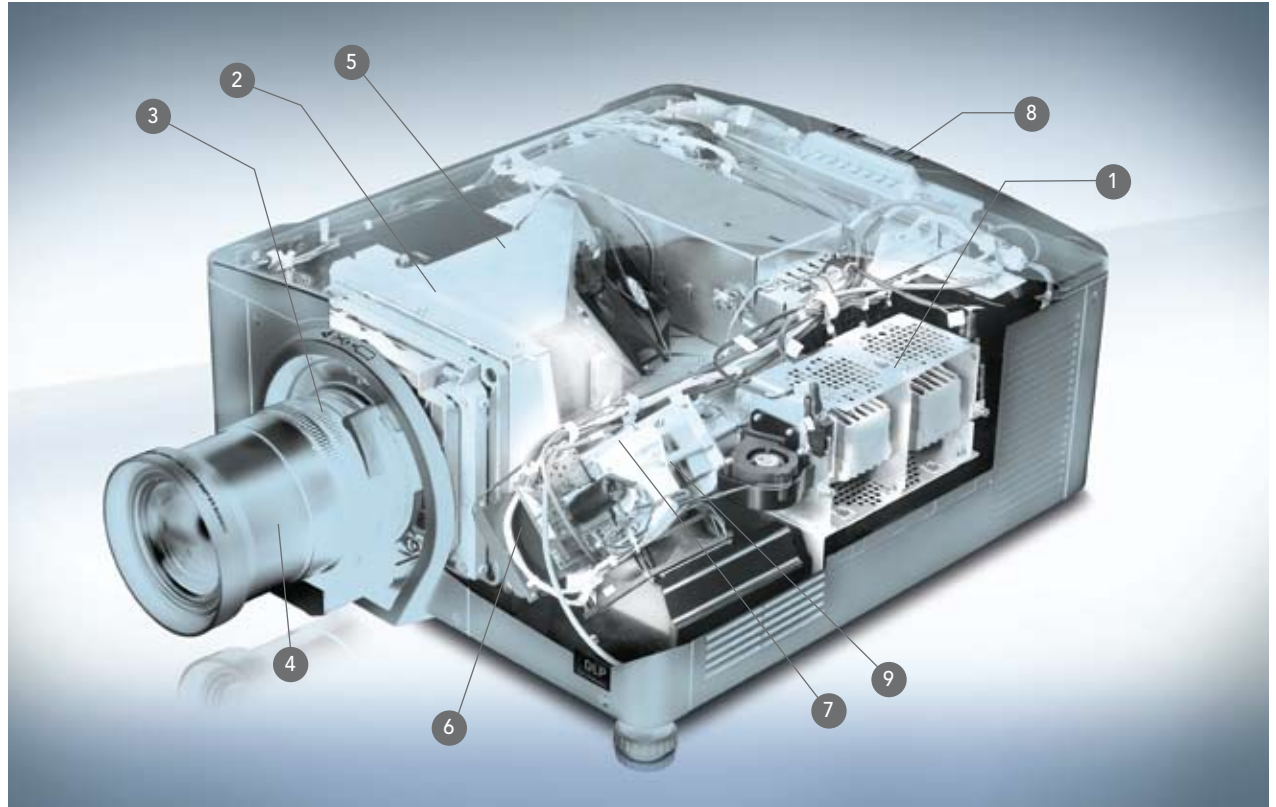

[2] Image quality

3-chip DLP® technology, high-quality optics and world-class 10-bit image processing.

With low maintenance and highly reliable (>100,000 hours) DLP® technology, the Christie M Series delivers:

- High brightness
- Excellent color
- Excellent uniformity
- High contrast
- Excellent fill ratio



[3] Intelligent Lens System (ILS)™



The ILS automatically recognizes and calibrates a lens when it is installed. Stepper motor based encoding ensures that motor drift does not occur, as typically found with DC encoded motors, providing accurate and repeatable recall of all lens offset, zoom and focus positions.

[4] Expanded lens suite



With the addition of a short zoom (1.25-1.6:1 SX+/1.16-1.49:1 HD) and a long zoom (7.5-11.2:1 SX+/6.9-10.4:1 HD), this expanded suite provides the broadest range of HD lenses in this marketplace.

[5] Dust sealed engine



M Series projectors can operate filter-free because of dust-sealed engines and optics. Since dust and dirt cannot affect the system and filters are not required,

image quality is maintained and maintenance costs are lower. Removable side panels enable the addition of optional coarse dust and fog juice filters for projectors that are exposed to harsh environments.

[6] Motorized yellow notch filter²

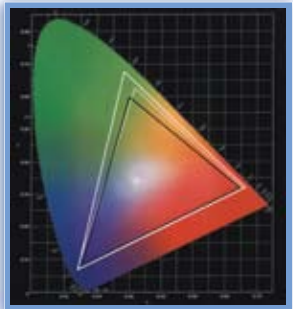

- Expanded color gamut
- Regular color gamut
- REC 709

The motorized yellow notch filter optically expands the color gamut for richer greens and yellows. Since you lose some brightness by improving the greens and yellows, this is a channel-configurable option which enables you to decide when it is needed. This filter is standard on all M Series HD models and is ideal when video is being displayed.



Standard color gamut



Expanded color gamut

[7] Dynamic iris

Ideal for video applications, the dynamic iris is a channel-configurable option. It automatically adjusts an internal iris to extend the range of blacks and provide richer details during dark scenes for true image reproduction.

A variable contrast ratio of 2500-10,000:1 produces a picture with a rich, dynamic appearance.

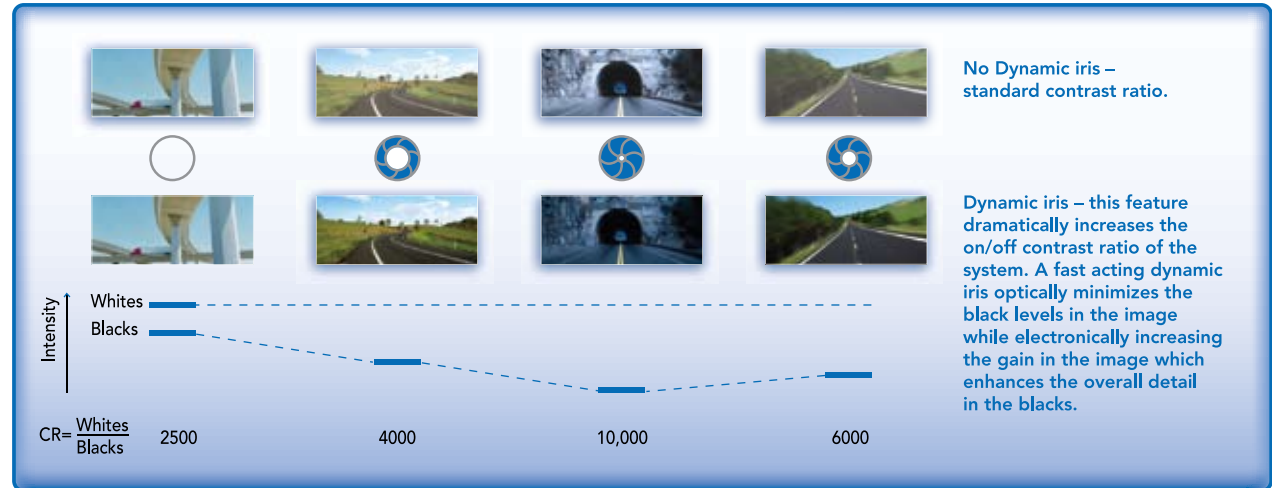

[8] Embedded Christie Twist™

Standard in all M Series models, Christie Twist™ enables seamless white and black level edge-blending of multiple curved images, faster and more easily than through traditional, manual methods. Controlled by an easy-to-use GUI users can expertly control and edge blend or stack multiple curved images quickly and seamlessly. Images can be warped to fit virtually any dimension or shape display. Embedded Christie Twist™ ensures that all M Series projectors work with value-added accessories, such as AutoStack™.



Easy-to-use GUI



Easy-to-use GUI

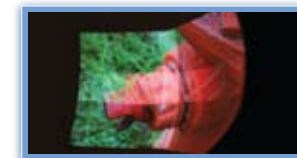

Image on curved screen – before blending



Curved screen – after blending

[9] LiteLOC™¹

The LiteLOC™ feature automatically manages your display's brightness levels over time so that you can match the brightness of a multiple projector system in tiled or blended arrays. This feedback system continuously monitors lamp brightness, so that as the lamp goes through its natural brightness decay, the system increases the lamp power in order to maintain consistent brightness.

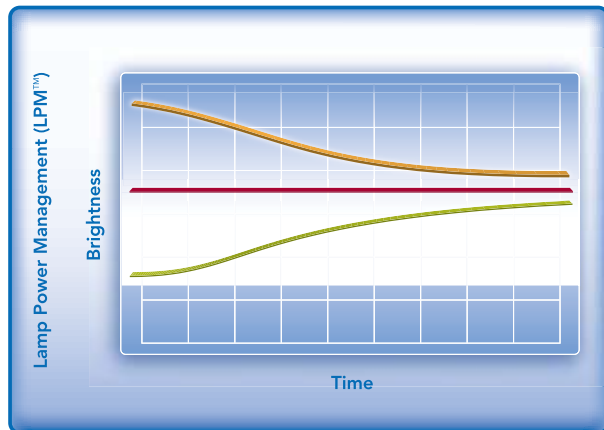
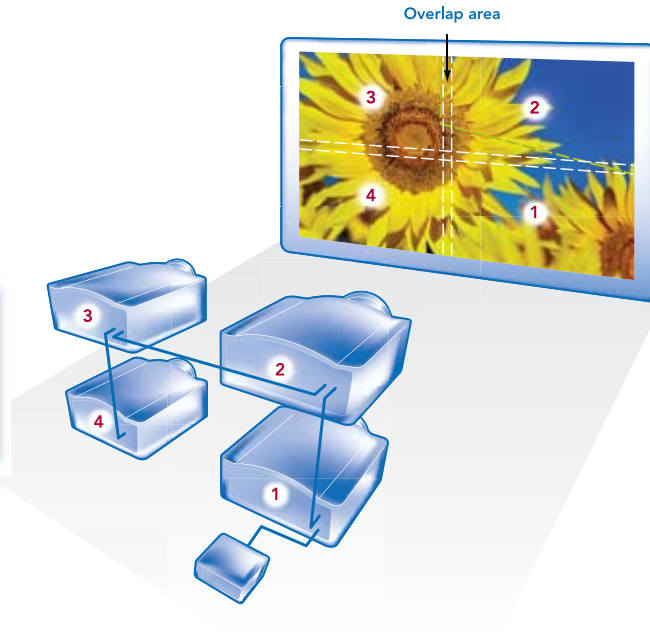

■ Natural lamp brightness ■ Constant regulated brightness ■ Lamp power

[8] Multi-window/screen processing

External processors are not required for simple, small tiled and blended arrays, therefore lowering your costs for installation. Each M Series projector has the ability to send signals to multiple projectors (up to a 3 x 3 array)* without any additional hardware or software. The projectors in the tiled array can then show only the portion of the signal that they need to project.

[8] Embedded edge blending and color matching

Advanced blending capabilities and Comprehensive Color Adjustment (CCA™) ensure digitally accurate color matching and uniformity across multi-screen blended or tiled images.

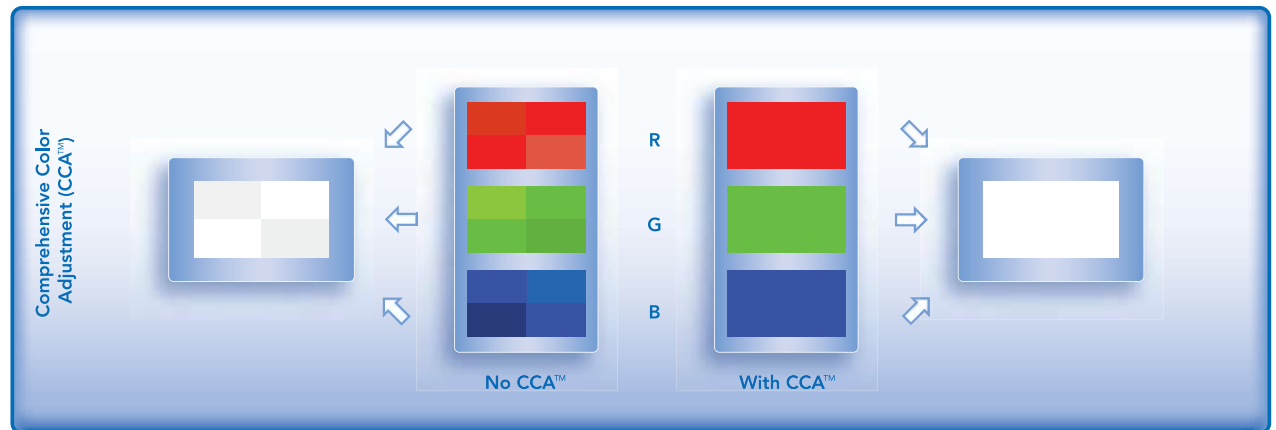
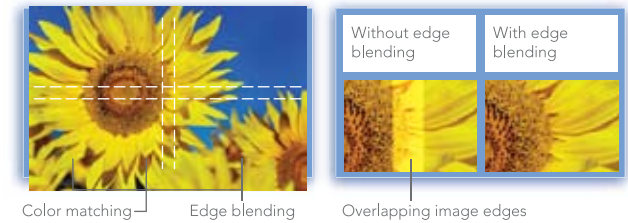

* Subject to input bandwidth limitations.

[8] ChristieNET™ web interface

ChristieNET™ enables users to access all projector menus and controls through a web interface without disrupting the live presentation. This allows for real-time adjustments and monitoring of each projector on the network – regardless of geographic location.

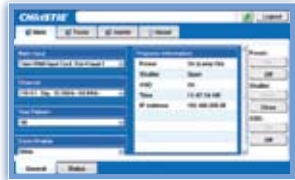

Main page controls and information



Virtual On Screen Display (OSD): access full menu structure, remotely.



Status and diagnostics: displays alarm events for quick projector monitoring and diagnosis



Admin screen includes upload, backup, restore and more

[8] Automatic shut-off

This feature lowers the cost of ownership by reducing power consumption and extending lamp life when the projector is not in use. In this mode, if a signal is not detected, the projector will slowly dim the lamps then shut off one lamp, and finally if there is still no signal, the system will go into standby mode. If a signal is detected during the ramp-down phase the unit will revert back to its full power, dual lamp mode.

[8] Input cards



In total, there are four input card slots available. Each projector is equipped with a standard set of input cards.

Dual SD/HD – SDI input card



The Dual SD/HD-SDI input card accepts both standard-definition (SD) and high-definition (HD) serial-digital-interface (SDI) signals, and enables the user to connect

two of either types of signal. Both single-link HD and dual-link HD signals are accepted. This card also has two SD/HD-SDI outputs to enable “loop-through” for its respective input.

Analog input card



The Analog input card accepts an analog video signal input over a 5 BNC connector interface. It can accept RGBHV signals over 5 connectors, as well as component YPbPr signals on the RGB inputs.

Dual link DVI input card

The Dual link DVI input card has a 15-pin VGA connector for analog signals and a DVI-I connector which can support a single- or dual-link DVI HDCP video signal. The card can simultaneously support a digital signal on the DVI input and an analog signal on the VGA port.

DMX512 interface card

This interface card supports the DMX512 communication standard through two 5-pin XLR connectors.

Video decoder input card



The Video decoder input card accepts various types of standard definition (SD) video, including CVBS (composite video), S-video, and component. It accepts NTSC 3.58, NTSC 4.4,

PAL, PAL-N, PAL-M or SECAM formats. This card has two mini-DIN connectors (for S-video signals) and four BNC connectors that can be grouped to allow combinations of CVBS, S-Video, YPrPb or RGB video sources.

Twin HDMI™ input card



The Twin HDMI input card accepts two HDMI inputs and provides 12-bit deep color handling on the input. Additionally, advanced loop-through allows any

input on any input card to be looped through to the two HDMI outputs on the card.

LCD keypad



This easy-to-use LCD keypad includes:

- Contextual menus provide a fully-featured, intuitive interface; removing the need for a cluttered keypad

- Large, four line LCD display
- Adjustable brightness and timed LCD off mode
- Intuitive keypad design that lights up when features are active – making it user friendly
- Active keys are color-coded amber to indicate that selections will result in changes visible to the audience.

Dual-frequency receiver

The dual-frequency (38 kHz and 455 kHz) receiver ensure the projector receives signals at increased distances between the remote and projector, and reduces the affect of interference from lighting.

Quiet operation

When your presentation depends on the full attention of your audience you don't want them focused on the noise from your projector. The filter-free design with auto-sensing fan and temperature sensors automatically adjust for the quietest operation possible.

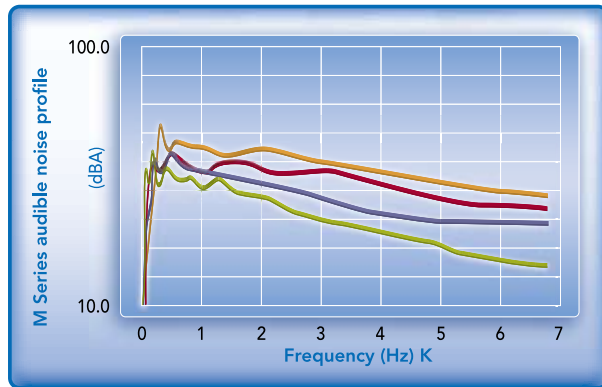

■ 200W single lamp mode ■ 350W dual lamp mode
 ■ 200W dual lamp mode ■ Max ambient with filter installed

Sound is reduced in the various modes, as well, high pitched, annoying frequencies are minimized.

Roadster models



The M Series Roadster models have been designed with stagers in mind. The Christie Roadster S+10K-M and the Christie Roadster HD10K-M ship equipped with more input cards than the other M Series models, as well as a stacking frame.

Accessories

Whatever you need, Christie has a large selection of optional accessories. Create the projector you need by choosing from eight lenses, various input cards and much more.

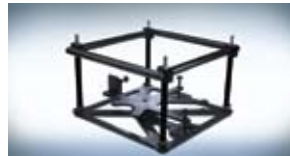

Optional stacking frame



Optional ceiling mount



Optional lamp



Optional lenses

Filters (optional)

If the environment you're working in requires more than the protection of our dust sealed engine, choose from one of two filters (coarse dust and fog juice). Help extend the life of your projector and protect your investment from dirt, dust, sand as well as fog, smoke, hazers and pyrotechnics. Each M Series projector is equipped with two removable side panels that are designed to hold a filter, if required.



Optional coarse dust filter



Optional fog juice filter

	Description	Part number
Lens - fixed	Lens ILS 0.73:1 SX+/0.67:1 HD	118-100110-XX
	Lens ILS 1.2:1 SX+ /1.1:1 HD	118-100117-XX
Lens - zoom	Lens ILS 1.25-1.6:1 SX+/1.16-1.4:1 HD	118-100111-XX
	Lens ILS 1.5-2.0:1 SX+/1.4-1.8:1 HD	118-100112-XX
	Lens ILS 2.0-2.8:1 SX+/1.8-2.6:1 HD	118-100113-XX
	Lens ILS 2.8-4.5:1 SX+/2.6-4.1:1 HD	118-100114-XX
	Lens ILS 4.5-7.5:1 SX+/4.1-6.9:1 HD	118-100115-XX
	Lens ILS 7.5-11.2:1 SX+/6.9-10.4:1 HD	118-100116-XX
Lamps*	Assembly 350W lamp	003-100857-XX
	Assembly 200W lamp	003-100856-XX
Input cards	Analog input	108-309101-XX
	Dual link DVI input	108-312101-XX
	Video decoder input	108-310101-XX
	Dual SD/HD-SDI input	108-313101-XX
	Twin HDMI input	108-311101-XX
	DMX512 interface	108-314101-XX
Miscellaneous accessories	Coarse dust filter pack M Series	118-100104-XX
	Fog juice filter pack M Series	118-100105-XX
	Stacking frame	118-100107-XX
	Ceiling mount	118-100108-XX
	Portrait coupler	118-116109-XX

* Lamp power is specific to each model and cannot be interchanged.

		DS+6K-M	DS+10K-M	Roadster S+10K-M	HD6K-M	HD10K-M	Roadster HD10K-M	
Image	brightness	Dual lamp: 5000 ANSI lumens (5500 center lumens) Single lamp: 2500 ANSI lumens (2750 center lumens)	Dual lamp: 9300 ANSI lumens (10,230 center lumens) Single lamp: 4650 ANSI lumens (5115 center lumens)		Dual lamp: 5100 ANSI lumens (5560 center lumens) Single lamp: 2550 ANSI lumens (2805 center lumens)	Dual lamp: 9500 ANSI lumens (10,450 center lumens) Single lamp: 4750 ANSI lumens (5225 center lumens)		
	contrast	2500-10,000:1 (full on/off) 650:1 ANSI (typical)						
Display	type	3-chip 0.95" DMD						
	native resolution	SX+ (1400 x 1050)			HD (1920 x 1080)			
Lamp	type	Dual Osram 200W P-VIP	Dual Osram 350W P-VIP		Dual Osram 200W P-VIP	Dual Osram 350W P-VIP		
	life	High power: 2000 hrs @ 200W Low power: 3000 hrs @ 150W	High power: 1500 hrs @ 350W Low power: 2000 hrs @ 300W		High power: 2000 hrs @ 200W Low power: 3000 hrs @ 150W	High power: 1500 hrs @ 350W Low power: 2000 hrs @ 300W		
Input	signals	HDTV formats VGA through to QXGA (2048 x 1536) • Accepts all current HDTV/DTV formats • Multi-standard video decoder • Horizontal and vertical scaling, all inputs						
	pixel clock	165 MHz						
	scan rates	Horizontal: 15 to 120 kHz • Vertical: 23.97 to 150 Hz						
Inputs, control and networking		RS232 in/out • RS422 In • Ethernet (10/100) • USB Device • GPIO (RS232 9 Pin male connector) • Built-in backlit LCD keypad • Remote control (with optional wired XLR connection)						
Optical system		Dust sealed, 3-chip DMD light engine • Motorized horizontal and vertical lens offset • Scheimpflug (tilt) adjustment • Built-in light shutter • Tool-free lens insertion system						
Lenses	fixed	0.73:1 SX+/0.67:1 HD* • 1.2:1 SX+/1.1:1 HD						
	zoom	1.25-1.6:1 SX+/1.16-1.49:1 HD • 1.5-2.0:1 SX+/1.4-1.8:1 HD • 2.0-2.8:1 SX+/1.8-2.6:1 HD • 2.8-4.5:1 SX+/2.6-4.1:1 HD • 4.5-7.5:1 SX+/4.1-6.9:1 HD • 7.5-11.2:1 SX+/6.9-10.4:1 HD						
	offsets	±100% Vertical • ±50% Horizontal • (* ±23%V / ±13%H)				±120% Vertical • ±42% Horizontal • (* ±35%V / ±12%H)		
Accessories	standard	Input cards – analog, dual link DVI • User manual • IR remote • Line cord	Input cards – analog, dual link DVI, dual SD/HD-SDI, video decoder • Stacking frame • User manual • IR remote • Line cord	Input cards – analog, dual link DVI • User manual • IR remote • Line cord	Input cards – analog, dual link DVI, dual SD/HD-SDI, video decoder • Stacking frame • User manual • IR remote • Line cord			
	optional	Input cards – analog, dual link DVI, dual SD/HD-SDI, video decoder, twin HDMI • Coarse dust filter • Fog juice filter • Ceiling mount • Stacking frame • and more (see accessories section of brochure)						
Enhanced feature sets ³		LitelOC™ • Comprehensive Color Adjustment (CCA™) • Embedded Christie Twist™ image warping and edge-blending • Intelligent Lens System (ILS™) for zoom, focus, horizontal and vertical offset for all lenses • Auto setup • Digital keystone correction • Dynamic iris • Menus in five languages • 99 channel memories • Multi-windowing and processing (up to a 3 x 3 array) • Motorized yellow notch filter (HD models only)						
Power requirements	operating voltage	110-240 VAC 50/60 Hz						
	operating current	8.7 A @ 100 VAC	13.2 A @ 100 VAC		8.7 A @ 100 VAC	13.2 A @ 100 VAC		
	power	870W	1320W		870W	1320W		
	dissipation	2971 BTU/hr	4508 BTU/hr		2971 BTU/hr	4508 BTU/hr		
Dimensions	size	(LxWxH): 22.1 x 19.7 x 10.2" (561 x 500 x 259mm)						
	shipping dimensions	(LxWxH): 29 x 27 x 20.5" (737 x 689 x 521mm)						
	weight	55 lb (25 kg)						
	shipping weight	75 lb (34 kg)						
Operating environment		Temperature: 40 to 104° F (5 to 40° C)			Humidity: 10-80% non-condensing			
Regulatory approvals		UL/CSA/IEC 60,950 (3rd edition) • FCC Class A, CE, CCC • This product conforms to all relevant European directives, standards, safety, health and environmental concerns • RoHS, WEEE						
Limited warranty		2 years parts and labor (including light engine) • Contact an authorized Christie representative for full details of our limited warranty						

¹ US Patents 7,230,768; 6,205,271; 6,734,957. ² Patent pending. ³ Some features may not be functional on initial product shipments but will be enabled via software upgrade when available.

		Lenses											
		0.73:1 SX+/ 0.67:1 HD	1.2:1 SX+/ 1.1:1 HD	1.25-1.6:1 SX+/1.16-1.49:1 HD		1.5-2.0:1 SX+/ 1.4-1.8:1 HD		2.8-4.5:1 SX+/ 2.6-4.1:1 HD		7.5-11.2:1 SX+/6.9-10.4:1 HD			
		Lens throw ratio											
Screen size		0.73	1.2	1.25	1.6	1.5	2	2.8	4.5	7.5	11.2		
SX+ (4:3)	Screen width – ft (m)	Throw distance – ft (m)											
	Screen height – ft (m)	4.8 (1.5)	3.6 (1.1)	3.5 (1.1)	5.8 (1.8)	6.0 (1.8)	7.7 (2.3)	7.2 (2.2)	9.6 (2.9)	13.4 (4.1)	21.6 (6.6)	36.0 (11.0)	53.8 (16.4)
	6.4 (2.0)	4.8 (1.5)	4.7 (1.4)	7.7 (2.3)	8.0 (2.4)	10.2 (3.1)	9.6 (2.9)	12.8 (3.9)	17.9 (5.5)	28.8 (8.8)	48.0 (14.6)	71.7 (21.8)	
	12.8 (3.9)	9.6 (2.9)	9.3 (2.8)	15.4 (4.7)	16.0 (4.9)	20.5 (6.2)	19.2 (5.9)	25.6 (7.8)	35.8 (10.9)	57.6 (17.6)	96.0 (29.3)	143.4 (43.7)	
	20.0 (6.1)	15.0 (4.6)	14.6 (4.5)	24.0 (7.3)	25.0 (7.6)	32.0 (9.8)	30.0 (9.1)	40.0 (12.2)	56.0 (17.1)	90.0 (27.4)	150.0 (45.7)	224.0 (68.3)	
	24.0 (7.3)	18.0 (5.5)	17.5 (5.3)	28.8 (8.8)	30.0 (9.1)	38.4 (11.7)	36.0 (11.0)	48.0 (14.6)	67.2 (20.5)	108.0 (32.9)	180.0 (54.9)	268.8 (81.9)	
	32.0 (9.8)	24.0 (7.3)	23.4 (7.1)	38.4 (11.7)	40.0 (12.2)	51.2 (15.6)	48.0 (14.6)	64.0 (19.5)	89.6 (27.3)	144.0 (43.9)	240.0 (73.2)	358.4 (109.2)	
	40.0 (12.2)	30.0 (9.1)	29.2 (8.9)	48.0 (14.6)	50.0 (15.2)	64.0 (19.5)	60.0 (18.3)	80.0 (24.4)	112.0 (34.1)	180.0 (54.9)	300.0 (91.4)	448.0 (136.6)	
HD (16:9)	Screen size	0.67	1.1	1.16	1.49	1.4	1.8	2.6	4.1	6.9	10.4		
	Screen width – ft (m)	Throw distance – ft (m)											
	Screen height – ft (m)	5.2 (1.6)	2.9 (0.9)	3.5 (1.1)	5.8 (1.8)	6.1 (1.8)	7.8 (2.4)	7.3 (2.2)	9.4 (2.9)	13.6 (4.1)	21.4 (6.5)	36.1 (11.0)	54.4 (16.6)
	7.0 (2.1)	3.9 (1.2)	4.7 (1.4)	7.7 (2.3)	8.1 (2.5)	10.4 (3.2)	9.8 (3.0)	12.6 (3.8)	18.1 (5.5)	28.6 (8.7)	48.1 (14.7)	72.5 (22.1)	
	13.9 (4.3)	7.8 (2.4)	9.3 (2.8)	15.3 (4.7)	16.2 (4.9)	20.8 (6.3)	19.5 (6.0)	25.1 (7.7)	36.3 (11.1)	57.2 (17.4)	96.2 (29.3)	145.0 (44.2)	
	21.8 (6.6)	12.3 (3.7)	14.6 (4.4)	24.0 (7.3)	25.3 (7.7)	32.5 (9.9)	30.5 (9.3)	39.2 (12.0)	56.7 (17.3)	89.3 (27.2)	150.3 (45.8)	226.6 (69.1)	
	26.1 (8.0)	14.7 (4.5)	17.5 (5.3)	28.8 (8.8)	30.3 (9.2)	39.0 (11.9)	36.6 (11.2)	47.1 (14.3)	68.0 (20.7)	107.2 (32.7)	180.4 (55.0)	271.9 (82.9)	
	34.9 (10.6)	19.6 (6.0)	23.4 (7.1)	38.3 (11.7)	40.4 (12.3)	51.9 (15.8)	48.8 (14.9)	62.8 (19.1)	90.6 (27.6)	142.9 (43.6)	240.6 (73.3)	362.6 (110.5)	
	43.6 (13.3)	24.5 (7.5)	29.2 (8.9)	47.9 (14.6)	50.6 (15.4)	64.9 (19.8)	61.0 (18.6)	78.4 (23.9)	113.3 (34.5)	178.7 (54.5)	300.7 (91.7)	453.2 (138.1)	

All values are within a 5% error.

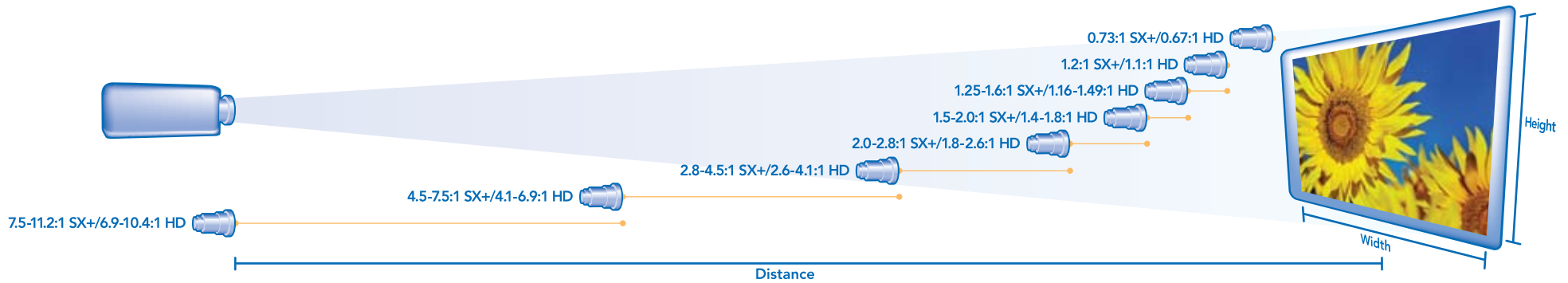

Front view

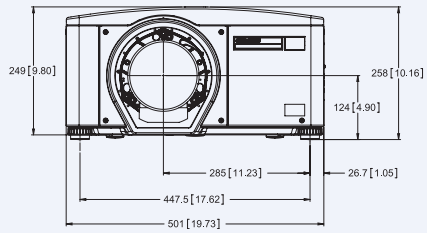

Side view

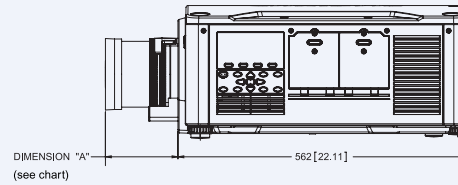

Description	Part number	Dimension 'A'
Lens ILS 0.73:1 SX+/0.67:1 HD	118-100110-XX	215mm (8.49")
Lens ILS 1.2SX+/1.1HD	118-100117-XX	279mm (11.01")
Lens ILS 1.25-1.6 SX+/1.16-1.49 HD	118-100111-XX	238mm (9.37")
Lens ILS 1.5-2.0 SX+/1.4-1.8 HD	118-100112-XX	205mm (8.07")
Lens ILS 2.0-2.8 SX+/1.8-2.6 HD	118-100113-XX	169mm (6.68")
Lens ILS 2.8-4.5 SX+/2.6-4.1 HD	118-100114-XX	155mm (6.14")
Lens ILS 4.5-7.5 SX+/4.1-6.9 HD	118-100115-XX	141mm (5.51")
Lens ILS 7.5-11.2 SX+/6.9-10.4 HD	118-100116-XX	199mm (7.86")



Top view

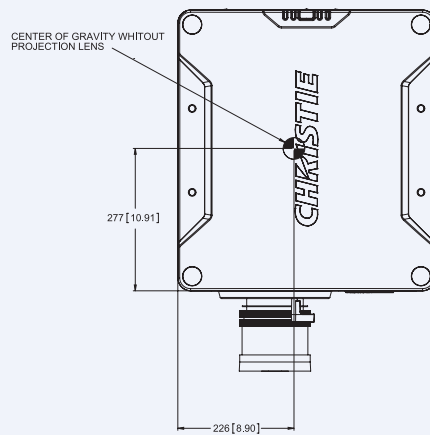

Underneath view

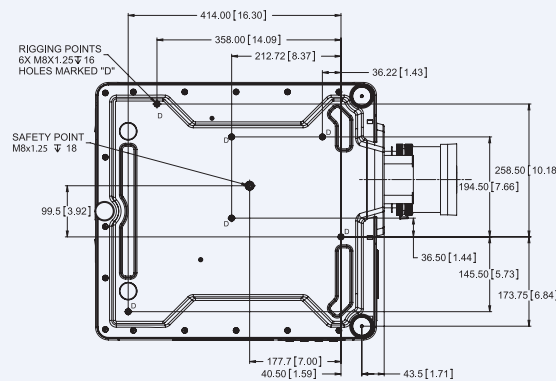

Corporate offices

USA – Cypress
ph: 714-236-8610
Canada – Kitchener
ph: 519-744-8005

Worldwide offices

United Kingdom
ph: +44 118 977 8000
Germany
ph: +49 2161 664540
France
ph: +33 (0) 1 41 21 44 04

Hungary/Eastern Europe
ph: +36 (0) 1 47 48 100
Singapore
ph: +65 6877 8737
India
ph: +91 80 4146 8940

Shanghai
ph: +86 21 6278 7708
Beijing
ph: +86 10 6561 0240

Korea
ph: +82 2 702 1601
Japan
ph: +81 3 3599 7481



For the most current specification information, please visit www.christiedigital.com

 Copyright 2008 Christie Digital Systems, Inc. All rights reserved. All brand names and product names are trademarks, registered trademarks or tradenames of their respective holders. Canadian manufacturing facility is ISO 9001 and 14001 certified. Performance specifications are typical. Due to constant research, specifications are subject to change without notice. Printed in Canada on recycled paper. 2382 Aug 08

CHRISTIE®