



**Broil King®**  
**KEG**

**OPERATION HANDBOOK**  
**911770 / 4000 Series**

# Broil King® KEG

The BROIL KING® KEG is designed to make your good times better. This was our quest and the result is the BROIL KING® KEG - a fabulous outdoor cooking appliance.

By purchasing your BROIL KING® KEG and perfecting your own recipes with it, your passion for grilling is about to go to a whole new level. Your skills and reputation will grow with each triumphant cookout and rave review.

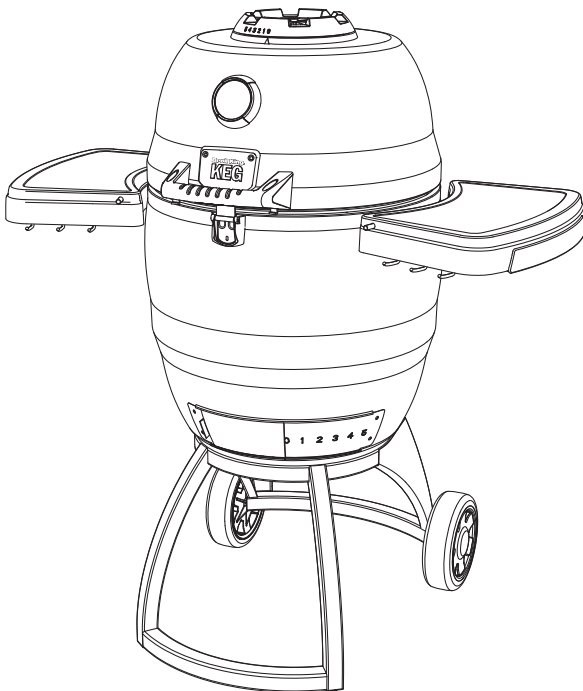

## WARNING

DO NOT OPERATE OVER 800°F / 425°C

MULTIPLE PATENTS PENDING

## ! DANGER

- This grill is designed for outdoor use only. If used indoors, toxic fumes will accumulate and cause serious bodily injury or death.
- Do not add charcoal starter fluid or charcoal impregnated with charcoal starter fluid to hot or warm charcoal.
- Do not leave children or pets unattended near a hot grill.
- Do not attempt to move a hot grill.
- Do not use grill within five feet of any combustible material.
- Do not use unless grill is fully assembled and all parts are in place.
- Do not remove ashes until all charcoal is completely burned out and fully extinguished.
- Do not use grill in high winds.

## ! WARNING

- Keep the grill in a level position at all times.
- Always use fire bowl and charcoal grate.
- Never touch the cooking or charcoal grate or the grill to see if they are hot.
- Use barbecue mitts or hot pads to protect hands while cooking or adjusting the dampers.
- Use proper barbecuing tools with long, heat-resistant handles.
- To extinguish the coals, close the lid and both dampers completely. Do not use water because it will damage the grill's finish.

**FAILURE TO HEED THESE DANGER AND WARNING STATEMENTS MAY CAUSE SERIOUS INJURY OR DEATH, OR A FIRE OR EXPLOSION RESULTING IN DAMAGE TO PROPERTY.**

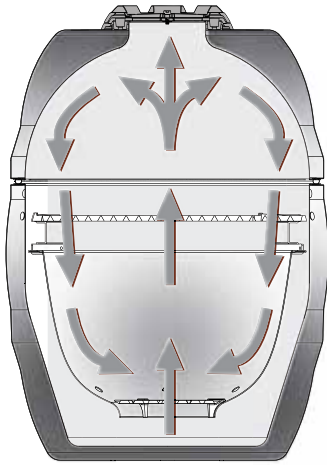

The unique **BROIL KING® KEG** shape is perfectly designed for efficient thermal convection-style cooking.

Two steel walls and commercial grade insulation keeps the heat in and maximizes fuel efficiency.

The thermometer, built right into the lid, assures you are able to maintain the proper temperature inside the grill for whatever feast you are preparing.

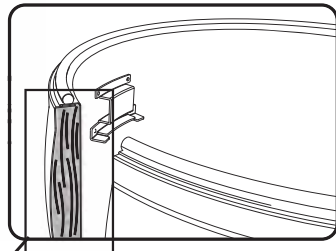

Bottle Openers

Removable Cooking Grates

Charcoal Grate

Fire Bowl

Multi-Tool

Tool Hooks

Removable Side Tray

Tool Hooks

Removable Side Tray

To assemble your **BROIL KING® KEG** see the Assembly Instructions

Wedges

Wedges

Ultra-sturdy steel frame

Leveling Feet



### Natural Lump Charcoal

Your BROIL KING® KEG will run on many types of fuel including traditional charcoal briquettes and even wood chunks. The KEG works best with True 'Cue™ 100% Natural Hardwood Lump Charcoal (MODEL# TCF5505). Good natural lump charcoal, like True 'Cue™, contains no chemicals, additives or fillers. This means your fire burns hotter, cleaner and makes less ash than with charcoal briquettes.



### Fire Starter Sticks

The preferred fire starters for your BROIL KING® KEG are True 'Cue™ Match tip Firestarters (MODEL# TCF5511). They'll get the lump charcoal going without using lighter fluids. (which we don't recommend)

You'll find lump charcoal and starter sticks at hardware stores, general merchandise stores, and outdoor product stores where cookout supplies are sold.

## Broil King KEG Initial 'Burn-In'

### Season The Cast Iron Grate

Before you start to cook anything on your new BROIL KING® KEG, you first have to burn off the coating used to protect your BROIL KING® KEG during shipment. You will then need to season it, this will protect the cast iron parts from rusting during normal use.

First remove the grill grates and wash thoroughly in warm, soapy water. Rinse completely and dry with a soft towel. Don't allow to air dry and don't ever put in a dishwasher.

When the cast iron grill grate is completely dry, apply a coating of solid vegetable shortening to both sides of it for protection. Also apply vegetable shortening to the top damper, inside and out.

For the final "seasoning" step - fire up your BROIL KING® KEG to about 400°F for about an hour. That'll burn off any of the protective coating that might still be in the pores of the metal. It may be a good idea to repeat the seasoning process to your grill grate every so often.

## WARNING

Always use caution when opening the lid. Carefully ease the lid open just a crack (about one inch) and count to five (1-2-3-4-5) before opening all the way. This allows the heat that has built up inside the grill to escape slowly and prevents a sudden rush of oxygen from causing a flare-up.

## Broil King® KEG Lighting

### Step 1:

Set the top and bottom dampers positions to position 5 to let the maximum amount of air in to fuel the fire.

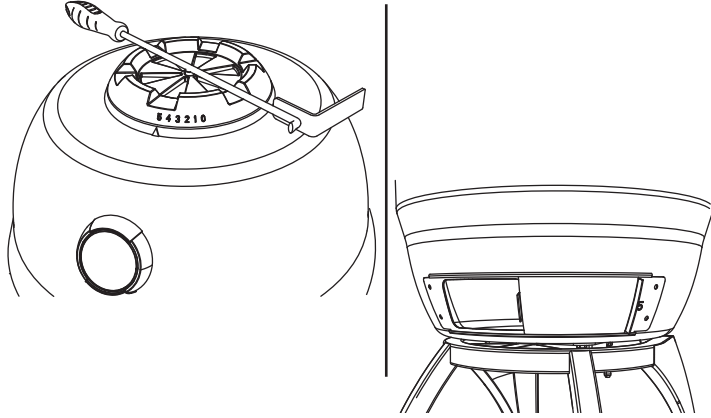

### Step 2:

Open the lid, remove the two grilling grates and pour roughly 1.5 pounds of the natural lump charcoal onto the charcoal grate in the bottom of your BROIL KING® KEG.

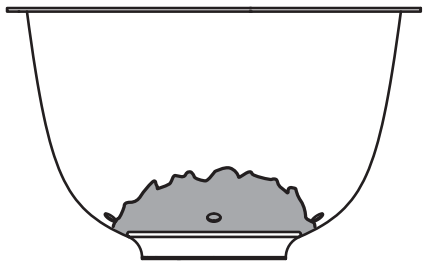

**Careful** - not too much charcoal. The charcoal should cover the charcoal grate in a slight mound piled not much higher than the fire holes. Important: **Do not allow lump charcoal to block or cover the air holes in the firebowl.**

As you become more familiar with your KEG, you will quickly get a feel for how much charcoal you need for each type of cooking. Because your BROIL KING® KEG is so efficient, it takes less charcoal than you're used to using.

### Step 3:

Now the starter sticks can be lit and poked into the side of the mound.

### Step 4:

Allow the charcoal to ignite with lid open until any flames go out before closing the lid.

### Step 5:

Put the grill grate back in place and close lid. Stay close by to adjust dampers to desired cooking temperature.

## BROIL KING® KEG heats up fast...

... and can get extremely hot.

Begin to adjust the dampers down from the "5" position once the temperature hits about 100°F below your target temperature.



## Multi-Tool makes it all even easier

This gadget is just as cool as the versatile BROIL KING® KEG itself.

Use it to:

- Safely adjust the top and bottom dampers, (they can get quite hot).
- Move the cooking grates.
- Remove ash by raking out and into a metal bucket.

## Broil King KEG Controlling Temperature

The BROIL KING® KEG allows you to control cooking temperature by regulating airflow through the top and bottom dampers. The more you open the dampers, the more air will flow through and the hotter the temperature will get. Small adjustments to the dampers will impact the cooking chamber temperature.

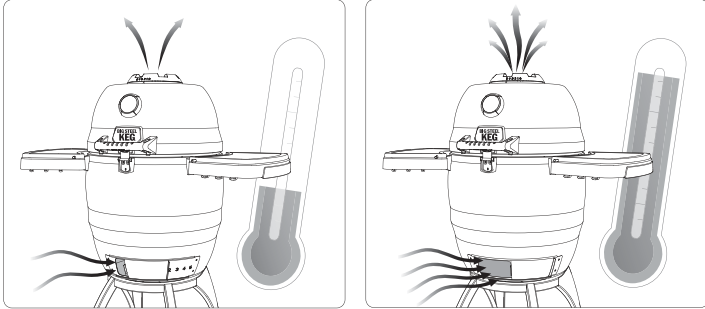

### Cooking At Low Temperatures

For cooking at low temperatures - below 300°F - manage the temperature closely so not to exceed desired cooking temperature when starting the fire. It is important to get the dampers in the 1 position (or lower) before the fire gets too hot.

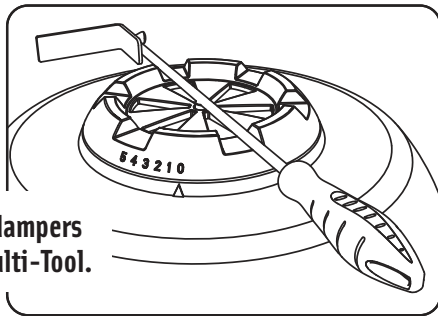

Adjust the dampers  
using the Multi-Tool.

## Cooking The First Time

### Grate Positions

The BROIL KING® KEG allows you to adjust the position of the cooking grates to suit your needs. The cast iron cooking grate has two positions. The lower position enables the grill to accommodate larger dishes like whole turkeys or roasts. For smaller items, you may want to use the higher position.

The Multi-Tool can be used to adjust the grate position. Make sure the tab on the tool fits the notch on the cast iron grill grate.

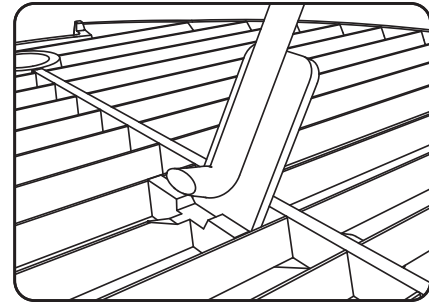

The chrome plated grill grate provides an additional cooking surface. When using the chrome grate, the cast iron grate must be in the lower locked position. The chrome plated cooking grate can swing out of the way to access the lower cooking grate during cooking.

### SHUTTING DOWN

When you're ready to shut down the BROIL KING® KEG, close both dampers to put fire out completely.

You may still have unused charcoal left, leave it there, it is still good to use the next time you fire up your BROIL KING® KEG. As for the grease left on the grill - cook it off at the beginning of the next use as it will continue to season the grill grate.

The BROIL KING® KEG will give you many years of great service with minimal care. The seasoning process will help preserve the cast iron parts. If at any point you see rust forming, use a steel wire brush to clean the grate and then season it again as described earlier.

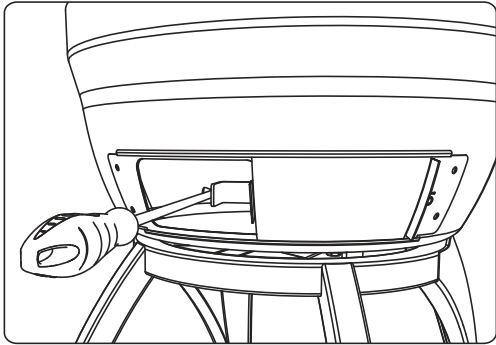

When the charcoal ashes do pile up, remove them into a metal bucket with the Multi-Tool - only perform this when the grill is cool and charcoal has been extinguished.



**Sponge and  
mild detergent**



**Dishwasher**

**Remember:** Never put any part of your BROIL KING® KEG in the dishwasher for cleaning.

For surface clean-ups, water, mild detergent and a sponge will do just fine.

\* **Always keep your BROIL KING® KEG covered with a grill cover. (KA5535)**

# Broil King® KEG

## Cooking Guide

All cooking times and temperatures are approximate.

Use a food thermometer to check internal temperature.

Food	°F
Ground Beef, Pork, Lamb	160°
Ground Turkey, Chicken	165°
Beef, Veal, Lamb	
Med. Rare	145°
Medium	160°
Well Done	170°
Chicken, Turkey, Duck	165°
Pork	160°
Ham	
Fresh (raw)	160°
Pre-Cooked	140°

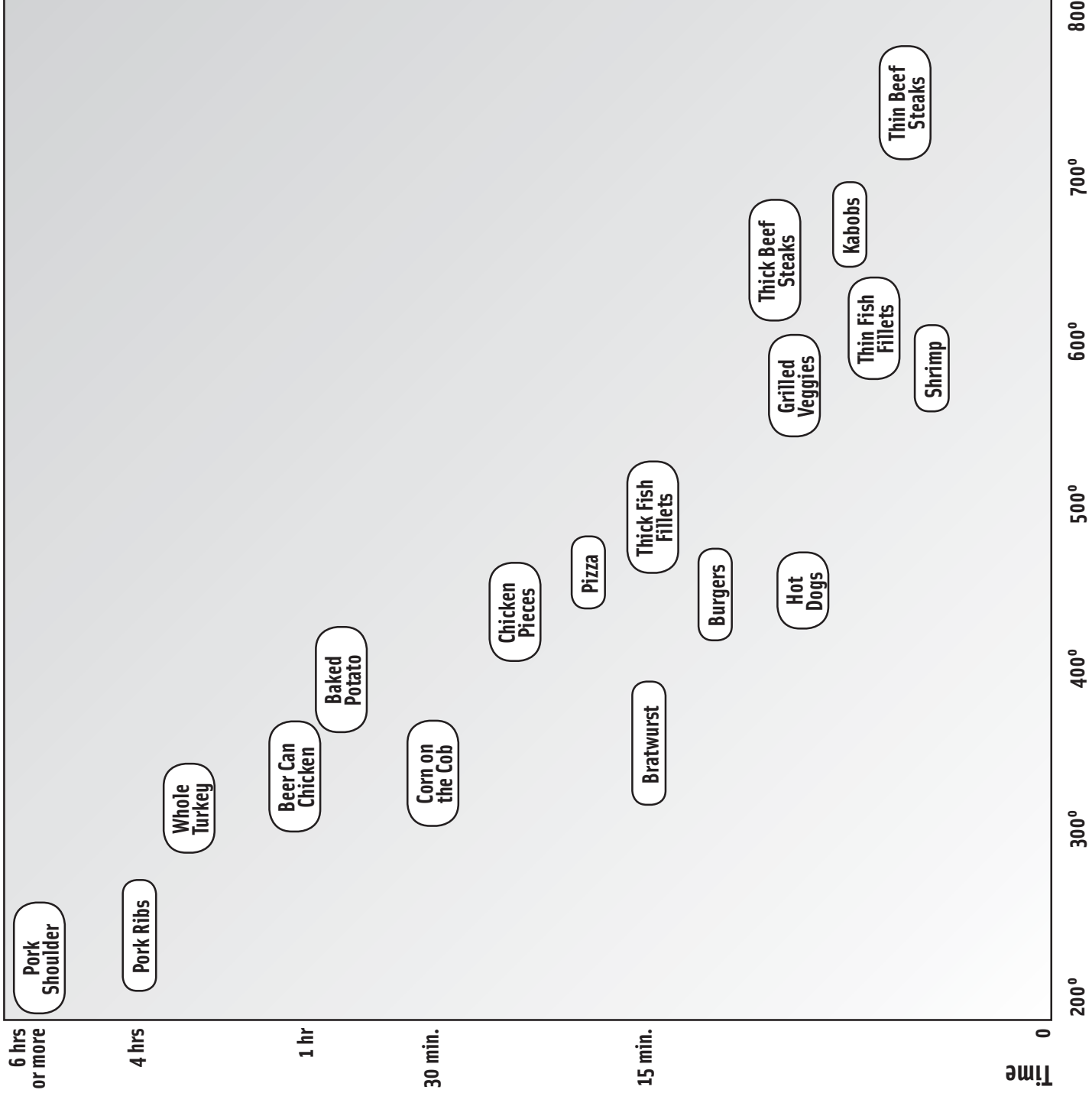



# Broil King® KEG Winning Recipes

## Low N' Slow Ribs

Your BROIL KING® KEG excels at making tender, fall-off-the-bone ribs with a minimum of fuss. Load the grill with coals and light a fire starter on top of the mound. When the fire starter is out and the topmost coals are lit, close the lid. Adjust the dampers to the #1 position when the temperature reads 250°F. Cook the ribs for four hours. Remove the ribs, baste with your favorite sauce and cook for another hour at 250°F. For extra flavor, add a handful of soaked hickory chips to your fire before starting the cook.



## Sumptuous Stuffed Peppers

Cooking veggies is fast and easy on your BROIL KING® KEG. The convection currents and double-wall insulation help to maintain a consistent temperature throughout the grill. For this reason, cooking times on both the upper and lower grates will be about the same. It will also be much faster than a traditional grill - so keep an eye on it. Stuff bell peppers with your favorite fixins - we like Italian sausage, rice and cheese. Place them



directly on the grate and bake on 350°F for 20 to 30 minutes.



## The Perfect Steak Grilling Guide

For the perfect medium rare 1" thick New York Strip, follow these simple instructions.

Marinate steak for 1 hour at room temperature or up to 24 hours in the refrigerator. If refrigerating, bring steak close to room temperature a half hour before grilling for more even cooking. Preheat grill on MEDIUM/HIGH. Brush grids with olive oil and proceed as directed.

NOTE: Bone in cuts take slightly longer. Times may be affected by wind, outdoor temperature, and thickness or temperature of meat prior to cooking.

Meat Thickness		Heat Setting	Time Per Side				Total Time
1½"	1"		A	B	C	D	
	Rare	Med/High	1¾	1¾	1¾	1¾	7 minutes
Rare	Medium/Rare	Med/High	2	2	2	2	8 minutes
	Medium	Med/High	2¼	2¼	2¼	2¼	9 minutes
Medium/Rare	Well	Med/High	2½	2½	2½	2½	10 minutes
Medium		Med/High	3	3	3	3	12 minutes

Place steak on angle on hot grids.

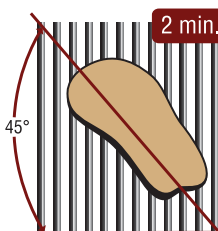

Flip the steak as shown below.



Turn and flip the steak again.

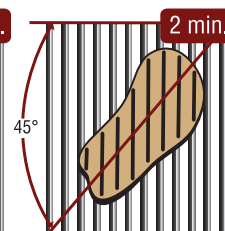

Finally, flip the steak again.

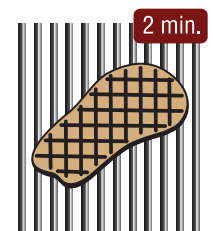

## Ultimate Beer Can Chicken

The BROIL KING® KEG is perfectly suited for roasting.

Unlike a regular grill, the insulated BROIL KING® KEG cooks evenly and maintains temperature flawlessly. Just get your fire going and adjust

the dampers down when you reach 350°F. Take a half-full can of your favorite beer and add a few cloves of garlic and your favorite barbecue rub. Rub down your bird, being sure to get plenty inside of the cavity. Stand the chicken up on the can by placing the open end into the cavity. Place the chicken standing up on the grill and roast until the internal temperature reaches 165°F. For extra flavor, add a handful of soaked pecan chips to your fire before starting the cook.

## Perfect Pizzas

Baking on the BROIL KING® KEG will take your cooking to a whole new level - making you the envy of the neighborhood. The upper grate gives you a little more distance from the fire and is perfect for baking. When making pizza, we like to use our BROIL KING® KEG 12" diameter pizza stone (MODEL# BSA5541). Place the stone on the upper grate of your BROIL KING® KEG and pre-heat to 400°F. Use fresh dough and load it up with your favorite toppings. Place your pizza on a sheet of baker's parchment paper - this will ensure results. Bake on top of the pizza stone for 10 to 15 minutes.

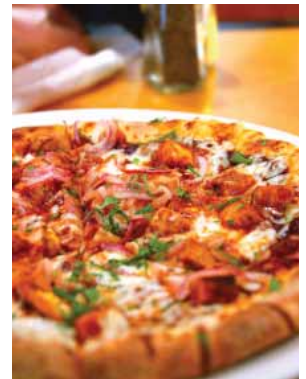

**Broil King®**  
**KEG**

**ONWARD MANUFACTURING COMPANY LTD.**

585 Kumpf Drive • Waterloo, Ontario, Canada • N2V 1K3

[info@omcbbq.com](mailto:info@omcbbq.com) • Phone: 519.885.4540 • Fax: 519.885.1390

North America Customer Service: 1.800.265.2150