

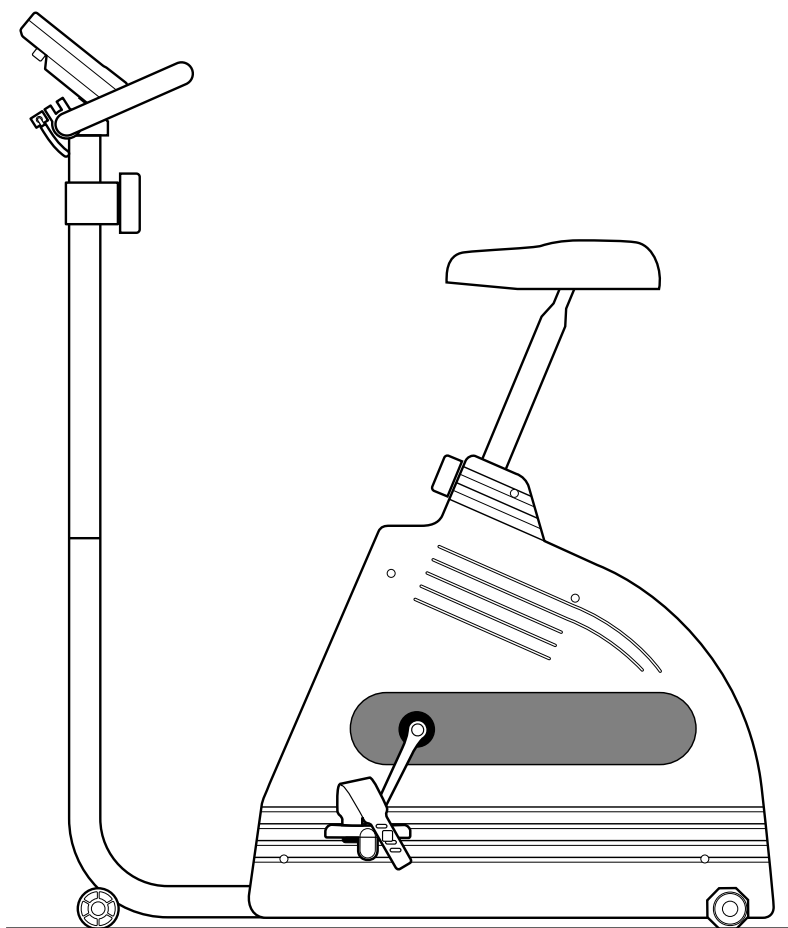

# Cateye ergociser

**MODEL EC-L3200**  
OPERATING INSTRUCTIONS



# EC-L3200 Cateye ergociser

## CONTENTS

<b>Introduction</b>	3
<b>For safety operation</b>	
<b>Anatomy of the EC-L3200</b>	2
<b>Assembly</b>	4
<b>Mounting the control unit / How to use the pulse sensor</b>	6
<b>Your first ride</b>	8
<b>Operation of buttons &amp; workload shift lever</b>	10
<b>Input your data</b>	12
<b>Start the exercise</b>	14
<b>Purpose of exercise / Exercise program / Glossary of terms</b>	16
<b>Trouble shooting / Warranty service</b>	18
<b>Specifications</b>	



### Package

(If anything is missing, contact the dealer where you purchased this unit.)

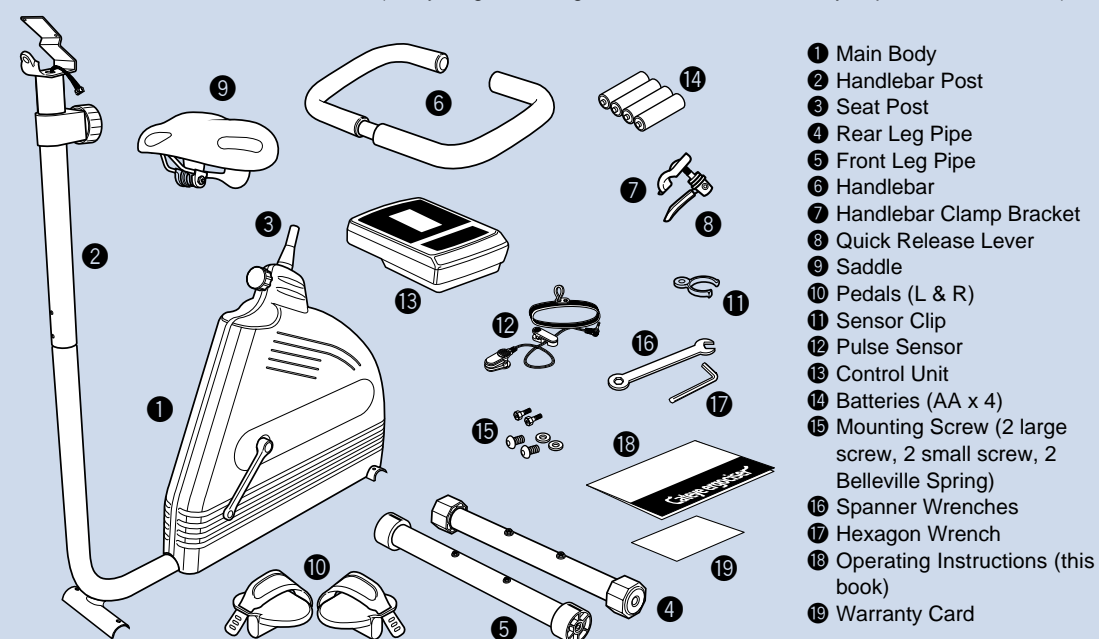



# Anatomy of The EC-L3200

Refer to this page whenever necessary while reviewing this manual.

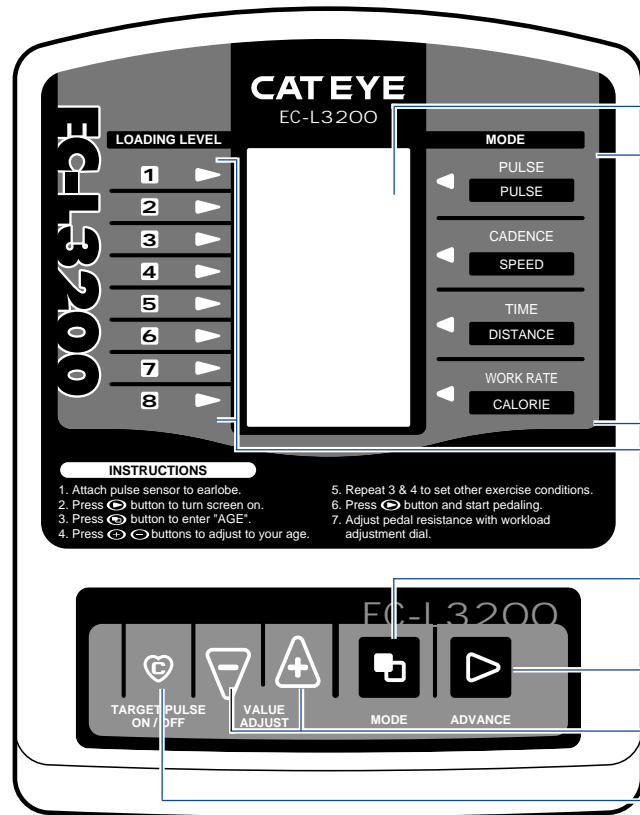

**LCD Screen**

**Data Description**

Indicates what the figure in each column stands for

**Workload Level Indicator**

Shows the position of the workload adjustment dial

**Mode Button**

**Advance Button**

**Value Adjust Button**

**Target Pulse On/Off Button**

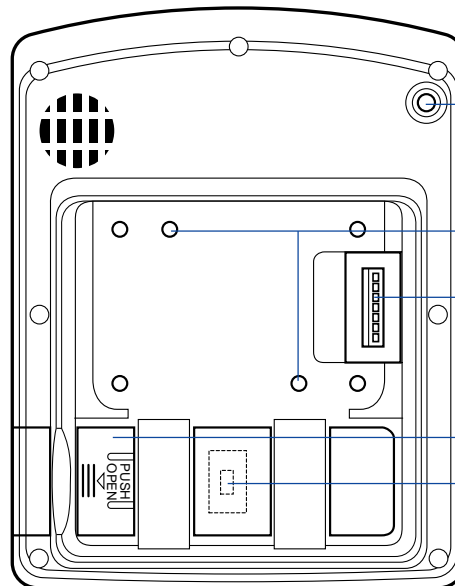

**Pulse Sensor Jack**

**Mounting Screw Hole**

**Cable Inlet**

Cable connector from the main body is connected here.

**Battery Case**

**Distance Scale Switch**

Accessible when the battery case is removed. Select either km or mile.

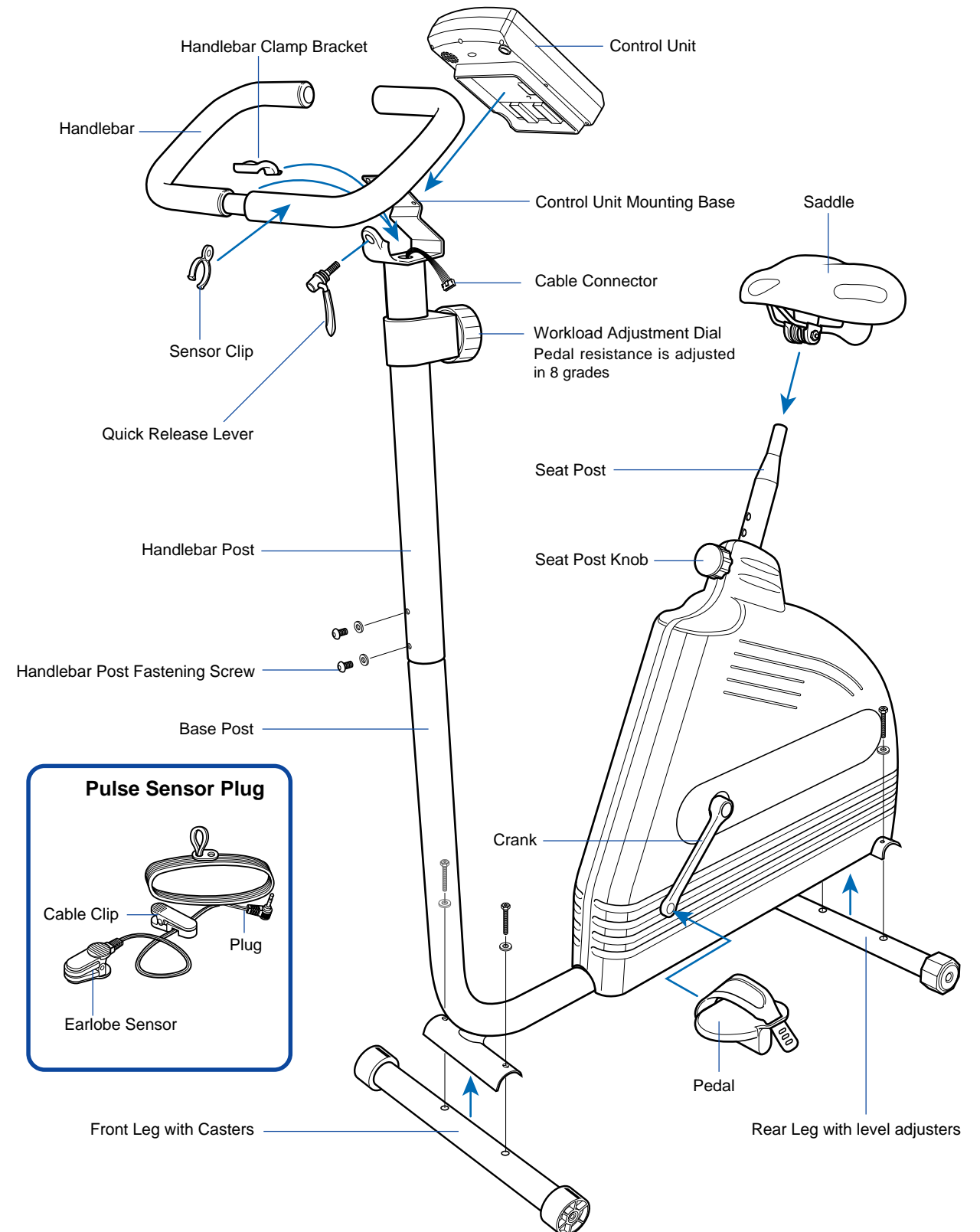

**Handlebar Clamp Bracket**

**Control Unit**

**Handlebar**

**Control Unit Mounting Base**

**Saddle**

**Cable Connector**

**Sensor Clip**

**Workload Adjustment Dial**  
Pedal resistance is adjusted in 8 grades

**Quick Release Lever**

**Seat Post**

**Handlebar Post**

**Seat Post Knob**

**Handlebar Post Fastening Screw**

**Base Post**

**Pulse Sensor Plug**

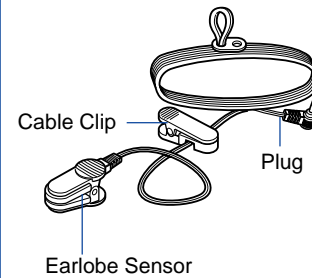

**Crank**

**Front Leg with Casters**

**Pedal**

**Rear Leg with level adjusters**

## Introduction

Thank you very much for your purchase of Cat eye Ergociser Model EC-L3200. The model EC-L3200 is a new high-tech exerciser with a built-in computer designed to allow aerobic exercise conveniently for the purpose of advancing your cardiovascular system, and maintaining and improving physical endurance.

You can do aerobic exercise effectively when your pulse rate meets constantly a target pulse rate that is decided under your age, physical strength and purpose.

Read this manual carefully to achieve maximum fitness from your EC-L3200 and keep it handy.

### Symbol marks used for safety precautions in this manual

The descriptions with the following symbol marks in this manual refer to very important matter in terms of your safety and handling of the unit. You are strictly requested to observe these precautions.

**WARNING** Should this indication be neglected and improper handling attempted by the operator, such critical risks which could result in a fatal or serious injuries are impending.

**CAUTION** Should this indication be neglected and improper handling attempted by the operator, there are possibilities of physical injuries or material damages.

**REFERENCE** This symbol mark describes advantageous items to the user or complementary items.

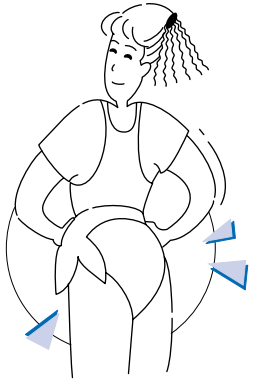

## For safety operation

Please read through this section before proceeding to operate your Cat eye Ergociser.

For your safety, you are kindly requested to observe the following:

### WARNING!!!

- Before using the EC-L3200, it is important to consult a medical specialist if you are suffering from any of the following: heart disease (angina pectoris, myocardial infraction), hypertension, diabetes, respiratory disease (asthma, chronic bronchitis, pulmonary emphysema, etc.), articular metamorphosis, rheumatism, gout, or any other disease and physical complaints.
- If you are not used to regular physical activities, it may be dangerous to suddenly start strenuous exercise. Try to increase your exercise level gradually and always avoid careless exertion.
- If you feel sick or sense something is wrong with your body during exercise, immediately stop exercising.
- In case children, sick persons, or those who are physically disabled are using this unit, be sure that they should be attended by someone else.

### CAUTION

- The pulse (earlobe) sensor should always be used with the correct age setting. This allows the upper pulse limit alarm to issue a warning when your heart rate has unusually increased.
- Be sure to remove pulse sensor cord by holding the plug instead of pulling it by holding the cord.
- Do not use this unit in areas where there are a lot of spray products or inflammable substance.
- Do not use this unit with the ventilation hole, etc. covered.
- Do not let substance fall or insert into the openings of the unit. As otherwise, it may result in failures of the unit.
- Do not disassemble the main unit or the control unit. Consult the dealer you purchased the unit from, in case of trouble.
- Avoid using or storing the unit outdoors or in areas where it is exposed to direct sunlight.
- Do not use the unit in areas where temperature and humidity are high.
- Avoid using the unit in other manners than stated in this manual.
- Do not use the unit whenever it does not operate normally, it is dropped or damaged, or when it is wet. When such events have occurred, contact our authorized dealer in your location.
- Do not wipe the unit with organic solvents such as thinner, kerosene, gasoline or alcohol. Wipe it clean with a cloth with neutral cleanser, and wipe with a dry cloth.
- Wipe off the sweat drops on the main unit and control unit, after use.
- For repairing the unit, be sure to use the genuine parts for Cateye Ergocisers only.

# 2 Assembly

Assemble the unit according to the following procedure. Learn how to adjust each part as well.

\* In addition to the tools provided, please prepare a screw driver.

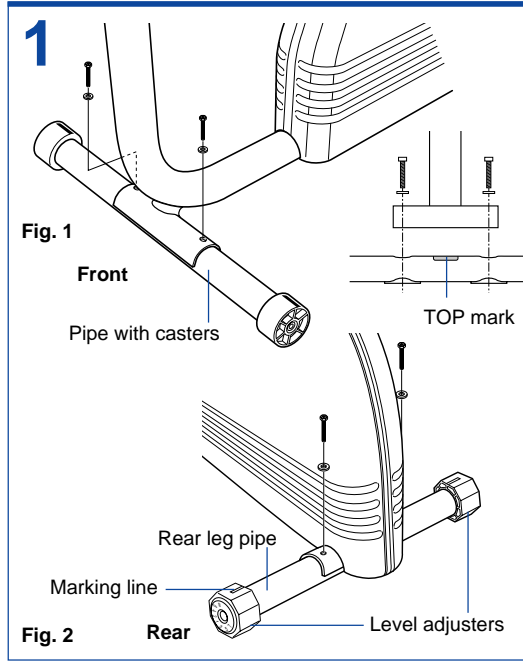

## 1. Attaching the leg pipes

- Remove the two screws from each leg pipe.
- Place the front leg pipe under the front end of the main body as Fig. 1 and fasten it with the screws securely.
- Place the rear leg pipe under the rear end of the main body as Fig. 2 and fasten it equally.

**CAUTION:** Place the leg pipes with the "TOP" mark facing upward.

**ADJUSTMENT:** Turn the level adjusters if necessary, in order to compensate the floor unevenness.

**REFERENCE:** When the marking line is at the top, the rear leg is at the same level as front.

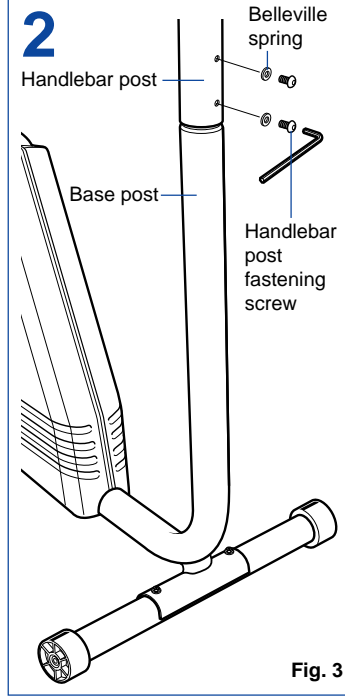

## 2. Mounting the handle post

- Attach handlebar post to base post and secure with fastening screws.

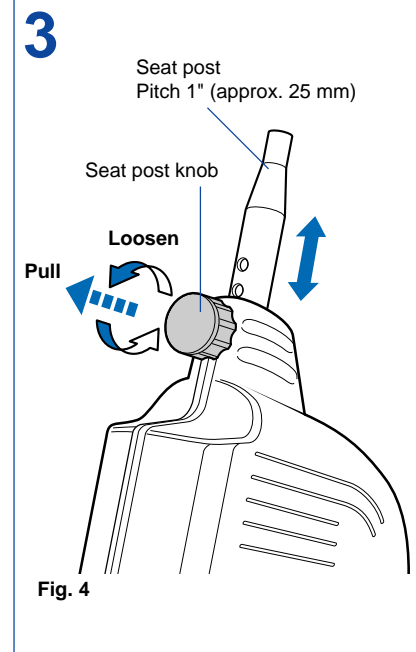

## 3. Seat post position (ADJUSTMENT)

- Turn the seat post knob clockwise and counterclockwise and pulling it allows the seat post to slide up and down.(Fig.4)
- Adjust the seat post to an appropriate height and release the seat post knob, and move the seat post slightly up or down.
- The spring inside the seat post knob drives the pin into the nearest hole on the seat post and turn it clockwise until the seat post cannot wobble.
- The pitch of the seat post hole is 1 inch (approx.25mm).

**CAUTION:** Confirm that the pin of the seat post knob must be in the hole securely.

**CAUTION:** Do not pull the seat post knob while mounted. The seat post may drop down suddenly.

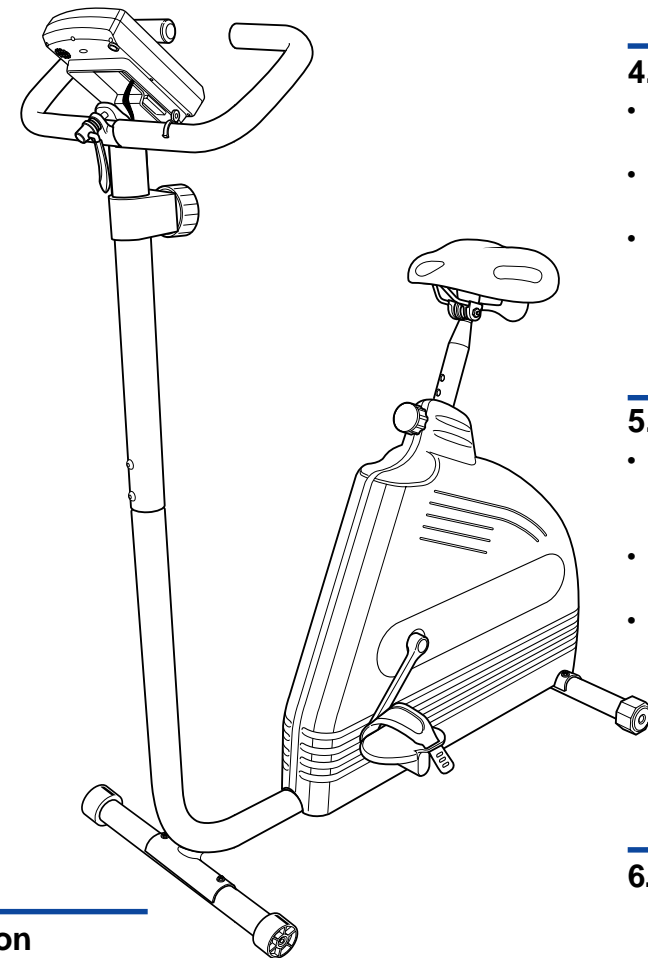

**Assembly completed.**  
(Control Unit already mounted)

## 4. Mounting the saddle

- Lift up the seat post to a proper height for saddle mounting.
- Mount the saddle at the top of the seat post as Fig. 5.
- Adjust the saddle angle to make it horizontal, and use the #13 end of the spanner wrenches to tighten the nuts from both sides.

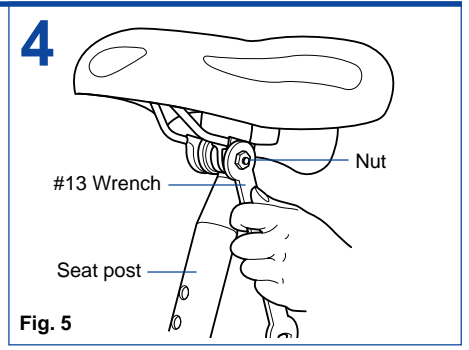

## 5. Attaching the pedals

- Attach the pedals to the crank as Fig. 6 and fasten them firmly using the #15 end of the wrench provided.
- Be sure to identify R and L of the pedal with the engraved mark.
- Fasten clockwise the R pedal, and counterclockwise the L pedal. (Fig. 7)

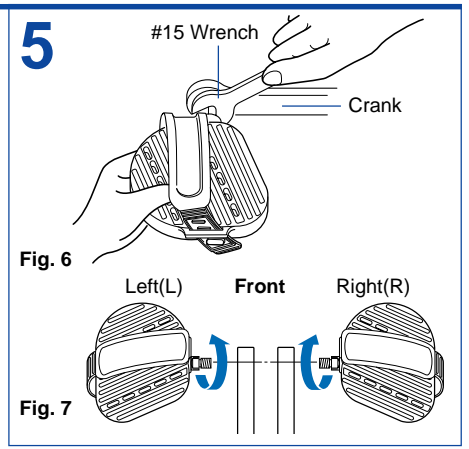

## 6. Mounting the handlebar and adjusting the handlebar grip (ADJUSTMENT)

- Place the Handlebar clamp bracket and the handle bar into place. (fig 8)
- Place both washers provided onto the Quick release and screw it into the handlebar clamp assembly until there is a loose fit. The Quick release works like a clamp, test it to determine when it is open (clamp assembly will be loose). Test for proper tightness using the lever action to close the Quick Release. If at this time the handle bar is too loose open the Quick Release lever and turn the screw portion into the Handlebar clamp bracket 1 to 2 turns. Repeat the Test process until the handle bar is held tightly into place when the lever is closed and loose enough to adjust the bar when the lever is open.

**REFERENCE:** Be sure that when you close the Quick Release lever it snaps firmly into place.

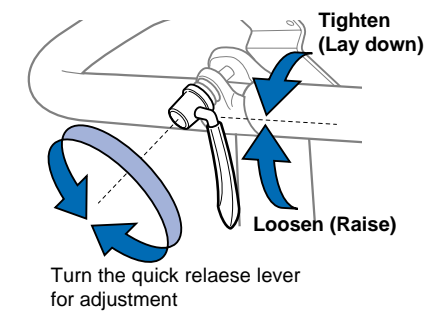
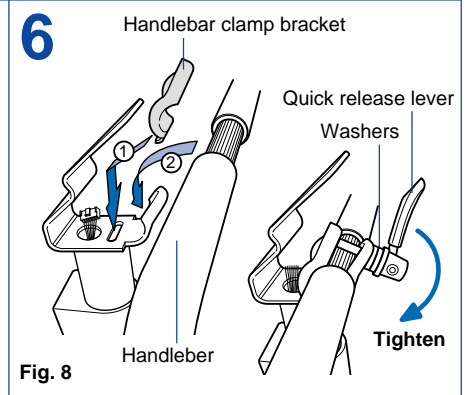



## Mounting The Control Unit How to Use The Pulse Sensor

Complete the following procedure before riding

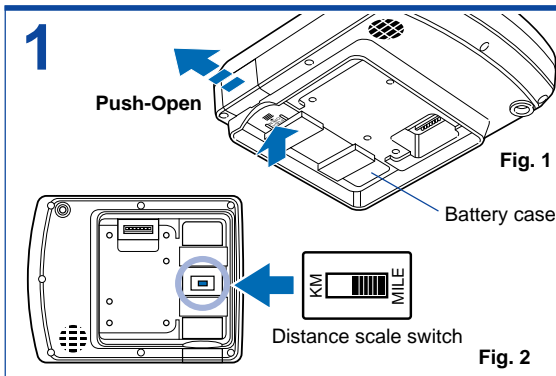

### 1. Setting the distance scale

- Remove the battery case from the control unit (Fig. 1)
- Set the distance scale switch to "km" or "mile" at your choice. (Fig. 2)

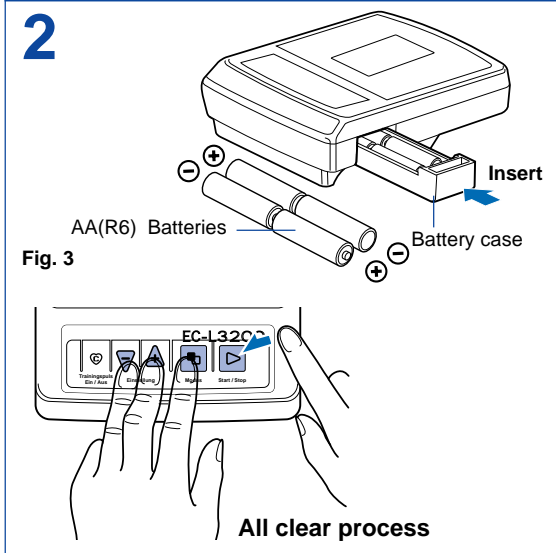

### 2. Loading (replacing) the batteries

- Put the batteries provided [AA(R6) x 4] in the battery case, making sure that the polarity is correct (Fig. 3) and insert the battery case into the control unit.
- Execute the "All Clear" process as shown below.

#### How to do "All Clear"

- Press the three buttons (+), (-), and (⏻) simultaneously, and holding them down press the (▶) button.
- All the LCD segments appear at a time, then the screen turns blank. (Refer to page 10)

#### Replacing the batteries

- When the batteries wear out, mark appears on the screen. If it appears replace the batteries soonest possible.
- Alkaline batteries are recommended because of longer life.

**CAUTION:** Be sure to execute the "All Clear" upon replacing the batteries, too.

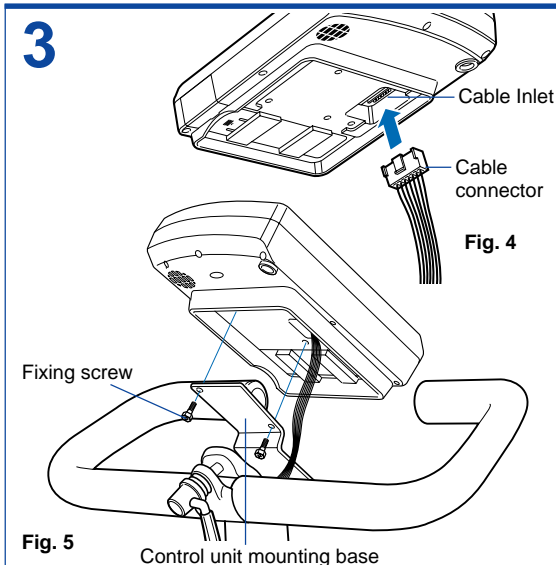

### 3. Mounting the control unit

- Insert the cable connector of the 7P cable coming out of the main body, securely into the cable inlet at the back of the control unit. (Fig.4).
- Place the control unit on the mounting the base as Fig.5, and fasten the 2 screws securely.

### 4. Adjustment

- Adjust the position of each part in such a way that your riding posture will be as illustrated. (Fig. 6)
- The saddle height should be at the level where your knee is slightly bent when the pedal is at the lowest position. (Refer to Item 3 of Page 4 on how to adjust)
- Using the quick release lever, determine the handlebar angle where you can keep a natural posture. (Item 6 of Page 5)
- When moving the unit, lift up the rear of the unit holding the rear end of the saddle, and roll forward on the casters of the front leg.

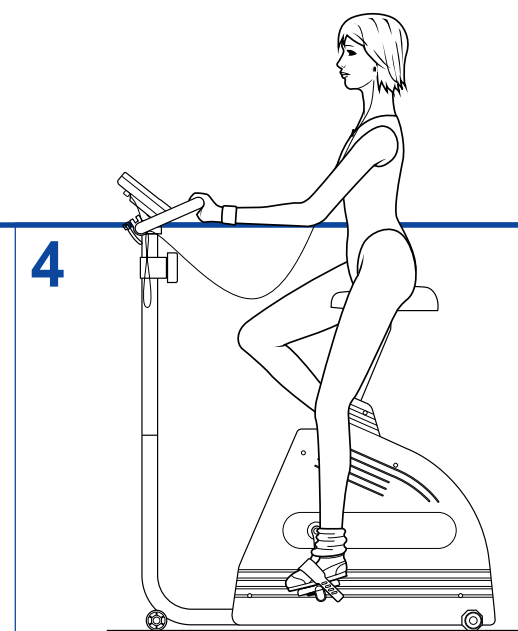
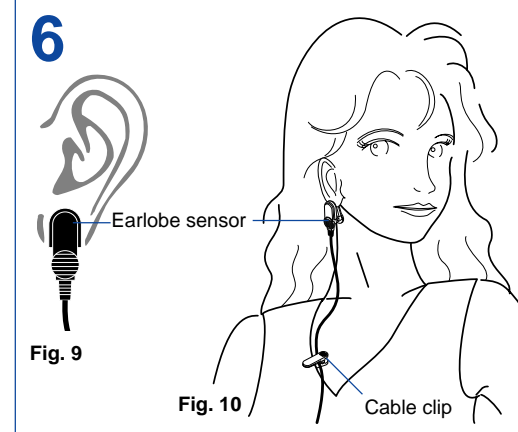
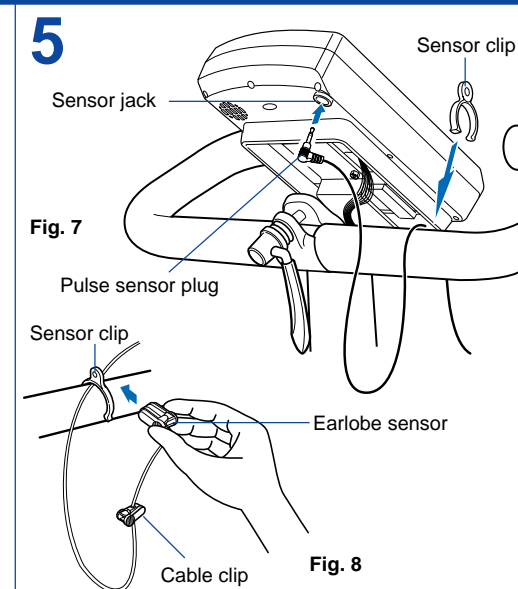

Fig. 6 Recommended exercise posture

### 5. Attaching the pulse sensor

- Insert the pulse sensor plug into the sensor jack at the back of the control unit. (Fig. 7)
- Use the sensor clip to take up slack in the cable, to keep the cable from swinging too much during exercise. (Fig. 7)
- Keep the pulse (earlobe) sensor attached on the sensor clip when not in use. (Fig. 8)



### 6. How to use the pulse (earlobe) sensor

- Clip the pulse sensor at the center of your earlobe of either side. (Fig. 9) Ear rings or other ornaments must be removed while using the pulse sensor.
- Attach the cable clip to the collar of your clothes during the exercise, to prevent excessive swinging of the sensor cable. (Fig. 10)

#### Cautions on handling the pulse sensor

- When it is cold, massage your earlobe before use, to improve blood circulation.
- Try not to change the position of the pulse sensor during the exercise.
- If the symbol frequently lights up during the use, remove the earlobe sensor once and reattach.
- The sensor cable can be broken if pulled strongly. Treat it with sufficient care.





When the pulse rate display seems to be incorrect, check the pulse sensor as described below.

- \* Remove the pulse sensor from your earlobe and close it with nothing in between, while the screen is in working state.
  - mark lights up and pulse rate is displayed as 0 --- **Normal**
  - mark lights up intermittently when you swing the cable --- **The cable is half broken**
  - mark doesn't light up --- **The cable is broken**
  - mark lights up even when the pulse sensor is attached to your earlobe or some object --- **The cable is short-circuited.**

# 4

## Your First Ride

Try a ride so that you can familiarize yourself with the unit.

- Attach Pulse Sensor
- Press  Button
- Confirm Initial Display
- Press  Button Begin Exercise
- Press  Button Confirm In-Exercise Display(A) and (B)
- Turn the workload adjustment dial. Confirm the Pedal Resistance changes.
- Finish Exercise when Buzzer beeps. Press  Button

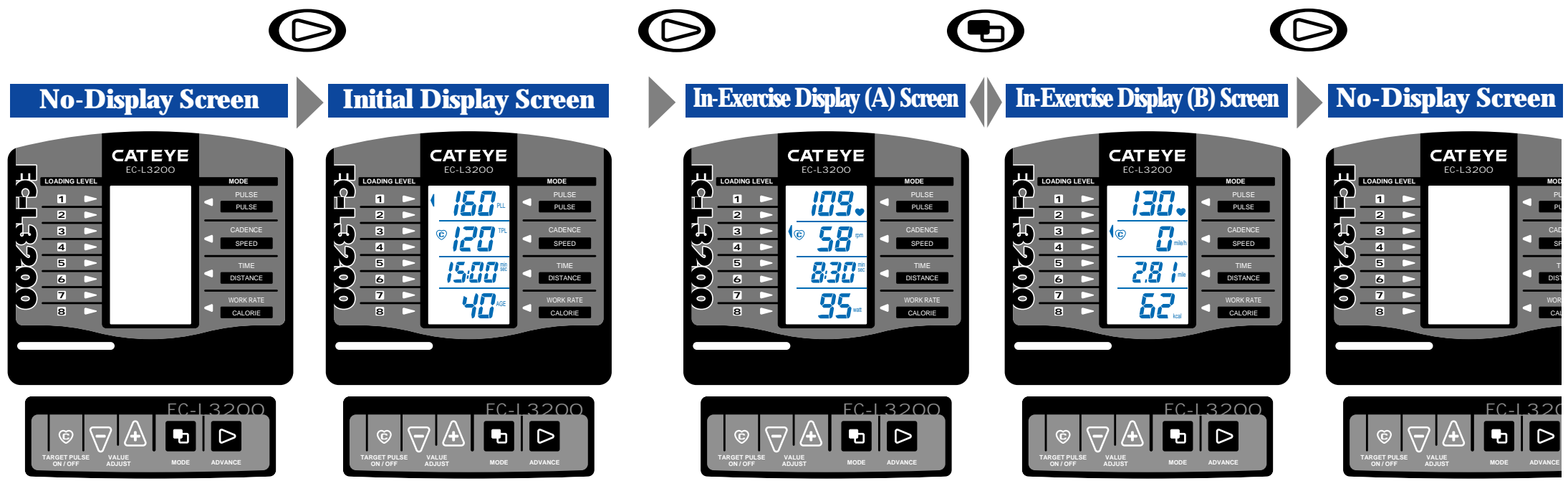

When power is off, no display appears on the screen. In this state, the battery consumes minimal power. When the unit is not in use, turn off to "No-Display" state.

- If input signal is not entered into the control unit in 10 minutes, the unit is automatically turned off to "No-Display" state.

In the "No-Display" state, this "Initial Display" appears with a press of the Advance button .

- Preset Initial Display** (from top)
- Upper-Limit Pulse Rate**  
160 bpm (beats per minute)
  - Target Pulse Rate**  
120 bpm (beats per minute)
  - Target Exercise Time**  
15 minutes
  - Age**  
40 years old

The above display can be modified to your personal data, but at this stage leave them as they are.

After the "Initial Display" state, this "In-Exercise Display (A)" appears with a press of the advance button .

- Exercise Display (A) Screen** (from top)
- Current Pulse Rate**  
(bpm)
  - Pedal Cadence**  
(rpm-revolutions per minute)
  - Countdown Timer**  
(minute:second)
  - Work Rate**  
(watt)
- Change pedal resistance by moving the workload adjustment dial to the left for easier and to the right for harder.

If you press the advance button  when the screen is in this state, it turns to the "No-Display" state.

The In-Exercise Display (A) and (B) alternately appear with each press of the mode button .

- In-Exercise Display (B) Screen** (from top)
- Current pulse Rate**  
(bpm)
  - Simulated Current Speed**  
(mile/h or km/h)
  - Simulated Trip Distance**  
(mile or km)
  - Calorie Consumption**  
(kcal)

If you press the Advance button  when the screen is in this state, it turns to the "No-Display" state.

When the target time has elapsed, the buzzer will beep to notify the target has been achieved. After the target time has been achieved, the timer will start counting up.

Slow down your pace gradually, and finish your exercise. Review your workout data shown on the screen, and press the Advance button . The screen will go off and the power will be disconnected.

**REFERENCE:** If you wish to continue your exercise after hearing the beep to notify you the achievement of the target time, you can continue the exercise. The calorie consumption will be continuously logged.

Now, we believe you have understood what you can expect from the exercise of Cateye Ergociser EC-L3200.



# Operation of Buttons & Workload Adjustment Dial

To make the most of the functions of the unit.

## 1. Functions of the buttons

### Advance Button

It makes the program proceed. Each time you press this button, the display advances in the order as Fig. 1.

### Mode Button

It is used in two ways.

- a) In the "Initial Display", each press of this button switches the item to be modified in the order as Fig. 2.
- b) In the "In-Exercise Display", each press of this button converts the screen alternately as Fig. 3.

### Value Adjust Buttons

In the "Initial Display", each button serves to change the blinking numerical value in each selected mode.

- Button ----- Each press increases the numerical value by 1, and when held down, it increases rapidly.
- Button ----- Each press decreases the numerical value by 1, and when held down it decreases rapidly.

### Target Pulse On/Off Button

The mark turns on and off each time you press this button.

When the mark is shown, the buzzer beeps if your pulse rate deviates from the target pulse rate zone. When the mark is off, such a function is not activated.

[Beeping Sound Pattern]	0	1	2 (sec.)
Beyond the target pulse rate zone			2kHz
Below the target pulse rate zone			1kHz

- The buzzer function is not activated until your pulse rate once reaches the target pulse rate.
- The target pulse rate zone may slightly differ depending on the target pulse rate that you input, but approximately within +/- 5 bpm from the target pulse rate.

## Special functions of buttons

### "All Clear" Function

When new batteries are loaded, or when abnormal signal is received due to electrostatic trouble, etc., the screen may show abnormal displays. In such a case, first hold down the set buttons and the mode button simultaneously, then press the advance button . The screen first turns to "No-Display" state, then it displays all the readings for 2 seconds. Finally it returns to the "No-Display" state.

### Recovery Function

If you press the advance button by mistake during exercise, making the screen turn to "No-Display" state, press any of the other buttons, except the advance button , within 10 seconds. The screen recalls the previous "In-Exercise Display" state.

### Memory Function

In the "No-Display", if you hold down the mode button and press the advance button , the data that was set for your last exercise can be recalled. This function is useful when you can use the unit exclusively and want to repeat the same exercise program.

\*This function becomes effective 10 seconds after the unit is turned off.

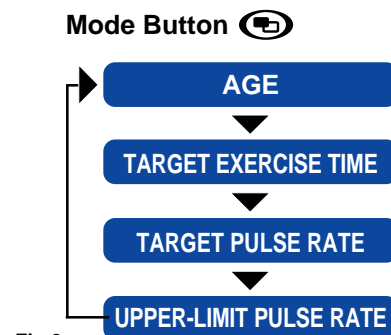
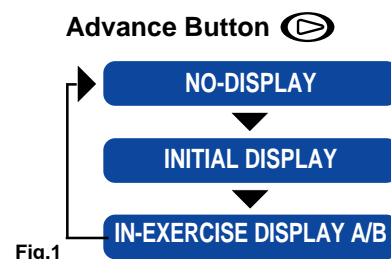

Fig.3

### All-clear Process

- Press the three buttons simultaneously, and holding them down press the button.
- Be sure to perform this procedure after replacing the batteries.

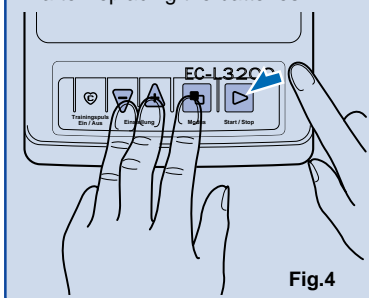

Fig.4

Before starting exercise, set the workload adjustment dial to the following standard level in accordance with your age and sex.

Age	Male	Female
20~30's	3	2
40~50's	2	1
Over 60	1	1

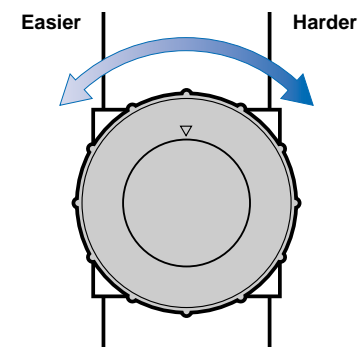

Fig.5

## 2. Workload Adjustment Dial and Work rate

- Work rate (watt) is determined by the position of the workload adjustment dial, and your pedal cadence. (Fig.5)
- To get the desired work rate during the exercise, first adjust it roughly by the workload adjustment dial, then precisely by changing your pedal cadence. The workload can be shifted to 8 positions, 1 is the easiest and 8 is the heaviest. (Fig.4) Turning the workload adjustment dial leftward make the workload easier and turning it the rightward make the workload heavier. Each position of the workload adjustment dial is identified by the mark displayed on the screen. The following table shows work rate (watt) corresponding to each workload adjustment dial position, and the pedal cadence.

Work Rate (watt)						
Pedal Cadence Shifting Position	50	60	70	80	100	120
1	25	33	41	50	65	85
2	50	65	85	105	140	195
3	75	100	130	155	215	265
4	100	135	170	210	285	355
5	125	165	215	260	350	440
6	150	200	255	310	420	520
7	175	235	295	355	480	595
8	200	265	335	405	545	680

REFERENCE: At the middle position of each workload level on the workload adjustment dial, it shows the exact work rate as per above figure.

CAUTION: Do not overtighten workload adjustment dial.

### Screen Display

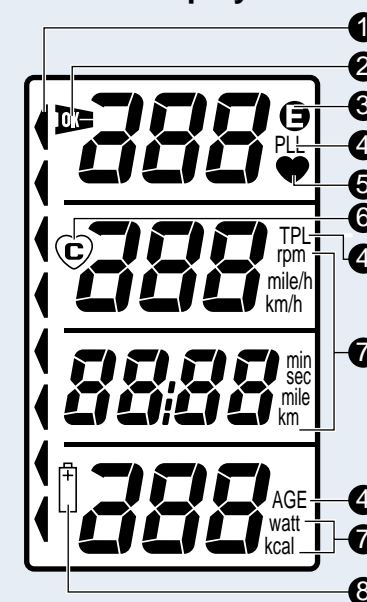

Fig.6

- ① **Workload Level Indicator**  
Indicates the position of the workload adjustment dial.
- ② **Pulse Sensor "OK" Mark**  
Indicates that the pulse sensor functions properly.
- ③ **"Error" Mark**  
Appears when the pulse rate jumps up or down abnormally, or when the pulse sensor is not attached to your earlobe properly.
- ④ **Data Mark**  
Indicates the mode in display.  
PLL ----- Upper-Limit Pulse Rate  
TPL ----- Target Pulse Rate  
AGE ----- Age of the user
- ⑤ **Pulse Mark**  
Flickers synchronized with the pulse
- ⑥ **Target Pulse Rate On/Off Mark**  
When this mark is on, the buzzer functions to signal when your pulse rate is out of the target pulse rate zone.
- ⑦ **Unit Mark**  
Indicates the unit of the display figure.
- ⑧ **Battery Alarm Mark**  
Indicates that the battery power has exhausted.

# 6

## Input Your Data

The target pulse rate calculated from your age is the key of effective exercise.

### Adjusting Saddle Height

Adjust the saddle height to get correct exercise posture.

### Adjusting Handlebar Angle

Adjust handlebar angle to get correct exercise posture.



### Attaching Pulse Sensor

Attach the pulse sensor to your earlobe correctly.



### Press Advance Button

Press the advance button  to turn on the Initial Display.



### Input Your Age

Use  and  buttons to input your age.

### Input Target Exercise Time

Use  and  buttons to input exercise time.

### Input Target Pulse Rate

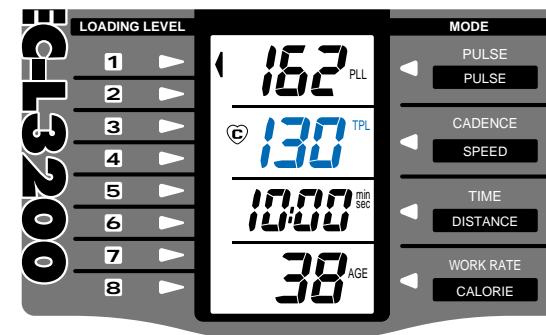
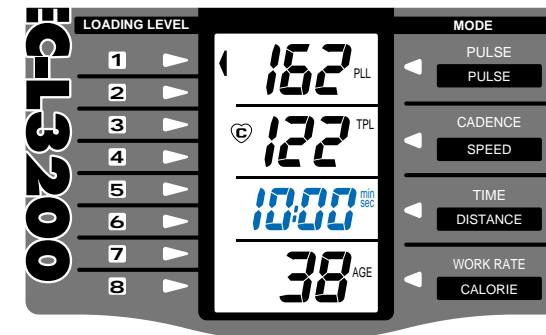
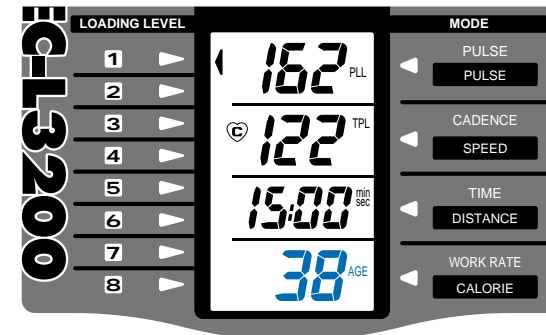
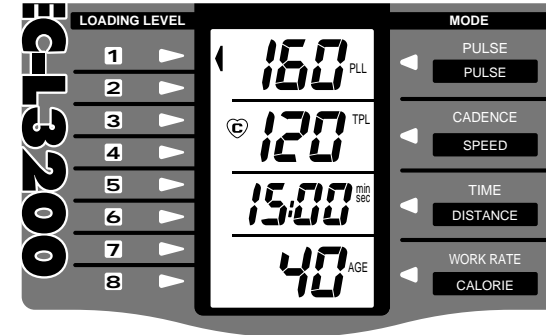

Use  and  buttons to input target pulse rate.





### 1. Press Advance Button

- 1) After setting the correct saddle height and handlebar angle, ride on the saddle and attach the pulse sensor to your earlobe.
- 2) Press the Advance button  to turn on the "Initial Display". You can modify the "Age", "Exercise Time" and "Target Pulse Rate" from this display, as described below.



### 2. Input Your Age

- 1) Press the mode button , and the numerical value "40" at the bottom flickers, which is the preset standard age.
  - 2) Input your age, using the  or  button.
- \* Each time the age is modified, the upper-limit pulse rate (PLL) and the target pulse rate are automatically set, based on "200 - age" and "160 - age" respectively.

### 3. Input Target Exercise Time



- 1) Press the mode button , to make the numerical value "15:00" in the third column flicker, which is the preset standard exercise time.
- 2) Input the desired exercise time, using the  or  button.  
Setting range: 0 ~ 99 minutes, in 1 minute increment

### 4. Input Target Pulse Rate

- 1) Press the mode button , to make the numerical value "120" in the second column flicker, which is the preset standard target pulse rate.
- 2) Input the desired target pulse rate, using the  or  button.  
Setting range: 80 ~ (Upper Pulse Limit - 10) bpm

#### For a person who has built up enough physical strength:

The target pulse rate cannot be set higher than (Upper Pulse Limit - 10). If you wish to set a higher target pulse rate, first modify the Upper Pulse Limit upward. The maximum settable Upper Pulse Limit is 199, so you can set the target pulse rate to 189 bpm at maximum.

- How to modify the upper-limit pulse rate
- 1) Press the mode button  until the upper-limit pulse rate (value in the top column) flickers.
  - 2) Input the desired upper-limit pulse rate using the  or  button.
- In general, modification of the upper-limit pulse rate is not always recommended because the target pulse rate automatically set at [180 - age] is adequate for effective exercise.



# 7 Start The Exercise

Continuing exercise with the EC-L3200 will make you fit.

## Adjust the workload level

Set the workload adjustment dial at an appropriate position, in accordance with your age and sex.

## Press Advance Button (Start to Exercise)

Upon pressing the advance button , start pedaling.



## Press Mode Button, Review (A) & (B) Screens

You can read various data using the mode button .

## Finish Exercise when Buzzer Beeps

When the target exercise time is over, the buzzer signals the end. (The timer starts to count-up after this point.)

## Review Your Data

Press the mode button  to review the data, and record them.  
Press the advance button  to turn off the screen to No-Display state.

### WARNING !!!

If the buzzer beeps continuously to signal that your pulse rate has exceeded the upper-limit pulse rate, stop exercising immediately.

Beeping sound pattern	0	1	2(sec.)
When the upper-limit pulse rate is exceeded	[Solid blue bar]		
Beyond the target pulse rate zone	[Blue square]	[Blue square]	[Blue square]
Below the target pulse rate zone	[Blue square]	[Blue square]	[Blue square]
When the target exercise time has elapsed	[Solid blue bar]		



Buttons to use and display progress

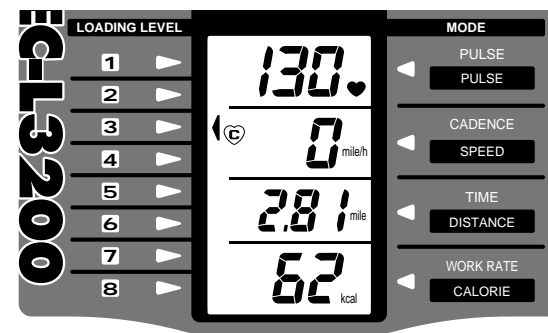
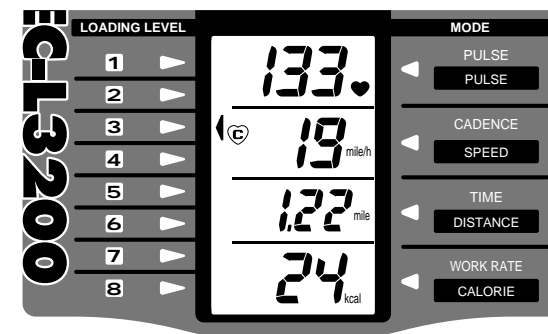
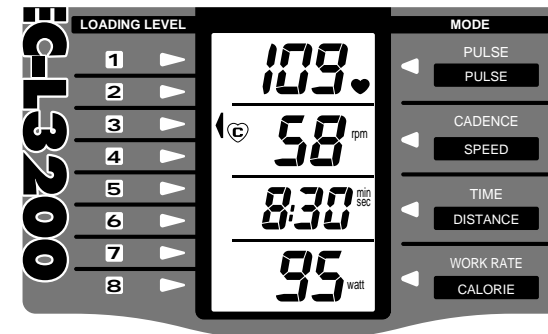
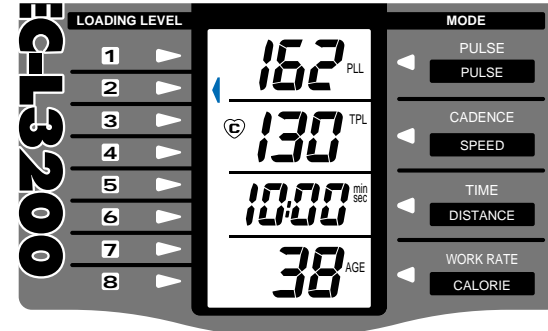

## 5. Adjust Workload Level

Set the workload adjustment dial at an appropriate position, in accordance with your age and sex.

Age	Male	Female
20~30's	3	2
40~50's	2	1
Over 60	1	1



## 6. Start to Exercise

- 1) After setting the data, press the advance button  and start pedaling. The timer starts to countdown, so the remaining time is shown.
  - 2) Keep pedaling in the range of 50~70 rpm, increasing the workload level by one point per minute, so that your pulse rate comes close to the target pulse rate smoothly.
  - 3) After your pulse rate once reaches the target pulse rate, the buzzer will beep if your pulse rate is out of the target pulse rate zone. In such a case, adjust your pedal cadence upward or downward by about 5 rpm so that your pulse rate can stay within the target pulse rate zone.
- \* In case you cannot get back to the target pulse rate zone by only changing the pedal cadence, adjust the workload adjustment dial to change the workload level upward or downward.

## 7. Alternate Display

With each press of the mode button  during exercise, the In-Exercise Display (A) and (B) alternate. (Refer to page 9) You can read different data while you exercise.

## 8. Finish Exercise

- 1) When the buzzer beeps to signal the end of the target exercise time, finish exercise. Recall the In-Exercise (B) screen, by pressing the mode button .
  - 2) Review the consumed calories (kcal) and the simulated trip distance (mile or km).
- \* You may continue exercise even after the buzzer beeps to signal the end, if you have not reached to your target of consumed calories. The timer starts counting up after this point.
- 3) Press the advance button  to turn off the screen to the "No-Display" state.

# 8

## Purpose of Exercise / Exercise Program Glossary of Terms

To maximize the benefit of your exercise.

### 1. Purpose of Exercise

Do you often get out of your breath when you go up stairs or walk fast? This is because your ability to take oxygen into your body is getting weak. Such ability is evaluated by a value called MOU (Maximum Oxygen Uptake), which represents the maximum amount of oxygen taken into your body per 1 kg of body-weight in a minute (ml/kg.min.). The MOU value can be used as a scale of your physical endurance.

The average MOU value is 40-50 ml/kg.min. for men in their twenties, and 30-40 ml/kg.min. for women of the same age. In general, the MOU value becomes less as you get older, and the more you lack proper exercise, the faster it decreases. It is said the MOU value less than 22 ml/kg.min. may result in illness of cardiovascular system, and in restriction of your daily life.

Continued aerobic exercise several times per week maintains and improves your MOU value, activating oxygen supply to your cardiovascular system. With the EC-L3200, you can perform aerobic exercise effectively and efficiently.

### 2. Exercise Program

Aerobic exercise will be more effective when it is continued at a certain pulse rate, which is determined based on your age and physical strength. This is called "Target Pulse Rate".

#### How to decide your target pulse rate

When you input your age, the EC-L3200 automatically sets your target pulse rate at [160 – age]. This target pulse rate corresponds to 50-60 % of the exercise level for the twenties, 40-50 % for the sixties. (Refer to "Exercise Level" on page 17.) The older you are, at the less intense level your target pulse rate is set because of such programming of the EC-L3200. The exercise level automatically set by this unit could be too hard even for a young person, if he is a beginner. If you feel it too hard, you may decrease the target pulse rate by 10 bpm from the original level. If you feel too easy, you may increase it by 10 bpm so that you can continue exercise in the appropriate target zone as illustrated. If you can continue your exercise at the target pulse rate of [180 – age], your exercise can be considered as effective enough. Upgrade your exercise gradually so that you can reach the suggested final target of [190 – age].

#### Exercise Time for Each Session

A minimum of 30 minutes exercise is necessary for each session of exercise. A 5 minute warm up period, and 20 minutes of exercise time, with a 5 minute cool down period, is suggested as a standard exercise. For weight reducing exercise, over 30 minutes exercise time at the low level of the target pulse rate is recommended with a 5 minute cool down.

#### How many days a week for exercise

Minimum two exercise days a week is required just to maintain your present fitness level. With 3-4 exercise days you can expect improvement. Always consult with your doctor before proceeding with any exercise program.

#### Caution:

Concentrated and repeated exercise in a day may produce an adverse result.

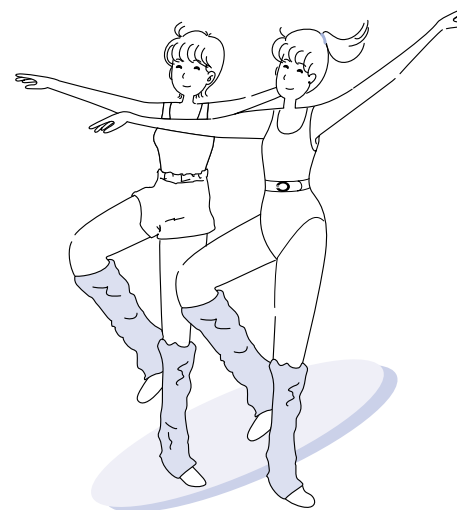
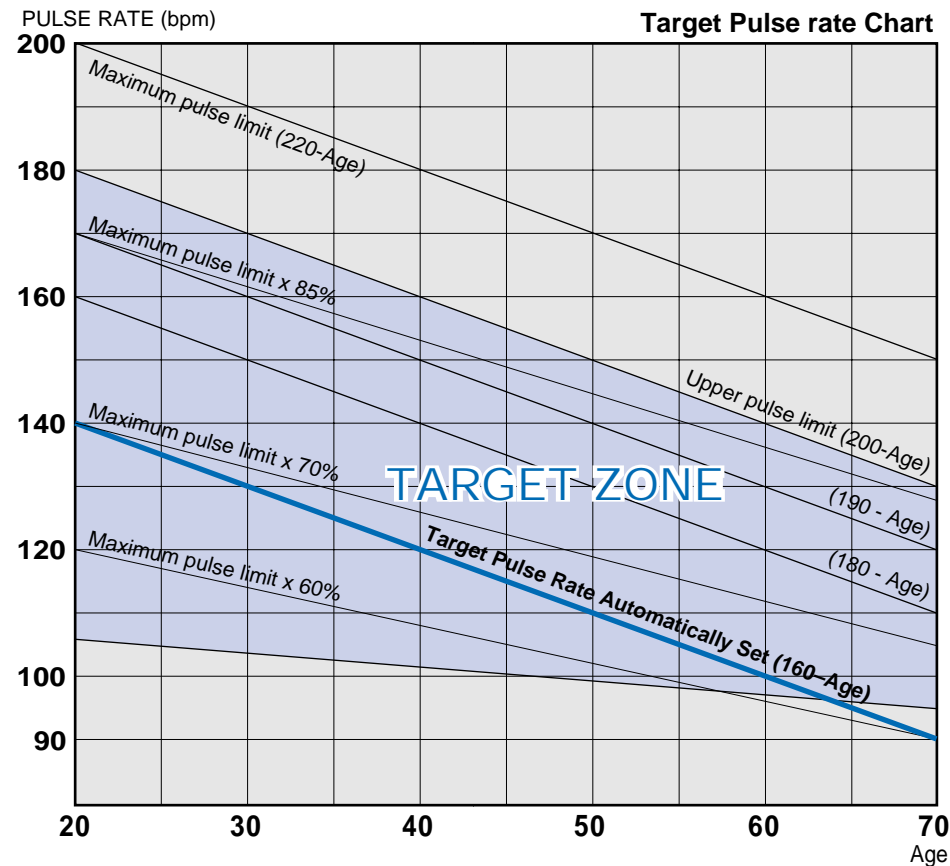

### 3. Glossary of Terms

#### Maximum Heart Rate

When you exercise, your heart rate continues to increase as the exercise level becomes more intense, but there is a certain limit. This limit is called the maximum heart rate. The maximum heart rate decreases as you become older. The decrement ratio in the maximum heart rate differs individually, depending on whether one is physically well trained or not. In general, the maximum heart rate decreases yearly by 0.6-1.0 beats per minute.

The heart rate is the number of heart beats per minute measured by a cardiograph. However, we can measure the pulse by touching the arteries near the skin, such as carotid arteries; which is called the pulse rate.

At the earlobe, blood flow fluctuates with each beat of the heart, and the optical permeability through the earlobe changes every time the heart beats. The EC-L3200 measures the pulse rate with the sensor, amplifying the changes of optical permeability. An earlobe is a suitable part for sensing the pulse rate during the physical exercise since its muscular movement during exercise is very little and doesn't affect the pulse rate detection.

The heart rate and the pulse rate differ from each other in principle and method, but their value per minute is equal, and therefore both can be interpreted as synonymous.

#### Upper-Limit Pulse Rate (PLL)

The maximum pulse rate is related with the age, and is calculated by standard formulas such as [220 – age] or [204 – 0.69 x age]. In the EC-L3200, it is calculated as [200 – age] and called the upper-limit pulse rate (PLL), which is lower than the standard formula of the maximum pulse rate and gives you a safer upper-limit pulse rate. When your pulse rate exceeds the preset upper-limit pulse rate, a buzzer beeps to warn you. You can adjust the upper-limit pulse rate according to your physical condition.

#### Target Pulse Rate (TPL)

A pulse rate to be maintained during the exercise is called the target pulse rate (TPL). When your pulse rate is more than 5 bpm over or under the target pulse rate which you set before the exercise, a buzzer beeps to signal you.

#### Exercise Level

Since the pulse rate gets higher according to the intensity of exercise, the exercise level can be indicated by how high your pulse rate is compared with your pulse rate at rest. It is shown by percentage as follows:

$$\text{Exercise Level (\%)} = \frac{\text{Pulse Rate in exercise} - \text{Pulse Rate at rest}}{\text{Maximum Heart Rate} - \text{Pulse Rate at rest}} \times 100$$

Therefore, the target pulse rate for a certain exercise level can be obtained through the following formula:

$$\text{Target Pulse rate} = (\text{Maximum Heart Rate} - \text{Pulse Rate at rest}) \times \frac{\text{Exercise Level (\%)}}{100} + \text{Pulse Rate at rest}$$



# Trouble Shooting / Warranty Service Specifications

## Trouble Shooting

Trouble	Check Item	Suggested Remedy
No display appears or abnormal display appears on the LCD panel.	Press the advance button (⏩) and check if the display appears or not. Proceed "All-clear Process", and press the advance button (⏩) and check if the display appears or not. [Page 10 (Fig. 4)]	If still no display appears, the batteries are dead. Replace all four batteries. [Page 10]
Buzzer beeps continuously.	Check if your upper-limit pulse rate (PLL) has been set correctly. [Page 13-2]	Input your age correctly. The upper-limit pulse rate is set at [200 – age].
"Distance Scale Unit" display is wrong.	Check if the distance scale unit was set correctly according to instructions. [Page 5-7]	Follow instructions on page 6-1 to set the desired distance unit.
The pulse rate reading is not displayed.	Check if the sensor plug is inserted properly. [Page 7-5] Check if the pulse sensor is correctly attached to your earlobe. [Page 7-6] Check if the plug or the cable of the pulse sensor is damaged. [Page 7]	Insert the sensor plug properly, and attach the pulse sensor correctly.  In case of damage on the pulse sensor, replace it with a new one.
The target pulse rate alarm does not beep.	Has your pulse rate once reached the target pulse rate? [Page 10]  Is the Target Pulse On/Off mark (Ⓞ) lit on the screen? [Page 10]	The target pulse rate alarm is activated only after your pulse rate reaches the target.  Press the Target Pulse On/Off button (Ⓞ) to turn on the (Ⓞ) mark.

## Warranty Service

- Cat Eye Co., Ltd. guarantees that the Cateye Ergociser™ Model EC-L3200 is free from material defects and malfunctions under correct and normal use for a period specified in the separate Warranty Card. In case there should be defects or malfunctions, Cat Eye will repair or replace the unit or parts, according to the terms and conditions mentioned in the Warranty Card.
- If repair service is required, contact your dealer where the unit was purchased.
- The warranty covers only the main unit and the control unit. Accessories such as the pulse sensor are not covered.

ITEM	SPECIFICATIONS		
Load	Eddy current system utilizing permanent magnet		
Load Range	Manual Adjustment	1 ~ 8 level	
	Cadence	50 ~ 120 rpm	
	Load Range	25 ~ 680 watts	
Acceleration	2-step belt drive		
Control System	4-bit micro-computer		
Display Function	Function	Range	Accuracy
	Pulse Rate	50 ~ 220 bpm	± 1 bpm (stable state)
	Cadence	20 ~ 240 rpm	± 1 rpm
	Exercise Time	00 min. 00 sec. ~ 99 min. 59 sec.	± 0.003 %
	Work Rate	0 ~ 999 watts	± 5 watts (at 50 watts)
	Speed	0 ~ 99 miles/h (km/h)	Simulated value
	Distance	0.00 ~ 99.99 miles (km)	Simulated value
	Calorie	0 ~ 999 kcal	Estimated value
Alarm Function	Target Pulse Rate Alarm		
	Signals if the pulse rate deviates from target pulse rate zone		
	Upper-limit Pulse Rate Alarm		
	Signals when pulse rate exceeds preset upper-limit pulse rate		
	Exercise Time Alarm		
Signals when preset target exercise time is reached			
Power Supply	AA (R6) x 4 (Battery life: Approx. 200 hours by alkaline battery)		
User's Weight Limit	286 lbs (130 kg)		
Measurement	Handlebar Height:	39-7/32 ~ 52-7/16 inches (996 ~ 1332 mm)	
	Saddle Height:	33-9/32 ~ 46-31/32 inches (845 ~ 1193 mm)	
	Length:	42-11/32 inches (1075 mm)	
	Width:	19-11/16 inches (500 mm)	
Weight	Net Weight:	55.5 lbs. approx. (27 kgs)	

\* Specifications and design are subject to change without notice.  
U.S. Pat. 4929825 / Design Pat. Pending



## **CATEYE** CO., LTD.

---

2-8-25, Kuwazu, Higashi Sumiyoshi-ku, OSAKA, 546-0041 JAPAN

PHONE: 81-6-6719-7781

FAX: 81-6-6719-2362