



Baseline Switch 2250 Plus

User Guide

Installationsanleitung

3C16476CS

<http://www.3com.com/>

Part No. 10015237 Rev. AA
Published August 2006



3Com Corporation • 350 Campus Drive • Marlborough • MA USA 01752-3064

Copyright © 2006, 3Com Corporation. All rights reserved. No part of this documentation may be reproduced in any form or by any means or used to make any derivative work (such as translation, transformation, or adaptation) without written permission from 3Com Corporation.

3Com Corporation reserves the right to revise this documentation and to make changes in content from time to time without obligation on the part of 3Com Corporation to provide notification of such revision or change.

3Com Corporation provides this documentation without warranty, term, or condition of any kind, either implied or expressed, including, but not limited to, the implied warranties, terms or conditions of merchantability, satisfactory quality, and fitness for a particular purpose. 3Com may make improvements or changes in the product(s) and/or the program(s) described in this documentation at any time.

If there is any software on removable media described in this documentation, it is furnished under a license agreement included with the product as a separate document, in the hard copy documentation, or on the removable media in a directory file named LICENSE.TXT or !LICENSE.TXT. If you are unable to locate a copy, please contact 3Com and a copy will be provided to you.

UNITED STATES GOVERNMENT LEGEND

If you are a United States government agency, then this documentation and the software described herein are provided to you subject to the following:

All technical data and computer software are commercial in nature and developed solely at private expense. Software is delivered as "Commercial Computer Software" as defined in DFARS 252.227-7014 (June 1995) or as a "commercial item" as defined in FAR 2.101(a) and as such is provided with only such rights as are provided in 3Com's standard commercial license for the Software. Technical data is provided with limited rights only as provided in DFAR 252.227-7015 (Nov 1995) or FAR 52.227-14 (June 1987), whichever is applicable. You agree not to remove or deface any portion of any legend provided on any licensed program or documentation contained in, or delivered to you in conjunction with, this User Guide.

Unless otherwise indicated, 3Com registered trademarks are registered in the United States and may or may not be registered in other countries.

3Com and the 3Com logo are registered trademarks of 3Com Corporation.

Microsoft, MS-DOS, Windows, and Windows NT are registered trademarks of Microsoft Corporation.

IEEE and 802 are registered trademarks of the Institute of Electrical and Electronics Engineers, Inc.

Netscape Navigator is a registered trademark of Netscape Communications.

JavaScript is a trademark of Sun Microsystems.

All other company and product names may be trademarks of the respective companies with which they are associated.

ENVIRONMENTAL STATEMENT

It is the policy of 3Com Corporation to be environmentally-friendly in all operations. To uphold our policy, we are committed to:

Establishing environmental performance standards that comply with national legislation and regulations.

Conserving energy, materials and natural resources in all operations.

Reducing the waste generated by all operations. Ensuring that all waste conforms to recognized environmental standards. Maximizing the recyclable and reusable content of all products.

Ensuring that all products can be recycled, reused and disposed of safely.

Ensuring that all products are labelled according to recognized environmental standards.

Improving our environmental record on a continual basis.

End of Life Statement

3Com processes allow for the recovery, reclamation and safe disposal of all end-of-life electronic components.

Regulated Materials Statement

3Com products do not contain any hazardous or ozone-depleting material.

Environmental Statement about the Documentation

The documentation for this product is printed on paper that comes from sustainable, managed forests; it is fully biodegradable and recyclable, and is completely chlorine-free. The varnish is environmentally-friendly, and the inks are vegetable-based with a low heavy-metal content.

CONTENTS

ABOUT THIS GUIDE

- Conventions 5
- Related Documentation 6
- Documentation Comments 6

1 INTRODUCING THE BASELINE SWITCH

- Overview of the Baseline Switch 2250 Plus 7
- Features and Capabilities 7
 - Autosensing of MDI/MDIX Connections 7
 - Autonegotiating 10/100 Mbps Ports 7
 - SFP Ports 8
 - Traffic Prioritization 8
 - Forwarding of BPDU Packets 8
- Physical Features 9
 - Front Panel 9
 - Rear Panel 12
- Package Contents 12

2 INSTALLING THE SWITCH

- Before You Begin 13
- Positioning the Switch 13
- Aufstellen des Switch 14
- Rack-Mounting or Free-Standing 14
 - Using the Mounting Kit 14
 - Montagesatz Anweisungen 15
 - Placing Units On Top of Each Other 16

- Supplying Power to the Switch 16
 - Checking for Correct Operation 16
- Connecting a Network Device 17
- Using SFP Transceivers 18
 - Approved SFP Transceivers 18
 - Inserting an SFP Transceiver 18
 - Removing an SFP Transceiver 19
- Performing Spot Checks 19

3 CONNECTING TO THE WEB INTERFACE

- Requirements for Accessing the Web Interface 21
- Running the Discovery Application 21
- Logging On to the Web Interface 23
- Navigating the Web Interface 23
 - Menu 23
 - Buttons 25
- Accessing the Interface Without Using Discovery 26
 - DHCP Assigned IP Address 26
 - Manually Assigned (Static) IP Address 26

4 CONFIGURING THE SWITCH

- Configuration Overview 27
- Device Summary Information 27
- Administration Settings 29
 - Modifying the IP Address Settings 29
 - Automatic IP Configuration 29
 - IP Setup 30

Backup Configuration	30
Restore Configuration	30
Firmware Upgrade	31
Initialize	31
Reboot	32
System Access	32
System Time	34
SNMP	34
Configuring VLANs	35
VLAN	36
Forwarding Tagged/Untagged Frames	39
Sample VLAN Configurations	40
Spanning Tree	41
IGMP Snooping	42
IGMP Query	42
Broadcast Storm	43
Configuring Port Settings	43
Administration	43
Speed/Duplex for 1000 Mbps Connections	45
Link Aggregation	45
Spanning Tree per Port	47
Port Mirroring	49
QoS VoIP Traffic Settings	50
Security	53
RADIUS Client	53
802.1X Settings	54
Monitoring	56
Address Table	56
Cable Diagnostics	56

5 TROUBLESHOOTING

Resetting to Factory Defaults	59
Forgotten Password	59

Forgotten Static IP Address	60
Solving LED Issues	60
If the Problem Persists	61

A OBTAINING SUPPORT FOR YOUR PRODUCT

Register Your Product	63
Purchase Value-Added Services	63
Troubleshoot Online	63
Access Software Downloads	63
Telephone Technical Support and Repair	64
Contact Us	64

B SAFETY INFORMATION

Important Safety Information	67
------------------------------	----

C TECHNICAL INFORMATION

Related Standards	69
Environmental	69
Physical	69
Electrical	69

GLOSSARY

INDEX

REGULATORY NOTICES

ABOUT THIS GUIDE

This guide describes how to install your Switch and perform initial management configurations.

This guide is intended for use by network administrators who are responsible for installing and setting up network equipment. Consequently, it assumes a basic working knowledge of LANs (local area networks).

Diese Anleitung ist für die Benutzung durch Netzwerkadministratoren vorgesehen, die für die Installation und das Einstellen von Netzwerkkomponenten verantwortlich sind; sie setzt Erfahrung bei.



If release notes are shipped with your product and the information there differs from the information in this guide, follow the instructions in the release notes.

Most user guides and release notes are available in Adobe Acrobat Reader Portable Document Format (PDF) on the 3Com World Wide Web site:

<http://www.3com.com>

Conventions

[Table 1](#) and [Table 2](#) list conventions that are used throughout this guide.

Table 1 Notice Icons

Icon	Notice Type	Description
	Information note	Information that describes important features or instructions
	Caution	Information that alerts you to potential loss of data or potential damage to an application, system, or device
	Warning	Information that alerts you to potential personal injury

Table 2 Text Conventions

Convention	Description
Screen displays	This typeface represents information as it appears on the screen.
The words "enter" and "type"	When you see the word "enter" in this guide, you must type something, and then press Return or Enter. Do not press Return or Enter when an instruction simply says "type."
Words in <i>italics</i>	Italics are used to: <ul style="list-style-type: none">■ Emphasize a point.■ Denote a new term at the place where it is defined in the text.■ Identify menu names, menu commands, and software button names. Examples: From the <i>Help</i> menu, select <i>Contents</i>. Click <i>OK</i>.

Related Documentation

In addition to this guide, each 3Com Baseline Switch 2250 Plus documentation set includes the following:

- Online Help – Accessible from the Web interface, provides information that helps you perform tasks using the Web interface.
- Release Notes – Provide information about the current software release, including new features, modifications, and known problems.

Documentation Comments

Your suggestions are very important to us. They will help make our documentation more useful to you. Please e-mail comments about this document to 3Com at:

`pddtechpubs_comments@3com.com`

Please include the following information when contacting us:

- Document title
- Document part number (on the title page)
- Page number (if appropriate)

Example:

- 3Com Baseline Switch 2250 Plus User Guide
- Part number: 10015237
- Page 25



Please note that we can only respond to comments and questions about 3Com product documentation at this e-mail address. Questions related to technical support or sales should be directed in the first instance to your network supplier.

1 INTRODUCING THE BASELINE SWITCH

This chapter provides an overview of the features and capabilities of the 3Com® Baseline Switch 2250 Plus. It also identifies the contents of the Switch package and helps you get to know the physical features of the device.

Overview of the Baseline Switch 2250 Plus

The 3Com® Baseline Switch 2250 Plus is a versatile, easy-to-use unmanaged switch. It is ideal for users who want the high-speed performance of 10/100 switching with the added functionality of Gigabit links but do not need sophisticated management capabilities.

The Switch is shipped ready for use. No configuration is necessary, unless you want to configure advanced features such as VLAN support and link aggregation.

Features and Capabilities

The Switch has 48 shielded RJ-45, 10/100 Mbps auto-negotiating ports and two 10/100/1000BASE-T ports that operate in conjunction with two Small Form Factor Pluggable (SFP) transceiver slots on the front panel. Use these SFP transceiver slots for easy, flexible connection to fiber-based Gigabit media.

While there are four physical Gigabit ports, only a maximum of two can be operational at any given time.

Autosensing of MDI/MDIX Connections

All ports on the Switch can autosense both medium dependent interface (MDI) and medium dependent interface crossover (MDIX) connections. This allows you to connect network devices to each port using either a normal straight-through TP (twisted pair) cable or a 'crossover' TP cable.

Any port can therefore be used to connect to another switch port, server, or workstation without additional configuration.

Autonegotiating 10/100 Mbps Ports

Each 10/100 Mbps port automatically determines the speed and duplex mode of the connected equipment and provides a suitable switched connection. The 1000BASE-T ports also support automatic 10/100/1000 Mbps speed detection.

The 10/100 Mbps connections on these 1000BASE-T ports can operate in either half-duplex or full-duplex mode. 1000 Mbps connections, on the other hand, only operate in full duplex mode.

SFP Ports

The two SFP ports support fiber Gigabit Ethernet short-wave (SX) and long-wave (LX) SFP transceivers in any combination. This offers you the flexibility of using SFP transceivers to provide connectivity between the Switch and a 1000 Mbps core network.

When an SFP port is in operation, the corresponding 10/100/1000BASE-T port is disabled.

Traffic Prioritization

The Switch offers priority queuing, which means all packets that are received are examined to see if they have been priority encoded. If a packet has been priority encoded, then the Switch will read the priority level and determine whether the packet should be directed through the normal or high priority channel. This feature is useful during excessive loads when one type of traffic may require priority over another. The Switch is configured to comply with 802.1p, VLAN tagged frames.

Traffic prioritization ensures that high priority data is forwarded through the Switch without being delayed by lower priority data. It differentiates traffic into classes and prioritizes those classes automatically. Traffic prioritization uses the multiple traffic queues that are present in the hardware of the Switch to ensure that high priority traffic is forwarded on a different queue from lower priority traffic, and is given preference over that traffic. This ensures that time-sensitive traffic gets the highest level of service. The 802.1D standard specifies eight distinct levels of priority (0 to 7), each of which relates to a particular

type of traffic. The priority levels and their traffic types are shown in the following table.

Table 3 Priority Levels for Traffic Types

Priority Level	Traffic Type
0	Best effort
1	Background
2	Standard (spare)
3	Excellent effort (business critical)
4	Controlled load (streaming multimedia)
5	Video (interactive media), less than 100 milliseconds latency and jitter
6	Voice (interactive voice), less than 10 milliseconds latency and jitter.
7	Network control reserved traffic

Forwarding of BPDU Packets

Within an extended local area network that implements a spanning tree protocol topology, switches communicate with each other using bridge protocol data unit (BPDU) packets.

If your network is implementing a spanning tree topology across multiples switches, you can configure 3Com Baseline Switch 2250 Plus to forward or to block and discard bridge protocol data unit (BPDU) packets to another switch. Switches that support the spanning tree protocol communicate with each other using BPDU packets.

The spanning tree protocol (STP) is a mechanism that prevents looping and broadcast storms. A spanning tree uses the spanning tree algorithm to detect

available communication paths between switches and to determine the best available path and block less optimal paths.

For information on configuring BPDU forwarding and blocking, refer to [“Spanning Tree”](#) on [page 41](#).

Physical Features

[Figure 1](#) shows the front and rear panels of the Switch. The numbers in this diagram refer to numbered sections in [“Front Panel”](#) on [page 9](#) and [“Rear Panel”](#) on [page 12](#).

Figure 1 Front and Rear Panels

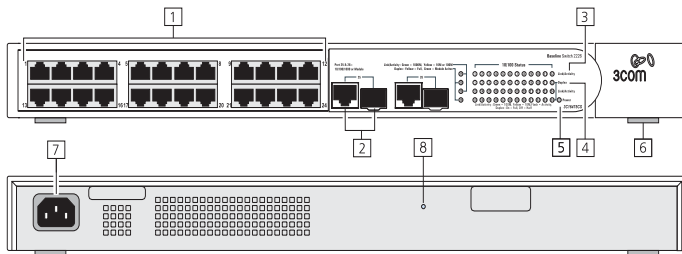

Front Panel

The front panel of the Switch contains a series of indicator lights (LEDs) that help describe the state of various networking and connection operations.

(1) 48 RJ-45 Ports



WARNING: RJ-45 Ports. These are shielded RJ-45 data sockets. They cannot be used as standard traditional telephone sockets, or to connect the unit

to a traditional PBX or public telephone network. Only connect RJ-45 data connectors, network telephony systems, or network telephones to these sockets.

Either shielded or unshielded data cables with shielded or unshielded jacks can be connected to these data sockets.



AVERTISSEMENT: Points d'accès RJ-45. Ceux-ci sont protégés par des prises de données. Ils ne peuvent pas être utilisés comme prises de téléphone conventionnelles standard, ni pour la connection de l'unité à un réseau téléphonique central privé ou public. Raccorder seulement connecteurs de données RJ-45, systèmes de réseaux de téléphonie ou téléphones de réseaux à ces prises.

Il est possible de raccorder des câbles protégés ou non protégés avec des jacks protégés ou non protégés à ces prises de données.



WARNHINWEIS: RJ-45-Porte. Diese Porte sind geschützte Datensteckdosen. Sie dürfen weder wie normale traditionelle Telefonsteckdosen noch für die Verbindung der Einheit mit einem traditionellem privatem oder öffentlichem Telefonnetzwerk gebraucht werden. Nur RJ-45-Datenanschlüsse, Telefonnetzsysteme or Netztelefone an diese Steckdosen anschließen.

Entweder geschützte oder ungeschützte Buchsen dürfen an diese Datensteckdosen angeschlossen werden.

The Switch has 48 10/100 Mbps autonegotiating ports (ports 1 to 48). Their speed and duplex mode

(half-duplex or full-duplex) are automatically determined by the capabilities of the connected device.

Each port also supports automatic MDI/MDI-X detection and can be connected to either a 10BASE-T, or a 100BASE-TX device.



CAUTION: *The Switch supports full-duplex autonegotiation. If the connected device does not support autonegotiation, the Switch will operate in half-duplex mode (even if the attached device is operating in full-duplex mode).*

In such a configuration, you may notice some degradation of network performance. 3Com recommends that you use devices that are capable of autonegotiation (and that you ensure that autonegotiation is enabled, if it is a configurable option). (see [“Troubleshooting”](#) on [page 59](#)).

(2) 10/100/1000BASE-T/SFP Ports

Ports 49 and 50 are combination Gigabit RJ-45 ports with shared Small Form Factor Pluggable (SFP) transceiver slots. If an SFP transceiver (purchased separately) is installed in a slot and is active, the associated RJ-45 port of the same number is disabled.

The 1000BASE-T RJ-45 ports support automatic MDI/MDI-X operation, so you can use straight-through or crossover cables for all network connections to workstations or servers, or to other switches or hubs.

The two SFP ports support fiber Gigabit Ethernet short-wave (SX) and long-wave (LX) SFP transceivers in any combination. This offers you the flexibility of using SFP transceivers to provide connectivity between the Switch and remote 1000 Mbps workgroups or to create a high-capacity aggregated link backbone connection.



SFP ports are numbered 49 and 50 on the Switch. When an SFP port is active, it has priority over the 10/100/1000 port of the same number. The corresponding 10/100/1000 port is disabled when an SFP transceiver is plugged in.

(3) Link/Activity LEDs

The following tables describe the LEDs visible on the front of the Switch, and how to read their status according to color.

Table 4 10BASE-T/100BASE-TX Ports

Status	Meaning
Green	Link established, operating at 100 Mbps
Yellow	Link established, operating at 10 Mbps
Flashing Green	Packets are being received or transmitted on the port at 100 Mbps

Status	Meaning
Flashing Yellow	Packets are being received or transmitted on the port at 10 Mbps
Off	<p>Link not established, either nothing is connected to the port, or there is a problem.</p> <ul style="list-style-type: none"> ■ Verify that the attached device is powered on ■ Verify that the cable or fiber is the correct type and is not faulty ■ For fiber connections, ensure that the receive (RX) and transmit (TX) cable connectors are not swapped <p>If these checks do not identify the cause of the problem, it may be that the unit or the device connected to the port is faulty. Contact your 3Com network supplier for further advice.</p>

Table 5 10BASE-T/100BASE-TX/1000BASE-T Ports

Status	Meaning
Green	Link established, operating at 1000 Mbps
Yellow	Link established, operating at 10 or 100 Mbps
Flashing Green	Packets are being received or transmitted on the port at 1000 Mbps
Flashing Yellow	Packets are being received or transmitted on the port at 10 or 100 Mbps

Status	Meaning
Flashing Yellow to Green	Port disabled or link loopback error
Off	<p>Link not established, either nothing is connected to the port, or there is a problem.</p> <ul style="list-style-type: none"> ■ Verify that the attached device is powered on ■ Verify that the cable or fiber is the correct type and is not faulty ■ For fiber connections, ensure that the receive (RX) and transmit (TX) cable connectors are not swapped <p>If these checks do not identify the cause of the problem, it may be that the unit or the device connected to the port is faulty. Contact your 3Com network supplier for further advice.</p>

(4) Module Active LEDs

The Module Active LEDs show the status of any SFP modules that are installed.

Table 6 Module Active LEDs

Status	Meaning
Green	Fiber SFP is inserted in the slot
Off	No fiber SFP is inserted in the slot

(5) Power LED

The Power LED shows the power status of the Switch.

Table 7 Power LED

Status	Meaning
Green	The unit is powered on and ready for use
Flashing Green	Power-on self-test is in progress
Yellow	Power-on self-test or loopback test failed. If this occurs, reset the Switch to factory defaults. Refer to “Resetting to Factory Defaults”
Off	The unit is not receiving power: <ul style="list-style-type: none"> ■ Verify that the power cord is connected correctly ■ If the unit still does not operate, contact your 3Com network supplier

(6) Self-Adhesive Pads

The unit is supplied with four self-adhesive rubber pads.



Do not apply the pads if you intend to rack-mount the unit.

If the unit is to be part of a free-standing stack, apply the pads to each marked corner area on the underside of the unit. Place the unit on top of the lower unit, ensuring that the pads locate with the recesses of the lower unit.

Rear Panel

(7) Power Supply

The Switch automatically adjusts to the supply voltage. Only use the power cord that is supplied with the unit.

(8) Recovery Button

Use the Recovery button on the rear panel to reset the Switch to its factory defaults. For more information, refer to [“Resetting to Factory Defaults”](#) on [page 59](#).

Package Contents

The 3Com Baseline Switch 2250 Plus package includes the following items:

- One 3Com Baseline Switch 2250 Plus unit
- One power cord
- Four standard height, self-adhesive rubber pads
- One mounting kit
- One CD-ROM, which contains this *User Guide* and the 3Com Discovery application
- One warranty flyer

Before installing and using the Switch, verify that your Switch package has all these items. If any of the above items are damaged or missing, contact your 3Com network supplier immediately.

2 INSTALLING THE SWITCH

This chapter contains information that you need to install and set up the Switch. It covers the following topics:

- [Positioning the Switch](#)
- [Rack-Mounting or Free-Standing](#)
- [Supplying Power to the Switch](#)
- [Connecting a Network Device](#)
- [Connecting a Network Device](#)
- [Performing Spot Checks](#)

Before You Begin



WARNING: Safety Information. Before installing or removing any components from the Switch or carrying out any maintenance procedures, read the safety information provided in [Appendix B](#) of this guide.



AVERTISSEMENT: Consignes de sécurité. Avant d'installer ou d'enlever tout composant du Switch ou d'entamer une procédure de maintenance, lisez les informations relatives à la sécurité qui se trouvent dans [Appendix B](#) (l'Appendice B) de ce guide.



WARNHINWEIS: Sicherheitsinformationen. Bevor Sie Komponenten aus dem Switch entfernen oder dem Switch hinzufuegen oder Instandhaltungsarbe-

iten verrichten, lesen Sie die Sicherheitsanweisungen, die in [Appendix B](#) (Anhang B) in diesem Handbuch aufgefuehrt sind.

Positioning the Switch

The Switch is suitable for use in an office environment where it can be free-standing or mounted in a standard 19-inch equipment rack.

Alternatively, the Switch can be rack-mounted in a wiring closet or equipment room. A mounting kit, containing two mounting brackets and four screws, is supplied with the Switch.

When deciding where to position the Switch, ensure that:

- It is accessible and cables can be connected easily.
- Cabling is away from sources of electrical noise. These include lift shafts, microwave ovens, and air conditioning units. Electromagnetic fields can interfere with the signals on copper cabling and introduce errors, therefore slowing down your network.
- Water or moisture cannot enter the case of the unit.
- Air flow around the unit and through the vents in the side of the case is not restricted (3Com

recommends that you provide a minimum of 25 mm or 1 in. clearance).

- The air is as free of dust as possible.
- Temperature operating limits are not likely to be exceeded. It is recommended that the unit is installed in a clean, air conditioned environment.



It is always good practice to wear an anti-static wrist strap when installing network equipment, connected to a ground point. If one is not available, try to keep in contact with a grounded rack and avoid touching the unit's ports and connectors, if possible. Static discharge can cause reliability problems in your equipment.

Aufstellen des Switch

Bei der Entscheidung wo Sie den Switch positionieren, stellen Sie sicher das:

- Der Switch zugänglich ist und die Kabel leicht angeschlossen werden können.
- Die Kabel nicht in der Nähe von elektrischen Störquellen befinden. Das schließt Aufzugsschächte, Mikrowellen und Klimaanlage ein. Elektromagnetische Felder können die Signale in den Kupferleitungen stören, und Fehler verursachen, was die Verlangsamung Ihres Netzwerkes zur Folge haben kann.
- Weder Wasser noch Feuchtigkeit in das Gehäuse eindringen kann.
- Die Luftzirkulation um den Switch und durch die Öffnungen des Gehäuses nicht behindert wird.

3Com empfiehlt das Sie 25mm (1 Inch) Zwischenraum sicherstellen.

- Die Luft so frei wie möglich von Staub ist.
- Es unwahrscheinlich ist das die Betriebstemperatur überschritten wird. 3Com empfiehlt das Sie den Switch in einer sauberen, klimatisierten Umgebung installieren.

Rack-Mounting or Free-Standing

The unit can be mounted in a 19-inch equipment rack using the supplied mounting kit, (see ["Using the Mounting Kit"](#) on [page 14](#)), or it can be free-standing. Do not place objects on top of the unit or stack.



CAUTION: *If installing the Switch in a free-standing stack of different size Baseline or SuperStack® 3 units, the smaller units must be installed above the larger ones. Do not have a free-standing stack of more than six units.*

Using the Mounting Kit

The Switch is supplied with two mounting brackets and four screws. These are used for rack mounting the unit. When mounting the unit, take note of the guidelines given in ["Positioning the Switch"](#) on [page 13](#).

The Switch is 1U (1.75 in.) high and will fit in a standard 19-inch rack.



CAUTION: *Before continuing, disconnect all cables from the unit. Remove the self-adhesive pads from the underside of unit, if already fitted.*

To rack-mount the Switch:

- 1 Place the unit the right way up on a hard, flat surface with the front facing towards you.
- 2 Locate a mounting bracket over the mounting holes on one side of the unit.
- 3 Insert the two screws supplied in the mounting kit and fully tighten with a suitable screwdriver.

Figure 2 Inserting the Screws

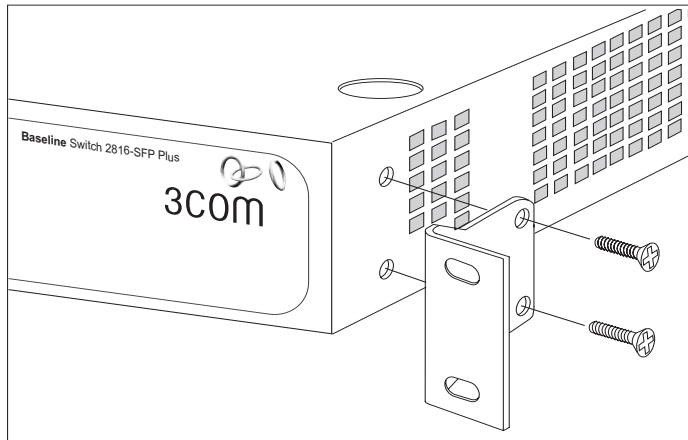

- 4 Repeat the two previous steps for the other side of the unit.
- 5 Insert the unit into the 19-inch rack and secure with suitable screws (not provided). Ensure that the ventilation holes are not obstructed.
- 6 Reconnect the network cables.

Montagesatz Anweisungen

Der Switch wird mit zwei Halterungen und vier Schrauben geliefert. Diese werden für den Einbau in einen Baugruppenträger benutzt. Bei der Montage der Baugruppe beachten Sie die Anweisungen aus "Aufstellen des Switch".

Der Switch ist eine Baueinheit hoch und passt in einen Standard 19" (Zoll) Baugruppenträger.



ACHTUNG: Entfernen Sie alle Kabel, bevor Sie fortfahren. Entfernen Sie die selbstklebenden Polster (Füße) von der Unterseite der Baugruppe, falls diese bereits angebracht sind.

- 1 Platzieren Sie die Baugruppe aufrecht auf einer harten, ebenen Fläche mit der Vorderseite zu Ihnen.
- 2 Ordnen Sie eine der Halterungen über den Löchern an der Seite der Baugruppe an.
- 3 Stecken Sie zwei der mitgelieferten Schrauben in die Löcher und drehen Sie diese mit einem geeigneten Schraubendreher fest.
- 4 Wiederholen Sie letzten beiden Schritte auf der anderen Seite der Baugruppe.
- 5 Führen Sie die Baugruppe in den 19" (Zoll) Baugruppenträger ein und sichern Sie die Baugruppe mit geeigneten Schrauben. (Nicht im Lieferumfang enthalten.)
- 6 Schließen Sie alle Kabel wieder an.

Placing Units On Top of Each Other

If the Switch units are free-standing, up to four units can be placed one on top of the other. If you are mixing a variety of Baseline and SuperStack units, the smaller units must be positioned at the top.

If you are placing Switch units one on top of the other, you must use the self-adhesive rubber pads supplied. Apply the pads to the underside of each Switch, sticking one in the marked area at each corner. Place the Switch units on top of each other, ensuring that the pads of the upper unit line up with the recesses of the lower unit.

Supplying Power to the Switch

Power problems can be the cause of serious failures and downtime in your network. Ensure that the power input to your system is clean and free from sags and surges to avoid unforeseen network outages. 3Com recommends that you install power conditioning, especially in areas prone to black outs, power dips and electrical storms.

The unit is intended to be grounded. Ensure it is connected to earth ground during normal use. Installing proper grounding helps to avoid damage from lightning and power surges.



Before powering on the Switch, verify that network cables and the power cable are securely connected.



CAUTION: *The Switch has no ON/OFF switch; the only method of connecting or disconnecting main*

power is by connecting or disconnecting the power cord.

To power on the Switch:

- 1 Plug the power cord into the power socket on the rear panel of the Switch. Refer to [“\(7\) Power Supply”](#) on [page 12](#) for more information.
- 2 Plug the other end of the power cord into a power outlet.

When the Switch is powered on, the Power LED lights up. If the Power LED does not light up, refer to [“\(5\) Power LED”](#) on [page 12](#) for more information.

Checking for Correct Operation

After you power on the Switch, it automatically performs a power-on self-test (POST). During POST, the Power LED on the front panel of the Switch flashes green.

When POST is complete, the Power LED turns green. If the Power LED turns yellow after POST, it means that POST failed.

[Table 8](#) summarizes the possible colors for the Power LED after POST.

Table 8 Possible Power LED Colors After POST

Color	State
Green	The unit is powered on and ready for use

Color	State
Yellow	Power-on self-test or loopback test failed. This can happen if a ports or ports fail when the Switch was powered on.
Off	The unit is not receiving power: <ul style="list-style-type: none"> ■ Verify that the power cord is connected correctly, and then try powering on the Switch again ■ If the Switch still does not operate, contact your 3Com network supplier

If POST fails, try the following:

- Power off the Switch, and then power it on again. Check the Power LED and see if POST was successfully completed.
- Reset the Switch. See [“Resetting to Factory Defaults”](#) on [page 59](#).



CAUTION: Resetting the Switch to its factory defaults erases all your settings. You will need to reconfigure the Switch after you reset it.

If these do not resolve the issue:

- Check the 3Com Knowledgebase for a solution. To visit the 3Com Knowledgebase Web site, start your Web browser, and then enter <http://knowledgebase.3com.com>
- Contact your 3Com network supplier for assistance.

Connecting a Network Device

To connect a network device to the Switch, use Category 5 unshielded or shielded (screened) 100 Ohm TP cables (or Category 3 cables for 10 Mbps connections).

For optimal connections, ensure that the cable length for each connection is not longer than 100 m (328 ft).

Figure 3 Connecting Devices to the Switch

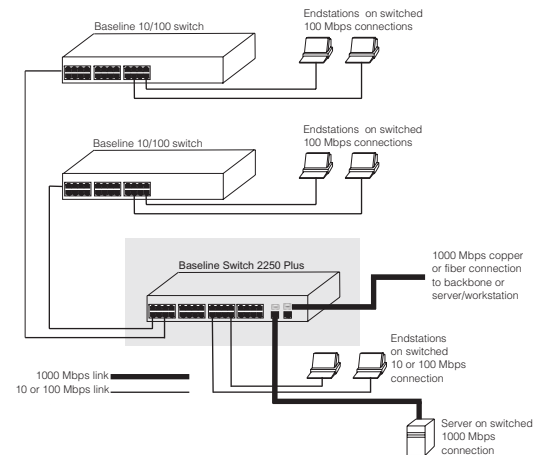

To connect a device to the Switch:

- 1 Connect one end of the cable to an RJ-45 port on the Switch.
- 2 Connect the other end to the appropriate RJ-45 port on the connecting device.

For 1000BASE-T operation, 3Com recommends using Category 5e or 6 cables.

Using SFP Transceivers

The following sections describe how to insert and remove an SFP transceiver from an SFP slot.

i SFP transceivers are hot-insertable and hot-swappable. You can remove them from and insert them into any SFP port without having to power off the Switch.

Approved SFP Transceivers

The following list of approved SFP transceivers is correct at the time of publication:

- 3CSFP91 SFP (SX)
- 3CSFP92 SFP (LX)

To access the latest list of approved SFP transceivers for the Switch on the 3Com Corporation World Wide Web site, enter this URL into your Internet browser:

<http://www.3com.com>

i 3Com recommends using 3Com SFPs on the Switch. If you insert an SFP transceiver that is not supported, the Switch will not recognize it.

Inserting an SFP Transceiver

To be recognized as valid, the SFP transceiver must be one of the following:

- 1000BASE-SX SFP transceiver – Use this transceiver to connect the Switch directly to a multimedia fiber-optic cable.
- 1000BASE-LX SFP transceiver – Use this transceiver to connect the Switch directly to a single-mode

fiber-optic cable or to multimode fiber using a conditioned launch cable.

i If the SFP transceiver is faulty, it will not operate within the Switch. See [“Troubleshooting” on page 59](#).

To insert an SFP transceiver:

- 1 Hold the transceiver so that the fiber connector is toward you and the product label is visible, as shown in [Figure 4](#). Ensure the wire release lever is closed (in the upright position).

Figure 4 Inserting the SFP Transceiver

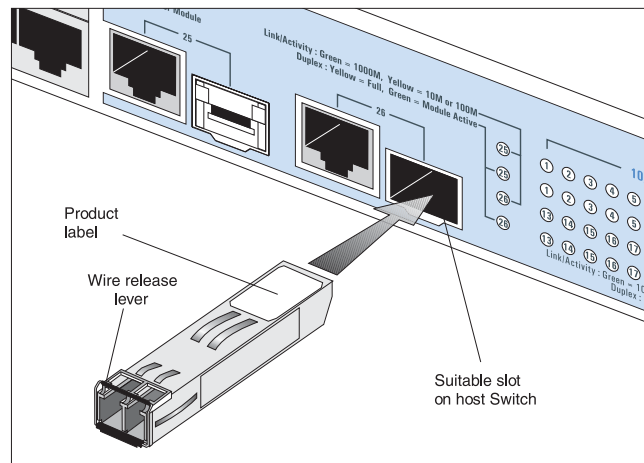

- 2 Gently slide the transceiver into the SFP slot until it clicks into place.



CAUTION: SFP transceivers are keyed and can be properly inserted only one way. If the transceiver does not click when you insert it, remove it, turn it over, and then re-insert it.

- 3 Remove the plastic protective cover, if fitted.
- 4 Connect the fiber cable.
- 5 The transceiver connects to the network using a duplex LC connector. Attach a male duplex LC connector on the network cable into the duplex LC connector on the transceiver.
- 6 Connect the other end of the cable to a device fitted with an appropriate Gigabit Ethernet connection.
- 7 Check the Module Active LEDs on the front of the Switch to ensure that it is operating correctly.

Removing an SFP Transceiver

Removing an SFP transceiver does not require powering off the Switch.

To remove an SFP transceiver:

- 1 Disconnect the cable from the transceiver.
- 2 Move the wire release lever downwards until it is pointing toward you.
- 3 Pull the wire release lever toward you to release the catch mechanism.

The SFP transceiver should slide out easily.

Performing Spot Checks

At frequent intervals, you should visually check the Switch. Regular checks can give you an early warning of a possible failure; any problems can then be attended to when there will be least effect on users.

3Com recommends periodically checking the items listed in [Table 9](#).

Table 9 Items to Check

Item	Verify That
Cabling	All external cabling connections are secure and that no cables are pulled taut
Cooling fan	Where possible, check that the cooling fan is operating by listening to the unit. The fan is fitted near to the front right hand side of the unit (when viewed from the front).

If you experience any problems operating the Switch, refer to [“Troubleshooting”](#) starting on [page 59](#).



3 CONNECTING TO THE WEB INTERFACE

The Switch has a built-in Web interface that you can use to set the admin password, change the IP address that is assigned to the Switch, and configure its advanced settings.



If you only want the Switch to function as a basic layer 2 switch, you do not need to access the Web interface and configure the Switch.

This chapter provides information on how to gain access to the Web interface using the Discovery application. It also introduces the menu items and buttons that are available on the Web interface.

The following topics are covered:

- [Requirements for Accessing the Web Interface](#)
- [Running the Discovery Application](#)
- [Logging On to the Web Interface](#)
- [Navigating the Web Interface](#)

Requirements for Accessing the Web Interface

To connect to the Web interface, you need the following:

- The Discovery application, which is included on 3Com Baseline Switch 2250 Plus CD-ROM that is supplied with your Switch
- A computer that is connected to the Switch and that has a Web browser

Running the Discovery Application

The 3Com Baseline Switch 2250 Plus CD-ROM contains, among others, the Discovery application.

The Discovery application can be used for detecting and connecting to the Switch on the network. The application will launch a Web interface that provides the user with options to configure, modify, and upgrade the Switch.

To use Discovery to connect to the Web interface, do the following:

- 1 On a computer that is connected to the Switch, insert the CD-ROM into its CD drive.

Discovery should start automatically. If it does not start automatically, go to the `\Discovery` folder on the CD-ROM, and then double-click `discovery.exe`.

The Welcome screen of Discovery appears.

Figure 5 Welcome Screen of Discovery

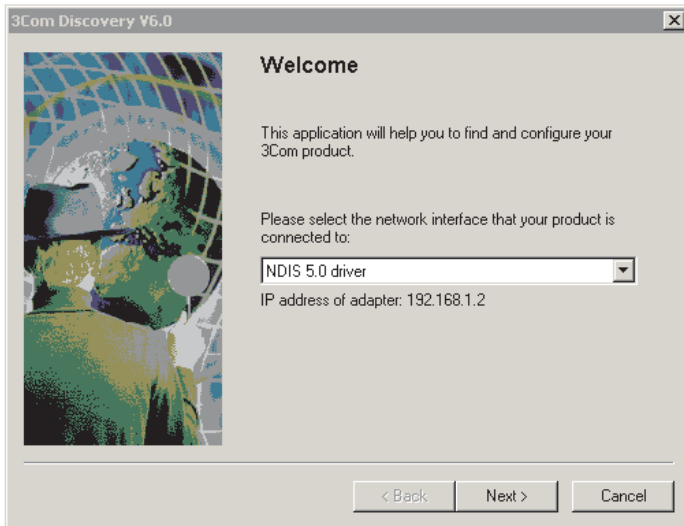

- 2 If the computer has multiple network adapters, select the adapter that connects the computer to the Switch, and then click *Next*.

If the computer has only one adapter, click *Next*.

Discovery searches the network for 3Com devices. When detection is complete, the Discovered Devices screen displays detected network devices.

Figure 6 Discovered Devices Screen

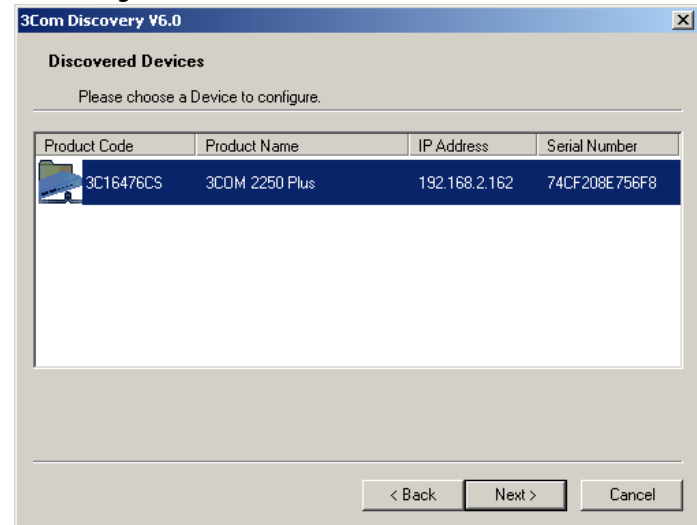

- 3 On the Discovered Devices screen, click *Baseline Switch 2250 Plus*, and then click *Next*.

The Completing the 3Com Discovery Application screen appears.

- 4 Click *Finish*.

The logon dialog box for the Web interface appears.

Logging On to the Web Interface

After the Web interface loads in your Web browser, the first page that appears is the logon screen. On this screen, you need to enter the administration user name and password to gain access to the Web interface.

The logon screen also displays the IP address that the Switch is currently using.

Figure 7 Logon Dialog Box

To log on to the Web interface:

- 1 In *User name*, type **admin**.
- 2 Leave the *Password* field blank.
- 3 Click *OK*.

Navigating the Web Interface

The Web interface has been designed to enable you to easily perform advanced configuration tasks and view information about the Switch.

Menu

The menu is located on the left side of the Web interface. When you click an item on the menu, the related screen appears in the main part of the interface. Some menu items will give you sub-menu tabs to choose from.

Figure 8 Switch Screen Layout

Sub-Menu Tabs

Menu

System Information

Device Summary Information	
Product Description:	iCom Switch 2250 plus 50-Port
System Location:	Marlborough, MA 01752 USA
System Contact:	iCom Corporation
Serial Number:	1EC75040E368
Product IC Number:	ICR17561-91
MAC Address:	00-12-A8-AD-E3-80
Software Version:	3.01.00026
Unit UpTime:	23 Days 19 hours 38 minutes 42 seconds
Bootrom Version:	1.00
Hardware Version:	00.00.00

[Table 10](#) lists the available items on the menu.

Table 10 Available Menu Items

Menu Item	Description
Device Summary	Contains tabs that allow you to: <ul style="list-style-type: none"> ■ Provide a summary of the Switch's basic settings and versions of current components. ■ Set the polling interval in seconds. ■ Display the description for each color coded port.
Save Configuration	Saves the Switch's configuration.
Administration	Manages the device.
IP Setup	Allows you to setup, modify, or view the IP configuration parameters.
Backup Configuration	Allows you to backup the Switch's configuration.
Restore Configuration	Allows you to restore a saved configuration.
Firmware Upgrade	Allows you to upgrade the current firmware via HTTP.
Initialize	Allows you to reset the Switch to factory default settings.
Reboot	Allows you to perform system reboot.
System Access	Contains tabs that allow you to: <ul style="list-style-type: none"> ■ Display user summary information. ■ Create a new user. ■ Modify existing users. ■ Remove existing users.
System Time	Allows you to set the system time.

Menu Item	Description
SNMP	Contains tabs that allow you to: <ul style="list-style-type: none"> ■ Display SNMP summary information. ■ Enable or disable SNMP. ■ Add community strings. ■ Remove community strings.
Device	Configures the device.
VLAN	Contains tabs that allow you to: <ul style="list-style-type: none"> ■ Create a VLAN. ■ Modify a VLAN. ■ Modify VLAN membership for a port. ■ Rename a VLAN. ■ Remove a VLAN. ■ Display VLAN membership for a port. ■ Display VLAN information.
Spanning Tree	Allows you to configure a Spanning Tree Protocol.
IGMP Snooping	Allows you to enable or disable IGMP snooping.
IGMP Query	Allows you to enable or disable IGMP query mode.
Broadcast Storm	Allows you to enable or disable rate limiting.
Port	Configures the ports.
Administration	Contains tabs that allow you to: <ul style="list-style-type: none"> ■ Display selected port information for the entire Switch. ■ Display individual port information. ■ Modify the port settings.

Menu Item	Description
Link Aggregation	Contains tabs that allow you to: <ul style="list-style-type: none"> ■ Display link aggregation summary. ■ Create an aggregation group. ■ Modify the port memberships. ■ Remove an aggregation group.
Spanning Tree per Port	Contains tabs that allow you to: <ul style="list-style-type: none"> ■ Display selected spanning tree information for every port. ■ Display individual port spanning tree information. ■ Modify the spanning tree settings for a port.
Port Mirroring	Monitor traffic going in and out of ports.
Statistics	Display statistics for a selected port.
QoS	Configures QoS settings.
VoIP Traffic Setting	Contains tabs that allow you to: <ul style="list-style-type: none"> ■ Display Voice VLAN summary. ■ Configure Voice VLAN global settings. ■ Configure Voice VLAN port settings. ■ Display port information for Voice VLAN and Trunk details. ■ Display OUI summary. ■ Add or remove OUI.
Security	Configures security settings.
Radius Client	Contains tabs that allow you to: <ul style="list-style-type: none"> ■ Display Radius Client information. ■ Configure Radius Client settings and set authentication parameters.

Menu Item	Description
802.1X Settings	Contains tabs that allow you to: <ul style="list-style-type: none"> ■ Display 802.1X information. ■ Display 802.1X detailed information per port. ■ Configure 802.1X settings.
Monitoring	Display Switch monitoring information.
Address Table	Displays MAC address table information for ports and VLANs.
Cable Diagnostics	Contains tabs that allow you to: <ul style="list-style-type: none"> ■ Display selected cable diagnostics information for all ports. ■ Display all cable diagnostics information per port.
Help	Direct link to help pages.

Buttons

Depending on the screen that is currently displayed, the following buttons may appear:

- *Apply* – Click to save and apply any changes that you have made
- *Cancel* – Click to discard any unsaved changes

Accessing the Interface Without Using Discovery

The Discovery application works by automatically detecting the IP address that is assigned to the Switch, and then using that address to connect to the Web interface. If you know the Switch's IP address, you can access the Web interface without using Discovery.

This section describes how to access the interface directly, without using Discovery.



If you do not configure the Switch's IP address settings, it will perform auto IP configuration to assign an IP address to itself. For more information, refer to "Automatic IP Configuration" on page 29.

To determine the IP address that the Switch will assign to itself during auto IP configuration, check the sticker on the base of the Switch. This sticker contains the MAC address and default IP address of the Switch.

DHCP Assigned IP Address

If you set the IP address mode to DHCP, check the DHCP server for the IP address that is assigned to the Switch, and then use that IP address to access the Web interface.

For example, if the DHCP server assigned the IP address 192.168.0.123 to the Switch, start your Web browser, and then type `http://192.168.0.123`.

Manually Assigned (Static) IP Address

If you assigned a static IP address to the Switch, you need to use that IP address to access the Web interface the next time you want to configure the Switch.

For example, if you assigned the Switch the IP address 192.168.0.123, start your Web browser, and then type `http://192.168.0.123`.

4 CONFIGURING THE SWITCH

This chapter provides information on how to configure the Switch's advanced features. Topics include:

- [Device Summary Information](#)
- [Administration Settings](#)
- [Configuring VLANs](#)
- [Configuring Port Settings](#)
- [QoS VoIP Traffic Settings](#)
- [Security](#)
- [Monitoring](#)

Configuration Overview

The Switch is shipped ready for use. If you only want the Switch to function as a basic layer 2 switch, you do not need to access the Web interface and configure the Switch.

You only need to access the Web interface if you want to:

- Set the administration password to the Web interface
- Assign an IP address to the Switch
- Configure the Switch's advanced features
- Upgrade the firmware

Device Summary Information

The Device Summary screen, which automatically loads after you log on to the Web interface, provides a snapshot of the Switch's basic settings and versions of current components.

Click *Device Summary* on the menu. A screen appears with three tabs that include:

- Device View
- Polling Interval
- Color Key

Device View

Contains fields that display the system, switch, and management switch information to identify the Switch. The fields include Product Description, System Location, System Contact, Serial Number, Product 3C Number, MAC Address, Software Version, Unit Uptime, Bootrom Version, and Hardware Version.

Figure 9 Device View

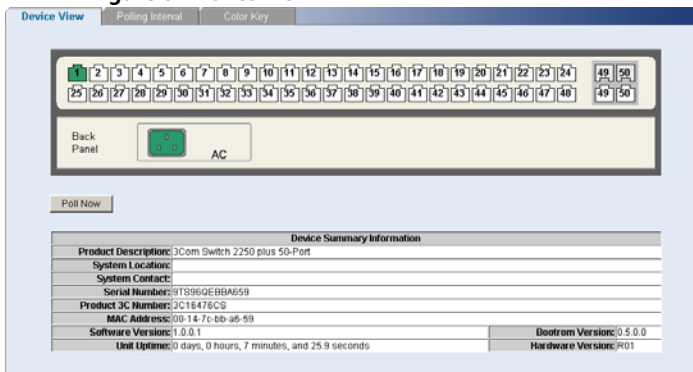

If you request for technical assistance from 3Com Support, you may be asked to print out the information on this screen.

Polling Interval

Enter the interval in seconds you would like the Switch to refresh. (Range: 10 to 180 seconds; 0 to disable polling).

Figure 10 Device View

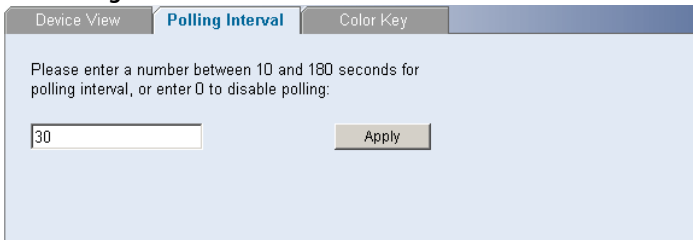

To set the polling interval:

- 1 Click the *Device Summary* menu, click *Polling Interval* tab.
- 2 Enter a number between 10 to 180 seconds for the polling interval. Enter a 0 to disable polling.

Color Key

Description of the color coding.

Figure 11 Color Key



Administration Settings

The Administration menu includes eight administration items:

- IP Setup
- Backup Configuration
- Restore Configuration
- Firmware Upgrade
- Initialize
- Reboot
- System Access
- System Time
- SNMP

Modifying the IP Address Settings

To enable devices on the network to communicate with the Switch, you need to assign an IP address to it — either by DHCP or by assigning a static IP address.

By default, the Switch performs automatic IP configuration and assigns an IP address to itself. This is necessary for the Discovery application to be able to connect to the Web interface.

Automatic IP Configuration

When you power on the Switch for the first time, it automatically uses the default IP address `169.254.x.y`, where `x` and `y` are the last two bytes of its MAC address.



To determine the exact IP address that the Switch assigns to itself during auto IP configuration, check the sticker on the base of the Switch. This sticker contains the MAC address and default IP address of the Switch.

To detect its IP information using the automatic configuration process, the Switch goes through the following sequence of steps:

- 1 The Switch tries to configure itself with the default IP address `169.254.x.y`, where `x` and `y` are converted from the last two bytes of its MAC address.

For example, if the MAC address is `08004E000102`, the IP address would be `169.254.1.2`. This address is used if the Switch is operating in a standalone mode, or no other switches on the network have this IP address.

The Switch also assigns the subnet mask `255.255.0.0` (default class B mask) to itself.

- 2 If this default IP address is already in use on the network, then the Switch detects this, and increments the last byte of the MAC address by one to generate its IP address.

The IP address would therefore become `169.254.1.3`.

- 3 The Switch repeats step 2 until an unused IP address is found.



3Com recommends using automatic IP configuration only for the initial setup. Once you gain access to the Web interface, you should assign an IP address to the Switch (either by using DHCP or assigning a static IP address) to ensure successful communication between the Switch and other network devices.

IP Setup

To set the IP address for the Switch:

- 1 Click *Administration*, then *IP Setting* on the menu. The IP Settings screen appears. Follow the IP Setup Wizard to complete the setup.



This wizard can also be used to set system name, location and contact information.

Figure 12 IP Settings Screen

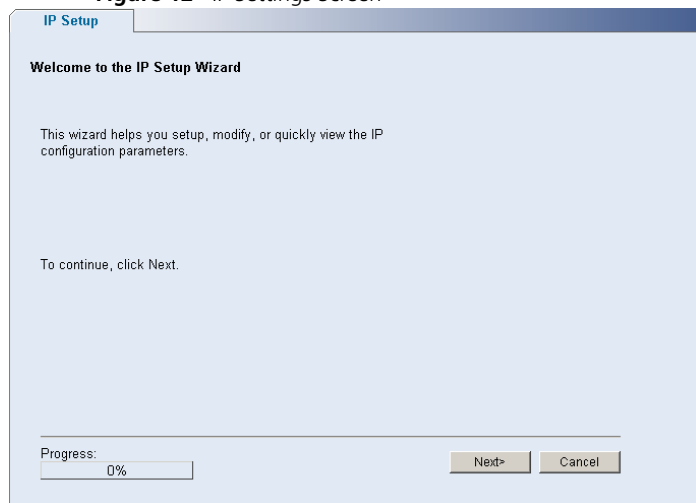

Backup Configuration

To save the Switch configuration settings:

- 1 Click *Administration*, then *Backup Configuration* on the menu. The Backup Configuration screen appears.

Figure 13 Backup Configuration

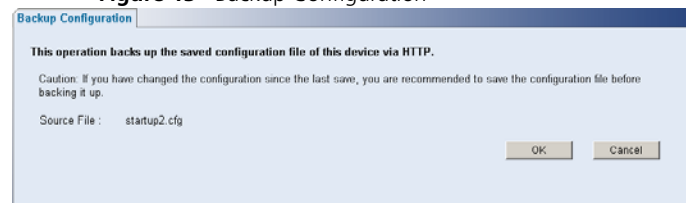

- 2 Click *OK*. You will be prompted to provide a location where the configuration file will be saved.

Restore Configuration

To reload configuration settings that you previously saved to a file:

- 1 Click *Administration*, then *Restore Configuration* on the menu. The Restore Configuration screen appears.

Figure 14 Restore Configuration

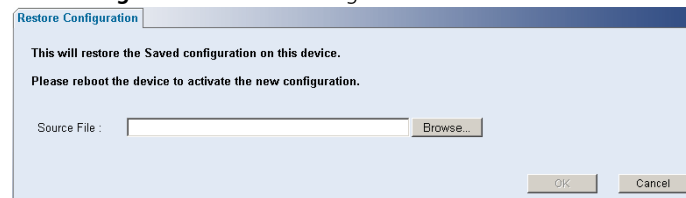

- 2 Click *Browse* to locate the backup file on your computer to restore the configuration settings.

- 3 Click *Restore* to copy the configuration back to the Switch.

For security purposes, restoring the configuration does not change the password.

Firmware Upgrade

The Upgrade facility allows you to install on the Switch any new releases of system firmware that 3Com may make available.

Newer versions of firmware can be downloaded via HTTP and copied to the Switch; the Switch will restart and apply the newer system firmware version.

Figure 15 Upgrade Screen

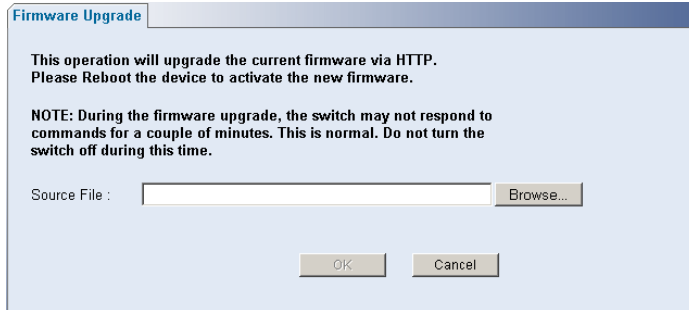

- 1 Click *Administration*, then *Firmware Upgrade* on the menu. The Firmware Upgrade screen appears.
- 2 Once you have downloaded the firmware, use the *Browse* button to locate the file on your computer, and then click *OK*.



*You may need to change the file type in the dialog box displayed by your Web browser to *.* to be able to see the file.*

The file will be copied to the Switch, and once this has completed, the Switch will restart. Although the upgrade process has been designed to preserve your configuration settings, 3Com recommends that you make a backup of the configuration beforehand, in case the upgrade process fails for any reason (for example, the connection between the computer and the Switch is lost while the new firmware is being copied to the Switch).

A progress screen displays while the upgrade is taking place.

The upgrade procedure can take a few minutes, and is complete when the progress bar has finished running and the Power LED has stopped flashing and is permanently green.



CAUTION: *Do not interrupt power to the Switch during the upgrade procedure. If you do, the firmware may be corrupted and the Switch may not start up properly afterwards.*

Initialize

To reset the Switch to factory default settings:

- 1 Click *Administration*, then *Initialize* on the menu.

You will lose all your configuration changes. The Switch LAN IP address will revert to the default IP address 169.254.x.y. (see [“Automatic IP Configuration”](#) on [page 29](#)). You may need to restart

your computer to re-establish communication with the Switch.

Reboot

Clicking on *Administration*, then *Reboot* on the menu has the same effect as power cycling the unit. No configuration information will be lost. Reboot the Switch if you are experiencing problems and you want to re-establish your Internet connection.

Any network users that are currently accessing the Internet will have their access interrupted while the reboot takes place, and they may need to restart their computers when the reboot has completed and the Switch is operational again.

System Access

Click *Administration*, then *System Access* on the menu. A screen appears with four system access tabs:

- User Summary
- Create User
- Modify User
- Remove User

To prevent unauthorized users from accessing the Web interface and modifying the Switch's settings, the interface is password-protected.

The default admin account settings are:

- User name – `admin`
- Password – blank (no password)

To ensure that unauthorized users do not access the Web interface, 3Com recommends that you set an admin password when you first configure the Switch.



Even if you do not intend to actively manage the switch, 3Com recommends that you change the password to prevent unauthorized access to your network.



The password can be up to 8 characters long and is case-sensitive.



If you forget the administration password after you set it, refer to ["Forgotten Password"](#) on [page 59](#) for information on how to regain access to the Web interface.

User Summary

Displays the list of user names and their access level.

Figure 16 User Summary Screen

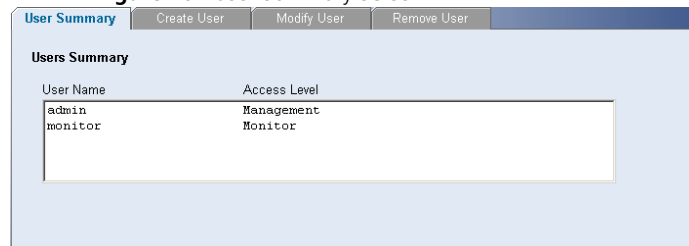

Create User

This page allows you to create a user and define the access level and password for that user.

Figure 17 CreateUser Screen

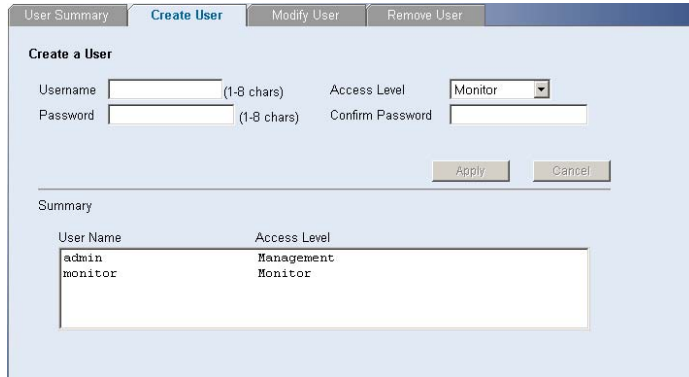

Create a User

Username (1-8 chars) Access Level

Password (1-8 chars) Confirm Password

Summary

User Name	Access Level
admin	Management
monitor	Monitor

Modify User

This page allows you to modify a user's access level and password.

Figure 18 Modify User Screen

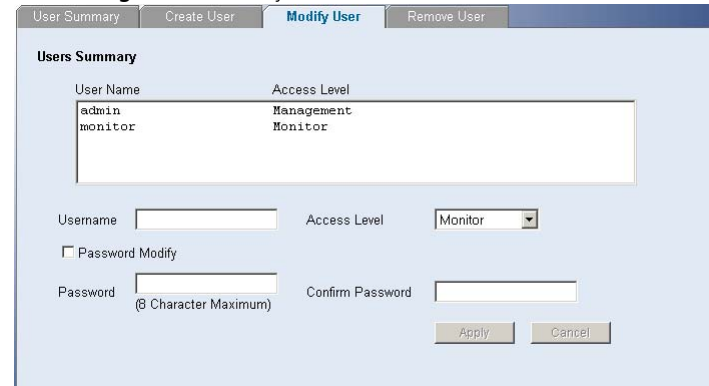

Users Summary

User Name	Access Level
admin	Management
monitor	Monitor

Username Access Level

Password Modify

Password (8 Character Maximum) Confirm Password

Remove User

To remove a user from the Switch, click on the user name, then click *Remove*.

Figure 19 Remove User Screen

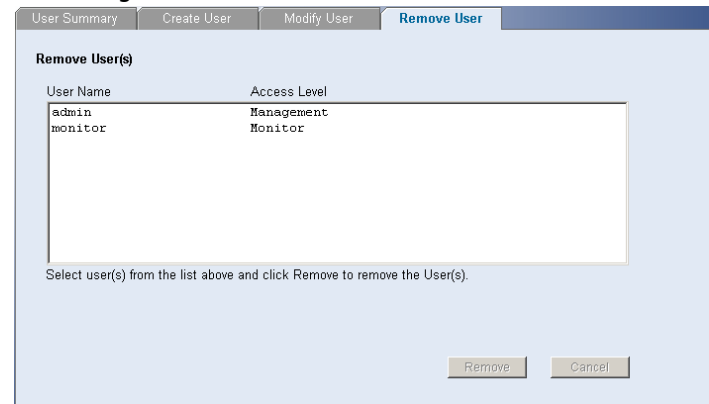

Remove User(s)

User Name	Access Level
admin	Management
monitor	Monitor

Select user(s) from the list above and click Remove to remove the User(s).

System Time

Click *Administration*, then *System Time* on the menu. This screen allows you to set the system time. You can set the Year, Month, Day, Hours, Minutes, and Seconds.

Figure 20 System Time Screen

Setup

Set up the system time manually.

Hours Minutes Seconds
Month Day Year

Apply Cancel

SNMP

Simple Network Management Protocol (SNMP) is a communication protocol designed specifically for managing devices on a network. Equipment commonly managed with SNMP includes switches, routers and host computers. SNMP is typically used to configure these devices for proper operation in a network environment, as well as to monitor them to evaluate performance or detect potential problems.

Click *Administration*, then *SNMP* on the menu. A screen appears with four system access tabs:

- Summary
- Setup
- SNMP Add
- SNMP Remove

Summary

Displays the list community access strings.

Figure 21 SNMP Summary Screen

Summary Setup SNMP Add SNMP Remove

SNMP Trap Summary

IP Address	Community String	Version
(none)		

Setup

Enable or disable the SNMP Agent Status.

Figure 22 SNMP Setup Screen

Summary Setup SNMP Add SNMP Remove

SNMP Agent Status Enabled

Apply Cancel

SNMP Add

This page allows you to create community strings for management access.

Figure 23 SNMP Add Screen

The screenshot shows the 'SNMP Add' screen with the following fields and controls:

- Summary** | **Setup** | **SNMP Add** | **SNMP Remove**
- New Traps Destination**
- IP Address:
- Community String:
- Version:
-
- Table with columns: IP Address, Community String, Version
- Table content: (none)

SNMP Remove

This page allows you to remove community strings.

Figure 24 SNMP Remove Screen

The screenshot shows the 'SNMP Remove' screen with the following elements:

- Summary** | **Setup** | **SNMP Add** | **SNMP Remove**
- Table with columns: IP Address, Community String, Version
- Table content: (none)
-

Configuring VLANs

A virtual LAN (VLAN) is a collection of network nodes that share the same collision domain, regardless of their physical location or connection point in the network. A VLAN serves as a logical workgroup with no physical barriers, and allows users to share information and resources as though located on the same LAN.

You can use the Switch to create VLANs to organize any group of ports into separate broadcast domains. VLANs confine broadcast traffic to the originating group and help eliminate broadcast storms in large networks. This also provides for a more secure and cleaner network environment.

You can create up to 64 VLANs, add specific ports to a chosen VLAN (so that the port can only communicate with other ports on the VLAN), or configure a port make it a member of all VLANs.

Communication between different VLANs can only take place if they are all connected to a router or layer 3 switch.

The Device menu includes five items:

- VLAN
- Spanning Tree
- IGMP Snooping
- IGMP Query
- Broadcast Storm

VLAN

Click *Device*, then *VLAN* on the menu. A screen appears with seven tabs that include:

- Setup
- Modify VLAN
- Modify Port
- Rename
- Remove
- Port Detail
- VLAN Detail

Setup

Use the Setup screen to create VLANs on the Switch. To propagate information about VLAN groups used on this Switch to external devices, you must specify a VLAN ID for each VLAN.

Figure 25 Setup Screen

Create VLANs: ID(s)
Example: 3, 5-10

ID	Name
1	DefaultVlan

Available option on the Setup screen include:

- VLAN ID – ID of configured VLAN (1-4094, no leading zeroes)

For examples on setting up VLANs, refer to [“Sample VLAN Configurations”](#).



CAUTION: *At least one port must always be an untagged member of VLAN 1 (the management VLAN). If you choose to connect all ports to VLANs other than VLAN 1, you will no longer be able to access the Web interface. If this happens, you will need to reset the Switch to factory settings.*

By default, all ports belong to VLAN 1 as an untagged member. However, they can belong to multiple VLANs as a tagged member. Also, newly created VLANs will initially have no ports associated with them.

Modify VLAN

Use the Modify VLAN screen to change the VLAN to which a port belongs, and configure the port to communicate with all other VLANs, or a selected VLAN.

Figure 26 Modify VLAN Screen

- 1 Enter a set of VLANs or select all VLANs to configure, then click *Select*.
- 2 From the drop down menu, select a VLAN to modify.
- 3 Select a membership use. Available options for each port include (only one option can be associated with a single port):
 - Tagged
 - Untagged
- 4 Select ports to associate with the membership, then click *Apply*.

Modify Port

Use the Modify Port screen to modify the VLAN membership of a port.

Figure 27 Modify Port Screen

- 1 Select a membership use. Available options for each port include (only one option can be associated with a single port):
 - Not a member
 - Tagged
 - Untagged
- 2 Select a port to associate with the membership.
- 3 Enter a VLAN to apply these changes to, then click *Apply*.

Rename

Use the Rename screen to change the name of a VLAN.

Figure 28 Rename Screen

The screenshot shows the 'Rename' tab in a network management interface. At the top, there are navigation tabs: Setup, Modify VLAN, Modify Port, **Rename**, Remove, Port Detail, and VLAN Detail. Below the tabs, there is a section titled 'Select a set of VLANs to work with:' containing a text input field with a magnifying glass icon and the text 'Example: 1,3,5-10', and a radio button labeled 'All VLANs' with a 'Select' button next to it. Below this is a section titled 'Choose a VLAN to rename' which contains a table with two columns: 'ID' and 'Name'. The table currently shows a single entry with '(none)' in both columns. At the bottom, there is a 'Selected ID' label, an 'Enter new name' text input field, and an 'Apply' button.

- 1 Enter a set of VLANs or select all VLANs to add to the rename list, then click *Select*.
- 2 From the list of selected VLANs, choose a VLAN to rename. Enter a new VLAN name and click *Apply*.

Remove

Use the Remove screen to remove a VLAN.

Figure 29 Remove Screen

The screenshot shows the 'Remove' tab in a network management interface. At the top, there are navigation tabs: Setup, Modify VLAN, Modify Port, Rename, **Remove**, Port Detail, and VLAN Detail. Below the tabs, there is a section titled 'Select a set of VLANs to work with:' containing a text input field with a magnifying glass icon and the text 'Example: 1,3,5-10', and a radio button labeled 'All VLANs' with a 'Select' button next to it. Below this is a table with two columns: 'ID' and 'Name'. The table currently shows a single entry with '(none)' in both columns. At the bottom, there are three buttons: 'Select All', 'Remove', and 'Cancel'.

- 1 Enter a set of VLANs or select all VLANs to add to the remove list, then click *Select*.
- 2 From the list of selected VLANs choose a VLAN to remove, or click the *Select All* button to select all the VLANs. Click *Remove* to remove the VLAN.

Port Detail

Choose a port to display the tagged and untagged VLAN memberships it is associated with.

Figure 30 Port Detail Screen

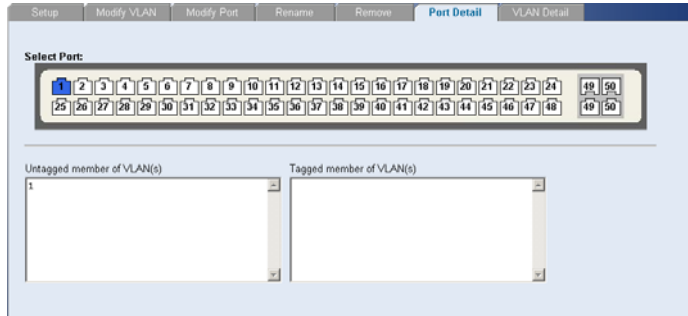

VLAN Detail

Use this screen to display detailed VLAN information.

- 1 Enter a set of VLANs or select all VLANs to add to the details list, then click *Select*.
- 2 From drop down menu, choose a VLAN to display the tagged and untagged VLAN memberships it is associated with the ports on the switch.

Figure 31 VLAN Detail Screen

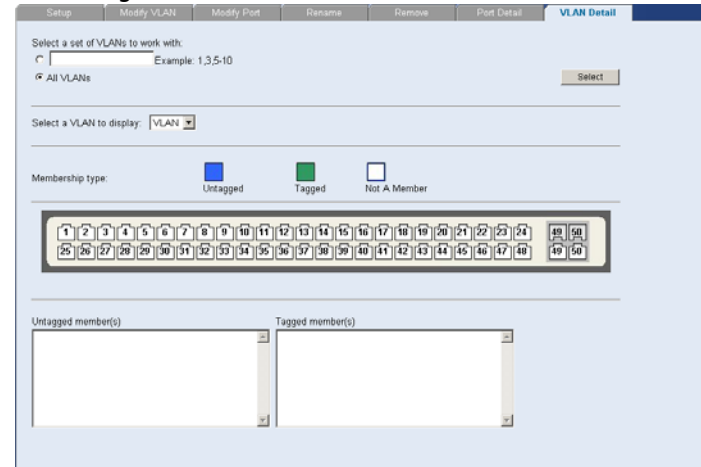

Forwarding Tagged/Untagged Frames

Each port on the Switch is capable of passing tagged or untagged frames.

The following describes how the Switch will handle tagged and untagged frames.

- When a port receives a tagged frame with a VLAN ID and the port is a member (untagged or tagged) of that VLAN, the frame is accepted. Otherwise if the port is not a member of that VLAN, the frame is discarded.
- When a port receives an untagged frame and the port is an untagged member of a VLAN, the frame is accepted and assigned to that VLAN ID. Otherwise if the port is not an untagged member of any VLAN, the frame is discarded.

The Switch will only forward a frame to ports that are members (tagged or untagged) of the VLAN to which the frame is assigned. If the port is an untagged member, the egress frame will be stripped of the VLAN tag and forwarded as untagged. However, if the port is a tagged member, the egress frame is forwarded as tagged.

Sample VLAN Configurations

To illustrate how you can segment network devices that are connected to the Switch, the following sample configurations are provided.

Setting Up Two VLANs on the Same Switch

[Figure 32](#) illustrates how you can set up a simple VLAN on the Switch using desktop connections.

Figure 32 Desktop VLAN Configuration

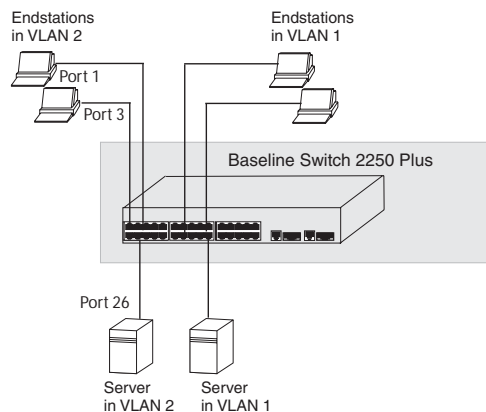

If you want to add ports 1, 3, and 26 to VLAN2 (as shown in [Figure 32](#)), so that the ports on the default

VLAN1 and the ports on VLAN2 cannot communicate with each other, do the following:

- 1 Create a new VLAN and set the VLAN ID to 2. Refer to [“Setup”](#) for instructions. VLAN1 is the default VLAN and already exists.
- 2 Set ports 1, 3, and 26 to associate with the *Untagged* membership in VLAN2.
- 3 Click *Apply*.

Ports 1, 3, and 26 now belong to VLAN2, and will not communicate with any other ports, unless you add other ports to the VLAN or change the port configuration.

Setting Up VLAN Across Two Switches

This example explains how you can set up a VLAN across two Switches using *Tagged* ports. This enables ports that are members of the same VLAN (but are on different switches) to communicate, provided that a port on each Switch is set to *Tagged*, and that these ports are connected.

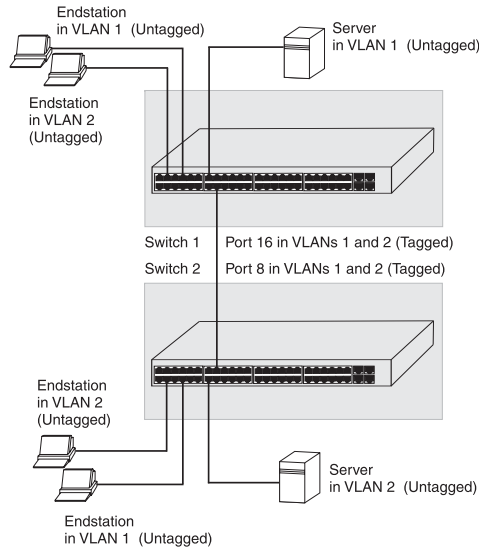
Figure 33 Tagged VLAN Configuration

To set up the configuration shown in [Figure 33](#), do the following:

- 1 Create VLAN2 on both Switch 1 and Switch 2. You need not create VLAN1 since it exists by default.
- 2 On Switch 1, set the ports that you want to be part of VLAN2 to *Untagged*. Set one port (for example, port 16) to *Tagged*.
Click *Apply*.
- 3 On Switch 2, set the ports that you want to be part of VLAN2 to *Untagged*. Set one port (for example, port 8) to *Tagged*.
Click *Apply*.

- 4 Connect the *Tagged* port on Switch 1 (in this example, port 16) to the *Tagged* port on Switch 2 (in this example, port 8).

Those ports on Switch 1 that are members of VLAN2 can now communicate with those ports on Switch 2 that are members of VLAN2.

Spanning Tree

Spanning tree is a bridge-based system for providing fault tolerance on networks and can be used to detect and disable network loops. The spanning tree ensures that the optimal path is maintained between spanning tree-compliant networked devices by:

- Disabling redundant paths when the main paths are operational.
- Enabling redundant paths if the main paths fail.

Spanning tree uses a distributed algorithm to select a bridging device that serves as the root of the spanning tree network. The bridging device, known as the Root Bridge, generates bridge protocol data units (BPDUs) on all ports at a regular interval known as the Hello Time. All other spanning tree-compliant devices on the network have a designated Root Port. This is the Port nearest the Root Bridge and it is used for receiving the BPDUs initiated by the Root Bridge. If a bridge does not get a Hello BPDU after a predetermined interval, the bridge assumes that the link to the Root Bridge is down. This bridge will then initiate negotiations with other bridges to reconfigure the network to reestablish a valid network topology.

After all the bridges on the network have determined the configuration of their ports, each bridge only forwards traffic between the Root Port and the ports that are the Designated Bridge Ports for each network segment. All other ports are blocked, which means that they are prevented from forwarding traffic.

To use spanning tree, choose enabled from the drop State down menu, fill in the setup parameters, and click *Apply*.

Figure 34 Spanning Tree Screen

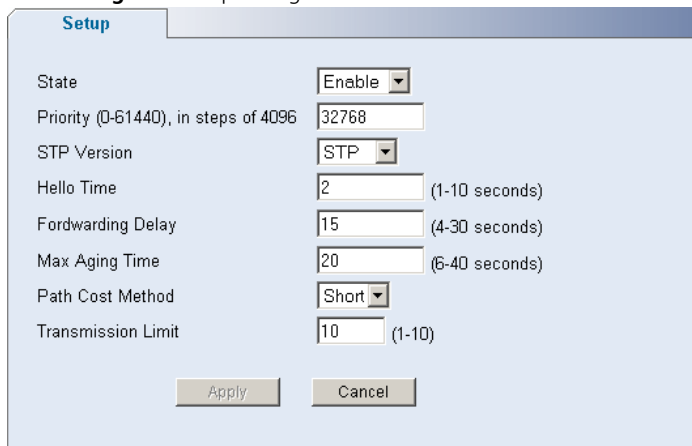

The Spanning Tree Setup screen features a 'Setup' tab at the top. It contains several configuration fields: 'State' is a dropdown menu set to 'Enable'; 'Priority (0-61440), in steps of 4096' is a text input field with '32768'; 'STP Version' is a dropdown menu set to 'STP'; 'Hello Time' is a text input field with '2' and '(1-10 seconds)' to its right; 'Forwarding Delay' is a text input field with '15' and '(4-30 seconds)' to its right; 'Max Aging Time' is a text input field with '20' and '(6-40 seconds)' to its right; 'Path Cost Method' is a dropdown menu set to 'Short'; and 'Transmission Limit' is a text input field with '10' and '(1-10)' to its right. At the bottom, there are 'Apply' and 'Cancel' buttons.

IGMP Snooping

This switch uses IGMP (Internet Group Management Protocol) to query for any attached hosts that want to receive a specific multicast service. It identifies the ports containing hosts requesting to join the service and sends data out to those ports only. It then propagates the service request up to any neighboring multicast switch/router to ensure that it will continue

to receive the multicast service. This procedure is called multicast filtering.

The purpose of IP multicast filtering is to optimize a switched network's performance, so multicast packets will only be forwarded to those ports containing multicast group hosts or multicast routers/switches, instead of flooding traffic to all ports in the subnet (VLAN).

Choose enable or disable from the IGMP Snooping Mode drop down menu.

Figure 35 IGMP Snooping Setup Screen

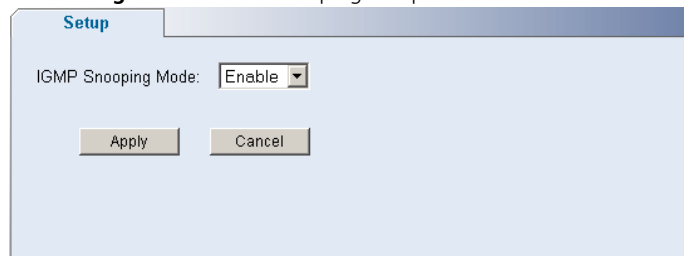

The IGMP Snooping Setup screen features a 'Setup' tab at the top. It contains one configuration field: 'IGMP Snooping Mode' is a dropdown menu set to 'Enable'. At the bottom, there are 'Apply' and 'Cancel' buttons.

IGMP Query

Choose enable or disable from the IGMP Query Mode drop down menu.

Figure 36 IGMP Query Setup Screen

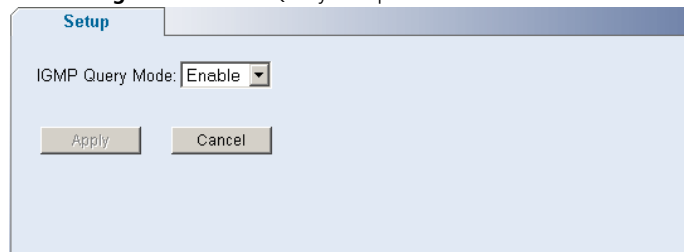

The IGMP Query Setup screen features a 'Setup' tab at the top. It contains one configuration field: 'IGMP Query Mode' is a dropdown menu set to 'Enable'. At the bottom, there are 'Apply' and 'Cancel' buttons.

Broadcast Storm

Use the Broadcast Storm page to set the Switch's broadcast storm control and threshold limits.

A broadcast storm is an incorrect packet sent out on a network that causes most hosts to respond all at once, typically with wrong answers that start the process over again. Broadcast storms use substantial network bandwidth and may cause network time-outs.

The settings include:

- Status – Enables and disables broadcast storm control.
- Packet Rate Threshold – Sets the broadcast storm threshold (64 to 1000000 kilobits per second).

Figure 37 Broadcast Storm Setup Screen

Setup

Broadcast Storm Control

Status Enabled

Packet Rate Threshold (64-1000000) (Kbits/sec)

Note: Packet threshold is ignored if Broadcast Storm Control is "Disabled".

Configuring Port Settings

Using the Web interface, you can configure the speed/duplex, flow control, link aggregation, and port mirroring settings of each port. You can also view the

current connection status of each port or shut down or disable ports.

The Port menu includes five items:

- Administration
- Link Aggregation
- Spanning Tree per Port
- Port Mirroring
- Statistics

Administration

Three tabs are available on the Port Administration page:

- Summary
- Detail
- Setup

Summary

Use the *Summary* tab to display Port State, Flow Control, Speed, Default VLAN ID, Link Type, or Duplex for all the ports.

Figure 38 Port Administration Summary Screen

Select Feature:

PortState Default VLAN ID(PVID)
 Flow Control Link Type
 Speed Duplex

Feature Summary:

Ports	Setting
1	Enabled
2	Enabled
3	Enabled
4	Enabled
5	Enabled
6	Enabled
7	Enabled
8	Enabled

Detail

Use the *Detail* tab to display detailed port setting information for a port.

Figure 39 Port Administration Detail Screen

Select a port

1	2	3	4	5	6	7	8	9	10	11	12	13	14	15	16	17	18	19	20	21	22	23	24	25	26	27	28	29	30	31	32	33	34	35	36	37	38	39	40	41	42	43	44	45	46	47	48	49	50
---	---	---	---	---	---	---	---	---	----	----	----	----	----	----	----	----	----	----	----	----	----	----	----	----	----	----	----	----	----	----	----	----	----	----	----	----	----	----	----	----	----	----	----	----	----	----	----	----	----

Port State:	Enable	PVID:	1
Flow Control:	Disable	Link Type:	Access
Speed:	Auto(10M)	Duplex:	Auto

Values in brackets indicate the current operating value for the chosen port

Setup

Use the *Setup* tab to configure the port settings. The following options are available:

- Port State – Enables and disables the port.
- Flow Control – Enables and disables flow control for the entire Switch. When flow control is enabled, the Switch regulates the packet flow so that a sending device does not transmit more packets than a receiving device can process. If flow control is disabled, packets may be dropped under certain periods of high traffic.

Flow control is disabled by default.

- Speed – Sets the speed mode of the port. Available options include auto, 10, 100, and 1000. For 1000 Mbps connections, see [“Speed/Duplex for 1000 Mbps Connections”](#) below.

Auto (or autonegotiation) sets the optimum combination of speed and duplex that can be supported by both ends of the link.

- Duplex – Sets the duplex mode of the port. Available options include auto, half, and full.

If you modify any of these settings, click *Apply* to save your changes.

Figure 40 Port Administration Setup Screen

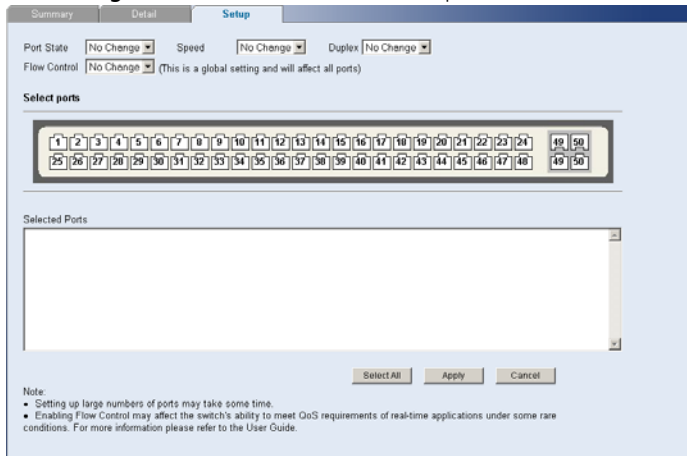

Speed/Duplex for 1000 Mbps Connections

You cannot preset the speed to 1000 Mbps. To run a port at 1000 Mbps, you must enable autonegotiation for the port. When autonegotiation is enabled, the Switch will automatically connect at 1000 Mbps, providing the connected device also supports this speed.

1000 Mbps connections are always full-duplex. Half-duplex connections are only available for 10 Mbps and 100 Mbps settings.



CAUTION: Before manually setting a port to full-duplex, verify that the device connected to the port is also manually set to the same speed and duplex setting. If connecting link partners are left to autonegotiate for a link manually set on this switch to full-duplex, they will always negotiate to half-duplex, resulting in a duplex mismatch. This can result in a significant reduction in network performance. If you are unsure of how to configure the speed/duplex setting, simply enable autonegotiation for the port.



You cannot modify the speed/duplex settings of ports that are members of a trunk or aggregated link.



Supported SFP transceivers only operate at 1000 Mbps full-duplex. Inserting an SFP transceiver into a gigabit port disables the corresponding RJ-45 port, even if no fiber cable is inserted.

Link Aggregation

Link aggregation, also called “trunking”, refers to bonding multiple ports into a single group to effectively combine the bandwidth into a single connection or a “trunk”. If you are connecting the Switch to another switch or to an Internet backbone, you can aggregate links on the Switch to increase throughput and prevent packet loopback between switches.

For link aggregation to work, the trunks must be configured on both ends (switches).

Guidelines for Creating Trunks

- Any port on the Switch can be used for creating a trunk.
- This switch supports a maximum of four trunks.
- Each trunk may contain up to four members.
- A port may only be a member of one trunk at any one time.
- All ports in a trunk must be configured in an identical manner, including communication mode (that is, speed, duplex mode and flow control).

Four tabs are available on the Port Link Aggregation page:

- Summary
- Create
- Modify
- Remove

Summary

Use the *Summary* tab to display Group ID, Port members, and Link Type for a list of link aggregate groups.

Figure 41 Link Aggregation Summary Screen



Create

Use the Create tab to add ports to a group membership.

Figure 42 Link Aggregation Create Screen

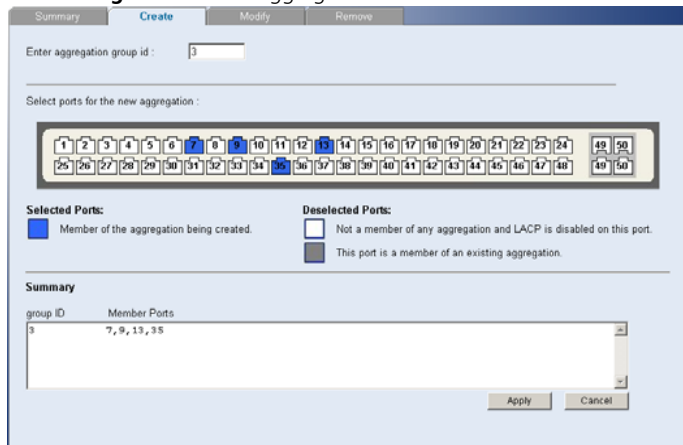

To create a new link aggregation group:

- 1 Enter a link aggregation group ID in the box field.
- 2 Select the ports to add to the group.
- 3 Click *Apply*.

Modify

Use the Modify tab reassign port members to a link aggregation group.

Figure 43 Link Aggregation Modify Screen

To modify a link aggregation group:

- 1 Select the aggregation group to modify, then click *Select*.
- 2 Select the ports to add to the group.
- 3 Click *Apply*.

Remove

Use the Remove tab delete a link aggregation group.

Figure 44 Link Aggregation Remove Screen

Group ID	Member Ports
1	3, 11, 14, 22, 30, 44, 45, 46, 48
2	4, 7, 27, 39
3	10, 18, 29, 40, 50
4	2, 8, 35, 49

To remove a link aggregation group:

- 1 From the link aggregation group list, select the aggregated group to remove.
- 2 Click *Remove*.

Spanning Tree per Port

This administrative tool supports the configuration of the Switch to forward, or block and discard 802.1D spanning tree BPDU packets.

Spanning tree is a bridge-based system for providing fault tolerance on networks and can be used to detect and disable network loops. The spanning tree ensures that the optimal path is maintained between spanning tree-compliant networked devices by:

- Disabling redundant paths when the main paths are operational.
- Enabling redundant paths if the main paths fail.

Spanning tree uses a distributed algorithm to select a bridging device that serves as the root of the spanning tree network. The bridging device known as

the Root Bridge generates BPDUs (Bridge Protocol Data Units) on all ports at a regular interval known as the Hello Time. All other spanning tree-compliant devices on the network have a designated Root Port. This is the Port nearest the Root Bridge and it is used for receiving the BPDUs initiated by the Root Bridge. If a bridge does not get a Hello BPDU after a predetermined interval, the bridge assumes that the link to the Root Bridge is down. This bridge will then initiate negotiations with other bridges to reconfigure the network to re-establish a valid network topology.

After all the bridges on the network have determined the configuration of their ports, each bridge only forwards traffic between the Root Port and the ports that are the Designated Bridge Ports for each network segment. All other ports are blocked, which means that they are prevented from forwarding traffic.

Three tabs are available on the Spanning Tree per Port page:

- Summary
- Detail
- Setup

Summary

Use the *Summary* tab to display Status, Edged Port, Link Type, Path Cost, State, or Port Priority for all the ports.

Figure 45 Spanning Tree Summary Screen

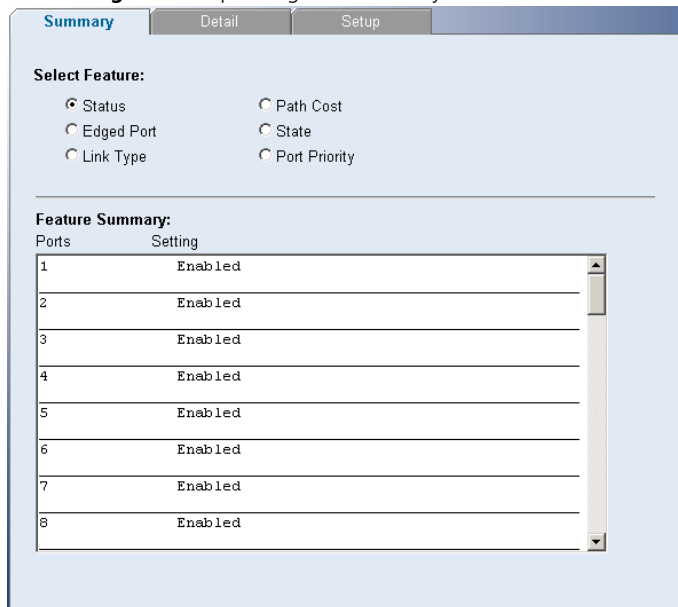

Detail

Use the *Detail* tab to display detailed spanning tree information for a port.

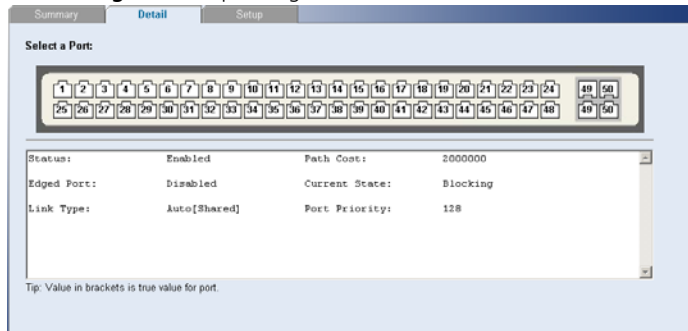
Figure 46 Spanning Tree Detail Screen

Setup

Use the *Setup* tab to configure the spanning tree settings for each port. The following options are available:

- **Status** – Enables and disables spanning tree for the port.
- **Edged Port** – Enables and disables edged port for the port.
- **Link Type** – Choose between Point-to-Point, Shared, or Auto for the link type.
- **Path Cost** – The path cost is used to determine the best path between devices. The path cost method is used to determine the range of values that can be assigned to each interface.
- **Port Priority** – Used in selecting the root device, root port, and designated port. The device with the highest priority becomes the STA root device. However, if all devices have the same priority, the

device with the lowest MAC address will then become the root device.

If you modify any of these settings, click *Apply* to save your changes.

Figure 47 Spanning Tree Setup Screen

Port Mirroring

The Switch allows you to monitor traffic going in and out of a particular port. For traffic monitoring to work, you need to attach a network analyzer to one port and use it to monitor the traffic of other ports in the stack.

To set up traffic monitoring, you need to set an analysis port (the port that is connected to the analyzer), and a monitor port (the port that is to be monitored). Once the pair is defined, and you enable traffic monitoring, the Switch takes all the traffic going in and out of the monitor port and copies it to the analysis port.



CAUTION: The analyzer port should have a higher bandwidth than the mirror port. Otherwise, the Switch may not be able to copy all traffic effectively during periods of high traffic.

Figure 48 Port Mirroring Screen

Port Traffic Monitoring

All traffic transmitted and received on the monitor port will be copied to the analyser port.

Monitor Port:

Analyser Port:

Mirror Type:

To set up port mirroring:

- 1 Connect a network analyzer to a port.
- 2 Access the Web interface. Click *Port*, then *Port Mirroring* on the menu. The Port Monitoring Setup Screen appears.
- 3 Select the port number under Monitor Port to which you want to monitor. Traffic to and from this port will be forwarded to the analyser port.
- 4 Select the port number under Analyser Port to which you connected the network analyzer. Traffic to and from the selected mirrored ports will be forwarded to this port.
- 5 Under Mirror Type, select to monitor incoming traffic, outgoing traffic, or both.
- 6 Click *Apply*.

QoS VoIP Traffic Settings

Using the Web interface, you can configure the Voice over Internet Protocol (VoIP) settings.

The QoS VoIP Traffic Setting menu includes six tabs:

- Summary
- Setup
- Port Setup
- Port Detail
- OUI Summary
- OUI Modify

Summary

Use the *Summary* tab to display the global settings for Voice VLAN.

Figure 49 QoS VoIP Summary Screen

Summary | Setup | Port Setup | Port Detail | OUI Summary | OUI Modify

Voice VLAN State: Disabled
 Voice VLAN-ID: 0
 Voice VLAN Aging Time: 1 Day 0 Hour 0 Min

Ports Enabled for Voice VLAN

Ports in Voice VLAN

Setup

Use the *Setup* tab to configure the global settings for Voice VLAN. The following options are available:

- Voice VLAN Status – Enable or disable Voice VLAN for the switch.
- Voice VLAN ID – Input the Voice VLAN ID for the switch.
- Voice VLAN Aging Time – Input the aging time.



You must first create a VLAN from the VLAN Setup page before you can assign and configure a Voice VLAN.

Figure 50 QoS VoIP Setup Screen

Port Setup

Use the *Port Setup* tab to configure the port or trunk setting for Voice VLAN. The following options are available:

- Voice VLAN Port Mode – Select between None, Manual, or Auto.
- Voice VLAN Port Security – Enable or disable the security.

To configure the Voice VLAN settings for the ports:

- 1 Select Voice VLAN Mode and Security settings.
- 2 Select the ports you would like to apply these settings to.
- 3 Click *Apply*.

Figure 51 QoS Port Setup Screen

Port Detail

Use the *Port Detail* tab to display the Voice VLAN information for selected ports.

Figure 52 QoS Port Detail Screen

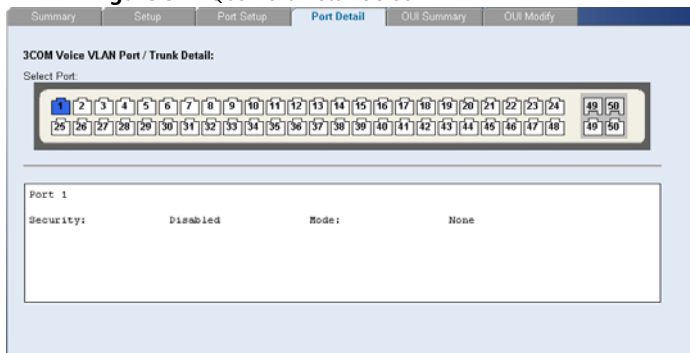

OUI Summary

Use the *OUI Summary* tab to display the list of Organizational Unique Identifier for a company and their description.

Figure 53 QoS OUI Summary Screen

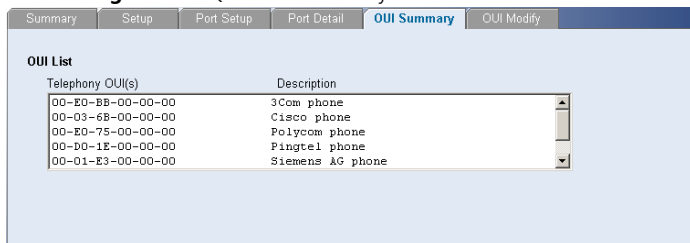

OUI Modify

Use the *OUI Modify* tab to add to the list of Organizational Unique Identifier. The following options are available:

- Telephony OUI – Input a new company identifier to add to the list.
- Description – Input a description for the new company identifier.

To add to the OUI list:

- 1 Enter a Telephony OUI and description.
- 2 Click *Add*.

To remove an OUI from the list:

- 1 Select a Telephony OUI from the list.
- 2 Click *Remove*.

Figure 54 QoS OUI Modify Screen

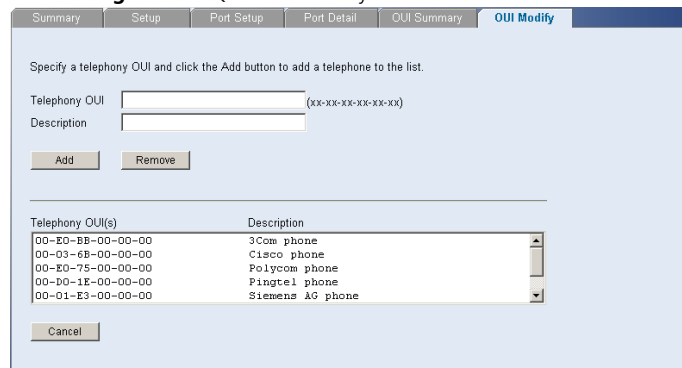

Security

Using the Web interface, you can configure the RADIUS Client and 802.1X settings.

The Security menu includes two items:

- RADIUS Client
- 802.1X Settings

RADIUS Client

Remote Authentication Dial-in User Service (RADIUS) is a logon authentication protocol that uses software running on a central server to control access to RADIUS-aware devices on the network. An authentication server contains a database of multiple user name/password pairs with associated privilege levels for each user or group that require management access to a switch.

The RADIUS Client menu includes two tabs:

- Detail
- Configure

Detail

Use the *Detail* tab to display the RADIUS Client settings.

Figure 55 RADIUS Client Detail Screen

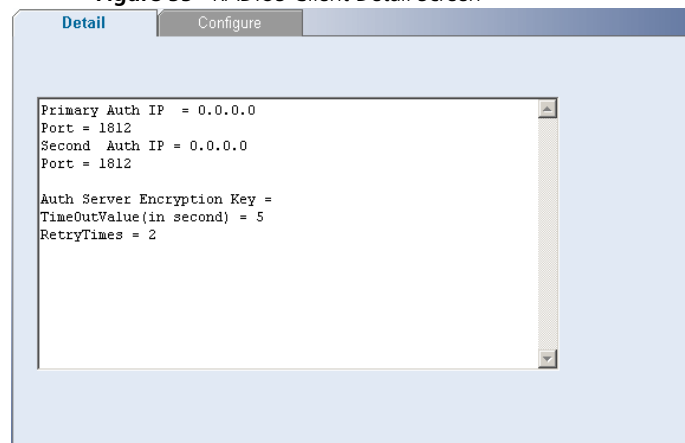

Configure

Use the *Configure* tab to configure the RADIUS settings. The following parameters are available:

- Max Retries – Sets the number of retries of sending authentication requests.
- Timeout – Sets the interval between sending authentication requests.
- IP Address – The IP address of the RADIUS server.
- UDP port – The RADIUS server UDP port used for authentication messages.
- Key – Sets the RADIUS encryption key.

After you have filled in the parameters, click *Apply* to save your changes.

Figure 56 RADIUS Client Configure Screen

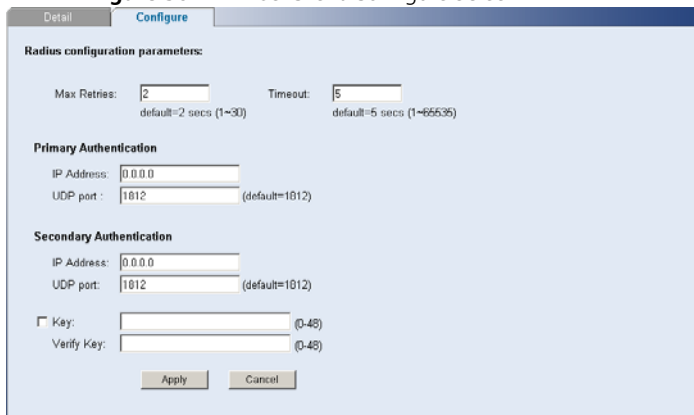
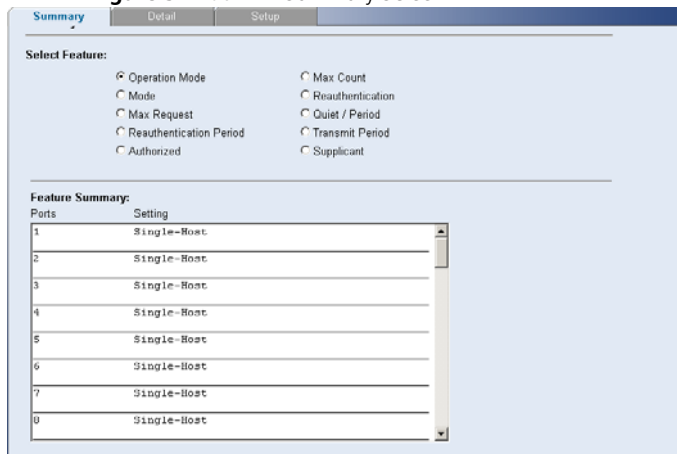

Figure 57 802.1X Summary Screen



802.1X Settings

The IEEE 802.1X (dot1x) standard defines a port-based access control procedure that prevents unauthorized access to a network by requiring users to first submit credentials for authentication.

The 802.1X settings menu includes three tabs:

- Summary
- Detail
- Setup

Summary

Use the *Summary* tab to display the 802.1X authentication settings.

Detail

Use the *Detail* tab to display detailed 802.1X authentication information for a port.

Figure 58 802.1X Detail Screen

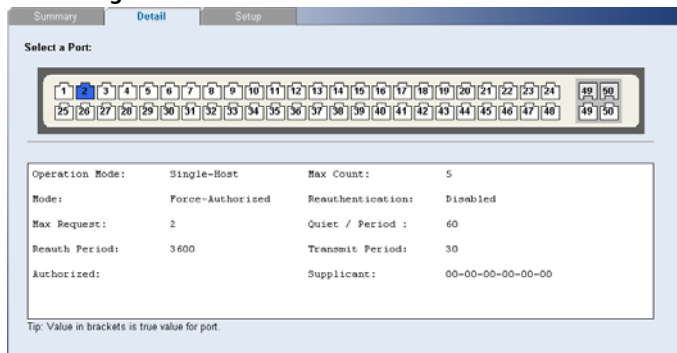

Setup

Use the *Setup* tab to configure the 802.1X authentication settings. The following fields are available:

- System Authentication – Sets the global setting for 802.1X. (Default: Disabled)
- Operation Mode – Allows single or multiple hosts (clients) to connect to an 802.1X-authorized port. (Options: Single-Host, Multi-Host; Default: Single-Host)
- Mode – Sets the authentication mode to one of the following options:
 - Auto – Requires a dot1x-aware client to be authorized by the authentication server. Clients that are not dot1x-aware will be denied access.
 - Force-Authorized – Forces the port to grant access to all clients, either dot1x-aware or otherwise.
 - Force-Unauthorized – Forces the port to deny access to all clients, either dot1x-aware or otherwise.
- Maximum Request – Sets the maximum number of times the switch port will retransmit an EAP request packet to the client before it times out the authentication session. (Range: 1-10; Default 2)
- Mode Reauthentication – Sets the client to be re-authenticated after the interval specified by the Re-authentication Period. Re-authentication can be used to detect if a new device is plugged into a switch port. (Default: Disabled)

- Max Count – The maximum number of hosts that can connect to a port when the Multi-Host operation mode is selected. (Range: 1-1024; Default: 5)
- Reauthentication Period – Sets the time period after which a connected client must be re-authenticated. (Range: 1-65535 seconds; Default: 3600 seconds)
- Quiet Period – Sets the time that a switch port waits after the Max Request Count has been exceeded before attempting to acquire a new client. (Range: 1-65535 seconds; Default: 60 seconds)
- Transmit Period – Sets the time period during an authentication session that the switch waits before re-transmitting an EAP packet. (Range: 1-65535; Default: 30 seconds)

After you have filled in the parameters, click *Apply* to save your changes.

Figure 59 802.1X Setup Screen

The screenshot shows the '802.1X System Setting' configuration page. At the top, there are tabs for 'Summary', 'Detail', and 'Setup'. The 'Setup' tab is active. Below the tabs, the '802.1X System Setting' section is visible. It includes a 'System Authentication' dropdown menu set to 'Disabled'. Under the 'Port Settings' section, there are several configuration options: 'Operation Mode' (No Change), 'Mode' (No Change), 'Maximum Request' (input field), 'Mode Reauthentication' (No Change), 'Max Count' (input field), 'Reauthentication Period' (input field), 'Quiet / Period' (input field), and 'Transmit Period' (input field). At the bottom of the page, there is a numeric keypad with buttons for digits 1-9, 0, and a '50' button. Below the keypad are three buttons: 'Select All', 'Apply', and 'Cancel'.

Monitoring

Using the Web interface, you can display address table information and cable diagnostics.

The Monitoring menu includes two items:

- Address Table
- Cable Diagnostics

Address Table

Use the Address Table Summary screen to display the Address Table information. You can query by selecting a port, choosing a VLAN, or entering in a MAC Address, then click *Select*.

Figure 60 Address Table Screen

Query by:

Port

VLAN

MAC Address

Feature Summary:

Port	MAC Address	VLAN
1	11-22-33-44-55-66	1

Cable Diagnostics

The Switch provides cable diagnostic, which helps you detect and resolve issues with the attached cables.

The Cable Diagnostics menu includes two tabs:

- Summary
- Diagnostics

Summary

Use the Summary tab to display information on Test Result, Cable Fault Distance, or Last Update for every port on the switch.

Figure 61 Cable Diagnostic Summary Screen

Select Feature:

Test Result

Cable Fault Distance

Last Update

Feature Summary:

Ports	Value
1	OK
2	OK
3	Fail
4	Fail
5	Fail
6	Fail
7	Fail
8	Fail

Diagnostics

Use the Diagnostics tab to display individual port information on Test Result, Cable Fault Distance, and Last Update.

Figure 62 Cable Diagnostic Screen

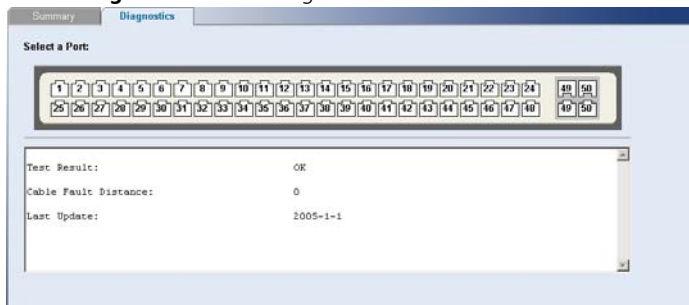



5 TROUBLESHOOTING

This chapter lists some issues that you may encounter while installing, using, and managing the Switch, with suggested courses of corrective action to take.

If you encounter an issue that is not listed here and you cannot solve it, check the 3Com Knowledgebase at <http://knowledgebase.3com.com> before contacting your local technical support representative.

For more information on how to obtain support for your Switch, refer to [Appendix A](#).

Resetting to Factory Defaults

If the Switch does not operate normally or if the firmware becomes corrupted, you can reset the Switch to factory defaults.



CAUTION: *Resetting the Switch to factory defaults erases all your settings. You will need to reconfigure the Switch after you reset it.*

To reset the Switch to its factory defaults:

- 1 Using the tip of a pen (or a similar object), press the Recovery button on the rear panel of the Switch. See [Figure 1](#) for illustration.
- 2 Power off the Switch, and then power it back on, while keeping the Recovery button pressed.
- 3 Release the Recovery button.

4 Reset the Switch either by:

- Accessing the Web interface using Discovery, and then pressing the *RESET* button on the Initialize tab of the *Administration* menu. After you click *RESET*, a confirmation message appears. Click *OK* to confirm.
- Powering off the Switch, and then powering it back on.



The Switch will perform automatic IP configuration after you reset it. See "[Automatic IP Configuration](#)" on [page 29](#) for more information.

Forgotten Password

If you forget the password to the Web interface after you set it, you will need to reset the Switch to regain access. See "[Resetting to Factory Defaults](#)" on [page 59](#) for instructions.

After resetting the Switch, log on to the Web interface using the default admin account settings:

- User name – `admin`
- Password – blank (no password)

Forgotten Static IP Address

If you forget the static IP address that you assigned to the Switch and you need to access the Web interface, use the Discovery application to automatically detect the IP address and connect to the interface.

For information on using the Discovery application, refer to [“Running the Discovery Application” on page 21](#).

Solving LED Issues

This section lists some issues that are related to the LEDs on the front panel of the Switch. For information on basic LED checks, refer to the following topics in [Chapter 1](#):

- [\(4\) Module Active LEDs](#)
- [\(3\) Link/Activity LEDs](#)
- [\(5\) Power LED](#)

A link is connected, but the Link/Activity LED for the port is off.

There is a problem with this connection. Verify that:

- The device being connected to is powered on and operating correctly.
- The cable is connected at both ends.
- The cable is not damaged.
- If the connection is to a workstation, that the workstation's network interface is installed and configured correctly.

- The correct category of cable is being used for the required link speed. Category 3 cables can be used for 10BASE-T operation only. Category 5 cable is required for 100BASE-TX or 1000BASE-T. 3Com recommends Category 5e or 6 cables for 1000BASE-T operation.

A fiber cable is connected, but the Module Active LED is off.

Verify that:

- The fiber cable is in good condition.
- The SFP module is correctly inserted.
- A 3Com SFP module is being used. Refer to [“Approved SFP Transceivers” on page 18](#) for details.
- The equipment at the far end is installed and correctly configured.

The Link/Activity LED is on, but network performance is poor

The Switch supports full-duplex autonegotiation. If the connected device does not support autonegotiation, ensure that it is configured for half-duplex operation only. If the connected device has autonegotiation disabled or overridden, and is configured as full-duplex, the Switch will configure the link as half-duplex, causing a mismatch that will reduce network performance when data is transmitting and receiving simultaneously on the same link.

Ensure that the connected device has either:

- Autonegotiation enabled, or
- The ports are configured for half-duplex operation

All ports appear to show continual activity.

There may be broadcast storms on the network. Remove port connections one at a time, waiting a few seconds between each port. If the LEDs go off after removing a port connection, the device that was connected to that port is introducing an excessive amount of broadcast frames to the network. Some pieces of network equipment operate by sending out broadcast frames regularly.

Refer to the documentation that accompanies the device for information on disabling the broadcast operation.

If the Problem Persists

If the problem persists and the unit still does not operate successfully, contact your 3Com network supplier with the following information before returning the unit:

- Product number and serial number (printed on a label supplied with the unit).
- A brief description of the issue



A OBTAINING SUPPORT FOR YOUR PRODUCT

Register Your Product

Warranty and other service benefits start from the date of purchase, so it is important to register your product quickly to ensure you get full use of the warranty and other service benefits available to you.

Warranty and other service benefits are enabled through product registration. Register your product at <http://eSupport.3com.com/>. 3Com eSupport services are based on accounts that you create or have authorization to access. First time users must apply for a user name and password that provides access to a number of eSupport features including Product Registration, Repair Services, and Service Request. If you have trouble registering your product, please contact 3Com Global Services for assistance.

Purchase Value-Added Services

To enhance response times or extend warranty benefits, contact 3Com or your authorized 3Com reseller. Value-added services like 3Com ExpressSM and GuardianSM can include 24x7 telephone technical support, software upgrades, onsite assistance or advance hardware replacement. Experienced engineers are available to manage your installation with minimal disruption to your network. Expert assessment and implementation services are offered to fill resource gaps and ensure the success of your

networking projects. More information on 3Com maintenance and Professional Services is available at <http://www.3com.com/>

Contact your authorized 3Com reseller or 3Com for a complete list of the value-added services available in your area.

Troubleshoot Online

You will find support tools posted on the 3Com web site at <http://www.3com.com/>

3Com Knowledgebase helps you troubleshoot 3Com products. This query-based interactive tool is located at <http://knowledgebase.3com.com> and contains thousands of technical solutions written by 3Com support engineers.

Access Software Downloads

Software Updates are the bug fix / maintenance releases for the version of software initially purchased with the product. In order to access these Software Updates you must first register your product on the 3Com web site at <http://eSupport.3com.com/>.

First time users will need to apply for a user name and password. A link to software downloads can be found

at <http://eSupport.3com.com/>, or under the Product Support heading at <http://www.3com.com/>

Software Upgrades are the software releases that follow the software version included with your original product. In order to access upgrades and related documentation you must first purchase a service contract from 3Com or your reseller.

Telephone Technical Support and Repair

To obtain telephone support as part of your warranty and other service benefits, you must first register your product at <http://eSupport.3com.com/>

Warranty and other service benefits start from the date of purchase, so it is important to register your product quickly to ensure you get full use of the warranty and other service benefits available to you.

When you contact 3Com for assistance, please have the following information ready:

- Product model name, part number, and serial number
- Proof of purchase, if you have not pre-registered your product
- A list of system hardware and software, including revision level
- Diagnostic error messages
- Details about recent configuration changes, if applicable

To send a product directly to 3Com for repair, you must first obtain a return authorization number (RMA). Products sent to 3Com, without authorization numbers clearly marked on the outside of the package, will be returned to the sender unopened, at the sender's expense. If your product is registered and under warranty, you can obtain an RMA number online at <http://eSupport.3com.com/>. First time users will need to apply for a user name and password.

Contact Us

3Com offers telephone, e-mail and internet access to technical support and repair services. To access these services for your region, use the appropriate telephone number, URL or e-mail address from the list below.

Telephone numbers are correct at the time of publication. Find a current directory of support telephone numbers posted on the 3Com web site at <http://csoweb4.3com.com/contactus/>

Country	Telephone Number
Asia, Pacific Rim Telephone Technical Support and Repair	
Australia	1 800 678 515
Hong Kong	800 933 486
India	+61 2 9424 5179 or 000800 6501111
Indonesia	001 803 61 009
Japan	00531 616 439 or 03 3507 5984
Malaysia	1800 801 777
New Zealand	0800 446 398
Pakistan	+61 2 9937 5083
Philippines	1235 61 266 2602 or 1800 1 888 9469
P.R. of China	800 810 3033
Singapore	800 6161 463
S. Korea	080 333 3308
Taiwan	00801 611 261
Thailand	001 800 611 2000

You can also obtain support in this region using the following e-mail: apr_technical_support@3com.com

Or request a repair authorization number (RMA) by fax using this number: +65 543 6348

Europe, Middle East, and Africa Telephone Technical Support and Repair

From anywhere in these regions, call: +44 (0)1442 435529

From the following countries, you may use the numbers shown:

Country	Telephone Number
Austria	01 7956 7124
Belgium	070 700 770
Denmark	7010 7289
Finland	01080 2783
France	0825 809 622
Germany	01805 404 747
Hungary	06800 12813
Ireland	1407 3387
Israel	1800 945 3794
Italy	199 161346
Luxembourg	342 0808128
Netherlands	0900 777 7737
Norway	815 33 047
Poland	00800 441 1357
Portugal	707 200 123
South Africa	0800 995 014
Spain	9 021 60455
Sweden	07711 14453
Switzerland	08488 50112
U.K.	0870 909 3266

You can also obtain support in this region using the following URL: <http://emea.3com.com/support/email.html>

Country	Telephone Number
Latin America Telephone Technical Support and Repair	

From the Caribbean, Central and South America, call:

Country	Telephone Number
Antigua	1 800 988 2112
Argentina	0 810 444 3COM
Aruba	1 800 998 2112
Bahamas	1 800 998 2112
Barbados	1 800 998 2112
Belize	52 5 201 0010
Bermuda	1 800 998 2112
Bonaire	1 800 998 2112
Brazil	0800 13 3COM
Cayman	1 800 998 2112
Chile	AT&T +800 998 2112
Colombia	AT&T +800 998 2112
Costa Rica	AT&T +800 998 2112
Curacao	1 800 998 2112
Ecuador	AT&T +800 998 2112
Dominican Republic	AT&T +800 998 2112
Guatemala	AT&T +800 998 2112
Haiti	57 1 657 0888
Honduras	AT&T +800 998 2112
Jamaica	1 800 998 2112
Martinique	571 657 0888
Mexico	01 800 849CARE
Nicaragua	AT&T +800 998 2112
Panama	AT&T +800 998 2112
Paraguay	54 11 4894 1888
Peru	AT&T +800 998 2112
Puerto Rico	1 800 998 2112
Salvador	AT&T +800 998 2112
Trinidad and Tobago	1 800 998 2112
Uruguay	AT&T +800 998 2112
Venezuela	AT&T +800 998 2112
Virgin Islands	57 1 657 0888

Country	Telephone Number
You can also obtain support in this region using the following:	
Spanish speakers, enter the URL: http://lat.3com.com/lat/support/form.html	
Portuguese speakers, enter the URL: http://lat.3com.com/br/support/form.html	
English speakers in Latin America should send e-mail to: lat_support_anc@3com.com	
US and Canada Telephone Technical Support and Repair	
1 800 876 3266	

B SAFETY INFORMATION

Important Safety Information

Please refer to the safety information found in the *3Com Switch Family Safety and Regulatory Information* manual included with this product.

You can find the *3Com Switch Family Safety and Regulatory Information* manual on the product CD-ROM that was included with your switch. You can also download the safety manual from the 3Com Web site: **www.3Com.com**



C TECHNICAL INFORMATION

Related Standards

The 3Com Baseline Switch 2250 Plus has been designed to the following standards:

Functional	ISO 8802-3, IEEE 802.3 (Ethernet), IEEE 802.3u (Fast Ethernet), IEEE 802.3ab (Gigabit Ethernet), IEEE 802.3x (Flow Control), IEEE 802.1D (Bridging)
MAC Address	4096
Safety	UL/CUL (UL60950-1, CSA22.2 No 60950-1), TUV/GS (EN60950-1), IEC60950-1
EMC Emissions	EN 55022 Class A, FCC Part 15 Subpart B Class A, ICES-003 Class A, VCCI Class A, AS/NZS 3548 Class A, CNS 13438 Class A
Immunity	EN 55024

Environmental

Operating Temperature	0–40 °C (32–104 °F)
Humidity	0–95% (non-condensing)
Standard	EN 60068 (IEC 68)—various parts

Physical

Width	440 mm (17.3 in.)
Depth	215 mm (8.5 in.)
Height	41 mm (1.6 in.) or 1U
Weight	3.1 kgs (6.83 lbs)
Mounting	Free standing, or 19 in. rack mounted using the mounting kit supplied

Electrical

Power Inlet	IEC 320
AC Line Frequency	50/60 Hz
Input Voltage	100–240 VAC
Current Rating	2 amperes (maximum)
Maximum Power Consumption	56 watts
Maximum Power Dissipation	184.3 BTU/hr



GLOSSARY

10BASE-T

The IEEE specification for 10 Mbps Ethernet over Category 3, 4 or 5 twisted pair cable.

100BASE-TX

The IEEE specification for 100 Mbps Fast Ethernet over Category 5 twisted-pair cable.

1000BASE-LX

IEEE 802.3z specification for Gigabit Ethernet over 9/125 micron core single-mode fiber cable.

1000BASE-SX

IEEE 802.3z specification for Gigabit Ethernet over two strands of 50/125 or 62.5/125 micron core multimode fiber cable.

1000BASE-T

IEEE 802.3ab specification for Gigabit Ethernet over 100-ohm Category 5, 5e or 6 twisted-pair cable (using all four wire pairs).

autonegotiation

Autonegotiation is where two devices sharing a link, automatically configure to use the best common speed. The order of preference (best first) is: 1000BASE-T full-duplex, 100BASE-TX full-duplex, 100BASE-TX half-duplex, 10BASE-T full-duplex, and 10BASE-T half-duplex. Autonegotiation is defined in

the IEEE 802.3 standard for Ethernet and is an operation that takes place in a few milliseconds. Autonegotiation must be enabled for the 1000BASE-T ports to operate at 1000 Mbps, full-duplex.

bandwidth

The information capacity (measured in bits per second) that a channel can transmit. The bandwidth of Ethernet is 10 Mbps, the bandwidth of Fast Ethernet is 100 Mbps and Gigabit Ethernet is 1000 Mbps.

category 3 cable

One of five grades of Twisted Pair (TP) cabling defined by the EIA/TIA-568 standard. Category 3 is voice grade cable and can only be used in Ethernet networks (10BASE-T) to transmit data at speeds of up to 10 Mbps.

category 5 cable

One of five grades of Twisted Pair (TP) cabling defined by the EIA/TIA-568 standard. Category 5 can be used in Ethernet (10BASE-T) and Fast Ethernet networks (100BASE-TX) and can transmit data at speeds of up to 100 Mbps. Category 5 cabling is better to use for network cabling than Category 3, because it supports both Ethernet (10 Mbps) and Fast Ethernet (100 Mbps) speeds.

category 5e cables

One of five grades of Twisted Pair (TP) cabling defined by the EIA/TIA-568 standard. Category 5e can be used in Ethernet (10BASE-T), Fast Ethernet (100BASE-TX) and Gigabit Ethernet (1000BASE-T) networks, and can transmit data at speeds of up to 1000 Mbps.

category 6 cable

One of five grades of Twisted Pair (TP) cabling defined by the EIA/TIA-568-B standard. Category 6 can be used in Ethernet (10BASE-T), Fast Ethernet (100BASE-TX) and Gigabit Ethernet (1000BASE-T) networks, and can transmit data at speeds of up to 1000 Mbps.

client

The term used to describe the desktop PC that is connected to your network.

DHCP

Dynamic Host Configuration Protocol. This protocol automatically assigns an IP address for every computer on your network. Windows 95, Windows 98 and Windows NT 4.0 contain software that assigns IP addresses to workstations on a network. These assignments are made by the DHCP server software that runs on Windows NT Server.

Ethernet

A LAN specification developed jointly by Xerox, Intel and Digital Equipment Corporation. Ethernet networks use CSMA/CD to transmit packets at a rate of 10 Mbps and 100 Mbps over a variety of cables.

Ethernet address

See MAC address.

Fast Ethernet

An Ethernet system that is designed to operate at 100 Mbps.

Gigabit Ethernet

An Ethernet system that is designed to operate at 1000 Mbps.

full-duplex

A system that allows packets to be transmitted and received at the same time and, in effect, doubles the potential throughput of a link.

half-duplex

A system that allows packets to be transmitted and received, but not at the same time. Half-duplex is not supported for 1000 Mbps. Contrast with full-duplex.

IEEE

Institute of Electrical and Electronics Engineers. This American organization was founded in 1963 and sets standards for computers and communications.

IEEE 802.1D

Specifies a general method for the operation of MAC bridges, including the Spanning Tree Protocol.

IEEE 802.1Q

VLAN Tagging - Defines Ethernet frame tags that carry VLAN information. It allows switches to assign endstations to different virtual LANs, and defines a

standard way for VLANs to communicate across switched networks.

IEEE 802.1p

An IEEE standard for providing quality of service (QoS) in Ethernet networks. The standard uses packet tags that define up to eight traffic classes and allows switches to transmit packets based on the tagged priority value.

IEEE 802.3ad

A standard that defines link aggregation. 802.3ad is now incorporated into the relevant sections of the IEEE Std. 802.3-2002.

IETF

Internet Engineering Task Force. An organization responsible for providing engineering solutions for TCP/IP networks. In the network management area, this group is responsible for the development of the SNMP protocol.

IP

Internet Protocol. IP is a layer 3 network protocol that is the standard for sending data through a network. IP is part of the TCP/IP set of protocols that describe the routing of packets to addressed devices. An IP address consists of 32 bits divided into two or three fields: a network number and a host number or a network number, a subnet number, and a host number.

IP Address

Internet Protocol Address. A unique identifier for a device attached to a network using TCP/IP. The address is written as four octets separated with periods (full-stops), and is made up of a network section, an optional subnet section and a host section.

LAN

Local Area Network. A network of end stations (such as PCs, printers, servers) and network devices (hubs and switches) that cover a relatively small geographic area (usually not larger than a floor or building). LANs are characterized by high transmission speeds over short distances (up to 1000 meters).

Layer 2

Data Link layer in the ISO 7-Layer Data Communications Protocol. This is related directly to the hardware interface for the network devices and passes on traffic based on MAC addresses.

link aggregation

See Trunking.

MAC

Media Access Control. A protocol specified by the IEEE for determining which devices have access to a network at any one time.

MAC address

Media Access Control Address. Also called the hardware, physical, or Ethernet address. A layer 2 address associated with a particular network device.

Most devices that connect to a LAN have a MAC address assigned to them as they are used to identify other devices on a network. MAC addresses are 6 bytes long.

network

A network is a collection of computers and other computer equipment that are connected for the purpose of exchanging information or sharing resources. Networks vary in size, some are within a single room, others span continents.

ping

Packet Internet Groper. An internet utility used to determine whether a particular IP address is online. It is used to test and debug a network by sending out a packet and waiting for a response.

protocol

A set of rules for communication between devices on a network. The rules dictate format, timing, sequencing and error control.

RJ-45

A standard connector used to connect Ethernet networks. The "RJ" stands for "registered jack."

server

A computer on a network that is shared by multiple end stations. Servers provide end stations with access to shared network services such as computer files and printer queues.

SFP

Small Form Factor Pluggable (SFP) Connectors are based on an open standard that enables hot swapping of various types of fiber optic and copper-based transceivers into the host equipment.

subnet address

An extension of the IP addressing scheme that allows a site to use a single IP network address for multiple physical networks.

subnet mask

A subnet mask, which may be a part of the TCP/IP information provided by your ISP, is a set of four numbers configured like an IP address. It is used to create IP address numbers used only within a particular network (as opposed to valid IP address numbers recognized by the Internet, which must be assigned by InterNIC).

subnet

A network that is a component of a larger network.

switch

A device that interconnects several LANs to form a single logical LAN that comprises of several LAN segments. Switches are similar to bridges, in that they connect LANs of a different type; however they connect more LANs than a bridge and are generally more sophisticated.

TCP/IP

Transmission Control Protocol/Internet Protocol. This is the name for two of the most well-known protocols

developed for the interconnection of networks. Originally a UNIX standard, TCP/IP is now supported on almost all platforms, and is the protocol of the Internet.

TCP relates to the content of the data travelling through a network — ensuring that the information sent arrives in one piece when it reaches its destination. IP relates to the address of the end station to which data is being sent, as well as the address of the destination network.

traffic monitoring

Enables the monitoring of port traffic by attaching a network analyzer to one switch port, in order to monitor the traffic of other ports on the Switch.

trunking

A method which specifies how to create a single high-speed logical link that combines several lower-speed physical links.

VLAN

Virtual LAN. A collection of network nodes that share the same collision domain regardless of their physical location or connection point in the network. A VLAN serves as a logical workgroup with no physical barriers, and allows users to share information and resources as though located on the same LAN.



INDEX

Numbers

1000BASE-LX 71
1000BASE-SX 71
1000BASE-T 71
100BASE-TX 71
10BASE-T 71

A

auto IP configuration 29
 default IP address 29
 default mask 29
autonegotiation 7
autosensing 7

B

bandwidth 71

C

client 72
configuration
 overview 27
connecting
 network device 17
 SFP transceivers 18
conventions
 notice icons, About This Guide 5
 text, About This Guide 5

D

DHCP 72
Discovery 21
dynamic host control protocol See DHCP

E

Ethernet 72

F

Fast Ethernet 72
forgotten IP address 59
forgotten password 59
free-standing 14
front panel
 Link/Activity LEDs 10
 Module Active LEDs 11
 Power LED 12
 RJ-45 ports 11
 self-adhesive pads 12
 SFP ports 10
full-duplex 72

G

Gigabit Ethernet 72

H

half-duplex 72

I

IEEE 72
IETF 73
installing 13
IP address
 auto configuration 29
 modifying 29
IP defined 73

L

LAN defined 73
LED issues 60
LEDs
 Link/Activity 10
 Module Active 11
 Power 12
link aggregation 45
local area network 73

M

MAC address 73
media access control 73
monitoring traffic 49
mounting kit
 contents 13
 using 14

N

network analyzer 49
network cables
 category 3 71
 category 5 71
 category 5e 72
 category 6 72
network defined 74

P

package contents 12
panels
 front 9
 rear 12
password

- changing 32, 34
 - default (blank) 32
 - setting 28
- physical features 9
- port settings
 - configuring 43, 50, 53
- ports
 - RJ-45 11
 - SFP 8, 10
- positioning 13
- POST 16
- powering on 16
- power-on self-test *See* POST
- protocol defined 74

R

- rack-mounting 14
- rear panel
 - power supply 12
 - Recovery button 12
- resetting to factory defaults 59
- RJ-45
 - defined 74
 - ports 11

S

- server defined 74
- SFP ports 8, 10
- SFP transceivers 18
 - approved (supported) 18
 - inserting 18
 - removing 19
- spot checks 19
- subnet mask 74
- switch defined 74

T

- TCP/IP 73
 - defined 74
- traffic 75
 - monitoring 49

- troubleshooting 59
 - forgotten IP address 59
 - forgotten password 59
 - LED-related issues 60
 - POST failed 17
- trunking *See* link aggregation

U

- user name
 - default 32

V

- viewing
 - status information 27
- VLANs 35
 - creating 41
 - maximum supported 35
 - sample configurations 40

W

- Web interface
 - accessing directly 26
 - accessing using Discovery 21
 - buttons 25
 - connecting 21
 - logging on 23
 - menu 23
 - navigating 23
 - requirements for accessing 21

REGULATORY NOTICES

FCC STATEMENT

This equipment has been tested and found to comply with the limits for a Class A digital device, pursuant to part 15 of the FCC rules. These limits are designed to provide reasonable protection against harmful interference when the equipment is operated in a commercial environment. This equipment generates, uses and can radiate radio frequency energy and, if not installed and used in accordance with the instructions, may cause harmful interference to radio communications. Operation of this equipment in a residential area is likely to cause harmful interference to radio communications, in which case the user will be required to correct the interference at their own expense.

INFORMATION TO THE USER

If this equipment does cause interference to radio or television reception, which can be determined by turning the equipment off and on, the user is encouraged to try to correct the interference by one or more of the following measures:

- Reorient the receiving antenna.
- Relocate the equipment with respect to the receiver.
- Move the equipment away from the receiver.
- Plug the equipment into a different outlet so that equipment and receiver are on different branch circuits.

If necessary, the user should consult the dealer or an experienced radio/television technician for additional suggestions. The user may find the following booklet prepared by the Federal Communications Commission helpful:

How to Identify and Resolve Radio-TV Interference Problems

This booklet is available from the U.S. Government Printing Office, Washington, DC 20402, Stock No. 004-000-00345-4.

In order to meet FCC emissions limits, this equipment must be used only with cables which comply with IEEE 802.3.

CE STATEMENT (EUROPE)

This product complies with the European Low Voltage Directive 73/23/EEC and EMC Directive 89/336/EEC as amended by European Directive 93/68/EEC.

CSA STATEMENT

This Class A digital apparatus meets all requirements of the Canadian Interference-Causing Equipment Regulations.

Cet appareil numérique de la classe A respecte toutes les exigences du Règlement sur le matériel brouilleur du Canada.

VCCI STATEMENT

この装置は、情報処理装置等電波障害自主規制協議会（VCCI）の基準に基づくクラスA情報技術装置です。この装置を家庭環境で使用すると電波妨害を引き起こすことがあります。この場合には使用者が適切な対策を講ずるよう要求されることがあります。