

ProXpressTM

Multifunction Switch/Router Model TE100-S55

for connecting 10Base-T, 100Base-TX,
100Base-FX and ISDN links

User's Guide

First Edition - June 1, 1996

Trademarks

Copyright © 1996 TRENDware

All rights reserved, contents may be revised without prior notice.

TRENDnet ® is a registered trademark of TRENDware

Ethernet is a trademark of Xerox Corporation.

Microsoft Windows is a trademark of Microsoft Corporation.

VT100 is a trademark of Digital Equipment Corporation.

FCC warning

This equipment has been tested and found to comply with the limits for a Class A digital device, pursuant to Part 15 of the FCC Rules. These limits are designed to provide reasonable protection against harmful interference when the equipment is operated in a commercial environment. This equipment generates, uses, and can radiate radio frequency energy and, if not installed and used in accordance with the instruction manual, may cause harmful interference to radio communications. Operation of this equipment in a residential area is likely to cause harmful interference in which case the user may be required to correct the interference at his or her own expense.

Service and support

TRENDware is committed to providing customers with high quality and timely technical support worldwide.

Unlimited technical support is available to you free of charge. TRENDware support engineers are available to respond to your calls Monday through Friday, 8:30 a.m. to 5:30 p.m. Pacific Standard Time.

USA TEL 1-310-328-7795 FAX 1-310-328-7798

Bulletin Board System:

310-328-8191
(protocol: 14400, 8, N,1)

World Wide Web Site:

<http://www.trendware.com>

About this manual

This manual is the user's reference guide for the **TE100-S55** that interconnects Fast Ethernet, 10Base-T and ISDN links into a single system. It provides detailed information on the features, functions and installation of the TE100-S55.

Chapter 1 provides an overview of Fast Ethernet and Switching technology, their uses and benefits in the currently emerging computing environment, and an overview of the TE100-S55.

Chapter 2 describes the cabling rules and guidelines for integrating the TE100-S55 into a network.

Chapter 3 describes how to configure the TE100-S55 through the Out-of-band management.

Chapter 4 describes how to configure the TE100-S55 through the XPressView SNMP Management program.

Chapter 5 teaches how to identify the status LEDs of the TE100-S55 and how to isolate and solve problems.

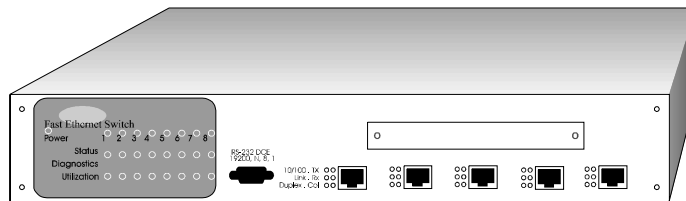

TE100-S55

Table of Contents

Chapter 1 INTRODUCTION

Fast Ethernet Technology	7
Switching Technology	8
10/100 Switching Technology	9
Benefits of Switching	9
Introducing the TE100-S55	10
Features of the TE100-S55	12

Chapter 2 GETTING STARTED

Cabling Rules and Site Preparation	13
Unpacking	16
The Front Panel	17
Mounting	18
Attaching Cables	18
Adding Optional Modules	19
Power ON	19
Software Setup	20
Checking Status LEDs	20

Chapter 3 CONFIGURING THE SWITCH

Introduction	21
Out-of-Band Management	22
Spanning Tree Algorithm	27

Chapter 4 SNMP MANAGEMENT

Installing XPressView	36
Starting XPressView	37
Operating XPressView	38
Chapter 5 DIAGNOSTICS	
Power-On Self Test	41
System Status LEDs	42
System Diagnostic LEDs	43
System Utilization LEDs	43
Port Status LEDs	44
APPENDICES	
A ~ Switch Default Setting	45
B ~ RS-232 Pin Specification	46
C ~ RJ-45 Pin Specification	47
D ~ 10Base-T Module	49
E ~ 100Base-FX/TX Module	50
F ~ ISDN Module	52
G ~ Hardware Specification	54
INDEX	56

Chapter 1 Introduction

Fast Ethernet Technology

The growing importance of LANs and the increasing complexity of desktop computing applications are fueling the needs for high performance networks. A number of high-speed LAN technologies are available to provide greater bandwidth and improve client/server response times. Among them, Fast Ethernet, also known as 100Base-T, provides the smoothest migration path for the current 10Base-T technology. The non-disruptive and smooth evolutionary nature of Fast Ethernet, plus its prevailing market acceptance, guarantees it as the most cost effective and high-performance networking solution of the future.

100Base-T networks essentially look and act like 10Base-T networks, only faster (*see Table 1-1, page 8*). 100Base-T provides 10 times the performance of 10Base-T while retaining most of the same cabling rules and the CSMA/CD media-access method. 100Base-T also uses the same packet format, packet length, error control and management information as 10Base-T. As such, 100Base-T is recognized as the true and rightful heir of 10Base-T.

For flexibility, the 100Base-T specification contains three different cabling schemes, 100Base-TX (Cat 5 UTP), 100Base-T4 (Cat 3,4 or 5 UTP) and 100Base-FX (fiber optic). 100Base-TX is probably the most popular choice since it enables users to retain their existing 10Base-T cabling infrastructure and easily migrate to Fast Ethernet.

	Ethernet	Fast Ethernet
Speed	10Mbps	100Mbps
Cost	x	2x or less
IEEE 802.3 Standard	CSMA/CD	CSMA/CD
Topology	Star or Bus	Star
Cable Supported	UTP, Coax, Fiber	UTP, Fiber
Cable Specification	10Base-T: Cat 3,4,5 UTP 10Base-2: Thin coax 10Base-F: Fiber optic	100Base-T4: Cat 3,4,5 UTP 100Base-TX: Cat 5 UTP 100Base-FX: Fiber optic
Maximum distance of UTP link	100 meters	100 meters
Collision domain diameter (maximum distance w/UTP)	500 meters	210 meters
Maximum network diameter (using switches/routers)	Unlimited	Unlimited
Media Independent Interface	Yes (AUI)	Yes (MII)
Full duplex Signaling	Yes	Yes

Table Chapter 1 -1, Ethernet vs. Fast Ethernet

Switching Technology

Another approach to pushing beyond the limits of Ethernet is the development of Switching technology. A switch works in the MAC address level, bridging multiple Ethernet segments to prevent unnecessary network traffic from passing one another. In a properly subdivided switched LAN, the net result is a full and transparent bandwidth for each segment.

Switched Ethernet vs. Legacy Ethernet is analogous to using private telephone lines vs. party lines. By connecting to a switched port, each Ethernet segment has dynamic full

performance or “wire-speed.” Therefore, a switch effectively splits a physical shared-access LAN into bridged multiple LAN segments. Each segment supports a workgroup and even provides a dedicated connection to a desktop server. The outcome is a multiplication of the overall available bandwidth and a more predictable performance under heavy network loads.

10/100 Switching Technology

Just as 100Base-T is an extension of the existing 10Base-T technology, 10/100 Switching is merely an extension of 10Base-T Switching. The 10/100 Switch provides not only the 10/100Mbps high-speed transmission rate per segment, but it also bridges 10Base-T and 100Base-T into a harmonious network.

Combining Fast Ethernet and Switching technologies, the 10/100 Switch provides enough bandwidth to satisfy the most demanding workgroups, as well as a high-speed backbone link.

Benefits of Switching

From the technical point of view, Ethernet switching technology dramatically boosts the total bandwidth of a network. It also puts configuration flexibility and bandwidth adaptability into the local workgroups where the majority of work is generated from a business operation. Switching further eliminates the congestion problem inherent to the contention oriented Ethernet CSMA/CD protocol, thereby improving predictable response times under heavy network loads. In the past, this congestion under heavy loads was alleviated using an expensive routing technology.

From the applications point of view, the new wave of object oriented distributed Client/Server applications demands higher bandwidth and tighter integration of client workstations with servers. The legacy shared-access 10Mbps Ethernet technology

can no longer provide both bandwidth and predictable response times to this new generation of workgroup computing.

From an economical point of view, Fast Ethernet switching not only satisfies both technical and business requirements, but also preserves the users' existing investment in the huge 10Base-T Ethernet installed base. This compatibility insures a path for users to add, change, and migrate to Fast Ethernet capabilities as needs arise. It also provides a low cost and flexible bandwidth solution directly to local workgroups, where the majority of work is generated and reducing the need of expensive routers that usually cater to the network backbone.

Introducing the TE100-S55

The word "flexible" best describes the characteristics of the TE100-S55 . Not only does it provide five fixed 10/100Mb ports, but it also provides an open slot for adding an 8-port 10Base-T module, a 100Base-FX/TX port or an ISDN router module. Users can hand-select the necessary modules to fit their individual needs.

With expandable switch functionality and ISDN router support, the TE100-S55 brings to the workgroup capabilities normally found in more expensive, chassis-based products. Dual-speed 10/100 configuration options also make the product ideal for integrating Fast Ethernet technology into existing 10Mbps network.

Both fixed and modular network ports on the TE100-S55 feature NWAY Auto-negotiation, to simplify installation and use. NWAY Auto-negotiation senses the network speed when cabling is inserted into the port, and automatically transmits at either 100Mbps or 10Mbps. In addition, it detects whether the device transmitting to the port is utilizing half or full-duplex signaling and configures itself without user intervention. When taking advantage of full duplex signaling, the TE100-S55 literally

doubles network throughput to 200Mbps on Fast Ethernet segments and 20Mbps on 10Base-T segments.

Although the TE100-S55 is equipped with five ports for 10Base-T or 100Base-TX connections, it also provides an open slot for add-on modules. These modules include an 8-port 10Base-T, a 100Base-FX/TX port or an ISDN router.

Module Type	Description	Common Usage
10Base-T	Eight RJ-45 ports for Cat 3, 4 or 5 UTP cable. <i>Refer to Appendix D, page 49 for more detail.</i>	Existing 10Base-T users who want to expand or segment their 10Base-T connections.
100Base-FX/TX	One MIC port for fiber optic cable plus one RJ-45 port for Cat 5 UTP cable. Although two ports are provided, only one port may be used at a time. <i>Refer to Appendix E, page 50 for more detail.</i>	Fast Ethernet users who want to connect to fiber optic backbone or expand their 100Base-TX connection.
ISDN Router (up to 128Kbps)	One RJ-11 port for ISDN phone line (two-64Kbps channels). <i>Refer to Appendix F, page 52 for more detail.</i>	Ethernet or Fast Ethernet users who want to access remote locations or internet/intranet.

Table Chapter 1 -2, Description of Add-on Modules

Features of TE100-S55

Utilizing the latest Fast Ethernet and Switching technologies, the TRENDnet TE100-S55 is designed to provide:

- Five 10/100Mbps dual-speed Ethernet ports
- One expansion slot with multiple configuration options:
 - 8 switched ports for 10Base-T OR
 - 2 switched port for 100Base-FX/TX OR
 - 1 ISDN router (up to 128Kbps)
- NWAY Auto-negotiation for each network port providing auto-detection of connected cable type, auto-sensing of full or half duplex signaling and auto-configuration.
- Full or half-duplexing.
- Store-and-forward packet switching.
- The IEEE 802.1d Spanning Tree Algorithm for network loop detection and prevention and topology re-configuration.
- Native SNMP management support with Ethernet MIB II (RFC 1284) and bridge MIB (RFC 1286).
- Dynamic, automatic self-learning network configuration that is refreshed every three minutes for maximum performance.
- VLAN support.
- 4,096 maximum entries for MAC Address Table.
- One RS-232 port for local/remote Out-of-Band management.
- The EEPROM (flash memory) for firmware upgrade.
- Comprehensive LED display of the system/port status.
- Self-test during power on to ensure system integrity.

Chapter 2 Getting Started

Cabling Rules and Site Preparation

Although 100Base-T and 10Base-T are alike in many aspects, there are slight differences in the cabling rules. So, spend some time in locating and reconfiguring your cabling structure for the best network layout.

The key cabling rules for 100Base-TX are:

- The 100Base-TX specification requires two-pair Category 5 UTP or two-pair Type 1 STP cable.
- The maximum cable length from an end-station to a hub or repeater is 100 meters.
- The maximum number of repeater¹ hops allowed is two.
- The maximum network diameter is 210 meters: two segments of 100 meters with two repeaters/hubs no farther apart than 10 meters are allowed.
- Switches are not considered as a repeater. Therefore, there are no limitation to repeater hops or to the network diameter distance. However, the maximum cable length from an end-station to a switch still remains at 100 meters.

¹ A single or a stacked 100Mbps hub is counted as one repeater. A switch is not counted as a repeater, but is treated as an end-station when applying the topology rules.

The TE100-S55 fits into the 100Base-T cabling architecture as a switch. Therefore, unlimited number of switches may be installed in the same network with maximum distances of 100 meters apart. The 10/100Mb ports of TE100-S55 require two-pair Cat5 UTP (or Type 1 STP) for 100Base-TX connections. For 10Base-T connections, two-pair Cat 3, 4 or 5 UTP cables are required.

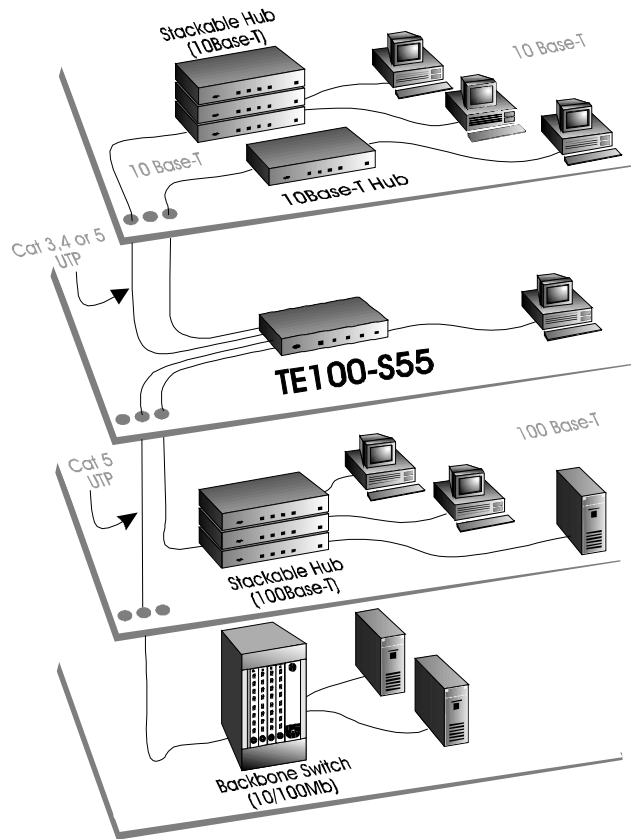

Figure Chapter 2 -1, Example of TE100-S55 wiring environment

Careful planning and site preparation are the keys to success for installing Fast Ethernet switches. Users should perform a network bandwidth analysis based on their workgroup network traffic needs and examine their workstation equipment for other performance bottlenecks.

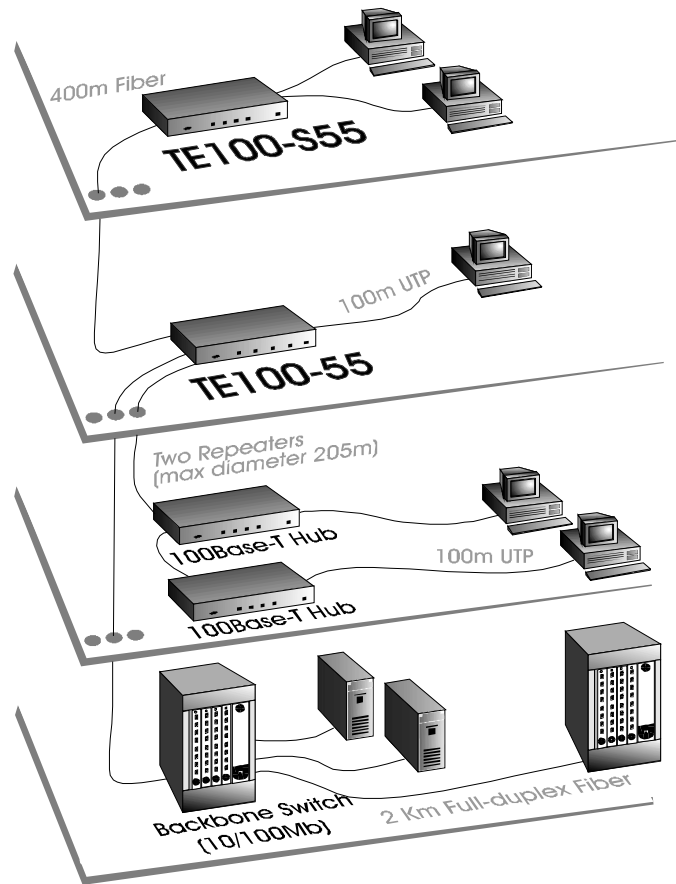

Figure Chapter 2 -2, 100Base-T cabling rules

Unpacking and Setup

Now that you have a good understanding of the basic cabling rules, as well as your own network environment, you're ready to integrate the TE100-S55 into the network.

The following sections describe how to install, connect and setup your new TE100-S55 .

UNPACKING

The TE100-S55 shipping carton should contain the following items:

- 1 TE100-S55 unit
- 1 AC power cord
- 2 Mounting brackets
- 1 RS-232 serial cable (6 ft)
- This User's Guide

If any item is found missing or damaged, please contact your local TRENDware reseller for replacement.

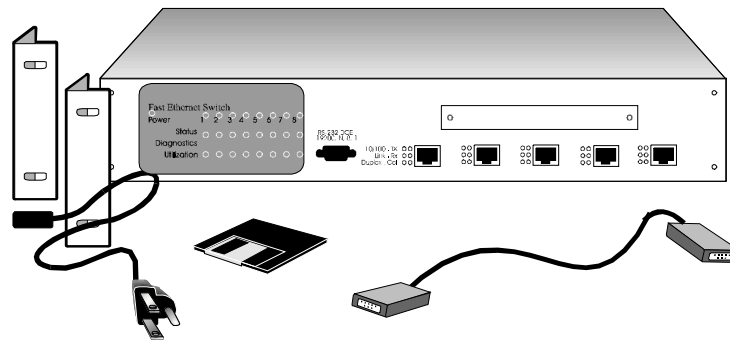

Figure Chapter 2 -3, Contents of the TE100-S55 Package

THE FRONT PANEL

The TE100-S55 features following items on its front panel:

- (A) Five RJ-45 ports for 10Base-T or 100Base-TX links
- (B) An expansion slot with multiple configuration options:
 - (b1) 8-port 10Base-T Switch OR
 - (b2) 2-port 100Base-FX/TX Switch OR
 - (b3) 1-port ISDN router
- (C) One RS-232, DB9 Out-of-Band management port
- (D) Eight system status LEDs
- (E) Eight system diagnostic LEDs
- (F) Eight system utilization LEDs
- (G) Six status LEDs for each port
- (H) Power Status LED

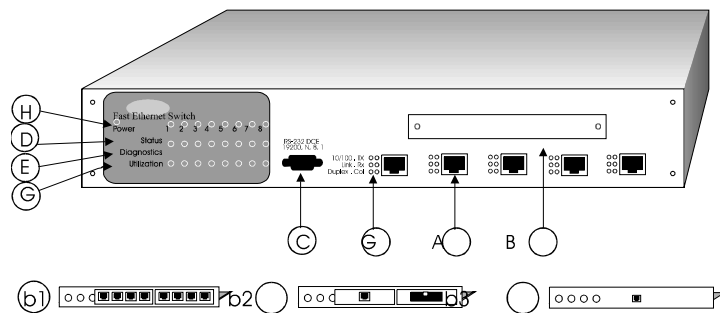

Figure Chapter 2 -4, Front panel of the TE100-S55

MOUNTING

The TE100-S55 can be placed either on a table or rack mounted. For rack mounting: First screw the pair of mounting brackets (included in the packing carton) onto the switch. Then, mount the TE100-S55 onto the rack, as shown below in *Figure 2-5*.

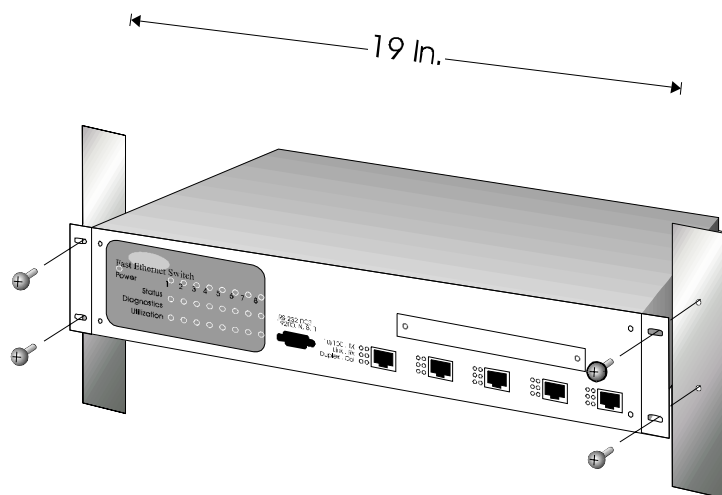

Figure Chapter 2 -5, Rack mounting a TE100-S55

ATTACHING CABLES

There are five RJ-45 ports on the TE100-S55 for connecting five workstations or LAN segments. Each port supports either 10Base-T or 100Base-TX networks, auto-detecting the type of connection. For 100Base-TX connection, two-pair Category 5 UTP (or Type 1 STP) cabling is required. For the 10Base-T connection, two-pair Category 3, 4 or 5 UTP is required.

If you are connecting workstations to the TE100-S55, use a standard UTP cable with a straight RJ-45 pin layout. If you are connecting hubs, bridges or other switches to the TE100-S55, the Transmit (TD) and the Receive (RD) wires must be crossed-over at one end of the connector. Please refer to *Appendix C, page 47* for the details of pin layout.

ADDING OPTIONAL MODULES

Although the TE100-S55 is equipped with five ports for 10Base-T or 100Base-TX connections, it also provides an open slot for add-on modules. These modules include an 8-port 10Base-T, a 100Base-FX/TX port or an ISDN router.

To install add-on modules, simply unscrew and remove the slot cover from the front panel of the TE100-S55. Slide-in and screw the add-on module into the open slot of the TE100-S55. Afterwards, attach the appropriate LAN or WAN connections to each module.

Please refer to *Appendix D~F (page 49-53)* for more details on each add-on module and its installation process.

POWER ON

The TE100-S55 can be used with AC power sources, 90 - 250 VAC, 50 - 60 Hz. The internal power supply will adjust to the local power source automatically.

You may turn ON the power of the TE100-S55 with or without attaching LAN connections to the switch. You should observe the LEDs as the Switch is going through the Power-On Self Test (POST) sequence. All system Status LEDs should go off, and the Power LED should go on, when the POST is successful. The corresponding **Link** LED will be turned on when a LAN segment is connected to the port and functioning normally.

SOFTWARE SETUP

The default settings of TE100-S55 (shown in *Appendix A, page 45*) should be sufficient in the majority of installations. If a different setting is required for your specific environment, please refer to *Chapter 3, page 21* for “Out-of-Band Management” or *Chapter 4, page 35* for “SNMP Management”.

For simple management, you can perform the Out-of-Band Management and access the TE100-S55 through its RS-232 port. For elaborate SNMP management, you can run the XPressView program from any network station.

CHECKING STATUS LEDs

When the power is first turned on, TE100-S55 performs a Power-On Self Test (POST). Please observe the status LEDs for verification of proper installation (*for more detail, refer to Chapter 5, page 41*). These status LEDs also provide information about the system unit and its connected Ethernet or Fast Ethernet LAN segments, during normal operation.

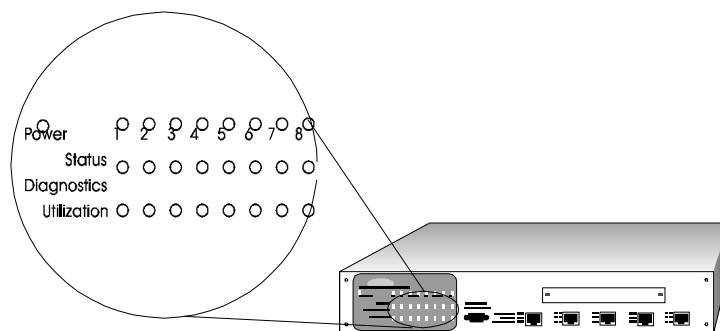

Figure Chapter 2 -6, TE100-S55 status LEDs

Chapter 3 **Configuring the Switch**

Introduction

The TE100-S55 is designed to operate with or without the aid of extensive network management software. For simple management, you can run a terminal emulation program and access the TE100-S55 through its RS-232 port. For elaborate SNMP management, you can run the XPressView program from any network station. Chapter 4 describes the details of how to install and utilize the XPressView SNMP Management program.

Out-of-Band Management is the vehicle to access TE100-S55 locally or remotely via its RS-232 serial port. Through this port, you can set up, monitor or modify the TE100-S55 configuration.

Out-of-Band Management

ATTACHING TO THE RS-232 PORT

The TE100-S55 can be configured using the Out-of-Band Management function. To begin, you must first connect a PC (or a terminal) directly to TE100-S55 using the supplied RS-232 serial cable.

The RS-232 port is a DCE with a 9-pin female connector. *Figure Chapter 3 -1* shows the cable connection to a DTE such as a PC running VT100 terminal emulation software or an actual VT100 terminal. The switch-to-terminal (DCE/DTE) serial communication speed is preset at 19,200 baud.

Refer to *Appendix B* for detailed pin specifications of the RS-232 port.

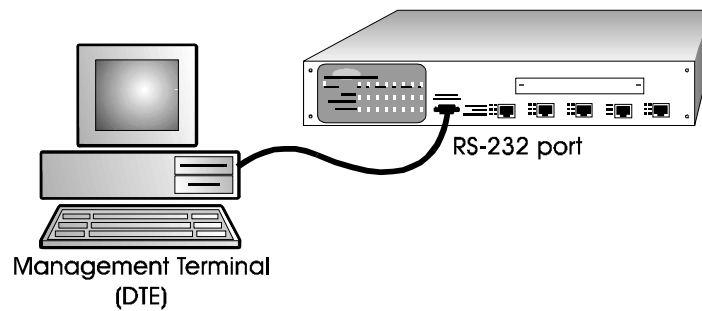

Figure Chapter 3 -1, RS-232 connection to a local terminal

VT100 TERMINAL

Once you've connected a PC (or terminal) to the RS-232 port of the TE100-S55, you can begin the VT100 terminal emulation process. The VT100 terminal emulation software can be found in Microsoft Windows or any other communication software.

Table 3-1 describe the necessary settings for your PC or terminal connection to TE100-S55.

Terminal Step	VT100 Compatible terminal	PCVT100 terminal emulation
Communication software	Turn on the machine and login as VT100 terminal	Run the VT100 Terminal emulation software / This software can be found in MS Windows (Accessory section)or other communication software
DCE/DTE line setting	19,200 Baud, 8 N 1 (hardware setting)	19,200 Baud, 8 N 1 (through the Terminal software)
PC COM port hardware setting	N/A	Refer to PC COM port hardware and Software setup guidelines
Assigning control keys to a non-VT100 system software environment	N/A	If your keyboard does not respond properly within the MS Terminal Emulation program, go to the Terminal Preference menu and Deselect the "Use function, arrow, Ctrl keys for Windows" option; or refer to specific terminal emulation software

Table Chapter 3 -1, VT100 Terminal Emulation Settings

Upon a successful execution of terminal emulation, your computer will establish communication with the TE100-S55 and allow you to view or modify the following settings.

Control Settings	System display	User selection
Switch Configuration	Switch Version No.	V1.10 (Fixed)
	Switch IP Address	168.8.xx.xx
	Switch Subnet Mask	255.255.0.0
	Default Gateway	0.0.0.0
	Switch MAC Addr.	Factory preset (Fixed)
	Save change	F2 key
	Exit	F4 key
Port Configuration	Port/x State	Enable (or Disable)
	Port/x Physical	Auto (or 100/Half, 100/Full, 10/Half, 10/Full)
	Port/x State	Block, Learning, Listening, Forwarding, Disable (Fixed)
	Port/x Priority	0 (Hi) - 255 (Low)
Spanning Tree Configuration	Enable / Disable	Enable (or Disable)
	Bridge (switch) Priority	32768
	Root Cost	(Reflected STA result)
	Hello Time	10 sec. (range: 1 - 10 sec.)
	Forward Delay Time	30 sec. (range: 4 - 30 sec.)
	Max Age Time	40 sec. (range: 6 - 40 sec.)
	Root Bridge	(MAC addr. of Root Bridge)
	Root Port	(Reflected STA result)
Down-load new system firmware	Y / N	Space Key (toggle)
	Exit	F4 key
Load factory default parameters	Y / N	Space Key (toggle)
	Exit	F4 key
Filtering Data Base	Port Number	1 ~ 5
	Port State	Disable (or Forwarding, Blocking)
	MAC address	Up to 16 MAC addresses

Table Chapter 3 -2, TE100-S55 Settings for Out-of-Band management

USER-SELECTIVE PARAMETERS

The TE100-S55 is factory set with a unique Ethernet MAC address. Except for the MAC address, Version Number and Port State, all parameters in *Table 3-2* can be modified.

From the *Switch Configuration menu*, you can change the **IP Address** of TE100-S55 to match the TCP/IP environment of your network. The Gateway Address may also be changed to match the Gateway of your network.

From the *Port Configuration menu*, you can Enable/Disable each port connection, and prioritize them (ranges from 0 to 255). The priority level, in conjunction with the preset port ID, is used under the Spanning Tree Algorithm to determine the “Root Port”. The **Port State** parameter corresponds to the Enable/Disable port settings and the dynamic changes in routing paths of the surrounding network. The Port State may show message Blocking, Learning, Listening, Forwarding or Disable, at any given time.

The **Port Physical** setting defaults to AUTO, but you can change it to 100Mb half duplex, 100Mb full duplex, 10Mb half duplex, or 10Mb full duplex mode. Although optional, the AUTO setting is recommended since it employs the NWAY Auto-negotiation feature of the TE100-S55, automatically detecting and selecting the optimum cable speed (10 or 100Mb) and signaling type (full or half duplex) for each port. When taking advantage of full duplex signaling, the TE100-S55 literally doubles network throughput to 200Mbps on Fast Ethernet segments and 20Mbps on 10Base-T segments.

From the *Spanning Tree Configuration menu*, you can Enable/Disable the STA function, change the switch priority and various timers. The STA functions and parameters are discussed in full detail on page 27.

From the *Down-load New System Firmware menu*, you can upgrade the TE100-S55 with the latest firmware (if revision is available). The XMODEM function will guide you in downloading the firmware code into the TE100-S55. To acquire the revised firmware file, please contact TRENDware technical support.

From the *Load Factory Default Parameters menu*, you can replace all parameter modifications for TE100-S55 with the original default settings.

From the *Filtering Data Base menu*, you can Disable, Forward or Block up to 16 MAC addresses for each port on the TE100-S55. This feature allows you to create a virtual LAN, filtering each segment for added performance.

Spanning Tree Algorithm

In a more complex network environment, devices may physically be connected in a loop, causing network failure due to the infinite transfer of packets. In anticipation of such perplexity, the TE100-S55 is designed to support the Spanning Tree Algorithm (STA). Using STA, the TE100-S55 will prevent network loops by logically designating a single path for each connection, as well as establishing a backup path in case of a path failure.

Specifically, Spanning Tree Algorithm (STA) provides the following services:

- **Network loop detection and prevention** - Only one path is allowed between any two switch/bridge segments. If there are multiple paths, forwarded packets may loop indefinitely and result in serious network failure. When STA detects a loop, it activates the path with the lowest “path cost”, while blocking the other paths.
- **Automatic topology re-configuration** - If an active path fails, the backup path will be automatically activated, and the STA will auto-configure the network topology.

In a simple network where there is no possibility of network looping, you may *disable* the STA function. However, if the possibility of network loops exist, just leave the STA *enabled* along with other switches/bridges in the network. The TE100-S55 will interact with other switches/bridges to dynamically establish forwarding paths within the network.

Subsequently, the TE100-S55 may be referred to as a bridge. Since a switch is analogous to a bridge, the STA rules of a bridge applies equally to the TE100-S55.

You can view or modify the STA parameters through the Out-of-Band Management, as shown in *Table 3-3*. Pay special attention to the effects of each STA parameter in order to avoid erroneous behavior in the network.

STA parameters	Settings	Effects	Comment
Enable/Disable	Enable / Disable	Participate in or remove from STA	Enable in a SNMP network
Bridge Priority	lower the #, higher the priority	Increases chance of becoming the Root Bridge	Avoid, if the switch is used in workgroup level of a large network
Hello Time	1 - 10 sec.	No effect, if not Root Bridge	Never set greater than Max. Age Time
Max. Age Time	6 - 40 sec.	Compete for Root Bridge, if BPDU is not received	Avoid low number for unnecessary reset of Root Bridge
Forward Delay	4 - 30 sec.	High # delays the change in state	Max. Age $\leq 2 \times$ (Forward Delay - 1) Max. Age $\geq 2 \times$ (HelloTime + 1)
Port Level STA parameters			
Enable / Disable	Enable / Disable	Enable or disable this LAN segment	Disable a port for security or problem isolation
Port Priority	lower the #, higher the priority	Increases chance of become Root Port	

Table Chapter 3 -3, User-selective STA parameters

STA operates at two levels, the **Switch** and the **Port** level. In addition, STA uses several timers to periodically ensure the integrity of switches/bridges and their ports in a network.

The following paragraphs introduce the key information and terminology needed to understand the STA parameters. Please note that the word “bridge” now refers to TE100-S55.

AT THE BRIDGE LEVEL

Root Bridge: A network must first establish a starting point from which all data forwarding path values are calculated, compared, and determined. The Root Bridge is the unit with the lowest Bridge Identifier¹ (Bridge Priority + MAC address).

Bridge Priority: This is a user changeable parameter. This parameter enables all bridges in the network to establish a Root Bridge. A change to the Bridge Priority may cause the network to re-establish a new Root Bridge. A high Bridge Priority increases the chance for a bridge to be selected as the Root Bridge (the smaller the number, the higher the priority).

Root Path Cost: From each bridge, Root Path Cost is the total Path Cost of reaching the Root Bridge from a Designated Bridge. A Root Bridge has Root Path Cost of 0.

Designated Bridge: From each LAN segment, the bridge that has the lowest Root Path Cost to the Root Bridge becomes the Designated Bridge. It forwards data packets for that LAN segment. In case all bridges on a segment have the same Root Path Cost, the bridge with the lowest Bridge Identifier becomes the Designated Bridge.

¹ The bridge MAC address is only used to decide the Root Bridge when there are 2 or more bridges with the same Bridge Priority.

AT THE PORT LEVEL

Designated Port: This is the port on each Designated Bridge that forwards data packets for the attached LAN segment.

Root Port: Each bridge has a Root Port that has the lowest Path Cost to the Root Bridge. In case there are several ports with the same Path Cost, the one with the lowest Port Identifier (Port Priority + pre-assigned Port ID) becomes the Root Port¹.

Port Priority: This is a user changeable parameter for each port on the bridge. In conjunction with a pre-set port ID, this parameter determines the Root Port of a Bridge.

Path Cost: This parameter is fixed² and will not be shown. The 100Mb segments will have auto-assigned Path Cost of 10, while the 10Mb segments will have auto-assigned Path Cost of 100.

¹ In a bridge, a port is Blocked, if it is not a Root or a Designated Port.

² This is a changeable parameter, based on the STA specification. However, it is fixed by the TE100-S55 implementation.

TIMERS

Max. Age Time: This is a user changeable parameter. Should a Bridge fail to receive an identifier packet from its Root Bridge within this time limit, it assumes that the Root Bridge has failed. Therefore, a new Root Bridge will be established for the network.

Hello Time: This is a user changeable parameter. Should a Bridge be assigned as a Root Bridge, the Hello Time setting will be used as the interval to send out identifier packets to notify other Bridges of its existence. The Hello Time must be less than the Max. Age Time, or else a configuration error will occur.

Forward Delay: This is a user changeable parameter. This is the delay time that each port on a Bridge waits in the Listening state before changing its Blocking state to the Forwarding state.

ILLUSTRATION OF STA

A simple illustration of three Bridges (or TE100-S55) connected in a loop is depicted in *Figure 3-2*. In this example, you can anticipate some major network problems if the STA assistance is not applied. For instance, if Bridge 1 broadcasts a packet to Bridge 2, Bridge 2 will broadcast it to Bridge 3, and Bridge 3 will broadcast it to Bridge 1...and so on. The broadcast packet will be passed indefinitely in a loop, causing a serious network failure.

To alleviate network loop problems, STA can be applied as shown in *Figure Chapter 3 -3*. In this example, STA breaks the loop by blocking the connection between Bridge 1 and 2. The decision to block a particular connection is based on the STA calculation of the most current Bridge and Port settings. Now, if Bridge 1 broadcasts a packet to Bridge 3, then Bridge 3 will broadcast it to Bridge 2 and the broadcast will end there.

STA setup can be somewhat complex. Therefore, you are advised to keep the default factory settings and STA will automatically assign root bridges/ports and block loop connections. However, if you need to customize the STA parameters, refer to *Table 3-3* on page 28.

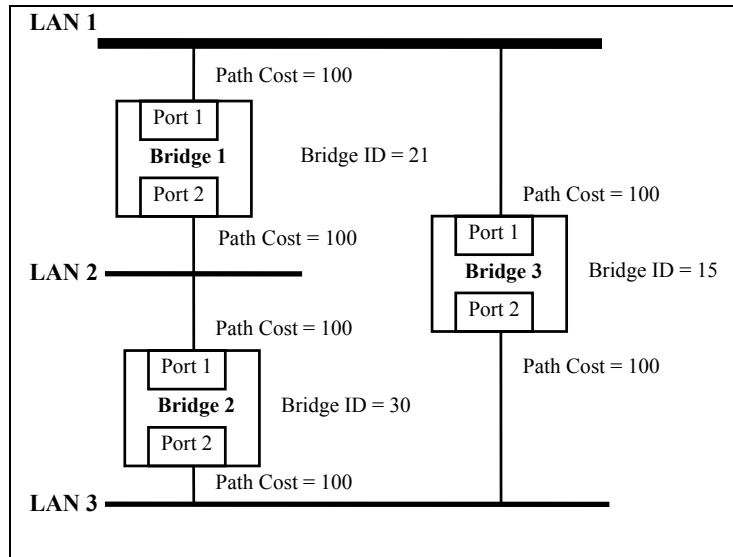

Figure Chapter 3 -2, Before Applying the STA Rules

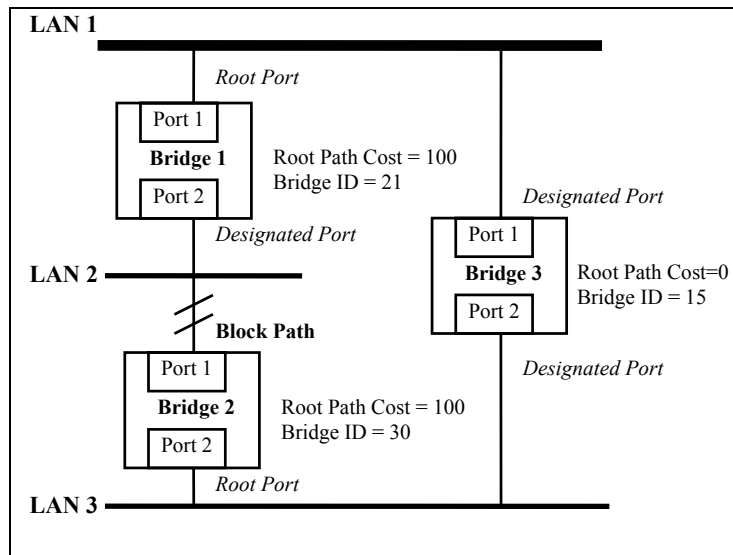

Figure Chapter 3 -3, After Applying the STA Rules

Chapter 4 **SNMP Management**

For basic setup of the TE100-S55, use the out-of-band management functions as described in Chapter 3. However, for a user-friendly graphic interface to your TE100-S55 setup, you can use the XPressView SNMP Management program.

The XPressView program permits you to view or modify the TE100-S55 configuration and its network activities. Specifically, it allows you to do the following management functions:

- Enable/Disable each Port State.
- View the Switch Configuration.
- Modify the parameters for Spanning Tree Algorithm.
- Monitor the incoming and outgoing network traffic.

Installing XPressView

Installing the XPressView SNMP Management program is easy to do and only takes a few minutes. The supplied SETUP program guides you through the process.

WHAT YOU NEED

To use XPressView, your computer must have the following:

Processor:	386, 486 or Pentium
RAM:	2 megabytes minimum
Disk Space:	10 megabytes minimum
Windows:	3.1, 3.11 or Win95
TCP/IP	Winsock interface (It is recommended to set the IP address at 168.8.xx.xx, similar to the TE100-S55 IP address)
Drive:	1.44 Floppy
Display:	VGA

TO INSTALL XPRESSVIEW

- Run Windows and close all programs that are active.
- Insert the supplied XPressView diskette into your floppy drive.
- From Windows Program Manager or Explorer, click the floppy drive that contains XPressView, and click the SETUP command. The setup screen will appear. Accept or modify the Destination Directory and click NEXT.
- The XPressView program icon will automatically be added to your Windows start screen.

Starting XPressView

After you install the XPressView program, you are ready to begin SNMP management of your TE100-S55.

- From Windows start screen, click the XPressView icon. The Welcome screen will appear.

START FROM SCRATCH

If this is your first time to run the XPressView program, you will need to create an environment that represents the TE100-S55.

- Click the AUTO DISCOVERY icon. 
- Enter the range of IP addresses to search and XPressView will auto-detect all of the TE100-S55 switches in your network.

Discovery				
IP Address Range				
Start IP Address	<input type="text"/>	<input type="text"/>	<input type="text"/>	<input type="text"/>
Stop IP Address	<input type="text"/>	<input type="text"/>	<input type="text"/>	<input type="text"/>

***As an option, you can click the DEVICE icon and manually type each IP address of your TE100-S55.*

- For future use, save this environment by going to the NETWORK menu and clicking the SAVE command.

NOTE: Each switch must have a unique IP address in order to communicate with the network manager. The factory default IP address of each TE100-S55 is 168.8.xxx.xxx. The last two bytes of the IP address are identical to the last two bytes of the MAC address, which is displayed on the back of each TE100-S55. The MAC address can also be referenced through out-of-band management (*see chapter 3, page 24*).

OPEN AN EXISTING ENVIRONMENT

To open an existing environment, go to the NETWORK menu and click the OPEN command. Choose the appropriate file name and click the OK command. Your screen will display the list of TE100-S55 icons and will allow management of these devices.

Operating XPressView



Once you create or open an environment, you are ready to view or modify the TE100-S55 configuration and its network activities.

SELECT A DEVICE

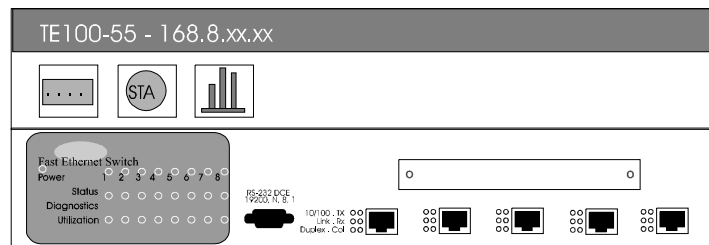
From the main screen, click the TE100-S55 icon and the management menu will appear.



From the management menu, choose a port by clicking the port-icon. Afterwards, choose the management function by clicking one of the management-icon:

-  View/Modify the Switch Configuration.
-  Modify the parameters for Spanning Tree Algorithm.
-  Monitor the incoming and outgoing network traffic.

VIEW/MODIFY SWITCH CONFIGURATION

If you click a port and then click the “Switch Configuration” icon, the following screen will appear, allowing you to Enable or Disable the selected port.

Port Configuration	
IP Address: 168.8.xx.xx	
State	
<input type="radio"/> Enable Mask	<input type="radio"/> Disable
<input type="button" value="Set"/>	<input type="button" value="Cancel"/>

However, if you click the “Switch Configuration” icon without clicking a port, the following screen will appear allowing you to view the IP, Subnet mask and MAC addresses.

Switch Configuration	
IP Address: 168.8.xx.xx	
Configuration	
Subnet Mask	255.255.0.0.
MAC Address	xx xx xx xx xx xx

MODIFY THE SPANNING TREE ALGORITHM

If you click a port and then click the “STA” icon, the Port STA screen will appear, allowing you to modify the port priority.

However, if you click the “STA” icon without clicking a port, the following screen will appear, allowing you to modify the Bridge Priority, Max, Hello and Forward parameters.

Bridge Spanning Tree Algorithm	
IP Address: 168.8.xx.xx	
Bridge Priority	<input type="text"/>
Bridge Max	<input type="text"/> sec
Bridge Hello	<input type="text"/> sec
Bridge Forward	<input type="text"/> sec

MONITOR NETWORK TRAFFIC

When you click the “Monitor Network Traffic” icon, a query control screen will appear, allowing you to choose the type of packets to monitor. Click the packet types from the OID List, and then click one of the Display types (text or graphic).

Query Control
IP Address: 168.8.xx.xx

Port	OID List	Display Type
<input type="radio"/> 1	<input type="checkbox"/> Rx Bytes	<input type="radio"/> <input type="radio"/>
<input type="radio"/> 2	<input type="checkbox"/> Rx Ucast Packets	Operation
<input type="radio"/> 3	<input type="checkbox"/> Rx NUcast Packets	<input type="text"/>
<input type="radio"/> 4	<input type="checkbox"/> Rx Discards	Polling
<input type="radio"/> 5	<input type="checkbox"/> Rx Errors	<input type="text"/> sec
	<input type="checkbox"/> Tx Bytes	
	<input type="checkbox"/> Tx Ucast Packets	
	<input type="checkbox"/> Tx NUcast Packets	
	<input type="checkbox"/> Tx Discards	
	<input type="checkbox"/> Tx Errors	

Display in TEXT format

Statistics
IP Address: 168.8.xx.xx

	Absolute Count	Delta Count
Rx Bytes		
Rx Ucast Packets		
Rx NUcast Packets		
Rx Discards		
Rx Errors		
Tx Bytes		
Tx Ucast Packets		
Tx NUcast Packets		
Tx Discards		
Tx Errors		

Display in GRAPHIC format

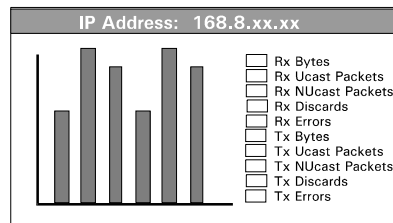

Chapter 5 **Diagnostics**

Power-On Self Test

A Power-On Self Test (POST) sequence takes place when the TE100-S55 is first turned on (cold boot). Software reset (warm boot) through the RS-232 port does not prevent unauthorized remote re-boots.

The POST sequence checks the system integrity by performing the following tests:

- System boot
- RAM test
- Timer and interrupt controller tests
- Cache controller test
- RS-232 diagnostic port test
- BIOS test
- EEPROM checksum test
- Program load checksum test
- Ethernet ports test

Besides the Power On/Off LED, there are eight system Status LEDs used to display the results of these tests during the POST sequence. The LED status further display test results in two categories, the System test and the Port test. Any errors from the System tests means that the Switch failed to function. Any error(s) from the Port test effects that individual port and the remaining ports will be operational.

System Status LEDs

TE100-S55 is equipped with eight Status LEDs which reflect the Power-On Self Test results. If there is a system error, the Status LED **2** light will be ON and the LEDs **5-8** will display the error code.

Although some errors may be resolved easily, some errors may require that the unit be returned to TRENDware reseller for repair.

System error LED		Error Status	Action
Off - ①②③	④⑤⑥⑦⑧		
On - ①②③	④⑤⑥⑦⑧		
①②③	④⑤⑥⑦⑧	No error	Normal
①②③	④⑤⑥⑦⑧	Boot	Record LED error code and contact technical support
①②③	④⑤⑥⑦⑧	RAM	Record LED error code and return the unit.
①②③	④⑤⑥⑦⑧	Interrupt controller	Record LED error code and return the unit.
①②③	④⑤⑥⑦⑧	Timer controller	Record LED error code and return the unit.
①②③	④⑤⑥⑦⑧	Cache controller	Record LED error code and return the unit.
①②③	④⑤⑥⑦⑧	RS-232 port	Record LED error code and return the unit.
①②③	④⑤⑥⑦⑧	BIOS	Record LED error code and contact technical support
①②③	④⑤⑥⑦⑧	EEPROM	Record LED error code and contact technical support
①②③	④⑤⑥⑦⑧	Program down-load	Record LED error code and contact technical support
Port error LED			
①②③	④⑤⑥⑦⑧	Port 1 - 5 error (s)	The system board is OK; the reported port(s) is disabled. Record LED status and contact technical support.
LED ③ is reserved.	↑↑↑↑↑ 1 2 3 4 5 port position		

System Diagnostic LEDs

TE100-S55 is equipped with eight Diagnostic LEDs which reflect status of add-on modules. The details of LEDs will be supplied with each optional module package and will not be covered in this manual.

System Utilization LEDs

TE100-S55 is equipped with eight Utilization LEDs which reflect the LAN's percentage of utilization. This is a measure of the traffic on the network.

The LEDs ❶ - ❸ indicates a low traffic on the network, while the LEDs ❹-❷ indicates a high traffic on the network. As the LEDs increase in number, the network administrator should consider optimizing the network for reduced traffic.

Port Status LEDs

TE100-S55 is equipped with six Status LEDs which reflect the status of each port.

As you connect a network cable to the TE100-S55, it will auto-detect the type of cable and the corresponding **10/100** LED will light up. Likewise, depending on the port connection, the **DUPLEX** LED will light up to indicate its status of full or half duplex signaling.

When a port connection is active, the **LINK** LED will light up to indicate its operative state. Also, as activities occur on the network, the **RX** or **TX** LED will light up to indicate its transmission or reception of data.

When multiple packets are delivered at the same time, a collision will occur and the **COL** LED will light up. Although collisions are normal, if there's too much, you should consider rearranging the workgroups or optimize the network for reduced traffic.

Port LED	Status	Port State	Action
10/100	On	100Mbps	Check connections on this cable segment
	Off	10 Mbps	
Duplex	On	Full Duplex	
	Off	Half Duplex	
Link	On	Port Connection Normal	
	Off	Port Connection Inactive	
Tx or RX	Off	No packet traffic	Check if consistently heavy
	Blinking	TD or RD Active	
	On	Heavy packet traffic	
Col	Off	No collision	Normal
	Blinking	Collision Active	Normal
	On	Jabber, serious problem	Check this segment

Appendices

Appendix A Switch Default setting

Parameter	Default	Range	Data type
Spanning Tree State	Enable	Enable/Disable	
Bridge Priority	32768	0 - 65535	Integer
Hello Time	10 sec.	1 - 10 sec.	Integer
Max Age Time	40 sec.	6 - 40 sec.	Integer
Forward Delay Time	5 sec.	5 - 30 sec.	Integer
Aging Time	300 sec.	0 - 10 ^ 6	Integer
IP Address	168.8.xx.xx		
Subnet Mask	255.255.0.0		
Gateway Address	0.0.0.0		
MAC Address	0080C8xxx		
Port State	Enable		
Port Physical	Auto		
Port(s) Priority	128	0 - 255	Integer
Filtering Data Base (Port State)	Disable	Disable Forwarding Blocking	

Note: **Bold** type face indicates user-selective parameters.

The TE100-S55 default parameter settings

Appendix B RS-232 Pin Specification

The RS-232 serial port of the TE100-S55 uses a 9-pin female connector. The port can be connected to a PC emulating a VT100 terminal or an actual VT100 terminal.

For a local connection, the table below shows the pin layout of a 9 to 9-pin or a 9 to 25-pin cable connection between the TE100-S55 and the management terminal.

TE100-S55 (DCE)		Terminal (DTE)		
Pin number	Signal name	for 9-pin	for 25-pin	Signal name
1	not used	1	-	not used
2	transmit (TD)	2	3	RD
3	Receive (RD)	3	2	TD
4	Data Carrier Detect (DCD)	4	20	DTR
5	signal ground (SG)	5	7	SG
6	Data Terminal Ready (DTR)	6	8	DCD
7	clear to send (CTS)	7	4	RTS
8	request to send (RTS)	8	5	CTS
9	not used	9	-	not used

The TE100-S55 to Terminal RS-232 pin connections

Appendix C RJ-45 Pin Specification

When connecting the TE100-S55 to another switch, bridge or a hub, a modified cross-over cable is necessary. Please review these products for matching cable pin assignments.

The following diagram and tables show the standard RJ-45 receptacle/connector and their pin assignments for the switch-to-network adapter card connection and the cross-over cable for the switch-to-switch/hub/bridge connection.

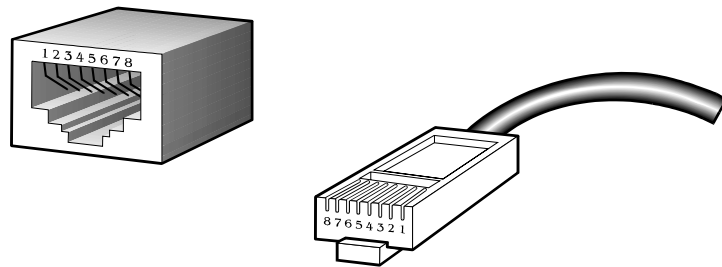

The standard RJ-45 receptacle/connector

<u>Contact</u>	<u>Media Direct Interface Signal</u>
1	TD + (transmission)
2	TD - (transmission)
3	RD + (reception)
4	not used
5	not used
6	RD - (reception)
7	not used
8	not used

The Standard Category 3 cable, RJ-45 pin assignment

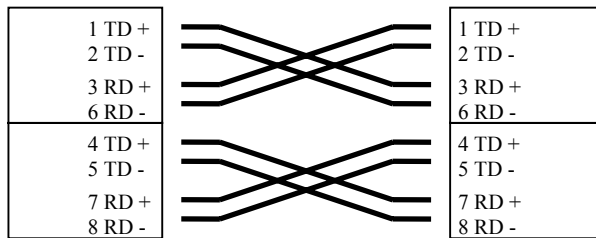

The pin assignment for Category 5, 4-pair cross-over cable

Appendix D 10Base-T Module

The 10Base-T specification is the most popular cabling scheme for conventional 10Mb Ethernet networks and is used in over 70% of LANs worldwide.

Although the TE100-S55 is equipped with five ports for 10Base-T connections, it also provides an open slot for an optional 8-port 10Base-T module.

The 10Base-T module uses inexpensive two-pair Category 3, 4 or 5 UTP cable. It services distance of up to 100 meters and supports full or half-duplexing.

How to Install the 10Base-T module

- Unscrew and remove the cover slot from the front panel of the TE100-S55.
- Slide-in and securely screw the 10Base-T module into the open slot of the TE100-S55.
- Attach the UTP cable into the RJ-45 connectors of the 10Base-T module.

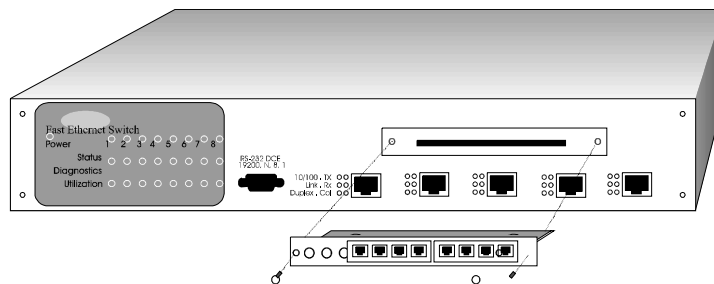

Appendix E 100Base-FX/TX Module

The physical specification for Fast Ethernet cabling comes in three different flavors. These include 100Base-TX (2-pair over Cat 5 UTP), 100Base-T4 (4-pair over Cat 3 UTP), and 100Base-FX (2 fiber connections).

The 100Base-TX specification is the most popular cabling scheme for Fast Ethernet networks. Since it requires a UTP cable similar to 10Base-T, installation and configuration of 100Base-TX cabling is easy and cost-effective.

In contrast, the 100Base-FX specification requires the fiber optic cabling which is more expensive than the conventional UTP cabling. However, it has a definite appeal to widespread LANs where cost of wiring is less important than the distance it delivers to Ethernet LANs--400 meters for half-duplex segments and 2 kilometers for full-duplex segments.

For flexibility, the TE100-S55 provides an 100Base-FX/TX module that's equipped with both Fiber Optic and UTP ports. It permit the users to choose the necessary cabling type that fits their individual needs.

The 100Base-TX port requires two-pair Category 5 UTP cable or two-pair Type 1 STP cable. It services distance of up to 100 meters and supports full or half-duplexing. The 100Base-FX port requires one pair of 62.5/125 micron fiber-optic cable. It services distance of up to 400 meters and supports full or half-duplex operation. It is an ideal solution for backbone connections.

Although the 100Base-FX/TX module is equipped with two ports (MIC and UTP connectors), please keep in mind that only one port may be used at a time.

How to Install the 100Base-FX/TX module

- Unscrew and remove the cover slot from the front panel of the TE100-S55.
- Slide-in and securely screw the 100Base-FX/TX module into the open slot of the TE100-S55.
- Attach either the Fiber Optic cable or Cat 5 UTP cable to the 100Base-FX/TX module. *Although this module is equipped with two ports, only one port may be used at one time.*

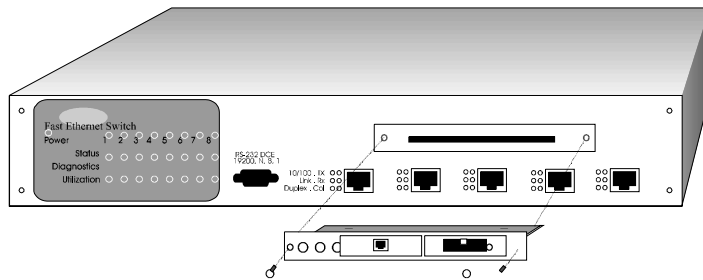

Appendix F ISDN Module

An Integrated Services Digital Network (ISDN) is one of the most rapidly expanding technologies for transmitting data and voice over wide area networks (WANs). The popularity of ISDN is due to its high-speed WAN connections at low cost, enabling greater productivity not only for home office workers or internet users, but also for corporate branch offices and remote sites.

In comparison, ISDN can transfer data more than four times as fast as a cutting-edge 28.8 Kbps modem. In its simplest form, ISDN offers the Basic Rate Interface (BRI), which has two 64Kbps B channels and a single 16Kbps D channel. The B channels can be combined, making the maximum transmission rate of 128Kbps. Furthermore, data compression enables an ISDN link to achieve up to 512Kbps transmission speeds.

ISDN provides high-speed remote access that is ideal for applications where analog connections are too slow and T1 connections are too expensive.

The *ISDN Router module* for the TE100-S55 is an excellent solution for connecting individuals or offices to headquarters or to the internet/intranet. It offers the equivalent bandwidth and reliability of leased lines at a significantly lower cost.

The *ISDN Router module* uses a single ISDN BRI capable of sending data over one B channel for data rates of 64Kbps or use both B channels for data rates of up to 128Kbps. Optional data compression can boost throughput up to 4-to-1 (512Kbps), depending on the data being transferred.

How to Install the ISDN module

- Unscrew and remove the slot cover from the front panel of the TE100-S55.
- Slide-in and securely screw the ISDN module into the open slot.
- Attach the ISDN phone line into the RJ-11 port of the ISDN module.

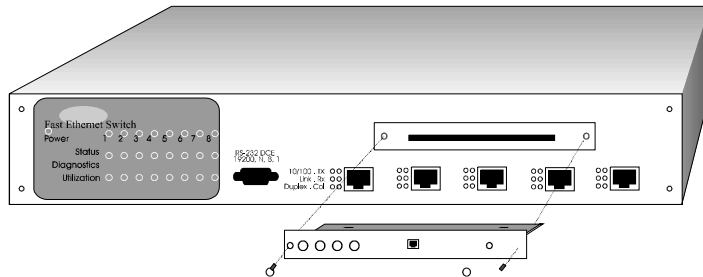

Appendix G Hardware Specifications

SWITCH SPECIFICATION

- Complies to IEEE 802.3 CSMA/CD 10Base-T, 100Base-TX, 100Base-FX Ethernet Standards
- Complies to IEEE 802.1d Spanning Tree, IEEE 802.2 LLC, and ISO 8807-3 standards
- Switched IEEE 802.3 MAC layer frame size: 64-1518
- NWAY Auto-negotiation for each network port providing auto-detection of connected cable type, auto-sensing of full or half duplex signaling and auto-configuration
- Store-and-forward packet switching
- Native SNMP management support with Ethernet MIB II (RFC 1284) and bridge MIB (RFC 1286)
- VLAN support
- 4,096 maximum entries for MAC Address Table
- Comprehensive LED display of the system/port status
- 128KB EEPROM (flash memory) for firmware upgrade
- One RS-232D (DB-9) port for Out-of-Band management (asynchronous, 8-bit data, 1 stop bit, no parity, 19.2K baud)
- Rack mountable (Fits standard 2U EIA 19" rack)
- Five 10/100Mbps LAN ports built-in
- Optional slot for add-on modules

PORT SPECIFICATION

5 x 10/100Mbps LAN ports (fixed)

- Five RJ-45 ports for Cat 3, 4 or 5 UTP cable
- 10 or 100Mbps data transfer rate
- Full or half duplexing
- NWAY Auto-negotiation

8 x 10Mbps LAN ports (optional module)

- Eight RJ-45 ports for Cat 3, 4 or 5 UTP cable
- 10Mbps data transfer rate
- Full or half duplexing
- NWAY Auto-negotiation

1 x 100Base-FX/TX LAN port (optional module)

- One MIC port for 62.5/125 microns multimode fiber optic
- One RJ-45 ports for Cat 5 UTP or STP cable
- 100Mbps data transfer rate
- Full or half duplexing
- NWAY Auto-negotiation

1 x ISDN WAN port (optional module)

- One RJ-11 port for ISDN phone line
- Up to 128K baud rate (two 64Kbps channels)

PHYSICAL CHARACTERISTICS

Operating temperature:	0 - 50 degrees Celsius
Humidity:	5% - 95% non-condensing
Input power:	90 - 250 VAC, 50 - 60 Hz auto-select
Power consumption:	20 watts maximum
Emission:	FCC Class A, CE mark
Safety:	UL, CSA
Ventilation:	2 built-in DC fans
Dimension:	17.36 in (w), 2.85 in (h), 9.37 in (d)
Weight:	8 lb.
Warranty:	One year parts and labor

INDEX

100Base-T	<i>See</i> Fast Ethernet
Adding Optional Modules	19
Add-on modules	11
100Base-FX/TX Module.....	50
10Base-T Module.....	49
ISDN Module.....	52
Attaching Cables	18
Attaching to the RS-232 Port	22
Bridge Priority	28, 29
Cabling rules for 100Base-TX.....	13
Checking Status LEDs.....	20
CSMA/CD.....	7, 8, 9, 54
TE100-S55	10, 11, 12
Designated Bridge	29
Designated Port	30
Down-load New System Firmware	26
Ethernet	8
XPressView	16, 20, 21, 35, 36, 37
Fast Ethernet	7, 8, 9, 10, 11, 50
Filtering Data Base.....	26
Forward Delay	28, 31
Front Panel	17, 19, 49, 51, 53
Gateway Address	24, 25
Hardware Specifications.....	54
Hello Time	24, 28, 31
Installing XPressView	36
IEEE 802.1D	12, 54
IP Address	24, 25, 36, 37
ISDN	10, 11, 12, 17, 52
LEDs	17, 19, 20, 41, 42, 43, 44
Load Factory Default Parameters.....	26
Max. Age Time	28, 31

Modify the Spanning Tree Algorithm	39
Monitor Network Traffic	40
NWAY Auto-negotiation	10, 12, 25, 54
Operating XPressView	38
Out-of-Band Management	12, 17, 20, 21, 22, 24, 28, 35, 38, 54
Path Cost	27, 29, 30, 45
Port Configuration	25
Port Physical setting	25, 45
Port Priority	28, 30, 39
Port State	24, 25, 35, 44, 45
Port Status LEDs	44
POST	19, 20, 41
Power ON	19
Power-On Self Test	<i>See</i> POST
Priority level	25
Rack mounting	18
RJ-45 Pin Specification	47
Root Bridge	24, 28, 29, 30, 31
Root Path Cost	29
Root Port	24, 25, 28, 30
RS-232 Pin Specification	46
Service and support	3
SNMP Management	12, 16, 20, 21, 35, 36, 37, 54
Spanning Tree Algorithm	12, 25, 27, 35, 38, 39
STA parameters	28, 29, 32
Starting XPressView	37
Switch Configuration	24, 25, 35, 38, 39
Switch Default setting	45
Switching Technology	8
System Diagnostics LEDs	43
System Status LEDs	42
System Utilization LEDs	43
Terminal emulation	21, 22, 23, 24
Unpacking	16
VT100 Terminal	22, 23, 46