

# BUNN®

# LCR-3 HV

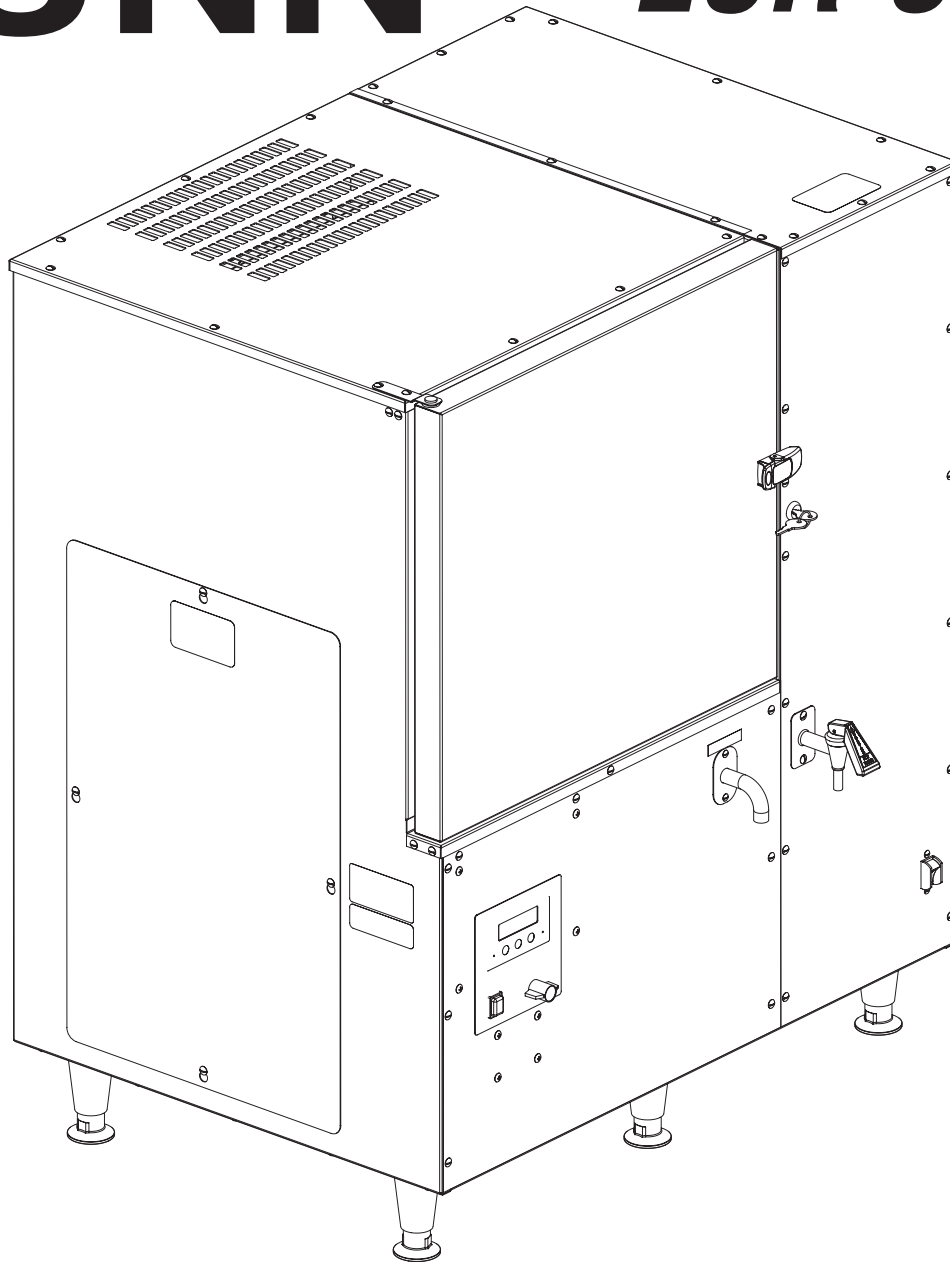

## INSTALLATION & OPERATING GUIDE

### BUNN-O-MATIC CORPORATION

POST OFFICE BOX 3227

SPRINGFIELD, ILLINOIS 62708-3227

PHONE: (217) 529-6601 FAX: (217) 529-6644

To ensure you have the latest revision of the Operating Manual, or to view the Illustrated Parts Catalog, Programming Manual, or Service Manual, please visit the Bunn-O-Matic website, at [www.bunn.com](http://www.bunn.com). This is absolutely FREE, and the quickest way to obtain the latest catalog and manual updates. For Technical Service, contact Bunn-O-Matic Corporation at 1-800-286-6070.

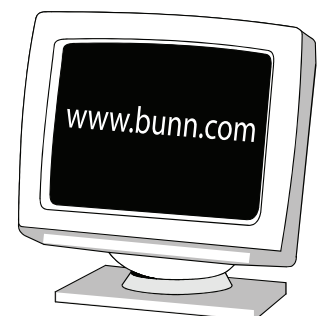

## BUNN-O-MATIC COMMERCIAL PRODUCT WARRANTY

Bunn-O-Matic Corp. ("BUNN") warrants equipment manufactured by it as follows:

- 1) All equipment other than as specified below: 2 years parts and 1 year labor.
- 2) Electronic circuit and/or control boards: parts and labor for 3 years.
- 3) Compressors on refrigeration equipment: 5 years parts and 1 year labor.
- 4) Grinding burrs on coffee grinding equipment to grind coffee to meet original factory screen sieve analysis: parts and labor for 3 years or 30,000 pounds of coffee, whichever comes first.

These warranty periods run from the date of installation BUNN warrants that the equipment manufactured by it will be commercially free of defects in material and workmanship existing at the time of manufacture and appearing within the applicable warranty period. This warranty does not apply to any equipment, component or part that was not manufactured by BUNN or that, in BUNN's judgment, has been affected by misuse, neglect, alteration, improper installation or operation, improper maintenance or repair, damage or casualty. This warranty is conditioned on the Buyer 1) giving BUNN prompt notice of any claim to be made under this warranty by telephone at (217) 529-6601 or by writing to Post Office Box 3227, Springfield, Illinois 62708-3227; 2) if requested by BUNN, shipping the defective equipment prepaid to an authorized BUNN service location; and 3) receiving prior authorization from BUNN that the defective equipment is under warranty.

**THE FOREGOING WARRANTY IS EXCLUSIVE AND IS IN LIEU OF ANY OTHER WARRANTY, WRITTEN OR ORAL, EXPRESS OR IMPLIED, INCLUDING, BUT NOT LIMITED TO, ANY IMPLIED WARRANTY OF EITHER MERCHANTABILITY OR FITNESS FOR A PARTICULAR PURPOSE.** The agents, dealers or employees of BUNN are not authorized to make modifications to this warranty or to make additional warranties that are binding on BUNN. Accordingly, statements by such individuals, whether oral or written, do not constitute warranties and should not be relied upon.

If BUNN determines in its sole discretion that the equipment does not conform to the warranty, BUNN, at its exclusive option while the equipment is under warranty, shall either 1) provide at no charge replacement parts and/or labor (during the applicable parts and labor warranty periods specified above) to repair the defective components, provided that this repair is done by a BUNN Authorized Service Representative; or 2) shall replace the equipment or refund the purchase price for the equipment.

**THE BUYER'S REMEDY AGAINST BUNN FOR THE BREACH OF ANY OBLIGATION ARISING OUT OF THE SALE OF THIS EQUIPMENT, WHETHER DERIVED FROM WARRANTY OR OTHERWISE, SHALL BE LIMITED, AT BUNN'S SOLE OPTION AS SPECIFIED HEREIN, TO REPAIR, REPLACEMENT OR REFUND.**

In no event shall BUNN be liable for any other damage or loss, including, but not limited to, lost profits, lost sales, loss of use of equipment, claims of Buyer's customers, cost of capital, cost of down time, cost of substitute equipment, facilities or services, or any other special, incidental or consequential damages.

392, AutoPOD, AXIOM, BrewLOGIC, BrewMETER, Brew Better Not Bitter, BrewWISE, BrewWIZARD, BUNN Espresso, BUNN Family Gourmet, BUNN Gourmet, BUNN Pour-O-Matic, BUNN, BUNN with the stylized red line, BUNNlink, Bunn-O-Matic, Bunn-O-Matic, BUNNserve, BUNNSERVE with the stylized wrench design, Cool Froth, DBC, Dr. Brew stylized Dr. design, Dual, Easy Pour, EasyClear, EasyGard, FlavorGard, Gourmet Ice, Gourmet Juice, High Intensity, iMIX, Infusion Series, Intellisteam, My Café, PowerLogic, Quality Beverage Equipment Worldwide, Respect Earth, Respect Earth with the stylized leaf and coffee cherry design, Safety-Fresh, savemycoffee.com, Scale-Pro, Silver Series, Single, Smart Funnel, Smart Hopper, SmartWAVE, Soft Heat, SplashGard, The Mark of Quality in Beverage Equipment Worldwide, ThermoFresh, Titan, A Partner You Can Count On, Air Brew, Air Infusion, Beverage Bar Creator, Beverage Profit Calculator, Brew better, not bitter., BUNNSource, Coffee At Its Best, Cyclonic Heating System, Digital Brewer Control, Nothing Brews Like a BUNN, Pouring Profits, Signature Series, Tea At Its Best, Phase Brew, The Horizontal Red Line, trifecta, Ultra, Velocity Brew are either trademarks or registered trademarks of Bunn-O-Matic Corporation.

## CONTENTS

Warranty .....	2	Energy Saver Mode.....	11
Introduction .....	3	Optional 2-Product Operation .....	11
User Notices .....	4	Programming the Dispenser .....	12
Electrical Requirements .....	5	Loading the Concentrate .....	17
Plumbing Requirements .....	5	Priming the Concentrate Lines.....	17
Initial Set-up .....	6	Operating the Dispenser.....	18
Electrical Hook-up.....	6	Filling Cambros or other large containers .....	18
Plumbing Hook-up.....	6	Cleaning & Preventive Maintenance.....	19
Leveling the Dispenser.....	6	Replacing the Pump Tubing .....	20
Installing Pump Tubing .....	7	Draining the Hot Water.....	21
Operating Controls & Interface .....	8	Troubleshooting .....	22
Initial Fill & Heat.....	9	Field Calibration of the Concentrate Pumps .....	25
Rinse Alarm Feature.....	10	Dispenser Flow Rate Calibration .....	25
BIB Empty Lockout Feature.....	11	Field Calibrating the Empty BIB Warning.....	26
Brew Temperature Lockout Feature.....	11	Schematic Wiring Diagram .....	27

## INTRODUCTION

Always follow the Concentrate Manufacturer's for recommendations for proper Storage and Shelf Life. The product Flavor Profile is extended by the refrigerated cabinet featured in the LCR-3. This dispenser is designed to operate at ambient temperatures from 32°F (0°C) minimum to 104°F (40°C) maximum.

# USER NOTICES

Carefully read and follow all notices on the equipment and in this manual. They were written for your protection. All notices are to be kept in good condition. Replace any unreadable or damaged labels.

**⚠ WARNING**

- DO NOT OVERLOAD CIRCUIT.
- ALWAYS ELECTRICALLY GROUND THE CHASSIS OR ADAPTOR PLUG.
- DO NOT DEFORM PLUG OR CORD.
- FOLLOW NATIONAL AND LOCAL ELECTRICAL CODES.
- KEEP COMBUSTIBLES AWAY.

**FAILURE TO COMPLY RISKS EQUIPMENT DAMAGE, FIRE OR SHOCK HAZARD.**

READ THE ENTIRE OPERATING MANUAL BEFORE USING THIS PRODUCT

00986.0002E 5/98 ©1994 Bunn-O-Matic Corporation

00986.0002

As directed in the International Plumbing Code of the International Code Council and the Food Code Manual of the Food and Drug Administration (FDA), this equipment must be installed with adequate backflow prevention to comply with federal, state and local codes. For models installed outside the U.S.A., you must comply with the applicable Plumbing /Sanitation Code for your area.

00656.0001

**⚠ WARNING**

To reduce the risk of electric shock, do not remove or open cover. No user-serviceable parts inside. Authorized service personnel only. Disconnect power before servicing.

37881.0000



00824.0002

**⚠ CAUTION**

Do not connect to a circuit operating at more than 150 volts to ground.

27508.0000

**⚠ WARNING**

<b>Moving Parts.</b> Do not operate unit with this panel removed.	<b>Risk Of Electrical Shock.</b> Disconnect power before servicing unit.
--	---

27442.0000

**Optional Field Wiring**

120/208 V, 37.6 A, 7820 W  
1PH, 3-Wire + GND, 60HZ

120/240 V, 43.2 A, 10400 W  
1PH, 3-Wire + GND, 60HZ  
FOR USE ON INDIVIDUAL BRANCH CIRCUIT ONLY

120/208Y V, 32.8 A, 12000 W  
3PH, 4-Wire + GND, 60HZ

28181.0004

**CHARGE**

Type R134A, Amount **13 oz (368.6 gm)**

Design Pressures:  
High **276 psi (19 bar) (1.9 MPa)**  
Low **88 psi (6 bar) (0.61 MPa)**

33461.0004

**⚠ WARNING: HOT LIQUIDS**

37280.0000

**REMINDER!**  
CLEAN AIR FILTER WEEKLY  
(LOCATED UNDER THE DISPENSER)

**RECORDATORIO!**  
LIMPIAR EL FILTRO DE AIRE SEMANALMENTE  
(LOCALIZADO DEBAJO DEL DISPENSADOR)

**AIR FILTER CLEAN WEEKLY!**  
(LOCATED UNDER THE DISPENSER)

**FILTRO DE AIRE LIMPIAR SEMANALMENTE!**  
(LOCALIZADO DEBAJO DEL DISPENSADOR)

40054.0000

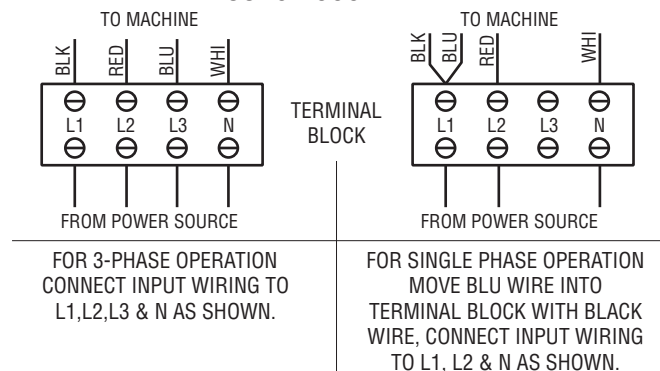

37947.0002

## ELECTRICAL REQUIREMENTS

**CAUTION:** The dispenser must remain disconnected from power source until specified in Electrical Hook-Up. The LCR-3 HV is shipped configured for 3 Phase operation. The internal terminal block must be rewired for 208/240V – 1Phase applications, (see Optional Field Wiring Diagram).

### FIELD WIRING TERMINAL BLOCK DIAGRAM

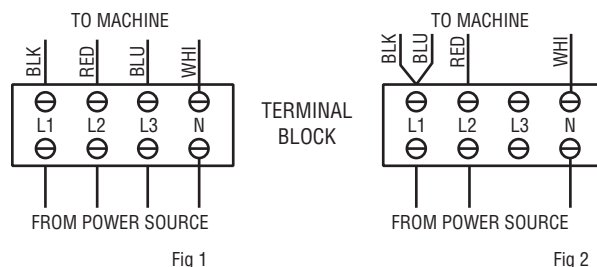

For all 208 - 240 Volt Connections: Use No. 6 AWG Wires suitable for 90°C (194 °F)

1. Unit is shipped wired for 3 Phase / 5 wire operation.
2. For 208 - 240V / 1 Phase / 3 Wire: Move the Blue Heater wire to the Top Black Terminal as shown.
3. Unit requires 120 Vac from L1 to N.

## PLUMBING REQUIREMENTS

The dispenser may be connected to a cold or hot water system (140°F Max.) with operating pressure between 20 and 90 psi (138 and 620 kPa) from a 1/2" or larger supply line. Install a regulator in the line when pressure is greater than 90 psi (620 kPa) to reduce it to 50 psi (345 kPa). The dispenser is set up to deliver to 6 Oz./sec. (177.4 ml/sec) and requires a water supply that can deliver a minimum of 3 gpm (11.4 lpm) at the inlet valve. A shut-off valve should be installed in the line before the dispenser.

**NOTE:** The water inlet fitting is 3/8" flare. Bunn-O-Matic recommends 3/8" flexible tubing from the 1/2" water supply line. At least 18 inches of FDA approved beverage tubing, such as reinforced braided polyethylene or silicone, before the dispenser will facilitate movement to clean the counter top. Bunn-O-Matic does not recommend the use of a saddle valve to supply water to the dispenser. The size and shape of the hole made in the supply line made by this type of device may restrict water flow.

**NOTE:** The water level sensors in this machine do not work with de-ionized water and may cause the unit to overflow. RO (Reverse Osmosis) water supply systems may need to be treated to restore free ions to the water.

**As directed in the International Plumbing Code of the International Code Council and the Food Code Manual of the Food and Drug Administration (FDA), this equipment must be installed with adequate backflow prevention to comply with federal, state and local codes. For models installed outside the U.S.A., you must comply with the applicable Plumbing /Sanitation Code for your area.**

## ALTERNATE LOCATION FOR THE WATER AND ELECTRICAL CONNECTIONS

The LCR-3 HV is supplied with the electrical and water connections at the back of the dispenser. However, in some applications it may be more convenient for one or both of these connections to be located in the bottom of the dispenser. To change the location, remove appropriate cover plate(s) from the bottom of the dispenser. Remove the valve and/or electrical clamp and holes plugs from the back of the dispenser and install them in the bottom panel. Re-install the cover plate on the back of the dispenser to cover the open holes. Take care to replace and tighten all water clamps, mounting screws and the plastic hole plugs.

## INITIAL SET-UP

**NOTE:** The LCR-3 HV dispenser weighs approximately 180 lbs. (82 kg). Use more than one person when lifting or moving the dispenser.

1. Cut the straps and remove the box and foam packing.
2. Locate and remove the information packets and tube kits from top of packaging and set aside.
3. Set dispenser on the counter where it is to be used. **CAUTION: DO NOT LIFT ON THE DOOR.**
4. Confirm the dispenser is level on the counter (See *LEVELING THE DISPENSER*).

## ELECTRICAL HOOK-UP

**CAUTION:** Improper electrical installation will damage electronic components.

1. An electrician must provide electrical service as specified in conformance with all local, state and federal electrical codes.
2. Using a voltmeter, check the voltage and color-coding of each conductor at the electrical source.
3. If plumbing is to be hooked up later, be sure the dispenser is disconnected from the power source. If plumbing has been hooked up, the dispenser is ready for Initial Fill & Heat.

## PLUMBING HOOK-UP

1. Flush the water line to remove any debris or foreign material.
2. Securely attach the water line to the 3/8" flare fitting, lower – right - rear corner of the dispenser.
3. Turn on the water supply and check for leaks.

**NOTE** - Water pipe connections and fixtures directly connected to a potable water supply shall be sized, installed and maintained in accordance with federal, state and local codes.

## LEVELING THE DISPENSER

Proper leveling of the dispenser is required to insure proper drainage of condensation from the refrigeration unit.

1. Set the dispenser on a level counter top.
2. Use the (6) adjustable legs to level the dispenser.
3. Once the unit is level, adjust the front three legs out another 1/16" to create a slight tilt towards the rear of the dispenser. (See Fig. below)

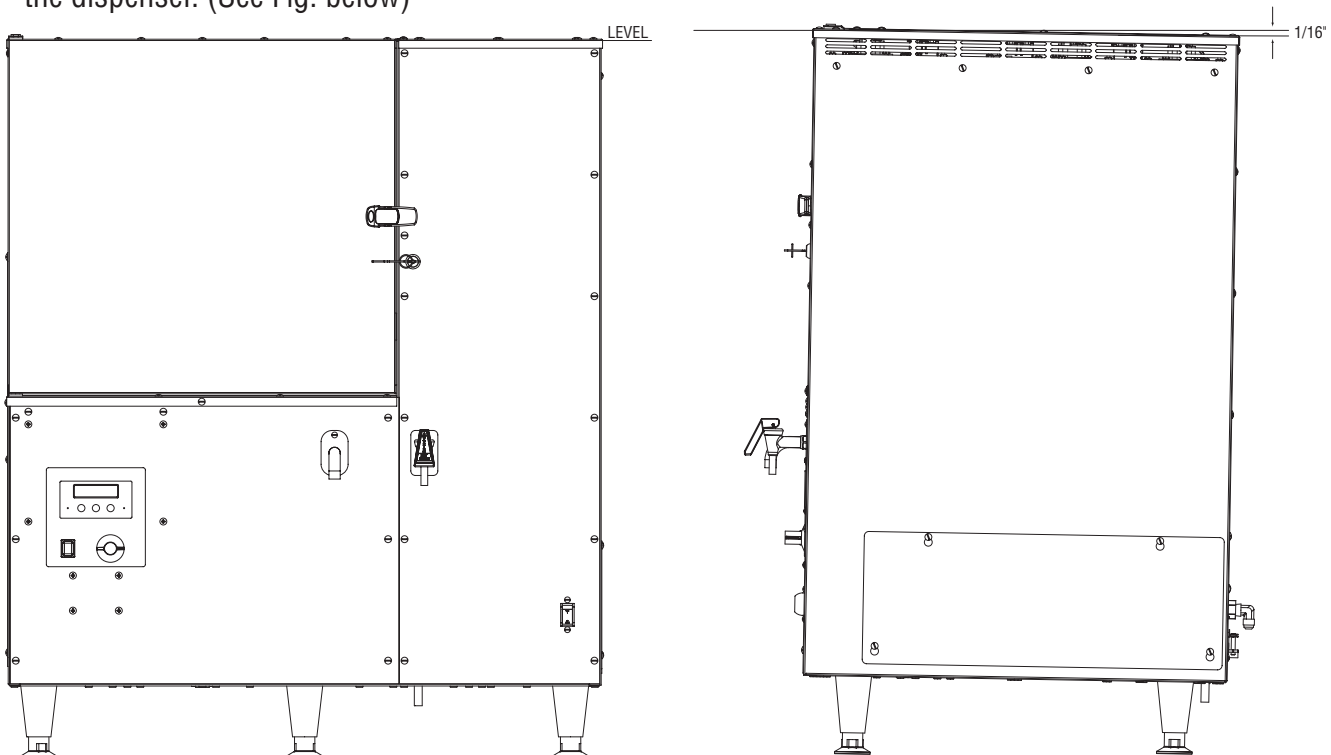

## DRIP TRAY INSTALLATION

1. Unscrew the middle and right front legs (Fig. 1) - just enough to allow the mounting bracket to slide under the legs, (~1/8").  
**Caution: The LCR-3 HV is very heavy. Use wood blocks to hold the machine up while working underneath it!**
2. Insert the bracket between the legs and the base of the machine and retighten the legs, (Fig. 2).

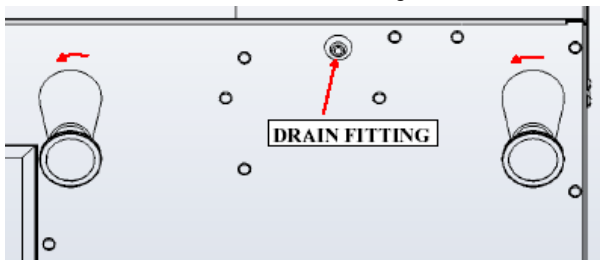

Fig. 1

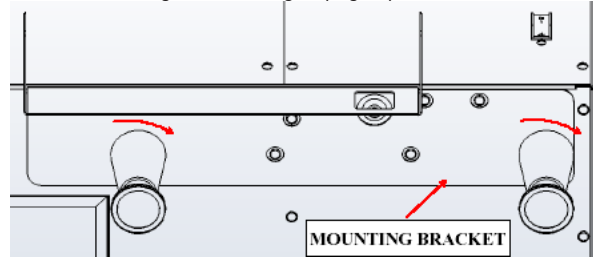

Fig. 2

3. Insert the Drip Tray onto the mounting bracket, (Fig. 3). Make sure the drain fitting is still protruding through the hole.

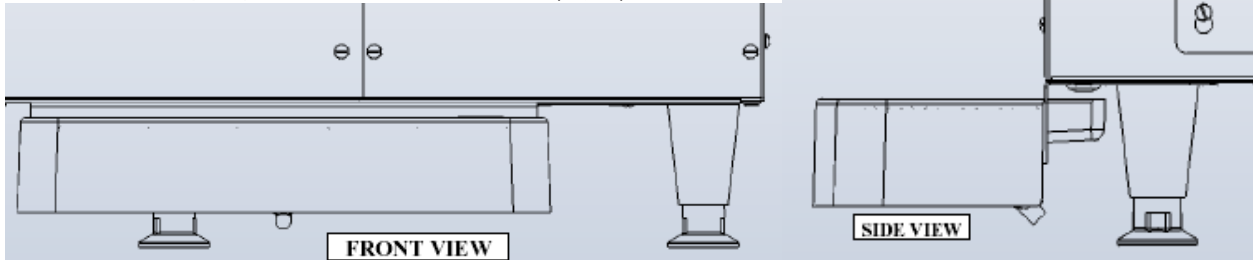

Fig. 3

### Optional Drip Tray Drain

A separate drain tube (not supplied) may be attached to fitting in the bottom of the tray, if desired. Note: Drill a 1/4" hole in the center of the fitting, before attaching the drain hose. Direct the other end of this hose into a permanent drain.

### Alternate Evaporator Drain

For locations where the Drip Tray is not desired, connect a separate drain hose (not supplied) to the Evaporator Drain Fitting and direct the other end of this hose into a permanent drain.

**CAUTION: FAILURE TO INSTALL THE DRIP TRAY OR ALTERNATE EVAPORATOR DRAIN WILL RESULT IN WATER DRIPPING ON TO THE COUNTER AND/OR FLOOR UNDER THE DISPENSER.**

## INSTALLING THE PUMP TUBING

(Refer to the *Tubing Installation Instructions* in side the cabinet door for details.)

1. Loosen the thumbscrew securing the tubing retainer plate to the pump housing. Set the retainer plate aside.
2. Depress the tension screw and remove it from the notch in the pump body, releasing the pump compression band.
3. Apply lubricant (BUNN-O-MATIC part number M2531.0001) to the new pump tubing.
4. Insert the tubing onto the mix chamber port and wrap the tubing around the pump rotor, making sure that the elbow and clamps end up on the bottom side of the pump body.
5. Close the compression band reinsert the tension screw into the notch in the pump housing.
6. Replace the tubing retainer plate and tighten the thumbscrew.
7. Reconnect bag connector to the product box.
8. Repeat steps 1 through 7 for the other two pumps.
9. Prime the pumps. Refer to *Priming the Concentrate Lines* section.

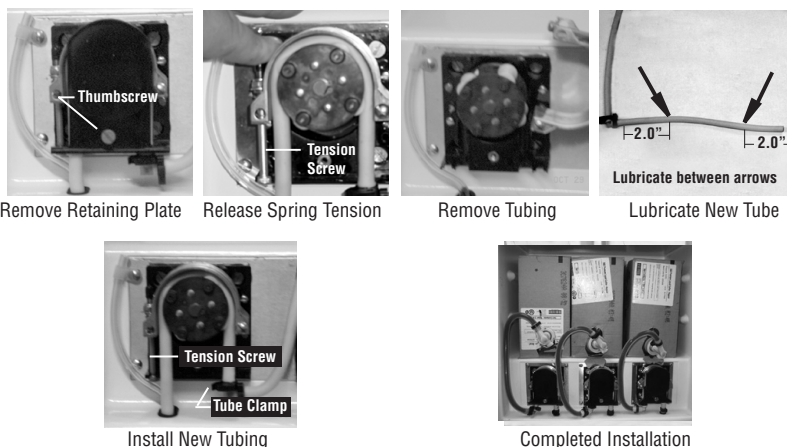



## OPERATING CONTROLS AND INTERFACE

1. Master ON/OFF Switch: Disconnects AC Power to the dispenser.
2. Hot Water Handle: Pull and Hold to dispense hot water manually.
3. Door Interlock Switch: Unit will not dispense product if the door is open.
4. LCD Display: Displays status, programming menus and fault messages.
5. Volume Selection: Rotate dial to the desired volume prior to dispensing product.
6. Dispense Switches (A-B-C): Push and Release to dispense the desired product.  
(These also double as programming switches in the Set-Up mode).
7. Function Selector Switch: Allows the user to set the dispenser into different dispensing modes.
  - a. RINSE: Dispenses hot water only - Flushes the mix chamber and dispense tip.
  - b. RUN: Normal dispense mode - Dispenses mixed product (concentrate and water).
  - c. PRIME: Dispenses concentrate only – Primes the concentrate pump.
8. Hidden Set-Up / Programming switches.
  - a. Press and hold the Right switch for 5 sec. to enter in the Set-Up mode.
  - b. Use the Right switch to scroll down and the Left switch to scroll up through the menu screens.





## INITIAL FILL & HEAT

1. Confirm the water supply is on.
2. Connect the dispenser to the power source.
3. Turn the Master ON/OFF Switch ON and select RUN on the Function Selector Switch. The LCD will display “Tank Filling – Please Wait!” and water will begin flowing into the tank.
4. Once the tank is full the dispenser will start heating the water and display “Heating – Select Flavor”. Dispenser models with product chillers will also begin to cool the cabinet at this time.
5. The LCD will display “Ready Select Flavor” when the tank temperature reaches the preset Ready Temperature.

**Note:** The time required to heat the water initially will vary depending on the AC Power and the temperature of the incoming water. While the tank is heating, the dispenser may be readied for use as described in Programming Functions & Basic Operations.

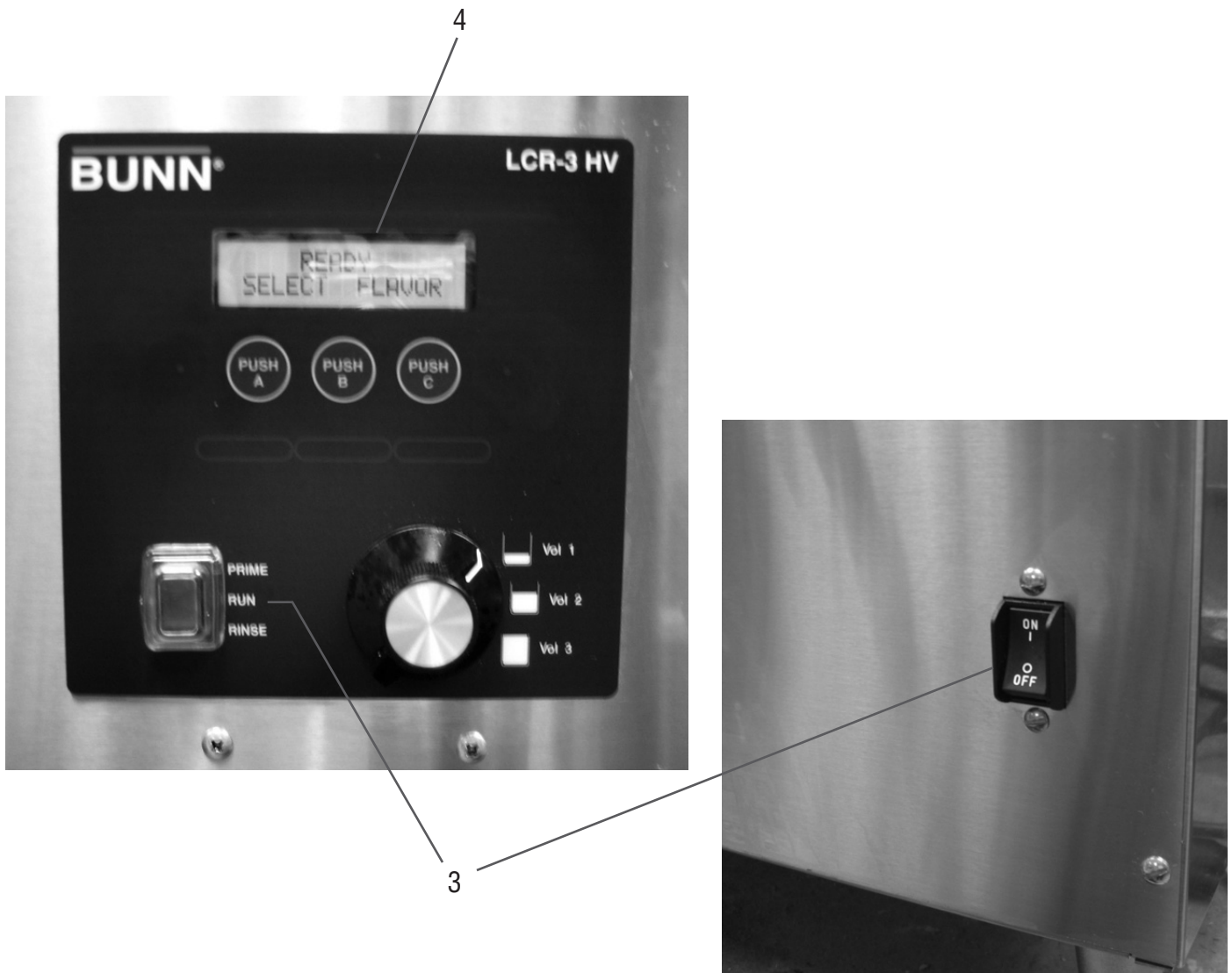

## Rinse Alarm Feature

Periodic rinsing of the mix chambers and dispense tips is essential for proper maintenance and optimum performance of the dispenser. The automated Rinse Alarm feature has three levels of operation; see Programming the Dispenser to select the desired alarm mode.

Alarm Level	Alarm Mode
Disabled	None
Warning Only	“Rinse Required” will be displayed 4 hrs prior to the selected time interval to remind the operator that the Rinse Procedure needs to be preformed soon. The dispenser will continue to serve product, even if the full time interval elapses.
Brew Lockout	“Rinse Required” will be displayed 4 hrs prior to the selected time interval to remind the operator that the Rinse Procedure needs to be preformed soon. However, the dispenser will Lockout and not continue to serve product once the selected time interval has elapsed.

**NOTE:** The time interval between Rinses is adjustable from 8 to 24 hrs. The dispenser is shipped with the Rinse Alarm disabled, (No Alarm). It is up to the user to determine the Rinse time interval and the level of warning required, based on their application and maintenance procedures.



### Rinse Procedure:

1. Select **Rinse** on the Function Selector switch.
2. Place a 2 Liter (1/2 Gal) container under the dispense tip.
3. Activate any of the dispense switches until the water flow stops automatically, approximately 10 sec. The Rinse Alarm message will go away, when the Rinse procedure has been satisfied.
4. Select **Run** on the Function Selector switch.

## BIB Empty Lockout Feature

The dispenser can be set to **not** dispense product when the concentrate BIB is empty. To enable this feature, first calibrate the Empty BIB Threshold (*refer to Field Calibrating the Empty BIB Warning*). Then enable the BIB Empty Lockout feature (*refer to the BIB Empty Lockout menu in Programming the Dispenser*). The dispenser will now Lockout dispensing and display “RIGHT, MIDDLE or LEFT BIB EMPTY – Replace Now!”. Once the BIB has been replaced, PRIME the concentrate line (*refer to Priming the Concentrate Lines*) to clear the Empty BIB warning.

**NOTE:** If the BIB Empty warning reappears, repeat the Priming operation a second time to insure the concentrate is flowing properly.

## Brew Temperature Lockout Feature

The dispenser can be set to not dispense product if the hot water is not up to the preset READY temperature. To enable this feature, set the READY temperature to the minimum allowable dispense temperature. Then enable the Brew Lockout feature, refer to READY TEMP and BREW LOCKOUT, in *Programming the Dispenser*. The dispenser will display “HEATING – Please Wait” and not allow dispensing until the tank temperature reaches the preset READY temperature.

## Energy Saver Mode

The LCR-3 HV can be set to turn off or lower the temperature when not in use. This feature allows the user to enable the Energy Saver Mode, set the Idle Time (length of time the dispenser is inactive before the Energy Saver Mode is activated) and choose between shutting the tank heaters OFF or holding the tank at 140° F (60° C) for faster recovery, (*refer to Programming the Dispenser*). When enabled, the dispenser will automatically go into the Energy Saver Mode after a predetermined time of inactivity, (Idle Time). When in this Mode the display will show “EnergySaver Mode / Press Any Switch.”

**NOTE:** Activating any switch on the control panel will cancel the Energy Saver Mode and reset the Idle Timer. Once the Energy Saver Mode is cancelled, the dispenser will display “Unit Re-heating / E-Saver Mode On” and not dispense product until the water temperature has reached the normal Tank Temperature. Once the normal Tank Temp is reached, the dispenser will revert to typical operation and displays.

## Optional 2- Product Operation

The LCR-3 HV can be configured to deliver only two coffee products for applications where additional volume a given product is needed. This feature allows the operator to load the same concentrate into the Left & Middle position, thus doubling the amount of product that can be dispensed - before having to replace the concentrate. The dispenser will automatically switch from one concentrate container to the other when a BIB Empty threshold is exceeded. The LCD will display “(LF or MID) BIB EMPTY - Replace Soon” to indicate that BIB is empty.

To enable this feature, first calibrate the Empty BIB Threshold (*refer to Field Calibrating the Empty BIB Warning*). Then select (2) in the 2 or 3 PRODUCTS? menu screen, (*refer to Programming the Dispenser*).

**NOTE:** If the operator feels the unit is waiting too long to switch over to the other BIB (i.e. too much clear water during the switch over) - increase the Empty BIB threshold and retest. Repeat this process until you are satisfied that the original BIB is nearly empty and switch over time is acceptable.

The operator can choose to replace the empty BIB right away or wait until the second BIB is empty. The dispenser will continue to switch from one BIB to the other, until it gets two BIB Empty warnings in a row. The dispenser will then shut down and display “BIB EMPTY - Replace Now!” indicating that both BIB’s are empty. Replace the BIB’s and PRIME the concentrate line (*refer to Priming the Concentrate Lines*) to clear the BIB Empty warning. If the BIB Empty warning reappears, repeat the Priming operation a second time to insure the concentrate is flowing properly.

**NOTE:** The BIB EMPTY LOCKOUT feature is automatically enabled when this feature is selected.

## PROGRAMMING THE DISPENSER

Press the Right Hidden Switch for 5 sec. to enter the programming menu. Use the Left and Right hidden switches to scroll through the menu screens. Select Exit to leave the programming function and return to normal operations.

**NOTE 1:** Flashing menu items indicate which selection is active.

**NOTE 2:** Values shown below are the factory default values for English units.

**NOTE 3:** Values in [X - X] are the Min. and Max. for that function.

LCD DISPLAY	ACTION	DESCRIPTION
<b>READY SELECT FLAVOR</b>	Hold the RT Hidden Switch for 5 seconds to enter Programming Functions	Normal Display for LCR models.
<b>LEFT DISP RATIO (-) 30:1 (+)</b>	Use the (+) or (-) buttons to adjust the Mix Ratio	Enter the desired Mix Ratio for the concentrate used in the Left dispenser. [20:1 - 100:1]
<b>MID DISP RATIO (-) 30:1 (+)</b>	Use the (+) or (-) buttons to adjust the Mix Ratio	Enter the desired Mix Ratio for the concentrate used in the Middle dispenser. [20:1 - 100:1]
<b>RIGHT DISP RATIO (-) 30:1 (+)</b>	Use the (+) or (-) buttons to adjust the Mix Ratio	Enter the desired Mix Ratio for the concentrate used in the Right dispenser. [20:1 - 100:1]
<b>LF DISP VOLUME 1 (-) 36.0oz (+)</b>	Use the (+) or (-) buttons to adjust the Volume	Set the desired <b>SMALL</b> portion control volume: (0 - 640 oz) or (0 - 18.93L)
<b>LF DISP VOLUME 2 (-) 192.0oz (+)</b>	Use the (+) or (-) buttons to adjust the Volume	Set the desired <b>MEDIUM</b> portion control volume: (0 - 640 oz) or (0 - 18.93L)
<b>LF DISP VOLUME 3 (-) 384.0oz (+)</b>	Use the (+) or (-) buttons to adjust the Volume	Set the desired <b>LARGE</b> portion control volume: (0 - 640 oz) or (0 - 18.93L)
<b>MID DISP VOLUME 1 (-) 36.0oz (+)</b>	Use the (+) or (-) buttons to adjust the Volume	Set the desired <b>SMALL</b> portion control volume: (0 - 640 oz) or (0 - 18.93L)
<b>MID DISP VOLUME 2 (-) 192.0oz (+)</b>	Use the (+) or (-) buttons to adjust the Volume	Set the desired <b>MEDIUM</b> portion control volume: (0 - 640 oz) or (0 - 18.93L)
<b>MID DISP VOLUME 3 (-) 384.0oz (+)</b>	Use the (+) or (-) buttons to adjust the Volume	Set the desired <b>LARGE</b> portion control volume: (0 - 640 oz) or (0 - 18.93L)
<b>RT DISP VOLUME 1 (-) 36.0oz (+)</b>	Use the (+) or (-) buttons to adjust the Volume	Set the desired <b>SMALL</b> portion control volume: (0 - 640 oz) or (0 - 18.93L)
<b>RT DISP VOLUME 2 (-) 192.0oz (+)</b>	Use the (+) or (-) buttons to adjust the Volume	Set the desired <b>MEDIUM</b> portion control volume: (0 - 640 oz) or (0 - 18.93L)
<b>RT DISP VOLUME 3 (-) 384.0oz (+)</b>	Use the (+) or (-) buttons to adjust the Volume	Set the desired <b>LARGE</b> portion control volume: (0 - 640 oz) or (0 - 18.93L)

## PROGRAMMING (Continued)

LCD DISPLAY	ACTION	DESCRIPTION
<b>TANK TEMP 190</b> (-) EXIT (+)	Use the (+) or (-) buttons to adjust the target Temp.	Sets the water Tank temperature: (120 - 200°F) or (49 - 93°C)
<b>READY TEMP 180</b> (-) EXIT (+)	Use the (+) or (-) buttons to adjust the target Temp.	Sets the hot water Ready temperature: Typically set to the min. desired dispense temp.
<b>CABINET TEMP 38</b> (-) EXIT (+)	Use the (+) or (-) buttons to adjust the target Temp.	Sets the Chilled cabinet target temperature: (38 - 50°F) or (3 - 10°C)

The following functions can be Password Protected. If you wish to prevent others from accessing these functions, enter a 4 digit code of your choice. Record your password code [ \_ \_ \_ \_ ], as you will need it to access these functions in the future.

LCD DISPLAY	ACTION	DESCRIPTION
<b>ENTER PASSWORD</b> (-) 0 (+)	Use the (+) or (-) buttons to enter password.	Enter the access Code to view the remaining functions. Factory Default = 0.
<b>SET PASSWORD ?</b> (-) 0 (+)	Use the (+) or (-) buttons to change the password.	Enter your own Code to prevent access to the remaining functions. [0 to 9999]
<b>2 OR 3 PRODUCTS?</b> (2) EXIT (3)	Select the number of products to be dispensed	Used to switch from standard 3 products to 2 products w/Autoswitching of the Left and Middle Bibs.
<b>SELECT UNITS</b> ENG EXIT METRIC	Select the preferred units.	Used to select the preferred units of measurement. (Oz., Gal, deg F) or (mL, L, deg C)
<b>REFRIGERATION ?</b> ON EXIT OFF	Select <b>OFF</b> to disable the Refrigeration system	Select OFF to temporarily override a cooling system fault and allow the machine to dispense coffee.
<b>DEICE CYCLE TIME</b> (-) 120 MIN (+)	Select the time delay between automatic deicing of the cabinet	If ice builds up on the evaporator - decrease the delay. If the cabinet is not cold enough - increase the delay. Factory Default=120 (2 hrs)[min=30, max=180]
<b>RINSE ALARM ?</b> NO EXIT YES	Select (YES) or (NO)	Selecting Yes will enable the Rinse Alarm function, (see <i>Rinse Alarm</i> )
<b>RINSE TIME ?</b> (-) 12 HRS (+)	Use the (+) or (-) buttons to adjust Rinse Alarm delay.	Enter the desired time between required Rinse Cycles in hours. [8 to 24 hrs]
<b>RINSE LOCKOUT ?</b> NO EXIT YES	Select (YES) to enable	Select YES to Lockout dispensing until the Rinse Alarm has been cleared. Default is NO.

If ON

If NO

If YES

to Next Page

## PROGRAMMING (Continued)

LCD DISPLAY	ACTION	DESCRIPTION
<b>BibEMPTY LOCKOUT</b> NO EXIT YES	Select (YES) to enable	Select YES to Lockout dispensing until the BIB is replaced and the pump has been Primed. Default is NO.
<b>BREW LOCKOUT ?</b> NO EXIT YES	Select (YES) to enable	Select YES to Lockout dispensing until the hot water tank is at READY Temp. Default is NO.
<b>ENERGY SAVER MODE</b> NO EXIT YES	Select (ON) to enable	Select ON to enable Energy Saver Mode. Default is OFF.
<b>E-SAVER IDLE TIME</b> (-) 4 HRS (+)	Use the (+) or (-) buttons to adjust the Idle Time	Enter the amount of inactive time before the dispenser goes into Energy Saver Mode. Default is 4 hrs. Maximum is 24 hrs.
<b>E-SAVER TANK TEMP</b> NO EXIT 140	Select OFF or 140° F (60°C)	Choose OFF to turn the tank heaters off completely or 140°F (60°C) to hold hot water at 140°F (60°C) during E-Saver Mode. Default is 140°F (60°C).



## PROGRAMMING (Continued)

The following functions are for diagnostic and troubleshooting purposes and typically do not have to be adjusted. Contact your local service agent for assistance before making changes to these functions.

LCD DISPLAY	ACTION	DESCRIPTION
<b>CAL LEFT PUMP ? LEFT</b>	Place a 50 mL (#34843.1000) graduated cylinder under the dispense tip, then activate the Left Pump	The Left Pump will dispense concentrate for 10 seconds, then shut off automatically. Collect and measure the concentrate dispensed.
<b>CAL LF PUMP VOL (-) 58mL (+)</b>	Use the (+) or (-) buttons to enter volume collected	Enter the volume of concentrate measured from the Left Pump in mL, (not Oz.)
<b>CAL MIDDLE PUMP ? MIDDLE</b>	Place a 50 mL (#34843.1000) graduated cylinder under the dispense tip, then activate the Middle Pump	The Middle Pump will dispense concentrate for 20 seconds, then shut off automatically. Collect and measure the concentrate dispensed.
<b>CAL MID PUMP VOL (-) 58mL (+)</b>	Use the (+) or (-) buttons to enter volume collected	Enter the volume of concentrate measured from the Middle Pump in mL, (not Oz.)
<b>CAL RIGHT PUMP ? RIGHT</b>	Place a 50 mL (#34843.1000) graduated cylinder under the dispense tip, then activate the Right Pump	The Right Pump will dispense concentrate for 20 seconds, then shut off automatically. Collect and measure the concentrate dispensed.
<b>CAL RT PUMP VOL (-) 58mL (+)</b>	Use the (+) or (-) buttons to enter volume collected	Enter the volume of concentrate measured from the Right Pump in mL, (not Oz.)
<b>CAL HI WTR FLOW PULL DISPENSER</b>	Place a 64oz (2000mL) container under the dispense tip, then Press and Hold any Dispense Switch	The Dispenser will dispense hot water for 20 seconds, then shut off. Release Dispense Sw.
<b>CAL HI WTR VOL (-) 1720mL (+)</b>	Use the (+) or (-) buttons to enter volume collected	Collect and measure the water dispensed. Enter the volume in mL. Default is 1720 mL
<b>XXX CAL -&gt; XXX (-) Tank Temp (+)</b>	Use the (+) or (-) buttons to adjust temperature reading	Adjust the display reading to match a calibrated probe inserted next to the Tank Sensor, °F (°C)
<b>BIB EMPTY -&gt; 600 (-) EXIT (+)</b>	Use the (+) or (-) buttons to adjust Empty BIB threshold	Used to set the Conductance Threshold for the Empty BIB warning. Default is 600

## PROGRAMMING (Continued)

LCD DISPLAY	ACTION	DESCRIPTION
<b>XXOVERFLOW &gt; 155</b> (-) EXIT (+)	Use the (+) or (-) buttons to adjust Overflow threshold	Used to set the Conductance Threshold for the Tank Overflow Probe
<b>XX REFILL -&gt; 155</b> (-) EXIT (+)	Use the (+) or (-) buttons to adjust Refill threshold	Used to set the Conductance Threshold for the Tank Refill Probe.
<b>WTR START DELAY</b> (-) .15SEC (+)	Use the (+) or (-) buttons to adjust delay time	Dispense Valve ON Delay. Eliminates weak mix at the beginning of a dispense.
<b>WTR STOP DELAY</b> (-) .15SEC (+)	Use the (+) or (-) buttons to adjust delay time	Dispense Valve OFF Delay. Flushes the mix chamber at the end of a dispense.
<b>TEST SWITCHES ?</b> UseSwitchToTest	NONE	Switch Diagnostic: Activate switches separately to test. Display will indicate which Switch has been activated. NOTE: Door Interlock switch must be held closed.
<b>TEST REFILL ?</b> EXIT YES	Momentarily depress (YES)	Refill Valve Diagnostic: Press YES to momentarily energize the Solenoid. CAUTION: Inlet Valve will open and water will flow, if connected and turned ON.
<b>TEST HEATER ?</b> EXIT YES	Momentarily depress (YES)	Tank Heater Diagnostic: Press YES to momentarily energize the Tank Heater Circuit. CAUTION: AC power will be applied to the Tank Heater Circuit.
<b>ENTER ASSET #</b> (-) 000000 (+)	Use the (+) or (-) buttons to enter the ASSET NUMBER	Allows the user the option of entering an Asset Number. Default is 000000
<b>SERIAL #</b> LCR 0000000	NONE	Displays the manufacture's Serial Number (should be identical to the Serial Number on the Data Plate)
<b>VIEW FAULTS?</b> (-) EXIT (+)	Select (+) to view the Fault Conditions	This unit stores the last 3 Fault Conditions in memory for diagnostic purposes.
<b>LATEST FAULT</b> NO FAULTS	Use the (+) or (-) to scroll through the Faults	Displays up to 3 FAULT Conditions or NO FAULTS, if nothing has failed since the last "Reset Defaults".
<b>FACTORY DEFAULTS</b> NO YES	Select (YES) or (NO)	<b>CAUTION:</b> Selecting YES will RESET all Programming Functions to the Factory Default settings

## LOADING THE CONCENTRATE

1. Thoroughly mix concentrate by vigorously shaking the product Bag-In-Box (BIB).
2. Pull the BIB connector through the hole provided in the box.
3. Open the dispenser door and locate the appropriate left, middle or right BIB Adapter fitting.
4. Connect the Adapter fitting to the BIB. Make sure the locking mechanism is fully engaged!
5. Place the BIB upright in the machine, rotating it into position with the connector down and facing forward.
6. Rotate the BIB Adapter to avoid sharp bends in the tubing and allow it to be routed between the pumps. Refer to the Tube Installation Decal on the door for proper routing.
7. Close the cabinet door.



Fig. 1

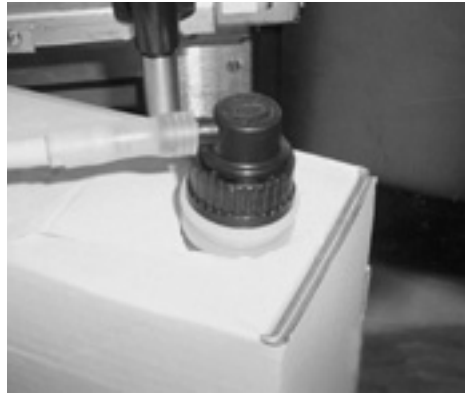

Fig. 2



Fig. 3

## PRIMING THE CONCENTRATE LINES

1. Select **PRIME** on the Function Selector Switch.
2. Load concentrate per instructions in the section titled Loading the Concentrate.
3. Place a container under the dispense tip.
4. Activate the appropriate pump switch until concentrate flows from the dispense tip, (approx 5 to 10 sec).
5. Repeat steps 2 through 4 for the other two pumps, if needed.
6. Select **RUN** on the Function Selector Switch.

**Note:** Concentrate may continue to drip out of dispense tip. The user may wish to run a Rinse Cycle (refer to Rinsing) after Priming the dispenser to clean out the remaining concentrate.



## OPERATING THE DISPENSER

**The Cabinet door must be closed & latched and the Function Selector Switch set to RUN to dispense coffee.**

### **To Dispense Coffee**

1. Select the desired volume (1, 2 or 3) using the rotary switch.
2. Place the appropriate container under the dispense tip.
3. Press and release the desired flavor switch to dispense product. The LCD will display “DISPENSING PRODUCT” “PRESS ANY SWITCH TO STOP”. Note: Pressing any switch after starting a dispense cycle - will abort that dispense and halt the flow of product.
4. Remove the container and serve accordingly.

### **To Dispense Hot Water**

1. Place container under the hot water dispenser tip.
2. Pull and Hold the Hot Water handle until the water reaches the desired level, then release.
3. Remove the container.

**NOTE:** For large containers that will not fit under the dispense tip, a short 3/8” diameter NSF approved hose may be used.

### **FILLING CAMBROS OR OTHER LARGE CONTAINERS**

The dispenser is designed primarily for containers that will fit under the dispense tip. However, it may be used to fill larger containers (up to 5 Gal) by use of an extension hose on the dispense tip. Care must be taken to insure that the mixed product flows freely from the dispense tip into the container.

1. Use a 5/8” I.D. or larger, NSF (National Sanitation Foundation) approved hose.
2. Use as short a hose as possible with no loops, bends or kinks in it.
3. Insure that the outlet of the hose is below the dispense tip and that the mixed product flows freely into the container.
4. A properly sized and positioned hose will not run full or back up into the dispense tip. Failure to follow these directions can alter the mix ratio and/or cause flooding of the vent tube.

**NOTE:** *Recovery time will be dependent on the temperature of the supply water and the supply voltage to the dispenser.*

## CLEANING & PREVENTATIVE MAINTENANCE

### General Cleaning and Sanitizing Procedures

**Note:** The BUNN® Liquid Coffee Dispenser incorporates a “user selectable” rinse reminder feature and can be set to disable dispensing when it is time to rinse. See *Programming Functions* to activate this feature.

### Daily: RINSING & CLEANING

1. Select **RINSE** on the Function Selector Switch.
2. Place a 1/2 gal (2 liter) container under the dispense nozzle.
3. Press and Hold any flavor selection switch for approximately twenty seconds or until the hot water is clear or has no concentrate coloring in it.
4. Wipe splash panels, dispense nozzle, door, and cabinet with a clean sanitary cloth.

**Note:** To clear the “Rinse” alarm, activate the dispenser until the flow stops automatically (approx. 20 seconds). The “Rinse” alarm display will turn off when the Rinse Procedure has been satisfied.

### Weekly: SANITIZING

1. Select **PRIME** on the Function Selector Switch and open the dispenser door.
2. Remove the bag connector from the product BIB and disassemble or prop open the internal valve to allow flow of product through the connector.

**NOTE:** Cutting the mating fittings from an empty bag makes an excellent “free flowing” connector for this purpose.

3. Place the bag connector into a one-gallon (3.8 liter) container of warm soapy tap water 140°F (60°C).
4. Place an empty container under dispense tip and activate the corresponding pump until the clean soapy water is dispensed from the dispense tip.
5. Repeat steps 3 and 4 with warm tap water 140°F (60°C) to rinse the soapy water from the pump tubing.
6. Continue dispensing until the water is clear, and no soapy water is being dispensed.
7. Prepare 2.5 gallons (9.46L) of sanitizing solution by dissolving 1 packet of Kay 5 sanitizer into 2.5 gallons (9.46L) of 120°F (48.9°C) water to ensure 100 ppm of available chlorine.
8. Again, repeat steps 3 and 4 with the sanitizing solution. Once sanitizing solution is visible, continue to dispense for 1 minute. Release handle and allow solution to sit for 5 minutes.
9. After soaking for 5 minutes, activate the dispense switch a second time, this time for 2 minutes. After 2 minutes, release the dispense switch.
10. Repeat steps 5 & 6 with warm tap water to flush out the sanitizing solution from the pump tubing.
11. Reattach the bag connector to product BIB.
12. Close the dispenser door and select **NORMAL** on the Function Selector Switch.
13. Activate the dispenser until concentrate/water mixture appears. Then dispense 20 ounces (600 ml) into a container of concentrate/water mixture and discard.
14. Repeat steps 1 through 13 for other two Pumps.
15. Wipe internal and external surfaces with a clean, sanitary cloth.

### Weekly: REFRIGERATION AIR FILTER

1. Remove the screen filter from the bottom of the dispenser.
2. Wash the screen in a mild detergent solution.
3. Use a soft bristled brush to remove all dust and grease.
4. Reinstall the screen.

## PREVENTIVE MAINTENANCE

Bunn-O-Matic® Corporation recommends that preventive maintenance be performed at regular intervals. Maintenance should be performed by a qualified service technician. For Technical Service, contact Bunn-O-Matic® Corporation at 1-800-286-6070.

**NOTE: Replacement parts or service caused by failure to perform required maintenance is not covered by warranty. Replace pump hoses every 6-Months or as needed.**

## REPLACING THE PUMP TUBING

The pumps and tubing used in this dispenser are designed to give maximum performance and long life. However, the tubes are a wear item and must be replaced periodically. How long the tubes last is dependent on usage and properties of the concentrate. Excessive wear will reduce the output of the pumps resulting in a weak mixed beverage.

**Bunn-O-Matic recommends replacing the Pump Tubing a minimum of once every 6 months or sooner, if warranted.**

Refer to the *Tube Replacement Instruction* on the Cabinet door for details.

1. Rinse the pump tubing with warm tap water (Refer to step 5 of the *Weekly Sanitizing instructions*) prior to removing the tubes to avoid concentrate spills.
2. Loosen the thumbscrew securing the tubing retainer plate to the pump housing. Set the retainer plate aside.
3. Depress the tension screw and remove it from the notch in the pump housing, releasing the tube compression band.
4. Open the compression band and gently pull the pump tube from around the pump's rotor.
5. Inspect the pump bands for signs of cracking or excessive wear. Replace if necessary.
6. Apply lubricant (BUNN-O-MATIC part number M2531.0001) to the new pump tubing's rotor side.
7. Insert the tube onto the mix chamber port, then wrap the new tubing around the pump rotor, making sure the elbow and clamps end up on the bottom side of the pump housing.
8. Depress the tension screw and insert it in the notch in the pump body, reapplying spring tension to the compression band.
9. Replace the tubing retainer plate and tighten the thumbscrew.
10. Repeat steps 1 through 9 for the other two pumps.

**Note:** Replacement Tube/Adapter Kits can be purchased from BUNN-O-MATIC.

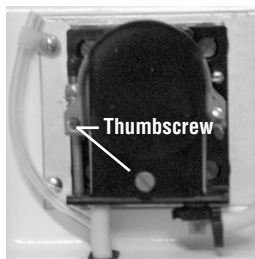

Remove Retaining Plate

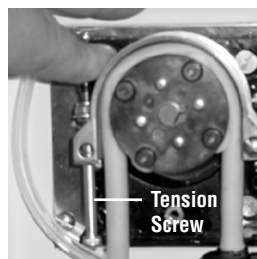

Release Spring Tension

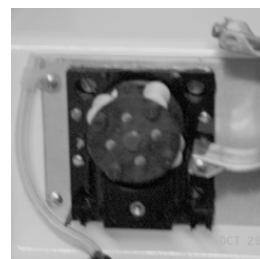

Remove Tubing

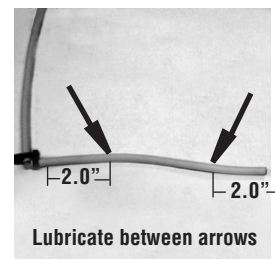

Lubricate New Tube

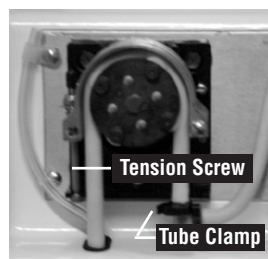

Install New Tubing



Completed Installation



## DRAINING THE HOT WATER TANK

**CAUTION:** The dispenser must be disconnected from the power source throughout these steps.

1. Disconnect the dispenser from the power source.
2. Shut off and disconnect the incoming water supply.
3. Remove the lower right access panel.
4. Pull out drain tube to empty into a sink or a container with a minimum of 18 gallon capacity.
5. Make sure drain clamp is closed. Then, remove drain plug.
6. Direct tube into sink or container and open drain clamp. Continue draining tank until ALL of the water is out.

**CAUTION:** The water may be very hot as it drains out of the tank. Make sure the hose is directed away from the body.

7. Close drain clamp, insert drain plug, place drain tube back into machine, and replace the access panel.

**Note:** The dispenser must be refilled using the Initial Fill & Heat steps before reconnecting the power source.

## Troubleshooting

A troubleshooting guide is provided to suggest probable causes and remedies for the most likely problems encountered. If the problem remains after exhausting the troubleshooting steps, contact the Bunn-O-Matic Technical Service Department.

- Only qualified service personnel should perform inspection, testing, and repair of electrical equipment.
- Shorting the terminals or the application of external voltages to electronic components may result in component or circuit board failure.
- Intermittent operation of electronic circuit boards is unlikely. board failure will normally be permanent. If an intermittent condition is encountered, the cause will likely be a switch contact or a loose wire connection at a terminal or crimp.
- Solenoid removal requires interrupting the water supply to the valve. Damage may result if solenoids are energized for more than ten minutes without a supply of water.
- The use of two wrenches is recommended whenever plumbing fittings are tightened or loosened. This will help avoid twists and kinks in the tubing.
- Make certain that all plumbing connections are sealed and all electrical connections are tight and isolated.
- This dispenser is heated at all times. Keep away from combustibles.

### WARNING:

- Exercise extreme caution when servicing electrical equipment.
- Disconnect the brewer from the power source when servicing, except when electrical tests are specified.
- Follow recommended service procedures.
- Replace all protective shields or safety notices.

Screen Displayed	Possible Cause	Troubleshooting Procedures
<b>NO DISPLAY</b>	No Power to the Dispenser	Check Master ON/OFF Switch Check Power Cord & Circuit Breaker Service Required
<b>HEATING Please Wait!</b>	Water temp is below the preset READY temp	Wait for water temp to rise Check Ready Temp. threshold setting Service Required
<b>RINSE REQUIRED</b>	Rinse Alarm Time Interval has expired	Rinse Dispenser, see <i>Rinse Procedure</i> Replace BIB, see <i>Loading the Concentrate</i>
<b>XXXX BIB EMPTY Replace BIB Soon</b>	Concentrate BIB is empty. BIB not properly connected. Tubing kinked or blocked. Empty BIB Threshold too high.	Replace BIB, see <i>Loading the Concentrate</i> Check BIB Connector Fittings Check Tubing Installation Check Empty BIB Threshold, see <i>Field Calibrating the Empty BIB Warning</i>
<b>____ TARGET RPM TOO HIGH !!</b>	The calculated Target RPM for the pump indicated is out of range	Check Pump & Flow Rate Calibration, refer to <i>Field Calibration Procedures</i>

## Troubleshooting (Continued)

Screen Displayed	Possible Cause	Troubleshooting Procedures
<p>___ <b>TARGET RPM TOO LOW !!</b></p>	The calculated Target RPM for the pump indicated is out of range	Check Pump & Flow Rate Calibration, refer to <i>Field Calibration Procedures</i>
<p>___ <b>PUMP FAULT</b> <b>CHK PUMP WIRING</b></p> <p><b>CHK RPM SENSOR</b></p> <p><b>CHK TUBING AREA</b></p>	<ol style="list-style-type: none"> <li>1. Pump Motor failure</li> <li>2. RPM Sensor failure</li> <li>3. Tubing pinched in rollers</li> </ol>	<p>Service Required</p> <p>Service Required</p> <p>Replace Tubing</p>
<p><b>OVERFLOW FAULT</b></p>	<ol style="list-style-type: none"> <li>1. Refill valve stuck open</li> <li>2. Faulty refill probe</li> <li>3. Faulty overflow switch</li> </ol>	<p>Service Required</p> <p>Service Required</p> <p>Service Required</p>
<p><b>HEATING TIME TOO LONG</b> ↑↓ <b>CHECK HEATING CIRCUIT</b></p>	<ol style="list-style-type: none"> <li>1. Tank Heater failure</li> <li>2. Triac failure</li> <li>3. Tank Temp. sensor failure</li> </ol>	<p>Service Required</p> <p>Service Required</p> <p>Service Required</p>
<p><b>FILL TIME TOO LONG</b> ↑↓ <b>CHECK WATER SUPPLY</b></p>	<ol style="list-style-type: none"> <li>1. Water shut off to dispenser</li> <li>2. Inlet Solenoid Valve failure</li> </ol>	<p>Check water supply valve</p> <p>Service Required</p>
<p><b>TANK SENSOR OUT OF RANGE</b> ↑↓ <b>CHECK FOR BAD CONNECTIONS</b> ↑↓ <b>CHECK WIRE FOR SHORTS</b></p>	<ol style="list-style-type: none"> <li>1. Corresponding Temperature Sensor Probe wire(s) broken or disconnected</li> <li>2. Corresponding Temperature Sensor Probe wire(s) shorted to housing, or to each other.</li> </ol>	<p>Service Required</p> <p>Service Required</p>

## Troubleshooting (Continued)

Screen Displayed	Possible Cause	Troubleshooting Procedures
COOL TEMP SENSOR OUT OF RANGE ↑↓ CHECK FOR BAD CONNECTIONS ↑↓ CHECK WIRE FOR SHORTS	1. Cold Sensor wire(s) shorted to housing, or to each other.  2. Product cabinet temperature too high.  3. Product cabinet temperature too low.	Service Required  Service Required  Service Required
EVAP TEMP SENSOR OUT OF RANGE ↑↓ CHECK FOR BAD CONNECTIONS ↑↓ CHECK WIRE FOR SHORTS	1. Evaporator temperature too high or too low.  2. Corresponding Evaporator Sensor Probe wire(s) broken or disconnected.  3. Corresponding Temperature Sensor Probe wire(s) shorted to housing, or to each other.	Service Required  Service Required  Service Required
COOLER FAULT! EVAP TEMP TOO HI ↑↓ CHECK EVAP FAN CHK EVAP SENSOR	1. Cabinet circulating fan failure  2. Ice build up on evaporator coils  3. Evaporator sensor failure	Service Required  Service Required  Service Required
COOLING TIME TOO LONG ↑↓ CHECK AIR FILTER CHECK COOLING UNIT	1. Air intake filter clogged  2. Wiring failure  3. Compressor failure	Clean Air Filter  Check wiring harness for breaks, shorts, open connectors  Service Required
COND PROBE FAULT CHECK COND PROBES ↑↓ CHK DISP SWITCHES CHK CONNECTIONS	1. Concentrate buildup on probes  2. Machine dispensing continuously  3. Water flowing continuously	Check pump & tubing for proper installation. Clean probes Dispense switch failure, Service Required Dispense valve leaking, Service Required
JUMPER FAULT! CONFIG NOT VALID ↑↓ CHECK J-18 ON CONTROL BOARD	1. Invalid wire harness configuration	Service Required

## Field Calibration of the Concentrate Pumps / Dispenser Flow Rates

The factory set Default Values for the Pump & Dispenser Flow Rates are very accurate and typically do not need to be field calibrated. However, if the mix ratio accuracy is ever in question, this procedure can be used to recalibrate the unit in the field. Equipment Required:

250 ml graduated cylinder, with 2 ml graduations. BUNN # 34028.0000

2000 ml graduated container. BUNN # 34843.0001

**NOTE:** You can calibrate either the Concentrate Pumps or the Dispenser Flow Rate independently. Simply scroll through the menu screen to the desired section and perform only those steps.

### Calibrating the Left Concentrate Pump

1. Select **PRIME** on the Function Selector Switch. (refer to Priming the Concentrate Lines).
2. Place a container under the Dispense Tip and prime the concentrate lines until a steady stream of concentrate comes out the tip (approximately 10 seconds).
3. Stop the Priming and allow the tip to stop dripping. Discard the concentrate collected.
4. Select **NORMAL** on the Function Selector Switch.
5. Locate the programming module and use the Arrow Down key to scroll through LCD screens until CAL LEFT SIDE appears and press the YES button.
6. The CAL LEFT PUMP menu screen will be displayed. Place a 50 ml graduated cylinder under Dispense Tip and activate the Left dispenser momentarily. The dispenser will run the Left Concentrate Pump for 20 seconds and then shut OFF automatically.
7. Keep the graduated cylinder under dispense tip until all the concentrate has dripped out.
8. Measure the volume of concentrate collected in the graduated cylinder. The acceptable range for the volume collected for the 1/4" tubing is 50-60 ml.
9. If the amount collected is not within the acceptable range, empty the graduated cylinder and repeat STEPS 6 – 8.
10. If the amount collected is still not within range, replace the pump tubing with a new Tube Kit, (refer to the Tube Replacement Instructions).
11. When satisfied with the volume of concentrate collected, scroll down to the next menu screen.
12. The CAL LF PUMP VOL menu screen will be displayed. Use the (-) / (+) keys to adjust number displayed to the amount measured in STEP 8.

Repeat steps 2-11 to Calibrate the Middle and Right Pumps

### Dispenser Flow Rate Calibration

1. Press the Right hidden switch to display the ? WTR FLO menu screen.
2. Place a 2000 ml graduated container under Dispense Tip and press Left Dispense Switch momentarily. The dispenser will dispense water for 10 seconds and then shut OFF automatically.
3. Keep the graduated container under dispense tip until all the water stops dripping.
4. Measure the volume of water collected in the graduated container. The acceptable range for the volume collected is 1600 to 2000 mL.
5. If the amount collected is not within the acceptable range, empty the graduated container and repeat STEPS 1 -4.
6. If the amount collected is still not within range, inspect the dispense valves, tubing and mix chamber for lime, kinks or other obstructions.
7. When satisfied with the volume of concentrate collected, scroll down to the next menu screen.
8. The CAL WTR VOL screen will be displayed. Use the (-) / (+) keys to adjust number displayed to the amount measured in STEP 4.

## Field Calibrating the Empty BIB Warning

The dispenser will automatically display LEFT, MIDDLE or RIGHT BIB Empty when the corresponding Concentrate BIB is Empty. The Refill message is triggered when the Conductance Sensor reading drops below the minimum setting. The factory set minimum is 600 and should be correct for most locations. However, the hardness of the local water supply may affect this reading. If the Refill message doesn't come on when the BIB is empty or the message comes on too early and there is still concentrate left in the BIB, use the following procedure to find the correct Empty BIB threshold.

**Note:** Increasing the threshold slightly will cause the Empty BIB warning to come on sooner. Lowering the threshold will draw more concentrate from the BIB, but could allow dispensing of weak coffee.

1. Set the Function Switch to the "**Rinse**" position.
2. Place a 1/2 gal or larger container under the dispense tip, then activate and hold the left dispenser.
3. Dispense long enough to rinse all the concentrate out of the mix chamber and for the conductance reading "COND" on the LCD to stabilize and stop dropping.
4. Record the nominal Conductance value displayed. (NOTE: It is typical for this value fluctuate (+/- 25) points about the nominal value}. This is the conductance reading of the water in your area.
5. Add 100 points to Conductance value. This is the new Empty BIB threshold value for your dispenser.
6. Enter this new value into the Empty BIB Alarm threshold, see *Programming the Dispenser*.



