

## How to use this document

- In Acrobat Reader, use the table of contents links in the left window to move to the page you require.
- Click on any link in the Contents list below.
- Print out the sections you require.

## SOUNDWEB MASTER CONTENTS

■ Datasheets	2
■ Designer Software v1.50 Help File	20
■ Installation Guides	218
■ Serial Interface Kit documentation	288
■ Networking	322
■ Frequently Asked Questions	328
■ Extending RS-232 connections	332
■ 9010 Power Options	340
■ DXF Outline Drawings Reference	342
■ Architect's & Engineers Specifications	346
■ Software Release Notes	350
■ WHISEWORKS NTM filters white paper	370
■ Controlling other equipment via Soundweb	372
■ Colour Brochure	374



Click on the titles to reach the datasheets.

1. **9088ii Networked Signal Processor**
2. **9000ii Networked Signal Processor**
3. **9008 Networked Expansion Processor**
4. **9010 Programmable Controller**
5. **9012 Wall Panel**
6. **9014 Fibre Interface**
7. **9016 Video/Audio Matrix Switcher**
8. **9026 Audio Matrix Switcher**
9. **3088 Soundweb Lite Signal processor**
10. **9015 Wall Panel**

# Soundweb™ 9088*ii*s DSP System

# SOUNDWEB™



## Overview

The Soundweb 9088*ii*DSP unit is the heart of the Soundweb system. As a standalone single rack space device it has all the facilities required for a sound system processor - 8 inputs, 8 outputs, a DSP engine, networking for connection and signal distribution to other soundweb units, Analogue GPI control interfacing, and RS232 ports for external control by PC or AMX/Crestron type systems. Plug in an audio source, an amplifier, and speakers and you are away

All the facilities are included in a 9088*ii*, there is no additional Soundweb system hardware required to begin building physical systems. The only option decision to make is a choice of line input, mic/line input cards or AES/EBU Digital input/output cards. Each digital card accepts 2 stereo inputs at sample rates from 32kHz to 96kHz, and can output at 44.1, 48, 88.2, and 96kHz. When digital inputs are used, the analogue outputs remain in use as a mirror version of the digital output.

Each Soundweb 9088*ii* can typically hold up to 12 completely different system designs in its own memory. Programming the unit is accomplished via the Soundweb Designer software, available free of charge from BSS Audio (website [www.bss.co.uk](http://www.bss.co.uk)).

For safety-critical systems, the Soundweb 9088*ii* has an opto-isolated output which functions as a watchdog; the opto-isolator conducts when power is applied to the unit and the software is functioning correctly; it is cut off if there has been a power failure or other fault. This function can be used to trigger alarm systems or to construct redundant systems.

## Architects and Engineers Specifications

The Digital Signal Processor shall be a stand-alone unit of one rack space, capable of providing a fully-functional system with 8 analogue inputs and 8 analogue outputs, without the need for a dedicated, on-line computer system. The Analogue inputs shall have a remotely-adjustable gain stage prior to A/D conversion.

The system designer shall be provided complete flexibility in system configuration.

Line inputs or combination Microphone/Line inputs shall be provided, together with channel-selectable 48 volt phantom power for the microphone inputs. The unit shall provide a tamper-proof front-panel with no user-adjustable controls. Front panel LED indicators will provide monitoring of signal presence, clip and network status. Analogue/Digital/Analogue conversion shall be by 24-bit A-D converters and 24-bit D-A converters to provide maximum operating headroom and performance. The Dynamic Range shall be 105dB minimum (unweighted, 108dB A-weighted), with a THD figure of less than 0.01%.

Optional AES/EBU Digital input/output cards shall be available, each card having 2 stereo inputs and 2 stereo outputs. Input sample rates shall be accepted from digital sources with rates from 32kHz to 96kHz, and the user shall be able to select output sample rates of 44.1kHz, 48kHz, 88.2kHz, 96kHz or any sample rate between 32kHz and 96kHz using external clock synchronisation. Clock synchronisation shall be possible with the first digital input, the internal clock or an external word clock on a BNC connector.

Input and Output connections are provided via modular, Phoenix/Combitcon style hardware. Mating connectors (Phoenix/Combitcon MSTB 2.5/6-ST-5.08 or equivalent) shall be supplied with each unit on delivery or in advance.

The Signal Processor shall also be networkable over Category 5 cable (as established in the TIA/EIA-568-B standard), to provide 8 channels of audio signals and control data routing between processors for system expansion or communication. This network shall be terminated on RJ-45 connectors, and be stable over distances up to 1000 feet between units. There shall be available a fibre-optic converter to extend this distance to 1.2 miles. The network shall allow system expansion at a later date through the addition of further Signal Processors.

System Configuration shall be by a Personal Computer, which may be disconnected after configuration without affecting installed operation of the unit. Up to 12 System Configurations shall be stored in each processing device, and these configurations shall not be limited

by factory-only presets or pre-determined processing. It shall be possible to configure a number of system presets, which may be recalled at any time via the PC or external control devices.

The unit's software shall provide a palette of audio processing objects for use in system designs to include, but not be restricted to: Automatic Microphone Mixers, Ambient Noise Compensators, Crossovers, Compressors, Gates, Duckers, Expanders, Limiters, Gain blocks, Graphic Equalisers, Parametric Equalisers, Stereo Parametric Equalisers, Filters, Metering points, Delays, Mixers, Matrix Routers, Matrix Mixers, Source Matrices, Tone Generators, and Source Selectors. The software shall provide the facility to construct user-defined control panels incorporating elements of the processing object parameter controls. Multi-level password-based security shall protect the integrity of the system.

The device configuration window shall provide a DSP gauge to inform the designer as to the percentage of DSP usage. The system design software shall be compatible with either Windows 95 or Windows NT4, 32 bit operating systems.

The software shall provide a facility to create personalised, custom processing objects for use in system designs, with provision for intellectual property cloaking via Macros.

It shall be possible to connect standard potentiometers and switches or control voltages to 8 control input ports to allow non-technical operators to change system presets or variable parameters. An additional 8 control output ports shall provide logic outputs for purposes of signal indication, external switching systems, or other similar system control applications. An opto-isolated failsafe indicator shall be provided on an open-collector output.

Two RS-232 ports shall be provided to allow control of the unit from Multimedia Systems such as AMX, Crestron, Dataton, Avenger or other PC devices communicating in a serial mode, as well as independent, simultaneous control and programming from a PC operating Soundweb Designer software. The RS232 port on any device shall provide access to all devices that are properly networked together. It shall be possible to use multiple PC's connected to separate signal processors in a network to control the system. It shall also be possible to remotely control the system network using a PC & modem to connect over telephone lines to another modem connected to the system network.

To aid in system management, the software shall provide a method of event logging so that system diagnostics are available. This event log shall include failures, warnings and information notices, and shall display the time of the event occurrence and the device to which the event applies and the design file originally loaded.

- **8 Analogue Mic/Line Inputs and 8 Analogue Outputs**
- **Optional AES/EBU digital input/output (2xstereo) cards with external word clock input**
- **Standalone unit with 200MIPS of DSP resource**
- **Integral multivoltage PSU (85V - 270V AC)**
- **Analogue Control ports for GPI hardware interfacing eg faders, switches & LEDs**
- **Front and rear access RS232 ports for PC control**
- **Integral memory holds up to 12 DSP system designs.**
- **Optional lacing bar to secure cabling**



# Soundweb 9088*ii*s DSP System

# SOUNDWEB™

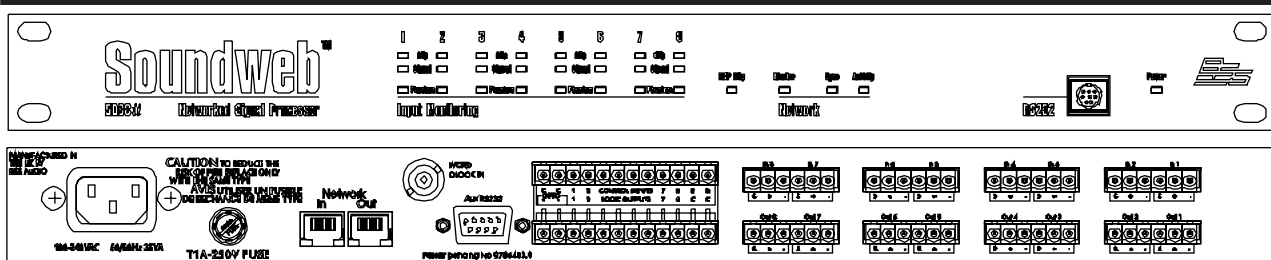

## 9088*ii*s Technical Specifications

<b>Inputs:</b>	8 Analogue, electronically balanced, on Phoenix/Combicon removable screw connectors.
<b>Line Inputs:</b>	Nominal gain 0dB, electronically switchable to gain, input impedance 10kOhm
<b>Mic/Line Inputs:</b>	Nominal gain 0dB, electronically switchable up to +72dB, in +6dB steps, input impedance 3.5kOhm
<b>Maximum input level</b>	+20dBu with 0dB input gain (+8dBu with 12dB gain)
<b>CMRR</b>	>75dB at 1KHz
<b>Equivalent Input Noise (EIN)</b>	<-128dBu typ with 150 Ohms source
<b>Phantom power:</b>	48V nominal, selectable per input
<b>AES/EBU Digital Inputs:</b>	2 x 2-channel inputs per card, sample rates accepted from 32 to 96kHz, auto selected, on Phoenix/Combicon removable screw connectors
<b>Outputs:</b>	8 Analogue, electronically balanced, on Phoenix/Combicon removable screw connectors.
<b>Maximum output level:</b>	+20dBu
<b>AES/EBU Digital Outputs:</b>	2 x 2-channel outputs per card, sample rates 44.1, 48, 88.2, 96kHz, user selectable, on Phoenix/Combicon removable screw connectors
<b>Digital Resolution:</b>	24 bit
<b>Frequency response:</b>	(+/-0.5dB) 15Hz to 20KHz
<b>THD:</b>	<0.01% (20Hz to 20KHz, +10dBu output)
<b>Dynamic range:</b>	105dB typ. (22Hz to 22KHz unweighted)
	108dB typ. (A-weighted)
<b>Crosstalk:</b>	<-75dB
<b>Mains voltage</b>	85-270V AC, 50/60Hz,
<b>Power Consumption</b>	<35VA
<b>Control ports (8 inputs and 8 outputs)</b>	
<b>Control input voltage:</b>	0 to 4.5V
<b>Control input impedance:</b>	4.7kOhms to +5V (2-wire mode) >1MOhm (3-wire mode)
<b>Logic output voltage</b>	0 or +5V unloaded
<b>Logic output impedance</b>	440 Ohm
<b>Opto output series impedance</b>	220 Ohms (isolated)
<b>Watchdog Output:</b>	Phoenix/Combicon connector for failsafe control.
<b>Opto Output current</b>	14mA max.
<b>Opto output withstanding voltage</b>	80V max. (Off)
<b>Network:</b>	2xRJ45 connectors for Soundweb network connection.
<b>Maximum network cable length</b>	300m/1000ft, longer distance using 9014 fibre converters
<b>Led Indicators:</b>	Signal Present (per input), CLIP (per input), network input active, network output active, network Master indicator.

## Input Connector Pin-outs

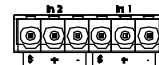

Each connector accommodates two inputs, pin 1 is on right when viewed from rear:

- Pin 1: Input 1 (3,5,7) Screen (ground)
- Pin 2: Input 1 (3,5,7) +ve (hot)
- Pin 3: Input 1 (3,5,7) -ve (cold)
- Pin 4: Input 2 (4,6,8) Screen (ground)
- Pin 5: Input 2 (4,6,8) +ve (hot)
- Pin 6: Input 2 (4,6,8) -ve (cold)

## Output Connector Pin-outs

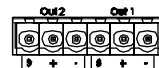

Each connector accommodates two inputs, pin 1 is on right when viewed from rear:

- Pin 1: Output 1 (3,5,7) Screen (ground)
- Pin 2: Output 1 (3,5,7) +ve (hot)
- Pin 3: Output 1 (3,5,7) -ve (cold)
- Pin 4: Output 2 (4,6,8) Screen (ground)
- Pin 5: Output 2 (4,6,8) +ve (hot)
- Pin 6: Output 2 (4,6,8) -ve (cold)

Digital cards have 2 inputs and 2 outputs per card, wired as above, with inputs to the right as viewed from the rear.

## Network Port pin-outs Pairs, according to TIA/EIA-568-B standard



- Pin 1 (White) with Pin 2 (Orange)
- Pin 3 (White/Green) with Pin 6 (Green)
- Pin 4 (Blue) with Pin 5 (White/Blue)
- Pin 7 (White/Brown) with Pin 8 (Brown)

## Control port pin-outs

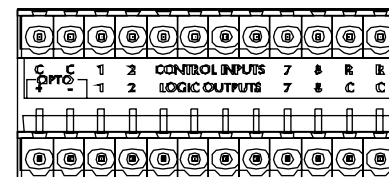

## Upper Row: Logic Inputs

- Pin 1, 2, : Common. Pin 11, 12 : Reference
- Pin 3,4,5,6,7,8,9,10: Logic Input

## Lower Row: Logic Outputs

- Pin 1, 2, 11, 12 : Common
- Pin 3,4,5,6,7,8,9,10: Logic Output

BSS Audio have a policy of continued product improvement and accordingly reserve the right to change features and specifications without prior notice. May 2005



**BSS Audio UK** A Division of Harman International Industries Ltd  
Cranborne House, Cranborne Road, Potters Bar,  
Hertfordshire, England, EN6 3JN  
Tel +44 (0)1707 660667, Fax +44 (0)1707 660755  
www.bss.co.uk/soundweb/  
email: soundweb@bss.co.uk

**Harman Music Group**  
8760 S. Sandy Parkway  
Sandy, Utah 84070  
Tel: 801-566-8800 Fax: 801-568-7662  
web: www.bssaudious.com

**H** A Harman International Company



# Soundweb 9000*iis* Network Hub

SOUNDWEB™



The Soundweb 9000*iis* Network hub is used to expand the routing capabilities of the Soundweb system. It has all the processing facilities of the 9088*iis* DSP unit; 200MIPS of DSP horsepower, analogue GPI control interfacing, and RS232 ports for external control by PC or AMX/Crestron type systems; but has 6 network ports instead of analogue inputs and outputs.

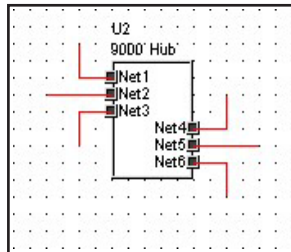

Like the 9088*iis*, each Soundweb 9000*iis* can hold up to 12 completely different system designs in its own memory. The DSP in a 9000*iis* hub is most often used for matrixing, mixing, and routing the signals from 9088*iis* devices, which are then free for signal processing.

The Soundweb 9000*iis* Hub occupies just a single rack space (1U) and includes its own power supply. Programming the unit is accomplished via the Soundweb Designer software, available free from BSS Audio.

For safety-critical systems, the Soundweb 9000*iis* has an opto-isolated output which functions as a watchdog: the opto-isolator conducts when power is applied to the unit and the software is functioning correctly; it is cut off if there has been a power failure or another fault. This function can be used to trigger alarm systems or to construct redundant systems.

The 9000*iis* Network Hub can be used to extend the matrixing and signal routing capabilities of a Soundweb System Network, and large systems can be constructed using one or more 9000*iis* hubs to interface with 9088*iis* devices.

As an example, a single 9000*iis* hub linked to three 9088*iis* devices can produce a fully matrixed 24 x 24 system.

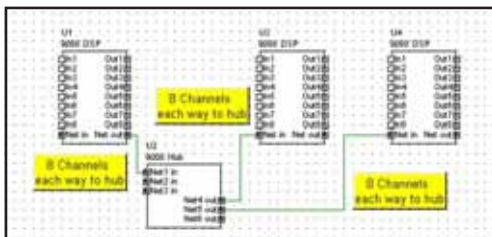

Hubs can also be connected to each other to form large signal busses. Again, as an example, a 24-way bus could be designed quite easily.



## Features

- 6 Network ports
- 200MIPS of DSP resource with all the DSP processing objects of the 9088
- Integral PSU
- Control ports for analogue GPI hardware interfacing
- Front and rear access RS232 ports for PC control
- Integral memory holds up to 12 DSP system designs.

## Compatibility with original Soundweb 9000 hubs (mark 1 units)

The 9000*iis* is a drop-in replacement for the original 9000 hub, and can be run without a change in the system design.

To get the maximum performance and features from the 9000*iis* model, the Soundweb Designer software must be upgraded to a version that supports the 9000*iis* (V1.30 or later), and the design file recompiled and loaded.

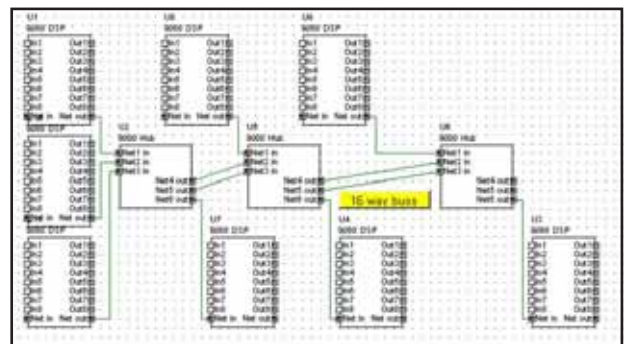

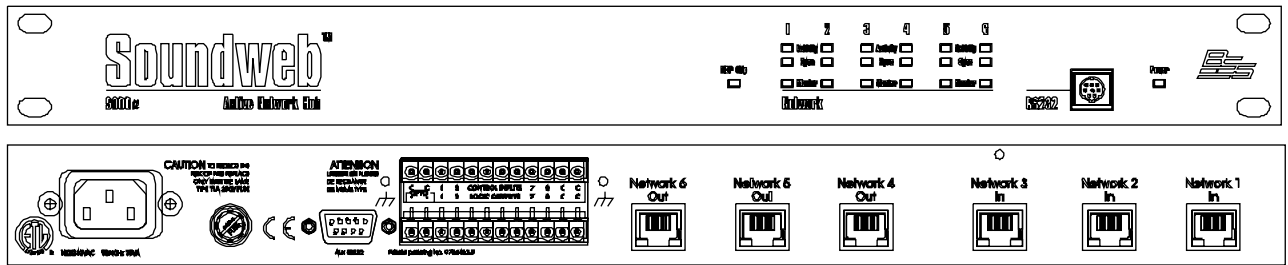

## Technical Specifications

**Power consumption** <35VA  
**Mains voltage** 85-270V AC, 50/60Hz

**Control ports:**  
**Control port inputs** 8  
**Control input voltage** 0 to 4.5v  
**Control input impedance** 4.7kOhms to +5V

**Control port outputs** 8  
**Logic output voltage** 0 or +5V unloaded  
**Logic output impedance** 440 Ohm  
**Opto output series impedance** 220 Ohms (isolated)

**Watchdog output:**  
**Fail safe connector** Phoenix/Combicon connector.  
**Opto output current** 14mA max.  
**Withstanding voltage** 80V max. (Off)

**Network connections:** 6xRJ45 connectors.  
**Max. network cable length** 300m/1000ft

**Led Indicators:** Network Activity, Network Sync, Network Master, DSP Clip, Power.

## Network Port pin-outs

Pairs, according to TIA/EIA-568-B standard



Pin 1 (White) with Pin 2 (Orange)  
 Pin 3 (White/Green) with Pin 6 (Green)  
 Pin 4 (Blue) with Pin 5 (White/Blue)  
 Pin 7 (White/Brown) with Pin 8 (Brown)

## Control port pin-outs

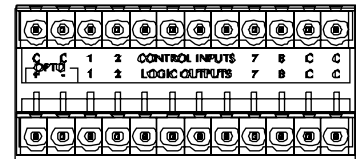

## Upper Row: Logic Inputs

Pin 1, 2, 11, 12 : Common  
 Pin 3,4,5,6,7,8,9,10: Logic Input

## Lower Row: Logic Outputs

Pin 1, 2, 11, 12 : Common  
 Pin 3,4,5,6,7,8,9,10: Logic Output

## Dual Redundant Ring System

Using Soundweb 9000iis hubs, it is possible to create a dual-redundant ring, where two network cables carry audio and control around a ring in both directions, so that if one cable is accidentally damaged, the other intelligently routes the signals to continue full operation.

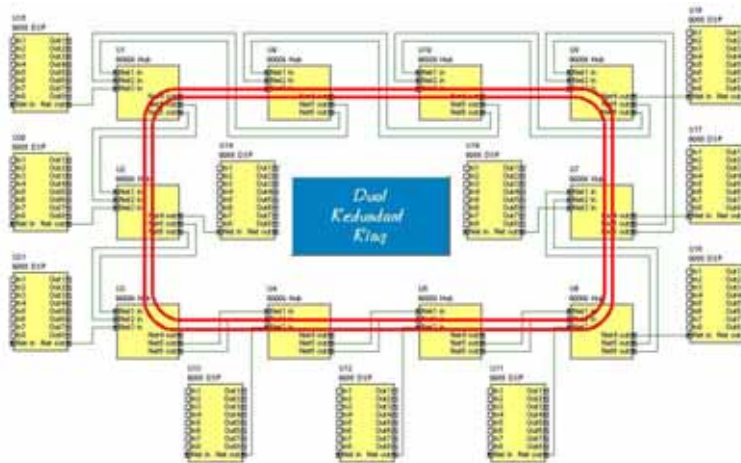

## Rear panel RS232 Port pin-outs



Pin 1: DCD      Pin 2: RX  
 Pin 3: TX      Pin 4: DTR  
 Pin 5: GND      Pin 6: DSR  
 Pin 7: RTS      Pin 8: CTS  
 Pin 9: N/C

*BSS Audio have a policy of continued product improvement and accordingly reserve the right to change features and specifications without prior notice. May 2005*



**BSS Audio UK** A Division of Harman International Industries Ltd  
 Cranborne House, Cranborne Road, Potters Bar,  
 Hertfordshire, England, EN6 3JN  
 Tel +44 (0)1707 660667, Fax +44 (0)1707 660755  
 www.bss.co.uk  
 email: info@bss.co.uk

**Harman Music Group**  
 8760 S. Sandy Parkway  
 Sandy, Utah 84070  
 Tel: 801-566-8800 Fax: 801-568-7662  
 web: www.bssaudious.com  
**H** A Harman International Company

# Soundweb™ 9008*iis* Networked Processor

**SOUNDWEB**  
TM

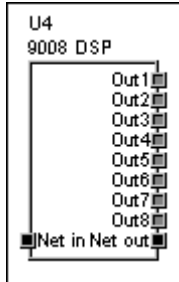

BSS Audio introduces a significant addition to the Soundweb range. The 9008*iis* hardware device is an expansion unit for Soundweb systems where more outputs are needed, but input sources are already covered using 9088*iis*'s. The 9008*iis* is almost identical to the 9088*iis*, and delivers the same dsp and control capabilities, but lacks any input circuitry. By dispensing with the input cards, and associated sockets the 9008*iis* is cost effective in situations where extra inputs are unnecessary.

The unit is envisaged to be especially useful providing additional outputs for larger systems where each additional 9008*iis* can route and process up to 8 channels of audio to its balanced outputs. Also with its built in networking capabilities the 9008*iis* can communicate with all the other Soundweb devices on the network.

Front and rear RS232 ports are provided for programming, upgrade access and for connection to control systems such as AMX, Crestron or similar. For safety-critical systems, the Soundweb 9008*iis* has an opto-isolated output which functions as a watchdog to trigger alarm systems or to construct redundant systems. Programming the unit is accomplished using Soundweb Designer software, available free from the BSS Audio website, [www.bss.co.uk](http://www.bss.co.uk).

- » **8 Analogue Outputs.**
- » **200MIPS of DSP resource.**
- » **Integral multivoltage PSU, (85V - 270V AC).**
- » **Analogue control ports for GPI hardware interfacing; eg faders, switches & LEDs.**
- » **Front and rear access RS232 ports for PC control.**
- » **Integral memory holds up to 12 DSP system designs.**
- » **Supported in Soundweb Designer v1.22 and above.**
- » **Optional cable lacing bar.**

## 9008*iis* Technical Specifications

### General

DSP capability	200MIPS (Million Instructions Per Second)
Frequency response	15Hz to 20kHz (+/-0.5dB)
Total Harmonic Distortion (THD)	<0.01% (20Hz to 0kHz, +10dBu output)
Dynamic range	105dB typical (22Hz to 22kHz unweighted) 108dB typical (A-weighted)
Maximum output level	+20dBu
Inter-channel crosstalk	<-75dB
Maximum network cable length	300m/1000ft
Mains supply	85-270V AC, 50/60Hz
Power consumption	<35VA

### Control Ports

Control input voltage	0 to 4.5v
Control input impedance (2 wire mode)	4.7kOhms to +5V
Control input impedance (3 wire mode)	>1MOhm
Logic output voltage	0 or +5V unloaded
Logic output impedance	440 Ohm
Opto output current	14mA max
Opto output withstanding voltage	80V max
Opto output series impedance	220 Ohms (isolated)



**BSS Audio UK** A Division of Harman International Industries Ltd  
Cranborne House, Cranborne Road, Potters Bar,  
Hertfordshire, England, EN6 3JN  
Tel +44 (0)1707 660667, Fax +44 (0)1707 660755  
[www.bss.co.uk](http://www.bss.co.uk)  
email:info@bss.co.uk

**Harman Music Group**  
8760 S. Sandy Parkway  
Sandy, Utah 84070  
Tel: 801-566-8800 Fax: 801-568-7662  
web: [www.bssaudious.com](http://www.bssaudious.com)

**H** A Harman International Company

# Soundweb™ 9010 Programmable Remote

# SOUNDWEB™

The Soundweb 9010 Remote control is the long awaited solution to the problem of providing a sophisticated system control interface which requires no technical knowledge to operate.

The 9010 extends the already outstanding flexibility of the Soundweb system by providing multi-purpose programmable remote control. The 9010 has a rotary encoder and 6 push buttons which are labelled by a graphic LCD display.

The encoder and each button can be used to adjust almost any processing parameter within a Soundweb network; the user sets up the functions in the Soundweb Designer software. Multiple 'control pages' can be constructed with navigation between them and password protection, i.e. a button can have a different function in each page.



- **Backlit graphic liquid crystal display with programmable layout.**
- **One programmable continuous rotary encoder to adjust parameters.**
- **Six programmable pushbuttons.**
- **Internal electret capsule microphone with computer-controlled gain.**
- **External dynamic microphone input with computer-controlled gain.**
- **Two channel audio output.**

In addition to its control facilities, the 9010 provides an internal capsule microphone, an external microphone input, and two channels of audio output.

With suitable external amplification and loudspeakers, the audio outputs can be used for local monitoring of network audio signals or local communications.

The 9010 connects into the Soundweb network using RJ-45 connectors and category 5 cable, just like any other Soundweb device. The 9010 is powered from a standard 24V DC power supply; BSS provide a suitable supply capable of powering up to four 9010s. The optional 9011 adapter allows power to be sent to a daisy chain of 9010s down the network cable.

## Technical Specifications

**Mic Input:** 18 Bit A/D Conversion  
External Input Specifications  
Dynamic Range: 81dB  
(22Hz to 22kHz unweighted)  
Gain Control Range: 34dB to 72.5dB  
Max. Input Level: -14dBu  
EIN: -106dBu @ 150 Ohm

**Audio Output:** 18 Bit D/A Conversion  
Dynamic Range: >88dB  
(22Hz to 22kHz unweighted)  
Frequency Response: 30Hz to 20kHz, +/-0.5dB  
THD: <0.05%  
(20Hz-20kHz, 0dBu)  
Max. Output Level: +4dBu  
Channel Separation: 80dB, 20Hz-20kHz

**Power Requirements:** +24V DC, <5VA

BSS Audio offer a universal AC input +24V DC power supply (Z-999-PSU) and the interface adapter (Z-SW9011). The PSU may connect directly to a SW9010, or connect via the interface adapter where power will be supplied via the network.

### Software

Requires Soundweb Designer V1.14 or later.

The 9010 is fitted in a sturdy steel case, and is designed to mount in a standard US 3 gang outlet box.

BSS Audio have a policy of continued product improvement and accordingly reserve the right to change features and specifications without prior notice.





# Soundweb™ 9010 Programmable Remote

# SOUNDWEB™

## Programming the 9010

To program the 9010, the 'Button Setup' function within Soundweb Designer opens a design window which allows the user to decide the functions of each button and the encoder; whether it is to adjust parameters, trigger presets or change menu pages. The 9010 can control virtually any parameter of any Soundweb 9088, 9008 or 9000 device on the network.

For example, to assign a button to a fader to control gain, it is simply a matter of opening the gain control panel (in design mode) and dragging the fader object onto the desired button. The button adds default text, which may be changed with the text tool. When the button is pressed on the actual remote, the encoder will then control that fader.

Parameter controls, presets and parameter presets can all be placed onto buttons. Buttons can also be used to address new menu pages, by first creating a new page, then programming a button to access that page. These pages can be password protected for security. In this way, some functions can be left for general facility staff to operate, while other functions are secured for technician use only.

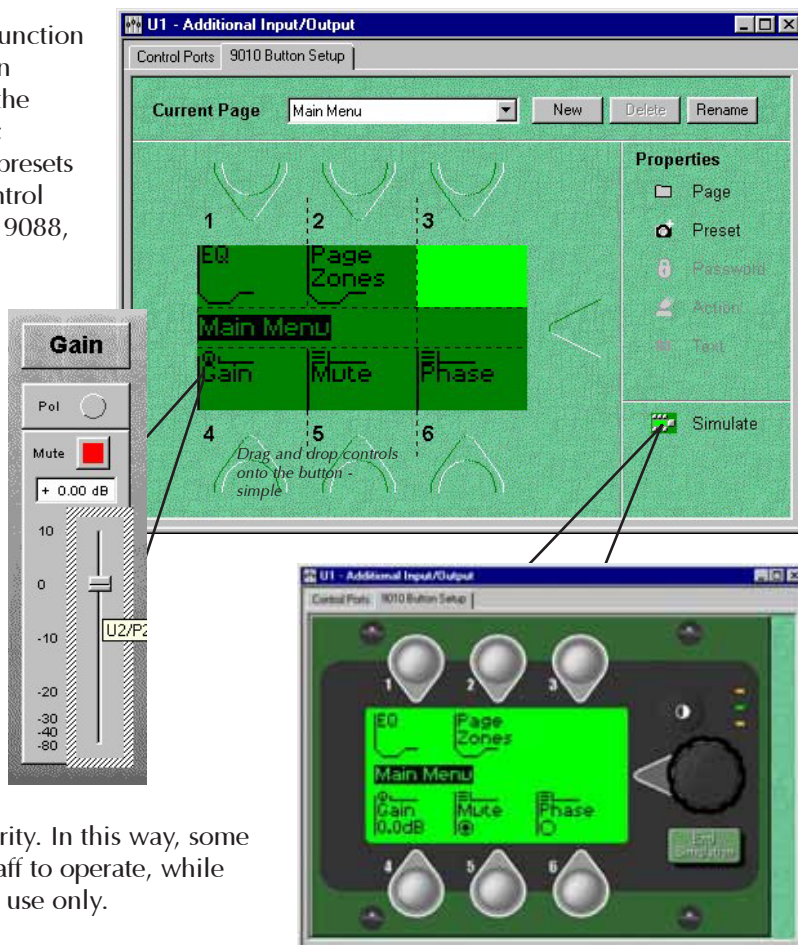

## Mechanical Installation

The 9010 Remote is designed to fit into a standard US 3-gang wallbox (available from BSS Audio) using the screws provided with the unit. We also offer a decorative bezel that fits around the 9010 when mounted in this box.

## Ordering Information

Z-SW9010	9010 Programmable Remote
Z-SW9011	Interface Power Adapter
Z-999-PSU	Universal 24V PSU
Z-010-BEZEL	Decorative bezel for 9010 Remote
Z-010-WALLBOX	Standard metal 3-gang mounting box

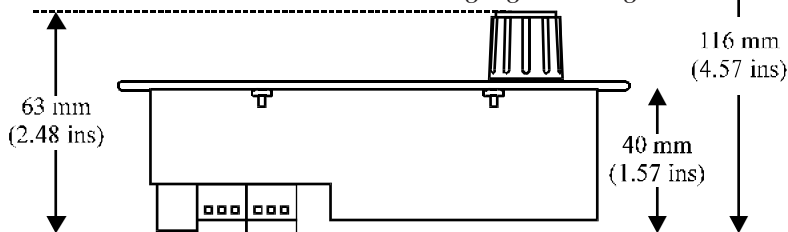

## Dimensions

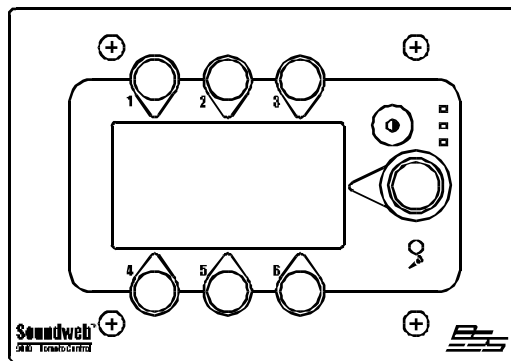
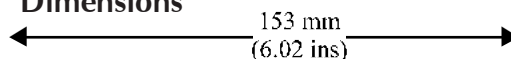

Once the design is complete, using the SIMULATE function allows you to check and debug the set up to ensure all the functions operate as expected, prior to compiling and loading the program into the 9010 device.

**BSS Audio UK** A Division of Harman International Industries Ltd  
 Cranborne House, Cranborne Road, Potters Bar,  
 Hertfordshire, England, EN6 3JN  
 Tel +44 (0)1707 660667, Fax +44 (0)1707 660755  
 www.bss.co.uk/soundweb/  
 email: soundweb@bss.co.uk

**Harman Music Group**  
 8760 S. Sandy Parkway  
 Sandy, Utah 84070  
 Tel: 801-566-8800 Fax: 801-568-7662  
 web: www.bssaudious.com



# Soundweb™ 9012 Wall Panel

# SOUNDWEB™

## Overview

The Soundweb 9012 Wall Panel is a simple hardware interface to the Soundweb Programmable DSP system.

It provides a quick and easy way for designers to provide a rotary fader control and source select (or other multiway switch function) in a standard UK-sized light switch panel mounting.

Using Soundweb Designer to 'map' functions onto the 9088*iis* control ports, these hardware controls can then be used to provide local control of, for example, volume, source select, or parameter presets.

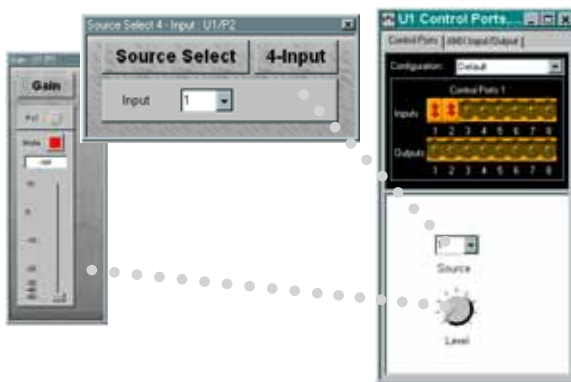

Connection is via the Soundweb standard Phoenix/Combicon removable screw terminal connectors. Three terminals are used for common, switch output and fader output.

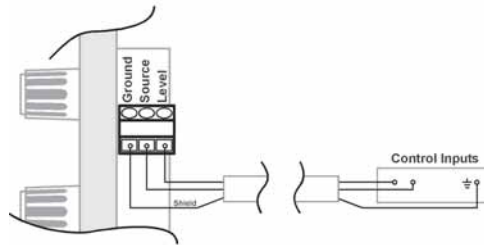

The switch has blank ident areas for marking the switch positions, either directly onto the white area or on self-adhesive labels. A set of 'standard' labels in 4 languages (English, French, German & Spanish) are supplied with the 9012 which should cover most locational requirements.

Additional or replacement switches and potentiometers are available from BSS Audio under the following part numbers:

**Rotary Switch: DH10007**

**Potentiometer: DM10018**



## 9012 Features

- Rotary fader for Volume control etc.
- 5-way rotary switch for source select etc.
- Standard UK light-switch fitting or US fitting in Beige

## Connector Pin-outs

### GND:

Common Connection (to Control Ports COMMON pin)

**1: SOURCE SELECT/PRESET**  
connection (switch)

**2: LEVEL**  
connection (rotary fader)



**BSS Audio UK** A Division of Harman International Industries Ltd  
Cranborne House, Cranborne Road, Potters Bar,  
Hertfordshire, England, EN6 3JN  
Tel +44 (0)1707 660667, Fax +44 (0)1707 660755  
www.bss.co.uk/soundweb/  
email: soundweb@bss.co.uk

**Harman Music Group**  
8760 S. Sandy Parkway  
Sandy, Utah 84070  
Tel: 801-566-8800 Fax: 801-568-7662  
web: www.bssaudious.com

**H** A Harman International Company



# Soundweb™ 9014 Fibre Interface

# SOUNDWEB™

## Fibre for long distance

The 9014 Fibre Interface has been designed to extend the networking capabilities of the Soundweb system. Using the 9014 Fibre System, the distance between Soundweb devices can be increased to 1.2 miles (2km).



## Fibre for noise immunity

The added advantage of using a fibre system is that fibre itself is totally immune to outside noise and interference, so your audio signals remain pristine from end to end.



## Installation

A pair of 9014 Fibre Interface units are used to replace a standard category 5 Soundweb network cable. Each fibre cable will transfer 8 channels of digital audio plus control data.

To utilise the fibre system, each end of the fibre link requires one 9014 device. Each device is equipped with an RJ-45 Soundweb network cable jack into which the network cable is connected, and two snap-in SC type fibre connectors.

Two fibre cables are then required to connect between 9014 devices - this is to enable the bi-directional audio transfer.

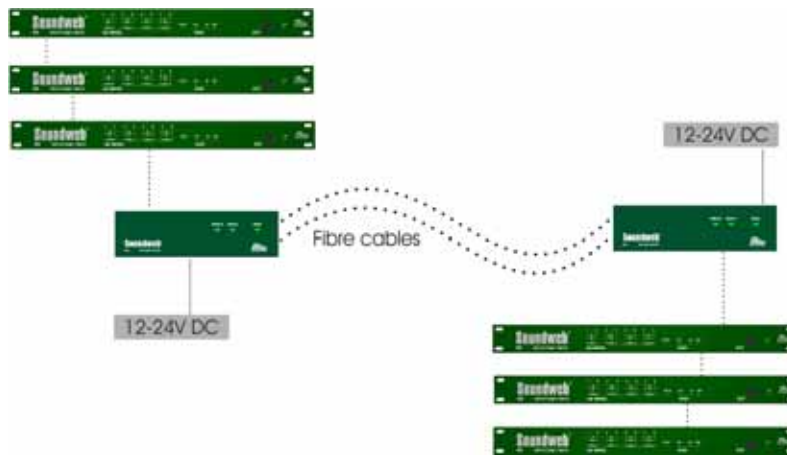

Each 9014 device requires a DC supply of 12V to 24V DC (BSS part Z-999-PSU). This PSU is capable of powering 8 9014 Fibre Interface modules. Power can be shared with the 9010 Remote Control, but not via the network cable.

## Multiple 9014 Interfaces

A mounting panel is available so that up to three 9014 devices may be installed in a single rack space.

## Technical Specifications

<b>Power</b>	
DC Supply:	12-24V DC, <5VA
Connector:	Phoenix screw terminal or 2.4mm inline barrel connector
Network:	Single RJ-45 Can be input node or output node - auto-sensed (no setup required)
Fibre Connections:	Snap-in SC fibre input Snap-in SC fibre output
Fibre cable:	Multimode 62.5/125um or Multimode 50/125um
Optical Power Budget:	10dB
Indicators:	Power led Fibre Link Active led Network cable present led
Max fibre length	2000 metres/ 6550 feet/ 1.2 miles
Dimensions	5.3" x 5.5" x 1.4" 135 x 139 x 36mm

Three 9014 devices can be mounted side-by-side in a 1U panel (available from BSS Audio). The panel can be used to rackmount a single or two 9014 devices if required, and can be fitted with the Z-999-PSU in this case.

BSS Audio offer a universal AC input +24V DC power supply (Z-999-PSU).

*BSS Audio have a policy of continued product improvement and accordingly reserve the right to change features and specifications without prior notice.  
May 2005*

**BSS Audio UK** A Division of Harman International Industries Ltd  
Cranborne House, Cranborne Road, Potters Bar,  
Hertfordshire, England, EN6 3JN  
Tel +44 (0)1707 660667, Fax +44 (0)1707 660755  
www.bss.co.uk  
email: info@bss.co.uk



**Harman Music Group**  
8760 S. Sandy Parkway  
Sandy, Utah 84070  
Tel: 801-566-8800 Fax: 801-568-7662  
web: www.bssaudious.com  
**H** A Harman International Company

# SW9016 Video/Audio Matrix Switcher

# SOUNDWEB™



Expanding the applications of Soundweb is the SW9016 Video/Audio Matrix Switcher, allowing video and audio sources to be routed by Soundweb Designer presets or simple remote control.

Integrating Soundweb Audio Processing and Networking with these switchers provides a unique and totally integrated multimedia processing system for Theme Bars, Restaurants, Clubs, Home Theatre Systems, Videoconferencing, Corporate Boardrooms, Classrooms and other environments where there may be several areas, each requiring it's own video/audio feed possibilities. In these systems, the theme is very much 'video follows audio' in that the video feeds are switched when the audio sources are re-routed according to event need.

The SW9016 features 8 video source inputs (NTSC or PAL) on BNC connections, along with 16 balanced audio inputs which allow easy input expansion for Soundweb audio inputs. Four video output zones are fed from BNC connectors with 8 balanced audio outputs.

In addition to seamless integration within Soundweb systems, the SW9016 is equally suited to stand alone operation. When used in this way it can be used as simple routing switches or alternatively loaded with up to eight pre-sets that allow any combination of audio/video routing and audio level to be instantly recalled in up to four independent zones. If no pre-sets are loaded, the units automatically default to a simple four zone source selector with 'audio follows video' routing, audio level control being independent for each zone.

Control can be remote via RS232 using simple string commands, or local from a contact closure port, for example using up to four 9012 panels. The baud rate of the RS232 can be changed to suit the application. BSS can also supply an 'active X' plugin to aid the easy integration with bespoke windows based control applications.

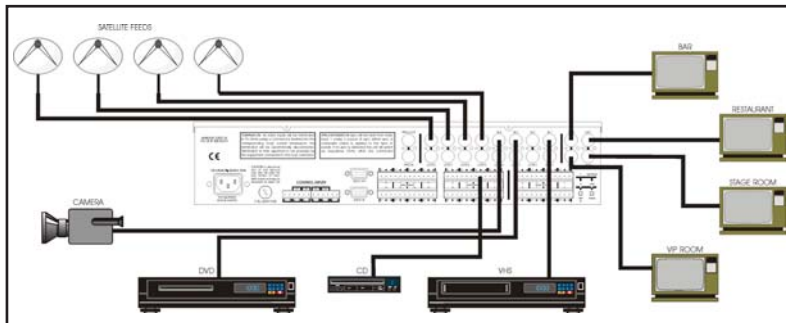

BSS Audio supplies a standalone PC program that can be used to both set-up and control the devices when they are not part of a Soundweb system. To increase flexibility, up to two SW9016s may be connected to a single Soundweb or other RS232 device.

## SW9016 Video/Audio Switcher Features

- ▶▶ 8 Video input sources and 16 audio inputs matrixable to 4 video outputs and 8 balanced audio outputs, either audio-follows-video or independently, with audio output level controls
- ▶▶ Controlled via Soundweb Designer or 9010/9012 controller presets, or a standalone PC application
- ▶▶ Simple control via simple switches
- ▶▶ 2 units may be cascaded to increase capacity

## Seam-free switching

The SW9016 is capable of switching the video during the 'vertical blanking interval' which will provide interference free switching between video sources that are synchronised. Sync can be taken from either a dedicated sync input or from video input 1. A 'sync out' connector is provided for connection to other equipment. If no sync is detected, the SW9016 will switch after 25ms thereby preventing it from locking up if sync is lost.

Each video input is provided with a 'loop' connection to allow daisy chaining. Plugging a cable into the loop connector automatically disconnects the 75Ohm termination inside the unit to avoid double terminating the source.

Preliminary  
Information  
March 2002



# SW9016 Video/Audio Matrix Switcher

**SOUNDWEB**  
**TM**

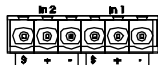
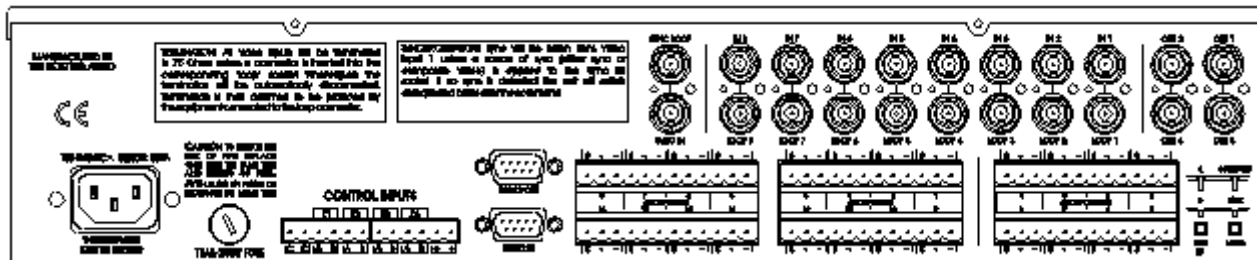

## Audio Input Connector

Each 6-way connector accommodates two inputs, pin 1 is on right when viewed from rear:

- Pin 1: Input 1 (3,5,7,9,11,13,15) Screen (ground)
- Pin 2: Input 1 (3,5,7,9,11,13,15) +ve (hot)
- Pin 3: Input 1 (3,5,7,9,11,13,15) -ve (cold)
- Pin 4: Input 2 (4,6,8,10,12,14,16) Screen (ground)
- Pin 5: Input 2 (4,6,8,10,12,14,16) +ve (hot)
- Pin 6: Input 2 (4,6,8,10,12,14,16) -ve (cold)



## Video Input and Output Connector

Centre - Signal, Outer - Ground

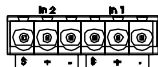

## Audio Output Connector

Each 6-way connector accommodates two outputs, pin 1 is on right when viewed from rear:

- Pin 1: Input 1 (3,5,7,9,11,13,15) Screen (ground)
- Pin 2: Input 1 (3,5,7,9,11,13,15) +ve (hot)
- Pin 3: Input 1 (3,5,7,9,11,13,15) -ve (cold)
- Pin 4: Input 2 (4,6,8,10,12,14,16) Screen (ground)
- Pin 5: Input 2 (4,6,8,10,12,14,16) +ve (hot)
- Pin 6: Input 2 (4,6,8,10,12,14,16) -ve (cold)

## Control port pin-outs

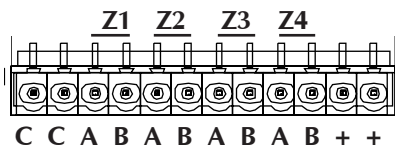

## Preset/Zone Trigger Inputs

Pin 1 is on right when viewed from rear:

- Pin 1, 2, : +5V. Pin 11, 12 : Common
- Zone Mode
- Pin A Source Select, Pin B Gain
- Preset Mode
- Use Z1 connections only

## Technical Specifications

### Video Inputs

8 Composite Video inputs (CBVS or SVideo) on BNC connectors with BNC loopthrough connectors  
 Video Standard PAL or NTSC (auto selected)  
 Video Bandwidth 150Mhz  
 Video Crosstalk <70dB up to 10MHz  
 Sync Automatically either Channel 1 or 'Sync' input  
 Impedance 75 Ohm self-terminating  
 Routing 8x4 Video Matrix  
**Video outputs** 4 x 75Ohm Composite Video Outputs on BNC connectors

### Audio Inputs

16 Balanced Audio inputs on Phoenix Combicon removable screw connectors.  
 Routing 16x8 Audio Matrix, each channel independently addressable  
 Input Impedance 10kOhm  
 Maximum Input Level +20dBu  
 THD <0.02%  
 Frequency Response 20Hz-20kHz +0/-0.2dB  
 S/N Ratio >110dB at unity gain  
 Crosstalk <-100dB  
 CMRR >40dB

### Audio Outputs

8 Balanced Audio Outputs on Phoenix Combicon removable screw connectors.  
 Output gain adjustable, -inf to +20dB

### Control & Presets

Presets 8 presets per video output zone when used with standalone PC app  
 Serial Control Port RS232 connects to Soundweb 9088iis, 9008iis or 9000iis or PC

### Dimensions

2RU (3.5") high, 19" wide, 6.6" deep (89mm x 445mm x 168mm)

### Weight

3kgs (6.6lbs)

*BSS Audio have a policy of continued product improvement and accordingly reserve the right to change features and specifications without prior notice. May 2005*

Preliminary Information  
 March 2002



**BSS Audio UK** A Division of Harman International Industries Ltd  
 Cranborne House, Cranborne Road, Potters Bar,  
 Hertfordshire, England, EN6 3JN  
 Tel +44 (0)1707 660667, Fax +44 (0)1707 660755  
 www.bss.co.uk/soundweb/  
 Email: soundweb@bss.co.uk

**Harman Music Group**  
 8760 S. Sandy Parkway  
 Sandy, Utah 84070  
 Tel: 801-566-8800 Fax: 801-568-7662  
 web: www.bssaudious.com  
**H** A Harman International Company

# SW9026 Audio Matrix Switcher

SOUNDWEB  
DESIGNER  
TM

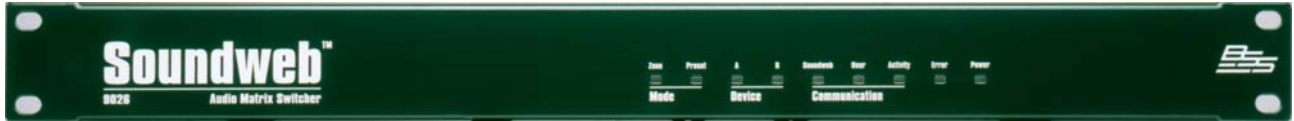

Expanding the applications of Soundweb is the SW9026 Audio Matrix Switcher, allowing multiple audio sources to be routed by Soundweb Designer presets or simple remote control.

Integrating Soundweb Audio Processing and Networking with these switchers provides the ability to route selected inputs from a number of sources. There are many instances where only a number of signals from multiple sources are required simultaneously, and the SW9026 permits low-cost input expansion for Soundweb systems, as well as offering a standalone solution for source selection and matrixing.

The SW9026 features sixteen balanced audio inputs, and the eight balanced outputs can then feed a Soundweb 9088ii for processing and further zone distribution.

In addition to seamless integration within Soundweb systems, the SW9016 is equally suited to stand alone operation. When used in this way it can be used as a simple switcher or alternatively loaded with up to eight pre-sets that allow any combination of audio routing and level to be instantly recalled in up to four independent stereo zones. If no pre-sets are loaded, the units automatically default to a simple four zone source selector with 'audio follows video' routing, audio level control being independent for each zone.

Control can be remote via RS232 using simple string commands, or local from a contact closure port, for example using up to four SW9012 wall panels. The baud rate of the RS232 can be changed to suit the application. BSS can also supply an 'active X' plugin to aid the easy integration with bespoke windows based control applications.

BSS Audio supplies a standalone PC program that can be used to both set-up and control the devices when they are not part of a Soundweb system. To increase flexibility, up to two SW9026s may be connected to a single Soundweb or other RS232 device.

## SW9026 Audio Switcher Features

- ▶▶ 16 balanced audio inputs matrixable to 8 balanced audio outputs, freely assignable
- ▶▶ Controlled via Soundweb Designer or 9010/9012 controller presets, or a standalone PC application
- ▶▶ Simple control via simple switches
- ▶▶ 2 units may be cascaded to increase capacity

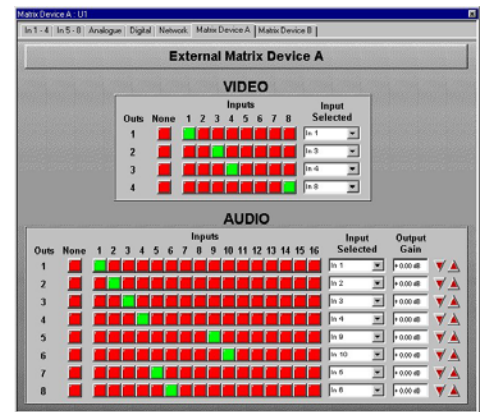

*Both the SW9016 Video/Audio Matrix Switcher and SW9026 Audio Matrix Switcher are programmable within Soundweb Designer*

*Preliminary  
Information  
March 2002*





# SW9026 Audio Matrix Switcher

# Soundweb™

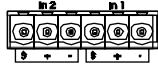

## Audio Input Connector

Each connector accommodates two inputs, pin 1 is on right when viewed from rear:

Pin 1: Input 1 (3,5,7,9,11,13,15) Screen (ground)  
 Pin 2: Input 1 (3,5,7,9,11,13,15) +ve (hot)  
 Pin 3: Input 1 (3,5,7,9,11,13,15) -ve (cold)  
 Pin 4: Input 2 (4,6,8,10,12,14,16) Screen (ground)  
 Pin 5: Input 2 (4,6,8,10,12,14,16) +ve (hot)  
 Pin 6: Input 2 (4,6,8,10,12,14,16) -ve (cold)

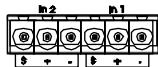

## Audio Output Connector

Each connector accommodates two outputs, pin 1 is on right when viewed from rear:

Pin 1: Input 1 (3,5,7,9,11,13,15) Screen (ground)  
 Pin 2: Input 1 (3,5,7,9,11,13,15) +ve (hot)  
 Pin 3: Input 1 (3,5,7,9,11,13,15) -ve (cold)  
 Pin 4: Input 2 (4,6,8,10,12,14,16) Screen (ground)  
 Pin 5: Input 2 (4,6,8,10,12,14,16) +ve (hot)  
 Pin 6: Input 2 (4,6,8,10,12,14,16) -ve (cold)

## Control port pin-outs

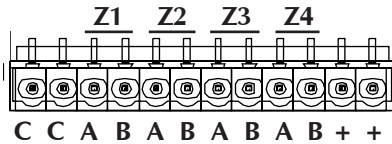

## Preset/Zone Trigger Inputs

Pin 1 is on right when viewed from rear:

Pin 1, 2, : +5V. Pin 11, 12 : Common  
 Zone Mode  
 Pin A Source Select, Pin B Gain  
 Preset Mode  
 Use Z1 connections only

## Technical Specifications

<b>Audio Inputs</b>	16 Balanced Audio inputs on Phoenix Combicon removable screw connectors.
<b>Routing</b>	16x8 Audio Matrix, each channel independently addressable
<b>Input Impedance</b>	10kOhm
<b>Maximum Input Level</b>	+20dBu
<b>THD</b>	<0.02%
<b>Frequency Response</b>	20Hz-20kHz +0/-0.2dB
<b>S/N Ratio</b>	>110dB at unity gain
<b>Crosstalk</b>	<-100dB
<b>CMRR</b>	>40dB
<b>Audio Outputs</b>	8 Balanced Audio Outputs on Phoenix/Combicon removable screw connectors.
<b>Output gain</b>	adjustable, -inf to +20dB
<b>Control &amp; Presets</b>	
<b>Presets</b>	8 presets per video output zone when used with standalone PC app
<b>Serial Control Port</b>	RS232 connects to Soundweb 9088ii, 9008ii or 9000ii or PC
<b>Dimensions</b>	1RU (3.5") high, 19" wide, 6.6" deep (45mm x 445mm x 168mm)
<b>Weight</b>	2.3kgs (5lbs)

*BSS Audio have a policy of continued product improvement and accordingly reserve the right to change features and specifications without prior notice. May 2005*

Preliminary  
 Information  
 March 2002



**BSS Audio UK** A Division of Harman International Industries Ltd  
 Cranborne House, Cranborne Road, Potters Bar,  
 Hertfordshire, England, EN6 3JN  
 Tel +44 (0)1707 660667, Fax +44 (0)1707 660755  
 www.bss.co.uk/soundweb/  
 email: soundweb@bss.co.uk

**Harman Music Group**  
 8760 S. Sandy Parkway  
 Sandy, Utah 84070  
 Tel: 801-566-8800 Fax: 801-568-7662  
 web: www.bssaudious.com  
**H** A Harman International Company

# Soundweb™ lite 3088 Signal Processor

# SOUNDWEB™



## Overview

For applications requiring a maximum 8 inputs and 8 outputs, the Soundweb lite 3088 has all the facilities required for a sound system processor; 8 inputs and outputs, a DSP engine, analogue GPI control interfacing, and RS232 ports for external control by PC or AMX/Crestron type systems. The 3088 integrates with the 9012 and 9015 wall panels, and with the 9016 and 9026 Video/Audio Matrix Switchers, and is highly suited for use in small bars, restaurants, houses of worship, boardrooms and clubs, and many other applications.

Options include the choice of line input, mic/line input cards or AES/EBU Digital input/output cards which accept 2 stereo inputs at sample rates from 32kHz to 96kHz, and can output at 44.1, 48, 88.2, and 96kHz. When digital inputs are used, the analogue outputs remain in use as a mirror version of the digital output.

Each Soundweb 3088 can typically hold up to 12 completely different system designs in its own memory. Programming the unit is accomplished via the Soundweb Designer software, available free of charge from the BSS Audio website ([www.bss.co.uk](http://www.bss.co.uk)), and of course custom control panels may be constructed on the PC.

For safety-critical systems, the Soundweb 3088 has an opto-isolated output which functions as a watchdog. The opto-isolator conducts when power is applied to the unit and the software is functioning correctly, but stops conducting in the event of a power failure or other fault. This function can be used to trigger alarm systems.

- » **8 Analogue Mic/Line Inputs and 8 Analogue Outputs**
- » **Optional AES/EBU digital input/output (2 x stereo) cards with external word clock input**
- » **Standalone unit with 200MIPS of DSP resource**
- » **Integral multivoltage PSU (85V - 270V AC)**
- » **Analogue Control ports for GPI hardware interfacing e.g. faders, switches, LEDs**
- » **Front and rear access RS232 ports for PC control**
- » **Integral memory holds up to 12 DSP system designs.**
- » **Optional lacing bar to secure cabling**

## Architects and Engineers Specifications

The Digital Signal Processor shall be a stand-alone unit of one rack space, capable of providing a fully-functional system with 8 analogue inputs and 8 analogue outputs, without the need for a permanent and dedicated, on-line computer system. The Analogue inputs shall have a remotely-adjustable gain stage prior to A/D conversion.

The system designer shall be provided complete flexibility in system configuration.

Line inputs or combination Microphone/Line inputs shall be provided, together with channel-selectable 48 volt phantom power for the microphone inputs. The unit shall provide a tamper-proof front-panel with no user-adjustable controls. Front panel LED indicators will provide monitoring of signal presence, clip and network status. Analogue/Digital/Analogue conversion shall be by 24-bit A-D converters and 24-bit D-A converters to provide maximum operating headroom and performance. The Dynamic Range shall be 105dB minimum (unweighted, 108dB A-weighted), with a THD figure of less than 0.01%.

Optional AES/EBU Digital input/output cards shall be available, each card having 2 stereo inputs and 2 stereo outputs. Input sample rates shall be accepted from digital sources with rates from 32kHz to 96kHz, and the user shall be able to select output sample rates of 44.1kHz, 48kHz, 88.2kHz, 96kHz or any sample rate between 32kHz and 96kHz using external clock synchronisation. Clock synchronisation shall be possible with the first digital input, the internal clock or an external word clock on a BNC connector.

Input and Output connections are provided via modular, Phoenix/Combincon style hardware. Mating connectors (Phoenix/Combincon MSTB 2.5/6-ST-5.08 or equivalent) shall be supplied with each unit on delivery or in advance.

System Configuration shall be by a Personal Computer, which may be disconnected after configuration without affecting installed operation of the unit. Up to 12 System Configurations shall be stored in each processing device, and these configurations shall not be limited by factory-only presets or predetermined processing. It shall be possible to configure a number of system presets, which may be recalled at any time via the PC or external control devices.

The unit's software shall provide a palette of audio processing objects for use in system designs to include, but not be restricted to: Automatic Microphone Mixers, Ambient

Noise Compensators, Crossovers, Compressors, Gates, Duckers, Expanders, Limiters, Gain blocks, Graphic Equalisers, Parametric Equalisers, Stereo Parametric Equalisers, Filters, Metering points, Delays, Mixers, Matrix Routers, Matrix Mixers, Source Matrices, Tone Generators, and Source Selectors. The software shall provide the facility to construct user-defined control panels incorporating elements of the processing object parameter controls. Multi-level password-based security shall protect the integrity of the system.

The device configuration window shall provide a DSP gauge to inform the designer as to the percentage of DSP usage. The system design software shall be compatible with Windows 95, 98, Windows NT4, Windows 2000 and Windows XP 32 bit operating systems.

The software shall provide a facility to create personalised, custom processing objects for use in system designs, with provision for intellectual property cloaking via Macros.

It shall be possible to connect standard potentiometers and switches or control voltages to 8 control input ports to allow non-technical operators to change system presets or variable parameters. An additional 8 control output ports shall provide logic outputs for purposes of signal indication, external switching systems, or other similar system control applications. An opto-isolated fail-safe indicator shall be provided on an open-collector output.

Two RS-232 ports shall be provided to allow control of the unit from Multimedia Systems such as AMX, Crestron, Dataton, Avenger or other PC devices communicating in a serial mode, as well as independent, simultaneous control and programming from a PC operating Soundweb Designer software. It shall also be possible to remotely control the system network using a PC & modem to connect over telephone lines to another modem connected to the system network.

To aid in system management, the software shall provide a method of event logging so that system diagnostics are available. This event log shall include failures, warnings and information notices, and shall display the time of the event occurrence and the device to which the event applies and the design file originally loaded.

A small wall-mounting panel shall be available that allows control of sources and level (or similar functions) by connecting onto the control ports on the digital signal processor or network hub housed in a standard UK light switch wall panel.

**The Digital Signal processor shall be the BSS Audio Soundweb Lite 3088.**  
The wall-mounting panel shall be the **BSS Audio Soundweb 9012 or 9015 Wall Panel.**





# Soundweb™ lite 3088 Signal Processor

# SOUNDWEB™

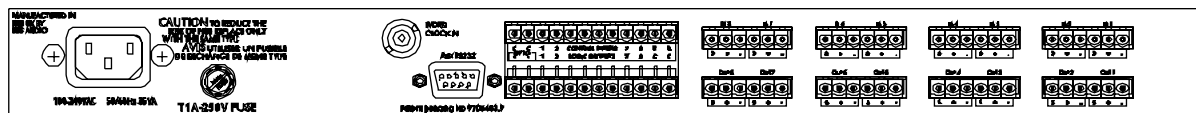
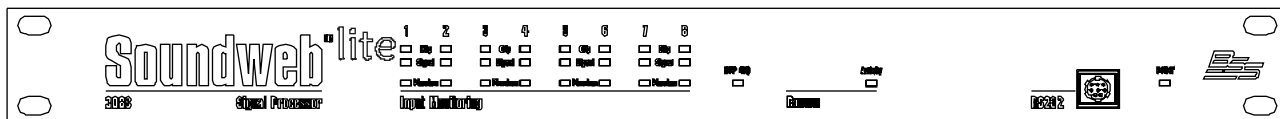

## 3088 Technical Specifications

**INPUTS**  
**Connectors:** 8 Analogue; electronically balanced Phoenix/Combicon removable screw connectors.  
**Line Inputs:** Nominal gain 0dB, electronically switchable to +12dB gain, input impedance 10kOhm  
**Mic/Line Inputs:** Nominal gain 0dB, electronically switchable up to +72dB, in +6dB steps, input impedance 3.5kOhm  
**Maximum input level:** +20dBu with 0dB input gain (+8dBu with 12dB gain)  
**CMRR** >75dB at 1KHz  
**Equiv. Input Noise (EIN):** <-128dBu typ with 150 Ohms source  
**Phantom power:** 48V nominal, selectable per input  
**AES/EBU Digital Inputs:** 2 x 2 channel inputs per card  
**Sample Rates:** 32 to 96kHz, auto selected  
**Connectors:** Phoenix/Combicon removable screw connectors

**OUTPUTS**  
**Connectors:** 8 Analogue; electronically balanced Phoenix/Combicon removable screw connectors.  
**Maximum Output Level:** +20dBu  
**AES/EBU Digital Outputs:** 2 x 2 channel outputs per card  
**Sample Rates:** 44.1, 48, 88.2, 96kHz, user selectable  
**Connectors:** Phoenix/Combicon removable screw connectors  
**Digital Resolution:** 24 bit  
**Frequency Response:** 15Hz to 20KHz (+-0.5dB)  
**THD:** <0.01% (20Hz to 20KHz, +10dBu output)  
**Dynamic Range:** 105dB typ. (22Hz to 22KHz unweighted) 108dB typ. (A-weighted)  
**Crosstalk:** <-75dB

**CONTROL PORTS**  
**Control Input Voltage:** 8 inputs and 8 outputs 0 to 4.5v  
**Control Input Impedance:** 4.7kOhms to +5V (2-wire mode) >1MOhm (3-wire mode)  
**Logic Output Voltage:** 0 or +5V unloaded  
**Logic Output Impedance:** 440 Ohm

**WATCHDOG OUTPUT**  
**Opto Output current:** Phoenix/Combicon connector for failsafe control 14mA maximum  
**Withstanding voltage:** 80V maximum (Off)  
**Series Impedance:** 220 Ohms (isolated)

**Panel Led Indicators:** Signal Present (per input), CLIP (per input)

**Mains Voltage:** 85-270V AC, 50/60Hz,  
**Power Consumption:** <35VA

*BSS Audio have a policy of continued product improvement and accordingly reserve the right to change features and specifications without prior notice. May 2005*

## Input Connector Pin-outs

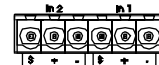

Each connector accommodates two inputs, pin 1 is on right when viewed from rear:  
 Pin 1: Input 1 (3,5,7) Screen (ground)  
 Pin 2: Input 1 (3,5,7) +ve (hot)  
 Pin 3: Input 1 (3,5,7) -ve (cold)  
 Pin 4: Input 2 (4,6,8) Screen (ground)  
 Pin 5: Input 2 (4,6,8) +ve (hot)  
 Pin 6: Input 2 (4,6,8) -ve (cold)

## Output Connector Pin-outs

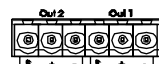

Each connector accommodates two inputs, pin 1 is on right when viewed from rear:  
 Pin 1: Output 1 (3,5,7) Screen (ground)  
 Pin 2: Output 1 (3,5,7) +ve (hot)  
 Pin 3: Output 1 (3,5,7) -ve (cold)  
 Pin 4: Output 2 (4,6,8) Screen (ground)  
 Pin 5: Output 2 (4,6,8) +ve (hot)  
 Pin 6: Output 2 (4,6,8) -ve (cold)

Digital cards have 2 inputs and 2 outputs per card, wired as above, with inputs to the right as viewed from the rear.

## Control port pin-outs

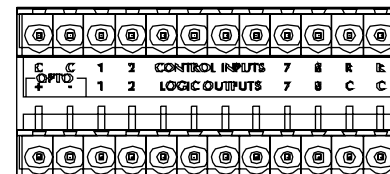

### Upper Row: Logic Inputs

Pin 1, 2, : Common. Pin 11, 12 : Reference  
 Pin 3,4,5,6,7,8,9,10: Logic Input

### Lower Row: Logic Outputs

Pin 1, 2, 11, 12 : Common  
 Pin 3,4,5,6,7,8,9,10: Logic Output

**BSS Audio UK** A Division of Harman International Industries Ltd  
 Cranborne House, Cranborne Road, Potters Bar,  
 Hertfordshire, England, EN6 3JN  
 Tel +44 (0)1707 660667, Fax +44 (0)1707 660755  
 www.bss.co.uk  
 email: info@bss.co.uk

**Harman Music Group**  
 8760 S. Sandy Parkway  
 Sandy, Utah 84070  
 Tel: 801-566-8800 Fax: 801-568-7662  
 web: www.bssaudious.com

**H** A Harman International Company

# Soundweb™ 9015 Wall Panel

# SOUNDWEB™

## Overview

The Soundweb 9015 Wall Panel is a simple hardware interface to the Soundweb programmable DSP system.

It provides a quick and easy way for designers to provide a pair of spin or 'up-down' buttons control and source or preset select (or other multiway switch function) in a standard UK-sized light switch panel fitting.

These hardware controls can be used to provide local control of, for example, volume, source select, or parameter presets. Soundweb Designer software is used to 'map' these functions onto the control ports of a Soundweb device. Gain or Level type controls must be 'morphed' into spin pairs to be mapped onto the control ports.

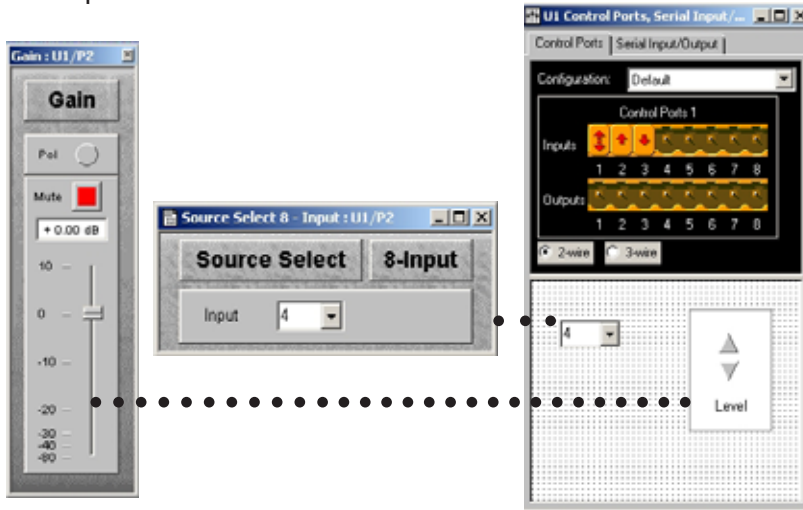

Connection is via screw terminal connectors.

Four terminals are used for common, rotary switch output and the 2 up/down button outputs.

The switch has blank ident areas for marking the switch positions, either directly onto the white area or on self-adhesive labels. Sets of 'standard' labels in 4 languages (English, French, German & Spanish) are supplied with the 9015 to cover most locational requirements.

BSS Audio have a policy of continued product improvement and accordingly reserve the right to change features and specifications without prior notice. May 2005

## 9015 Features

- » Up/Down buttons for volume control etc.
- » 8-way rotary switch for source or preset select etc.
- » Standard UK lightswitch fitting (Green) or US fitting

## Connector Pin-outs

1. **GND:** Common connection (to Control Ports **COMMON** pin)
2. **SOURCE SELECT/PRESET** connection (switch)
3. **LEVEL UP** connection (button)
4. **LEVEL DOWN** connection (button)



**BSS Audio UK** A Division of Harman International Industries Ltd  
Cranborne House, Cranborne Road, Potters Bar,  
Hertfordshire, England, EN6 3JN  
Tel +44 (0)1707 660667, Fax +44 (0)1707 660755  
www.bss.co.uk/soundweb/  
email: soundweb@bss.co.uk

**Harman Music Group**  
8760 S. Sandy Parkway  
Sandy, Utah 84070  
Tel: 801-566-8800 Fax: 801-568-7662  
web: www.bssaudious.com  
**H** A Harman International Company

This page intentionally blank

---



# Soundweb™

1.50

Help File



Soundweb™

**Connect here first...**



## Contents

---

# Contents

**SOUNDWEB**  
™

<b>Soundweb Information</b>	<b>27</b>
<b>What is Soundweb?</b>	<b>28</b>
Hardware Overview	28
9088 Networked Signal Processor	29
9088ii Networked Signal Processor	29
9008 Networked Expansion Processor	29
9000ii Active Network Hub	30
iis Devices	30
9010 Remote Control Panel - 'The Jellyfish'	30
9014 Optical Fibre Interface	30
9012 Dual Control Wall Plate	30
9016/9026 Video/Audio matrix devices	31
Software Design and Control	32
Designing a system overview	32
<b>Tutorial 1 - Working Example</b>	<b>33</b>
<b>Tutorial 2 - Security</b>	<b>47</b>
<b>Soundweb Designer V1.40 New Features</b>	<b>52</b>
<b>Soundweb Designer V1.30 Updates</b>	<b>52</b>
Introduction	53
Connections	53
Configuring the network	54
Design file considerations	55
Controlling the 9016/9026	56
External Control	57
Connecting the 9016/26 to another Soundweb device.	57
Audio Connections	58
Video Connections	58
<b>Soundweb Enhancements</b>	<b>59</b>
V1.40	59
V1.30	59
V1.22	60
V1.20	60



<b>Soundweb Designer Reference Section</b>	<b>61</b>
<b>1. General Program description</b>	<b>62</b>
Status bar	62
Map toolbar	62
Object toolbar	63
Main toolbar	63
Network toolbar	64
Configuration windows	64
Network window	65
System Design Files	65
Program Preferences	66
<b>2. Map windows</b>	<b>69</b>
Creating Map windows	69
Using Tabs to group Map windows	70
Navigating between Map windows	70
Design and Operate modes	71
Map window preferences	71
Full Screen Mode	72
Map Window layout options	73
Adding text and graphics	73
Exporting map window contents	77
Title Blocks	79
Printing Layouts	80
<b>3. Devices</b>	<b>81</b>
Defining the Devices in your system	81
<b>4. Configuration of a Device</b>	<b>82</b>
Configurations	82
Device options	83
Device names	83
Deleting a Device	84
Naming Ports on Devices	85
Defining network connections between Devices	85
Multiple Configurations	86
Audio Processing Objects	87
<b>5. Virtual Wiring</b>	<b>89</b>
Wiring up two connection points	89
Adding a wire to an existing net	90
Adding a corner to an existing wire	91
Deleting a net	91

# Soundweb™





Moving one or more nets	91
Copying one or more nets	91
Reshaping nets	91
Net Notes	93
Automated wiring	93
<b>6. Control Panels</b>	<b>95</b>
Device Control Panels	96
9088/9088ii Inputs Control Panel	96
9088ii Digital Inputs Control Panel	97
9088ii Digital Outputs Control Panel	98
9088/9088ii Network Status Control Panel	100
9000/9000ii Network Status Control Panel	100
9088/9088ii Analogue Outputs Control Panel	101
Control Surface Objects	102
Resetting a control to its defaults	103
Custom Control Panels	104
Customising Control Surface Objects	105
Copying settings between objects	105
Morphing a Control Surface Object	106
Link button	106
Linking Control Surface Objects	107
<b>7. Parameter Presets</b>	<b>108</b>
<b>8. Presets</b>	<b>110</b>
Auto - Online	111
Excluding Devices from a Preset	114
Preset Button	114
Preset Combo Box	115
<b>9. Compiling the Design</b>	<b>116</b>
Resources	116
Compiler problems	117
Compensation Delays	118
'Log in as a different user'	119
<b>10. Working 'online'</b>	<b>120</b>
Connecting the PC	120
Comms settings	121
Using the rear RS232 Port	122
The Network window and going 'online'	122

Going 'off-line'	124
Using more than one PC on the network at once	125
Remote access using a modem	125
Online Notes	127
<b>11. Kit List</b>	<b>128</b>
<b>12. Security</b>	<b>130</b>
Securing the system from unauthorised access	130
<b>13. Auto Online/Full Screen</b>	<b>131</b>
Full Screen Mode	131
Auto-Online	131
<b>14. Macros</b>	<b>132</b>
Create a Macro	133
<b>15. Event Log</b>	<b>135</b>
Filtering Events	137
Event Log window	138
Selecting Events	140
Event details	140
Deleting Events	140
Display Filters	141
Opening other Event Log databases	141
Exporting the Event Log	142
Event Log auto backup	142
<b>16. External control options</b>	<b>143</b>
Control Inputs and Logic Outputs	143
2-wire mode	143
3-wire mode (9088ii only)	145
Configuring Control Inputs in Designer	145
Control Ports & Combo Boxes	147
Control Ports & Configurations	147
Logic Outputs	148
Watchdog Output	148
<b>17. 9010 'Jellyfish' Remote Control Panel</b>	<b>149</b>
Getting started with a Jellyfish	149
9010 - The Page Design window	149
9010 Simulator window	151

# Soundweb™



9010 Input/Output Routing	152
9010 Output Control Panel	15
2	
<b>Technical Reference Section</b>	<b>153</b>
9010 Analogue Outputs Control Panel	154
9010 Network Outputs Control Panel	155
9010 Input Gains Control Panel	156
9010 Screen Control Panel	157
Configuring a control system with the 9010	157
9010 - Creating Pages	157
9010 and Configurations	157
9010 - Creating a Page change button	158
9010 - Preset button	158
9010 - Push buttons	158
9010 - List buttons	159
9010 - Control buttons	160
9010 - Passwords	160
Sending Pages to the 9010 remote	161
<b>18. AMX Control System Interfacing</b>	<b>162</b>
Programming AMX	164
AMX Example Code	165
AMX Object Detail	166
Data export functions	167
<b>i Audio processing object properties</b>	<b>168</b>
Automatic Mixers	169
Mixers	172
Matrix Mixers	173
Matrix routers	173
Source Selector	174
Source Matrix	174
Delay	175
Gain/Mute	176
Metering point	177
Tone generator	178
Noise generator	178
Crossover	179
Mono Sub	181
Ambient Noise Compensator	182
Network Selector	183
Modulator	184

<b>ii Understanding Networks</b>	<b>185</b>
Using the 9000ii Network Hub device	188
Network restrictions	188
Compressor	190
Expander	192
Ducker	194
Gate	195
Limiter	197
Leveller	198
EQ - Parametric Equaliser	200
Stereo Parametric Equaliser	201
Graphic Equaliser	201
Phase Filter	202
High Pass Filter	202
Low Pass Filter	203
FIR Filter	203
Building in fault tolerance	204
<b>iii Firmware Updates</b>	<b>205</b>
Locating the latest software	205
How to Update the Firmware	207
Loader.exe	208
Software Loader	211
BackupLoader.exe	213
9014 Optical Fibre Interface	214
<b>Glossary of terms</b>	<b>215</b>
<b>Soundweb Designer Keyboard Shortcuts</b>	<b>217</b>

# Soundweb™



## Soundweb Information

---

As of the 14th February 2003

**Soundweb Designer** is version 1.40 and runs under Microsoft Windows 98SE, NT, 2000 and XP. It can be run under emulation on a fast Apple Mac running either Virtual PC or Soft Windows.

**Firmware versions:**

9088	1.60
9088ii	1.20
9088iis	1.12
9008	1.12
9008iis	1.08
9000/9000ii	1.50
9000iis	1.06
9010	1.34

**All subject to change, please check our website for updates.**

Contact:

**BSS Audio UK**

Cranborne House,  
Cranborne Road,  
Potters Bar,  
Hertfordshire,  
England, EN6 3JN

Tel: +44 (0)1707 660667

Fax: +44 (0)1707 660755

email: [info@bss.co.uk](mailto:info@bss.co.uk)

website: [www.bss.co.uk](http://www.bss.co.uk)

A division of Harman International Industries Ltd.

**BSS Audio USA**

Harman Pro North America Inc.

1449 Donelson Pike,

Nashville,

TN37217,

USA

Tel: +1(615)360 0277

**Soundweb**  
TM



## What is Soundweb?

---

Soundweb is a configurable distributed audio network. It is based on two principles:

- Hardware Devices
- Software Design and Control

### Hardware Overview



These accept audio inputs and control signals from a variety of sources, e.g. microphones, CD players etc. for audio and, switches, potentiometers, 9010 remote, AMX or similar for system control.

The audio is converted into digital data in order to be routed and processed by a comprehensive selection of DSP algorithms, (developed by BSS and based on years of experience designing and building analogue audio dynamics processors and loudspeaker management systems).

The resultant signal is then reconverted back to the analogue domain at line level for connection to sound systems, recording equipment or for further external processing.

The core hardware devices have no front panel controls (only indicators) which provides long term reliability, consistency of operation and renders the system 'tamperproof'.

These signal processing devices are networked together using industry standard CAT5 cabling and large networks can be easily realised using BSS 9000 series network hubs.

Fault tolerance and redundancy is ensured by the use of bi-directional cable routing in a 'token ring' network configuration. If a device or section of the network goes offline, this will not affect the operation of the remaining Soundweb network. Further backup subsystems can also be configured.

# Soundweb™



## 9088 Networked Signal Processor



A signal processing unit with 8 analogue inputs, 8 analogue outputs and 160 MIPS (million instructions per second) of DSP power.

The 9088 was factory fitted with a pair of four-channel input cards which provided pre-amplification of the signals before being converted from analogue to digital.

The card options were:

- Z-088LIN Line level card - each channel can be set to 0 or 12dB gain (for pro/consumer level use).
- Z-088MIC Mic level card - each channel can be set to a gain between 0 and 72 dB (in 6dB steps), with phantom power selectable on each input.

## 9088ii Networked Signal Processor



A signal processing unit with up to 8 analogue inputs and outputs or 4 AES/EBU stereo digital inputs and outputs. With 200 MIPS of DSP power this is the workhorse and main processing unit of the family.

The card options are:

- Z-088DIG digital card – up to 4 channels of digital interface at AES/EBU standard.
- Z-088MIC Mic level card - each channel can be set to a gain between 0 and 72 dB (in 6dB steps), with phantom power selectable on each input.
- Z-088LIN Line level card - each channel can be set to 0 or 12dB gain (for pro/consumer level use).

## 9008 Networked Expansion Processor



The 9008 lacks the input circuitry of the 9088 but is otherwise identical. This unit is envisaged to be especially useful as an additional device in a larger system, where further routing and processing of audio is required to up to 8 outputs but, the required source signals are already covered by 9088 devices elsewhere in the network.

## 9000ii Active Network Hub



A unit with 6 network jacks and 200 MIPS of DSP power. This unit replaces the 9000, which had 160MIPS, delivering more power for mixing and routing signals. The 9000ii is backward compatible with the 9000, so any design created for 9000s can be loaded into a 9000ii without change.

### iis Devices

Soundweb Designer 1.30 now includes the support of iis devices for 9000 series of products. These devices have different firmware to the ii units and utilise new internal hardware, although for the user the performance is the same.

Within the Soundweb Designer software these are treated as ii devices.



### 9010 Remote Control Panel - 'The Jelly-fish'

A wall mountable remote control unit with six keys, a rotary knob, and a graphic LCD display which is used to provide control for the network.

The 9010 has a built in condenser microphone, second mic input and two outputs for use as a paging station.



### 9014 Optical Fibre Interface

For network systems that need extension beyond the physical limitation of the standard 300m/1000ft cable length. One pair of fibre interfaces and 2 fibre cables replace one cat 5 cable, routing 8 channels of digital audio and control in both directions up to 1.2 miles (2km).



### 9012 Dual Control Wall Plate

A wall mounted plate housing an analogue potentiometer with a 5-way source select switch and rotary fader for use as external controllers to the devices.

# Soundweb™



## 9016/9026 Video/Audio matrix devices

The 9016 and 9026 are matrix routing units. These do not contain any DSP power but are intended primarily to extend the routing capabilities of existing Soundweb networks. The devices can however, also be used as stand alone units.

The Soundweb 9016 features 16 audio inputs, 8 audio outputs, 8 video inputs and 4 video outputs.



The Soundweb 9026 features 16 audio inputs and 8 audio outputs.



In common with existing Soundweb units, the devices use the familiar six way Phoenix connectors, for audio connections. Video signals are connected to the 9016 using BNC Connectors. Both devices have two RS232 ports: RS232 IN and RS232 OUT.

The 9016 and 9026 operate in the same way as the existing source matrix processing objects in Soundweb Designer. Each output can be sourced from any one of the inputs at a time, whereas the same input can be fed to all outputs simultaneously.

## 3088 Signal Processor



A signal processing unit with up to 8 analogue inputs and outputs, or 4 AES/EBU stereo digital inputs and outputs. With 200 MIPS of DSP power, this device has the processing power of a 9088ii and the exclusion of networking capabilities make it a cost-effective option in situations where only a single Soundweb unit is required.

The 3088 DSP is supported in Soundweb Designer 1.40 and above.

The card options are:

- Z-088DIG digital card - up to 4 channels of digital interface at AES/EBU standard.
- Z-088MIC Mic level card - each channel can be set to a gain between 0 and 72 dB (in 6dB steps), with phantom power selectable on each input.

## Software Design and Control

The Soundweb system is totally user configurable via connection to a PC (desktop or laptop) computer running **BSS Soundweb Designer** software.

Soundweb Designer is a specially written application that can be run whilst connected to a Soundweb network to effect 'live' adjustment of parameter values (e.g. output levels, compressor threshold etc.) and complete changes of system configuration using 'Presets'.

Equally, it can also be used 'offline' (i.e. unconnected to the network) for designing a system, which can later be uploaded into the hardware.

The advantages of this approach are multiple.

- System designers can layout an audio system without the need for access to the hardware.
- The software helps create a 'virtual' version of possible configurations using a familiar CAD environment.
- The user can both 'dry run' the system and be fully aware of the use of DSP resources.
- Contractors can printout a graphical representation of their system schematic and a 'kit list' of equipment used directly from the software to aid in setting up the hardware or to include in tenders and specifications for clients.
- Updates and enhancements to existing systems can be worked on and tested without recourse to the hardware.
- Offsite system adjustments can still be performed 'online' to the network via remote access using a conventional modem connection.

## Designing a system overview

To design a system use **Soundweb Designer** software to perform the following tasks:

- Create and save your design in a **system design file** (.sdf).
- Define the Soundweb **devices** to use in the system.
- Choose and configure the **audio processing objects** to be loaded into the devices.
- Adjust the **parameters** of the audio processing objects using *control panels*.
- Designate **Presets** in order to change complete system set-ups.
- Select *control surface objects* to control the system.
- Design 'custom' **control panels** for use when the PC is 'online' to the network.
- Define **Macros** for frequently used sets of DSP functions.
- **Secure** the system (or parts of) from unauthorised access if necessary.

The design steps are actioned in several windows, each giving a different picture of part or all of the system - these are known as *Map windows*.

## Tutorial 1 - Working Example

---

# SOUNDWEB™

This tutorial is designed as a 'quick guide' to demonstrate the process of designing a simple Soundweb virtual system or layout. We hope that it will give you some idea of how Soundweb Designer works with map windows and objects and, how these relate to the processes that can be programmed into a Soundweb device.

It does not cover issues such as macro creation, graphics import/export, event logging, and use of external controllers or working 'online'. Please refer to the 'Soundweb in depth' section for details on these subjects and the many other features of Soundweb.

It is advised that the user should have read the preceding overview sections in order to familiarise with the basic workings and concept of the Soundweb system.

There is a Glossary at the end of this manual, which may help to explain some of the terminology used. There is also a list of keyboard shortcuts which you can print out for reference and an in depth description, including functions, options and connections of all the DSP processing objects.

Follow these steps to design an example Soundweb system:

- 1 Create a System Design File.**
- 2 Define a Soundweb device to program.**
- 3 Lay out the audio processing block diagram.**
- 4 Adjust audio settings.**
- 5 Set up Presets for different occasions/applications.**
- 6 Use a Preset to change DSP Configurations.**
- 7 Design a 'custom' Control Panel.**
- 8 Add a second Soundweb device to the system.**

Security issues are covered in the second tutorial which follows the Working Example.



## Step 1

### Create a System Design File

Before you start, make sure that you have Soundweb Designer software installed on your computer!

- 1 Launch the application.
- 2 *Maximise* the Soundweb Designer main window and use a high monitor resolution in order to give yourself plenty of work area.
- 3 If you do not already have a blank 'map window' on the screen use **File>New** to create one.
- 4 Select **File>Save As..** (to give your system design file a name).
- 5 Save it in a chosen directory of your hard disk.

From this point all information related to this system (DSP layout, Presets, etc.) will be saved with your system design file - so long as you remember to press **Save** occasionally...

# Soundweb™

## Step 2

### Define a Soundweb device to program

- 1 Select **Add>Device...** from the menu, or press the  button in the toolbar.
- 2 Choose '9088 DSP' from the list of 'Available Device Types'.

There are options and settings associated with this device, don't worry about these for the moment but, naming the device to reflect its purpose is good practice - especially when using multiple devices.

- 3 Press **OK** and then click anywhere on the map window.

You should see a representation of the 9088 device on your screen.

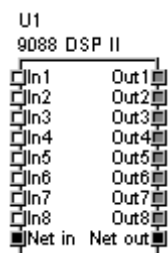



## Step 3

### Layout the audio processing block diagram

The objective is to layout a simple system consisting of a 4:2 mixer, with EQ on each input, and a compressor on each output.

1 Double click the 9088 DSP object; this opens its 'Configuration' window.

You should see objects representing the analogue inputs and outputs and network ports of the device.

On the next page is a picture of the system we are trying to create. Please refer to this diagram to help layout your arrangement.

To the left of the Configuration window there is a list of the available Processing Objects:

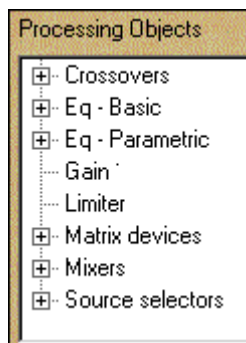

The Processing Objects are grouped into categories (such as Mixers, Dynamics, EQ, etc.) The list works like a Windows Explorer 'tree control'. To view all the items in a category (for example the Crossovers category) click on the '+' sign next to it.

This changes the window to the following:

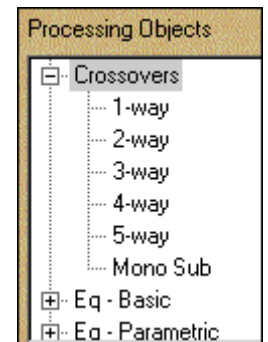

- 2 Click on the '-' sign to collapse the category down and simply show the category name without any of the contents.
- 3 Now open the 'Eq - Parametric' list of Processing Objects click on and drag a '**4-Band Parametric EQ**' onto the main window, opposite one of the analogue input ports.
- 4 Next, make three more copies of this EQ by holding down the **CTRL** key and dragging the EQ object to a new location.

! Keep the **CTRL** key down for the whole dragging process, and only release it after you have released the mouse button to drop your new EQ object into place.

- 5 Now also add one '**Mixer 4:2**' ('Mixers'), and two '**Compressor**' blocks ('Dynamics') to the layout.

## Step 4

### Wiring up the processors

We are now ready to wire up the block diagram.

*! If you have a laptop computer, you may find it easier to use a mouse rather than a trackpad or ball to perform the wiring of the processing objects.*

To connect the first EQ to the analogue input port:

- 1 Select **Edit>Add Wires**, also available in the right-click menu or press the  button in the toolbar.
- 2 Click on the connection point (the small square 'node') of the 'In1' object, a *virtual* 'wire' should appear attached to a *crosshair* (+) cursor.
- 3 Move the mouse to the 'In' port of the first EQ object, and click again.

A link should have been made between the two objects.

Repeat this process for each object in the system, i.e. wire the analogue input ports to the inputs of the EQs; the outputs of the EQs to the inputs of the mixer; the mixer outputs to the compressor inputs, and the compressor outputs to analogue 'Out1' and 'Out2'.

You can make a wire go round corners by clicking on a place on the map window where you want the current wire segment to change direction.

# Soundweb™

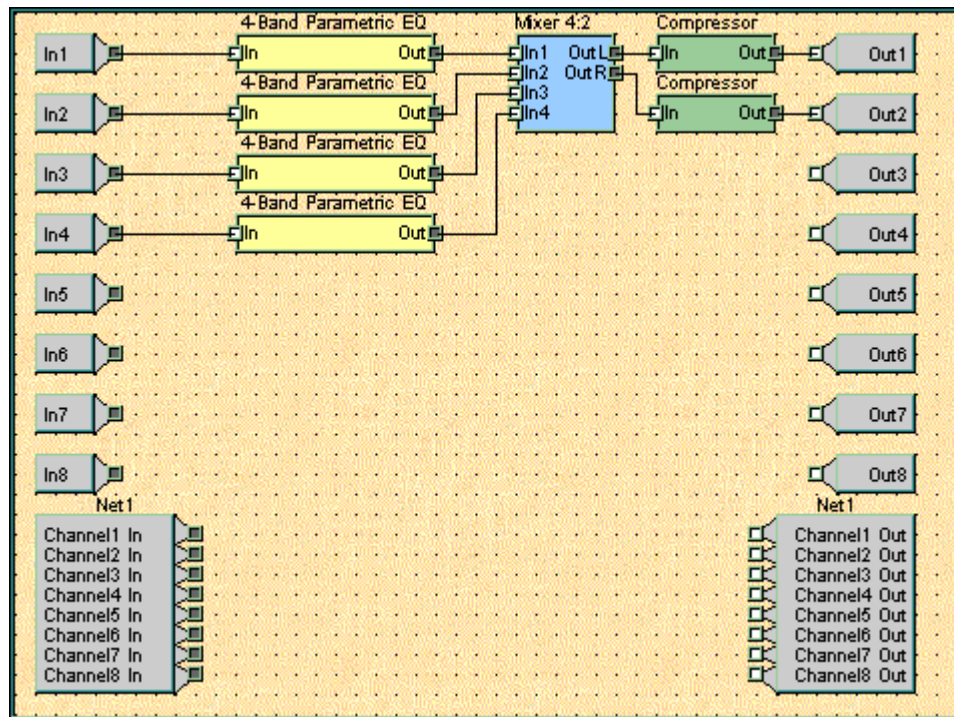

To delete a wire put in the wrong place:

- 1 Select **Edit>Edit Wires** from the menu, also in the right-click menu or use the  toolbar icon.
- 2 Click on the unnecessary wire, and press the **Delete/Backspace** key (or select **Delete** from the right click menu).

Wires can be *moved* by dragging the middle of the wire, which moves the whole net. Alternatively, to *reshape* the wiring move the black square at the end or a junction in the wire.

A **red** wire signifies that a connection has not been made or is not an appropriate action.

## Step 5

### Adjust audio settings

- Double click on the mixer object.

A 'control panel' for the mixer, like the one shown below, should appear. Experiment with the controls by using the mouse to adjust their settings until you are happy with how faders, buttons and rotary controls work.

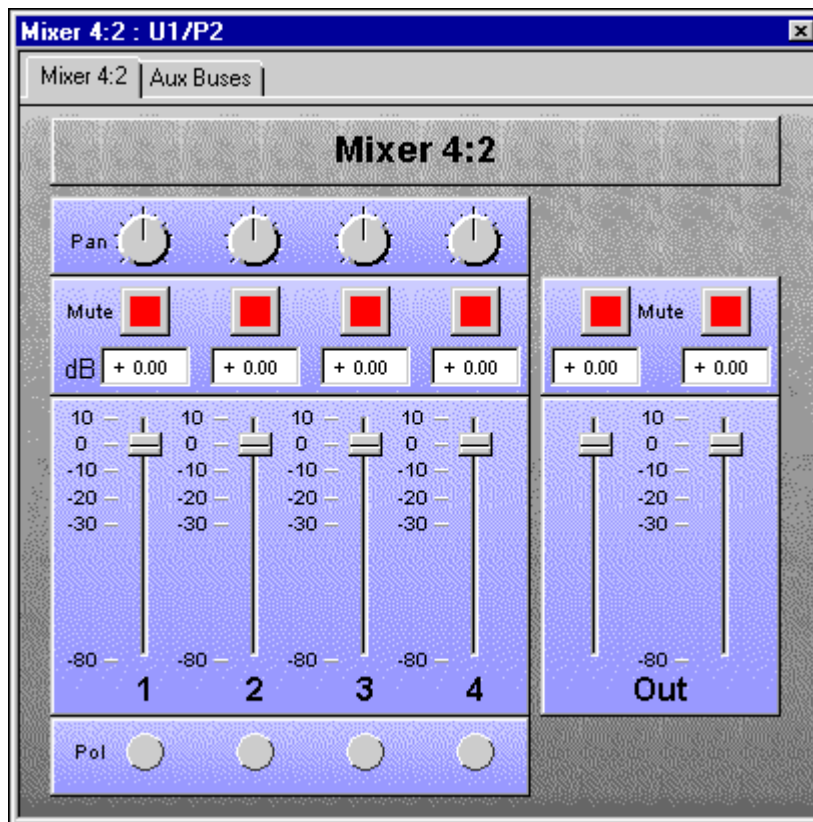

# Soundweb™

## Step 6

## Create Presets for different occasions/applications

Next, we're going to create two 'Presets'. One for a 'Conference' use, which will use all four inputs on the mixer. The second is for a 'Wedding', and will use the first two inputs only.

To set up the 'Conference' Preset:

- 1 Adjust all the gains on the mixer control panel to -10dB (either by moving the sliders or by selecting the textbox above them and typing in the number), and unmute all the inputs and outputs of the mixer (grey buttons, not red).
- 2 Select **View>Go to Preset View**, or press the  shortcut icon at the bottom of the screen.



- 3 In the dialogue box press **New**; type "**Conference**"; press **OK**.

This set-up is now stored in a Preset suitable for the 'Conference' application.

To create the second Preset.

- 4 Return to the mixer control panel by closing, minimising or resizing the Preset window.
- 5 Mute inputs 3 and 4, and adjust the gain to around -30dB on inputs 1 and 2.
- 6 Select **Preset View** as before; Press **New**; type “**Wedding**” and press **OK**.

These new settings are now stored in a second Preset.

To recall a Preset, select it from the list in the **Preset View**, and press **Recall**.  
If the mixer control panel is visible, you should see the fader and mute settings change.

# Soundweb™



## Use a Preset to change DSP Configurations

Next, we will change the system by adding a noise gate on mixer channel 4 - for use in the 'Conference' Preset only. This will demonstrate how we can not only change the settings of the system but also the Configuration of processing objects too.

Here is what we want the new Configuration to look like:

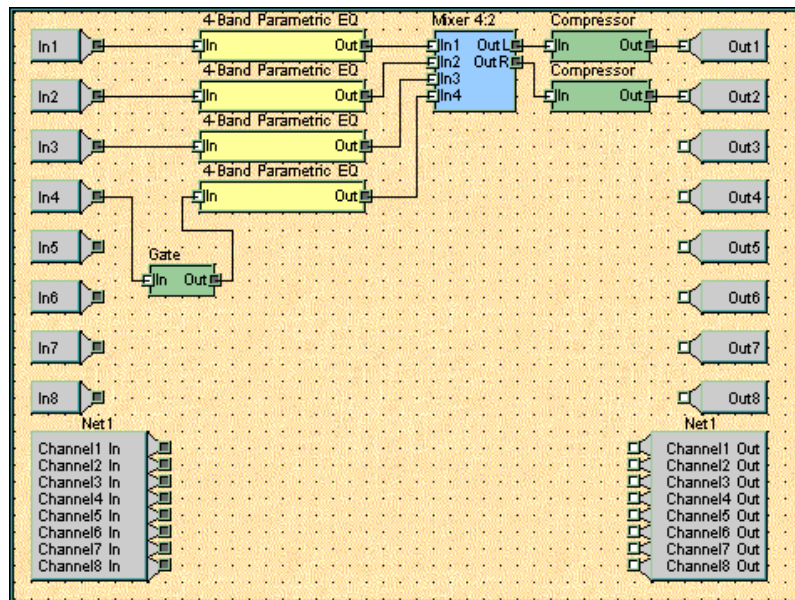

- 1 Return to the Configuration window.
- 2 Choose **Edit Wires** mode (as before).
- 3 Select *all* of the DSP blocks and wires by dragging a rectangle around the whole layout.

- 4 Copy this set-up by using **Edit>Copy** (also in the right click menu, or **CTRL-C**).
- 5 Now press the button next to the '**Configuration**' combo box.

This dialog box should appear:

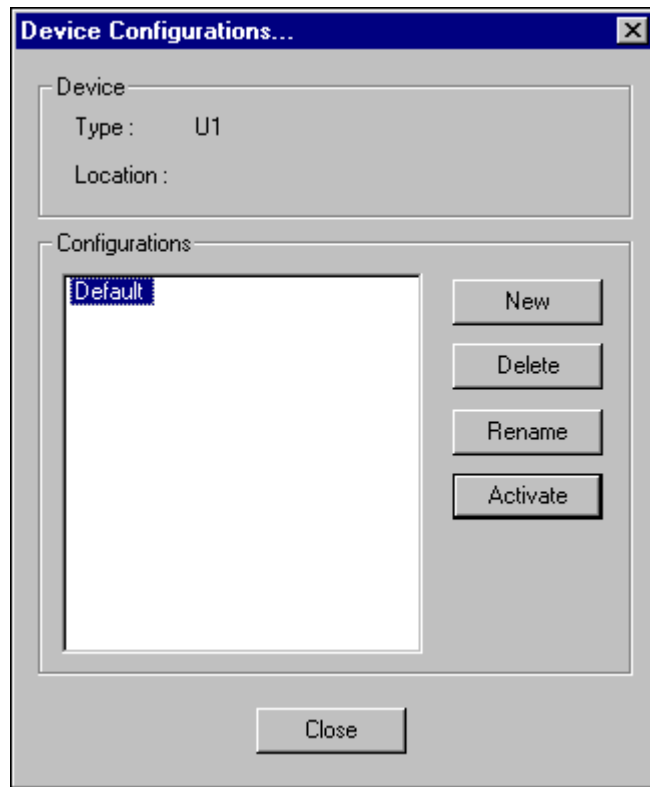

- 6 Press **New**.
- 7 Type "**Plus Gate**". Press **OK**. (If you want you can rename the 'Default' Configuration).
- 8 Select "**Plus Gate**" and press **Activate**.

A new layout page should appear.

To retrieve the Configuration that you designed originally.

- Select **Edit>Paste** (or **CTRL-V**).

! If you have resized windows or moved them you may find that the input and output ports are not connected - if this is so connect them up again.

Now to add the gate to the layout.

- 1 Delete the wire between 'In4' and the EQ.
- 2 Drag a 'Gate' from the 'Dynamics' Processing Objects list.
- 3 Wire 'In4' to the Gate input.
- 4 Wire the Gate output to the now vacant EQ input.
- 5 Return to the Preset View, select 'Conference' and press **Store**.
- 6 Switch between the 'Conference' and 'Wedding' Presets by selecting them in turn and pressing **Recall**.

You should see the block diagram change and that recalling a Preset *picks up* the DSP Configuration that was stored with it.

Note that Configurations are specific to a particular device but that Presets are system wide, i.e. a Preset stores all the settings for *all* of the devices on the network.

## Step 8

### Design a 'custom' control panel

Let's suppose that we want to create a control panel that has just the output gains from the mixer, and some dedicated buttons for Preset selection.

- 1 Go back to the Configuration window and double click on the mixer to bring up its 'default' control panel.
- 2 Select **Map>Design** (also in the right-click menu, or **ALT+D**).
- 3 Use **Map>New Window** or press the  button to provide a new map window in which to create the new control panel.
- 4 Select **Map>Rename** and give it a name like "Main control panel".
- 5 Adjust the window sizes to allow space to *drag and drop* between this window and the default control panel.
- 6 Next, drag an output gain fader from the mixer control panel to the new window.
- 7 If the software asks whether you want to resize the grid press 'Yes'.

Repeat this operation for the second gain fader.

- 8 Now click on the window and select **Map>Operate** (also in the right-click menu, or **ALT+O**). Also, switch the default control panel back to Operate mode.

You should now see that if you move a fader in either control panel, the corresponding fader in the other panel will track it.

Next, to add a button to select a Preset (i.e. "Wedding").

- 1 Click on the new 'Main control panel'
- 2 Select **Map>Design**.
- 3 Select **Add>Preset** or press the  button and click again on the 'Main control panel' to place the button.
- 4 Right click on the resulting Preset button and select **Properties** from the pop-up menu

**Soundweb**  
designer™

- 5 Select the **Preset** tab, and choose 'Wedding' from the combo box.
- 6 Repeat this sequence for the 'Conference' Preset.

In **Operate** mode, you should now be able to change between the two Presets by clicking on the buttons in the new control panel.

Text and images can be used to annotate your system design on most windows. You can label inputs, outputs and devices, and/or 'wire' the analogue inputs and outputs to bitmap pictures of loudspeakers or signal sources to indicate the system routing.

With the 'Main control panel' in **Design** mode (**ALT+D**) you can experiment with different visual appearances for your new control panel.

To add text or images use the **Add** menu (or buttons from the Object toolbar).

**View>Preferences>Map** (also in the right-click menu) will let you change the background colour of the window, or use a background image from a bitmap or Windows metafile.

A control object can be resized by selecting it and dragging a corner of the selection.

The right click **Properties** menu of an object gives control over many aspects of its appearance including font, colour and various bordering options.

## Step 9

### Add a second Soundweb device to the system

- Using **Map>Go To** or the **Window** menu, go back to the original map window ('Map Window 1').
- Select **Add>Device** or press the  button on the toolbar.
- Add a second '9088 DSP' device. Place it to the right of the first one.
- Make a network connection between the two by wiring from the '**Net Out**' port of one device to the '**Net In**' port of the other.

The second device is now ready to configure by double clicking on it as before...



End of tutorial 1

There follows a further tutorial for setting up a *secure* system, if this is likely to be needed then we recommend to work through both tutorials one after the other as they are intended to follow on.

**Soundweb™**





## Tutorial 2 - Security

This tutorial is designed to follow on from the Getting Started tutorial and requires that certain objects be in existence in the system design in order to demonstrate the use of security. Using the concepts outlined here, you should be able to apply security to most aspects of a system as required.

### Security Tutorial - Step 1

#### Enable security

- Select **View>Preferences>System design file**.
- Click on the **Security** tab.

This displays the following dialog:

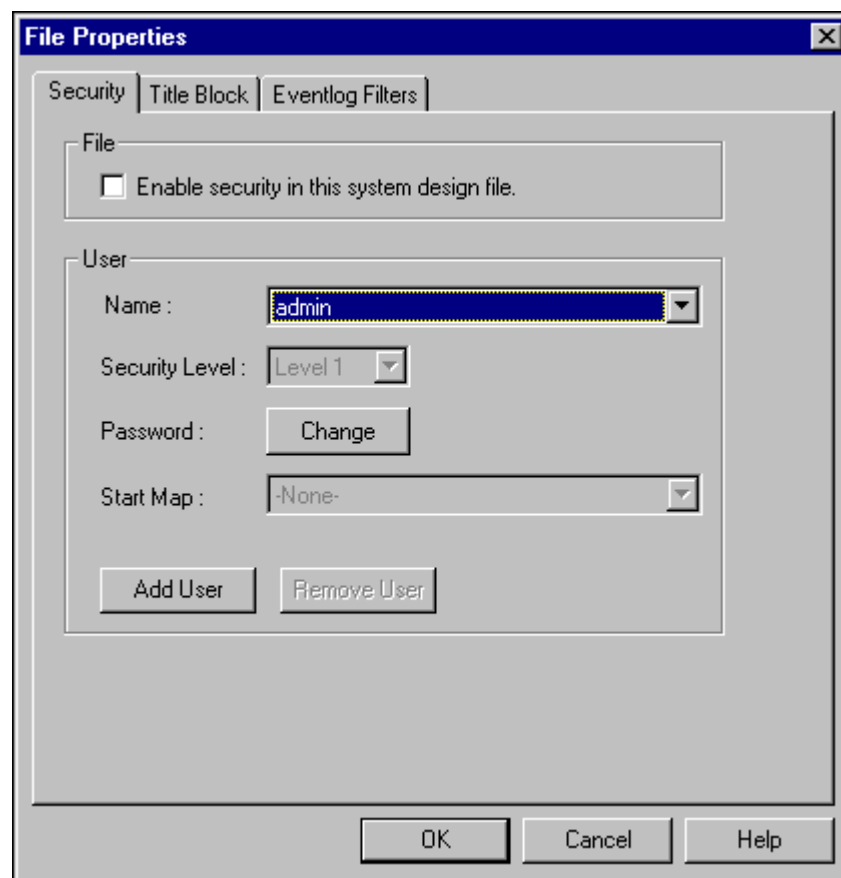

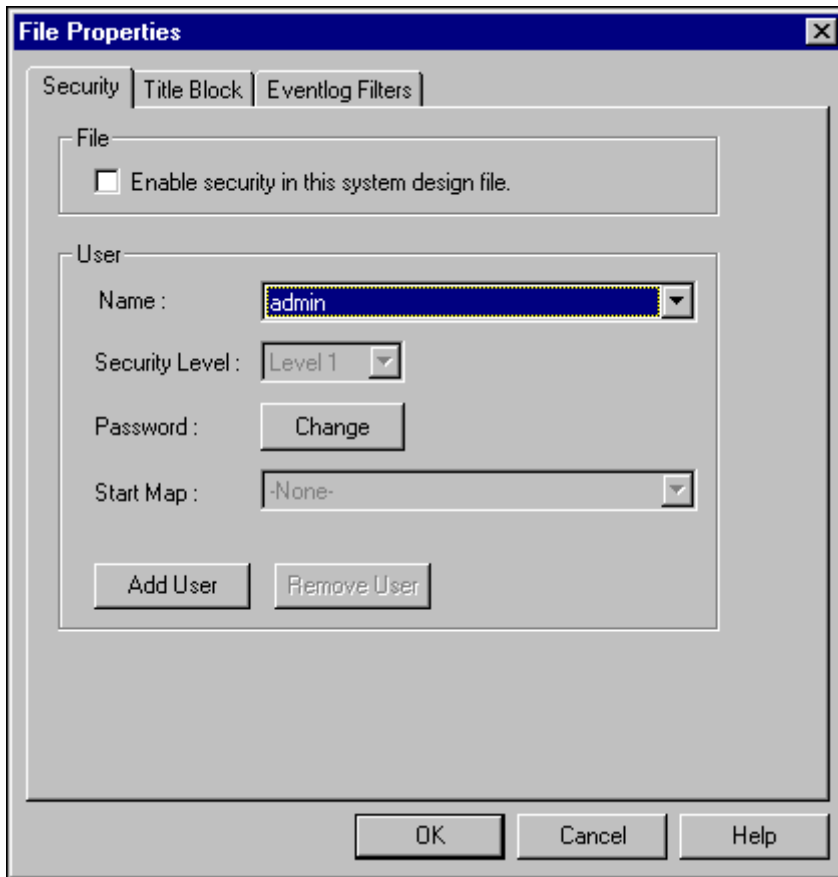

# Soundweb™

- Check the box labelled 'Enable security in this system design file'.
- Press OK.
- Save the system design file.
- Now close and re-open it.

You should see the following screen:



There is currently only one user, 'admin', whose password is also 'admin'.

Type in the password ('admin'), and click OK.

You now have access to the system as usual.

### Step2 - Set a password for the admin

To set the administrator's password to something other than the default (in order to prevent other people logging in as you).

- **Select** View>Preferences>System design file>Security.
- **Press** Change.

Type in the existing password ('admin') followed by the password that you wish to use. You will be asked to repeat this as confirmation.

### Step 3 Set up a new user

- **Select** View>Preferences>System design file>Security.
- **Press** Add User.
- Type in a name (such as 'operator'), and press OK.

A new user has been added with level 10 security (the lowest level and with the least access dependant on the security set-up), and with a password which is the same as the 'operator' name.

To change the security attributes of a user, i.e. security level and password:

**Modify the attributes in the other dialog fields, and select OK.**



## Step 4 - Controlling access to map windows

To allow a user access to a particular window only.

- **Select** View>Preferences>System design file>Security.
- **Select the user in the 'Name' combo box.**

Choose the map window to be opened when the user logs in from the Start Map combo box.

To test these changes to the security set-up:

- Save the system design file.
- Close it and re-open it.
- **At the login screen, select the user named 'operator'.**
- Type in the password.

You should see that the system has been opened with only the specified window active.

**Soundweb**<sup>TM</sup>

## Step 5 - Selective control access

Suppose we want to allow the user to see the input gain settings of the mixer, but not change them.

- First, close the file and re-open it, this time using the administrator's password.
- **Next, create a new map window, and rename it 'Input control panel'.**
- **Now return to 'map window1'.**
- Double-click on the main device to open its Configuration window.
- Double-click on the mixer processing object.
- **Choose Design mode from Map>Design (also in the right-click menu, or ALT+D).**
- Select the block of input faders by dragging a rectangle around them with the mouse.
- Drag the block across to your new map window, some shuffling of windows may be needed on the screen first to make this possible.
- **Click somewhere on the 'Input control panel' to ensure that this window is selected.**
- **Select View>Preferences>Map and click on the 'Security' tab.**
- **Set all the levels to 'Level 1', except the 'Security level to View' - leave this at 'Level 10'.**
- **The user 'operator' (who is at level 10) is now able to view the controls, but not operate them.**

To test this, a linking button is needed to allow 'operator' to navigate to the 'Input control panel'.

- **Go back to 'map window 1' (for example by selecting Map>Go To).**
- Enable Design mode, as before.
- **Select Add>Linking Button or press the button on the toolbar.**
- Place the new button somewhere on the control panel.
- **Right click on the button and select Properties.**
- **Select the 'Target Window' tab.**
- **Choose 'Input control panel' from the list of available target windows.**
- **Now save the file, close it, re-open it and login as 'Operator'.**
- You should enter the first map window as before.
- **Click on the linking button to access the 'Input control panel'.**



You should be able to view the mixer settings, but you should not be able to move any of the controls.

From this tutorial it should be possible to assign security to either the whole file or for selective areas and functions in the design.

! Remember your passwords or keep an unsecured backup copy of the sdf so that access does not become denied to you too...

## Soundweb Designer V1.40 New Features

### 3088 Signal Processor



A signal processing unit with up to 8 analogue inputs and 8 analogue outputs, or 4 AES/EBU stereo digital inputs and outputs. With 200 MIPS of DSP power, this device has the processing power of a 9088ii and the exclusion of networking capabilities make it a cost-effective option in situations where only a single Soundweb unit is required.

The 3088 DSP is supported in Soundweb Designer 1.40 and above.

The card options are:

- Z-088DIG digital card - up to 4 channels of digital interface at AES/EBU standard.
- Z-088MIC Mic level card - each channel can be set to a gain between 0 and 72 dB (in 6dB steps), with phantom power selectable on each input.
- Z-088LIN Line level card - each channel can be set to 0 or 12dB gain

## Soundweb Designer V1.30 Updates

### 9016/9026 Video/Audio Matrix Devices.

- Introduction
- Connecting to other Soundweb devices
- Configuring the network
- Adding to a Design File
- Controlling the devices
- External control options
- Connection information

### Enhancements and bug fixes

- Soundweb Designer 1.40
- Soundweb Designer 1.30
- Soundweb Designer 1.22
- Soundweb Designer 1.20

# Soundweb™



**Introduction**

The 9016 and 9026 are matrix routing units from BSS Audio. These units do not contain any DSP power but are intended primarily to extend the routing capabilities of existing Soundweb networks. The devices can however, also be used as stand alone units.

The Soundweb 9016 features 16 audio inputs, 8 audio outputs, 8 video inputs and 4 video outputs.



The Soundweb 9026 features 16 audio inputs and 8 audio outputs.



In common with existing Soundweb units, the devices use the familiar six way Phoenix connectors, for audio connections. Video signals are connected to the 9016 using BNC Connectors. Both devices have two RS232 ports: RS232 IN and RS232 OUT.

The 9016 and 9026 operate in the same way as the existing source matrix processing objects in Soundweb Designer. Each output can be sourced from any one of the inputs at a time, whereas the same input can be fed to all outputs simultaneously.

**Connections**

Soundweb Video/Audio Matrix devices are connected to a Soundweb system via the rear RS232 Port of a 9088ii, a 9000, a 9000ii or a 9008. Up to two external devices can be connected in series, the second matrix device being connected to the rear port of the first. If there is one Matrix device connected, the “unit ID” switch on the rear must be set as unit A. A second matrix device connected in series with this one, must have the “unit ID” switch set as unit B. The “Baud Rate” switches on both matrix switches must be set to the “Soundweb” (out) position.

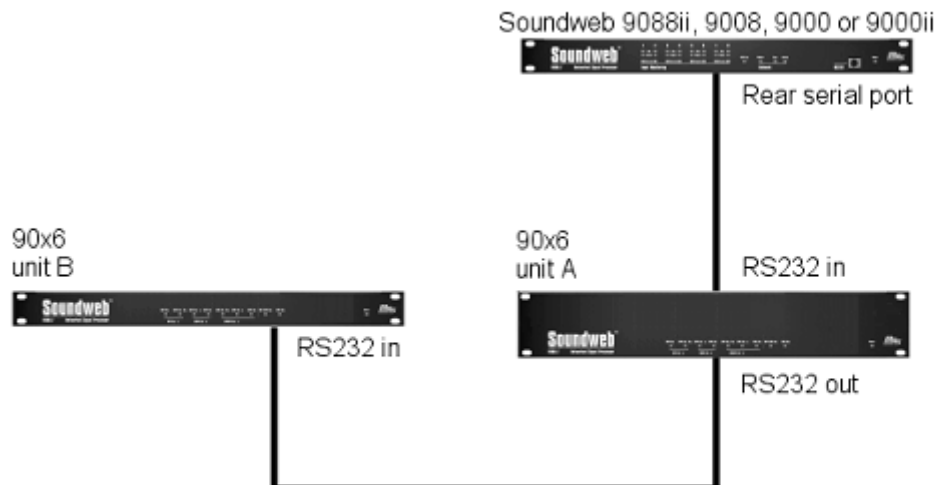

## Configuring the network

To effect control it is necessary to have a PC running Soundweb Designer online to the network. The 9016/26 is then controlled via the control panel of the device to which it is connected. To facilitate correct communication between the 9016/26 and Soundweb Designer software, check the 'External Matrix devices attached' checkbox on the device to which the 9016/26 is connected. This is located on the 'Expansion Matrix Devices' tab of the device properties dialog, which is accessed from the pop up menu activated by right clicking on the device icon in design view.

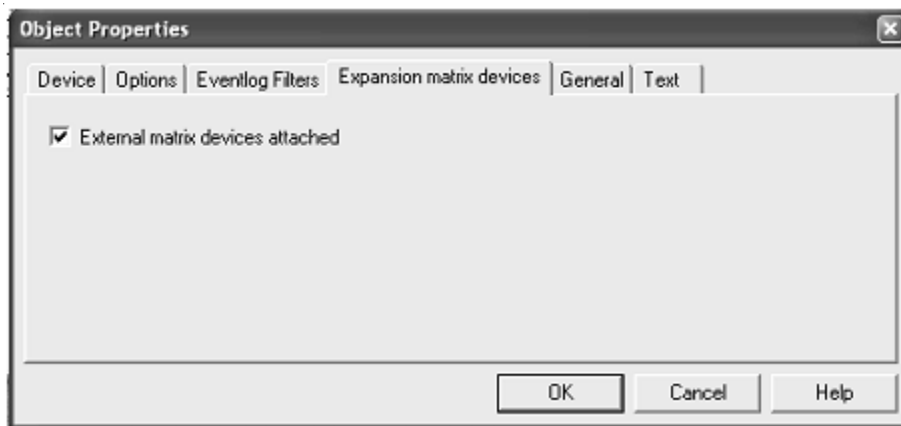

# Soundweb™

**Design file considerations**

There is no direct representation of the 9016 or the 9026 in Soundweb Designer; that is, you cannot create a new device of type 9016 or 9026 as you might with other Soundweb devices. However as an aid to system design, a bitmap representation of both matrix devices can be added by right clicking on a map window in design view, selecting Add New Image from the pop up menu, then browsing to the appropriate image in the pictures folder of your Soundweb installation. The Bitmaps are named "AudioMatrix" and "VideoAudioMatrix". Any wires drawn to these Bitmaps will be for illustration purposes only.

Audio Matrix  
9026

In1	Out1
In2	Out2
In3	Out3
In4	Out4
In5	Out5
In6	Out6
In7	Out7
In8	Out8
In9	Out9
In10	
In11	
In12	
In13	
In14	
In15	
In16	
RS-232	

Bitmaps included with Soundweb Designer

Audio/Video Matrix  
9016

—Audio—	
In1	Out1
In2	Out2
In3	Out3
In4	Out4
In5	Out5
In6	Out6
In7	Out7
In8	Out8
In9	
In10	
In11	
In12	
In13	
In14	
In15	
In16	
—Video—	
In1	Out1
In2	Out2
In3	Out3
In4	Out4
In5	
In6	
In7	
In8	
RS-232	



### Controlling the 9016/9026

There are in fact two sets of controls, on two separate tabs entitled 'Matrix Device A' and 'Matrix Device B'. Inputs can be patched to each output within the corresponding device, using either the drop down list or the push buttons. The currently active input for each output is indicated with a green LED. The gain of each audio output can be adjusted between -INF and +20dB, using the up/down spin controls, or by typing directly into the corresponding edit boxes.

Any changes made when the PC is online to a device will have immediate effect.

In common with other Soundweb Designer controls, the Matrix Device Controls can be dragged to map windows in order to create custom control panels. BSS recommend the use of presets to store and recall Matrix setups, this will enable multiple input/output routes and gain settings to be changed simultaneously. More information on presets can be found in the relative section of this document.

**SOUNDWEB™**

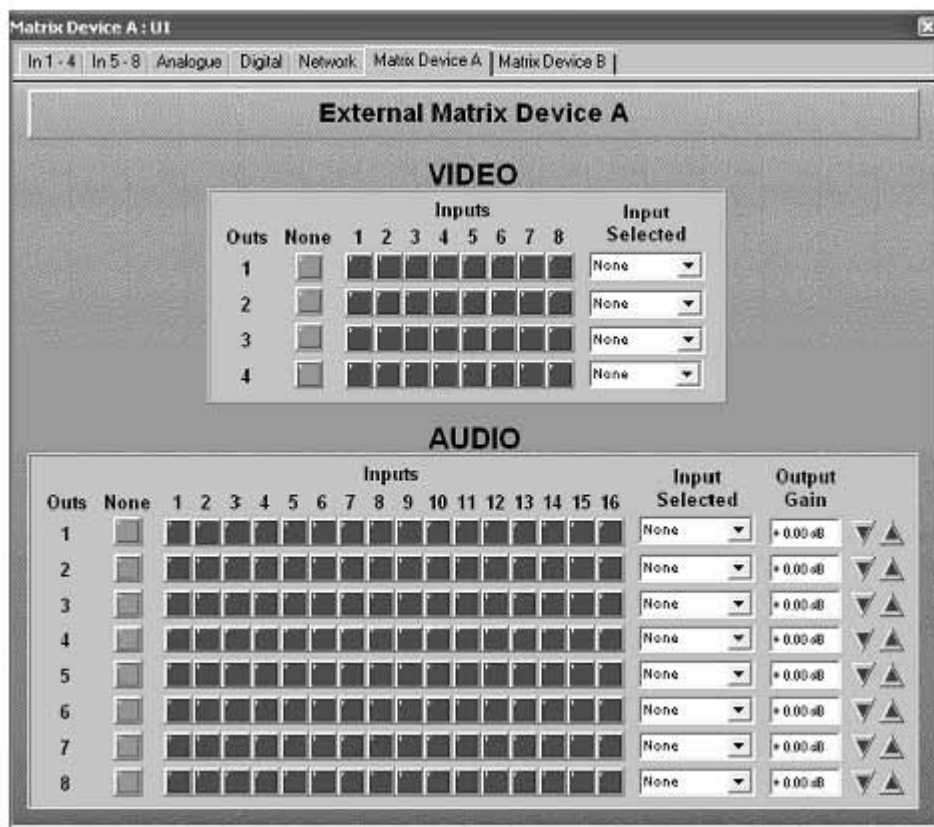

## External Control

All of the controls on the Matrix control panels can also be placed on a control port, which will enable control using external hardware devices such as the *BSS 9012 Dual Control Wall Plate*. See the relevant section for more information on using control ports.

The matrix devices can of course also be controlled by a *BSS 9010* remote control provided they are being used as part of a network that includes Soundweb DSP devices.

## Connecting the 9016/26 to another Soundweb device.

To Connect the 9016/26 to another Soundweb device a standard PC Serial Extension cable is used. Only the following connections are necessary.



Male 9-way D type - identical pin out to that used in a standard PC serial port:

Pin No.	Signal type	Function	9-way pin No.	25-way pin No.
1	DCD	Data carrier detect (input)	-	-
2	RXD	Receive data (input)	2	3
3	TXD	Transmit data (output)	3	2
4	DTR	Data terminal ready (output)	-	-
5	GND	Ground	5	7
6	DSR	Dataset ready (input)	-	-
7	RTS	Request to send (output)	-	-
8	CTS	Clear to send (input)	-	-
9	(not used)		-	-

Note: This is not the same wiring as the Null Modem cable currently used to connect a PC to the rear RS232 port of Soundweb DSP devices.

NB: 'commercial' cables may have some of the other connections wired up, this is perfectly acceptable.

## Analogue Connections

### Audio Connections

These connectors are in pairs at the back of the unit on six way Phoenix connectors. Inputs are on the top level and outputs on the bottom. The signal pin out is marked on the silk-screen of the case rear. Seen from the back of the unit, from left to right, the connection is always

- (S) shield/ground
- (+) +ve signal
- (-) -ve signal

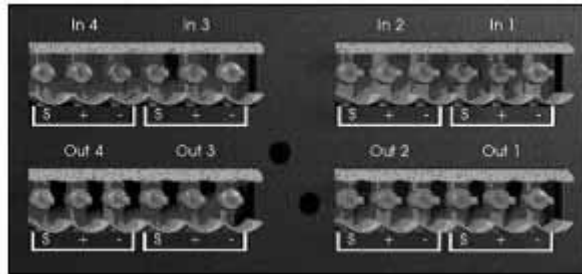

### Video Connections

Video inputs/outputs on the 9016 use standard BNC connectors.

**Soundweb™**

## Enhancements

### Version 1.40

- Along with the familiar 'no problems' message displayed in the network window of Designer when online to a fully functional network, a list of the devices on the network and the firmware versions contained in these devices is also displayed. This will allow the user to quickly check that all devices are running on the latest firmware versions, essential for prolonged reliable operation.

### Version 1.3

- ID info for parameter presets is now shown in the status bar rather than on a tooltip.
- Buttons placed on Control Ports as toggle buttons no longer get left out of presets and param. presets.
- Delays in Crossover objects - corrected occasional errors in reported delay times.
- Audio mutes caused by DSP reloads now corrected.
- Firmware will report if an earlier version than 1.22 of Soundweb Designer is used.
- Hubs can now detect a fibre failure in one leg of the two cores.
- Maximum number of configurations raised to 78.
- Preset changes from 9010 remote buttons can now be combined with password security.
- Hub mastership improved.
- Master LED remains illuminated when selecting device on network view.
- Serial control across networks improved for large numbers of parameters.
- Delay ranging fixed in macros.
- Parameter presets in 'Button Mode' now 'depress' like normal buttons when clicked.
- Any changes in a devices serial window will now signal the need to re-load the device.
- Compiler - delay compensation improvements.
- Windows '98 - long path name problem fixed.
- Event Log – problems displaying events using an SDF with a filename longer than 30 characters fixed.
- Macros - now exporting delay properties correctly.
- Metering – fixed problem with faders and parametric eqs not sending values when there were multiple meters on screen.
- Metering – fixed problem with meters requesting updates from devices, therefore causing extra network activity, even when they had been closed down in Designer.
- Automated wiring – crashes when trying to implement this feature now fixed.
- Configuration window – interface ports are now sent to back when first opening an





## Bug Fixes

### Version 1.22

- Fixes Bug that caused 9010 to request unnecessary Reload when going online.
- Modem is now initialised only on power up of device (Some users experienced problems with modem being initialised during Configuration changes).
- Correct Delay units are now displayed on 9010 and initial values are read correctly.
- Fibre system muting scheme altered - previously this could result in inaudible signals appearing at unconnected 9000 Hub network inputs.
- Devices no longer reboot when loaded with large design files containing Ambient Noise compensators.
- Macros containing gain objects that have their default values set to -INF no longer crash when their control panel is opened.
- Control range definition in macros now fixed (problem with -infinity).
- Designer no longer allows you to go online to a serial port that is not valid, i.e being used by another application or not physically existent.
- Keep alive timer re-introduced. Designer will timeout after 5 seconds. Network will time out after 2 seconds and perform a network reset.
- Closing Designer whilst online no longer causes the software to crash.
- Comms.exe now reboots on startup if Soundweb left it running on the last shutdown.

### Version 1.2

- Compiler - delay compensation improvements.
- Windows '98 - long path name problem fixed.
- Event Log – problems displaying events using an SDF with a filename longer than 30 characters fixed.
- Macros - fix for exporting delay properties correctly.
- Metering – fixed problem with faders and parametric eqs not sending values when there were multiple meters on screen.
- Metering – fixed problem with meters requesting updates from devices, therefore causing extra network activity, even when they had been closed down in Designer.
- Automated wiring – crashes when trying to implement this feature now fixed.
- Configuration window – interface ports are now sent to back when first opening an SDF so that user defined text labels can be seen.

# Soundweb™



## Soundweb Designer Reference Section

---

# SOUNDWEB DESIGNER ™

1. General program description
2. Map windows
3. Devices
4. Configuration windows
5. Virtual wiring
6. Control Panels
7. Parameter Presets
8. Presets
9. Compiling the design
10. Working 'online'
11. Kit List
12. Security
13. Macros
14. Event Log
15. External control options
16. 9010 Remote Control programming
17. AMX control system interfacing



# 1. General Program description





The Soundweb Designer application runs successfully under Windows 95/98 (Release 2) or NT. The main Soundweb Designer window looks like most typical Windows application programs: it has a menu bar, various iconic toolbars, a main work area, and a status bar.

## Status bar



The status bar, located at the bottom of the main window, has an indicator to show the present system status; 'ONLINE' is displayed when the PC is in active connection to the Soundweb hardware devices and 'OFFLINE' when the PC is working independently of the network.

The status bar also provides shortcuts to other windows. Click on one of these to go directly to the selected window:

-  Event log application
-  Network view
-  Macro creation page
-  Preset window
-  Kit list

It also displays an explanation of the buttons in the toolbars at the top of the screen when the mouse rolls over these icons (when available for use). Momentary 'Tooltips' also show abbreviated info at this point.

## Map toolbar

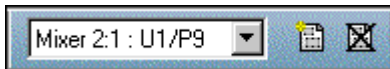

The Map Toolbar contains buttons for creating a new map window and deleting the currently open map window. It also contains a combo box with a list of all the map windows in the system design file. Map windows can be selected by name from this combo box.

It can be switched on or off using the **View>Map Toolbar** menu command and can be repositioned on the screen by clicking and dragging from an area of the toolbar which is not a button.

# Soundweb™

## Object toolbar

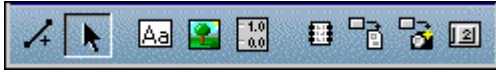

The Object Toolbar contains buttons for various *design*-related commands. These include adding devices, graphics, text, Presets and also buttons to switch a map window between **Add wires** and **Edit wires** modes. It can be switched on or off using the **View>Object Toolbar** menu command and can be repositioned on the screen by clicking and dragging from an area of the toolbar which is not a button.

 Add Wires mode

 Edit Wires mode

 Add Text box

 Add Image

 Add Scale

 Add Device

 Add Link button

 Add Preset button

 Add Parameter Preset selector

## Main toolbar



The Main Toolbar is an extension of the **File** and **Edit** menus allowing quick access to open and save files, print documents and to cut, copy and paste objects and text.

 Undo

- Functions that can be undone include:  
Creation of wires, movement of processing objects and the repositioning of control surface objects in design mode.
- Undo does not currently affect:  
Deletion of wires, controller movements and settings or the naming of objects.

Undo is available from either the Edit menu or the main toolbar icon.

This function has multiple levels of undo, up to a maximum of ten actions, but note that it is reset to none after performing an operation that cannot be undone.

### Network toolbar



A new toolbar indicates the network status of Designer, i.e. either 'Online' or 'Offline'. The toolbar can be undocked from the top of the screen and the resultant floating window can be relocated as required.

Also the Network view icon on the status bar will now flash 'load' when a device needs loading.

### Configuration windows

A Configuration window enables the detailed layout of signal processing objects for a device. It also shows their interconnections and relation to the external audio, control and network ports on the rear of the device.

Each device can have *one* active Configuration window, which can be switched between a number of different Configuration layouts.

This window has two main areas; to the left there is a list of available audio 'Processing Objects', a section to work with 'Configurations' and a button to 'Compile' your design. The main window area on the right is used to layout the processing objects.

When you create a new Configuration the main area contains objects that represent each of the Input and Output ports for the device. Also there may be processing objects which are permanently fixed in the device and do not vary when different Configurations are selected.

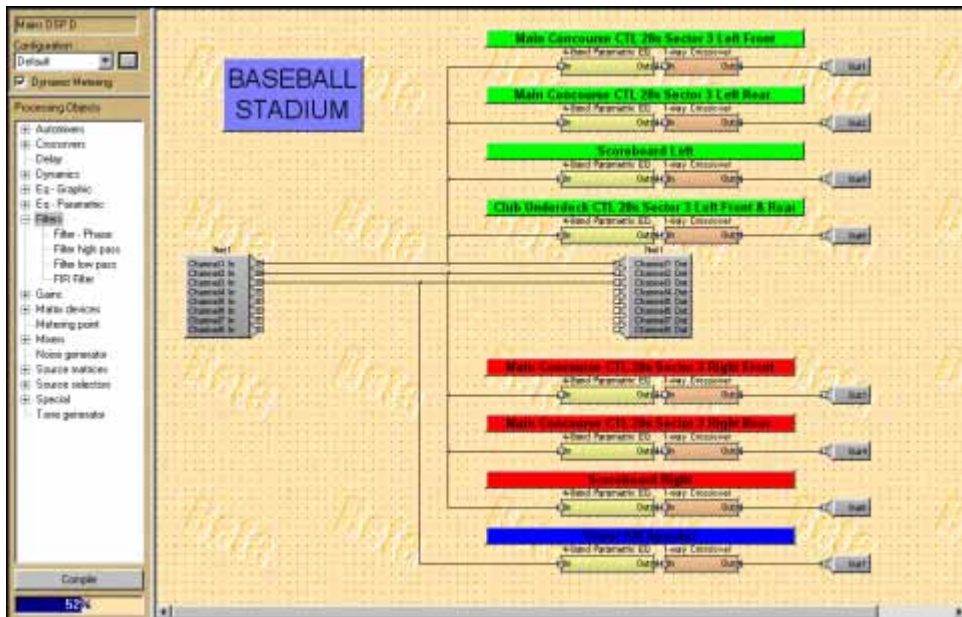

## Network window

The Network window (or 'view') is used to work 'online' with the network of Soundweb devices and to load the compiled version of your system design into the hardware. It displays the relationship between the devices in your design and the actual devices on the network to which the PC is connected. It is also used to load revised 'firmware' operating software into the devices

See '**Firmware Updates**' for more details.

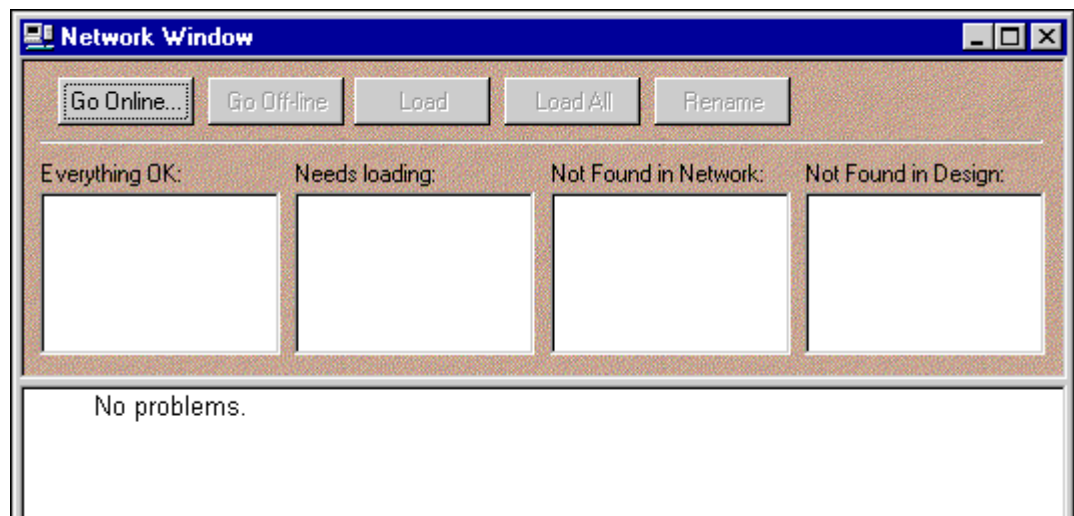

## System Design Files

The system design file (extension .SDF) is the principal data file. It contains all of the information about your Soundweb design; layout of the devices, processing blocks, Configurations, Presets, parameter settings, security information, graphical annotation, etc.

When transferring your system design between different computers you need only copy the system design (.sdf) file - no other files are required.

(The only exception to this is user defined Macros - see the 'Macros' topic for details).

They consist of one or more map windows which contain graphical representations of the DSP processing functions which are wired together to form the required system. This is then compiled into code, which is loaded into the Soundweb hardware.

Soundweb Designer works with one system design file open at any one time. To compare different systems, you need to open two copies of the Soundweb Designer application.

If you exit a session without changing the design since the last file save, but you have adjusted some parameters, you will be asked if you want to save before quitting. '**Yes**' will save the updated parameters. '**No**' will retain the original parameter values.

System design files are manipulated with the usual commands on the Windows File menu: **New**, **Open**, **Save** and **Save As**.

## Program Preferences

A number of aspects of the Soundweb Designer software can be customised to suit your individual needs. These are called '*Preferences*'.

### General Application Preferences

For items which are related to the *installation* of Soundweb Designer, and which therefore apply across all system design files

Select **View>Preferences>Application** and click on the **General** tab.

This dialog gives access to the following preferences:

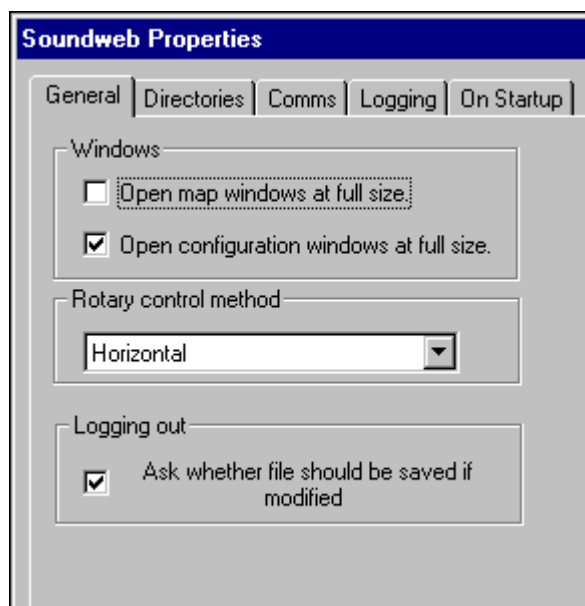

*There are further tabs to set up the Comms, Event Logging and on startup preferences, please refer to 'Working Online' and 'Event Logging' for information relating to these settings.*

### Windows settings

These check boxes allow you to select how a window is sized when it is created for the first time. If a box is checked, the window type indicated will always be made as large as possible to fit within your main Soundweb Designer area (note that this is different from the Windows *maximised* style). If the box is unchecked, the window type indicated will be set to a default smaller size.

# Soundweb™





## Rotary control method

You have three choices for the way on screen rotary control objects work.

- **'Horizontal'** - adjust by clicking in the centre of the control then moving the mouse from side to side.
- **'Vertical'** - adjust by clicking the mouse on the control and by moving the mouse up and down.
- **'Angular'** - adjust by clicking the mouse on the control and using a circular motion to mimic a hand turning the control.

Each method has its advantages. Linear (vertical or horizontal) control is easier to use when adjusting rotary controls *blind*, i.e. when looking up to listen to audio. The rotary method is perhaps more intuitive for novice users.

## Logging out

This option enables the designer to disable the dialogue box that would normally be shown when logging out of a design file in which changes have been made. As this can apply to parameter changes and not just design / layout changes it can be advantageous to disable this dialogue to prevent users from overwriting previously configured control settings.

## Directories

- Select **View>Preferences>Application** and then the **Directories** tab to display the following dialog:

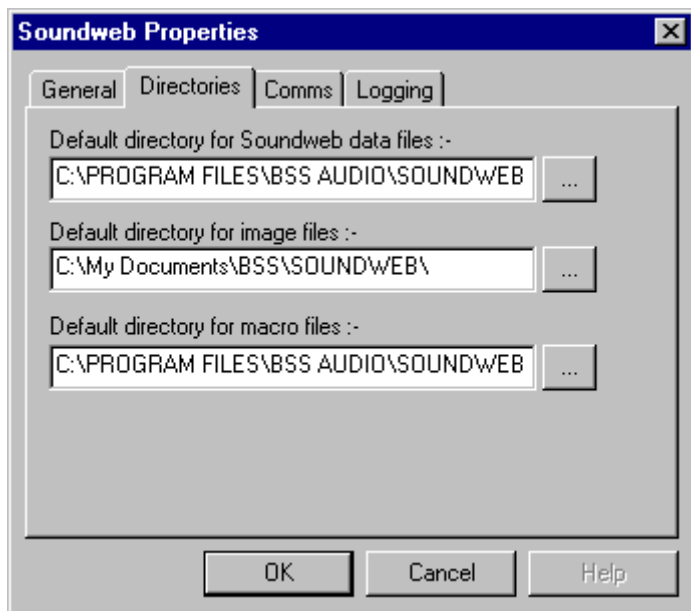

The Soundweb Designer application will use these directories.

- *Default directory for Soundweb data files:* specifies where Soundweb Designer stores System Design Files.
- *Default directory for image files:* specifies where Soundweb Designer will look for images (bitmaps, WMF files etc.) when loading graphics.
- *Default directory for macro files:* specifies where Soundweb Designer will read any Macros, and where it will export Macros.

The example screen shows some defaults set by the installation program.

- Click on the button to the right of the required directory name to change any of them to a different directory.

# Soundweb™

## 2. Map windows

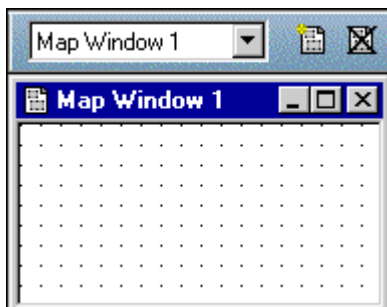

Map windows are the ‘virtual canvases’ on which you design your system. They enable the configuration of the device audio processing and the construction of control panels in an easy to understand graphical method. When you first start a new system design file, you are presented with a blank map window - this is like a canvas onto which you can paint a picture of your system.

You may choose to only use one map window in your design, or you may wish to use several different map windows, each presenting a unique picture of different parts of the system.

Map windows contain one or more of these:

- **Icons** representing hardware devices in the design.
- **Wires** indicating the connections between the devices.
- Software **controls** such as pushbuttons or faders.
- **Images** such as lines, bitmaps and text for adding colour and shape to help clarify a design.

A special form of map window exists that contains software controls but no device icons: this is called a *control panel*.

### Creating Map windows

When you create a new system design file, you normally automatically create a map window, called ‘Map Window 1’. You can create further map windows using the **Map>New Window** menu command or the  button on the Map toolbar.

## Using Tabs to group Map windows

When you create a new map window, you can group it with another map window into a single *tabbed* frame.

To do this:

- 1 Select an existing map window.
- 2 Right-click anywhere in the middle of the window.
- 3 Select **New Tab** from the menu.

A new map window will be created as part of a tabbed group with the old one, like this:

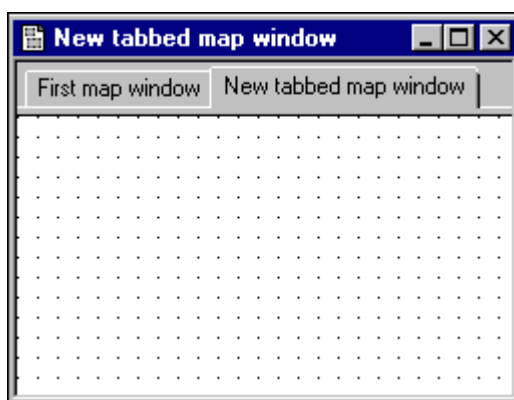

Note that tabs have to be created *before* using a map window, i.e. map windows cannot be transformed into a tab window later. To put already created objects into a tabbed window, use the standard cut and paste functions.

## Navigating between Map windows

You can navigate between open map windows using the list of open windows at the bottom of the **Window** menu (there may be a **More Windows...** option if the list has become rather long).

To go to a map window which has been closed, and which therefore does not appear in the list of windows in this menu, use the **Map>Go To** command - this displays a list of all available map windows in use in the system design file. Alternatively, you can also select a map window in the combo box on the map toolbar.

It is also possible to arrange 'link' buttons to switch between map windows.

## Design and Operate modes

A map window can be in one of two modes: '**Design**' or '**Operate**'. You can tell which mode you are in by looking at the mouse pointer. In Design mode, it is the conventional windows arrow. In Operate mode, the mouse pointer is a pointing hand.

- In Design Mode, the mouse is used to change the design of the window by adding, deleting, modifying or removing control surface elements, devices and graphic items.
- In Operate Mode, none of these things can be moved, and the mouse is used to adjust controls, or to activate pushbuttons.

You can switch between modes using the **Map>Design** and **Map>Operate** menu commands. Alternatively, right-click on a blank area of map window, and use the **Design** or **Operate** commands in the right-click menu, or press **ALT+D** or **ALT+O**.

## Map window preferences

Select **View>Preferences>Map** and click on the '**Map**' tab to display a dialog with settings related to the active map window.

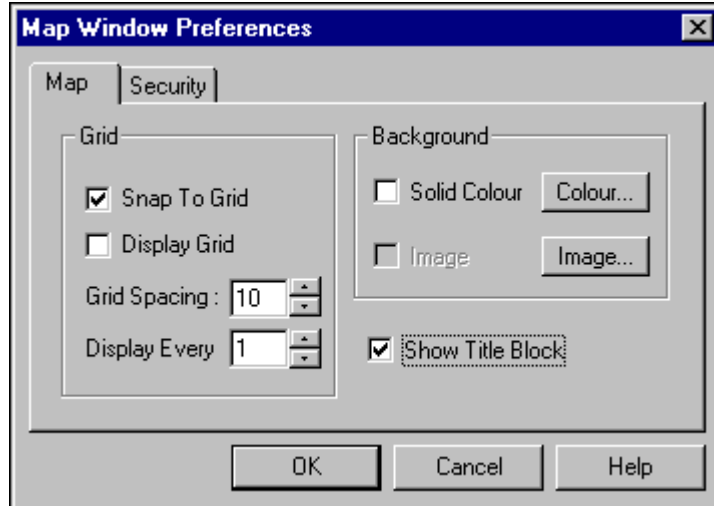

The following things can be changed:

- Grid: choose to display a design grid or not (Design mode only - the grid is never displayed in Operate mode). Also select the grid size and choose to 'snap' window items to the grid or not.
- Background: change the colour or use of an image for the window background.
- Show Title Block: enables title blocks to be added to the layout, mainly for printing.

Clicking on the **Security** tab allows you to set the protection requirements for the window via a system of security 'levels'; see Security topic for more information.

## Full Screen Mode

Accessed from the View menu, or using **CTRL+ALT+F**.

Selecting full screen mode enlarges the currently active map window to fill the screen completely. This allows the design of larger control panels, and the menus and tool bars can be hidden from view (and therefore tampering made impossible). Using this feature, a pc controlled Soundweb system can be made more aesthetically intrinsic to the task that it is set up for.

**CTRL+ALT+F** toggles between full screen and normal operation, while **CTRL+TAB** cycles through any active map windows. Menus can still be accessed with the usual windows keyboard commands: **ALT+F**(File menu); **ALT+V**(View menu) etc.



Whilst in full screen mode (in an unsecured design file), a 'Close Window' button is present. Pressing this button repeatedly will close all active map windows until the last remaining map window has been closed. Then the button changes to 'Exit Designer' and returns the user back to the normal Designer working overview. A dialogue box will ask if you wish to save the file before closing Designer.

When in 'auto-online' mode the 'Close Window' button is hidden and keyboard shortcuts can be disabled, i.e. **CTRL+ALT+F** will not work.

# Soundweb™

## Map Window layout options

To alter the order in which overlapping objects are displayed in order to prevent text and graphics looking messy:

- Right-click on an object and select one of the commands **Bring to front**, **Bring forward one**, **Send to back**, or **Send back one**.

Map windows can be deleted and renamed using the **Map>Delete**, or  toolbar button, and **Map>Rename** commands from the menus.

It is now possible in Design mode to align multiple objects, remove gaps between them and make them the same size as a chosen object.

- Select two or more objects and use these options from the context menu: **Make same size by**: Width, Height or both
- Choose one of these options and then click on the object that you wish to use as the template for the operation.

For example, 2 sliders are selected, the leftmost being wider than the right, and **Make same size by**: Width is chosen from the right click menu. The cursor then changes to reflect a scale operation and if the right hand slider is now clicked on then the left hand slider will change width to match it.

**Align by**: Top edges or Left edges

**Remove gaps**: Horizontally or Vertically

These options will align objects immediately without the need for further selection.

All these operations can be undone with the Undo feature.

## Adding text and graphics

Three forms of graphical items can be added to map windows and the Configuration window:

- Text objects.
- Images.
- Scales.

These can be used to help the user navigate the design, or simply to improve the appearance.

To add, move, delete or modify graphical items in a map window.

- Select **Design** mode.

New graphic items can be snapped to a grid by selecting this option in the **View>Preferences>Map...** dialog.





The order of overlapping graphic items may be changed using the right click options as described for objects on map windows. Arrange objects to avoid *messy* layouts!

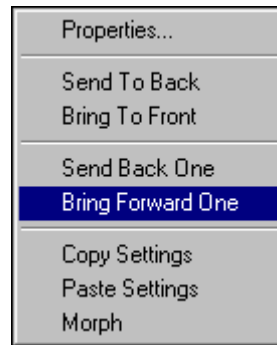

Wires can also be added for annotation purposes at arbitrary positions in map or Configuration windows, even if they do not connect active system items. If a wire does not have both ends connected to active connection points, it is considered *dumb* and is simply ignored by Soundweb Designer.

## Text objects

To *add* a text object:

- Select **Add>Text Object**, or use the  button in the Object toolbar, and click on the place in the window where you want the text to be placed. A flashing cursor will appear where you may type in your text.

To *move* a text object:

- Click on it to select it. A box will appear around the text; you can now drag the box to a new location.



To *delete* a text object:

- Select it and press **Del/Backspace**.

To *edit* a text object:

- Double-click on it - this brings up a flashing cursor which allows you to edit the text.

To *change properties* of a text object (such as its font size, type style or colour):

- Right-click on the text object and select **Properties** from the right-click menu.

# Soundweb™



## Scale objects

Scale objects are rectangular blocks that contain a series of numbers placed in accurate positions. They are often used next to a fader or EQ control box.

To create a scale:

- 1 Select **Add>Scale Object** or  button in the Object toolbar.
- 2 Click in the map window where you want the scale text to be placed.
- 3 Stretch the scale object to the desired size by dragging a corner out.
- 4 Select **Properties** from its right-click menu.
- 5 Change the style and font properties of the object as required.
- 6 From the **Scale** tab, select its 'Orientation' and 'Type' as required and choose 'Minimum' and 'Maximum' values for the scale (to a defined decimal place).

To input the numbers for the scale:

- 7 Double-click somewhere on the scale and type in a relevant number; repeat this for as many numbers as needed.

As they are inputted, they will be placed automatically in the correct position on the scale.

Double clicking on one of the numbers allows you to edit it (or delete it).

Double clicking on a blank area of the scale object allows you to put in further numbers.

## Images

Soundweb Designer supports two graphics file types:  
Windows bitmap files (.BMP) and Windows metafiles (.WMF).

To *add* an image to your map or Configuration window:

- 1 Select **Add>Image** or  button in the Object toolbar.
- 2 Click on the place in the window where you want the top left-hand corner of the image to be placed.

A dialog box will open asking you to select the file to be displayed.

- 3 Select the file and press **OK**.

To *move* an image:

- 4 Click anywhere inside it to select it, and drag the image to the new location.

To *resize* an image:

- 5 Select it and then use the handle provided at the bottom right hand corner. Alternatively, use the **Properties** dialog from its right-click menu. Here 'Size' and 'Scale' can be adjusted with constrained proportions; i.e. if you change any one of these items, the other two will change to reflect the modification that you have made. The image can be *stretched* to fit the new size or *tiled* to fill the new dimensions.

To *delete* the image:

- 6 Select it and press **Del/Backspace**.



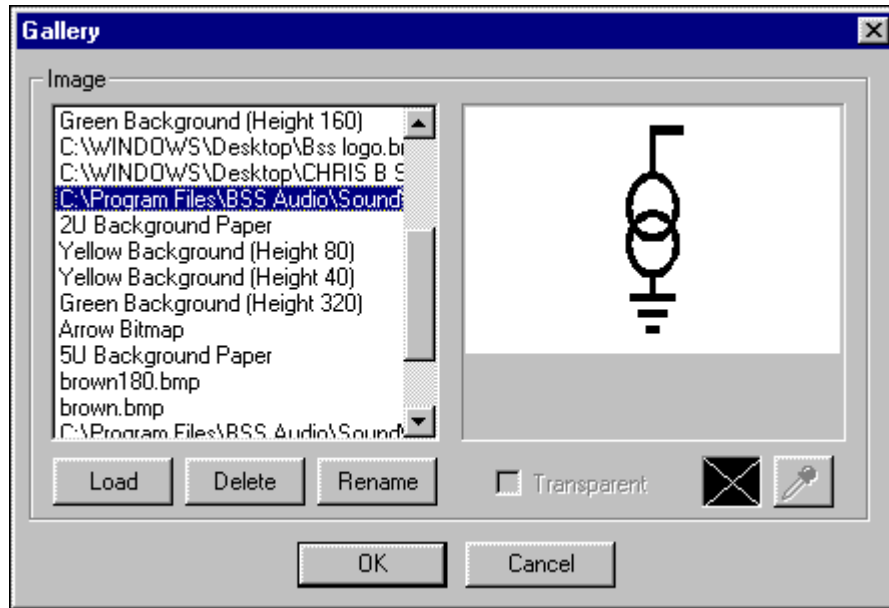

Soundweb™



## Image Gallery

The Image Gallery is accessed from **View>Image Gallery...** or by using the **Gallery** button that can be found in a new image 'open' dialog box. It contains a list of all of the images and WMF files currently in use within this system design file.

You can add images from your hard disk using the Gallery dialog box, or remove them. Whenever you load an image from disk into a map window or Configuration window, that image is also added to the Gallery and saved with the system design file. Therefore, images can be retrieved from the Gallery even if the original files are no longer available.

## Exporting map window contents

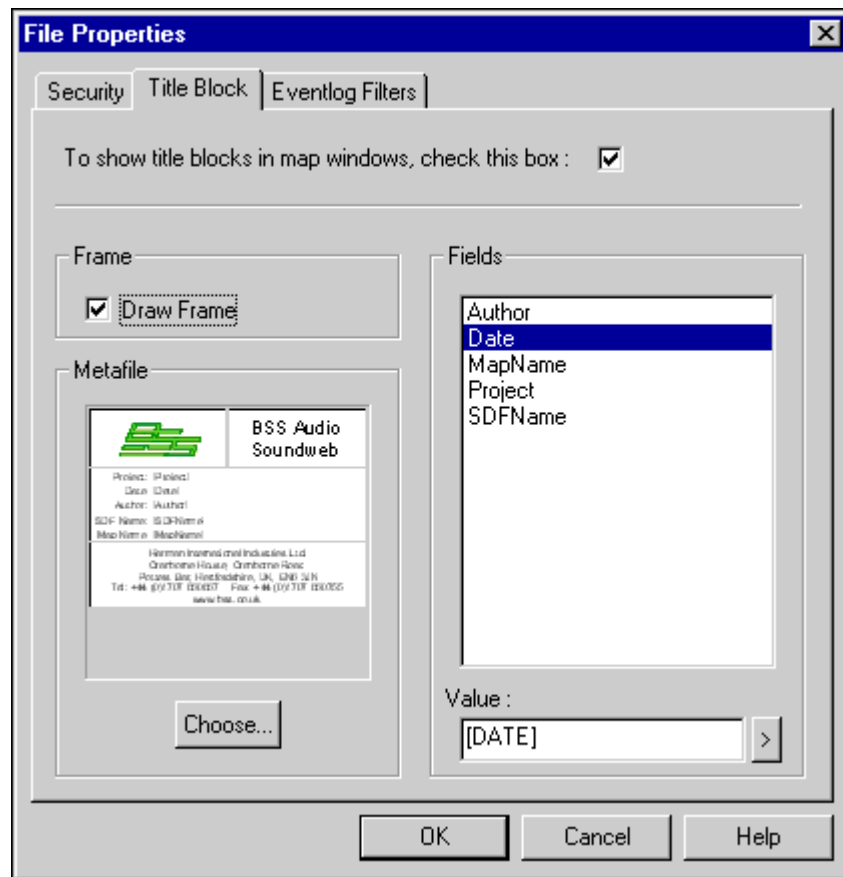

In addition to printing your map window, it may be useful for you to export it for inclusion in other Windows applications such as a word processor file.

To do this:

- 1 Click on the map window you wish to export.
- 2 Select **File>Export Map Window...**

The file can be saved as either a standard Windows metafile (.wmf) or enhanced Windows metafile (.emf). Select whichever is preferable for your use. Here is an example of a simple



map window exported in this way:

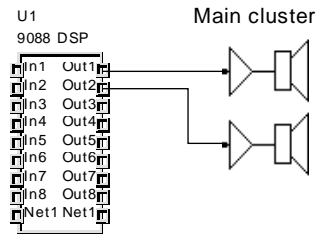

You may find that using a screen capture program and a bitmap file may look better on the PC screen, however the metafile will render text better when printed (and will take up considerably less disk space).

**Soundweb™**

## Title Blocks

A Title Block is a user-defined metafile that can be applied to all, or selected, map windows. It can display particular information to accompany the design (e.g. company logo and contact details) for screen viewing or printing. Information such as the date, system design file name and path, map name and currently logged on user can be automatically filled in to appropriately predefined fields. In addition, custom fields can be set up in the metafile which can have extra information typed into as required by the system designer.

To add a title block to your system design schematics:

- 1 Use **View>Preferences>System Design File**.
- 2 Select the **Title Block** tab.
- 3 Enable display of Title Blocks by checking the box.

! This will apply to *all* map windows in this system design file unless switched off individually by using **View>Preferences>Map** and deselecting the 'Show Title Block' checkbox.

- 4 Press the '**Choose**' button to select a Windows metafile, its contents will be previewed in the window above this button.

The complete image can be 'framed' so that its actual size can be seen on the screen.

To fill in a predefined Title Block 'form':

- 1 Click on one of the fields in the '**Fields**' list box.
- 2 Type the required text to be displayed on the Title Block into the '**Value**' text box. Alternatively, press the '>' button to select one of the options (Date, File Name, File Path, Map Name or User Name) to be filled in automatically.
- 3 Press **OK**:

The Title Block graphic is justified to the top left hand corner of your map window.

## Defining your own Title Block

You may already have a standard company logo and/or details as a Windows metafile, which you can import into Soundweb Designer. If not, or you wish to create a form using text fields to input information about the system design, this can be implemented using any of the more reasonable Windows graphics applications. Save the resultant file as a .wmf or .emf.

Alternatively, you can create your own custom Title Blocks from within Soundweb Designer.

Here are the steps for doing this:

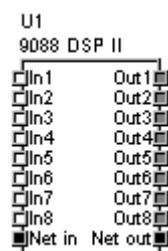

- 1 Create a new map window with **Map>New Window**, or  button on the toolbar.

- 2 Design your Title Block by adding text boxes, wires and bitmaps. You can play with the text fonts and properties to make them more attractive. A useful technique is to use an empty text box with the edge style 'bump' as a simple



- way of drawing a rectangle.
- 3 To define a 'field' for inputting information when the Title Block is used, define a text box where the text is enclosed by the vertical bar character '|'. For example, to create a field for the author of a project, create a text field "|Author|". When the Title Block is in use, the author of the project will be able to replace this field with their name.
  - 4 When you're happy with the way your Title Block looks in the map window, use **File>Export** to export it as an enhanced metafile (.emf).

You should use an 'empty' system design file, create your Title Block in a map window and keep this file available for Title Block design revisions in the future. Be sure to save the system design file, so that you can change the design later - you can't edit the metafile itself in Soundweb Designer after it has been saved.

### Printing Layouts

Individual map window layouts can be printed with or without a title block. Select the window that is required to be printed and use either **File>Print** or **CTRL+P**.

A **Print Preview** option is also available from the File menu so that the layout can be seen fitted to the selected page size from **Print Setup**. If the option to draw a frame has been used in the Title Block preferences then this will border the edge of the paper.



## 3. Devices

### Defining the Devices in your system

Before a hardware device can be configured, it needs to be represented in the software.

To *add* a device to your design:

- 1 Create or select an open map window.
- 2 Select **Add>Device** (also available in the right-click menu), or  button on the object toolbar.

This displays a dialog box with a list of available device types.

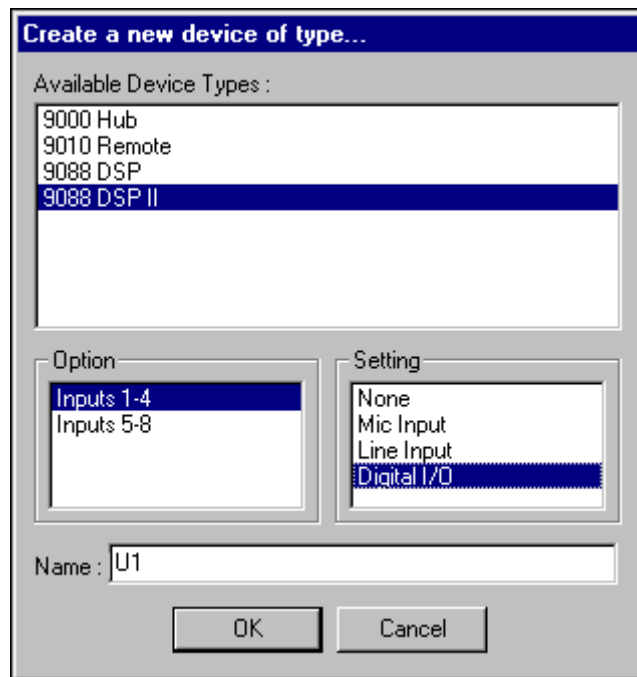

- 3 Select one and press **OK**.
- 4 Move the mouse to the location in the map window where you want the device to be placed. Click again to place the device.

An icon representing the device will appear on the map.

Adding further devices:

Repeat this process to define more devices. Alternatively, create a second device identical to the first by holding down the control key and dragging the icon to another place on the map window (or select the device and use the usual Windows copy and paste functions).



## 4. Configuration of a Device

To configure a device for audio processing:

- Double-click on its icon in a map window or select **Configure** from the right-click menu of the device object. This opens its **Configuration window**.

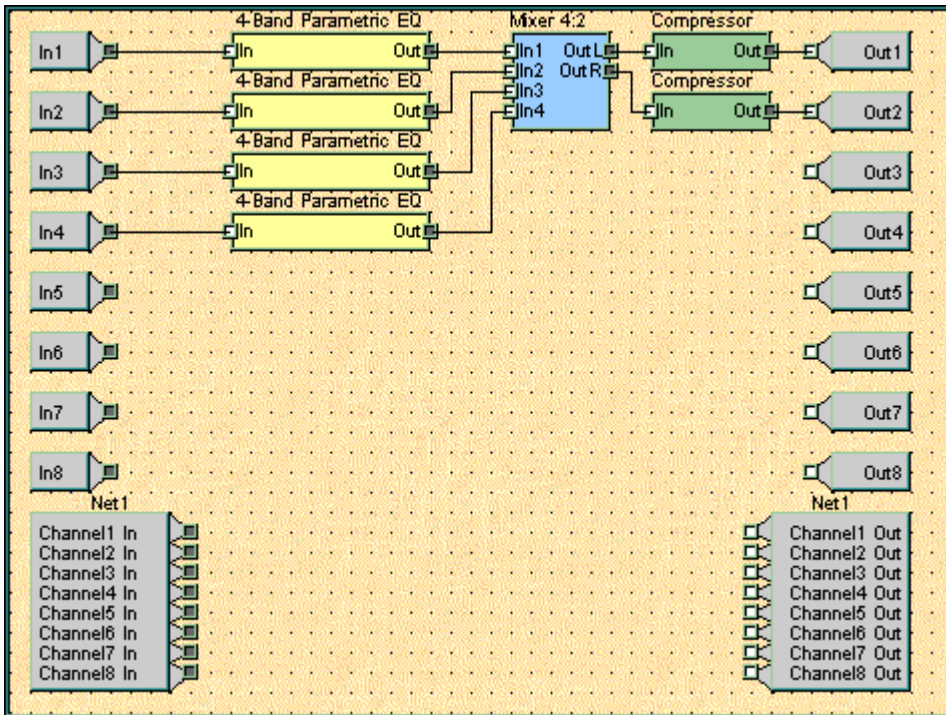

### Configurations

Each Soundweb device can store a number of different Configurations. A Configuration is set of processing data for each device and relates to *one* device only. You can switch Configurations instantly while the system is running.

The set of data includes the following:

- A list of the audio processing objects that are loaded in the device that defines what function in the system the device will perform.
- The signal paths between the inputs and outputs of the device (including network channels) and the position of the processing objects in those signal paths and their connection to each other.
- Certain other functions such as data relating to the switches on the contact closure ports, or the RS-232 serial interfaces.

A Configuration sets the operation of one particular device so does *not* store information about other devices in the system. A 9088 device can store around 12 complex Configurations (or more if simpler).

Note: use of foreign characters, e.g. ü, in Configuration names can cause devices to stop

# Soundweb™

## Device options

If a Soundweb device has factory-set options, these can be configured in the new device dialog when the device is first created or by selecting **Properties** from the device's right-click menu and selecting the **Options** tab.

For example, a Soundweb 9088 options screen looks like this:

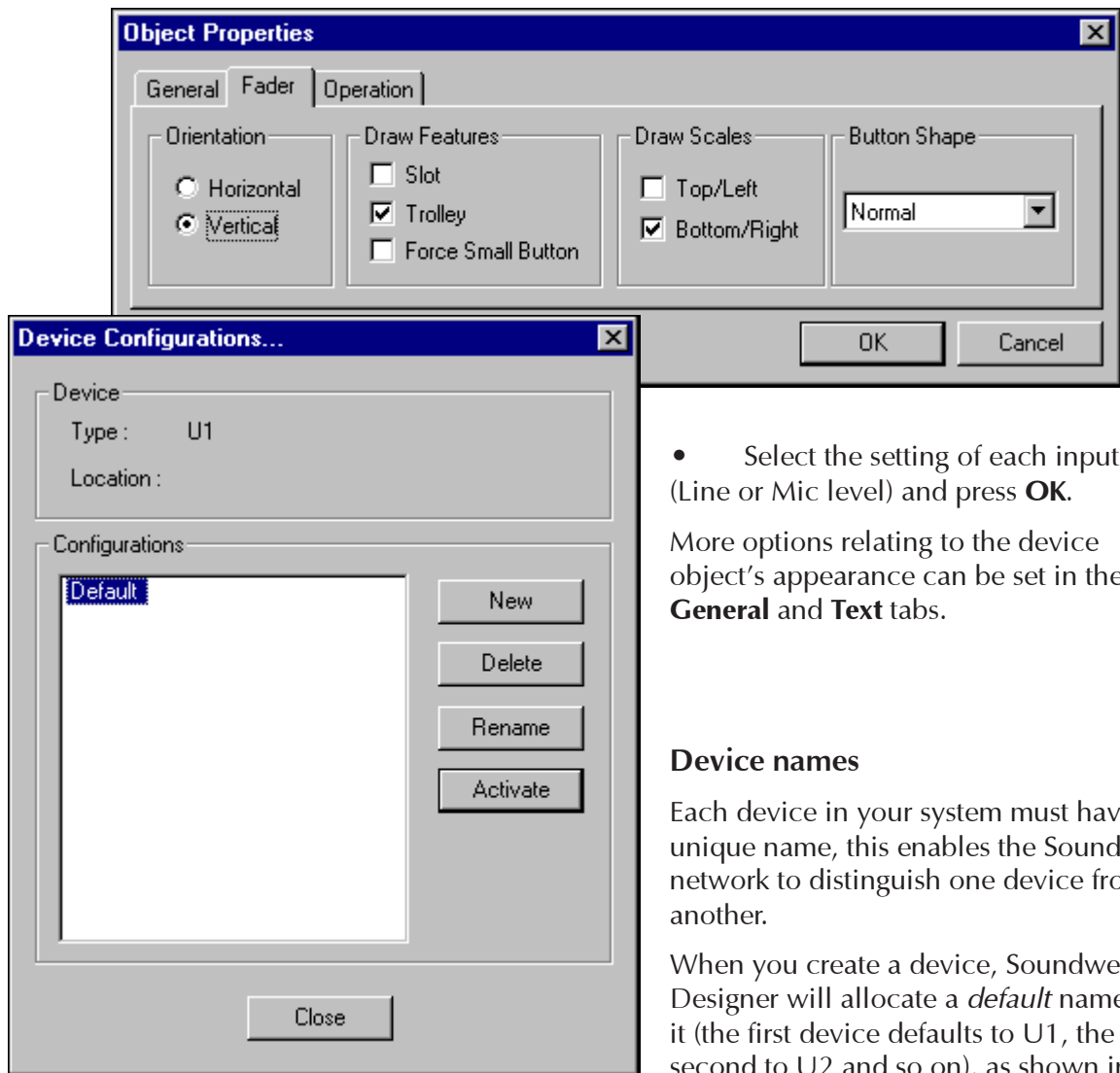

- Select the setting of each input card (Line or Mic level) and press **OK**.

More options relating to the device object's appearance can be set in the **General** and **Text** tabs.

## Device names

Each device in your system must have a unique name, this enables the Soundweb network to distinguish one device from another.

When you create a device, Soundweb Designer will allocate a *default* name for it (the first device defaults to U1, the second to U2 and so on), as shown in the **New Device** dialog.

If you prefer, you can replace it with a name of your own, such as "Conference room 1" or "Main paging mixer".

To change the name:

- Right click on a device icon and select **Properties** then the **Device** tab and type a new

Name.

### Deleting a Device

To *delete* a device:

- Select it and press **Del/Backspace**, or select **Delete** from the device's right-click menu.

Soundweb™

## Naming Ports on Devices

A Soundweb device object shows connection points for any analogue ports on the device as well as network ports.

These ports are not *active* as far as the design software is concerned, but can be used to annotate the diagram.

For example, you could add text and/or images to your diagram to represent the source and destination equipment - i.e. a microphone, dat machine, amplifier and loudspeakers. These can then be 'wired' to the inputs and outputs of the Soundweb device to clarify your design.

## Defining network connections between Devices

The network connection points (e.g. labelled NET In, NET4 Out etc.) represent the jack sockets on the back of the devices.

To specify in your schematic that network sockets *should* be connected up, add wires between the connection points representing the jacks.

Wiring network connections of devices on different map windows creates a flag on each of the map windows showing the destination device names and port identifiers.

See also **Device Control Panels** in the **Control Panels** (section 6).

## Multiple Configurations

To define multiple Configurations for a device, press the  button next to the Configurations combo box in the Configuration window.

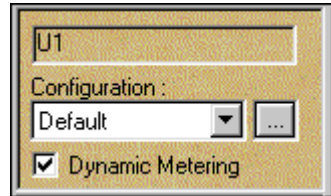

The resulting dialog contains a list box with the names of all the Configurations defined for the device, associated with five buttons: **New**, **Rename**, **Delete**, **Activate**, and **Close**.

To create a Configuration:

- Press **New**.
- Type in the name and click **OK**.
- To make this new Configuration the current one, click on its name and press **Activate**.

The **Rename** and **Delete** buttons allow you to change the name of the Configuration, and to delete it altogether. These actions prompt you for confirmation, as significant amounts of data can be lost. Standard **Edit** menu functions (**cut**, **copy** and **paste**) work on highlighted Configurations.

## Audio Processing Objects

The left-hand edge of the Configuration window contains a box showing a list of the 'Processing Objects' available.

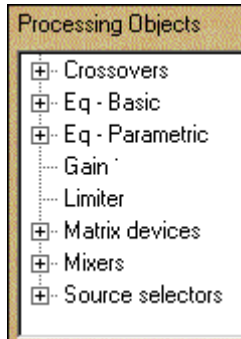

- To add a processing object to your system, drag and drop the name of the object from the list to the main window area.
- On releasing the object, a representation (a rectangular block with the name of the object inside and connection points around the edge for the different inputs and outputs) is created in the window.
- The objects can be moved around on the screen by picking them up and dragging them with the mouse or by using the cursor keys on your keyboard when the object is selected.
- Most processing objects have properties associated with them that can vary the behaviour and/or options available.
- Double clicking on a processing object opens its control panel - a software version of the hardware control interface that you might expect to see for the object in the real world.

There is further information in the **Technical Reference** section about all the different types of processing objects, their properties, options and controls. Control Panels are covered in detail further on in this manual.

# Soundweb™





## 5. Virtual Wiring

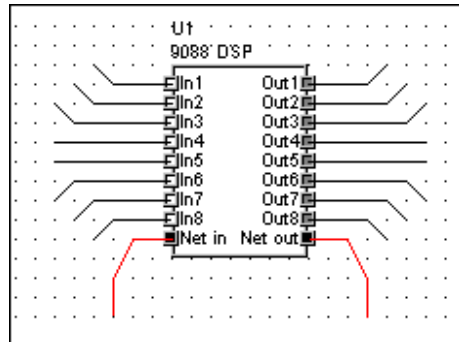

'Virtual wires' are used to connect the objects on the layout and route the signals between the connection points of processing objects or Input and Output ports. This section explains the use of the mouse when creating wires.

The mouse behaves differently according to whether or not you are in **Edit** or **Add Wires** mode. You change modes with the **Edit>Edit Wires** and **Edit>Add Wires** menu commands (also in the right-click menu).



Add Wires



Edit Wires

### Wiring up two connection points

- 1 Select **Add Wires** mode.
- 2 Click the mouse on a connection point (the small square node) on one of the objects; the pointer changes to a '+', and a wire is shown 'rubber-banded' from this node to the present mouse position.

To change the direction of a wire:

- Move the mouse to the place where you want to end the first segment of the net, and click there. A new wire is shown 'rubber-banded' from this point to the present mouse position.

Repeat this action to create more segments and finally click the mouse on the second node to

finish creating the 'net'.

Note that you can also *end* the wire by double clicking on open space, this leaves the end of the wire floating, for later connection.

### Adding a wire to an existing net

- 1 Select **Add Wires** mode.
- 2 Click the mouse somewhere on the net: a junction will be shown there, and wiring proceeds as in the section above.

Wiring can also be completed in reverse, by starting at the new connection point, and ending on the net to which the new wire is to be added. This may in fact prove to be easier as a rule.

# Soundweb™

## Adding a corner to an existing wire

- 1 Select **Add Wires** mode.
- 2 Move the mouse to the place on the net where you wish to add the corner.
- 3 Drag that point in the direction in which you want the new wire to go.

A node (junction) will be created, and the single wire will be replaced by two wires, rubber-banded from the present mouse position to the original end-points of the two wires.

- 4 Release the mouse to freeze the wires in their new position.

Repeat this process to tidy up any unwanted diagonal lines that have been created.

## Deleting a net

- 1 Select **Edit Wires** mode.
- 2 Click somewhere along the net to select it.
- 3 Press the **Delete/Backspace** key.

To delete more than one net at a time, select the first net and use **Shift-click** to select further wires.

## Moving one or more nets

- 1 Select **Edit Wires** mode.
- 2 Click on a net to select it; use **shift-click** to select more than one.
- 3 Drag the net and drop it in its new location.

## Copying one or more nets

- 1 Select **Edit Wires** mode.
- 2 Click on the net to select it; use **shift-click** to select more than one.
- 3 Hold down the **Ctrl** key, and drag the net and drop it in its new location.

## Reshaping nets

- 1 Select **Edit Wires** mode.
- 2 Click on the net to select it.



You should see that a node appears for each end of the net, and at each junction point or corner.

3 Drag one of the nodes to create the new shape.

Note that dragging a node onto another node will delete a section of line.

**Soundweb™**

## Net Notes

An incorrect connection (e.g. an input to input or output to output between processing objects) is indicated by the wire turning red.

The processing objects supplied in Soundweb Designer are set up for the default grid, which is 10x10 pixels. It is strongly suggested that you leave the grid on this setting, and leave the '**snap to grid**' option enabled.

By default, you are permitted to create vertical, horizontal and diagonal line segments. However, you can tighten this restriction by selecting **Edit>No Diagonal Lines**.

If you are in the middle of dragging something and you realise that you are doing the wrong thing, pressing the **Esc** key will abort the drag operation.

Most of the time you can stay in **Edit Wires** mode, as this will also allow you to add new wires. On occasions, Soundweb Designer will automatically switch modes for you. This saves you considerable frustration and time in flipping modes, at the expense of losing you some control. For example:

- If you are in **Edit Wires** mode, and you click on an empty connection point of a device, Soundweb Designer will assume that you are trying to wire it up and flip you into **Add Wires** mode temporarily.
- If you are in **Add Wires** mode and you click inside the body of a device, bitmap, text box or processing object, Soundweb Designer will assume that you are trying to move the object and switch you into **Edit Wires** mode temporarily.

## Automated wiring

To save time when wiring many identical connections that are spaced a regular number of grid spaces apart (e.g. wiring net inputs to net outputs or audio inputs to audio outputs).

- Put in the topmost (or leftmost) wire, then press a number key which is the number of times you want this connection duplicated (e.g. 7 if you want 8 connections).

This will not only work for single wires, but also for whole nets.

**Soundweb™**

## 6. Control Panels

Adjustments to audio settings are almost invariably made from virtual 'control panels' on the PC. External hardware controls can also be used to adjust these panels.

The settings of an audio processing object are initially adjusted using its 'default' control panel.

To open the default control panel of an audio processing object:

- Double-click on the object in the Configuration window.

The layout of a default panel cannot be changed but can be copied into a map window in order to create a new 'custom' control panel.

Here is an example of the default control panel for a mixer:

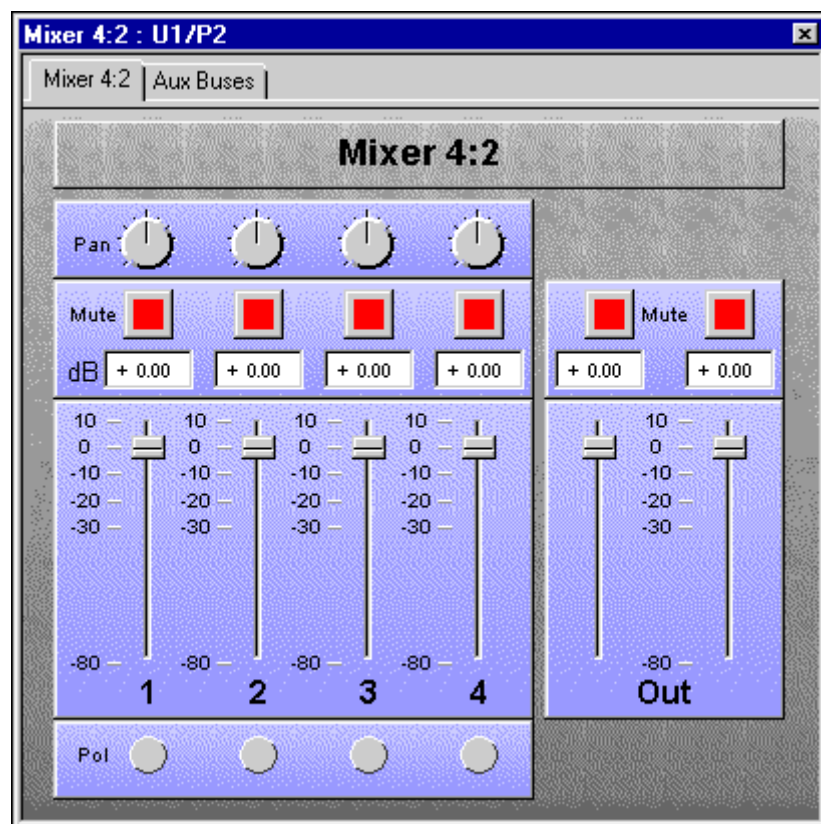

## Device Control Panels

Most Soundweb devices have control panels for adjustment of parameters like input and output gain. The control panels are accessible from the right-click menu of the device or by double clicking on one of the input/output port nodes in the Configuration window.

They contain settings that are related to the device, and are independent of any of the Configurations, although settings in these panels can be stored in 'Presets' as with other settings. Controls from these panels can be used in custom control panels.

### 9088/9088ii Inputs Control Panel

Select 'Control Panel' from the right click menu of a 9088 DSP object.

The displayed control panel reflects a 9088 equipped with mic option selected in its device properties and includes options to add phantom powering and change the polarity of any selected channel. Input gain can be adjusted between 0dB and 72dB in increments of 6dB for mic inputs and between 0dB and 12dB for line inputs.

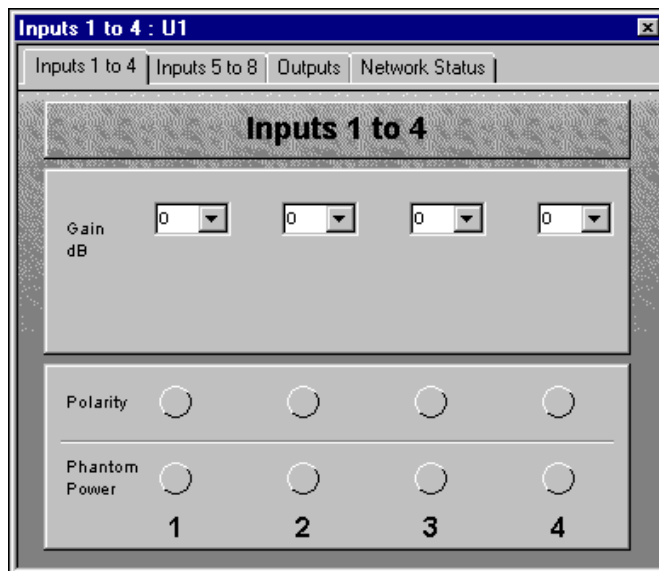

# Soundweb™



## 9088ii Digital Inputs Control Panel

Select 'Control Panel' from the right click menu of a 9088ii DSP object.

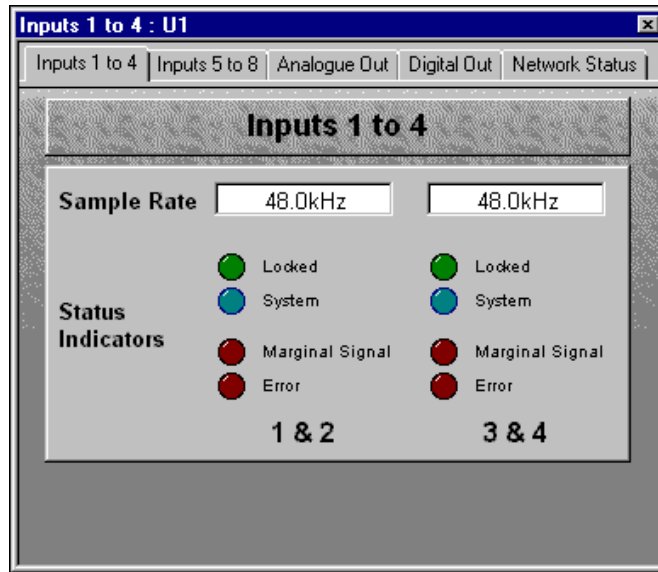

A 9088ii with digital interface card displays information about the digital clock frequency and synchronisation status.

The Soundweb system must be 'online' to accurately communicate the digital settings in this panel.

If an external clock signal is detected the system will 'Lock' to it lighting the green indicator and the sample rate will change to reflect the detected frequency. The blue led indicates that the received clock is phase locked to the internal 48kHz system clock.

The red 'Marginal Signal' and the 'Error' indicators will light if the clock signal is unreliable or damaged. In this instance the affected channel will mute audio output to avoid nasty digital artefacts which could damage external equipment. The error will also light when no clock signal is present.

## 9088ii Digital Outputs Control Panel

Select 'Control Panel' from the right click menu of a 9088ii DSP object.

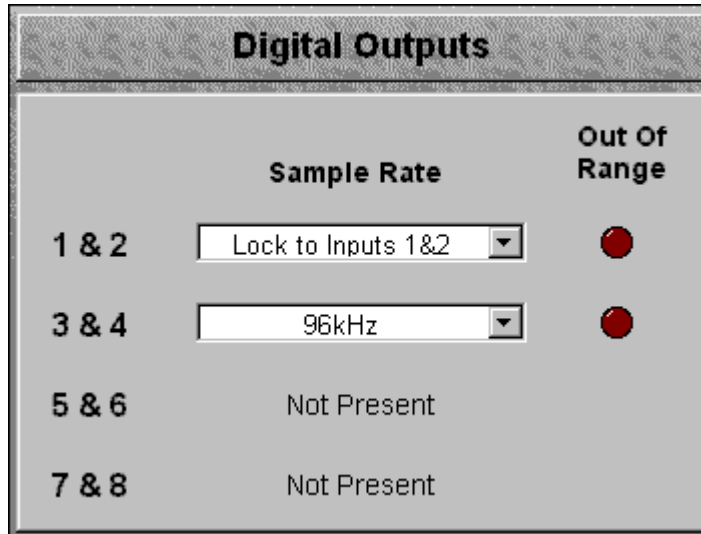

The dialogue shown is to demonstrate a range of possibilities available and is not necessarily a practical set of options.

- The Soundweb system must be 'online' to accurately communicate the digital settings in

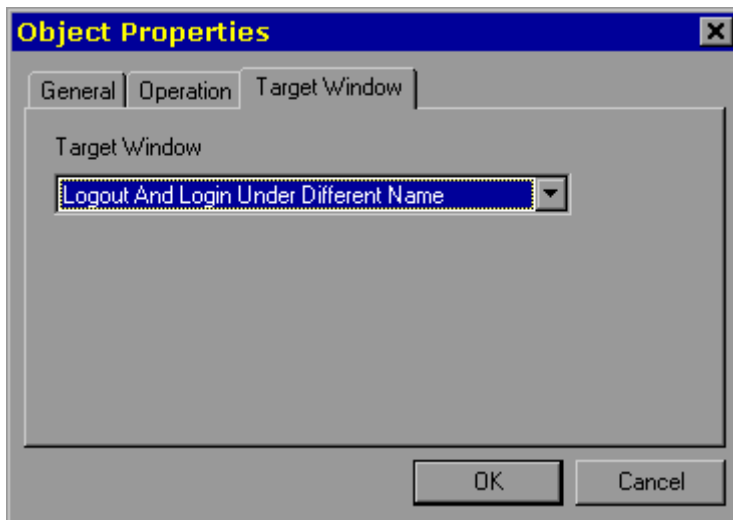

this panel.

- There are four standard internal fixed sample rates available plus options to lock to received clock from Inputs 1&2 or from an externally generated word clock signal connected to the BNC on the rear panel.
- Synchronisation to external clock source frequencies is possible between 16 and 100kHz.

# Soundweb™



# Soundweb™

If the received signal is outside this range then the red 'Out Of Range' indicator will light.

! The digital outs should not be connected to analogue inputs (especially amplification/speaker systems) as the high frequency nature of the digital signal could cause damage to your equipment.



### 9088/9088ii Network Status Control Panel

Select 'Control Panel' from the right click menu of a 9088 or 9010 DSP object.

The Network Status tab displays network traffic with two leds to represent signals received on the input or passing to the net out port.

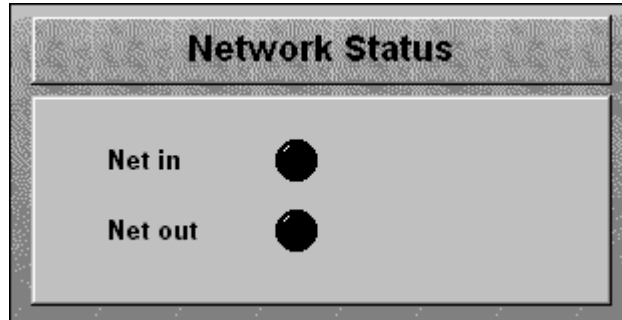

### 9000/9000ii Network Status Control Panel

Select 'Control Panel' from the right click menu of a 9000 DSP object.

The 9000 series hubs display the existence of network signals through their six ports.

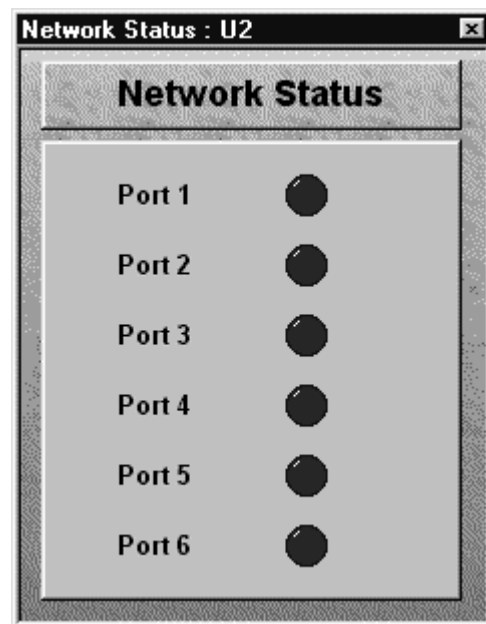

# Soundweb™

## 9088/9088ii Analogue Outputs Control Panel

Select 'Control Panel' from the right click menu of a 9088 DSP object.

# Soundweb™

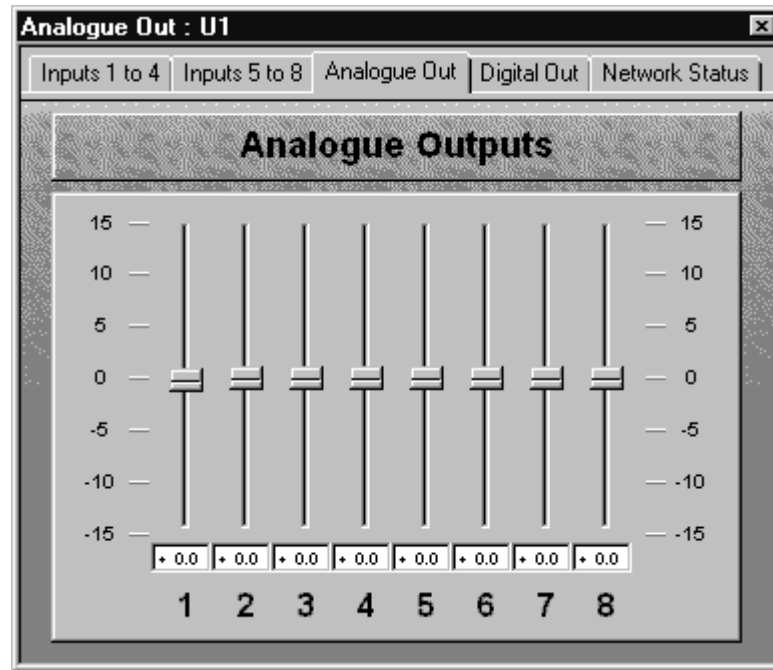

A 9088 has controls for the analogue output levels. Note that there are now value input boxes on each output for the selection of more exact decibel levels.

On a 9088ii fitted with digital interface cards the analogue outputs will still function (as they are part of the main board), i.e. these outputs will mirror the digital outputs.

It is also now possible to link the output fader objects together on a custom control panel.

## Control Surface Objects

A control panel could contain any combination of these *control surface objects*:

- Continuous controls
- Pushbutton
- Combo box
- Meter
- LED
- Parametric EQ
- Crossover

### Continuous controls

Control any continuously variable parameter. There are four different types:

- Linear fader
- Rotary knob
- Text box (for typing in a value)
- Spin increment and decrement (text boxes with up/down arrows attached).

Rotary controls can be adjusted either by vertical, horizontal or angular (radial) mouse movement (selected in **View>Preferences>Application>Rotary control method**).

### Pushbutton

Most pushbuttons are toggle buttons, which select between on/off states for a particular parameter (such as a mute switch).

Additionally, there are two special types of pushbutton: 'Preset' buttons and 'linking' buttons.

### Combo box

A drop down list box used for selecting one of a number of options. Typical of this would be a list of modes for a particular algorithm, e.g. filter types.

Presets can also be selected using the Preset combo.

### Meter

Displays the value of a parameter of an audio processing object.

When 'online' meters cause much data to be passed from the devices to the PC, so the limited comms bandwidth can cause updating of the meters to appear slow. Since this bandwidth is shared between all the on-screen meters, the best meter response is realised by closing down (not just minimising) all unnecessary control panels and map windows which have meters on them.

**LED**

The equivalent of a physical LED - displays the status of a true/false parameter.

**Parametric EQ**

An intricate graphical control allowing EQ to be set using a curve drawing mechanism.

**Crossover**

A compound graphical control-allowing crossover points and slopes to be set.

**Resetting a control to its defaults**

This can be used to set a gain control to 0dB, or a Parametric EQ control to 'all flat'.

- Hold down the **shift** key and double-click on the control object.

## Custom Control Panels

A 'custom' control panel is simply a map window containing control surface objects that are allocated and set up for your own use.

For example, a simple custom control panel might have the master gain settings for two or three different user determined 'zones', and a number of buttons to select Presets.

### Creating a custom control panel

Select **Map>New Window** or press the  button on the toolbar.

This opens a blank map page to which you can add control surface objects.

Alternatively, you can start with a 'default' panel and customise it.

To do this:

- 1 Double click on a processing object that contains control surface objects that you require; this opens its 'default' control panel.
- 2 Use **Map>Rename** to turn the default panel into a custom panel.

A warning message states:

"This operation will turn this control panel into a map window".

- 3 Press **OK**.

A dialog box appears to type a name for the new map window.

- 4 Use **Map>Design** to switch the panel into **Design** mode.

You can now modify this panel as desired, by adding, deleting or moving control surface objects, text and graphics. Also cut and paste objects from other control panels to build your own selection of controls.

To test the controls switch the map layout back into **Operate** mode by either using **Map>Operate**, **ALT+O** or from the right click menu.

Remember that controls taken from other panels will operate the parameters as if they were still part of that panel, i.e. moving a copied gain fader will move both the fader in your new panel as well as that in the old control panel. They are not 'linked' just accessing exactly the same parameter.

**Soundweb**<sup>TM</sup>



## Customising Control Surface Objects

To customise a control surface element.

- Select **Properties** from its right-click menu, this displays a dialog box with various tabs.

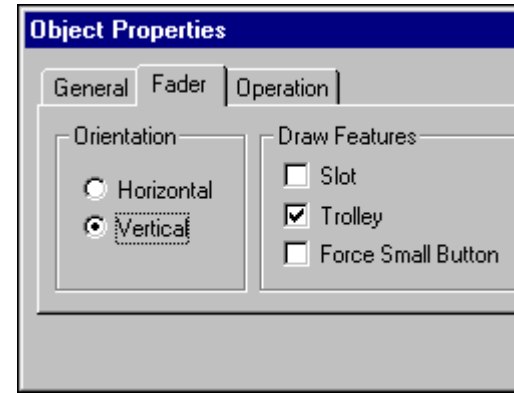
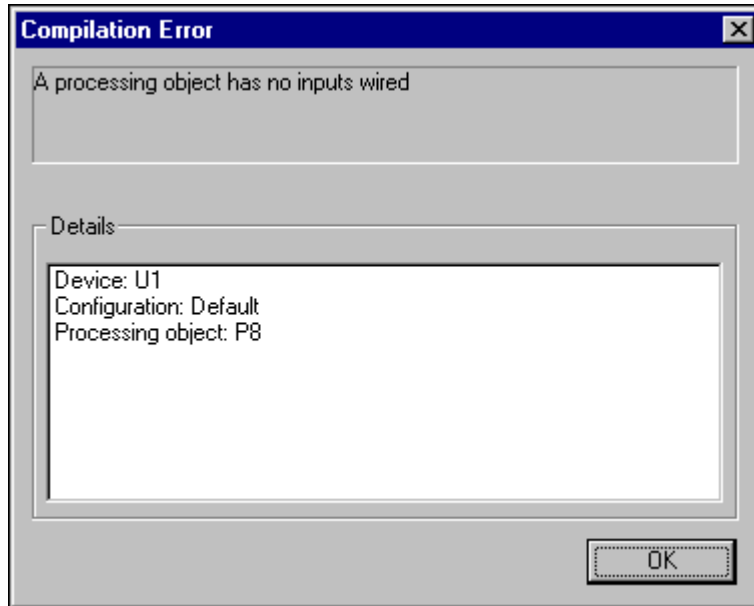

The **General** tab allows control over the colour or transparency of an object and to select a

variety of 'styles' for its edge.

Objects using text have a **Text** tab enabling control of font size, style and justification.

Other objects have an **Operation** tab, which contains various properties related to that particular type of control.

## Copying settings between objects

To copy the whole set-up from one object to another similar object (e.g. when a processing object has a complex set-up).

- 1 Select **Copy settings** from the right-click menu of the object that you have set up.
- 2 Select **Paste Settings** from the right-click menu of the object that you wish to copy it to. (Note that this is different from **Copy** and **Paste**, which would create a new object).

The most common example of this is to set up an EQ on a channel, and then to copy the settings to another EQ which needs the same set-up.

! If you copy settings between two processing objects whilst 'online', Soundweb Designer will go 'offline'. This is because some changes in settings lead to changes in the compiled design.

If you only wish to copy control values, use **Paste control values only** and you can remain



'online'. This will only work if the processing objects have the same option settings.

## Morphing a Control Surface Object

Soundweb allows you to transform the nature of a control surface object. For example, you can change a fader into a rotary control or edit box, or a switch into a combo box.

Some of the possibilities are subtler: you can change a pushbutton switch into an LED: this will provide a read-only indicator of the state of the switch.

To do a transformation:

- Select **Morph** from the right-click menu of the object you want to transform.

It is recommended that you make a copy of it first, since this process will lose any graphic properties you may have already applied to the object.

To transform a fader to an up/down button pair, it is necessary to copy the fader twice, then morph one to an *increment* control, and the other to a *decrement* control.

## Link button

A link button is a pushbutton that can be pressed to change to a different map window, use this to give the user a fast way of navigating between control panels. It can also be used to either log out then log in again or, to exit Soundweb Designer.

To use a link button:

- 1 Select **Add>Link button**, also available in the right click menu and from the  button on the map toolbar.
- 2 Click on the map window where you want the button to be placed.
- 3 Right-click on the button and select **Properties**.
- 4 Click on the **Target Window** tab.
- 5 Select the name of the desired map window or operation from the combo box.

In **Operate** mode, pressing the button will now open the chosen map window, log out or exit Designer as specified in the object properties.

# Soundweb™



## Linking Control Surface Objects

Sometimes, it is desirable to link two control surface objects together. A typical example would be the linking of two faders in order to produce a stereo gain control.

This is only possible for control surface objects in 'custom' control panels.

- Select the two desired objects (click on the first, and then **Shift**-click on the second).
- Right-click on one of the objects and select **Link**.

Note that the controls can be selected from different devices if you wish.

A dialog box asks what 'law' to use for linking the controls:

- Matched group** - operating one switch operates them all.
  - Radio group** - switching on one switch clears the others in the group.
  - Radio group (all off allowed)** - all switches can be in the 'off' state.
- Choose the appropriate law, and press **OK**.

For faders there are different laws:

**Soft Link** - allows the linked faders to have offset values, i.e. they will *follow* the operation of the moved fader but not match its exact value.

**Exact Copy** - the faders will follow the fader being adjusted exactly.

Whilst in **Design** mode, a *chain link* icon will appear next to each linked control so you can see instantly which controls are linked.

A new button will appear on the control panel.

This button is used in **Operate** mode to make or break the link.

If this facility is unnecessary, you can move the button to an unused map window.

! Note that if you delete a linking button, the link itself will *also* be deleted.

## 7. Parameter Presets

A Parameter Preset adjusts control *settings* only.

The audio is not muted during a Parameter Preset change so it is therefore preferable to a *full* Preset for changing parameter values whilst 'online'.

If the system is 'online' when you operate a control surface object, you are actually changing the value in real hardware.

If the system is 'offline', you are changing a representation in the PC's memory of what the setting will be in the real hardware when the PC is hooked up to it.

Parameter Presets also have the advantage of taking up much less memory in the hardware (so many more of them can be stored).

### Creating a Parameter Preset

- 1 Drag all the controls (in **Design** mode) that you want the Parameter Preset to adjust onto a new map window.
- 2 Next select **Add>Parameter Preset**, also in the right-click menu, or click the  button in the object toolbar.
- 3 Click on the map window where you want the Parameter Preset selector to be placed.
- 4 Now select **Add State** in the right-click menu of the Parameter Preset selector.

This opens a dialog box to enter the name for this Parameter Preset state.



- 5 Type in the name (for this state of control settings) then click **OK**.

The controls may then be adjusted (in **Operate** mode)

Another state can be added, having changed some control values, to the Parameter Preset selector by going back to **Design** mode and going back to **Add State** as before.

When all the required states have been added to the Parameter Preset selector, return to **Operate** mode. The button on the right-hand end of the Parameter Preset selector will then allow you to change to any of your predetermined sets of control settings.

To change the control settings associated with a Parameter Preset state:

- 1 Select the state and adjust the controls as required.

SOUNDWEB™

- 2 Select **Store State** in the right-click menu of the Parameter Preset selector.

! Parameter-Presets were known as 'Mini-Presets' in older versions of Soundweb Designer.

## 8. Presets

A 'Preset' is a collection of settings information, or 'snapshot' of the whole system. Each device can store a number of Presets - subject to there being enough memory in the devices to store them.

A Preset contains:

- The Configuration to be selected for each device.
- A list of the parameter settings for all of the audio processing objects.
- A screen layout of the map windows to be displayed when the Preset is activated.
- Information about the utilisation of any hardware control surface objects when the Preset is activated.

### Working with Presets

- 1 Select **View>Go to Preset View** (or use  shortcut icon at the bottom of the screen). This opens a window showing a list of the Presets defined in the design:



- 2 Press **New** to create a Preset.
- 3 Give the Preset a name and press **OK**.

This will allocate the current data (Configurations and control settings) to this Preset.

To update the information in a currently existing Preset, highlight its name in the list and press **Store**. This transfers the 'current' information into the selected Preset.

To recall the information in an existing Preset, highlight its name in the list and press **Recall**.

Soundweb™

## Auto - Online

Enables a specified design file to be loaded to a network of devices when Designer is launched. The chosen file will be opened, the PC will go 'online' to the devices, and the design file will be loaded.

Auto online is activated from **View>Preferences>Application>On Startup**

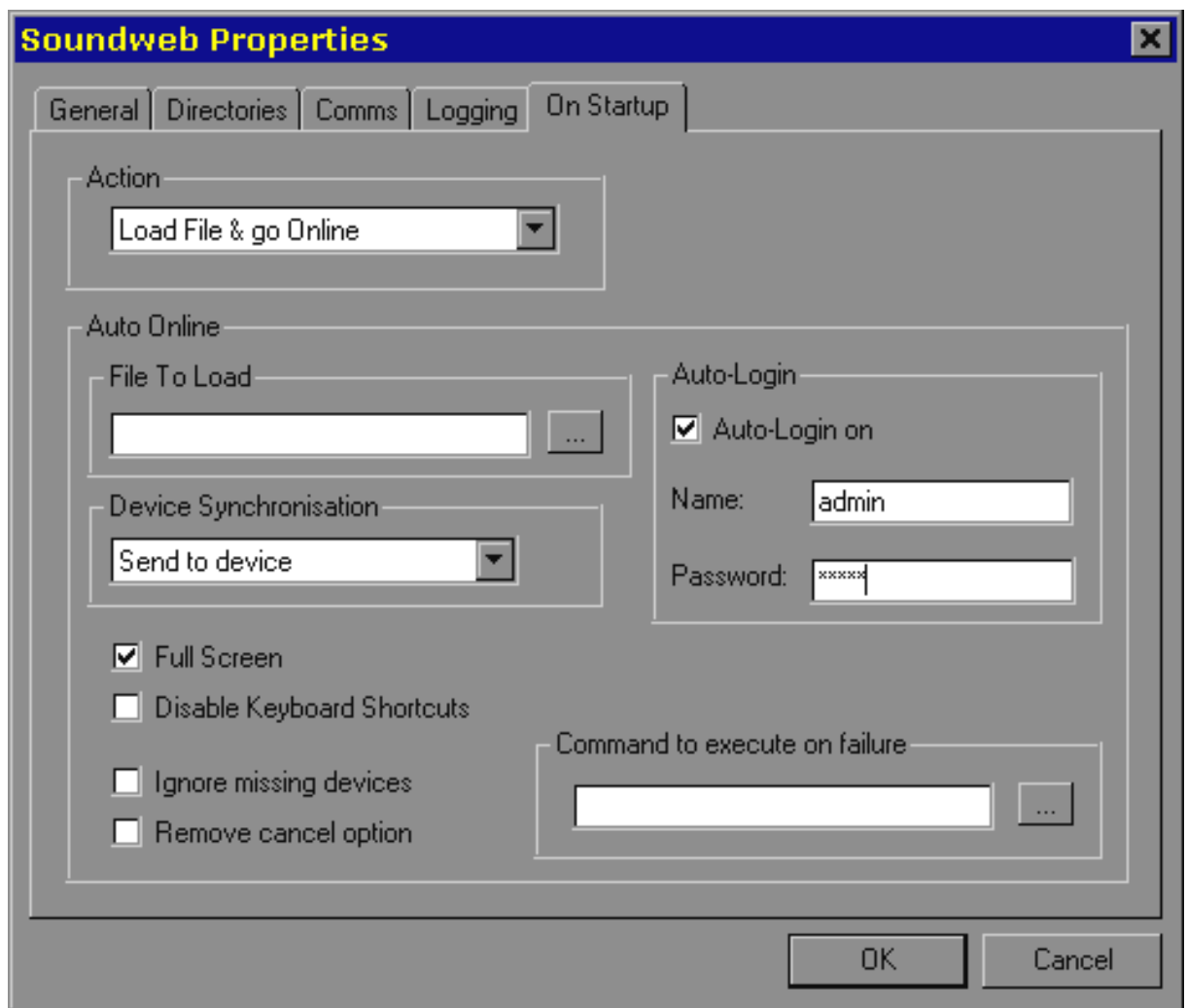

Control parameters can be synchronised either to reflect the settings stored in the devices on the network or, to update the network with the parameter values stored in the design file. The design file can be forced to open in full screen mode and the keyboard shortcuts for full screen options can be disabled.

The auto login feature allows a chosen user (with associated security clearance) to be automatically logged in, with password also. This allows the designer to set up a system with a PC connected, which on running the design file boots straight in to a preconfigured control panel. Operators can then be barred from design access or other sensitive areas of the system but they themselves never have to log in with a password. Equally this feature can speed up access to the design/network for the designer too, which could be especially useful when setting up larger systems.

If there are problems during the auto-online process, such as devices not present, mis-named, or not responding, incorrect comms settings etc., the auto-online process will stop but the file will be opened. If the 'Ignore missing devices' option is selected, then only those devices that can be found on the network will be loaded and the auto online process will continue.

The 'Command to execute on failure' option allows Designer to browse for a file such as an executable (.exe), text file or script that will be run in this instance. This could, for example, be used to run a script that would send an email to a system administrator to inform of the failure.

The 'Remove cancel option' omits the 'cancel' button that is normally displayed when going online, thus preventing an unauthorised user from breaking into the design file by cancelling the process before it has finished.

## Dynamic Metering

It is now possible to visually monitor the existence of a signal through the dsp layout on the PC screen using a flying meter probe.

This is enabled in a device's configuration window by ticking the 'Dynamic Metering' box located under the 'Configuration:' popup box in the top left of the window.

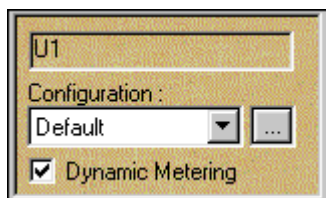

Once activated, pointing the mouse at a connected wire will register an led bargraph style display of signal level present through that connection.

This facility only works when the PC is online to the network of devices and will take the system offline if it is deselected. As with all metering objects there will be a slight DSP overhead which should be taken into account if this feature is to be used in a configuration that uses nearly all of a device's resources.







This activates the Preset, making it the current set of data.

The two security level combo boxes allow you to restrict a user to being able to use or edit certain Presets. See '**Security**' for more details.



## Excluding Devices from a Preset

- Press the **Devices...** button to open a dialog which will allow you to 'un-check' the devices you wish to exclude from the Preset.



Two particular control surface objects are not found in any of the standard control panels, but can be useful; these are Preset buttons and combo boxes. These are especially useful in systems where a PC is left permanently connected to the system for control purposes.

## Preset Button

A Preset Button is a pushbutton that activates a Preset when pressed. Use this for a fast method to select a particular Preset.

To create a Preset Button:

- 1 Select **Add>Preset Button**, also in the right-click menu or press the  button in the toolbar.
- 2 Click on the place in the map window where you want the button to be placed.
- 3 Right-click on the button and select **Properties**.
- 4 Click on the **Preset** tab, and then select the desired Preset from the combo box.

To associate the *current* layout of map windows with a Preset Button, right-click on the button and select **Capture**.

In **Operate** mode, pressing the button will activate the appropriate Preset.

## Preset Combo Box

A Preset Combo Box activates a Preset when it is selected from a list in the combo. Use this for a fast method to select from a list of Presets. A combo may be used to allow a selection of Presets to be triggered from a control port.

To create a Preset Combo:

- 1 From a map window, select **Add>New Preset Combo**, also in the right-click menu.
- 2 Click on the map window where you want the combo to be placed.
- 3 Right-click on the combo and select **Properties**.
- 4 Click on the **Preset** tab.
- 5 Select **Add** and choose the desired Presets from the list by highlighting and pressing **OK**.



You can change the order in which the Presets are listed either by highlighting the Preset name and pressing **Up** or **Down**. A Preset may be removed from the list by pressing **Delete**.

In **Operate** mode, selecting a Preset using the combo box will activate the appropriate Preset.

## 9. Compiling the Design

When your design is ready, press the **Compile** button in the Configuration window.

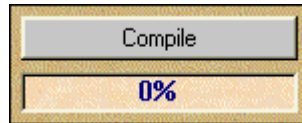

Soundweb Designer then computes the instructions that would be sent to the device to create the audio processing system you have just designed.

If all is well, you should see a message similar to this:

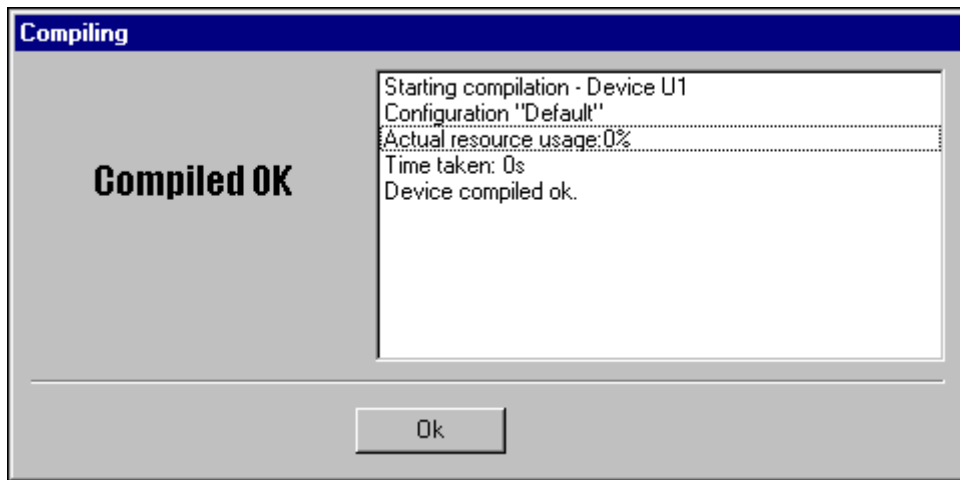

Now would be a good time to save your design!

### Resources

The complexity of the design that you can create is limited by the DSP resources in each hardware device. For example, the amount of memory, or the number of DSP processors and the power of each.

At the bottom left-hand side of the Configuration window is a 'resource' gauge, see above, which gives you a percentage reading of the resources which have been used up by your design so far.

This gauge updates automatically when you change the design, but may take several seconds to update after every change you make.

If the gauge shows less than 100%, the design is certain to fit once compiled. Its reading is only approximate and sometimes pessimistic. A reading of, say, 90% may not mean that you can only get 10% more into the design; it is possible that you may do better than this.

9000ii/9088ii note:

When you convert a 9000 or 9088 in your design to version ii, the resource gauge will refresh and display a lower value. This is because the new models have approximately 25% more dsp

Soundweb™



power than the old versions. Not all designs will show a 25% improvement though.

## Compiler problems

If you have run out of resources or if the compiler detects a problem with the design, you will see a dialogue or one of a number of possible error messages.

For an explanation of error messages and warnings, see [Compiler Error Messages](#).

If a processing object is named in an error:

- 1 Locate the processing object by using the **Locate** command (right-click menu) in the appropriate Configuration view.
- 2 Type in the name (excluding the device name – e.g. P3 not U1\P3) and the object in question should be highlighted.

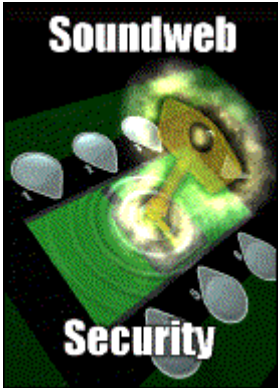

The design may need to be modified, usually by removing one or more of the processing objects. If all of these are critical, it may be necessary to add another device to your system and move some of the processing to the new device.

- 3 Press **OK** to disregard the error and continue with compilation, or press **Cancel** to abort the compile.

### Compensation Delays

Designs which show more than 100% on the gauge could still compile successfully if, when compiling you decide to omit 'compensation delays'.

These are normally included to equalise the processing delays (which may be up to 100 microseconds) so that all signals have the proper phase relationship. These are incurred as signals pass through the various paths and between the outputs of the hardware device. You may decide that this is not critical in your design.

# Soundweb™

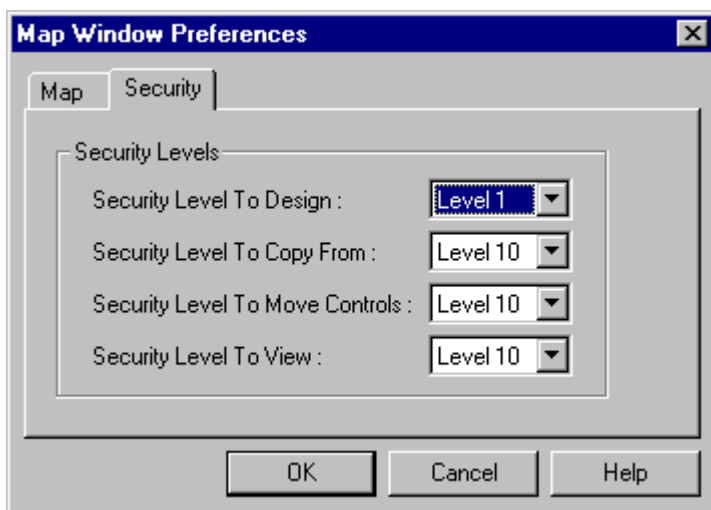

### 'Log in as a different user'

In a security enabled design file it is now possible to log out, then relogin as a different user, without having to close and re-open the design file, as was previously required. In this way, a designer can now quickly switch between different operator set-ups, whilst being able to easily return to the main *design enabled* version of the file to make additions and changes. At least two users need to have been configured in the 'Security' section of the 'System Design File' preferences in order to take advantage of this system.

To change user:

- Select 'Log in under different name' from the File menu (or use the CTRL+L keyboard shortcut).

Designer will probably ask whether you want to save the file, and state that any changes made up to this point will still be retained, even after logging in as a different user. This save option can be disabled (to prevent users changing the design file inadvertently) in the 'General' tab of the 'Application' preferences.

To login again:

- Select the user name from the popup box.
- Type in the correct password.

Clicking cancel on the log-in dialogue will close the file.

The design will now reopen based on the accesses permitted for the new user that has just logged in. A different map window, as specified in the new user's security set-up, may be displayed instead of the one that was being displayed before logging out. Note: If no default map window is specified, 'map window 1' will be displayed. Also access to other map windows and control panels may be disallowed and, design mode may not be available until logging back in at a higher security level, i.e. Admin.

It is possible to specify a particular map window that will be the only one that a user can see by using full screen mode and the auto online facility. Also, access to all shortcut keys and menus (apart from CTRL+L) can be restricted. In this way, an administrator can log in to edit the file, change privileges etc. by using the CTRL+L shortcut.

## 10. Working 'online'

---

Most of your time with Soundweb Designer will probably be spent 'offline' - on a standalone PC that is not connected to any actual Soundweb hardware.

When the design is finished connect the PC to the network of Soundweb devices in order to load the system and to use the control panels for 'live' adjustments. The system design is *compiled* into a code version to be loaded into the Soundweb hardware devices. If you haven't already done this then please refer to the section 'Compiling the Design'

### Loading a system overview

- 1 Connect the Soundweb devices with the appropriate network cabling and plug in your source and destination audio equipment.
  - 2 Plug a PC into the front panel RS-232 port of any one of the devices on the network.
  - 3 Check that the list of devices on the network agrees with the list in your design file, and resolve any differences.
  - 4 Load the design into the devices.
  - 5 Make any final adjustments to the parameter settings, and save them in an updated system design file.
- When you are 'online' to the network adjustments performed in Control Panels are transmitted immediately to the devices.
  - When the PC is disconnected from the network, the adjustments are stored in the system design file, and will be transmitted to the devices when you next go 'online'.

### Connecting the PC

First, you must ensure that the Soundweb devices have been installed in their equipment racks, and that the connections between them have been made in agreement with your system design.

Now plug your PC into the front panel RS-232 port of *any* of the devices on the network, it doesn't matter which one as long as the devices are connected together your PC will be able to communicate with all devices on the network.

**SOUNDWEB**<sup>TM</sup>





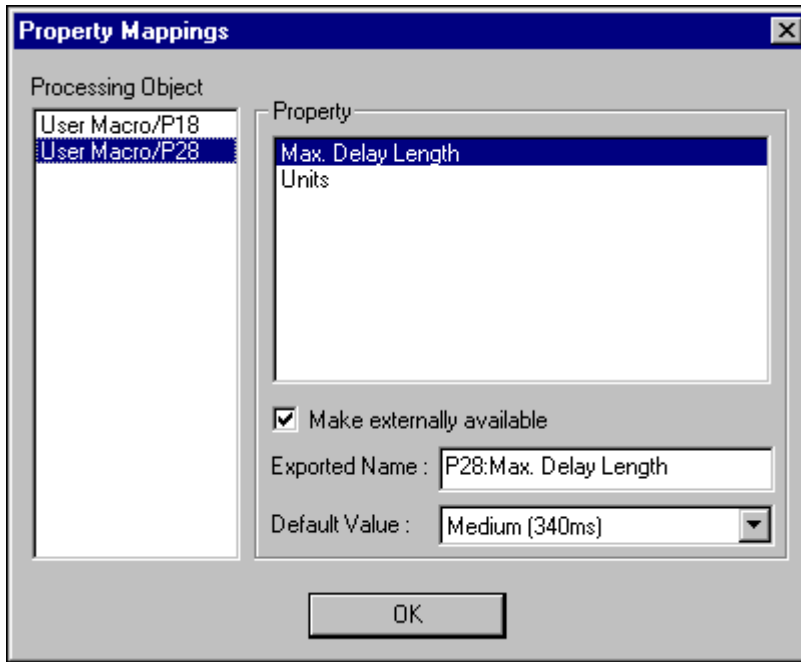

**Comms settings**

Ensure that Soundweb Designer is configured for the correct serial port on your PC. The serial port and speed can be selected in the Soundweb Preferences dialog (**View>Preferences>Application>Comms**).

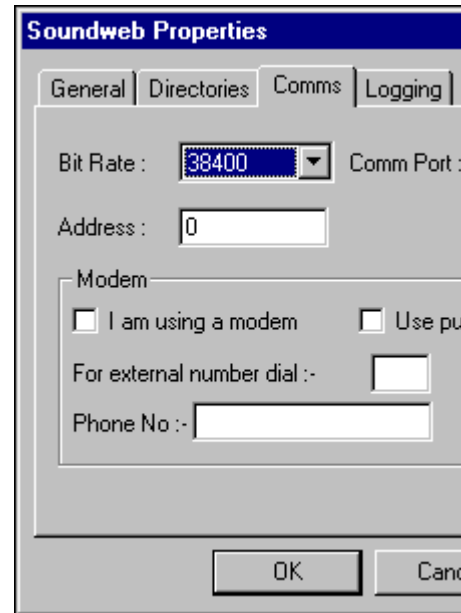

**'Bit Rate'**

Selects the serial bit rate.

This should be 38400 if the PC is connected to the front port or 115200 if connected to the rear. Note that AMX panels connect to the rear port at 38400.

**'Comm Port'**

Selects the serial port to which your Soundweb network is connected.

For PC's with old-style **serial** mice and only two serial ports, this will usually be **COM2**.

For PC's with **PS/2** mice (round connectors) and one serial port this will be **COM1**.

**'Address'**

Specifies a unique PC id.

If more than one PC is connected to the network then they should all have unique addresses.



The **'Modem'** area of this dialog enables the Designer software to remotely access and control a Soundweb network by 'dialling in' using a conventional modem. See Working Online (section 10) for more details.

### Using the rear RS232 Port

To use the rear port for going online from the PC you should:

- 1 Use a normal NULL modem cable (5 wire) to connect the PC to the rear port of the device.
- 2 Set the bit rate speed of the PC to 115200 in the Comms preferences.
- 3 Ensure that the device is not using the rear port for AMX communications.

The 9088 and 9000 devices' rear RS232 port runs at 115200 baud instead of the 38400 baud used by the front port. This higher baud rate means that data can be sent and received much faster than the front port which results in quicker network operation i.e. going 'online', loading, control, firmware updating etc.

For large networks (20 devices or more), it is recommended that the rear port is used instead of the front port as it will provide more reliable operation.

### The Network window and going 'online'

- Select **View>Go To Network View**, or press the  shortcut icon at the bottom of the screen.

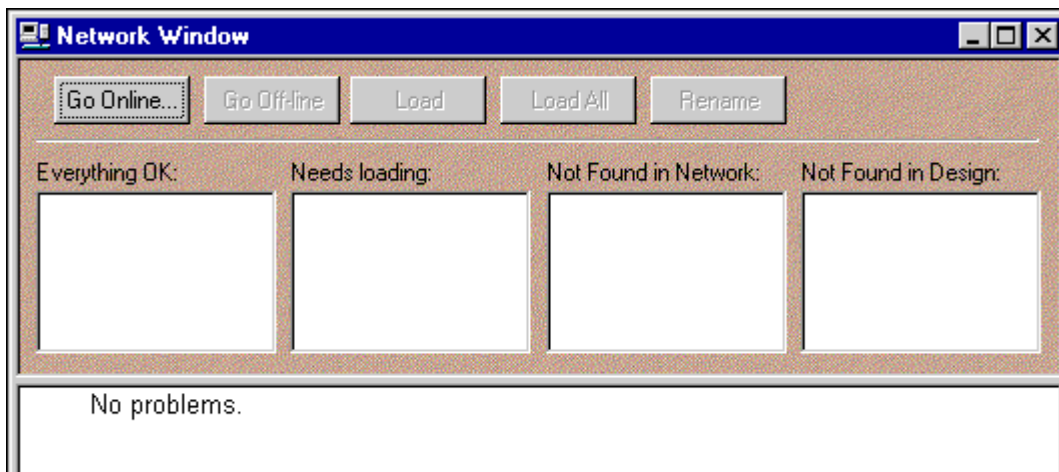

With your PC connected and the Soundweb devices all switched on.

- Press **Go Online**.

Soundweb Designer will now scan the network to find what devices are connected up, and checks the information that is loaded into them against what is in your design.

This process can take some time...

While it is in progress, there is a dialog box open allowing you to cancel the operation.

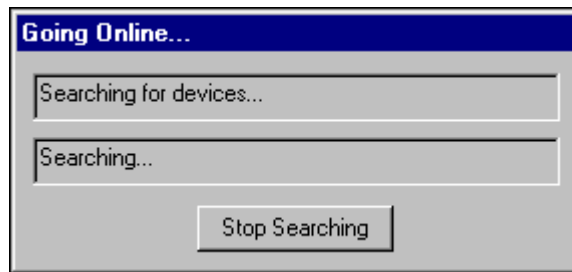

If your system design file contains devices whose Configurations have not been compiled, you will get a dialog box asking you to compile them now.

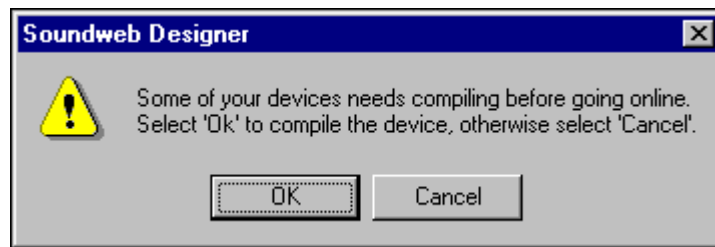

Note the compiler may need to make adjustments for differences in the hardware. This can cause a recompile when you go 'online' to a device.

The PC will examine the set-up in each device to see if anything has changed from last time that it was 'online'.

- If nothing has changed in the devices, the PC will go 'online' to them immediately.
- If the Configuration has changed, the device will need loading.
- If the Configuration has not changed but the parameter values are different (if for example a control was adjusted on the PC when 'offline'), a Parameter Synchronisation dialog box will offer a choice between sending the PC control settings to the device, or the device settings to the PC.

The devices are displayed in four lists:

- 1 **Everything OK:** The name, type and options in the system design file agree with the device on the network, and the Configuration and parameter values are correct.
- 2 **Needs Loading:** The name, type and options agree, but the Configuration is different.
- 3 **Not Found in Network:** Devices in the system design file are not existent on the network, either physically or by name or, have the wrong options fitted (e.g. wrong type of analogue input card).

#### 4 **Not Found in Design:** Devices that are on the network, but not in the system design file.

If the system has been installed according to your design, you would expect the latter three lists to be empty. If not, you will need to act:

For entries in the '**Needs Loading**' list. You will probably need to reload the device from your system design file using **Load**.

WARNING - loading a device will overwrite its entire set of information about Configurations, audio settings, control ports, etc. **There is no Undo!**

Before loading a device, you need to be very sure that either:

- a You do not require the Configuration settings currently in it or,
- b You have the system design file which was used to load it originally.

For entries in the '**Not found in Network**' list, you will need to do one of four things:

- 1 Install and/or connect and/or switch on a missing device.
- 2 Delete a device from your design file
- 3 Change the options for the device in the design file to match the actual device, or fit the correct option in the device. (Double-clicking the device name in this column will open the properties dialog for the device)
- 4 Rename a device, either on the network, or in the system design file, so that the two devices match. This is done by selecting the list item and hitting the **Rename** button.

For entries in the '**Not Found in Design**' list, you may wish to add the extra device to your design file, or you may simply ignore it completely.

If you have a large system and you are not sure which device is not in the design, click on its name in the fourth column. This will cause it to flash its front panel indicator LED's on and off a few times.

Once you are satisfied that the devices on the network are in order, download your design into the network by pressing **Load All** devices.

Alternatively, you can load the part of your design that relates to a single device by selecting it in the list of devices on the network and in your design, and pressing **Load**.

### Going 'off-line'

If you are working 'online', any parameter changes you make will normally be transmitted immediately to the network as well as being updated in your design. To make changes without affecting the audio, the PC must be taken 'off-line' - either by pressing **Go off-line** or by simply unplugging the serial cable.

# Soundweb™



## Using more than one PC on the network at once

It is possible for a Soundweb network to have more than one PC connected simultaneously. This is very useful if control is required in more than one location at once.

All the PCs on the network must have a unique address. This address is simply a number between 0 and 255 and is set in the **View>Preferences>Application>Comms** dialog.

For example, in a network with two PCs online, you could set the address of the first PC to 0 and the second PC to 1.

You must ensure that no two PCs have the same address, and that they are all using the same Soundweb Designer file.

Once online, the PCs will operate as normal, but will report a change to the network when one of the other PCs is taken offline.

## Remote access using a modem

It is possible to access a Soundweb system/network of devices using a standard Hayes compatible modem (e.g. US Robotics).

The desktop computer or laptop used to remotely control the system must have a copy of the correct System Design File and a working modem connection. If it is possible to get on the internet with the PC then it should work for Soundweb.

The connection sequence is as follows:

- 1 Load the relevant SDF onto the local computer, and load it into the device/network in the normal on-line way.
- 2 Plug a modem into the rear serial port of one of the Soundweb devices in the network.
- 3 Connect its phone wire to a working telephone point. This can be tested by plugging a standard telephone into the point and checking to see if a dial tone exists.
- 4 Make sure that the modem is powered up.
- 5 Reboot the Soundweb device that has been connected to the modem by switching the power off and then on – this allows the device to sense the modem. Activity lights should flash on the modem indicating that the device has made a connection.

At this point it may be useful to check the installation by reloading the SDF into the device/network, although this should not be necessary.

You can now remove the computer from the network, or leave it connected locally.

To remote control the network:

On the PC intended for remote control, first ensure the copy of the SDF is loaded, then go to the



Comms preferences in Soundweb Designer (**View>Preferences>Application>Comms**) and select the following options:

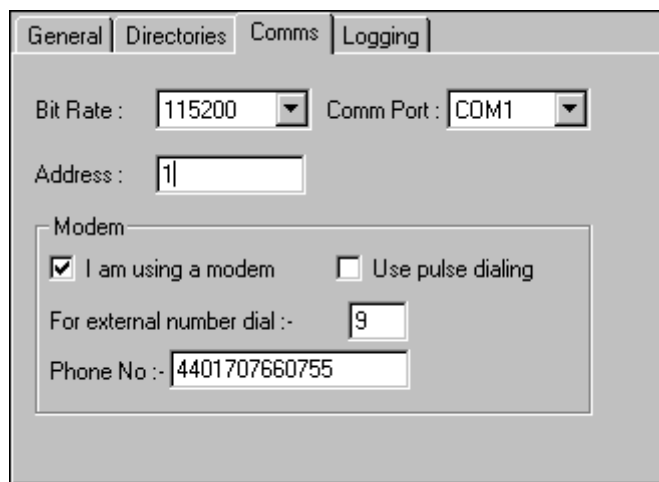

- 1 Tick the '**I am using a modem**' box.
- 2 Select the correct '**Comm Port**' that the PC is using for the modem connection.
- 3 The '**Address**' should be fine as '0' unless there are other PCs connected to the network you are trying to access. In which case assign a unique number to this connection.
- 4 The '**Bit Rate**' should be set at '115200' but in cases of bad connections or continuously dropped lines experiment with reducing this figure.
- 5 Only '**Use pulse dialing**' if you are connected to an old-fashioned telephone exchange still using this protocol.
- 6 '**For external number dial:-**'. If there is a number required to access an outside line, e.g. '9', input it here.
- 7 Type in the phone number, including std area code, of the modem connected to the Soundweb system.
- 8 Open the Network window and press '**Go Online**'.

The computer should now dial up a connection to the remote modem and once the handshaking process has finished access to the Soundweb system should be available as if the PC was connected directly to the serial port.

Network messages similar to going on-line locally may be received, such as 'Different Device Data, synchronise?' which means that Soundweb Designer has found different settings existent on the network of devices it is accessing. Press OK to update the SDF to reflect the actual settings of the device.

# Soundweb™



## Online Notes

Configuration windows are read only when the system is online. A safety feature to prevent accidental offlining whilst observing a configuration layout. Existing objects cannot be changed although it is possible to add new objects and this action will still force the system offline.

If the PC is to be left 'online' for extended periods of time, you need to be careful about 'sleep' or 'low power' modes, especially on laptop computers. Ensure that the comms port is not disabled when the PC automatically enters a low power mode.

Note that the device has software resident in a flash EPROM. This software is distinct from the Soundweb Designer software, and either may undergo revisions that can lead to compatibility conflicts. When going 'online', the system checks for compatibility and may advise the user to take steps to update the software in a device. Instructions for this process are available in the '**Firmware Updates**' section.

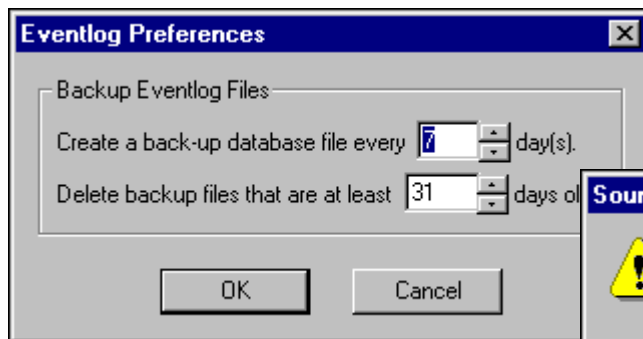

If Soundweb Designer fails to find the devices on the network...



Try the following:

- Check that the *Comms* set-up is correct. (Remember, the front port of the devices runs at 38400 baud, and the rear port runs at 115200 baud.)
- Make sure that the PC has a different *address* to the other PC's on the network.

## 11. Kit List

Soundweb Designer can print out a 'Kit List' to add to a tender document, or as a system overview document to be given to the contractor who will install the system.

The Kit List displays information about the system hardware, i.e. Soundweb devices in the system (including their names), the options that should be installed in them and the network connections that should be made between them.

Comments pertinent to the installation of a particular device can be added. For example, to inform the installer to beware of overheating device U4 (if placing it directly over an amplifier in the rack), and a reminder to install the 9010 remote in a 3-gang wall socket near the lobby of the building.

To add a comment to a device:

- 1 Select **Properties** from its right-click menu.
- 2 Click on the **Device** tab.
- 3 Type comments into the box provided. To put in a line break use **CTRL+Enter**.

To preview the Kit List.

- 4 Select **View>Go To Kit List**, or press the  shortcut icon at the bottom of the screen.

The Kit List for this example would look like this:

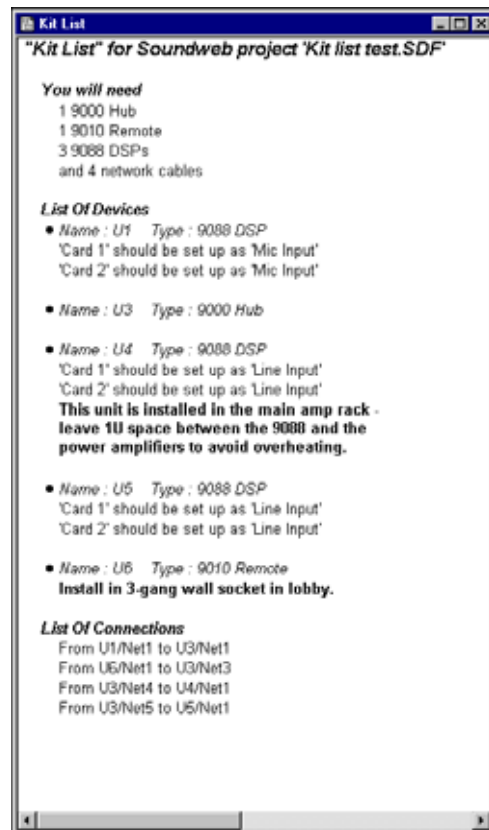

# Soundweb™





For each device in the system that has options, the Kit List will indicate which options should be fitted.

Remember to set up the device options for the type of input cards to be used in the 9088s. In this example, U1 has mic level cards in both positions, and the other 9088s use line level cards.

It is useful to rename some of the units from the default U1, U2 etc. generated by Soundweb Designer. Good practice is to use names to describe the *function* of the devices in the system, or their positions in the equipment racks.

To change the name of a device:

- 1 Select **Properties** from its right-click menu.
- 2 Change the name field in the **Device** tab.

Rather than printing the Kit List, you can copy the text into your favourite word processor.

- 3 With the Kit List view open select **Edit>Copy** to copy the text onto the Windows Clipboard.

Now it can be pasted into your application. Note that the text will be pasted as plain text; you will need to add your own formatting.

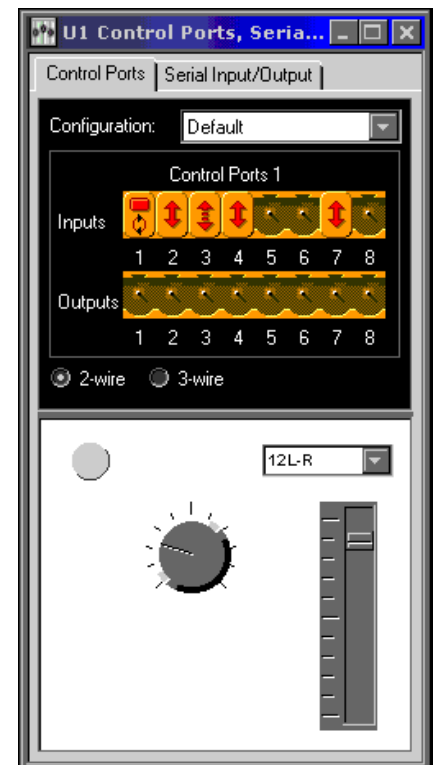

## 12. Security

---

### Securing the system from unauthorised access

Security is handled by a system of **'users'** and **'levels'**.

All security settings are stored in the system design file - they relate to a particular system design, not to the installation of the software on your PC.

The principle is this:

Define users by giving them a

- √ Name
- √ Password
- √ Security level (defined as a number between one and ten).

You can protect various aspects of your system by defining the minimum security level required to operate them.

The system starts with one user called **'Admin'**, whose initial password is also **'Admin'** and whose security level is **'1'**. Level **'1'** is the highest level and gives you access to everything.

Items that can be secured include Presets, map windows, and Configuration settings.

The most useful of these is map window security.

A user, below a particular security level, can be forbidden from opening a map window at all. In addition the user may be allowed to open it; open it and copy controls from it; to change settings; or to change the design of the window.

Security settings are accessed through **View>Preferences>System design file>Security** or **View>Preferences>Map** and there are further security settings available in the **Preset View**.

**!** Keep track of your passwords and/or keep an *unsecured* backup copy of your system design file should you need to return to a site that has security set up but access is not forthcoming...

For a more in depth overview of security issues please refer to the 'How to set up a secure system' tutorial.

Soundweb™

## 13. Auto Online/Full Screen

### Auto-Online

Enables a specified design file to be loaded to a network when Designer is launched. The chosen file will be opened, the PC will go “online” to the devices, and the design file will be loaded.

Auto online is activated from **View>Preferences>Application>On Startup**

Control Parameters can be synchronised either to reflect the settings stored in the devices on the network or, to update the network with the parameters values stored in the design file. The design file can be forced to open in full screen mode and the keyboard shortcuts for full screen options can be disabled.

The auto login feature allows a chosen user (with associated security clearance) to be automatically logged in, with password also. This allows the designer to set up a system with a PC connected, which on running the design file boots straight in to a preconfigured control panel. Operators can then be barred from design access or other sensitive areas of the system but they themselves never have to log in with a password. Equally, this feature can speed up access to the design/network for the designer too, which could be especially useful when setting up larger systems.

If there are problems during the auto-online process, such as devices not present, mis-named, or not responding, incorrect comms settings etc., the auto-online process will stop but the file will be opened. If the “**Ignore missing devices**” option is selected, then only those devices that can be found on the network will be loaded and the auto online process will continue.

The “**Command to execute on failure**” option allows Designer to browse for a file such as an executable (\*.exe), text file or script that will be run in this instance. This, for example, could be used to run a script that would send an e-mail to a system administrator to inform of failure.

The “**Remove cancel**” option omits the “**cancel**” button that is normally displayed when going online, thus preventing the user from breaking into the design file by cancelling the process before it have finished.

### Full Screen Mode

Selecting “Full Screen Mode” enlarges the currently active map window to fill the screen completely. This allows the design of larger control panels, and the menus and tool bars can be hidden from view (and therefore tampering made impossible). Using this feature, a pc controlled system can be made more aesthetically intrinsic to the task that it is set up for.

This option can be accessed at any time using the following keyboard shortcut “**Ctrl+Alt+F**”. Alternatively this can be setup as part of an Auto online system in **View>Preferences>Application>On Startup**.



## 14. Macros

A Macro is a *template* for a collection of audio processing objects and their interconnections, together with a suitable control panel for operating the collection. Use a Macro to define a frequently used set of DSP functions; the Macro then appears in the list of available processing objects.

If you are a consultant, you can use Macros to hide details of your design from the end-user, in order to disallow access and/or to protect your intellectual property.

To select the page for configuring Macros.

- Use **View>Go to Macro Creation view**, or press the  shortcut icon at the bottom of the screen.

The right hand half of the Macro creation view is a map window that will define the control panel for the Macro.

Configuring a Macro is just like designing a Configuration, except that you have to add your own input and output flags.

Note that whilst all Macros created in the current design will be saved in the same Macro file, all Macro files present in the macro subdirectory (set in **View>Preferences>Application>Directories**) will be made available to all subsequent designs. It is our advice not to use the same design file used for creating Macros for a serious design project as there are issues regarding linked objects within the same file. It is far better to use a separate file to create the Macros and then backup this file in case the Macro needs to be edited later.

You may wish to create a different Macro file for each project, or use one central Macro file common to all projects.

Note that the design details of the Macro are only available to the design file in which it was originally created. Therefore, if you need to subsequently edit the Macro, this can only be done in the original project.

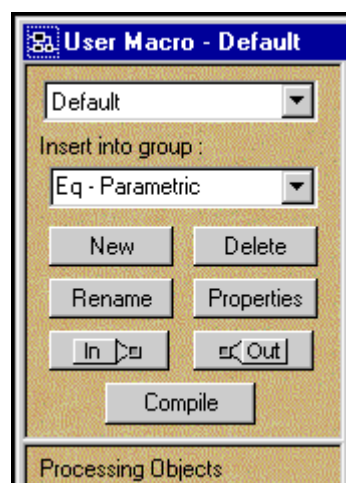

# Soundweb™

## Create a Macro

The procedure for creating a new Macro is as follows:

- Name**  
Click **New**, then in the dialog box, type in the name for your new processing object, and click **OK**.
- Insert into group**  
Select from the list of processing object categories to determine where the new Macro is placed. Alternatively, you can leave '<NONE>' selected to make the Macro appear in the top-level of the list, or you can enter your own name to create a new group category.
- Inputs and Outputs**  
Add inputs and outputs for the object by pressing the **In** or **Out** button as appropriate, Type a name for the port (e.g. 'Sidechain In' or 'Audio Out' etc.) in the dialog box. Click on the Macro configuration window (the left-hand window) to place the tag. Note that inputs and outputs will appear on the final object processing box in the same order that they are defined in the Macro.  
  
Ticking the 'Create Multiple Ports' option and selecting the number of ports required in the Input or Output configuration dialogues can now create multiple ports. The ports all take on the name typed in here and are differentiated by numbers added to the name.
- Processing Objects**  
Now add your processing objects and wire them together, just as you would in a normal Configuration. Wire the input tag to the input of your processing block and the output of the block to the output tag.
- Control Panel**  
Open the control panels for your processing objects and adjust the default settings of the controls that you do *not* wish the user to have access. Now decide what controls you wish the user to have. Drag these controls (in **Design** mode) to the right-hand part of the Macro window, arranging them, and adding text etc. exactly as you want the user to see the control panel.  
  
Note that controls whose action is determined by selection in a complex graphical control (such as the frequency control in a Parametric Equaliser) may not be used without the associated control panel itself.  
  
The background colour for the panel is selected using **Map>Preferences** in the usual way.
- Properties**  
Set up the option properties for the Macro by clicking the **Properties** button.



Select each processing object in turn by clicking on its name in the 'Processing Object' column.

Set the default value you would like the property to have by selecting it in the 'Default Value' combo box.

If you want this property to be available to the user to adjust: Click in the 'Make externally available' checkbox.

Enter the name you want to assign to this property in the 'Exported Name' textbox.

Click **OK** when you have completed this for all processing objects.

- **Compile**

Now click the **Compile** button to compile all the Macros you have created into a file which will subsequently be made available not only to the current design, but all other designs. The name of the file may be changed from the default name if you wish.

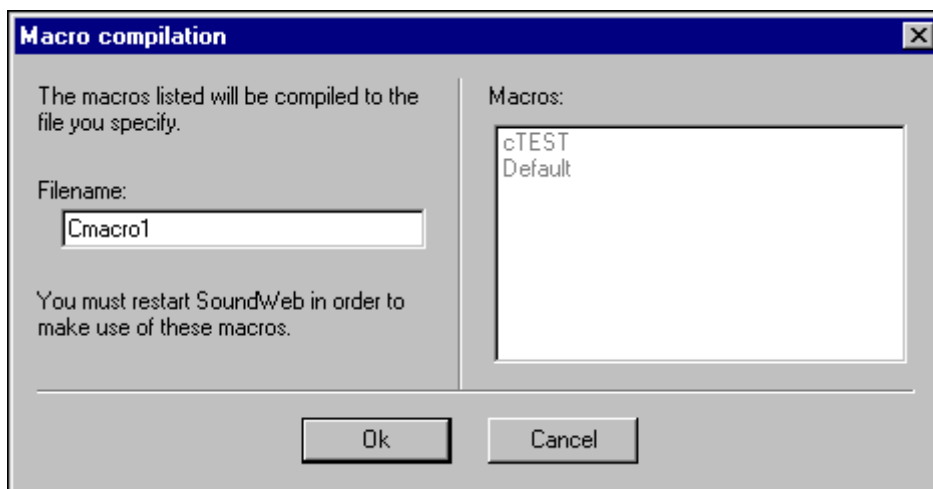

The newly created Macro will not be available until you next restart Soundweb Designer, when it will appear in the normal list of Processing Objects.

## 15. Event Log

# Soundweb™

Event logging provides a means of monitoring the operation of a Soundweb network to solve problems, find ways of making the system more efficient or just to give a picture of how the network is being used.

Each device stores events as they happen and, when 'online' to Soundweb Designer, 'logs' of these events are collected and entered into a database. These can then be viewed with the Event Log client from either within Designer, or as a separate program.

Event logging is enabled from **View>Preferences>Application>Logging**.

This dialog is used to configure general options for Event Logging.

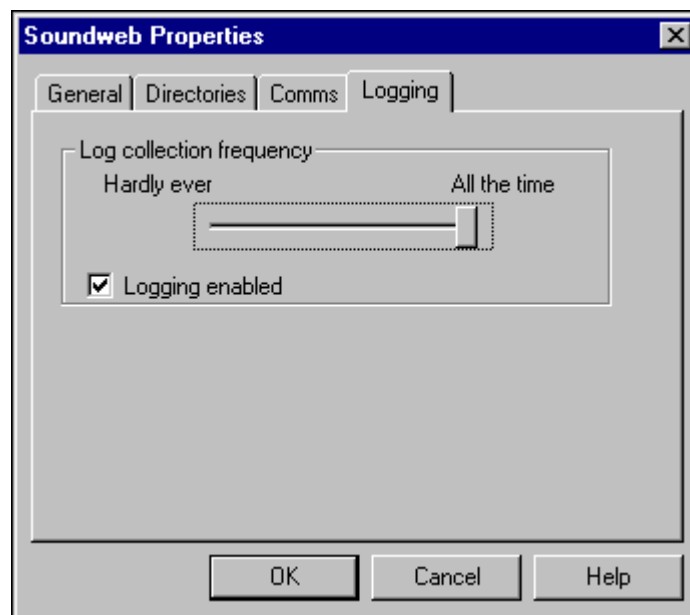

### 'Log collection frequency'

Determines how often Designer requests logs from devices. Lower settings (i.e. toward *Hardly ever*) will lead to larger logs (and in extreme cases may lead to some lost events) so the frequency should be kept *high* unless the resultant performance reduction is a problem.

**'Logging enabled'**

Enables or disables the collection of logs. Disabling logging stops the collection of logs from the current instance of Soundweb. This should be used when more than one PC is online to a network to prevent logs being divided between them.

Note: Disabling logging will not stop devices from logging data, only the PC from collecting the data.

# Soundweb™



## Filtering Events

Soundweb units have a finite space for storing events - when a device runs out of space, earlier events will be removed from the log and lost.

Filters can be defined to allow storage of only those events that are of interest and thus reduce the likelihood of events being lost.

Filtering events allows you to specify events which will be logged either on a per-device or system wide basis.

To specify for a single device, select **Properties** from a device's right-click menu and go to the **Eventlog Filters** tab.

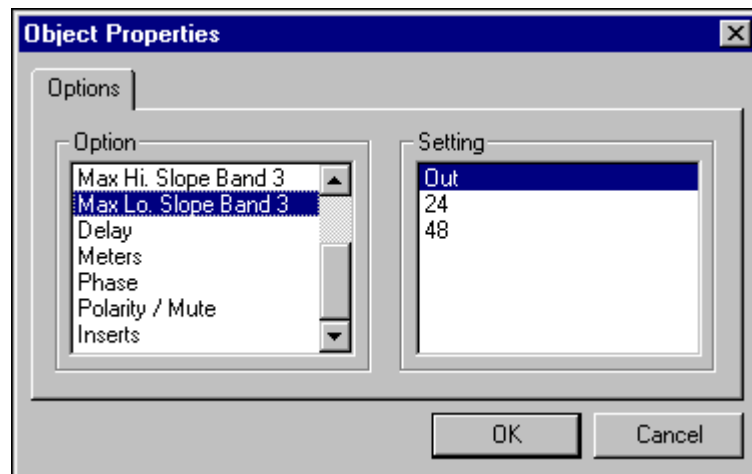

Events are organised into classes of *related* events so, by selecting a class in the left-hand list you will see the events in that class detailed in the right hand list.

- A checked box means that the specified event will be logged.
- By default, no events are logged.

Groups of events in the right hand box can be enabled or disabled by using the **Shift** and **Ctrl** keys for multiple selections.

To filter events for all devices simultaneously.

- Go to **View>Preferences>System Design File** and select the **Eventlog Filters** tab.

The interface is almost identical to the one above, except that where devices have different settings for an event the cross in the check box will be greyed. (If left greyed then the settings for that event will remain the same when **OK** is clicked).

## Event Log window

Used to both display and manipulate the events within the event log database.

- To display this window either select the **View>Go to Event Log** menu item, or press the  Event Log shortcut button at the bottom of the screen.

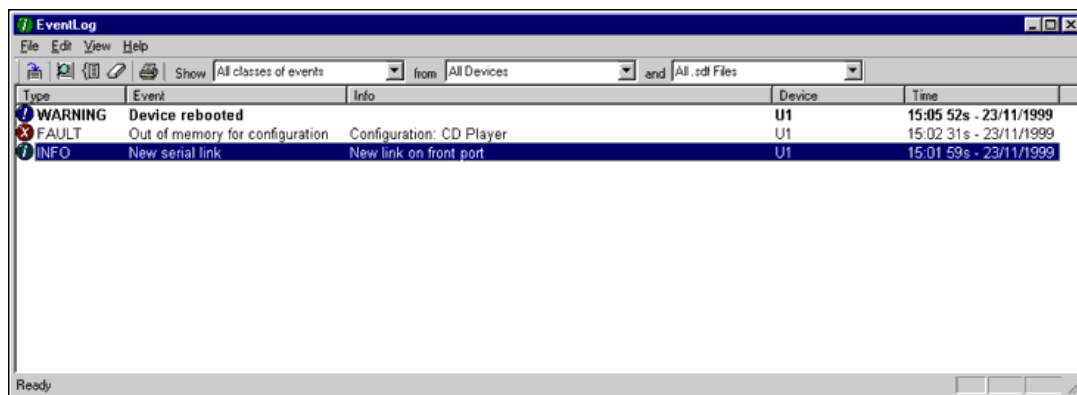

The main section of this window is the *event list*, which displays various information about each event.

There are 5 columns within which event information is organised:

- Type** – states the general nature of the event (e.g. Fault, Warning, Info etc.).
- Event** – every possible event that can be generated by Soundweb devices has a unique name.
- Info** – extra information about the event.
- Device** – the name of the device that reported the event.
- Time** – the recorded time at which the event took place.

Initially, events are ordered by time – with the most recent event at the top of the list. Clicking on a column heading will order the events in the event list according to the information within that column. Clicking twice on a column will reverse the order.

When Soundweb Designer receives new events, the **Update** toolbar button  is highlighted. The newly received events can then be added to the event list by clicking on it. (Also from the **View>Update List** menu item.)

Events that have just been updated will appear in **bold**, while events that were present before the update will appear as normal text.

# Soundweb™



**Soundweb™**



## Selecting Events

Events within the list can be selected by clicking on them. Multiple selections can also be made in conjunction with the **Shift** and **Ctrl** keys. To select all the events currently displayed in the list:

- Use the **Edit>Select All** menu command or click the  **Select All** toolbar button.

## Event details

To display extended details about an event - including a brief explanation of the event's meaning and a help section describing any actions the user can or should take upon seeing this particular type of event.

- Double-click on an event, use the **View>View Details...** menu item or  Details toolbar icon.

A *Notes* edit box has been provided at the bottom of the dialog. Text can be typed here by the user as comments that will then be added to the Event Log database.

## Deleting Events

Selected events can be deleted from the event list using the  **Delete** toolbar button, or **Edit>Delete** menu item. However, deleted items are not removed from the database, and can actually be displayed in the list by selecting **View>View All Events** – with deleted items displayed in grey text. Selecting the **View>View Undeleted events only** menu item will stop deleted events being displayed.

It is possible to permanently remove all deleted events within the event log database. This is achieved with **Edit>Clear Out Deleted Events**.

! It is advisable to only do this when the amount of event log information in the database becomes unmanageable. Otherwise, potentially helpful event information could be lost if deleted events are cleared too often.

## Display Filters

Next to the toolbar are three combo boxes.



These are the display filters and are used to limit which events are displayed within the event list.

Events can be filtered by:

- **Class.**
- **Device** that reported them.
- The **.sdf** file with which they are associated.

By default, these filters are set to display all types of event.

To filter the event list, open one of the three dialog boxes and choose an item from the drop down list:

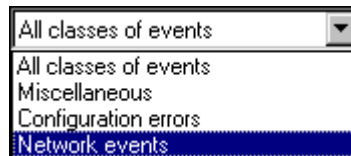

Once selected, only events that adheres to that filter setting will be displayed.

All three filters can be used in combination with each other - i.e. with all filters activated, only events of a particular class, from a particular device and from a particular .sdf file will be displayed.

## Opening other Event Log databases

During normal operation, the event log will use the default event log database, which is specified when Soundweb Designer is first installed. However, it is possible to temporarily open a different event log database.

To do this:

- Select **File>Open Database....**

A new database file will need to be specified.

(Event log information is contained within Microsoft Database files - .mdb files).

Once the event log program or Soundweb Designer itself is restarted, the event log application will return to using the default database file.

To change this default database path:

- Select **File>Set Default Database Path...**

Please Note: During normal operation, it should not be necessary to alter the database file the event log uses. These options have been added just for extra flexibility.

## Exporting the Event Log

The event log provides an *Export* function that converts the event information currently displayed in the event list into a text file.

To export the information:

- Use the **File>Export...** menu item.

## Event Log auto backup

In an extensive system of Soundweb devices where a large amount of events are being generated and stored in the log there has been problems with the size of the log file becoming too large. To prevent this a backup system has been added.

This dialogue enabled from the **Edit>Preferences** menu in the Event Log application allows the backup options to be changed.

The default settings, as shown, create a backup of the Event Log every seven days then delete those backups when they become a month old. This way there will never be more than about 4 backups stored on the host computer and the information can never be older than a month.

On starting Soundweb Designer this window may occasionally appear to inform the user that a backup has been created. The file name contains the date of backup.

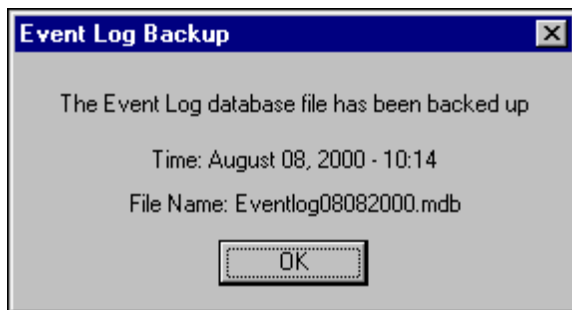

Even if you are not running a large system of Soundweb devices, this process will continue automatically. It should be considered that by default, the event log does not receive any events from a Soundweb system; the collection of events has to be enabled and the desired events have to be chosen using the filters. Therefore, the contents of the database may be minimal if the Event Log is not configured to collect large amounts of information.

# Soundweb™

## 16. External control options

Even when the PC is disconnected from the Soundweb system, it is still possible to adjust audio settings and activate Presets using:

- Switches and knobs hard wired to the control inputs.
- The Soundweb 9010 network remote control panel.
- Proprietary control systems such as AMX, Avenger, Crestron or Dataton.

### Control Inputs and Logic Outputs

A Soundweb system can be controlled and monitored without an 'online' PC using devices connected to the 'control inputs' and 'logic outputs'.

A switch or potentiometer, e.g. 9012 selector wall plate (Part no. Z-SW9012), connected to a control input can do anything that could be done with a switch, fader or rotary knob on a control panel in the Designer Software.

A Soundweb 9088 has a set of 8 control inputs, 8 logic outputs and an opto circuit. These are pins as part of a 24 way connector at the rear of the unit (the other pins are common/ground or reference depending on the device).

The control inputs connectors on the back of a 9088 or 9000 unit have four common (ground) connections (C), two either side of the eight Control Inputs.

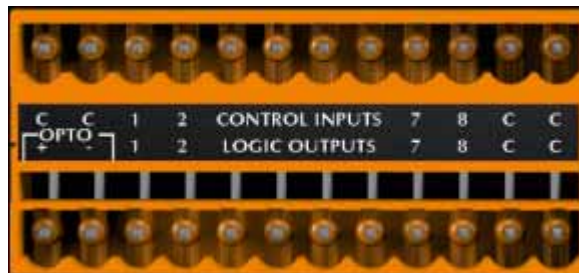

### 9088ii note

A 9088ii has two common (C) connections to the left of the Control Inputs and two software assignable reference voltage outputs (R) to the right.

The control inputs of the 9088ii also have two modes of operation. In Soundweb Designer's Control Ports window these are labelled '2-wire' and '3-wire'.

### 2-wire mode

This mode is the standard that the original 9088 and 9000 series work to, 3 wire mode being particular to the 9088ii.

In this mode the eight Control Inputs are internally 'pulled up' to +5V DC via a 4.7kOhm resistor. Therefore, no external voltage source is needed to create contact closure to ground (for switches such as mute buttons) or, resistance to ground (for other multi-state or continuous controls such as Parameter Presets or faders).

A 47kOhm-*log* potentiometer (Part no. DM10018) connected between a control input and common will allow parameters to be controlled linearly.

# Soundweb™



## 3-wire mode (9088ii only)

This mode allows the use of *linear* pots or faders for continuous controls. A pot would be wired as a *potential divider* with the top of the track connected to the reference output (**R**), the wiper to a control input and the bottom of the track to the common (**C**). For good performance pots with track resistance between 10K and 100K are recommended.

## Configuring Control Inputs in Designer

As an example, imagine connecting a momentary push-button switch to control input 1 of a Soundweb 9088, and a potentiometer to control input 2.

To use the potentiometer as the output gain of a mixer, and the push-button as a mute control:

- 1 Add a device object to a map window - to represent the unit that is to have controls wired to its ports.
- 2 Select **Control Ports** from the device object's right-click menu.
- 3 Double click the device object to access its Configuration window.
- 4 Add a mixer object to the Configuration window.
- 5 Double-click on the mixer to access its Control Panel.
- 6 Select **Design** mode.
- 7 Arrange the windows on the screen so that both the Configuration window and the Control ports window are visible.
- 8 Select and drag the mute button and the gain fader from the Configuration window to the lower (initially blank) portion of the Control ports window.
- 9 Now, drag the fader from the lower Control ports window and drop it onto the representation of *Input* pin number '2'.

You should see the following screen:

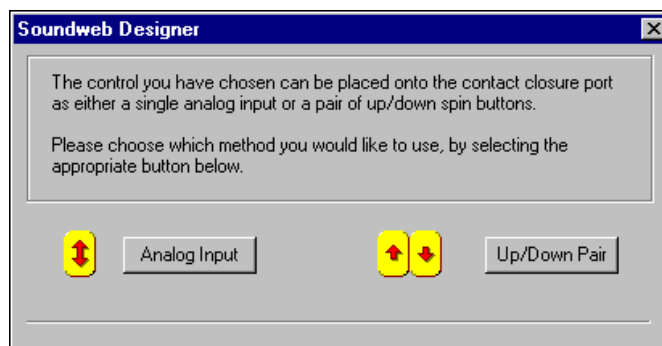

- Press '**Analogue input**'.

Also drag the push-button switch from the lower portion of the Control ports window and drop it onto the representation of *Input* pin number '1'. A dialog is displayed offering a choice of what type of action you require:

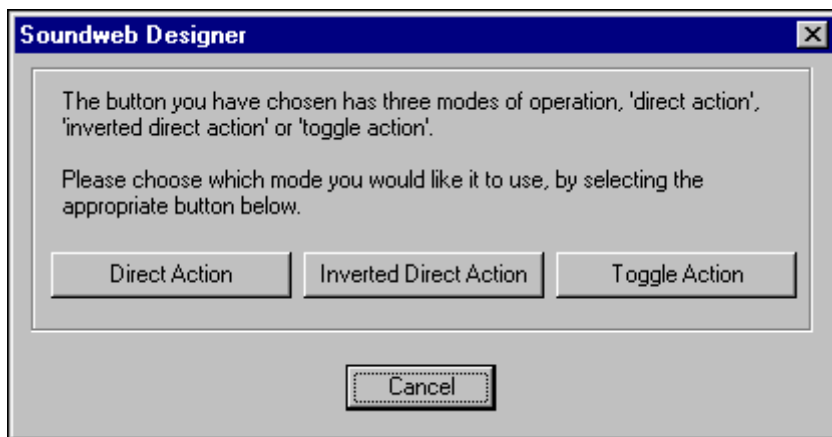

Direct, Inverted Direct or Toggle?

*Direct action* allows one value when a momentary switch is at rest, and another value when the switch is held pressed. This is useful for temporary muting, i.e. mute when pressed.

*Inverted Direct action* would reverse this state to become a press to talk/for signal – useful for paging systems.

Direct action could also be used for a multi-position rotary switch (with its 'wiper' connected to common) to select between a number of button functions (such as a group of Preset buttons).

*Toggle action* alternately switches a parameter on and off each time a momentary switch is pressed - for example activating/deactivating a bypass button.

- Choose **Toggle**.

Pressing the pushbutton should now operate the mute control of the mixer, and moving the potentiometer should operate the gain control fader.

Note that the mixer being controlled need not be in the same physical device as the control inputs being used for this. The Soundweb network connects all the devices together and allows a control input on any one device to be used with processing objects on any other.

In addition, instead of a potentiometer, you could use a pair of push button switches as *Up* and *Down* controls. This would require *two* control inputs to operate *one* fader.

Momentary switches connected to the control inputs can be used to control any item which can be operated by a pushbutton, i.e. Preset buttons and Parameter-Preset selection bars. A similar procedure is followed for these. Once a Preset button or Parameter-Preset bar has been created on a map window, drag it to the control port window, then drag it onto the appropriate input contact.

# Soundweb™



## Control Ports & Combo Boxes

When combo-boxes such as Preset combos or source selectors are dragged onto an input port, a dialog asks if you want the various states to be selected by a number of input pins ('Buttons'), or if you want a resistor ladder on a single input pin to be able to select from a number of states ('Analogue Input').

Preset combos additionally allow you to include a 'dead state' so that an open-circuit makes no selection. This allows you to connect a momentary push-switch in series with the wiper of a rotary switch, which is used to select the voltage from a resistor ladder; there is a table of resistor values at the end of this manual.

The push switch may then be used to activate the selection made by the rotary switch, which prevents *multiple* Preset selection when the rotary switch is turned.

## Control Ports & Configurations

The control port set-up can be assigned to a particular Configuration by selecting the appropriate Configuration from the Configuration combo box at the top of the window. This allows the control port to act in different ways in different Configurations.

For example, a potentiometer connected to control input 1 adjusting output level in 'Wedding' Configuration, but adjusting a limiter threshold in 'Conference' Configuration.

You could also activate a different Preset from the same control input in different Configurations so that one push button could be used to cycle through various Presets.

For the same control input to control a similar parameter in different Configurations, set the control port window up in a similar way for each Configuration.

## Logic Outputs

This works in a similar way to the control inputs. An LED control is the typical object that you would drag to a logic output. When dragging this object onto the control port, a dialog will ask if you want the action to be:

- 'Normal' (LED on causing a logic High, +5v)

or

- 'Inverted' (LED on causing a logic Low, 0v).

Note: To create an LED indicator for the states of an on-off switch use the Morph feature.

## Watchdog Output

The Soundweb 9088 also has an opto-isolated output that functions as a watchdog. The opto-isolator conducts when power is applied to the unit and the software is functioning correctly - it is cut off if there has been a power failure or a software crash. This function can be used to trigger alarm systems or to construct *redundant* systems. It is not configurable by Soundweb Designer.

# Soundweb™

## 17. 9010 'Jellyfish' Remote Control Panel

The 9010 is a wall-mounted panel for remote control of the Soundweb network. It may be configured to operate controls from any of the audio processing objects located in any 9088 or 9000 unit connected to it.

### Getting started with a Jellyfish

This section describes the various windows available and how to set up a 9010 remote unit to control the 9088 system. As the remote is of very little use on its own, it is assumed that the designer will already have a preconfigured 9088 system.

With a map window open.

- 1 Select **Add>Device** (or **New Device** from the right click menu).
- 2 Select **9010 Remote** and click on the map window.

A device with two analogue inputs, two analogue outputs, and Net in and Net out sockets should appear.

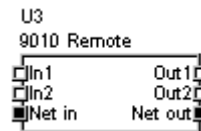

### 9010 - The Page Design window

- Select **Button Set-up** from the right-click menu of the device object.

This opens a design window for the screen display and controls of the 9010 remote.

The 'screen' of the remote is divided into sections by dotted lines. These show the boundaries of each button, and an area on the right for the rotary encoder. Each button section can be resized to allow different length names or parameters to be assigned.

For example, the middle buttons could be used for source select lists, with longer names and, the left and right buttons could be simple page navigation buttons such as next and last.

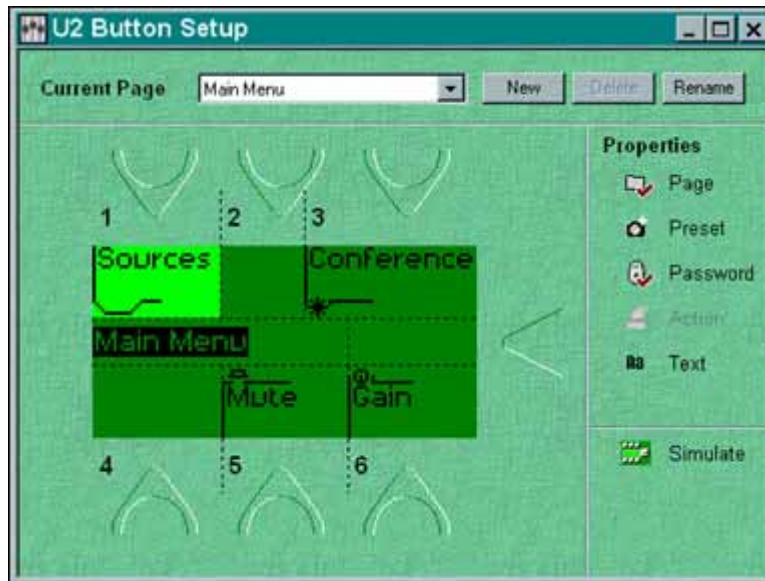

In the illustration the button '1' area is highlighted and the 'Properties' associated with it are on the right showing that the 'Sources' page has a password. The word 'Conference' has been made to fit in the button '3' area using the 'draggable construction lines'.

A drop-down list shows that the 'Current Page' defaults to 'Main Menu'. The buttons **New**, **Delete** and **Rename** are for working with Pages.

The 'Properties' section allows changes to the options for each of the sections of the screen. For example, a Page-change property can be set which would enable a particular button to change the remote to a different Page view.

When a property is set, a red tick is shown next to that property.

Note: There is now an extra button which can load in a 128x64 pixel monochrome bitmap image to display on the remote's screen, e.g. a company logo. An image can be added to each configured page. Account should be taken of any text and operation graphics that may obscure the new image.

# Soundweb™

## 9010 Simulator window

The simulator window is provided for testing the Page layouts and functionality of actions assigned to the controls. To access this screen:

- Press the **Simulate** button in the Page design window.

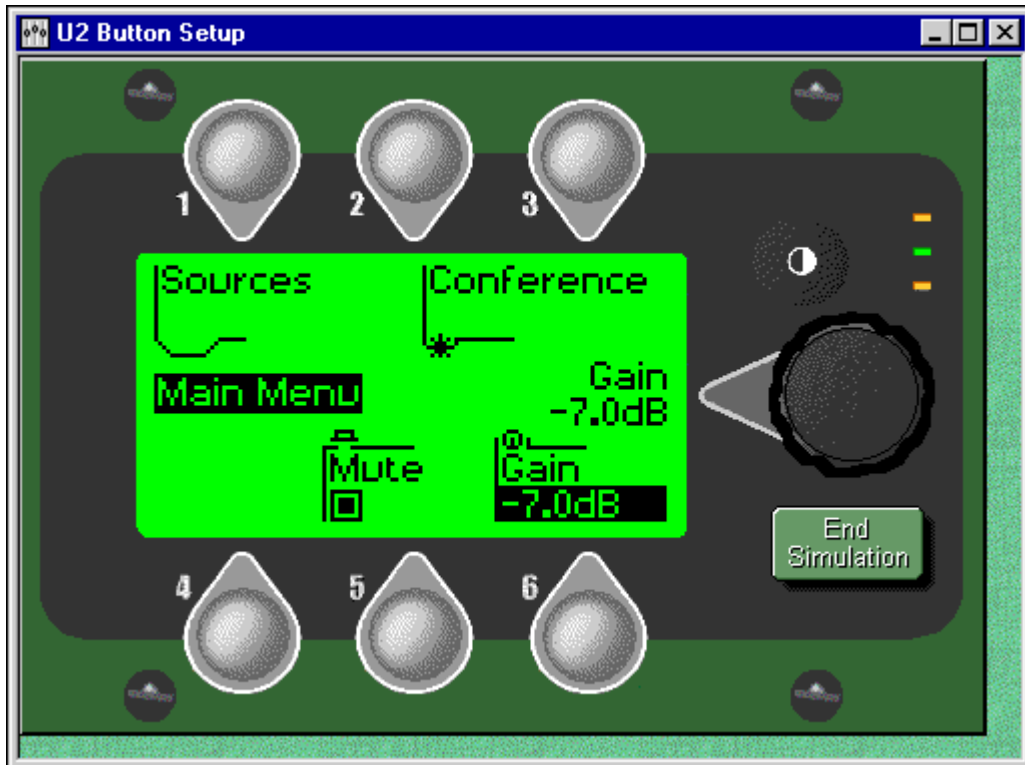

This representation of the 9010 emulates the operation of the real unit and will perform Page changes and radio groups of control values for the rotary encoder, but does *not* control any actual parameters.

- Return to the Page design window by pressing the **End Simulation** button.

### 9010 Input/Output Routing

Double clicking on the 9010 device object opens a Configuration window similar to that for a 9088 or 9000.

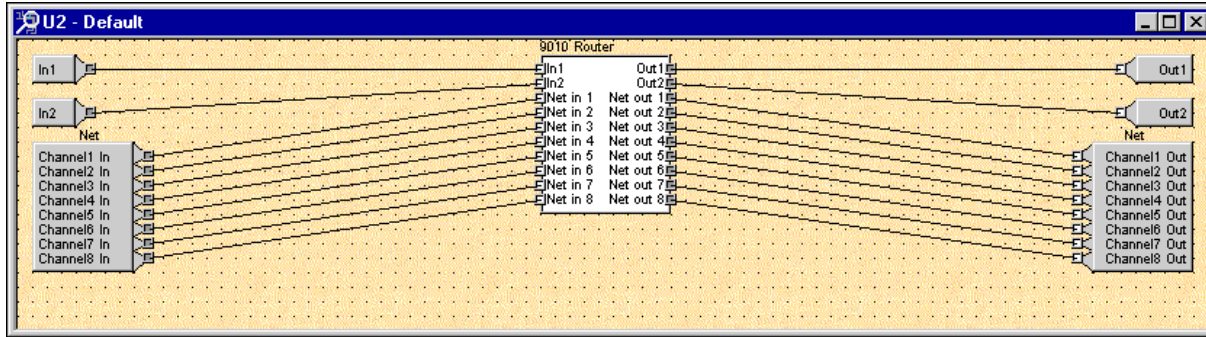

An input and output routing control panel is displayed by double clicking on the '9010 Router' object in the centre of the window.

Routing is split into two parts:

- Route any analogue or network input to either of the analogue outputs.
- Either route an analogue or network input to each of the eight network outputs.

### 9010 Output Control Panel

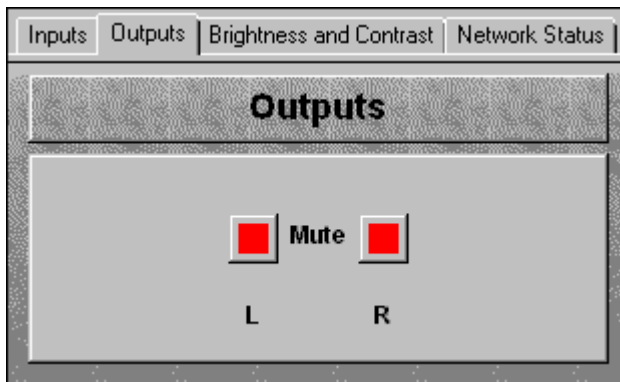

Output mutes are available by double-clicking the input or output blocks in the Configuration window, or by selecting **Control Panel...** from the 9010 device objects right-click menu.

Soundweb™





**Soundweb™**

## Technical Reference Section

---



## 9010 Analogue Outputs Control Panel

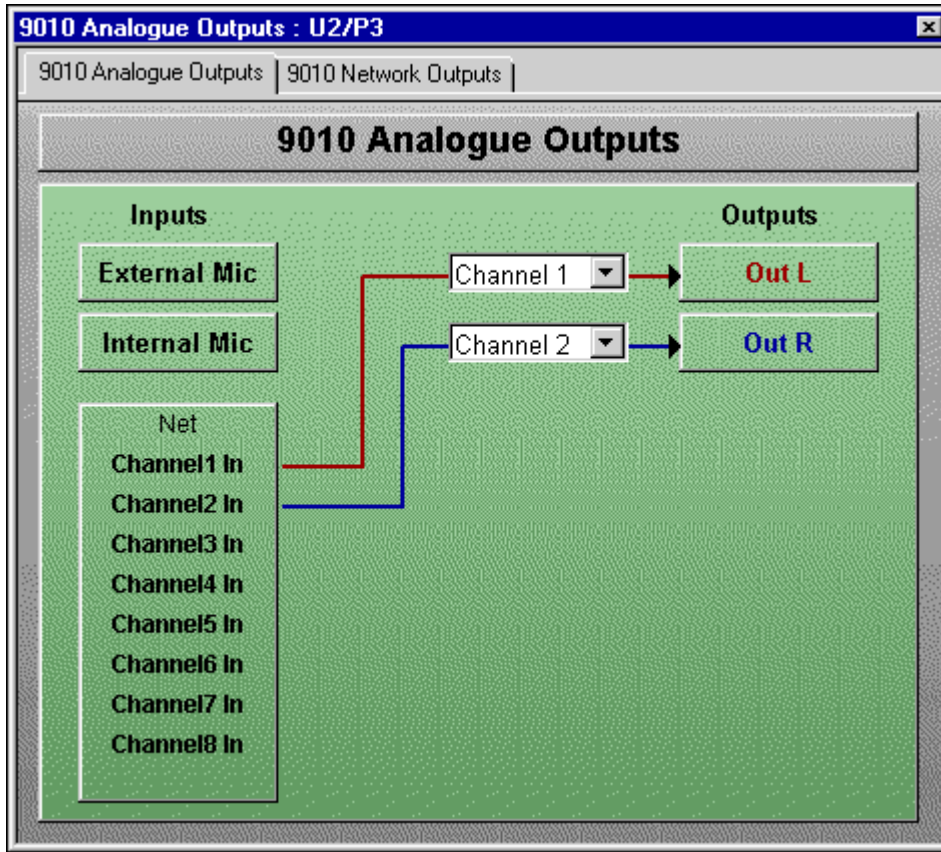

# Soundweb™

An analogue or network input can be selected for each of the analogue outputs. There are no restrictions to this routing and both channels may be routed from the same source.

A 'None' option is provided in the drop down list which will route silence to the selected channel.

## 9010 Network Outputs Control Panel

By default, the network inputs route to their corresponding network outputs. Routing one of the analogue inputs to a network output will replace this default route.

If *both* channels are routed to the same network output, the internal microphone input takes priority - regardless of the order in which they were routed. Routing may be set to 'None' for each channel, which will restore the through route from a network input.

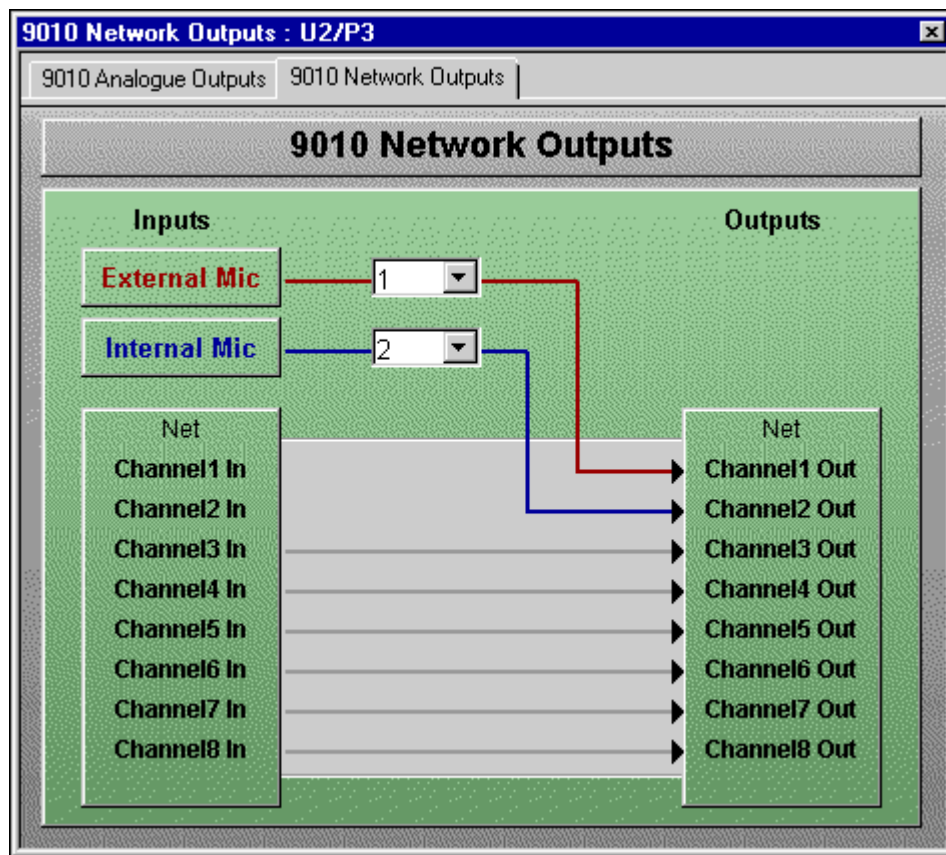

## 9010 Input Gains Control Panel

Input gain adjustment controls are available by double-clicking the input or output blocks in the Configuration window, or by selecting **Control Panel...** from the 9010 device objects right-click menu.

The 'Inputs' tab displays gain faders for both the external input and the built in condenser mic.

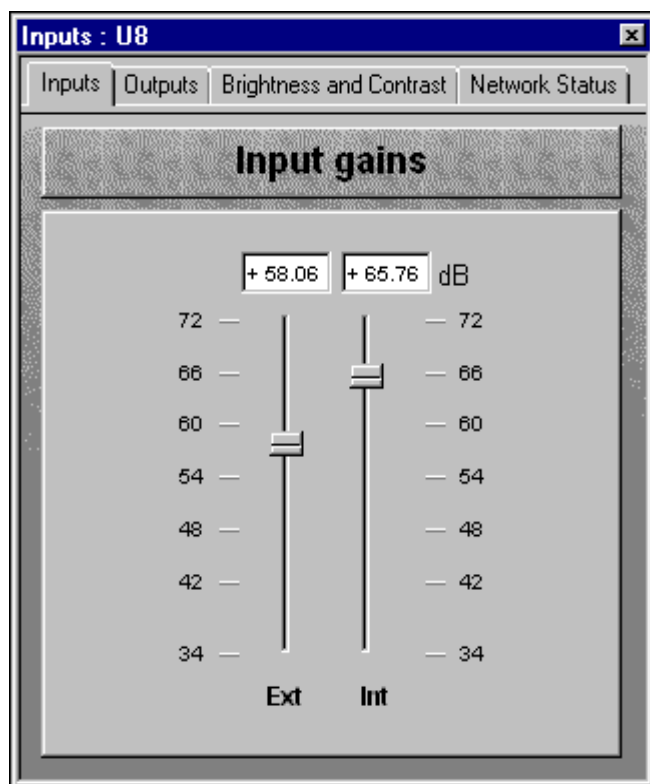

# Soundweb™

## 9010 Screen Control Panel



Brightness and Contrast controls to adjust the screen are available by double-clicking the input or output blocks in the Configuration window, or by selecting **Control Panel...** from the 9010 device objects right-click menu. Brightness controls the backlight level and Contrast the contrast and viewing angle.

## Configuring a control system with the 9010

### 9010 - Creating Pages

- Clicking the **New** button in the Page design window prompts for a name for the new Page.

After a Page is created, the Page name is displayed both in the 'Current Page' popup box and in the screen area. The real name of the Page and the name shown on the screen do not have to be the same.

- Clicking on the screen name and pressing the **Text** property will allow you to change the *displayed* name of the page.

Pages can be renamed or deleted using the corresponding buttons.

### 9010 and Configurations

A 9088 or 9000 Soundweb device may be set up with a number of Configurations, each with a different layout of audio processing objects and associated parameter controls.

The 9010 remote may have controls assigned to its Pages from a number of devices, each of which is able to change its Configuration. It is therefore possible that some of the controls on the remote will be controlling a parameter on a processing object that is not in a currently active Configuration.

In this case, the button parameter is shown as a .

This symbol is also shown at start-up to indicate that the control is not yet ready for use and will disappear once the system has settled.



## 9010 - Creating a Page change button



To create a link from one Page to another:

- 1 Select the originating Page.
- 2 Click on one of the empty button sections of the display.

The Page and Preset properties for this button will become available.

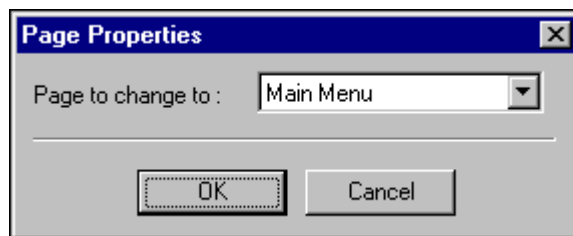

- 3 Click on the Page property and you will be prompted for a Page name from a drop-down list containing all the available Pages.
- 4 Choose the destination Page that you would like this button to select.

You can test your Page change by pressing the **Simulate** button.

- A Preset may be also added to this button at the same time as it being a Page change button.

Remember to provide a way back from a new Page to, say, the 'Main Menu' by repeating this process using another button.

## 9010 - Preset button



Highlighting a spare button section of the screen and pressing the 'Preset' property will prompt you for a Preset to assign to the button.

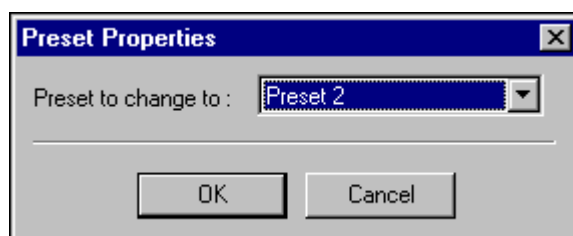

## 9010 - Push buttons



Dragging a control panel button, e.g. the mute button from a gain object, onto the 9010 design window will prompt for a choice of button types.

These can be either *Direct* action (momentary) or a *Toggle*.

- Toggle action is the default action for a mute button; i.e. the button will change state with each press.
- Direct action is provided for circumstances where the action of the button is required only whilst the button is held down, such as push-to-talk. The operation of this type of control can be inverted so that a push-to-talk button can be made from a mute button, i.e. 'push to un-mute'.

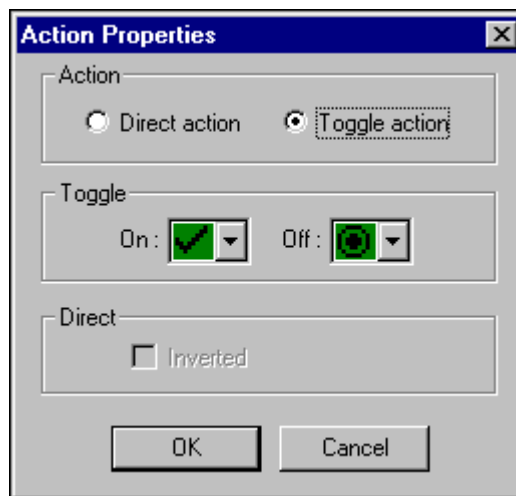

## 9010 - List buttons



A control, such as a source selector from a Configuration window will create a List button when dragged onto the design window. The text associated with the button should not be more than a single line, as the currently selected list item will be shown in the second line.

Pressing the list button will cause a list to appear on the screen, which will scroll with subsequent presses of the button. The selection is activated when the button is pressed and after a couple of seconds of in-activity the list will disappear, leaving the currently selected item visible.

## 9010 - Control buttons



Control buttons allow a number of different parameters to be controlled from the rotary encoder. When a control button is pressed, the function of the encoder is changed to adjust the parameter associated with that button, e.g. a fader level. During parameter adjustment, the screen area immediately to the left of the encoder will show the current control and its value.

For example, the rotary controls for Brightness and Contrast can be dragged onto buttons in the Page design window to become control buttons. Now by pressing the respective button the screen display can be adjusted with the rotary control.

## 9010 - Passwords

A password may be added to any properly assigned Page change button. Pressing a Page change button displays the password protected screen (in simulation mode or on the real remote) and will prevent access to the linked Page unless the correct password is entered.

To assign a password to protect access to a page:

- 1 Set up the page change.

Once there is a valid destination page available the password option should become active in the button setup screen.

- 2 Select the start page from the current page menu.
- 3 Click on the page change button that requires password protection.
- 4 Press the Password button to input your chosen password.

One of two methods of password entry may be configured for each page change:

- Six-digit numeric - Access to a numeric password protected Page is gained by inputting the correct six-digit number using the buttons.
- Alphanumeric - Access to an alphanumeric password protected Page is gained by rotating the encoder until the correct first letter is shown on the screen. Passwords can be set up with between one and eight upper case letters.

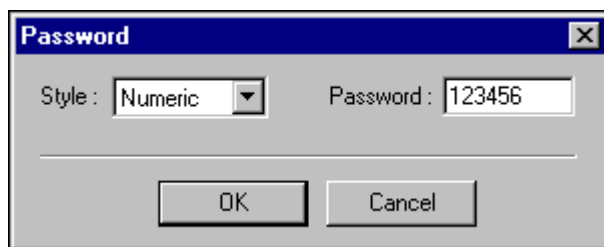

- 5 Select a method to use type in the password and press ok  
The page change is now protected. To test this use simulation mode.



During password entry, the currently selected letter is highlighted and the rest of the letters are shown as asterisks.

- A left-arrow button allows the user to go back to a letter previously entered in error.
- A 'Cancel' button is provided to return to the previous Page.

Press the right-arrow button to move to the next character.

Repeat this process, until all the letters have been entered. Press the 'Enter' button to gain access to the new page.

### Sending Pages to the 9010 remote

As the 9010 Remote does not have any DSP power, it is not necessary to compile any set-up that you may have created for the unit. It is however, necessary to load the unit with the Pages and control parameters that you have configured. This is achieved by going 'online' and loading as follows:

- 1 Select **View>Go to Network view** or press the  button on the toolbar.
- 2 Ensure that the 9010 is in the 'Needs loading' column. If not, then the name of the device is not the same as the device in your design. This can be rectified by renaming the device (select it and press **Rename** or right click on the device in its map window and change the name property).
- 3 Highlight the 9010 device and press **Load**.

After a few seconds of activity, the top level Page should appear on the device.

# 18. AMX Control System Interfacing

Soundweb™



Soundweb can be interfaced to the range of control systems made by AMX Corporation.

To connect a AMX controller to a particular Soundweb device:

- 1 See the '**Connector Pin outs**' for information on how to wire an AMX controller to a Soundweb device.
- 2 Decide which settings and Presets will be communicated between the Soundweb system and the AMX controller.
- 3 Select **Serial...** from the right click menu of a chosen Soundweb device.

This displays a map window like this: (the control surface objects shown in the window below are to demonstrate the possibilities available).

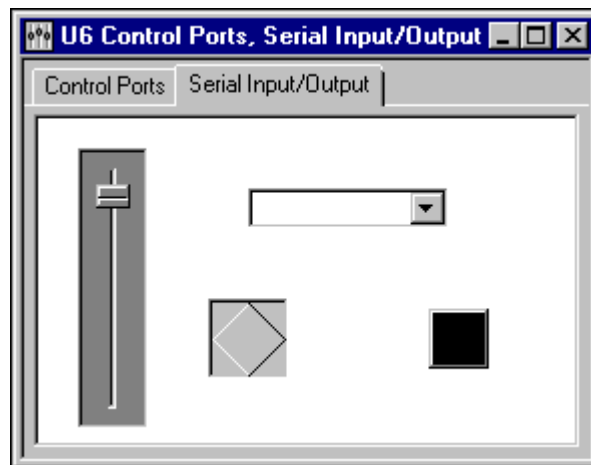
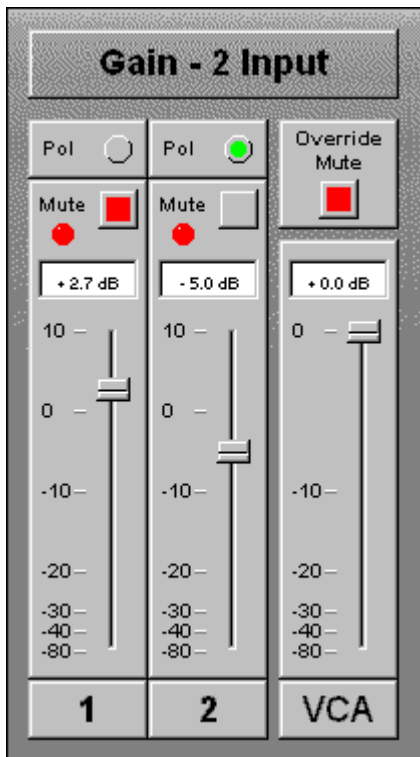

To operate say, the output gain and mute of a mixer from the AMX control system:



- 1 Add a mixer into your Configuration window.
- 2 Double-click on it to access its control panel.
- 3 Select **Design** mode.
- 4 Shuffle the windows on your screen so that both the Configuration window and the Serial input/output window are visible.
- 5 Select and drag the mute button and the fader from the Configuration window to the Serial window.
- 6 Go to the **Serial** menu and select **Export**.



- 7 Choose the location of '**SWFUNC.AXI**' to which you will export the information. The file is in a format suitable to be included into a AMX AXCESS or Netlinx program; it contains functions to map Soundweb controls to equivalents on the touch panel. It also contains the channel code numbers assigned to the controls that are used by the AMX device and by the Soundweb serial protocol for AMX communications.

If opened in a text editor, the file will contain comments which cross-reference Soundweb control references with AMX channel and level codes so that the touch panel layout can be designed correctly.

E.g.

```
(* U2/P2/Gain has level code :- 1 *)
(* U2/P1/Mute has channel code :- 4 *)
```

The exportable controls are:

- Faders
- Buttons including toggles, spin pairs and momentary.
- Meter bar graphs
- Source selectors
- Preset buttons
- Parameter Preset bars

## Programming AMX

Run the 'AXCESS' compiler program or 'AMX Studio' and create a new project, importing the files:

**BSSMAIN.AXS**  
**SWLIB.AXI**  
**SWFUNC.AXI**

Open the file **BSSMAIN.AXS**, this file is supplied as an example minimum to get your system running. It contains all the calls to the library functions that live in an 'include' file **SWLIB.AXI**. For Soundweb controls to co-exist with controls for other systems, the relevant calls from this file may be placed in another .AXS file, or you may add extra functions to this one. Bear in mind all the channel codes that have been allocated in the exported file **SWFUNC.AXI** when adding or merging another set of controls for other AMX controlled devices. It is also advisable to keep these three files together in a chosen directory.

Compile the file '**BSSMAIN.AXS**' as AXCESS or Netlinx as appropriate (the export and library are compatible with both) and download it to the 'Master'.

Before anything will work, you must have buttons and levels set up on the panel with the correct channel codes as described in the '**SWFUNC.AXI**' comments.

Set up touch panel controls with the following attributes:

- **Text objects** - have a variable text number and a channel number of zero. There is a maximum of 255 text objects but, these are not currently controllable from Soundweb
- **Level objects** - have a unique level number from 1 to 32.
- **Toggle buttons** are to be set as CHANNEL feedback.
- **Preset change buttons** should have a page change associated with them and are MOMENTARY feedback. The page change is so that the correct controls for a particular Preset come into view. If a page change is not assigned to a Preset button be prepared for controls not to respond because they are not relevant to the current Preset. This is the equivalent of controls being 'greyed-out' on a Soundweb map window.
- **Spin pairs** are to be set as feedback.
- **Source selectors** are MOMENTARY feedback buttons and have mutually exclusive and latching attributes associated with them in the master. This is handled automatically by the exported code.

Finally, compile the Soundweb layout and load the device. Upon loading, the back serial port will be configured for AMX control. Ensure that the AMX master has its dipswitches set for 38,400 baud 8N1 with no handshaking and messaging will commence.

**Soundweb**<sup>TM</sup>

## AMX Example Code

Parts of SWFUNC.AXI will look similar to this:

```
(* --> 'U1/P5/Mute' *)
    PUSH [TP, 10]
    CALL 'SW TOGGLE BUTTON' (10,SW_TOGGLE)
    [TP,10] = SW_CONTROL_VAL[10]
(* <-- *)
```

Placelholding comments surround each exported control:

```
(* --> *)
(* <-- *)
```

All calls to SWLIB.AXI, the library module, start with SW.

SWLIB.AXI provides the background handling of buttons, level controls, spin pairs, metering, and all the messaging to the Soundweb unit. This file contains more library functionality than the exported code actually puts to use and serves as an example of more complex control types that can be implemented on a AMX touch panel.

All the designer need do to get a system up and running is to have an INCLUDE 'SWFUNC.AXI' statement at the top of the main file and the following two calls:

```
DEFINE_START
CALL 'SW INIT CONTROLS'

DEFINE_PROGRAM
CALL 'SW RUN CONTROLS'
```

In this way, Soundweb controls and background messaging can co-exist with any other code in the master by being completely encapsulated in the include files.

## AMX Object Detail

A toggle button is realised by using script for updating the feedback and sending the status to the Soundweb unit each time it changes. Similarly, Soundweb can toggle the control on the touch panel.

An LED is a button with attributes that can be changed remotely. Its presses are not serviced.

A Preset is a momentary button that fires off a message. Soundweb Designer exports a list of associated controls in an exclusive group. Source selectors are set up in a similar way.

Controls in a Parameter Preset need to be set up as mutually exclusive. It is also necessary for these controls to be defined as latching.

The AMX master handles update of mutually exclusive controls so all that is required is an ON message for a particular source or Preset and the others are cleared.

To ensure that the correct controls for a particular Preset are displayed on the panel, use a touch panel page change together with a Preset change. If the user changes page, it is up to the designer to ensure that the Soundweb unit is notified with a Preset change at the same time. This can be done by allocating the page change button a channel code and sending a Preset change. SWFUNC.AXI contains some extra code associated with Preset buttons for changing page. Uncomment this and change to your page name:

```
(* --> `U1/Preset 1' *)
    PUSH [TP, 20]
    CALL `SW RECALL PRESET' (20)
(* uncomment the next line and change to your page name *)
(* CALL `SW SEND PAGE CMD' ("`Page name'") *)
(* <-- *)
```

A level control is an on-screen fader which is continuously monitored by AXCESS. Any changes in these controls will be sent to the Soundweb unit.

For further information regarding AMX control and other serial interface issues please consult the Serial Interface Kit which contains further examples and documentation, available directly from BSS.

# Soundweb™

## Data export functions

Designer now incorporates a new export function that allows the class name and id of particular processing objects within configurations in devices to be saved to a file. This file can then be imported into suitable third party control software applications for further external control of a Soundweb system.

Processing objects are chosen to be exported by either right clicking on an object and selecting 'Marked for export' or by renaming the object; which automatically selects this option. Objects can be chosen from multiple devices and then exported using the File menu command 'Export object data.'. Note that this command is only available at map window level, i.e. it does not appear in the File menu if a configuration window is the currently open window.

When you roll over an exportable object in a configuration or map window the status bar at bottom left of the screen displays the network address or 'handle', i.e. Handle=0x00000002. A control surface object on a control panel will display its handle and 'Method' code briefly on rollover with the mouse. Note that the method is currently not exported as part of the file.

The file that is exported can be saved either as a standard comma separated value (.csv) or as an object data file (.hdl). The format of the file is as follows:

1 <sup>st</sup> line	"File version",	"Designer version"	
Next lines	"Object name",	"Object type",	"Handle"

The SW Interface Kit documentation provides further detail on how to control processing objects using this data.

Note: when controlling a Soundweb system (via a rear RS232 port) you need to add '+s' to the name of the device that you wish to connect to. This changes the protocol used on the rear RS232 port to the SW Interface Kit protocol.

## i Audio processing object properties

Many processing objects have options that may be set prior to compiling. These allow optional or advanced features to be set up, such as access to sidechains, adding auxiliary buses to mixers, or controlling the maximum slope of crossovers.

To adjust the options for a processing object

- 1 Right-click on the object and select **Properties**.

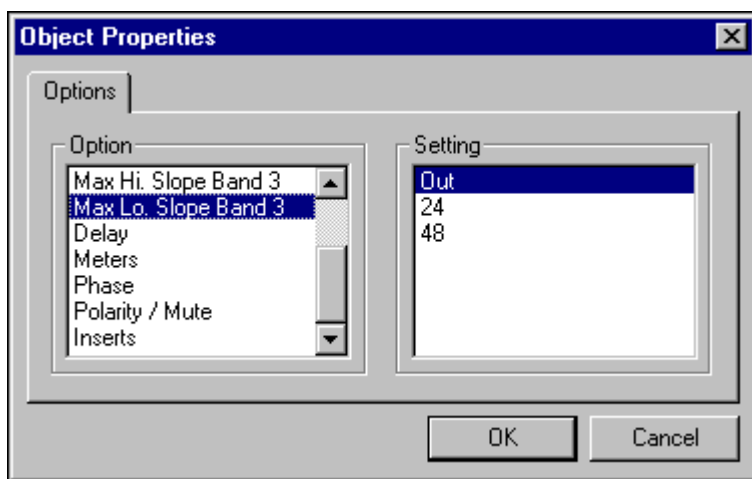

For objects that have more than one property:

- 2 Select the *property* you wish to change in the '**Option**' column
- 3 Set the *value* you wish to assign to this *property* in the '**Setting**' column.

The options for Processing objects default to 'off' to prevent overuse of DSP resources.

To access an object's control panel double click on it in the map window.

# Soundweb™



## Audio Processing Objects

---

### AUTOMATIC MIXERS

In addition to the features of a conventional mixer 'Automixers' allow 'hands-free' multi-microphone mixing without the need for 'manual gain riding' to keep background noise and feedback under control. These objects use an *Adaptive Threshold Gain Sharing* technique to control the attenuation in each input channel.

Note that due to this automation automatic mixers can use many dsp resources.

All inputs share the available gain; i.e. an 'open' microphone will attract the most gain. If more than one microphone is in use, the gain in the active channels is shared to give the same overall system gain. When all inputs are idle, the shared gain keeps all channels slightly active to avoid 'pumping' of the background noise.

Downward expansion is available for further reducing the background noise contribution from idle microphones. Options are provided to allow the mixer to be expanded not only within a given device, but also across the network. Aux. buses can be created and direct channel outputs may be made available for final mixing elsewhere, or for adding equalisation or other processing.

#### Inputs and Outputs

- The number of inputs and outputs for an Automixer is specified in its name; e.g. '8 to 1' has 8 inputs and 1 output.
- There is additionally an output for each aux. bus.
- The direct out property produces an additional output per channel for further processing or mixing elsewhere.
- The master option adds a further Mix Input, Chain Input and Master Output

#### Properties

##### Aux. Buses (0/1/2):

The number of aux. buses can be selected between 0 and 2.

##### Voiceband filters:

Filtering may be included so that the automixing action favours frequencies in the human vocal range. This helps the mixer to distinguish between speech and noise, giving a voice signal a better chance of 'winning' against a noise signal on another channel.



## Control Panel

Two tabs - 'Automatic Mixer' (or 'Channels') and 'Aux Buses':

### Automatic Mixer Tab:

- **Fader** for each input.
- **Mute** button for each input.
- **Polarity** button for each input (for signal inversion).
- **Solo** button for each input.  
Allows only 'soloed channels to be heard.  
! This is a 'solo-in-place' which impacts the main output.
- **Override** button for each input  
Forces this channel to be heard above all the others.  
Useful for a chairperson to interrupt a conference speaker for example.
- **Auto/Manual** button  
Assigns each channel to operate as either a conventional mixer channel or an automated channel.
- **Off Gain** control for each input.  
Determines what maximum attenuation will be applied by the downward expander to an idle channel.  
When this control is set to 0dB, no downward expansion is applied.  
The setting of this control has some effect on the point at which the On indicators illuminate.
- **Gain** control for the output.
- **Master Mute** button for the output.
- **Slope** control.  
Determines how aggressive the gain sharing is.  
Low slope settings cause the object to behave just like a conventional mixer. High slope settings cause the inputs to attenuate more deeply for 'closed' microphones. The fully clockwise 2:1 setting will be appropriate for most applications, but if you find the action to be too aggressive and do not want idle microphones to be 'dimmed' as much, then back this control off slightly.
- **Speed** control.  
Determines how quickly a channel recovers from being open.  
Fast (anti-clockwise) settings will be needed if different speakers are speaking in quick succession, since slow settings would prevent a newly active channel from fading up quickly enough.  
If the setting is too fast however, the gain sharing could 'pump' the gain up and down between spoken words.  
A setting somewhere near the centre of the travel will be found suitable in most cases.
- **On Indicator** for each input.  
Shows when a channel is active.

# Soundweb™



The 'on' level is related to the setting of the 'off gain' control. Since the gain sharing algorithm is a linear process, there is actually no concept of absolute 'on' or 'off'. Note that only one On indicator is allowed to be 'on' at a time so that the indicators may be applied to logic outputs to identify the speaker in automated camera applications.

**Aux Buses** Tab (optional)

- **Aux (send) output** control for each input and each bus.  
(Auxes are post-fader and post processing)

**! This object is capable of raising signal levels beyond the clipping point, so care should be exercised when using positive gain values.**

## MIXERS

A straightforward mixer object to mix an array of inputs to an output (or stereo output). Aux buses are optional.

### Inputs and Outputs

The number of inputs and outputs for the Mixer processing object is specified in its name, e.g. '8 to 2' has 8 inputs and 2 outputs. There is optionally one output for each aux bus.

### Properties

#### Aux Buses

The number of aux buses can be selected between 0 and 2.

#### Pan Law (stereo mixers only)

The law of the pan controls may be set to either 3dB, 4.5dB or 6dB. These figures relate to the attenuation applied to each channel at the central pan position.

### Control Panel

Two tabs ('Mixer' and 'Aux' Buses):

#### Mixer tab:

- **Fader** for each input
- **Pan** control (stereo objects only)
- **Mute** button for each input
- **Polarity** button for each input to invert the signal
- **Gain** control for each output

#### Aux Buses tab:

- **Aux** (send) output control for each input for each bus (optional)
- **Aux Pre-Fade** button to allow the aux signal to be routed either from before or after the fader (optional).

**! This object is capable of raising signal levels beyond the clipping point, so care should be exercised when using positive gain values.**

## MATRIX MIXERS

This object is used to connect an array of inputs to an array of outputs with an individual gain setting for each crosspoint.

### Inputs and Outputs

The number of inputs and outputs for the Matrix Mixer processing object is specified in its name, e.g. '16 to 8' has 16 inputs and 8 outputs.

### Control Panel

Two tabs ('Route' and 'Mix'):

#### Route tab:

- **Connect** button for each crosspoint.  
Click this to connect an input to an output (green), or to disconnect (no-colour).

#### Mix tab:

- **Gain** control for each crosspoint.
- **Overall Gain** control for each output.
- **Navigation** buttons (Larger matrix mixers):  
Select which section of the mixer is displayed in the control window.  
The labels on the axes change accordingly.
- **Select** button to switch between Connect buttons or Gain controls.

## MATRIX ROUTERS

These are identical to **matrix mixers** except that the gain at each crosspoint is fixed at 0dB

## SOURCE SELECTOR

An input select switch to choose between a predetermined number of inputs.

### Inputs and Outputs

The number of inputs for the Source Select processing object is specified in its name; e.g. '8 - Input' has 8 inputs. One output.

### Properties

**State 'None' Available:** The user may choose whether the 'None' position is available or not (no input).

### Control Panel

- One **combo box** permits the selection of one input, or optionally 'None'.

## SOURCE MATRIX

Routes between a predefined number of inputs and outputs. Each output can be sourced from one input or none.

### Control Panel

- One **combo box** per output permits the selection of a source input or none.

**Soundweb**<sup>TM</sup>

## DELAY

A basic delay line for delaying an input signal by a predetermined delay time without affecting the signal in any other way.

### Inputs and Outputs

- One audio input.
- One audio output.

### Properties

**Max. Delay Length** - (Short(80ms)/Medium(340ms)/Long(1360ms)/V.Long(5450ms)):

The maximum delay time may be selected between four different values so that minimal resources are consumed where only short delays are likely to be required, whilst still allowing very long delays to be used in applications that demand them.

### Units:

Adjust and display the delay in terms of inches, feet, metres or seconds.

### Control Panel

- **Delay time**  
Adjustable using spin increment/decrement box.

## GAIN/MUTE

A straightforward gain control for raising or lowering the level of the signal and integral mute button.

### Inputs and Outputs

- One audio input
- One audio output.

### Control Panel

- **Gain** fader  
Adjusts the gain from +10dB down to off.
- **Mute** button  
Mutes the output. On multi channel gain objects there are separate mutes per channel and an overall mute.
- **Polarity** button  
Inverts the signal.

**! This object is capable of raising signal levels beyond the clipping point, so care should be exercised when using positive gain values.**

There is now a new *category* of processing objects – ‘Gains’, 2 in, 4 in and 8 in gains have been included to accompany the single Gain control. Comprising of straight through gains with individual muting, polarity, overall mute of gain group and ‘master’ control of level. In this way multiple channels can have their levels adjusted with overall adjustment of relative level and signal mute from one control panel and without mixing.

# Soundweb™



## METERING POINT

A signal level metering object to monitor and display signal levels on the screen.

### Inputs and Outputs

- One input.
- One optional output.

### Properties

#### Control Output Available (Yes/No)

Outputs the DC sidechain of the meter for special applications.

Note that the signal at the meter output is not audio, but the meter 'sidechain'.

### Control Panel

Different styles of display are available in different tabs.

'**Bar**' tab (only if you do the Soundweb training!)

An LED bar graph type display

'**Needle**' tab

An analogue style VU meter display

'**Controls**' tab:

- **Attack** time control  
Adjusts how the meter responds to short duration transients.
- **Release** time control  
Adjusts how long the meter takes to recover.
- **Reference** control  
Sets where 0dB on the meter refers.

## tone generator

A test tone signal source that generates a sine wave of adjustable frequency and level.

### Inputs and Outputs

- One audio output.

### Control Panel

- **Level** control.  
Adjusts the output level.
- **Frequency** control.  
Adjusts the frequency of the test tone emission.

## noise generator

A random noise signal source which generates either white or pink noise of adjustable level. Two or more instances of these noise generators will produce uncorrelated outputs.

### Inputs and Outputs

One audio output.

### Control Panel

- **Level** control.  
Adjusts the output level.
- **Type** combo box.  
Selects between white or pink noise generation.

### Notes

White noise has equal energy per linear (Hz) bandwidth, and is useful for FFT based analysis. Pink noise has equal energy per percentage (Octave) bandwidth, and is useful for use with conventional Real Time Analysers that have equal octave width bands (e.g. 1/3 octave).

## CROSSOVER

A fully featured loudspeaker management processor consisting of various alignments of crossover filters, gain controls, and mid-band limiters. The limiter is a two-stage protection limiter for protecting against amplifier clipping and loudspeaker damage. The first stage has ballistics suitable for long term protection whilst retaining transparency and minimising signal level loss. The second stage has much faster ballistics to protect against loudspeaker over excursion. Limiter ballistics are automatically set by the system to give the optimum performance based on the high-pass frequency of the band. Options include delays, phase filters and limiter metering.

### Inputs and Outputs

- One audio output per band
- One common audio input.

When the option for individual inputs is selected, there is one input per band.

### Properties

#### Max Slope (out, 24, 48)

The maximum cut-off slope can be adjusted for each band edge so that resources are not wasted in allowing for high-slope crossover filters (such as 48dB/Octave) in applications where gentler, and less resource-hungry slopes are acceptable. The default is 24dB/Octave, which is suitable for most applications. Note that regardless of the maximum setting, the control panel will always allow lower slopes to be selected at any time.

#### Delay (off/on)

A delay-line may be inserted into each band for aligning loudspeaker drivers in time.

#### Meters (off/on)

Metering may be added to monitor the action of the limiters.

#### Phase (off/on)

Phase filters may be included to apply phase shifts between adjacent bands for fine-tuning alignment.

#### Polarity/Mute (off/on)

Polarity inversion and mute controls may be added.

#### Inserts (off/on)

The input feeds to the crossover filters are normally internally connected together to form a single common input, they may optionally be split into separate inputs so that equalisation (for example) can be uniquely applied to individual outputs without disturbing the calibration of the limiter.

### Control Panel

The graphical representation of crossover areas indicates what part of the frequency range each band occupies but is not intended to be accurate. Each band is a different height and colour,



with numbers on the right-hand edge of the graphics window to show which output the band is sent. The band edge is indicated by a square box (node) on the corner of the 'frequency response'. When selected the node becomes 'solid' and the frequency band can now be expanded or contracted by moving this node horizontally left or right.

Four tabs (Crossover, Delay/Phase, Gain, Limiter):

### Crossover tab

- **Frequency**  
Drag nodes horizontally with the mouse to change the crossover frequency. Normally the node at the intersection of two adjacent bands would be moved so that the adjacent bands track together. Some applications require adjacent crossover frequencies to be offset (overlapped for example). This can be done by selecting one band edge so it can be moved independently. Alternatively, the Frequency control below the window may be adjusted.
- **Filter Type**  
This combo box selects the alignment of the crossover (the crossover filter 'shape'). Note that the shape can be set differently on each band edge and, even on adjacent band edges, although this latter situation is probably best avoided in audio terms.

All X-overs now have the option of using Thiele Filters. This new filter type is designed around the Australian WHISEWORKS - Neville Thiele Method\* filter and BSS Audio is the first pro audio manufacturer to embrace the new technology. Select the NTM filter type from the drop down list.

WHISEWORKS - \*NTM™ and WHISEWORKS - Neville Thiele Method™ are trademarks of Precision Audio Pty.Ltd

### Delay/Phase tab

- **Delay** spinbox (for each band)  
Together with an optional graphical representation of the delay time using 'speaker' icons.
- **Phase** spinbox (optional)  
Adjusts the phase shift applied between a pair of bands.  
As there is some interaction between the phase controls, it is recommended that the highest frequency band phase be adjusted first, and then successively lower ones.

SOUNDWEB™

## Gain Tab

- **Band Gain** control  
Trims the output level of the band.  
The gain control is before the limiter, so does not alter the calibration of the limiter threshold. For optimal gain structure management, remember that any attenuation is better done in the analogue output control rather than in the crossover. If the crossover output is connected directly to an analogue output, the crossover limiter threshold will remain in calibration.

**! This control is capable of raising signal levels beyond the clipping point; so, care should be exercised when using positive gain values.**

- **Polarity** button  
Reverses the polarity of the band. (optional)
- **Mute** button  
Silences the band output. (optional)

## Limiter tab

- **Threshold** control  
Adjusts the level threshold above which limiting will take place.  
The system will track changes made to the main analogue output level control so that the limiter threshold setting relates to the level at the output terminals rather than the level at the output of the crossover.

If other processing objects are connected between the output of the crossover and the output the limiter threshold setting may be inaccurate, and the user must compensate for level changes which occur in these objects.

- **Meter**  
Displays the input signal level relative to the limiter threshold.  
A reading of 0dB corresponds to the limit threshold, whereas a reading of +6dB for instance means the signal is exceeding the threshold by 6dB, and is being compressed by 6dB.

## MONO SUB

Identical to the Crossover object except that it is a single band crossover with two inputs, which are internally mixed together with 6dB of signal loss so that a mono sub-bass feed can be created from a stereo signal.

This would normally be used in conjunction with a pair of crossover processing objects to handle the main stereo channels.



## AMBIENT NOISE COMPENSATOR

Allows the level of an announcer (or other programme material) to 'ride' on the average background (ambient) noise level so that the programme is kept at an audible level above that of the ambient noise.

It does this by measuring the level of the ambient noise (using a suitably placed microphone), and controlling the gain of the programme channel accordingly. Since the gain must be controlled only by the ambient noise, and not by the level of the programme itself, the ambient signal level will only be measured and the gain adjusted during periods of inactivity in the programme channel. The length of the gap in programme required for sampling to occur is adjustable to allow for reverberation on the programme.

Various controls further allow the user to vary the announcement threshold level for gap detection, the minimum and maximum applied gain, the speed of gain change, and the reference ambient level.

### Inputs and Outputs

- One announcement (Programme) input
- One ambient input - labelled 'Amb in'
- One audio output

### Control Panel

- (Ambient) **Threshold** control  
Adjusts the ambient signal level at which unity gain will exist. The amount by which the announcement channel gain is increased is equal to the amount by which the ambient level exceeds this threshold. Lower threshold settings will tolerate lower ambient signal levels before increasing the announcement gain. To lift the announcement out of the ambient noise more, *reduce* the setting of this control.
- **Ambient Level Meter**  
Displays the current ambient noise level. It's positioning next to the Threshold control shows the difference between the ambient level and the threshold, (which is equal to the applied gain).
- **Announcement gain meter**  
Indicates the current announcement channel gain.
- **Min Gain** control  
Determines the minimum gain that will be applied to the announcement channel. This should be set (with the aid of the Min Gain button) during quiet ambient levels so that an adequate announcement level is obtained.
- **Min Gain** button  
Forces the gain to the minimum setting for set-up purposes. Illuminates when activated.
- **Max Gain** control  
Determines the maximum gain that will be applied to the announcement channel.

## NETWORK SELECTOR

A simple switch that chooses between two inputs depending on the status of a network port. Designed for 'fault tolerance' applications where dual circuit loop redundancy is necessary. For further details see Building in fault tolerance in the Technical Reference section.

### Inputs and Outputs

Two inputs 'Default' and 'Backup'.

One of these inputs is fed to the output depending on the state of a given network port.

- If the network port has a valid connection, then 'Default' is fed to the output.
- If the network port does not have a valid connection then 'Backup' is routed to the output.

### Properties

**Network Port Control** (Net in/Net out)

Selects what network port on the hardware device is configured as the 'default' or 'backup'.

### Control Panel

3 indicators:

- **Input** - displays receipt of network signal.
- **Default** - Lights to show that the 'default' input is providing network communication.
- **Backup** - Lights when the default system has failed or is not present and indicates that the 'backup' input is now handling network traffic.

## MODULATOR

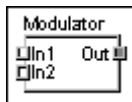

This processing object is found in the 'Primitives' group and has no control panel or properties.

### Inputs and Outputs

- Two inputs.
- One output

The output is one input multiplied by the other input, i.e. the output is the *product* of the inputs. The inputs can be AC (i.e. normal audio signals) or DC (e.g. dynamics sidechains etc.). Note that distortion will result if both inputs are AC(audio).

The modulator could for instance be used to allow the amplitude in one signal path to control the amplitude of a signal in another signal path to achieve a level-riding effect. To do this, you would put the controlling signal through a 'meter' to turn it into DC, then apply that to one modulator input, then pass the controlled signal through the other modulator input to the output.

**SOUNDWEB**  
DESIGNER™



## ii Understanding Networks

Soundweb devices, such as the 9088 processor, are connected in a 'token ring' style network in order to route audio from one input to another output elsewhere in the system. The network is bi-directional; this improves robustness and tolerance to faults.

A basic system routes 8 signals between boxes on the network. An exception to this is if there is only two 9088 devices in the system, in this instance 16 channels can be routed simultaneously.

### Hubs

If routing only 8 signals then up to 20 devices can be connected without the need for a hub. To create larger routing matrices using more channels a 9000 series hub is necessary. The hub has 6 network ports, each of which can support up to 6 Soundweb devices that become discrete rings in themselves.

### Network wiring protocols

A network jack on a Soundweb device is designated as one of two types: *Input* or *Output*. These are identical apart from two things:

- The pin out of the transmit and receive pins is reversed.
- The Output jack contains a power source whereas the input jack contains a power sensor only.

The jacks are labelled '**In**' and '**Out**' but, data travels in both directions through either, so these names are not intended to represent data flow direction. Although by convention, audio channels are thought of as passing from an Output to Input.

A Soundweb network must be connected 'point-to-point', i.e. connect a single '**In**' jack to a single '**Out**' jack, using a standard straight through cable. Such a connection is compatible with industry standard structured cabling systems. Refer to 'Connector Pin outs' for wiring details.

This allows audio channels to be passed 'downstream' from the Net '**Out**' jack on one device to the Net '**In**' jack on the next device. Soundweb automatically analyses the cabling and creates a network ring for itself by utilising a 'back-channel'. Audio channels are then routed back from the terminal device (the one without a connection on its Net '**Out**' jack) to the first device (the one without a connection on its Net '**In**' jack). These two jacks constitute *end nodes*.

! There must be no physical cable connection between these two end devices.

Note that all 6 network connections on a Soundweb 9000 Hub always become 'end nodes'. Each connection to the Hub thus becomes a discrete ring.

### Networks - Example using 9088s

Consider a collection of three 9088 devices which are connected in a simple 'daisy-chain' so that audio channels pass from the first device to the second, and from the second device to the third.

The 'Out' jack of the first device and the 'In' jack of the third device will become 'end nodes'. Soundweb will automatically complete a *phantom* connection from the third device back to the first device (using a 'back channel') to form a network ring.

Audio channels sent to the Net 'Out' of the third device will then be received at the Net 'In' of the first device.

No physical connection is permitted between the Net 'In' jack of the first device and the Net 'Out' jack of the third device.

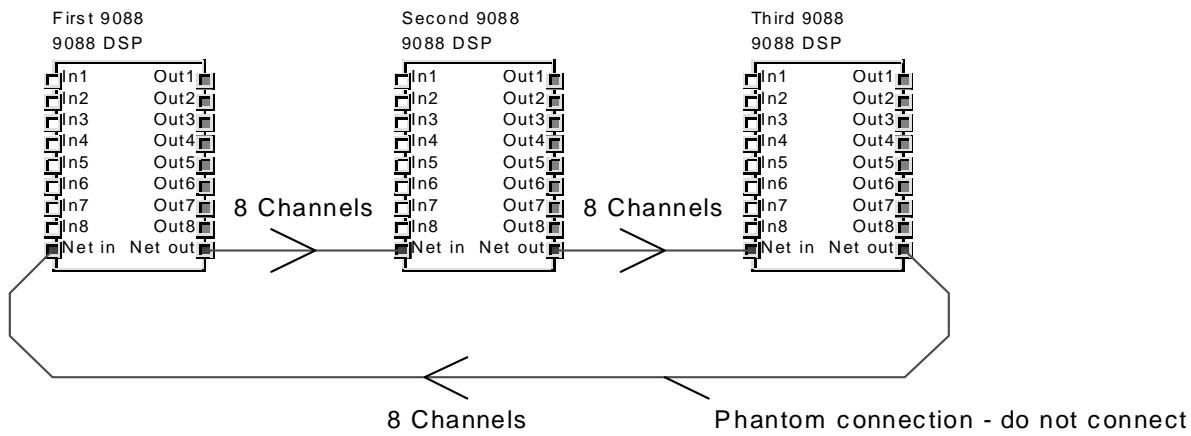

Soundweb™

**Networks - Example using 9088s and 9000 hubs**

Building on the previous system of 9088 devices and plugging the 'Out' jack of the third 9088 into 'In 1' of a 9000 hub, then plugging 'Out 4' of the Hub into the 'In' jack of a fourth 9088.

Soundweb will complete two rings using two 'back channels', One between the 'In 1' jack of the 9000 and the 'In' jack of the first 9088, and one between the 'Out 4' jack of the 9000 and the fourth 9088.

Audio channels will pass along from the first 9088 to the second, the second to the third and from the third to the hub. The audio is then routed from the hub to the fourth 9088. The 'back channels' will also allow audio channels to pass back from the hub to the first 9088 and from the fourth 9088 back to the hub.

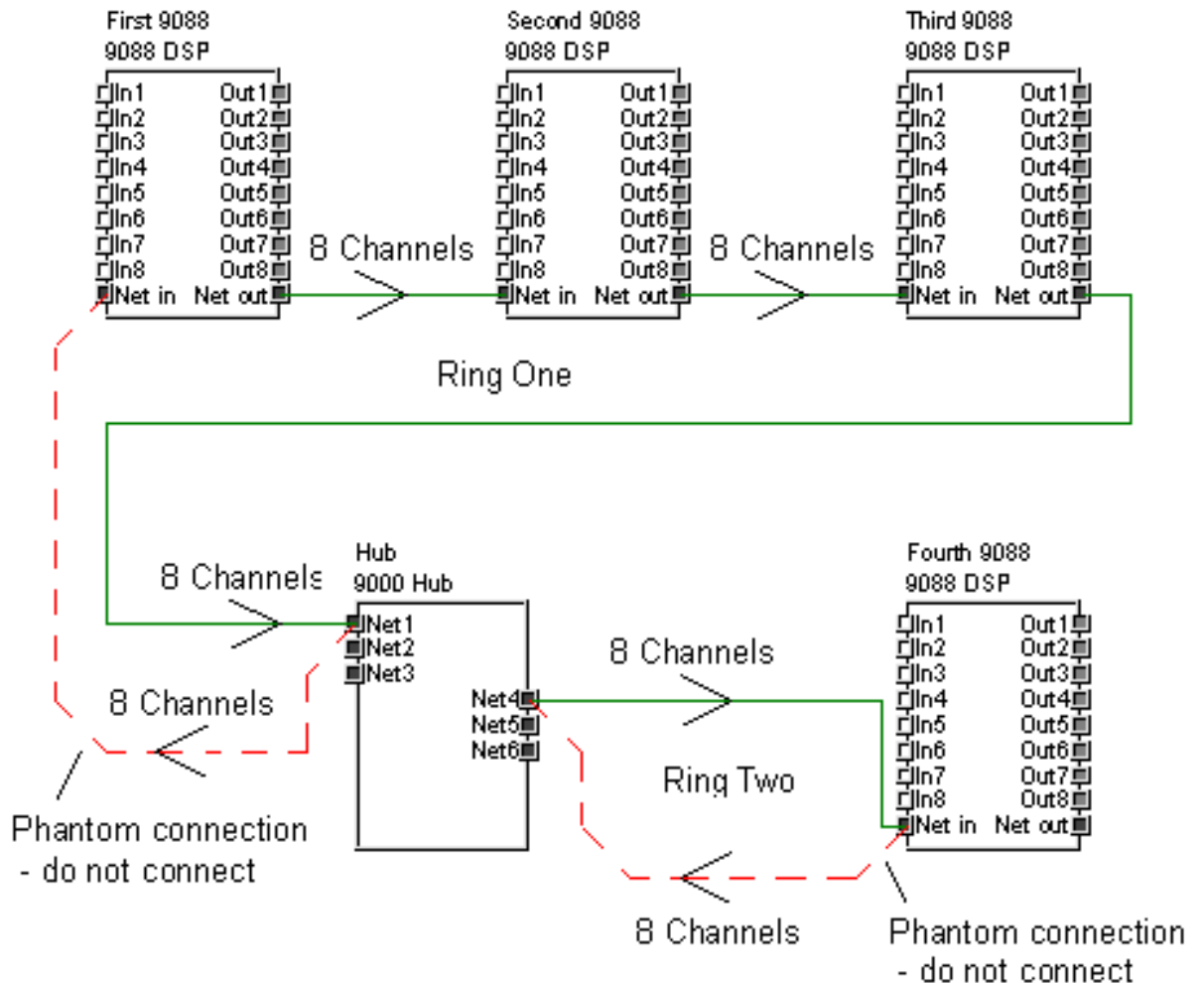

## Using the 9000ii Network Hub device

If you are have 9000ii's available to your design and wish to make use of their extra dsp power (i.e. you don't need to retain compatibility with the standard 9000):

- 1 Use **Add>Device** and select 9000 hub as usual.
- 2 Set the '**Type**' to **9000ii** (9000 is the default).

This can be done later using the device options in the device's **properties** menu.

If you look in the Kit-List, you should see something like this:

**"Kit List" for Soundweb project 'New file'**

**You will need**

3 9088 DSP

2 9000 Hub (1 with type 9000ii or later)

When you go 'online', you should be able to load the 9000ii as normal. If, however, you see something like this:

**The following devices have the wrong options set :-**

- *Name : U2 Type : 9000 Hub*  
*Type' is set up as '9000ii' in design,*  
*but as '9000' on network device.*

Confirm that you have named the device correctly. If the physical device is a 9000ii, make sure that it is loaded with the latest software (if you load a 9000ii with old 9000 software it will not work correctly) and try again.

Note: A 9000 hub cannot be physically upgraded to ii status as it contains fundamentally different hardware.

## Network restrictions

Soundweb allows you a lot of freedom in how the network cabling visits the devices on the network, so long as '**In**' jacks are connected to '**Out**' jacks, and that all devices are connected together by at least one cable (so that the PC can communicate with all of them), and they can communicate with one another.

The only limitations are:

- There must be at least one end-node device that is not a 9000 hub somewhere in the network, i.e. there must be a 9088 with one unconnected network jack. This is because there must be a network *master*, which can only be a *terminal* device and not a hub.
- There must *not* be a physical loop created by cabling. However It is quite acceptable to connect two or more cables between hubs, since these will be discrete rings.

# Soundweb™



This should be set (with the aid of the Max Gain button) during high ambient levels such that sensible operating levels, free of distortion etc. are maintained.

- **Max Gain** button  
Forces the gain to the maximum setting for set-up purposes. Illuminates when activated.
- **Speed** control  
Determines the speed at which the gain will change. Obtrusiveness will be minimised at slower speed settings, although responsiveness to sudden changes in ambient level will be reduced.
- **Gap Time** control  
Determines the amount of time the announcement channel must be 'silent' in order for the ambient channel to be sampled.  
In highly reverberant environments, a long gap time may be required to avoid false gain changes because of measuring the reverb tail of the announcement, rather than the ambient noise level. Use the Ambient Meter as a guide to how quickly the signal dies away after an announcement ends.
- **Gap Threshold**  
Determines the announcement input signal level below which the announcement channel signal must drop before it is considered to be in a gap, and thus allow ambient level sampling.  
Try setting the Threshold control 10dB or so above the idle noise of the announcement channel.
- **Gap LED**  
Informs the user when there is an announcement gap that is allowing ambient signal sampling to take place.
- **Bypass** button  
Removes the processor from the signal path.  
Use bypass to set up the nominal announcement level.

## Notes

The ambient microphone should be connected to a microphone input on a 9088 Signal Processor. The input gain should be adjusted to achieve a sensible operating level. When setting the Ambient Threshold control, the input gain should be taken into account.

The Ambient microphone should be positioned clear of non-representative sources of sound and, to prevent tampering, preferably a place not accessible to the public. In a large environment, several microphones could be used with a mixer object in Soundweb to get an average of the levels.

**! This object is capable of raising signal levels beyond the clipping point, so care should be exercised when using positive Maximum Gain values.**

**! It is recommended that a Limiter be used on the output of the Ambient Noise Compensator so that short term high-level signals are not allowed to pass through to the output.**



## COMPRESSOR

A fully featured compressor with the classic BSS 'progressive knee' sound, which produces a gentle ratio near the threshold becoming progressively more aggressive further into compression. An auto-release mode not only allows the release time to be related to the user-set attack time, but also varies this relationship depending on the nature of the program to give a very natural sounding result.

Two versions of the compressor are available, a single channel version, and a stereo version, where two independent audio channels are controlled by a single control panel, the sidechains being locked together to prevent stereo image shifts.

### Inputs and Outputs

The single channel compressor has one audio input and one audio output, the stereo version having two of each. If the sidechain property is switched on, an additional input is available, giving access to the control sidechain.

### Properties

#### Sidechain

A sidechain input can be made available so that an equaliser for example can be introduced to make compression frequency conscious. Any sidechain processing would normally derive its signal from the same source that is fed to the audio input of the compressor.

### Control Panels

- **Threshold** control  
Adjusts the level threshold above which compression will take place. Below this threshold, no compression will take place.
- **Ratio** control  
Adjusts the aggressiveness of compression.
- **Gain** control  
Adjusts out any gain anomalies.
- **Attack** control  
Adjusts the time it takes for the compressor to respond to signal levels above the threshold.  
Note that this control also affects the release time in 'Auto Release' mode.
- **Release** control  
Adjusts the time it takes for the compressor to recover after the signal level goes below threshold.  
Note that this control has no effect in 'Auto Release' mode.
- **Bypass** button  
Removes the compressor from the signal path.
- **Auto Release** button  
Automatically adjusts the release time optimally for the programme material.  
Note that the time constants are still dependent on the attack setting.

Soundweb™



# Soundweb™

- **Gain Reduction meter**  
Displays the amount of gain reduction being applied.

## Notes

! This object will cause audible distortion if the Attack and Release times are too fast since it will be trying to apply dynamic gain reduction to the instantaneous values of lower frequency waveforms.

! This object is capable of raising signal levels beyond the clipping point so; care should be exercised when using positive gain values.



## EXPANDER

Reduces the level of signals that fall below a threshold level.

### Inputs and Outputs

One audio input and one audio output.

### Properties

#### Sidechain

A sidechain input can be made available so that an equaliser (for example) can be introduced to make expansion frequency conscious. Any sidechain processing would normally derive its signal from the same source that is fed to the audio input of the expander.

### Control Panel

- **Threshold** control  
Adjusts the level threshold below which gain reduction will take place. Above this threshold no gain reduction will take place.
- **Ratio** control  
Adjusts the aggressiveness of expansion.
- **Attack** control  
Adjusts the time it takes for the expander to recover after the signal level goes above threshold.
- **Release** control  
Adjusts the time it takes for the expander to respond to signal levels which fall below the threshold.
- **Bypass** button  
Removes the expander from the signal path.

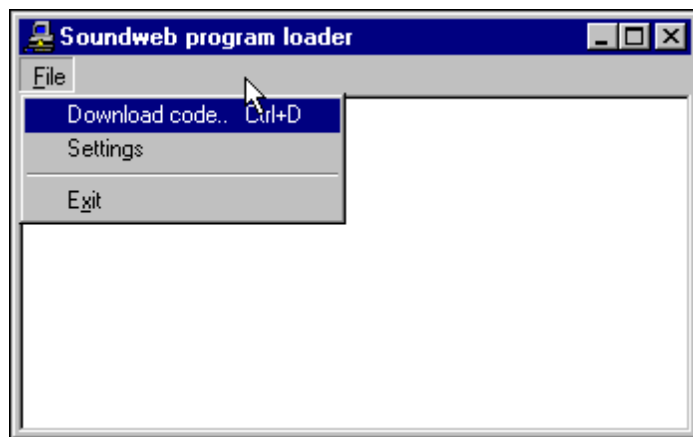

attenuate very quickly when the signal falls below threshold, set the Release control to a reasonably high value.

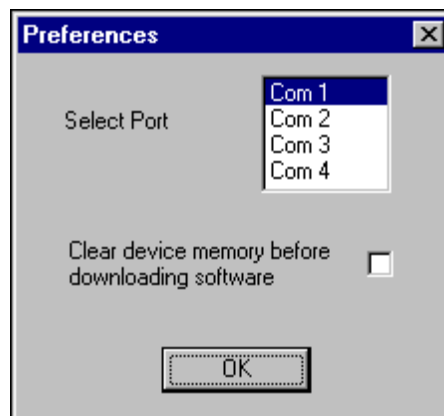

- **Q Gain** Reduction meter  
Displays the amount of gain reduction being applied.

### Notes

**! The expander can cause distortion at low frequencies when the Release control is set to low values. Unless you particularly need the expander to**

# Soundweb™





# Soundweb™



## DUCKER

Reduces the level of a (music) signal depending on the level of a control (mic) signal. Features an exponential attack and decilinear (linear dB per unit time) recovery for natural sounding fades.

### Inputs and Outputs

- One audio input for music.
- One audio input for the control (microphone) signal.
- One audio output.

### Control Panel

- **Threshold** control  
Adjusts the level threshold of the Mic signal above which gain reduction of the music signal will take place. Below this threshold, no gain reduction will take place.
- **Range** control  
Adjusts how 'deeply' the ducker will reduce the signal level of the music signal.
- **Duck time** control  
Adjusts the time it takes for the ducker to fade the music down when the Mic signal levels goes above threshold.
- **Hold** control  
Extends the 'ducked' phase to prevent 'chatter'.
- **Recover time** control  
Adjusts the time it takes the ducker to fade the music signal up when the mic signal level falls below the threshold.
- **Bypass** button  
Removes the ducker from the signal path.
- **Gain Reduction meter**  
Displays the amount of gain reduction being applied.

### Notes

**! This object will cause audible distortion if the Attack and Release times are too fast since it will be trying to apply dynamic gain reduction to the instantaneous values of lower frequency waveforms.**

# Soundweb™



## GATE

Reduces the level of signals that fall below a threshold level. Features an exponential attack and reverse exponential release, which helps to preserve the natural decay of the instrument or signal source, rather than imposing a synthetic envelope upon it.

### Inputs and Outputs

- One audio input.
- One audio output.

If the sidechain option is switched on an additional input is available, giving access to the control sidechain.

### Properties

#### Sidechain

A sidechain input can be made available so that an equaliser for example can be introduced to make gating frequency conscious. Any sidechain processing would normally derive its signal from the same source that is fed to the audio input of the gate.

### Control Panel

- **Threshold** control  
Adjusts the level threshold below which gain reduction will take place. Above this threshold, no gain reduction will take place.
- **Range** control  
Adjusts how 'deeply' the gate will reduce the signal level of below-threshold signals.
- **Attack** control  
Adjusts the time it takes for the gate to recover after the signal level goes above threshold.
- **Hold** control  
Extends the 'gate-open' phase to prevent 'chatter'.
- **Release** control  
Adjusts the time it takes for the gate to respond to signal levels which fall below the threshold.
- **Bypass** button  
Removes the gate from the signal path.
- **Manual Open** button  
Tests the attack/hold/release settings without having to manipulate the signal level.



- **Below Threshold meter**  
Displays the input signal level relative to the current threshold setting. Note that it is quite normal for this meter to show erratic readings when the threshold is set to very low values.
- **Open indicator**  
Shows when the gate is *not* reducing the signal level.

#### Notes

**! The gate can cause distortion at low frequencies when the Release control is set to low values. Unless you particularly need the gate to attenuate very quickly when the signal falls below threshold, set the Release control to a reasonably high value.**

# Soundweb™

## LIMITER

A two-stage protection limiter for protecting against amplifier clipping and loudspeaker damage. The first stage has ballistics suitable for long term protection whilst retaining transparency and minimising signal level loss. The second stage has much faster ballistics to protect against loudspeaker over-excursion.

### Inputs and Outputs

- One audio input
- One audio output.

### Control Panel

- **Threshold** control  
Adjusts the level threshold above which limiting will take place. Note that the system will track changes made to the main analogue output level control so that the limiter threshold setting relates to the level at the output terminals rather than the level at the output of the limiter. If any processing objects are connected between the output of the limiter and the main output however, the limiter threshold setting may be inaccurate, and the user must compensate for level changes which occur in these algorithms.
- **Attack** control  
Adjusts the time it takes for the limiter to respond to signal levels above the threshold.
- **Release** control  
Adjusts the time it takes for the limiter to recover after the signal level goes below threshold.

### Notes

An indication of limiting action can be achieved by applying a standard meter processing object to the *input* side of the limiter. If the attack and release settings of the meter are set to the same values as the limiter, and the meter reference set to the same value as the limiter threshold, then the meter will faithfully represent the limiting action of the limiter.

**! This object will cause audible distortion if the Attack and Release times are too fast since it will be trying to apply dynamic gain reduction to the instantaneous values of lower frequency waveforms.**

## LEVELLER

The leveller will attempt to keep the nominal level of the signal close to the desired target level set by the user, by gently changing the gain. An intelligent detection algorithm makes this processing object very free of side effects and easy to set up.

### Inputs and Outputs

- One audio input.
- One audio output.

### Properties

#### Voiceband Filter

Optionally included so that the levelling action favours frequencies in the human vocal range, helping to discriminate from noise signals.

### Control Panel

- **Target Output** control  
Adjusts the level which the leveller tries to maintain. The more positive the value, the higher the output level will be.
- **Ratio** control  
Adjusts the aggressiveness of levelling. Lower values allow more tolerance; allowing the output level to differ more from the target level, which preserves more of the original dynamics of the signal at the expense of firm control over the level. Higher ratio values cause the output level to be more tightly 'driven' towards the target level.
- **Maximum Gain** control  
Determines how much gain the object is allowed to apply to bring a low level signal up to the target level. Higher gain values allow the leveller to add more gain when the signal level is low, but will also bring up the noise floor more.
- **Speed** control  
Adjusts the time it takes for the leveller to recover from high levels when low levels are encountered. Higher values make the recovery slower, so there are no sudden jumps in gain. Lower (faster) values allow the leveller to track and counteract rapidly decreasing levels.
- **Bypass** button  
Removes the leveller from the signal path.  
! WARNING - significant changes in signal level can be caused by this control.
- **Threshold** control  
Determines the lowest input level that the Leveller will attempt to correct. The setting of this control is critical to the leveller's ability to discriminate unwanted noise from the wanted signal. Lower values will allow the leveller to 'pull-up' lower level signals, but will also make it more prone to activate on noise signals. Note that the intelligent detection algorithm helps to prevent noise signals from triggering levelling action even when they are above the threshold level, (if the leveller does not recognise them as vocal sig-

# Soundweb™



nals).

- **Active LED**  
Shows when the intelligent detector is allowing levelling action to take place. This is used along with the Threshold control to confirm that noise signals do not activate the detector, but wanted signals do.
- **Gain meter**  
Displays how much adjustment the leveller is applying to the signal.

#### Notes

An expander connected on the input side of the leveller may be useful in aiding the leveller to discriminate noise signals from wanted signals.

**! It should be noted that this object is capable of raising signal levels beyond the clipping point, so care should be exercised when using large Maximum Gain values.**

**! It is recommended that a Limiter be used on the output of the Leveller so that short-term high-level signals (which may not be attenuated by the Leveller), are not allowed to pass through to the output.**

## EQ - PARAMETRIC EQUALISER

A multi-function equaliser for corrective, or creative frequency response control. This may consist of a predetermined number of 'bands', each of which may have all parameters (i.e. Frequency, Bandwidth, Boost/Cut) controlled from a convenient graphics window.

### Inputs and Outputs

- One audio input.
- One audio output.

### Properties

#### Asymmetric Boost/Cut (Yes/No)

'Yes' produces cut curves which have the specified bandwidth at 3dB from the 0dB line (yielding non-complementary boost/cut shapes).

'No' produces cut curves which have the specified bandwidth 3dB from the tip of the bell (yielding complementary boost/cut shapes).

### Control Panel

Most of the manipulation may be done in the graphics window, which also shows the actual combined response of the filters. Empty squares (nodes) denote the current positions of the filters (in terms of frequency and boost/cut). A solid square (the selected filter node) denotes the currently selected filter, and any adjustments made to the controls will affect this filter. To create an additional EQ curve feature, click and drag a new filter up (or down) from the 0dB line.

Also it is now possible to copy the eq curve from a parametric eq window and impose it onto a new parametric eq using the Copy Settings command found in the right click menu. The band numbers will default to new bands numbered sequentially from 1.

Note that the right-click menu allows access to a filter 'bypass' function that allows an individual band of equalisation to be temporarily taken out of the signal path.

- **Filter Type** combo box  
Selects between bell, high-pass shelving or low-pass shelving shapes. May also be adjusted in a menu by right clicking on the filter node.
- **Slope** combo box  
Allows the cut-off slope to be adjusted (for shelving shapes only).
- **Frequency** control  
Adjusts the centre frequency of a bell filter, or the cut-off frequency of a shelving filter. May also be adjusted by moving the filter node in the graphics window horizontally using the mouse.
- **Width** control  
Adjusts the bandwidth of the filter (bell shape only). May also be adjusted by pressing the shift key and moving the filter node in the graphics window vertically using the mouse.
- **Boost/Cut** control.  
May also be adjusted by moving the filter node in the graphics window vertically using the mouse. Shift+double click will return all of the boost/cut settings to 0dB.

- **Bypass** button  
Removes the equaliser from the signal path



then it is necessary to delete the links, then re-construct map windows using the new parametric control panels. These can be linked much more reliably.

## STEREO PARAMETRIC EQUALISER

Identical to the Parametric Equaliser except with two audio inputs and two audio outputs. Applies identical filtering to two channels of audio.

## GRAPHIC EQUALISER

Simulates a conventional graphic equaliser for fast, intuitive frequency response control. It has the additional benefit of a 'Selectivity' control to determine the combining characteristics of the filters. An actual combined eq curve is available on the Response tab in the control window.

### Inputs and Outputs

One audio input and one audio output.

### Control Panel

- **Boost/Cut** fader per band.
- **Selectivity** control  
Adjusts how the bands interact.  
Lower selectivity settings produce a smooth overall response with some interaction.  
Higher settings reduce interaction but tend to produce a response with more ripple.
- **Flat** button  
Sets all the faders to 0dB.  
Note that this loses all the fader settings.
- **Bypass** button  
Removes the equaliser from the signal path.

## PHASE FILTER

A first order (single pole) all-pass filter for applying frequency-conscious phase shifting, whilst maintaining a flat magnitude response. The phase angle, and the frequency, at which the phase angle is to apply, are both adjustable.

### Inputs and Outputs

- One audio input.
- One audio output.

### Control Panel

- **Frequency** control for adjusting the frequency at which the phase angle is to apply.
- **Phase** control for adjusting the phase angle by which the signal is to be shifted at the frequency set by the Frequency control.

## HIGH PASS FILTER

Removes low frequencies, or for use as a single band crossover for creating feeds for high-frequency drivers.

### Inputs and Outputs

- One audio input.
- One audio output.

### Properties

#### Max Slope (24/48)

The maximum cut-off slope can be adjusted so that resources are not wasted in allowing for high-slope filters (such as 48dB/Octave) in applications where gentler, and less resource hungry slopes are acceptable. Note that regardless of what the maximum is set to, the control panel will always allow lower slopes to be selected at any time.

### Control Panel

- **Frequency** control  
Adjusts the high-pass frequency.
- **Filter Type** combo box  
Selects the filter shape (or crossover alignment) and cut-off slope.
- **Bypass** button  
Removes the filter from the signal path.

## LOW PASS FILTER

Removes high frequencies, or for use as a single band crossover for creating feeds for sub-bass drivers for example.

### Inputs and Outputs

- One audio input.
- One audio output.

### Properties

#### Max Slope (24/48)

The maximum cut-off slope can be adjusted so that resources are not wasted in allowing for high-slope filters (such as 48dB/Octave) in applications where gentler, and less resource hungry slopes are acceptable. Note that regardless of what the maximum is set to, the control panel will always allow lower slopes to be selected at any time.

### Control Panel

- **Frequency** control  
Adjusts the low-pass frequency.
- **Filter Type** combo box  
Selects the filter shape (or crossover alignment) and cut-off slope.
- **Bypass** button  
Removes the filter from the signal path.

## FIR FILTER

A new filter processing object that can import mathematically created FIR filter coefficients exported from other applications as .csv (comma separated value) or .dat format files. The number of coefficients can be up to 50, 100, 200, 400 or 600. The import files are located using a dialogue box displayed by right clicking on the FIR filter object and selecting 'Import coefficients'.

## Building in fault tolerance

When building a large Soundweb system it is often necessary to build in some provision for accidental cable breaks.

In the example below, a voice alarm signal must be routed to the speakers at all times. In case of a cable break the microphone signal must be routed via a backup network cable so that it still reaches the speakers.

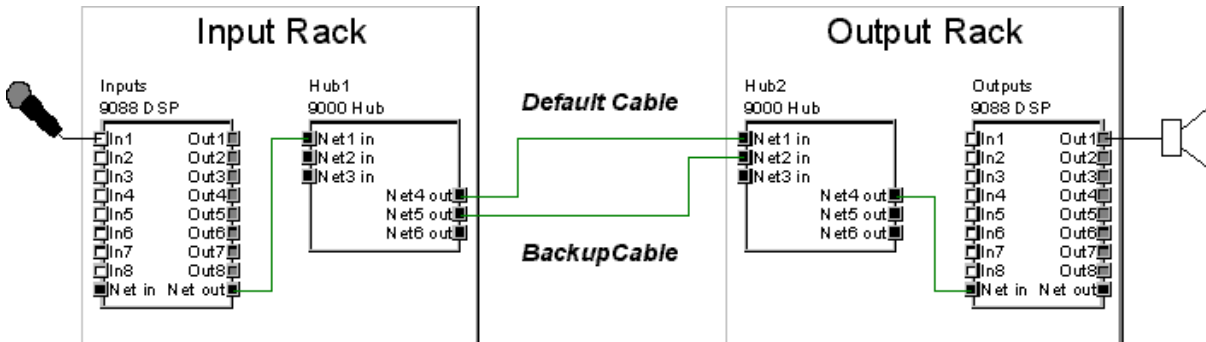

The two racks could be some distance apart, and are connected by two network cables, 'Default' and 'Backup'.

The signal is routed from 'Hub1' down both network cables to 'Hub2' where it is sent on to the outputs. Normally, 'Hub2' would route the signal from the 'default' cable to 'Outputs'. However, if the 'default' cable were accidentally cut, then it would route the signal from the 'backup' cable. The configuration in 'Hub2' looks like this:

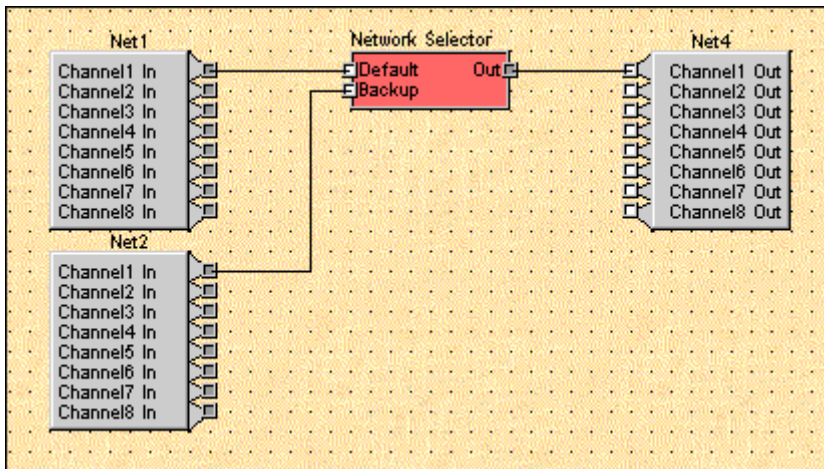

The **Network Selector** object has been set up to monitor the 'Net 1' port for a valid connection ('Net 1' has the 'default' cable plugged into it).

If the 'default' cable is intact, it will route audio from 'Net 1' to 'Net 4'.

However, if the cable is cut, it will switch to routing from 'Net 2' (the 'backup' cable).

Soundweb™

### iii Firmware Updates

# SOUNDWEB™

Firmware is the operating system code, or application software, that runs the hardware devices as stand alone units and also enables them to communicate with an external PC. The firmware is stored in a user updateable eeprom inside the device. A device cannot function properly without the correct firmware installed and possibly may not even function at all.

Occasionally, the software inside your Soundweb units will need to be updated to take advantage of new features, bug fixes and to retain proper compatibility with new versions of Soundweb Designer.

In these situations, the firmware 'loader' needs to be used. This application updates the data stored on the chips in your Soundweb units.

#### Locating the latest software

All new Soundweb devices come with the appropriate application code on the set-up disks or CD. This is also copied into the user's Soundweb directory during installation. So if Soundweb Designer is installed on the PC then there should be software available to update the hardware devices.

The embedded software is stored in '.dis' files - e.g. '9088v116.dis', this would be version 1.16 software for 9088 devices.

Alternatively, the 'latest' software can be found on the BSS Audio web site:

[www.bss.co.uk](http://www.bss.co.uk)

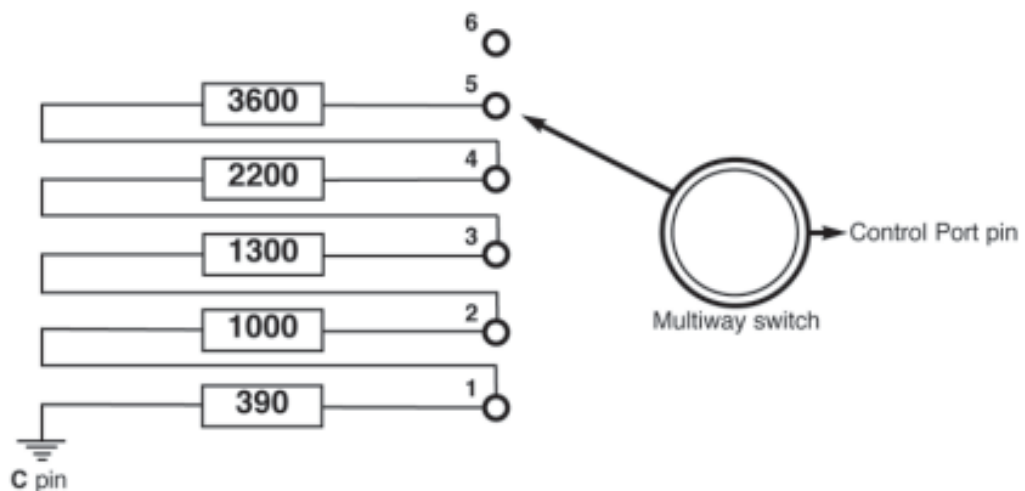
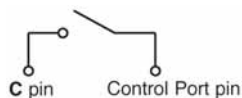

In the diagram the ability to switch between 6 states is available though the use of a five resistor ladder. The sixth state is achieved through an unconnected (open circuit) terminal.

The following table gives the resistor values in Ohms for each segment of the resistor ladder. To achieve the last state for a given number of states one less resistor is needed and the last terminal is open circuit / not connected (NC).

<b>States:</b>	<b>3</b>	<b>4</b>	<b>5</b>	<b>6</b>	<b>7</b>	<b>8</b>	<b>9</b>
<b>1st resistor to ground</b>	820	560	470	390	300	270	220
<b>2nd resistor</b>	2700	1600	1200	1000	820	680	560
<b>3rd resistor</b>	NC	3300	1800	1300	1000	820	680
<b>4th resistor</b>		NC	3600	2200	1500	1100	910
<b>5th resistor</b>			NC	3600	2400	1600	1200
<b>6th resistor</b>				NC	3900	2400	1800
<b>7th resistor</b>					NC	3900	2400
<b>8th resistor</b>						NC	4300
-							NC

# Soundweb™

## How to Update the Firmware

To load the latest firmware into hardware from Soundweb Designer:

- 1 Select the Network view by pressing the  button on the status bar.
- 2 Go 'online'.
- 3 Ensure that all devices are 'found' correctly.

When going 'online' with the hardware, one of the following messages may be displayed:

*"The device <name> has old application software, which is too old to use the integrated loader. Please use 'loader.exe' in your Soundweb directory to download new application software to this device. See 'loader.txt' in the Soundweb directory for more details."*

This means that the code in the device(s) does not support the new *fast* loader that is built into Soundweb Designer software.

Use the **Loader.exe** application to update these devices first, see the next section for how to use this utility.

Once loaded with more up to date software, then the integrated loader in the Soundweb Designer software can be used to update the firmware in the future.

If you receive the following message:

*"Soundweb has detected that some of the devices need new application software. Would you like Soundweb to open the Software Loader dialog now?"*

This means that Soundweb has found devices that have out of date software, but which can be loaded with the new integrated loader.

In certain circumstances a Soundweb device may have completely lost or damaged application code; a state denoted by the leds on the front panel 'chasing' from one end to the other. Neither Soundweb Designer nor Loader.exe will be able to find the device on the network.

A second comms program is provided in the Soundweb installation folder called **BackupLoader.exe** in case of this rare instance.

## Loader.exe

When Soundweb Designer cannot use its integrated software loader to update the firmware in a device, a separate application called **Loader.exe** can be used to bring the device up to date.

### IMPORTANT NOTES:

Soundweb designer must be closed down before using the Loader.exe application.

The loading process must not be stopped or interrupted. This includes removing cabling, switching power off/resetting and closing the program loading window.

**Loading can take anything up to 20 minutes per 9088/9000 device. Do not begin loading unless there is sufficient time to complete the process.**

Instructions to use Loader.exe

- 1 Connect a PC to a Soundweb device serial port as normal. If more than one device needs updating this can be done through the network by connection to any device on the same network.
- 2 Loader.exe can usually be found from **Start Menu>Programs>Soundweb>Loader.exe**
- 3 Select **File>Settings** from the program loader window.
- 4 Check that the correct comm port is selected for the computer to Soundweb connection. "Clear device memory before downloading software" should normally be left unchecked as it will erase the current device name and any loaded design file.
- 5 Press **OK**
- 6 Select **File>Download code**.

The names of connected devices should be displayed in the 'Devices Found' window of the resultant dialogue box.

Further information about each device, e.g. id number and current embedded software version can be displayed by clicking the 'Details/Summary' button

# Soundweb™





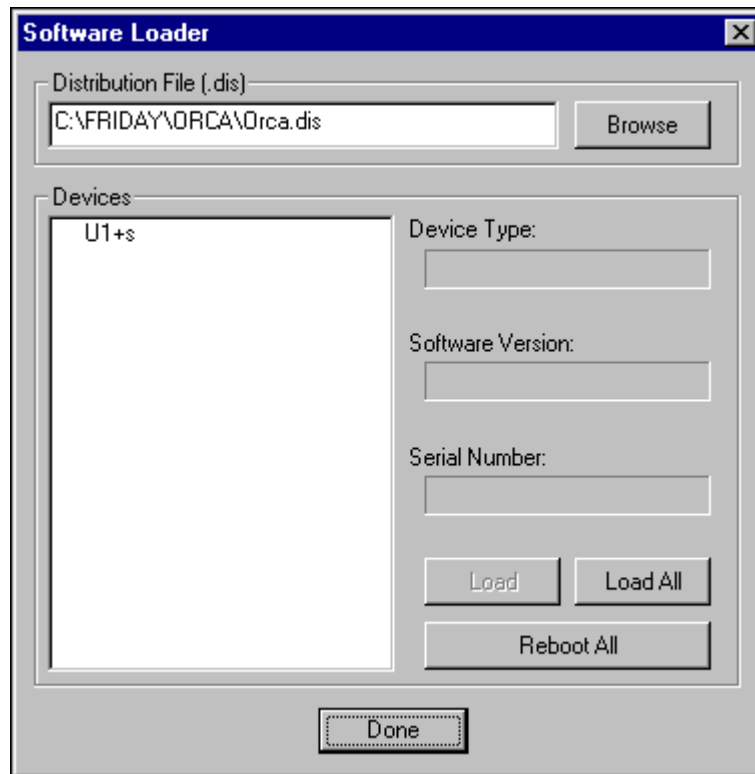

- 7 Click **'Browse'** to locate the latest .dis file appropriate for the device that is to be loaded. The software version and device type of the file will be displayed in the 'Program File Details' area of the dialogue box.
- 8 Select the device(s, of the same type, to be loaded in the 'Devices Found' window. Use the Control key to make multiple selections. The dialogue must be displaying the device names only, i.e. 'Summary' mode, in order to load multiple devices. Devices will be loaded sequentially.
- 9 Press **'Transfer'** to begin loading.  
The 'Progress' area of the dialogue box displays the status of the download.
- 10 When loading is complete press **'Done'**
- 11 Reset the Soundweb devices by cutting the power to them for a few seconds.
- 12 Restart Soundweb Designer.
- 13 Recompile the design files if necessary, go 'online' to the devices and reload.

Now that the devices are up to date this process can be handled in future by the faster integrated software loader built into Soundweb Designer.

**Troubleshooting:**

- **No devices are displayed in the 'Devices Found' window.**  
Click the '**Refresh**' button.  
Check connections and cabling.  
Close Loader.exe and restart.
- **Could not start Comms.**  
Check that Soundweb Designer is closed.  
Check that no other applications are using the selected comm port.  
Check that there are no other Soundweb comms applications open – these appear as an  icon in the windows taskbar.  
If there are more than one showing there will be a conflict on the ports. Press **CTRL+ALT+Delete**, select '**Comms**' and click '**End Task**'.
- **Soundweb Designer still reports that the device contains old software.**  
Reset the device by cutting power, waiting for a few seconds then reapplying power.
- **If loading is interrupted or stopped.**  
Do NOT reset or cut power to the device(s). The device may still be loadable provided it is not reset. Restart loading immediately.

If the device is reset with incomplete embedded software Loader.exe will not be able to function. In this case use **BackupLoader.exe**

# Soundweb™

**Software Loader**

Before using the integrated loader in Soundweb Designer, ensure that all devices with firmware too old to be loaded with it have been updated using the old application 'loader.exe'.

In the Network window:

- 1 Remain 'Offline'.
- 2 Select a device to load and go to the Software Loader window from the **Tools>Load Software** menu.

The Software loader dialog displays a list of all devices on the network. Clicking on a device in the list displays its information. The dialog also displays the path to the current distribution file. If the file is not the one which you wish to load, then click the **Browse** button to locate the latest '.dis' file.

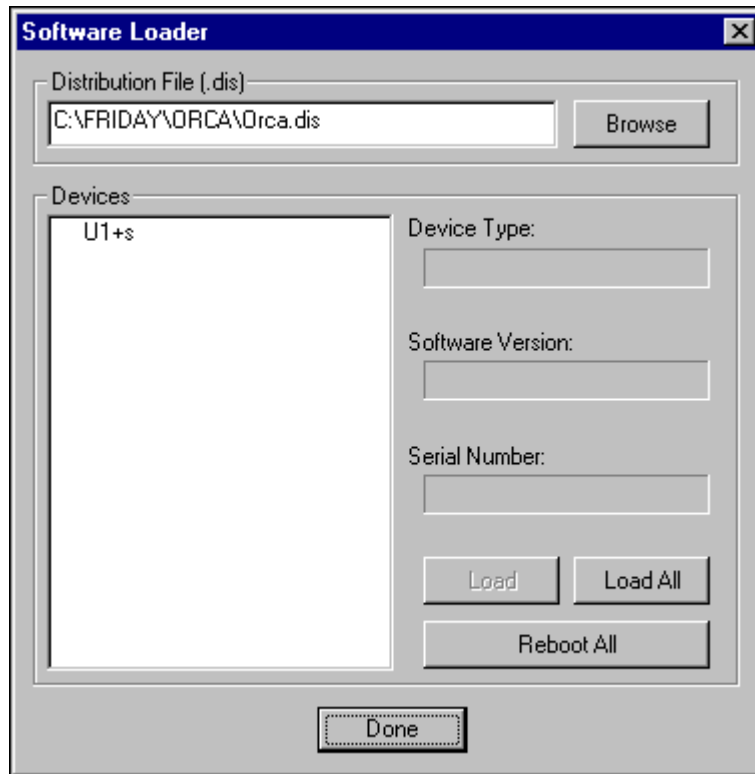

The Software Loader Dialog Box

Once the correct '.dis' file has been located, the devices displayed in the dialog are displayed in either grey or black.

- **Black** - the device *can* be loaded with the '.dis' file.
- **Grey** – the device *cannot* be loaded because it is the wrong type of device (i.e. a 9088 when the '.dis' file is for 9000s) or, it is already loaded with the correct '.dis' (denoted by a tick).



### 3 Click **Load All**

This loads all devices that are displayed **black** in the list.

You can also select devices by clicking in the list to select a device (click and drag to select a number of devices).

Clicking **Load** will load the highlighted devices only.

Once you have clicked **Load** or **Load All**, Soundweb will start loading the devices. This dialog is displayed to show the progress of the load.

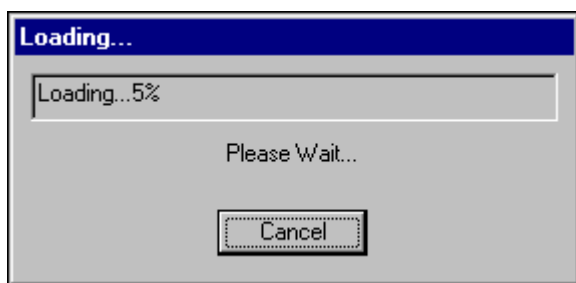

This takes a few minutes..

Once loading is 100% complete, Soundweb prompts if the devices should be *reset*. Resetting the devices causes them to use the new software that has been loaded.

This takes about 10 seconds.

If you choose not to reset the devices, the new software will not be run until the user powers the boxes down and then back up again.

**! If at any stage Soundweb designer reports that it had problems loading devices, the user should *not* power down devices.**

**! If Soundweb persistently fails to load devices then the user should contact BSS Audio for further assistance.**

# Soundweb™

### BackupLoader.exe

A second comms program (BackupLoader.exe) is provided in the Soundweb installation folder in case a Soundweb device has lost or damaged application code; a state denoted by the leds on the front panel 'chasing' from one end to the other.

#### IMPORTANT NOTES:

Soundweb Designer must be closed down before using BackupLoader.

**BackupLoader uses different files from those used by Designer and Loader. The identifying name is the same but the file extension is .A21 instead of .dis.**

To use BackupLoader.exe

- 1 Connect a PC to the front serial port of the 9088/9000 device.
- 2 Launch BackupLoader.exe from **StartMenu>Programs>Soundweb>BackupLoader.exe**

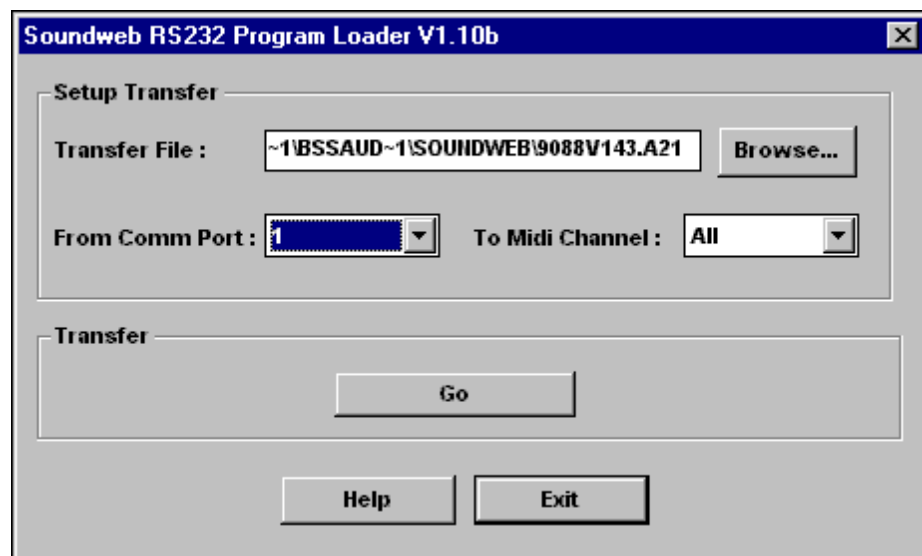

- 3 Select the appropriate .a21 file by clicking the '**Browse**' button and locating these files in the Soundweb directory.
- 4 Select the comm port that the PC uses to communicate to the Soundweb network normally within Designer.
- 5 Ignore the '**Midi Channel**' option.
- 6 Press '**Go**' to begin loading the device. A 'Loading...' window will appear.
- 7 Once loading has completed, the device needs to be reset by cutting and reapplying power.

## 9014 OPTICAL FIBRE INTERFACE

Power Supply:	12-24V DC, <5VA
Connector:	Phoenix screw terminal or 2.4mm inline barrel connector
Network:	Single RJ-45 Can be input node or output node - auto-sensed (no setup required)
Fibre Connections:	Snap-in SC fibre input Snap-in SC fibre output
Fibre cable:	Multimode 62.5/125um or Multimode 50/125um
Optical Power Budget:	10dB
Indicators:	Power led Fibre Link Active led Network cable present led
Max fibre length	2000 metres/6550 feet/1.2 miles
Dimensions	5.3" x 5.5" x 1.4" (135mm x 139mm x 36mm)

Three 9014 devices can be mounted side-by-side in a 1U panel (available from BSS Audio). The panel can be used to rackmount a single or two 9014 devices if required, and can be fitted with the Z-999-PSU in this case.

BSS Audio offer a universal AC input +24V DC power supply (Z-999-PSU).

**Soundweb™**

## Glossary of terms

---

**SOUNDWEB**  
™

### Audio processing object

The representation of a piece of DSP software running in one of the devices which performs some processing on a piece of audio. Displayed as a box with a number of input and outputs, it also has a control panel available to it.

### Chatter

Describes the effect caused in a noise gate by a borderline threshold signal that triggers the gate to open and close intermittently.

### Compiling

The process of validating a configuration that you have designed, and translating it into a form of data suitable for being loaded into a Soundweb device.

### Configuration

A set of information for a Soundweb device, which includes the list of audio processing objects and their interconnection, also a list of hardware control surface objects, implemented in the device.

### Control panel

Refers to a map window that contains control surface objects but no device icons. A control panel may be designed by the software (a default panel) or by you (a custom panel).

### Control surface object

Any item which can be used to adjust settings in a Soundweb network. This could be a hardware control surface object (such as a physical knob or switch), or a software control surface object in a map window, e.g. a fader or rotary.

### Device

A physical piece of audio processing equipment (hardware) which can be controlled by Soundweb designer, such as a Soundweb 9088 Networked Signal Processor.

### Dialogue Box (Dialog box)

A window that appears on screen either when called by a function, as a result of an error or, to warn a user about an action or possibility. A dialogue box usually needs some user input, whether to 'ok' or 'cancel' or to choose an option, in order to dismiss the window.

### Map window

A window depicting part or all of the system. It may contain icons representing devices, control surface objects, and/or miscellaneous graphic items such as lines and bitmaps.



**Network window**

A window indicating the status of the physical devices on the system, and comparing this against the list specified in the system design file.

**Object**

The software representation of something on the network. There are principally three types of object: a control surface object (such as a switch or fader), a device (representation of hardware) and an audio processing object (such as an audio delay or compressor).

**Offline**

The state in which the PC is not connected to a network of devices. The network being worked on is a notional one for the time being until the PC is plugged into a real network.

**Online**

The situation in which the PC is connected to the network of devices, and can be used to control them directly.

**Parameter**

A numeric quantity which affects signal processing. For example, the amount of boost or cut in a filter is a parameter, as is the gain of a mixer stage or the threshold of a compressor.

**Parameter Preset**

A collection of parameter value information for the system, containing a selected set of parameter settings for the audio processing objects for one or more devices.

**Preset**

A collection of set value information for the system. This contains the configuration to be selected for each device, a list of parameter settings for the audio processing objects, the utilisation of any hardware control surface objects and the set of control panels to be displayed when the Preset is activated.

**System Design File**

The PC file (with DOS extension .SDF) which stores all of the information about your design.

**Zone**

An assigned area, (e.g. lounge, main room, booth), that has separate controls for volume level (and maybe other parameters) from the main system.













## Soundweb Designer Keyboard Shortcuts

---

# SOUNDWEB DESIGNER

These keyboard shortcuts are also displayed in the menus themselves.

	New design file
	Open existing design file
	Save design file
	Print
	Cut
	Copy
	Paste

	Design mode
	Operate mode
	Move the selected object

	Next window
	Full Screen mode

**SHIFT & Double click - Set control to default value**



Copies of installation guides as supplied with associated Soundweb hardware.

<b>Soundweb™ 3088 lite Signal Processor</b>	<b>219</b>
<b>Soundweb™ 9000iis Network Hub</b>	<b>225</b>
<b>Soundweb™ 9008iis Output Expander</b>	<b>231</b>
<b>Soundweb™ 9010 Programmable Remote Control</b>	<b>239</b>
<b>Soundweb™ 9012 Wall Panel</b>	<b>247</b>
<b>Soundweb™ 9014 Fibre Interface</b>	<b>250</b>
<b>Soundweb™ 9088 Networked Signal Processor</b>	<b>255</b>
<b>Soundweb™ 9088iis Networked Signal Processor</b>	<b>262</b>
<b>Soundweb™ 9016 Video/Audio Matrix Switcher</b>	<b>270</b>
<b>Soundweb™ 9026 Audio Matrix Switcher</b>	<b>278</b>

## Important Safety Information - Read this carefully

This equipment has been tested and found to comply with the following European and international Standards for Electromagnetic Compatibility and Electrical Safety:

Radiated Emissions (EU):	EN55013	(1996)
RF Immunity (EU):	EN55013-2	(1996)
Electrical Safety (EU):	EN60065	(1998)
Electrical Safety (USA):	UL6500/ETL	(2000)
Electrical Safety (CAN):	CAN/CSA-E60065-00	(1994)



**Before using the apparatus, read these instructions. Follow all instructions, heed them and keep them in a safe place.**

- \* Clean only with a dry cloth.
- \* Do not block any of the ventilation openings. Install in accordance with the manufacturers instructions.
- \* Do not place objects filled with liquid on this apparatus.
- \* Do not defeat the safety purpose of the grounding type plug. A grounding plug has two blades and a third grounding prong. The third prong is provided for your safety. When the provided plug does not fit into your outlet, consult an electrician for replacement of the obsolete outlet.
- \* Protect the power cord from being walked upon or pinched, particularly at plugs, convenience receptacles and the point where they exit from the apparatus.
- \* Only use attachments/accessories specified by the manufacturer.
- \* Unplug this apparatus during lightning storms or when not in use for a long time.

**WARNING - TO REDUCE THE RISK OF FIRE OR SHOCK, DO NOT EXPOSE THIS APPARATUS TO RAIN OR MOISTURE.**

**DO NOT REMOVE COVERS. NO USER SERVICEABLE PARTS INSIDE - REFER SERVICING TO QUALIFIED SERVICE PERSONNEL.**

### **THIS EQUIPMENT MUST BE EARTHED.**



DO NOT EXPOSE  
TO RAIN OR MOISTURE



NE PAS EXPOSER A  
LA PLUIE NI A L'HUMIDITE

**IT SHOULD NOT BE NECESSARY TO REMOVE ANY PROTECTIVE EARTH OR SIGNAL CABLE SHIELD CONNECTIONS TO PREVENT GROUND LOOPS. ANY SUCH DISCONNECTIONS ARE OUTSIDE THE RECOMMENDED PRACTICE OF BSS AUDIO AND WILL RENDER THE EMC OR SAFETY CERTIFICATION VOID.**

For continued compliance with international EMC regulations, it is important that all cables be screened, and connected as follows:

- Audio cable screens to their 3088 connector ground.
- Control cable screens to the ground screws adjacent to the connector.

## Mechanical Installation

If the unit is likely to undergo extreme vibration through extensive road trucking and touring, it must be supported at the rear and/or sides to lessen the stress on the front mounting flange. Use either a ready-built rack tray or mount the 3088 unit between other units. Damage caused by insufficient support is not covered by the warranty.

To prevent cosmetic damage to the front panel finish, use protective plastic cups under the rack mounting bolts.

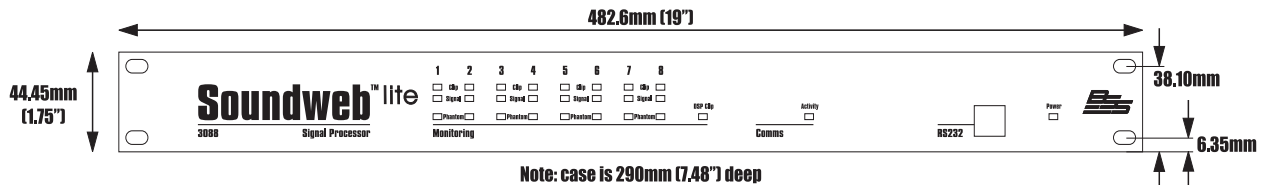

## Front Panel LED Functions

### Input Monitoring

Each channel has 3 LED indicators showing:

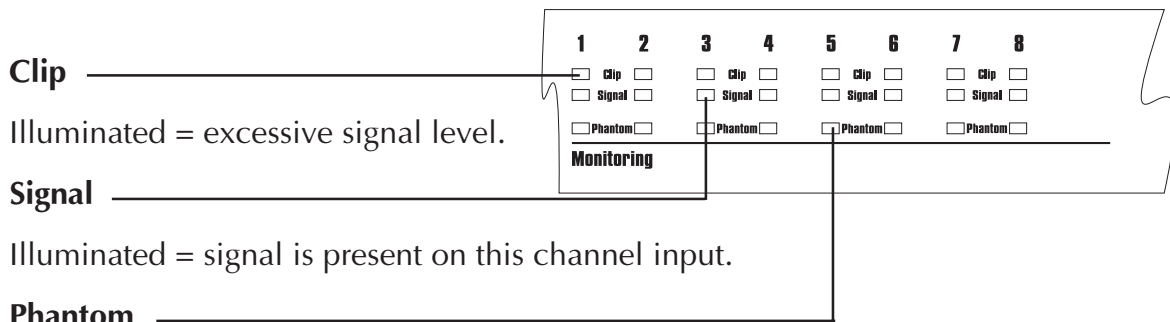

**Clip**  
Illuminated = excessive signal level.

**Signal**  
Illuminated = signal is present on this channel input.

**Phantom**  
Illuminated = phantom power is active for this Mic channel.

Scrolling from right to left = recovery mode, the device's firmware needs reloading.



**DSP Clip**  
Illuminated = indicates that the processed signal is clipping internally.

### Comms



**Activity**  
Flashing Yellow = indicates data transfer. The flashing is not regular, but is dependent on the rate of transfer.

Flashing Red = indicates bad data.

**Power**

illuminated = indicates that the power supply is functioning.

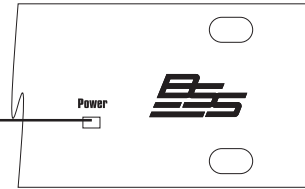

**Rear Panel Details**

**Audio & Control connectors**

3088 audio and control connections are via Klippon (also known as BL, Phoenix or Combicon) pluggable terminal block connectors.

12 x 6-way female Klippon connectors are supplied for making these connections.

For audio and network cables and looms, see the Product Overview catalogue from: Direct Cable Systems Ltd.

Tel: (020) 7485 0899 [www.directcable.co.uk](http://www.directcable.co.uk)

Neutricon-Neutricon tour grade network cable. P/N 1 50001

Phoenix-XLR audio cable P/N 1 00521

**Audio & AES/EBU Input and Output wiring convention**

Soundweb products provide cable shielding “back from the destination” to eliminate ground loop problems. Therefore, the shield (S) connection on an input is grounded, whereas the shield connection on an output is floating (although connected via an internal network to ground for EMC compliance).

**Balanced** wiring - The convention for balanced wiring (2-core plus shield) is:

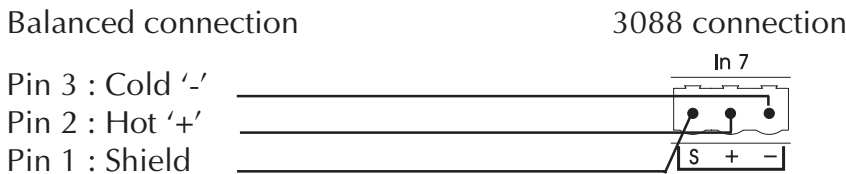

This wiring can also be applied to the AES digital interface card.

**Unbalanced** wiring (analogue audio only) - The convention for unbalanced wiring to the inputs (1-core plus shield) is:

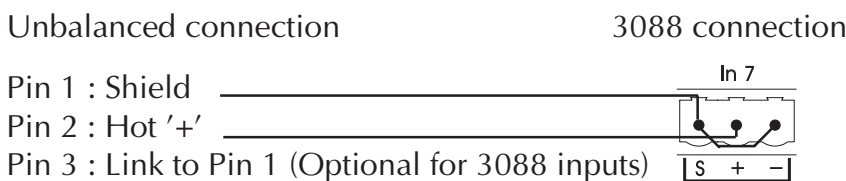

## Mains inlet

IEC power connector, for connection to mains supply (100-270V AC, 50/60Hz).

## Mains fuse holder

Requires a 20mm T1AL type fuse. Do not replace with anything other than the recommended fuse.

## Aux. RS232

An alternative connection for a control PC, modem or AMX/Crestron type panel. This port works at up to 115200bps. Note that AMX panels only currently connect at 38400bps.

### Pinouts

1 -DCD	6-DSR
2-RX	7-RTS
3-TX	8-CTS
4-DTR	9-N/C
5-GROUND	

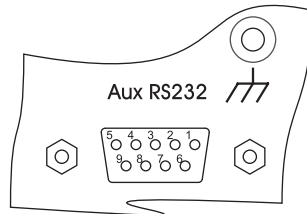

## Control Inputs

Used to connect switches or potentiometers, e.g. 9012 selector wallplate (Part no. Z-SW9012). Looking at the control port connector (on the back of the unit), there are two common (ground) connections “C” to the left of the eight CONTROL INPUTS and, two software assignable reference voltage outputs “R” to the right.

The control ports now have two modes of operation. In Soundweb Designer’s Control Ports window these are labelled “2-wire” and “3-wire”.

### 2-wire mode

In this mode the eight CONTROL INPUTS are internally “pulled up” to +5V DC via a 4.7kOhm resistor. Therefore, no external voltage source is needed to create contact closure to ground for switches such as mute buttons or, resistance to ground (for other multi-state or continuous controls such as Parameter Presets or faders).

See the Soundweb Designer help for a table of resistor values for use with Parameter Presets or source selectors.

Two “common” ground connections are provided using the two “C” connectors to the left of the CONTROL INPUTS.

A 47kOhm-log potentiometer (Part no. DM10018) connected between a control input and common will allow parameters to be controlled linearly.

### 3-wire mode

This mode allows the use of linear pots or faders for continuous controls. A pot would be wired as a potential divider with the top of the track connected to the reference output “R”, the wiper to a control input and the bottom of the track to a common “C”. For good

performance pots with track resistance between 10 and 100kOhms are recommended.

## **Logic Outputs**

Used to connect 'tally' indicator LED's or relays.

There are eight standard LOGIC OUTPUTS which produce 0V or +5V DC via an internal 440 Ohm resistor and two internally connected common (ground) connections "C".

An LED connected between one output (Anode, A) and common (Cathode, K) will illuminate when the logic output is activated, without requiring any external current limiting resistor.

A high sensitivity relay (such as a reed relay) may be driven by connecting four outputs in parallel. This arrangement will develop 4V across a 500Ohm coil, providing that all four outputs are made logic 1 simultaneously.

## **OPTO Output**

In addition to the eight standard logic outputs, there is an isolated output, which fails safe (open circuit) if the unit becomes faulty.

This is effectively the collector-emitter of a transistor (which may be thought of as a switch), in series with a 220-Ohm protection resistor. In conjunction with an external DC power source (max 80V), this may be used to drive various loads such as relays.

## Control Inputs and Logic Outputs connection diagram

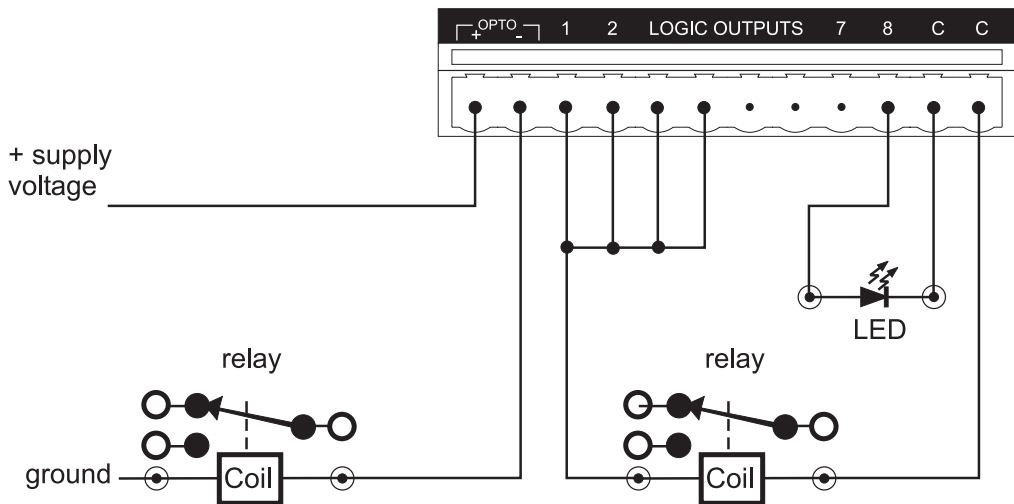
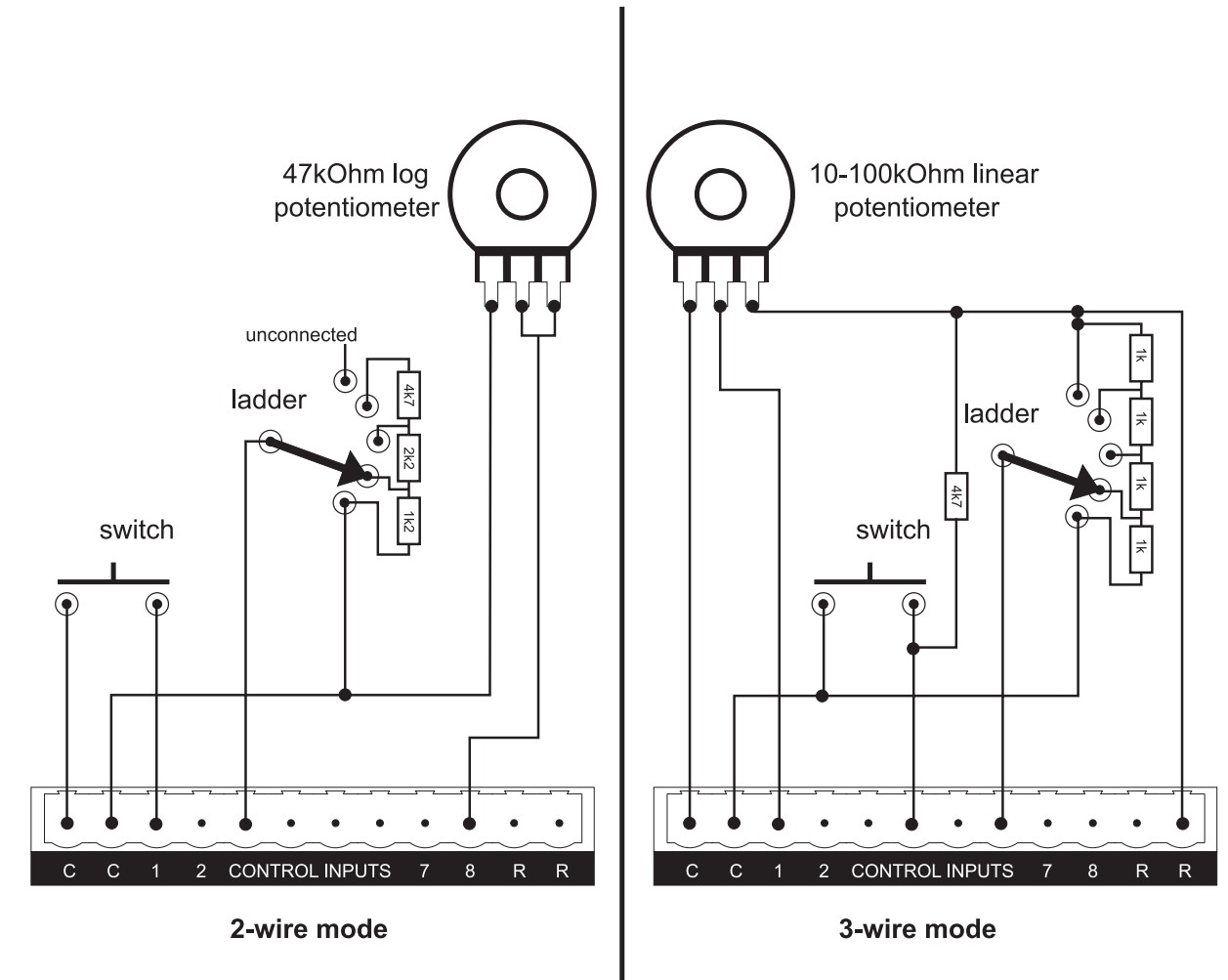



## Soundweb™ 9000iis Installation Guide

## Regulatory Information

An example of this equipment has been tested and found to comply with the following European and international Standards for Electromagnetic Compatibility and Electrical Safety:

Radiated Emissions (EU):	EN55022B	(1994)
Immunity (EU):	EN50082/1	(1992) RF Immunity, Fast Transients ESD
Mains Disturbance (EU):	EN61000/3/2	(1995)
Electrical Safety (EU):	EN60065	(1993)
Radiated Emissions (USA):	FCC part 15 Class B	
Electrical safety (USA):	UL6500	



## Important safety information - read and follow

**Do not remove covers. No user serviceable parts inside, refer servicing to qualified service personnel.** For continued compliance with international EMC regulations, it is important that all cables be screened, and connected as follows: Control cable screens to the ground screws adjacent to the connector. Network cables should be of type CAT.5. **WARNING: This equipment must be earthed.** It should not be necessary to remove any protective earth or signal cable shield connections to prevent ground loops. Any such disconnections are outside the recommended practice of BSS Audio, and will render the EMC or safety certificate void. Do not defeat the safety purpose of the polarised/grounding plug. A polarised plug has 2 blades, one wider than the other. A grounding type plug has 2 blades, and a **third** grounding prong. The third prong is provided for your safety. When the provided plug does not fit an electrical outlet, consult a qualified electrician.



**No-user serviceable parts compartment warning.**

## Mechanical Installation

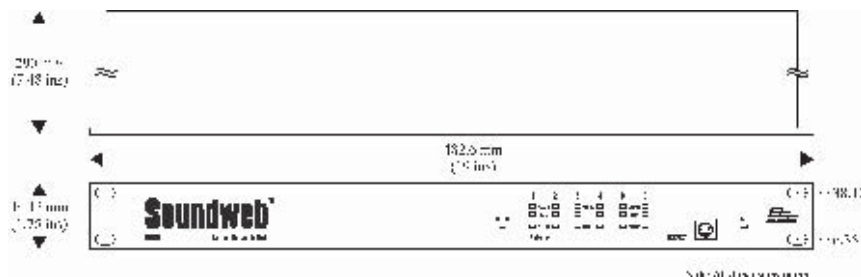

If the unit is likely to undergo extreme vibration through extensive road trucking and touring, the unit must be supported at the rear and/or sides to lessen the stress on the front mounting flange. The necessary support can generally be bought ready-built as a rack tray, or the 9000 unit can be mounted between other units. Damage caused by insufficient support is not covered by the warranty. To prevent cosmetic damage to the front panel finish, use protective plastic cups under the rack mounting bolts.

## Front panel LED functions

### Network monitoring

Each node has 3 LED indicators showing:

#### Network

##### Master

*Flashing* - The network is initialising. If it does not cease to flash, there is a cabling fault - either a double ring error or a problem with one of the cable connectors.

*Steady* - This node has become the hub master for this unit. It is either directly connected to the network master, or connected to a ring which contains the network master.

*Off* - This node is clienting to the master's clock.

##### Sync

*Steady* - This indicates the presence of a valid network connection on this node.

*Flashing* - There is a problem with the incoming network signal - possibly the maximum cable length has been exceeded.

##### Activity

*Flashing* - This LED indicates data transfer. The flashing is not regular, but dependant on the rate of transfer.

The node 1 light also indicates RS232 serial messaging in the same manner.

##### DSP Clip

*Illuminated* - Indicates that the signal is clipping internally.

##### Power

*Steady* - This indicates that the power supply is functioning.

## Front panel details

### RS232

Used to connect one of the 9000 units in the network to a controller PC, which can then communicate with any device on the network. The pin out is:

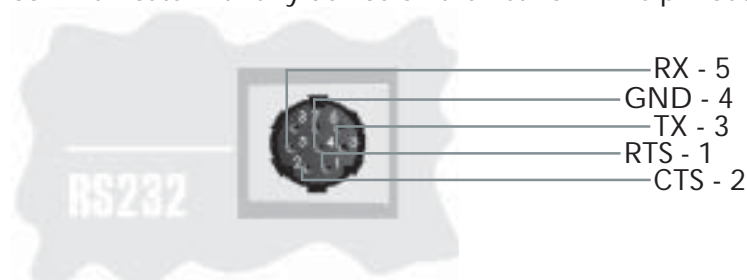

### Control cable wiring details

All control connections to the 9000 are via Klippon pluggable terminal block connectors (also known as BL, Phoenix or Combicon). 6-way female Klippon connectors are supplied for making these connections.



## Rear panel details

### Mains inlet

IEC power connector for removable mains supply.

### Fuse holder

Mains fuse - requires a 20mm T1A type fuse.

### Aux RS232

This is for connection to a PC, modem, AMX panel or other RS232 controller. A control PC may be connected here, or via the front panel RS232 port. The pin out is as follows:

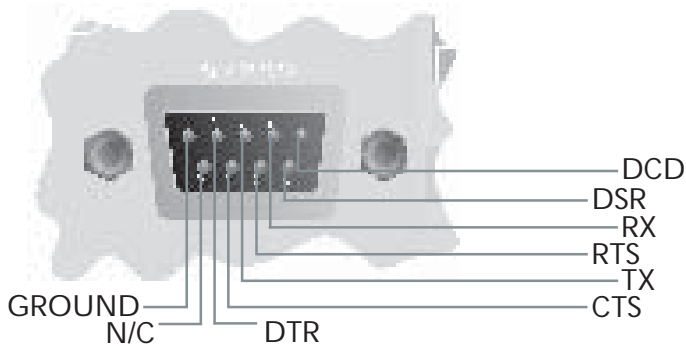

An example system showing possible connection set-ups.

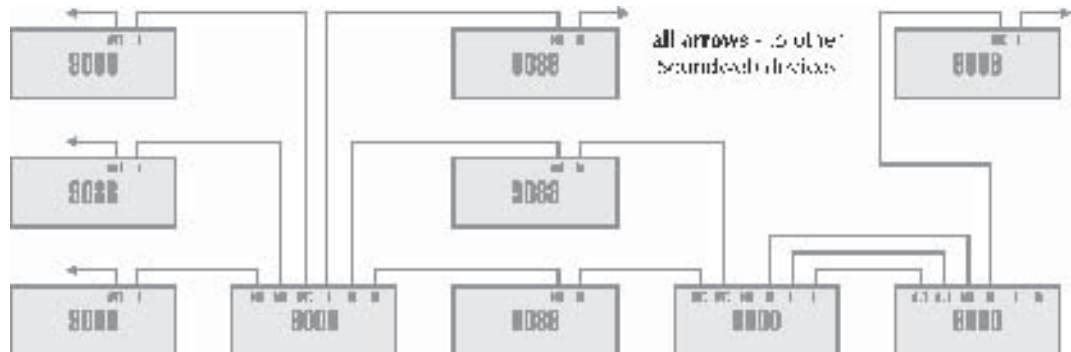

Each network socket on the SW9000 can be thought of as a terminal device node. The unit allows each branch of the network connected to each socket to act as a 'ring'. Note that several cables may be used to interconnect two or more SW9000 devices, and so increase the number of audio channels that may be passed between them. The connecting cable is CAT. 5 network cable, terminated with RJ45 connectors, with all 8 cores wired straight through.

Note that the twisted pairs in any CAT.5 network cable must be wired to the following pin pairs at each terminal (see page 8 for diagram):

1 (White-Orange) with 2 (Orange)    3 (White-Green) with 6 (Green)    4 (Blue) with 5 (White-Blue)    7 (White-Brown) with 8 (Brown)

**Note:** There must be at least **1 (one)** 9088 unit in the network, with only one node connected. For example, if you wish to have two 9000 units and one 9088 unit in the same network, the 9088 **must** be a terminal device.

## Control Inputs

Used to connect switches or potentiometers to the 9000. These eight inputs are internally 'pulled up' to +5V DC via a 4.7kOhm resistor, so no external voltage source is needed. Four common (ground) connections are provided (all connected together internally). A 47kOhm log potentiometer connected between one input and common will allow parameters to be controlled linearly. Alternatively, a switch may be connected between an input and common, or a multiway switch may be connected to several inputs with the wiper connected to common.

## Logic Outputs

Used to connect the 9000 to 'tally' indicator LEDs or relays. There are eight standard logic outputs which produce 0V or +5V DC via an internal 440 Ohm resistor. Two common (ground) connections are provided (connected together internally). A LED connected between one output (Anode, A) and common (Cathode, K) will illuminate when the logic output is activated, without requiring any external current limiting resistor. A high sensitivity relay (such as a reed relay) may be driven by connecting four outputs in parallel. This arrangement will develop 4V across a 500 Ohm coil, providing that all four outputs are made logic 1 simultaneously.

## Opto output

In addition to the eight standard logic outputs, there is an isolated output, which fails safe (open circuit) if the 9000 becomes faulty. This is effectively the collector-emitter of a transistor (which may be thought of as a switch) in series with a 220 Ohm protection resistor. In conjunction with an external DC power source (max 80V), this may be used to drive various loads such as relays.

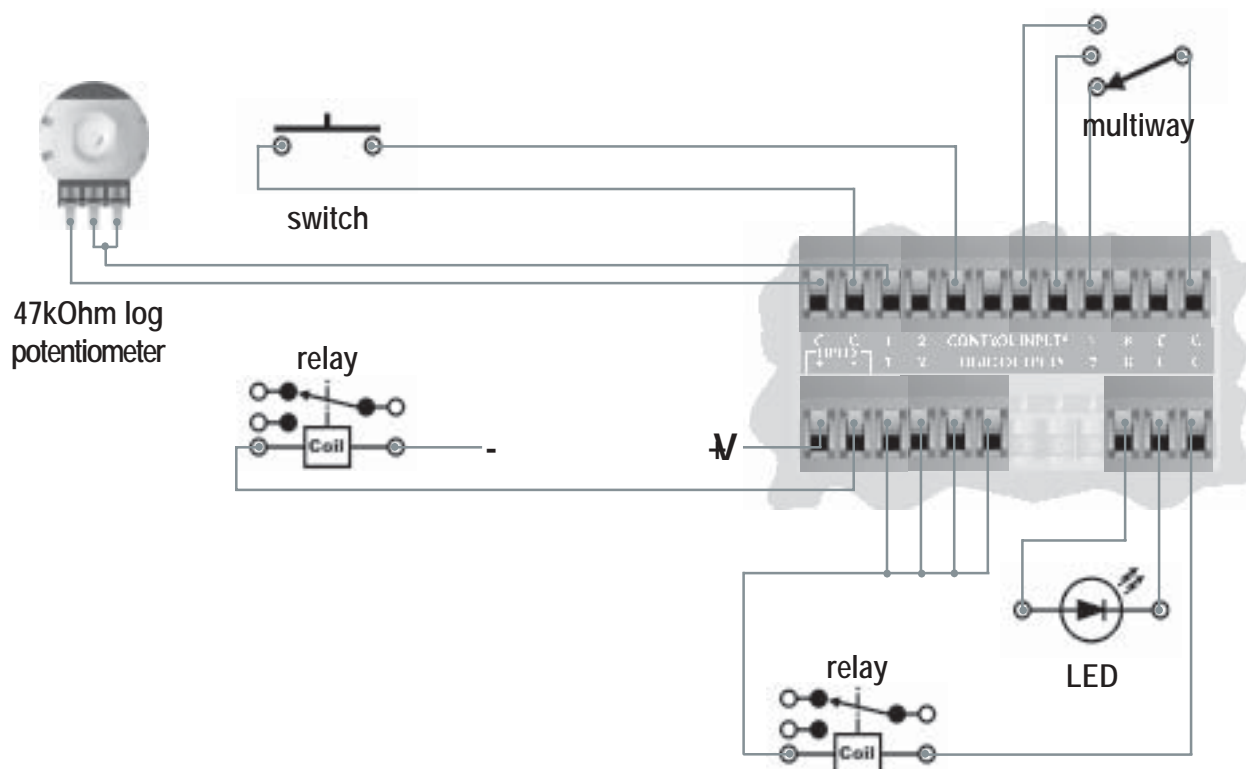

## Technical specifications

### General

Maximum network cable length	300m/1000ft
Power consumption	<35VA
Mains Voltage	85-270V 50/60Hz

### Control ports

Logic output voltage	0 or +5V unloaded
Logic output impedance	440 Ohm
Opto output series impedance	220 Ohms (isolated)
Control input voltage	0 to 4.5v
Control input impedance	4.7kOhms to +5V
Opto Output current	14mA max
Opto output withstanding voltage (off)	80V max.

## Network cable wiring

Wiring convention for all CAT.5 cables.

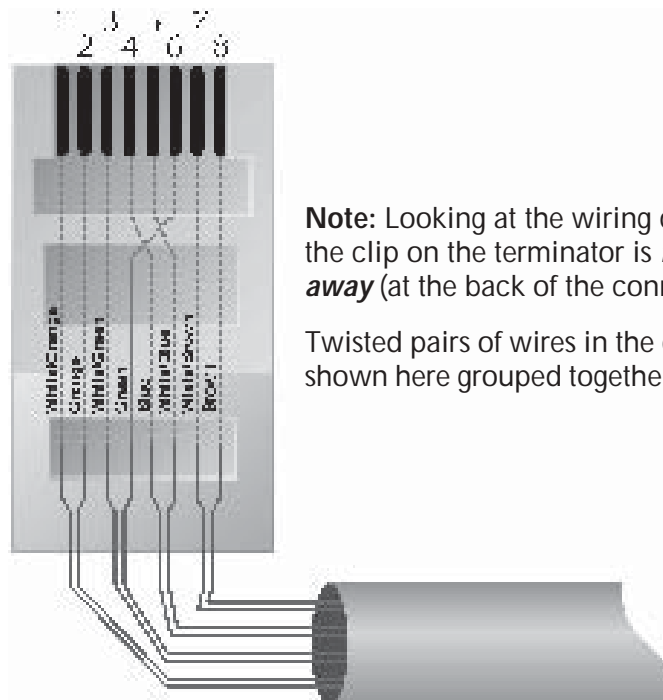

**Note:** Looking at the wiring diagram, the clip on the terminator is **facing away** (at the back of the connector).

Twisted pairs of wires in the cable are shown here grouped together.

# **Soundweb™**

---

**9008      Networked Signal Processor**

# **Installation Guide**



### Regulatory Information

An example of this equipment has been tested and found to comply with the following European and international Standards for Electromagnetic Compatibility and Electrical Safety:

Emissions (EU):	EN55013	(1990)
Generic Immunity (EU):	EN50082-1	(1997)
Electrical Safety (EU):	EN60065+A11	(1993)
Electrical Safety (USA):	UL6500/ETL	(1996)
Electrical Safety (CAN):	CAN/CSA-E65/ETLc	(1994)
Radiated Emissions (USA):	FCC parts 15 Class B	



For continued compliance with international EMC regulations, it is important that all cables be screened, and connected as follows:

- Audio cable screens to their 9008 connector ground.
- Control cable screens to the ground screws adjacent to the connector.

Network cables should be of type CAT. 5

### IMPORTANT SAFETY INFORMATION

**Do not remove covers.**

**No user serviceable parts inside - refer servicing to qualified service personnel.**

**This equipment must be earthed.**

**It should not be necessary to remove any protective earth or signal cable shield connections to prevent ground loops. Any such disconnections are outside the recommended practice of BSS Audio and will render the EMC or safety certification void.**

### Mechanical Installation



If the unit is likely to undergo extreme vibration through extensive road trucking and touring, it must be supported at the rear and/or sides to lessen the stress on the front mounting flange. Use either a ready-built rack tray or mount the 9008 unit between other units. Damage caused by insufficient support is not covered by the warranty.

To prevent cosmetic damage to the front panel finish, use protective plastic cups under the rack mounting bolts.



## Front Panel LED Functions

---

### DSP Clip

*Illuminated* = indicates that the processed signal is clipping internally.



### Network

#### Master

*Flashing* = the network is initialising. If the led continues to flash for more than a few seconds, there is a cabling fault - either a double ring error or a problem with one of the cable connectors.

*Steady* = this unit has become the clock master for the network.

*Off* = this unit is clienting to an external master clock.

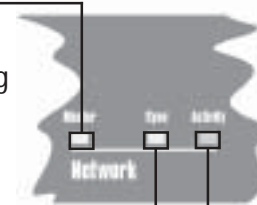

#### Sync

*Steady* = indicates the presence of one or more valid network connections.

*Flashing* = there is a problem with the incoming network signal - check connections and/or possibly the maximum cable length has been exceeded.

#### Activity

*Flashing Yellow* = indicates data transfer. The flashing is not regular, but dependent on the rate of transfer.

*Flashing Red* = indicates bad data and is usually caused by network faults. Check network connections, see Rear Panel details.

### Power

*Illuminated* = indicates that the power supply is functioning.

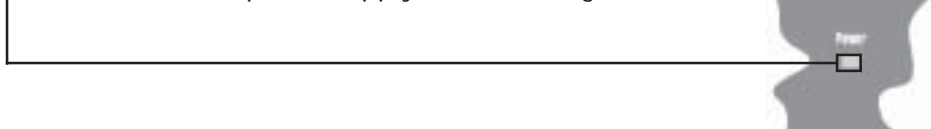

## Rear Panel Details

---

### Mains inlet

---

IEC power connector, for connection to mains supply (100-270V AC, 50/60Hz).

### Mains fuse holder

---

Requires a 20mm T1A type fuse. Do not replace with anything other than the recommended fuse.

### Audio & Control connectors

---

9008 audio and control connections are via Klippon (also known as BL, Phoenix or Combicon) pluggable terminal block connectors.

8 x 6-way female Klippon connectors are supplied for making these connections.

For audio and network cables and looms, see the Product Overview 2000 catalogue from:

Direct Cable Systems Ltd.

Tel: (020) 7485 0899

[www.directcable.co.uk](http://www.directcable.co.uk)

Neutricon-Neutricon tour grade network cable. P/N 150001

Phoenix-XLR audio cable P/N 100521

### Audio Output wiring convention

---

Soundweb products provide cable shielding 'back from the destination' to eliminate ground loop problems. Therefore, the shield (S) connection on an *input* is grounded, whereas the shield connection on an *output* is floating (although connected via an internal network to ground for EMC compliance).

**Balanced** wiring - The convention for balanced wiring (2-core plus shield) is:

#### Balanced connection

#### 9008 connection

Pin 3 : Cold '-'

Pin 2 : Hot '+'

Pin 1 : Shield

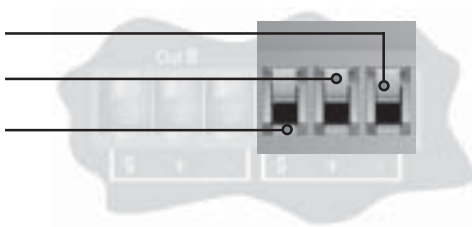

## Network In/Out

The Network *Out* socket on a Soundweb unit connects to the Network *In* socket on another unit. Repeat this process to make a network of devices. Audio channels are passed 'downstream' from the Net *Out* socket on the first unit to the Net *In* socket on the next unit. The Soundweb system automatically completes this 'daisy chain' of device connections to form a loop (using a 'back channel'), as shown by the dotted line in the diagram below.



This shows that audio channels are routed *back* from the terminal device (the one without a connection to its Net *Out* socket) to the first device (the one without a connection on its Net *In* socket).

**There must be no physical cable connection between the two end devices.**

The connecting cable is CAT. 5 network cable terminated with RJ45 connectors, with all 8 cores wired straight through.

Note that the twisted pairs in any CAT. 5 network cable must be wired to the following pin pairs at each terminal:

- 1 (White/Orange) with 2 (Orange)
- 3 (White/Green) with 6 (Green)
- 4 (Blue) with 5 (White/Blue)
- 7 (White/Brown) with 8 (Brown)

## Aux. RS232

An alternative connection for a control PC, modem or AMX/Crestron type panel. This port works at 115200bps. Note that AMX panels only currently connect at 38400bps.

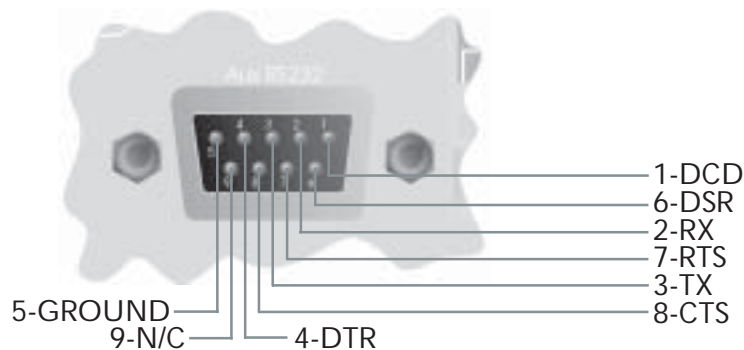

### CONTROL INPUTS

---

Used to connect switches or potentiometers, e.g. 9012 selector wallplate (Part no. Z-SW9012).

Looking at the control port connector (on the back of the unit), there are two common (ground) connections **C** to the left of the eight CONTROL INPUTS and, two software assignable reference voltage outputs **R** to the right.

The control ports now have two modes of operation. In Soundweb Designer's Control Ports window these are labelled '2-wire' and '3-wire'.

#### 2-wire mode

In this mode the eight CONTROL INPUTS are internally 'pulled up' to +5V DC via a 4.7kOhm resistor. Therefore, no external voltage source is needed to create contact closure to ground for switches such as mute buttons or, resistance to ground (for other multi-state or continuous controls such as Parameter Presets or faders).

See the Soundweb Designer help for a table of resistor values for use with Parameter Presets or source selectors.

Two 'common' ground connections are provided using the two **C** connectors to the left of the CONTROL INPUTS.

A 47kOhm-*log* potentiometer (Part no. DM10018) connected between a control input and common will allow parameters to be controlled linearly.

#### 3-wire mode

This mode allows the use of *linear* pots or faders for continuous controls. A pot would be wired as a *potential divider* with the top of the track connected to the reference output **R**, the wiper to a control input and the bottom of the track to a common **C**. For good performance pots with track resistance between 10K and 100KOhms are recommended.

### LOGIC OUTPUTS

---

Used to connect 'tally' indicator LED's or relays.

There are eight standard LOGIC OUTPUTS which produce 0V or +5V DC via an internal 440 Ohm resistor and two internally connected common (ground) connections **C**.

An LED connected between one output (Anode, A) and common (Cathode, K) will illuminate when the logic output is activated, without requiring any external current limiting resistor.

A high sensitivity relay (such as a reed relay) may be driven by connecting four outputs in parallel. This arrangement will develop 4V across a 500-Ohm coil, providing that all four outputs are made logic 1 simultaneously.

### OPTO Output

---

In addition to the eight standard logic outputs, there is an isolated output, which fails safe (open circuit) if the unit becomes faulty.

This is effectively the collector-emitter of a transistor (which may be thought of as a switch), in series with a 220-Ohm protection resistor. In conjunction with an external DC power source (max 80V), this may be used to drive various loads such as relays.

Control Inputs and Logic Outputs connection diagram

Soundweb™

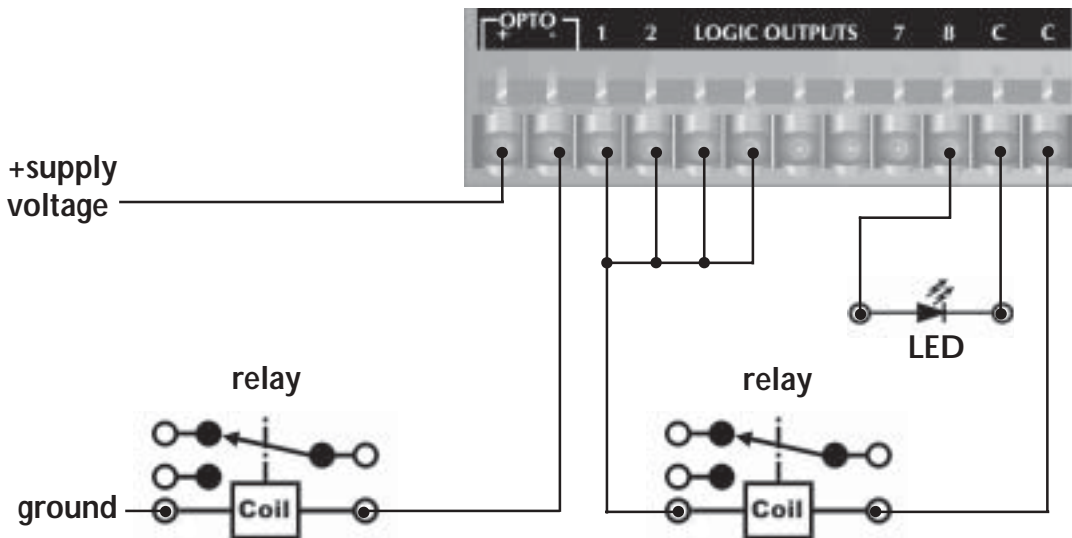
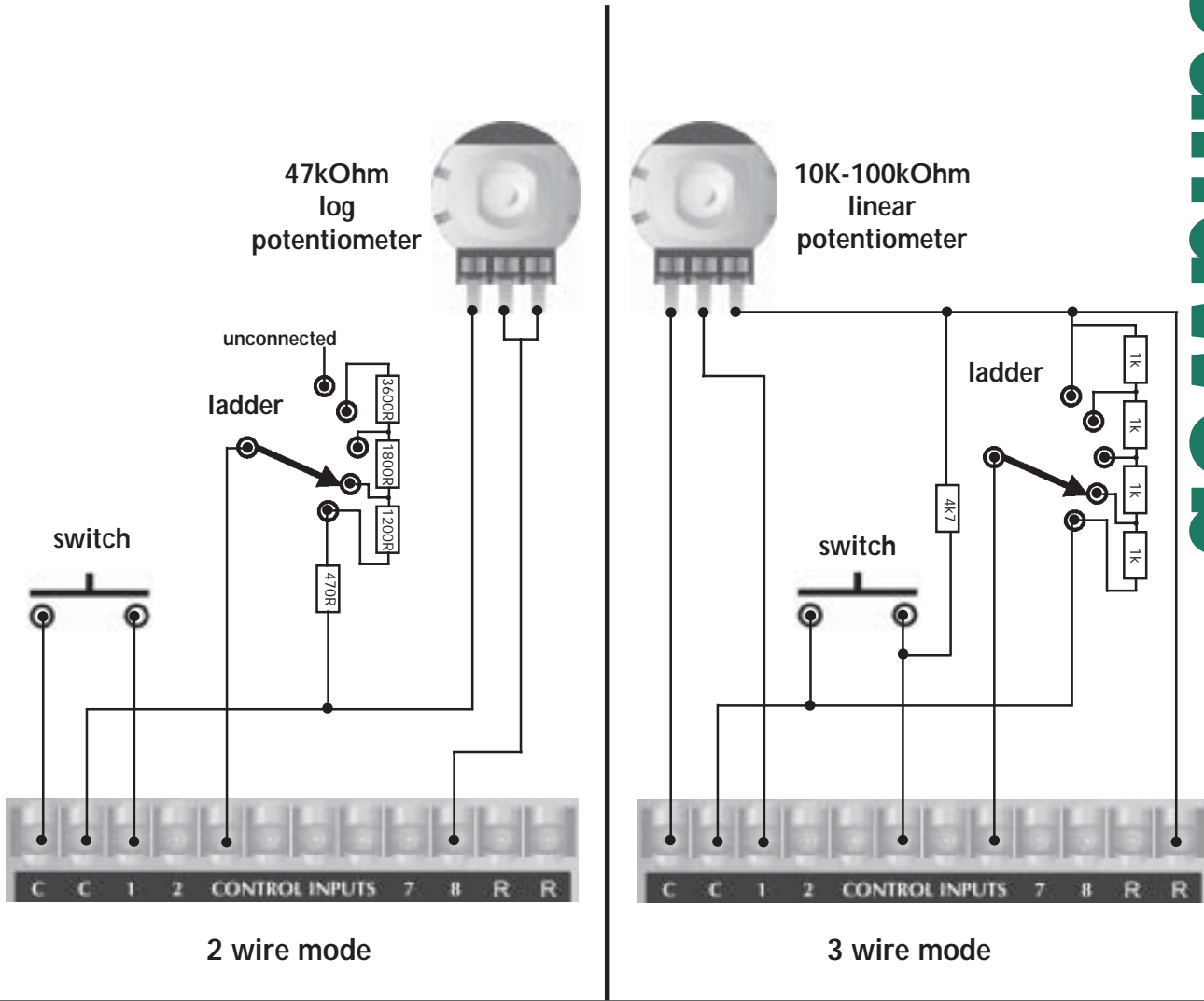

## 9008 Technical Specifications

---

### General

DSP capability	200MIPS (Million Instructions Per Second)
Frequency response	15Hz to 20KHz (+-0.5dB)
Total Harmonic Distortion (THD)	<0.01% (20Hz to 0KHz, +10dBu output)
Dynamic range	105dB typical (22Hz to 22KHz unweighted) 108dB typical (A-weighted)
Maximum output level	+20dBu
Inter-channel crosstalk	<-75dB
Maximum network cable length	300m/1000ft
Mains supply	85-270V AC, 50/60Hz
Power consumption	<35VA

### Control Ports

Control input voltage	0 to 4.5v
Control input impedance (2 wire mode)	4.7kOhms to +5V
Control input impedance (3 wire mode)	>1MOhm
Logic output voltage	0 or +5V unloaded
Logic output impedance	440 Ohm
Opto output current	14mA max
Opto output withstanding voltage	80V max
Opto output series impedance	220 Ohms (isolated)

# Soundweb™

---

9010 Remote Control  
Installation Guide



# Regulatory Information

An example of this equipment has been tested and found to comply with the following European and international Standards for Electromagnetic Compatibility (only when used with a metal wallbox).



Radiated Emissions (USA):	FCC part 15 Class A	
Radiated Emissions (EU):	EN55022	(1990) Associated Equip.
Immunity (EU):	EN50082/1	(1992) RF Immunity, Fast Transients ESD

# Important safety information

It should not be necessary to remove any protective earth or signal cable shield connections to prevent ground loops. Any such disconnections are outside the recommended practice of BSS Audio, and will render the EMC certificate void.

We have written this guide with the aim of helping installers and sound engineers to get the most out of the 9010. We recommend that you read this manual, particularly the section on installation, before attempting to operate the unit.

# Mechanical Installation

The 9010 is designed to fit into a standard 3-gang US wallbox. Screws are provided to fix the unit in place. An optional bezel is available to 'dress' the edges of the panel if required.

Dimensions of the unit are shown below. The use of a metal wall box to ensure that the installation meets necessary EMC standards is recommended.

For suitable wallboxes, contact your distributor for part Z-010-BOX.

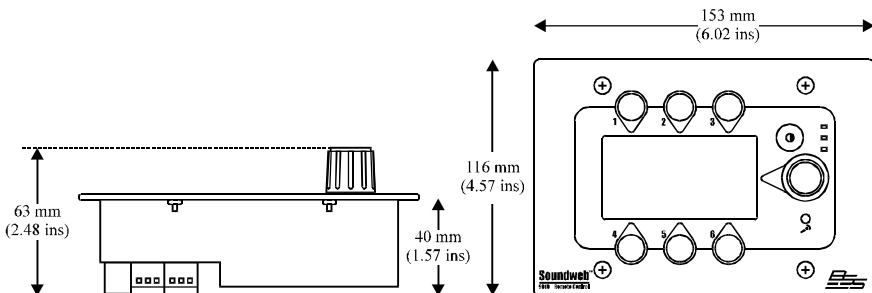



# Front panel LED functions

## Activity (yellow)

*Irregular Flashing* - This LED indicates data transfer

## Sync (green)

*Steady* - This indicates the presence of one or more valid network connections.

*Flashing* - There is a problem with the incoming network signal - possibly the maximum cable length has been exceeded.

## Master (yellow)

*Flashing* - The network is initialising. If it continues to flash for more than a few seconds, there is a cabling fault - either a double ring error or a problem with one of the cable connectors.

*Steady* - This unit has become the clock master for the network.

*Off* - This unit is clienting to the master's clock.

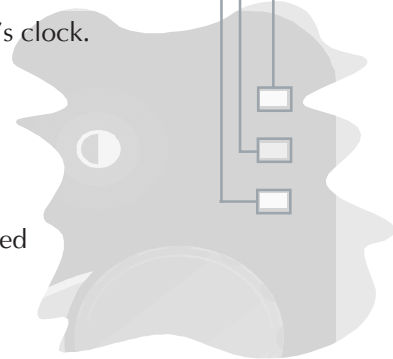

## Power

The 9010 requires 24v DC to be supplied externally.

There are two ways to power the unit:

- Connect a 24v DC power supply to the Power/Mic/Logic screw terminal block. Up to three more 9010's may be powered via network cabling from the Net Out of the 9010 which has the power supply connected (depending on cable length). *Refer to diagrams on page 7 for more details.*
- If it is inconvenient to cable a DC feed into the wallbox for the 9010, power may be applied via the network cable (on the Net In side), by using the Soundweb 9011 Power Interface to inject 24v DC from the power supply. Up to three more 9010's may be powered via network cabling from the Net Out of the 9010 which has the power supply connected (depending on cable length).

To assist calculating the maximum cable lengths between 9010s, refer to the spreadsheet *9010pwr.xls*, which may be found in the Soundweb Designer PC installation, or on our website, [www.bss.co.uk](http://www.bss.co.uk).

## Front panel details

### Display Contrast button

This is used to optimise the contrast of the display. Press and hold the contrast button to adjust. If you go past the optimum setting, keep holding the button so that adjustment starts from the beginning again.

### Backlit graphics display

The details displayed are specified by the Soundweb Designer software.

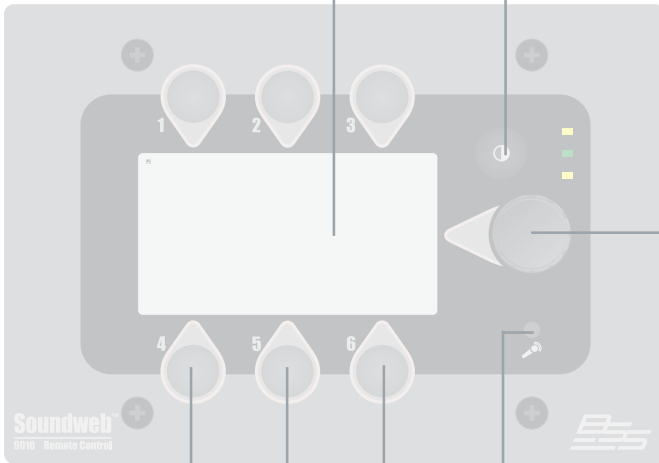

### Six push buttons

As with the rotary control, the operation of these are determined by the Soundweb Designer software.

### Microphone

The built-in microphone may be used for paging etc. The routing of the signal from the microphone is determined by the Soundweb Designer software.

### Rotary control

Used to adjust parameter values. The function of this control is determined entirely by the Soundweb Designer software.

# Rear panel details

## Network In/Out\*

*Network In* - connects to the *Network Out* socket on another unit.  
Connecting multiple units is done in the same way - *In* to *Out*.

Refer to the 9088 installation guide and Soundweb Designer help for further details.

The connecting cable is CAT. 5 network cable, terminated with RJ45 connectors, with all 8 cores wired straight through.

Note that the twisted pairs in any CAT.5 network cable must be wired to the following pin pairs at each terminal:

- 1 (White-Orange) with 2 (Orange)
- 3 (White-Green) with 6 (Green)
- 4 (Blue) with 5 (White-Blue)
- 7 (White-Brown) with 8 (Brown)

## Power/Mic/Logic screw terminal block\*

### Power In

DC power input (+24V and Gnd). See Power section.

### Mic -, +, S

Three connections for an external dynamic microphone:

- Mic -
- Mic +
- Mic Screen

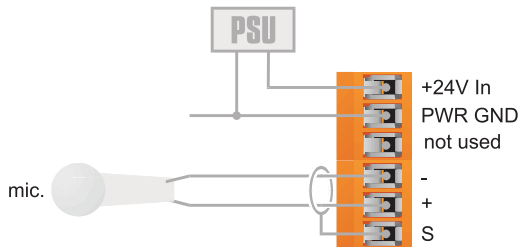

## Serial Port\*

### RS232

For connection to a PC running Soundweb Designer. The 10-pin IDC connector is arranged so that a short IDC ribbon cable can be connected to a male 9-pin D type connector to form an adapter cable. A standard 'null-modem' cable can be used to connect the unit to another unit.

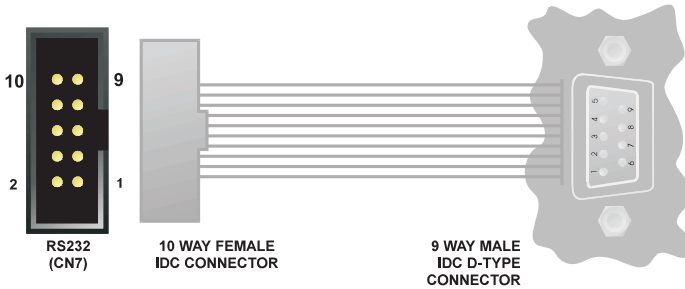

## Expansion Port\*

### Right/Left Outputs/Audio Gnd

An unbalanced line-level feed for use in custom applications, e.g. monitoring etc. The outputs are polarity inverted so that external inverting amplifiers may be used. The signal on these outputs is determined by the Soundweb Designer software.

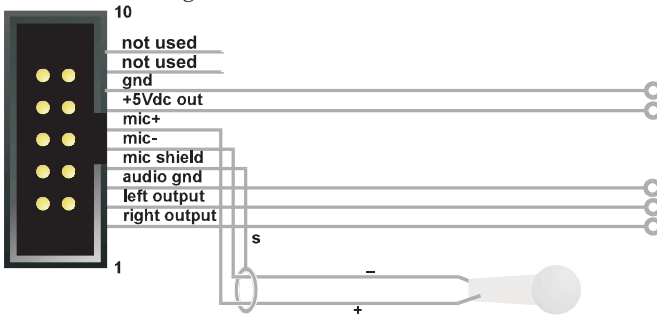

### Mic Shield, Mic -, Mic+

Commoned with the Mic In terminals on the Power/Mic/Logic screw terminal block.

### +5Vdc Out

A low current regulated +5V output for supplying power to electronics for custom applications. No more than 100mA may be drawn. Current drawn from this output will impact the length of network cable that may be used between the power supply and the 9010.

\*refer to label on back of unit for connection positions.

## Connecting to a power supply

If using the 9010 unit without a 9011 power interface, the network and 9010 should be connected in the following fashion:

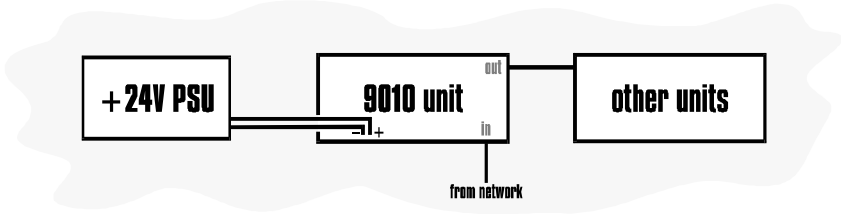

When using the 9010 unit with a 9011 power interface, connect as follows:

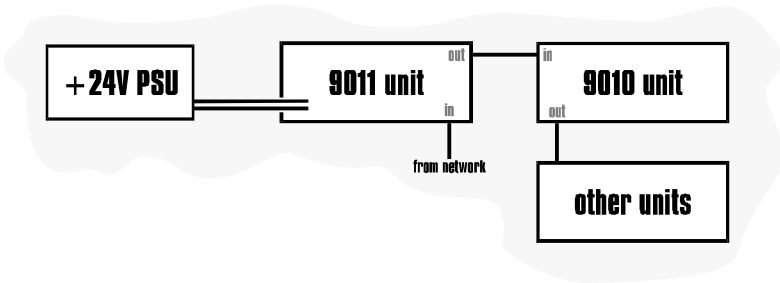

## Accessories

### Z-010-BEZEL Soundweb 9010 Bezel

A sculptured plastic surround to 'dress' the 9010 panel edges for more elegant presentation.

### Z-999-PSU Soundweb Power supply kit

A 24Vdc universal input power supply suitable for powering up to four 9010's. This is a free-standing unit with integral IEC power inlet.

### Z-010-BOX Soundweb 9010 wallbox

A standard U.S. 3-gang outlet wallbox suitable for housing the 9010 in an installation.

### Z-SW9011 Soundweb Power Interface

Allows DC power from a power supply to be injected into the network cable feeding the 9010(s).

# 9010 Remote Control

# Technical specifications

## External Microphone Input

Frequency response (+-1dB)	20Hz to 20KHz
THD	0.05% (20Hz to 20KHz, +10dBu output)
Dynamic range	80dB typ. (22Hz to 22KHz unweighted)
Gain control range	34 to 72dB
Maximum input level	-20dBu
Input impedance	2k Ohm
Equivalent Input Noise	-106dBu @150 Ohm

## Audio Outputs

Frequency response (+-1dB)	20Hz to 20KHz
THD	<0.05%(20Hz to 20KHz, 0dBu output)
Dynamic range	88dB typ. (22Hz to 22KHz unweighted)
Maximum output level	+4dBu
Output impedance	220 Ohm

Note - polarity is inverted to allow external headphone amplifier or line driver to be inverting.

## General

Maximum network cable length	300m/1000ft
Power consumption	<5VA (<200mA at 24V DC)

---

**Soundweb™**

**Soundweb™ 9012  
Installation Guide**



## Useful Information

v1.0 MR/JMK 4th November 1999

We have written this guide with the aim of helping installers and sound engineers alike to get the most out of the 9012. We recommend that you read this manual, particularly the section on mechanical installation, before attempting to operate the unit.

We welcome any comments or questions regarding the 9012 or other BSS products, and you may contact us at the address or World Wide Web site given below.

### **BSS Audio:**

Cranbourne House,  
Cranbourne Industrial Estate,  
Potters Bar,  
Hertfordshire,  
EN6 3JN.

<http://www.bss.co.uk/>

Tel: +44 (0)1707 660667 Fax: +44 (0)1707 660755

## Installation

The 9012 is a wall mounted controller which, with the rotary switch, can be used to control a source selector or parameter preset bar in the main system, and with the rotary level control alter the level of the gain object, for example.

A sticker sheet is provided with the unit, which should cover most locational requirements. The sheet covers 4 languages: English, French, German and Spanish.

The unit is mounted into a standard UK light switch wall box; and dimensions of the unit are shown below. The pitch between the fixing hole centres is 60mm. Mounting screws are provided.

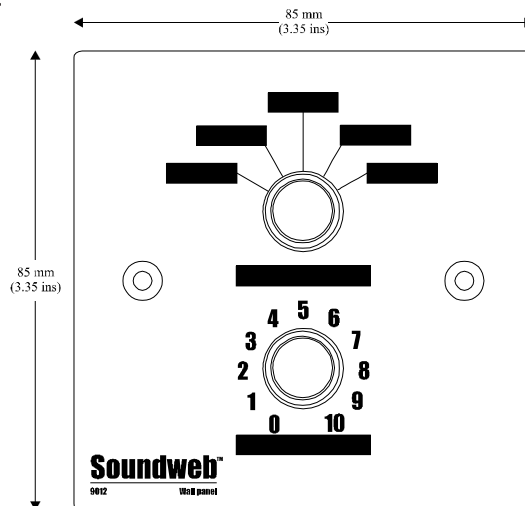

## Wiring

Wiring follows the standard control input wiring for a 9088, shown below. The printing on the PCB also shows the correct wiring convention. The cable used should be regular audio cable, or any quality shielded twin-core cable.



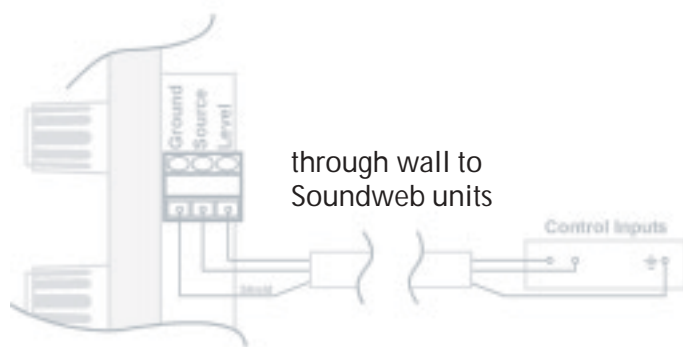

## Example setup

Shown below is a typical Soundweb setup for use with the 9012 wall panel.

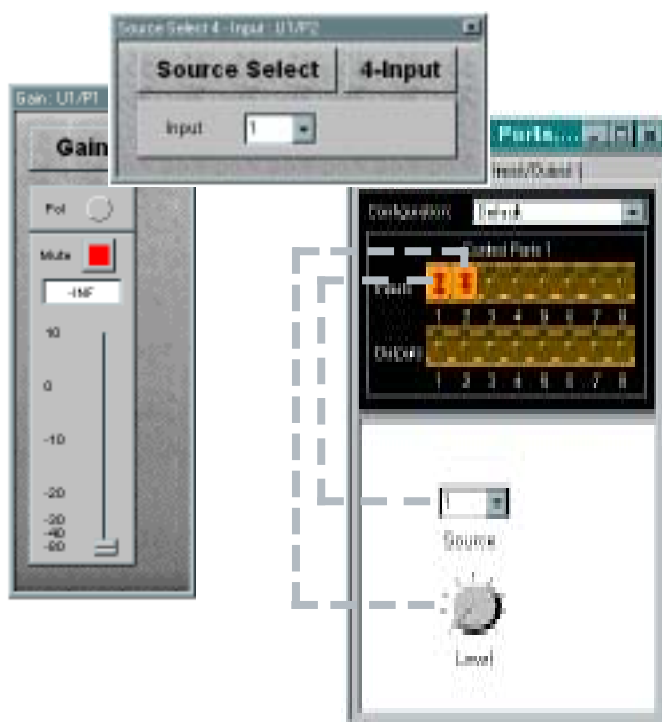

Parts for the 9012 are also available as spares, should you wish to design your own control panels.

BSS Part numbers are:

Source switch: DH10007

Level pot: DM10018

Please contact BSS sales for more details.

**Soundweb™**

---

**Soundweb™ 9014  
Installation Guide**



## Regulatory Information

v1.0 MR/JMK 8th September 1999

An example of this equipment has been tested and found to comply with the following European and international Standards for Electromagnetic Compatibility (only when used with a metal wallbox).

Radiated Emissions (EU): EN55022 (1995) Associated Equip.  
 Immunity (EU): EN50082/1 (1997) RF Immunity, Fast Transients ESD  
 Radiated Emissions (USA): FCC part 15 Class A



## Important safety information - read and follow

It should not be necessary to remove any protective earth or signal cable shield connections to prevent ground loops. Any such disconnections are outside the recommended practice of BSS Audio, and will render the EMC certificate void. We have written this guide with the aim of helping installers and sound engineers alike to get the most out of the 9014. We recommend that you read this manual, particularly the section on mechanical installation, before attempting to operate the unit. We welcome any comments or questions regarding the 9014 or other BSS products, and you may contact us at the address or World Wide Web site given below.

### **BSS Audio:**

Cranbourne House,  
 Cranbourne Industrial Estate,  
 Potters Bar,  
 Hertfordshire,  
 EN6 3JN.

[www.bss.co.uk](http://www.bss.co.uk)

Tel: +44 (0)1707 660667 Fax: +44 (0)1707 660755

## Mechanical Installation

Dimensions of the unit are shown below.

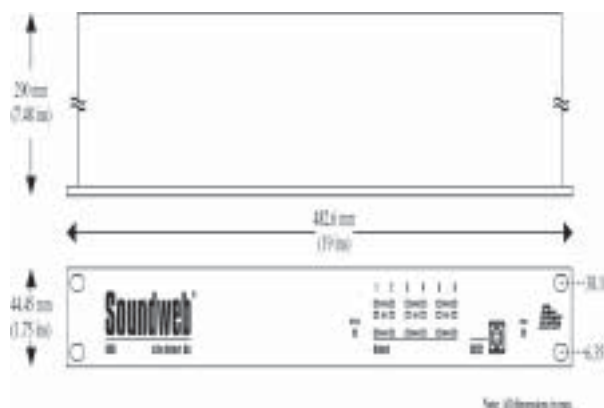

Three 9014 devices can be mounted side-by-side with a 1U panel, available from BSS Audio as part number Z-999-FPNL.

BSS Audio also offer a universal AC input +24V DC power supply, available as part number Z-999-PSU.

The panel can be used to rack mount one or two 9014 devices if required, and can be fitted with the Z-999-PSU power supply, with the use of a PSU tray; part number Z-999-TRAY.



## Use

The 9014 requires 12-24v DC to be supplied externally. There are two ways of getting power into the unit:

- Connect a 24v 1A DC power supply to the 2.4mm barrel connector. Up to nine more 9014s may be powered from the paralleled combicon connector.
- Connect a 12-24v DC power supply to the combicon connector.

A pair of 9014 Fibre Interface units are used to replace a standard category 5 Soundweb network cable. Each fibre cable will transfer 8 channels of digital audio plus control data.

To utilise the fibre system, each end of the fibre link requires one 9014 device. Each device is equipped with an RJ-45 Soundweb network cable jack into which the network cable is connected, and two snap-in SC type fibre connectors.

Two fibre cables are then required to connect between 9014 devices - this is to enable the bi-directional data transfer.

## Network socket

This connects to either the Network Out socket or the Network In socket on another unit.

The connecting cable is CAT. 5 network cable, terminated with RJ45 connectors, with all 8 cores wired straight through.

Note that the twisted pairs in any CAT.5 network cable must be wired to the following pin pairs at each terminal:

- 1 (White-Orange) with 2 (Orange); 3 (White-Green) with 6 (Green);
- 4 (Blue) with 5 (White-Blue); 7 (White-Brown) with 8 (Brown)

### **Note:**

Ensure that all Out sockets are connected to their correct In sockets at each end of every cable. Connecting In - In (or Out - Out) will result in improper operation of the network.

## Front panel LED functions

The unit has three LED indicators showing:

### Power

Steady - This indicates the power supply is functioning.

### Fibre-in

Steady – Data is arriving on the fibre input.

Intermittent – You have exceeded the optical power budget by either exceeding the maximum fibre length or by having too much attenuation in fibre splices. See the specification section.

### Cable-in

Steady – Data is arriving on the cable.

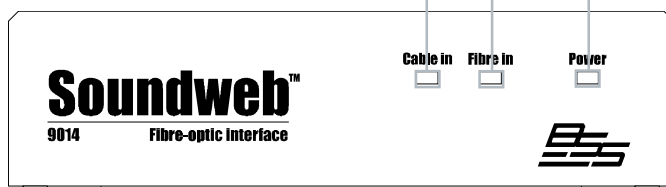

## Rear panel connections

The unit has the following connections on the rear face:

### Power

Phoenix socket: Power supply to or from a 9011 power interface.

Barrel socket: Power supply from a Z-999-PSU power supply.

### Network

Signal at the network socket is in electrical form.

The **network socket** is bi-directional, so information can pass in and out of the 9014 unit through this connection simultaneously. It is also auto-sensing, meaning that it can be connected to either an OUT or an IN socket on one of the other Soundweb series units.

### Fibre-in/out

Signal at the fibre in/out sockets has been converted to an optical format.

Information arriving from a Soundweb unit at the **network socket** is passed through the 9014 for conversion, and out of the **fibre out** socket.

Information arriving at the **fibre in** socket is passed through the 9014 for conversion and out of the **network socket**.

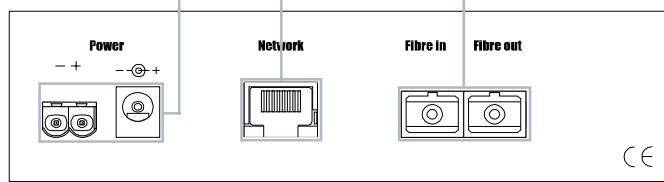

---

## Technical specifications

### Power

DC Supply 12-24V DC, <5VA  
Connector Phoenix screw terminal or 2.4mm inline barrel connector

### Network

Single RJ-45 Auto-sensed input node or output node - no setup required.

Max cable length 20m

### Fibre Connection

Snap-in SC fibre input  
Snap-in SC fibre output

### Fibre cable

Multimode 62.5/125um or Multimode 50/125um

### Optical Power Budget

10dB

Max fibre length 2000 metres/6550 feet/1.2 miles

N.B this distance is based on the optical power budget and maximum allowable network delay of one sample in any one ring.

Dimensions 5.3" x 5.5" x 1.4"  
135 x 139 x 36mm

---

**Soundweb™**

**Soundweb™ 9088  
Installation Guide**



## Regulatory Information

v1.2 JK 4th June 1998

An example of this equipment has been tested and found to comply with the following European and international Standards for Electromagnetic Compatibility and Electrical Safety:

Radiated Emissions (EU):	EN55013	(1990) Associated Equipment
Immunity (EU):	EN50082/1	(1992) RF Immunity, Fast Transients ESD
Mains Disturbance (EU):	EN61000/3/2	(1995)
Electrical Safety (EU):	EN60065	(1993)
Radiated Emissions (USA):	FCC part 15 Class B	
Electrical safety (USA):	UL813	



## Important user information

**Do not remove covers. No user serviceable parts inside, refer servicing to qualified service personnel.** For continued compliance with international EMC regulations, it is important that all cables be screened, and connected as follows: Audio cable screens to their 9088 connector ground. Control cable screens to the ground screws adjacent to the connector. Network cables should be of type CAT.5, fitted with a clip-on ferrite sleeve (STEWART TYPE 28A2029-0A0) near the network socket end. This equipment must be earthed. It should not be necessary to remove any protective earth or signal cable shield connections to prevent ground loops. Any such disconnections are outside the recommended practice of BSS Audio, and will render the EMC or safety certificate void.

## Mechanical Installation

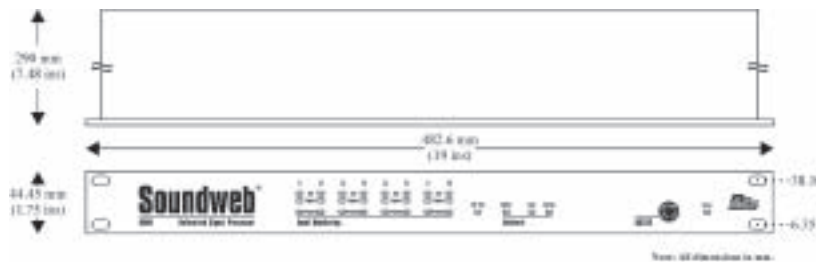

If the unit is likely to undergo extreme vibration through extensive road trucking and touring, the unit must be supported at the rear and/or sides to lessen the stress on the front mounting flange. The necessary support can generally be bought ready-built as a rack tray, or the 9088 unit can be mounted between other units. Damage caused by insufficient support is not covered by the warranty. To prevent cosmetic damage to the front panel finish, use protective plastic cups under the rack mounting bolts.



## Front panel LED functions

### Input monitoring

Each channel has 3 LED indicators showing:

#### Clip

*Illuminated* - Excessive signal level, close to clip.

#### Signal

*Illuminated* - A signal is present on this channel input.

#### Phantom

*Illuminated* - Phantom power is active for this mic channel.

*ALL flashing* - Unit selected in Soundweb designer/Network view.

### DSP Clip

*Illuminated* - Indicates that the signal is clipping internally.

### Network

#### Master

*Flashing* - The network is initialising. If it continues to flash for more than a few seconds, there is a cabling fault - either a double ring error or a problem with one of the cable connectors.

*Steady* - This unit has become the clock master for the network.

*Off* - This unit is clienting to the master's clock.

#### Sync

*Steady* - This indicates the presence of one or more valid network connections.

*Flashing* - There is a problem with the incoming network signal - possibly the maximum cable length has been exceeded.

#### Activity

*Flashing* - This LED indicates data transfer. The flashing is not regular, but dependant on the rate of transfer.

### Power

*Steady* - This indicates that the power supply is functioning.

## Front panel details

### RS232

Used to connect one of the 9088 units in the network to a controller PC (cable supplied with unit), which can then communicate with any device on the network. The pin out is:

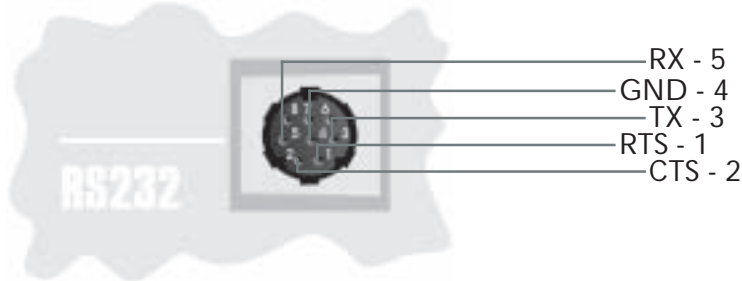

## Audio & Control cable wiring details

All audio and control connections to the 9088 are via Klippon pluggable terminal block connectors (also known as BL, Phoenix or Combicon). 6-way female Klippon connectors are supplied for making these connections.

### Audio Input and Output wiring convention

Soundweb products provide cable shielding 'back from the destination' to eliminate ground loop problems. This means that the shield (S) connection on an input is grounded, whereas the shield connection on an output is floating (although connected via an internal network to ground for EMC compliance).

*Balanced wiring* - The convention for balanced wiring (2-core plus shield) is:

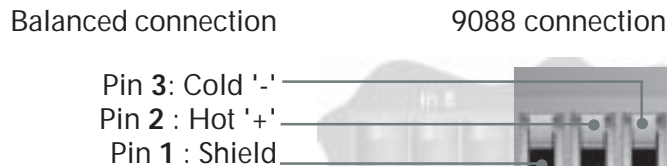

*Unbalanced wiring* - The convention for unbalanced wiring to the inputs (1-core plus shield) is:

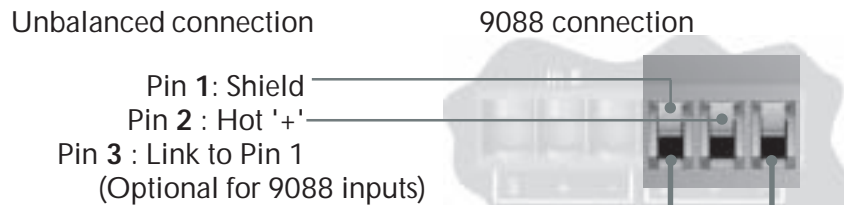

## Rear panel details

### Mains inlet

IEC power connector for removable mains supply.

### Fuse holder

Mains fuse - requires a 20mm T1A type fuse.

### Network In/Out

*Network In* - connects to the *Network Out* socket on another unit. Connecting multiple units is done in the same way - *In* to *Out*. This allows audio channels to be passed 'downstream' from the Net Out socket on one device to the Net In socket on the next device. The Soundweb system automatically completes this 'daisy chain' of device connections to form a loop (using a back-channel), as shown by the dotted line in the diagram below. This shows that audio channels may be routed back from the terminal device (the one without a connection on its *Net Out* socket) to the first device (the one without a connection on its *Net In* socket). There must be no physical cable connection between these two end devices however.



The connecting cable is CAT. 5 network cable, terminated with RJ45 connectors, with all 8 cores wired straight through.

Note that the twisted pairs in any CAT.5 network cable must be wired to the following pin pairs at each terminal:

- 1 (White-Orange) with 2 (Orange)      3 (White-Green) with 6 (Green)
- 4 (Blue) with 5 (White-Blue)      7 (White-Brown) with 8 (Brown)

### Aux RS232

This is for connection to a PC, modem or AMX panel (a control PC may be connected here, or via the front panel RS232 port).

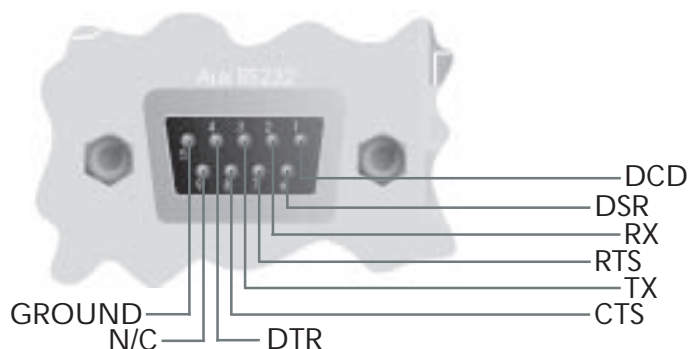

## Control Inputs

Used to connect switches or potentiometers to the 9088. These eight inputs are internally 'pulled up' to +5V DC via a 4.7kOhm resistor, so no external voltage source is needed. Four common (ground) connections are provided (all connected together internally). A 47kOhm log potentiometer connected between one input and common will allow parameters to be controlled linearly. Alternatively, a switch may be connected between an input and common, or a multiway switch may be connected to several inputs with the wiper connected to common.

## Logic Outputs

Used to connect the 9088 to 'tally' indicator LEDs or relays. There are eight standard logic outputs which produce 0V or +5V DC via an internal 440 Ohm resistor. Two common (ground) connections are provided (connected together internally). A LED connected between one output (Anode, A) and common (Cathode, K) will illuminate when the logic output is activated, without requiring any external current limiting resistor. A high sensitivity relay (such as a reed relay) may be driven by connecting four outputs in parallel. This arrangement will develop 4V across a 500 Ohm coil, providing that all four outputs are made logic 1 simultaneously.

## Opto output

In addition to the eight standard logic outputs, there is an isolated output, which fails safe (open circuit) if the 9088 becomes faulty. This is effectively the collector-emitter of a transistor (which may be thought of as a switch) in series with a 220 Ohm protection resistor. In conjunction with an external DC power source (max 80V), this may be used to drive various loads such as relays.

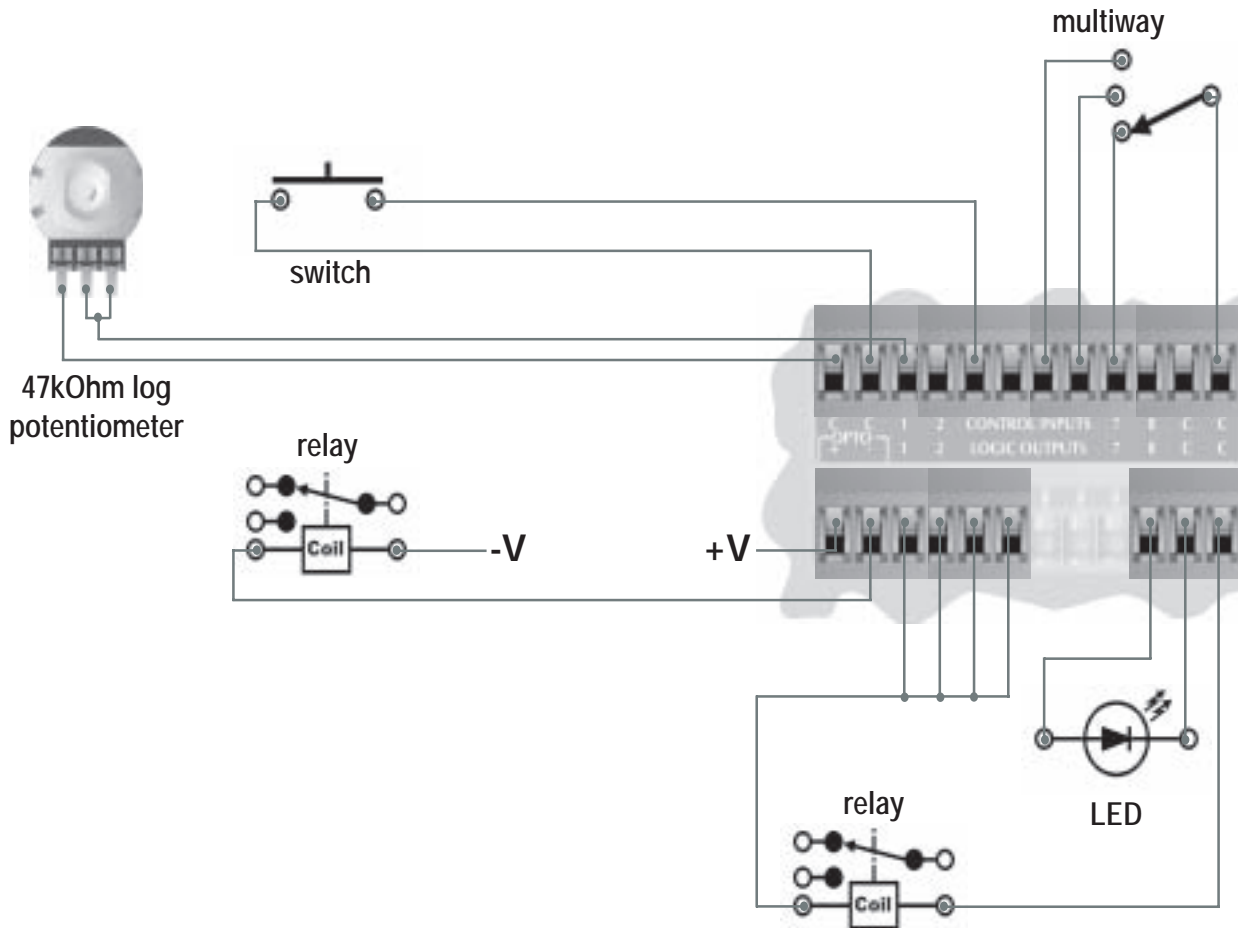

## Technical specifications

### General

Frequency response (+-0.5dB)	15Hz to 20KHz
THD	<0.01% (20Hz to 0KHz, +10dBu output)
Dynamic range	100dB typ. (22Hz to 22KHz unweighted) 103dB typ. (A-weighted)
Maximum output level	+20dBu
Inter-channel Crosstalk	<-75dB
Maximum network cable length	300m/1000ft
Power consumption	<35VA
Mains Volts	85-270V 50/60Hz

### Line input card

Input Impedance	10kOhms
Maximum input level	+20dBu (+8dBu with 12dB gain)
Gain range	0 or 12dB

### Universal microphone/Line input card

Input impedance	3.5kOhms
Maximum input level	+20dBu (with 0dB gain)
Gain range	0 to 70dB
CMRR	>75dB at 1KHz
Equivalent Input Noise (EIN)	<-128dBu typ with 150 Ohms source
Phantom power	48V nominal

### Control ports

Logic output voltage	0 or +5V unloaded
Logic output impedance	440 Ohm
Opto output series impedance	220 Ohms (isolated)
Control input voltage	0 to 4.5v
Control input impedance	4.7kOhms to +5V
Opto Output current	14mA max
Opto output withstanding voltage (off)	80V max.



**Soundweb™**  
**9088ii**      **Networked Signal Processor**  
**Installation Guide**

**Soundweb™**



## Regulatory Information

An example of this equipment has been tested and found to comply with the following European and international Standards for Electromagnetic Compatibility and Electrical Safety:

Emissions (EU):	EN55013	(1990)
Generic Immunity (EU):	EN50082-1	(1997)
Electrical Safety (EU):	EN60065+A11	(1993)
Electrical Safety (USA):	UL6500/ETL	(1996)
Electrical Safety (CAN):	CAN/CSA-E65/ETLc	(1994)
Radiated Emissions (USA):	FCC parts 15 Class B	



## IMPORTANT SAFETY INFORMATION

Do not remove covers.

No user serviceable parts inside - refer servicing to qualified service personnel.

**This equipment must be earthed.**

It should not be necessary to remove any protective earth or signal cable shield connections to prevent ground loops. Any such disconnections are outside the recommended practice of BSS Audio and will render the EMC or safety certification void.

For continued compliance with international EMC regulations, it is important that all cables be screened, and connected as follows:

- Audio cable screens to their 9088 connector ground.
- Control cable screens to the ground screws adjacent to the connector.

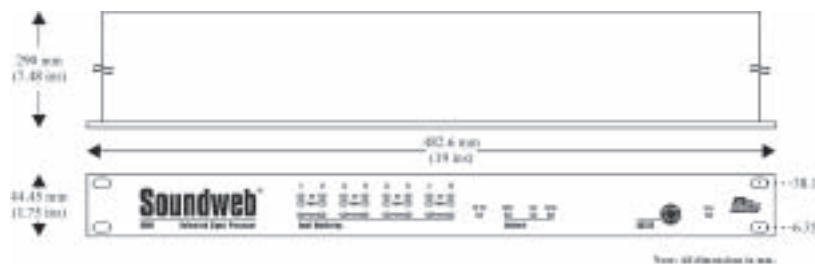

Network cables should be of type CAT. 5

## Mechanical Installation

If the unit is likely to undergo extreme vibration through extensive road trucking and touring, it must be supported at the rear and/or sides to lessen the stress on the front mounting flange. Use either a ready-built rack tray or mount the 9088 unit between other



## Front Panel LED Functions

### Input Monitoring

Each channel has 3 LED indicators showing:

**Clip**

*Illuminated* = excessive signal level.

**Signal**

*Illuminated* = signal is present on this channel input.

**Phantom**

*Illuminated* = phantom power is active for this Mic channel.

*ALL flashing* = this device is selected in Soundweb Designer's Network view.

*Scrolling from right to left* = recovery mode, the device's firmware needs reloading.

**DSP Clip**

*Illuminated* = indicates that the processed signal is clipping internally.

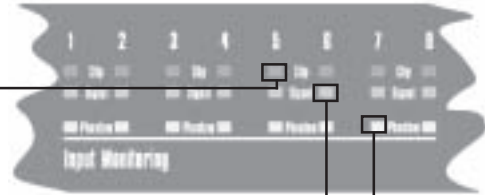

### Network

**Master**

*Flashing* = the network is initialising. If the led continues to flash for more than a few seconds, there is a cabling fault - either a double ring error or a problem with one of the cable connectors.

*Steady* = this unit has become the clock master for the network.

*Off* = this unit is clienting to an external master clock.

**Sync**

*Steady* = indicates the presence of one or more valid network connections.

*Flashing* = there is a problem with the incoming network signal - check connections and/or possibly the maximum cable length has been exceeded.

**Activity**

*Flashing Yellow* = indicates data transfer. The flashing is not regular, but dependent on the rate of transfer.

*Flashing Red* = indicates bad data and is usually caused by network faults. Check network connections, see Rear Panel details.

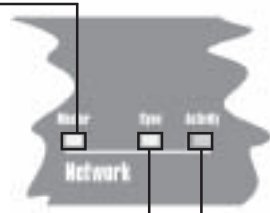

**Power**

*Illuminated* = indicates that the power supply is functioning.

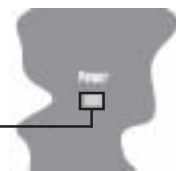



## Rear Panel Details

### Audio & Control connectors

9088 audio and control connections are via Klippon (also known as BL, Phoenix or Combicon) pluggable terminal block connectors. 12 x 6-way female Klippon connectors are supplied for making these connections. For audio and network cables and looms, see the Product Overview 2000 catalogue from: Direct Cable Systems Ltd.

Tel: (020) 7485 0899

www.directcable.co.uk

Neutricon-Neutricon four grade network cable.

P/N 150001

Phoenix-XLR audio cable

P/N 100521

### Audio & AES/EBU Input and Output wiring convention

Soundweb products provide cable shielding 'back from the destination' to eliminate ground loop problems. Therefore, the shield (S) connection on an *input* is grounded, whereas the shield connection on an *output* is floating (although connected via an internal network to ground for EMC compliance).

**Balanced** wiring - The convention for balanced wiring (2-core plus shield) is:

#### Balanced connection

#### 9088 connection

Pin 3 : Cold '-'  
Pin 2 : Hot '+'  
Pin 1 : Shield

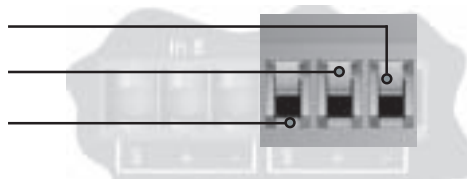

This wiring can also be applied to the AES digital interface card.

**Unbalanced** wiring (analogue audio only) - The convention for unbalanced wiring to the inputs (1-core plus shield) is:

#### Unbalanced connection

#### 9088 connection

Pin 1 : Shield  
Pin 2 : Hot '+'  
Pin 3 : Link to Pin 1  
(Optional for 9088 inputs)

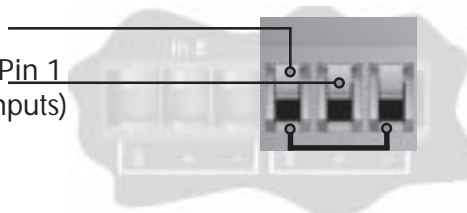

## Mains inlet

IEC power connector, for connection to mains supply (100-270V AC, 50/60Hz).

## Mains fuse holder

Requires a 20mm T1A type fuse. Do not replace with anything other than the recommended fuse.

## Network In/Out

The Network *Out* socket on a Soundweb unit connects to the Network *In* socket on another unit. Repeat this process to make a network of devices. Audio channels are passed 'downstream' from the Net *Out* socket on the first unit to the Net *In* socket on the next unit. The Soundweb system automatically completes this 'daisy chain' of device connections to form a loop (using a 'back channel'), as shown by the dotted line in the diagram below.

This shows that audio channels are routed *back* from the terminal device (the one without a connection to its Net *Out* socket) to the first device (the one without a connection on its Net *In* socket).

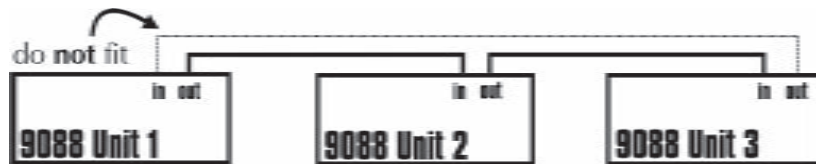

**There must be no physical cable connection between the two end devices.**

The connecting cable is CAT. 5 network cable terminated with RJ45 connectors, with all 8 cores wired straight through.

Note that the twisted pairs in any CAT. 5 network cable must be wired to the following pin pairs at each terminal:

- 1 (White/Orange) with 2 (Orange)
- 3 (White/Green) with 6 (Green)
- 4 (Blue) with 5 (White/Blue)
- 7 (White/Brown) with 8 (Brown)

## Aux. RS232

An alternative connection for a control PC, modem or AMX/Crestron type panel. This port works at 115200bps. Note that AMX panels only currently connect at 38400bps.

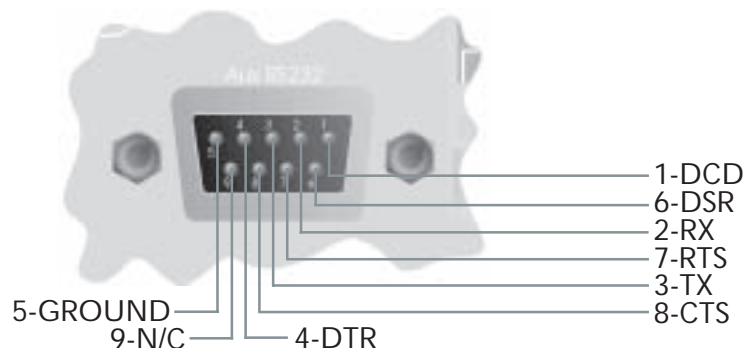

### CONTROL INPUTS

---

Used to connect switches or potentiometers, e.g. 9012 selector wallplate (Part no. Z-SW9012). Looking at the control port connector (on the back of the unit), there are two common (ground) connections **C** to the left of the eight CONTROL INPUTS and, two software assignable reference voltage outputs **R** to the right.

The control ports now have two modes of operation. In Soundweb Designer's Control Ports window these are labelled '2-wire' and '3-wire'.

#### 2-wire mode

In this mode the eight CONTROL INPUTS are internally 'pulled up' to +5V DC via a 4.7kOhm resistor. Therefore, no external voltage source is needed to create contact closure to ground for switches such as mute buttons or, resistance to ground (for other multi-state or continuous controls such as Parameter Presets or faders).

See the Soundweb Designer help for a table of resistor values for use with Parameter Presets or source selectors.

Two 'common' ground connections are provided using the two **C** connectors to the left of the CONTROL INPUTS.

A 47kOhm-*log* potentiometer (Part no. DM10018) connected between a control input and common will allow parameters to be controlled linearly.

#### 3-wire mode

This mode allows the use of *linear* pots or faders for continuous controls. A pot would be wired as a *potential divider* with the top of the track connected to the reference output **R**, the wiper to a control input and the bottom of the track to a common **C**. For good performance pots with track resistance between 10 and 100KOhms are recommended.

### LOGIC OUTPUTS

---

Used to connect 'tally' indicator LED's or relays.

There are eight standard LOGIC OUTPUTS which produce 0V or +5V DC via an internal 440 Ohm resistor and two internally connected common (ground) connections **C**. An LED connected between one output (Anode, A) and common (Cathode, K) will illuminate when the logic output is activated, without requiring any external current limiting resistor.

A high sensitivity relay (such as a reed relay) may be driven by connecting four outputs in parallel. This arrangement will develop 4V across a 500-Ohm coil, providing that all four outputs are made logic 1 simultaneously.

#### OPTO Output

---

In addition to the eight standard logic outputs, there is an isolated output, which fails safe (open circuit) if the unit becomes faulty.



## Control Inputs and Logic Outputs connection diagram

Soundweb™

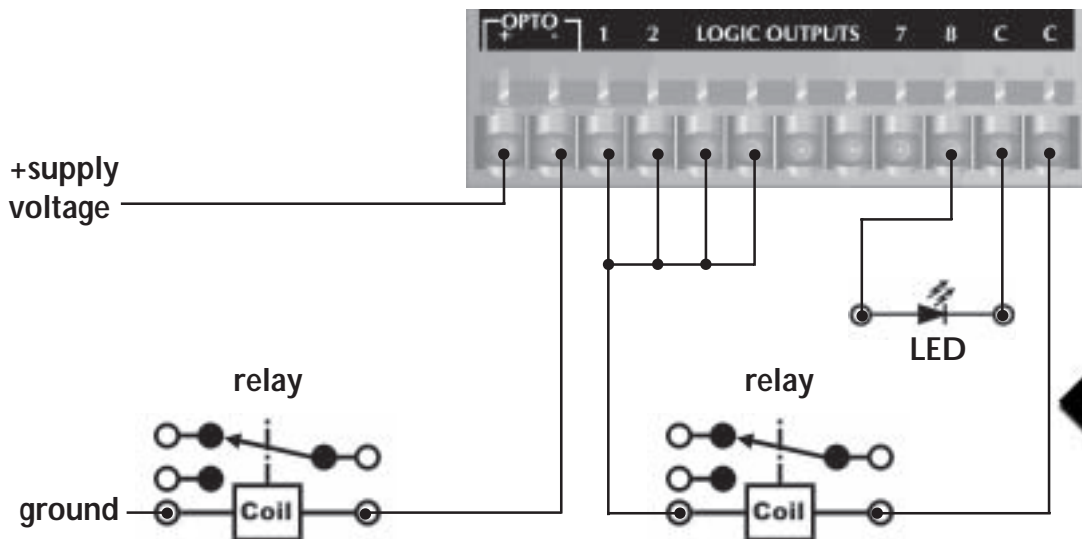
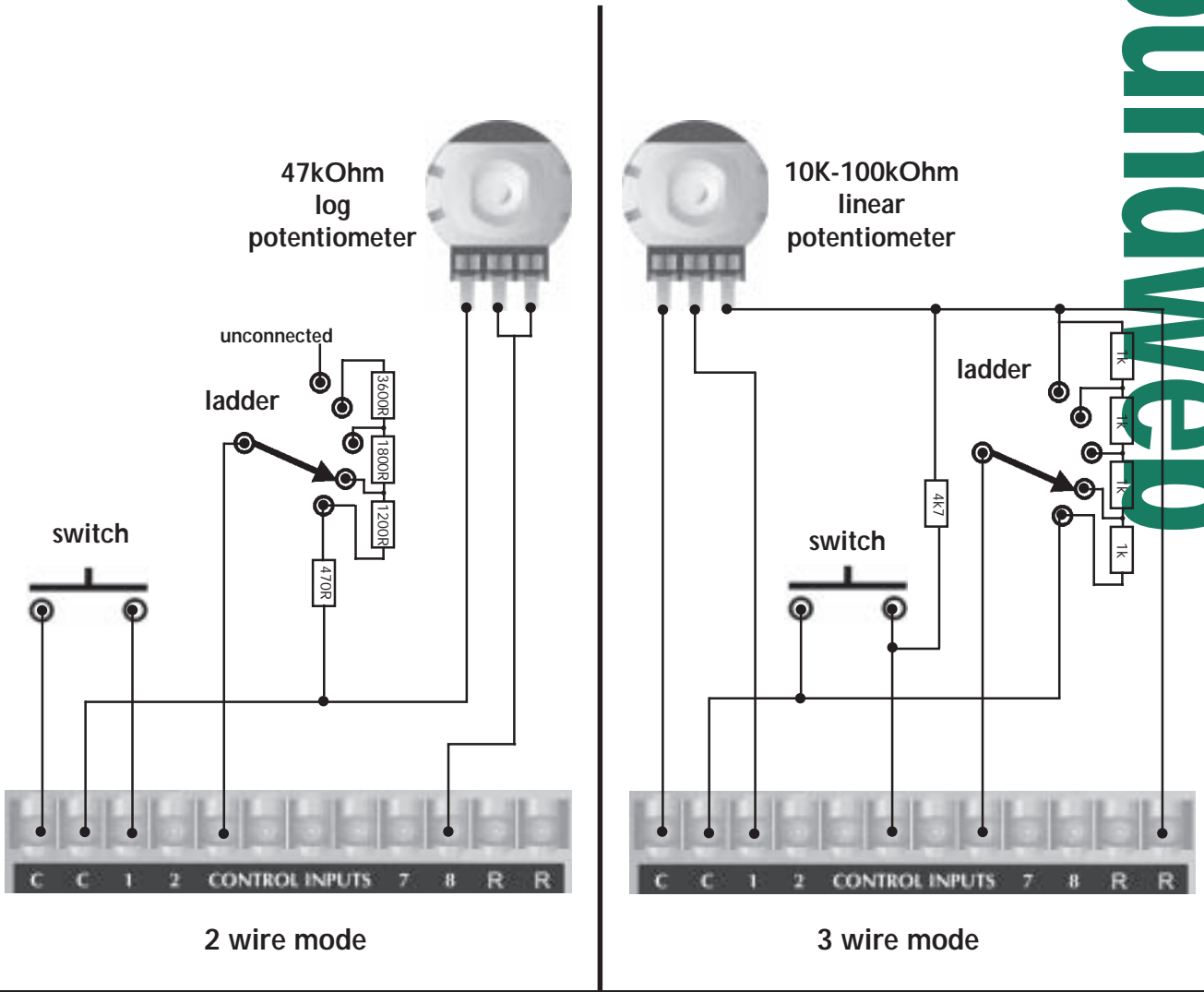

## 9088ii Technical Specifications

### General

DSP capability	200MIPS (Million Instructions Per Second)
Frequency response	15Hz to 20KHz (+-0.5dB)
Total Harmonic Distortion (THD)	<0.01% (20Hz to 0KHz, +10dBu output)
Dynamic range	105dB typical (22Hz to 22KHz unweighted) 108dB typical (A-weighted)
Maximum output level	+20dBu
Inter-channel crosstalk	<-75dB
Maximum network cable length	300m/1000ft
Mains supply	85-270V AC, 50/60Hz
Power consumption	<35VA

### Control Ports

Control input voltage	0 to 4.5v
Control input impedance (2 wire mode)	4.7kOhms to +5V
Control input impedance (3 wire mode)	>1MOhm
Logic output voltage	0 or +5V unloaded
Logic output impedance	440 Ohm
Opto output current	14mA max
Opto output withstanding voltage	80V max
Opto output series impedance	220 Ohms (isolated)

### Card Options:

#### Universal microphone/line input card

Input impedance	3.5kOhms
Maximum input level	+20dBu (with 0dB gain)
Gain range	0 to 70dB
CMRR	>75dB at 1KHz
Equivalent Input Noise (EIN)	<-128dBu typical (with 150 Ohms source)
Phantom power	48V nominal

#### AES Digital Card

Interface standard	AES/EBU
Digital resolution	24bit
Supported input sampling rates	32-96kHz
Supported output sampling rates	44.1, 48, 88.2, 96kHz (independent for each output)
Output clock source	Internal, Inputs 1 & 2, External Word Clock or System Clock (48kHz)



# Soundweb™

---

9016 Video/Audio Switcher

## Installation Guide

Soundweb™



## Important Safety Information - Read this carefully

This equipment has been tested and found to comply with the following European and international Standards for Electromagnetic Compatibility and Electrical Safety:

Radiated Emissions (EU):	EN55013	(1996)
RF Immunity (EU):	EN55013-2	(1996)
Electrical Safety (EU):	EN60065+A11	(1998)
Electrical Safety (USA):	UL6500/ETL	(2000)
Electrical Safety (CAN):	CAN/CSA-E65/ETLc	(1994)



**Before using the apparatus, read these instructions. Follow all instructions, heed them and keep them in a safe place.**

- \* Clean only with a damp cloth.
- \* Do not block any of the ventilation openings. Install in accordance with the manufacturers instructions.
- \* Do not place objects filled with liquid on this apparatus.
- \* Do not defeat the safety purpose of the grounding type plug. A grounding plug has two blades and a third grounding prong. The third prong is provided for your safety. When the provided plug does not fit into your outlet, consult an electrician for replacement of the obsolete outlet.
- \* Protect the power cord from being walked upon or pinched, particularly at plugs, convenience receptacles and the point where they exit from the apparatus.
- \* Only use attachments/accessories specified by the manufacturer.
- \* Unplug this apparatus during lightning storms or when not in use for a long time.

**WARNING - TO REDUCE THE RISK OF FIRE OR SHOCK, DO NOT EXPOSE THIS APPARATUS TO RAIN OR MOISTURE.**

**DO NOT REMOVE COVERS. NO USER SERVICEABLE PARTS INSIDE - REFER SERVICING TO QUALIFIED SERVICE PERSONNEL.**

**THIS EQUIPMENT MUST BE EARTHED.**



**IT SHOULD NOT BE NECESSARY TO REMOVE ANY PROTECTIVE EARTH OR SIGNAL CABLE SHIELD CONNECTIONS TO PREVENT GROUND LOOPS. ANY SUCH DISCONNECTIONS ARE OUTSIDE THE RECOMMENDED PRACTICE OF BSS AUDIO AND WILL RENDER THE EMC OR SAFETY CERTIFICATION VOID.**

For continued compliance with international EMC regulations, it is important that all cables be screened, and connected as follows:

- Audio cable screens to their 9016 connector ground.
- Control cable screens to the ground screws adjacent to the connector.



## Mechanical Installation

If the unit is likely to undergo extreme vibration through extensive road trucking and touring, it must be supported at the rear and/or sides to lessen the stress on the front mounting flange. Use either a ready-built rack tray or mount the 9016 unit between other units. Damage caused by insufficient support is not covered by the warranty. To prevent cosmetic damage to the front panel finish, use protective plastic cups under the rack mounting bolts.



## Front Panel LED Functions

### Zone

The unit is operating in zone mode with no presets loaded into it. Voltages presented to the control port switch stereo pairs of inputs to stereo pairs of outputs, with video following audio.

### Preset

The unit is operating in preset mode. Voltages presented to the "Z1" section of the control port will recall presets from memory.

### Device A

The unit is addressed as device A.

### Device B

The unit is addressed as device B.

### Soundweb

The unit is operating at the correct serial bitrate for connection to a Soundweb unit (38400bps)

### Power

When illuminated, indicates that the power supply is functioning.

### Activity

Flashes when a command is being processed.

### User

The unit is operating at a user-definable serial bitrate.

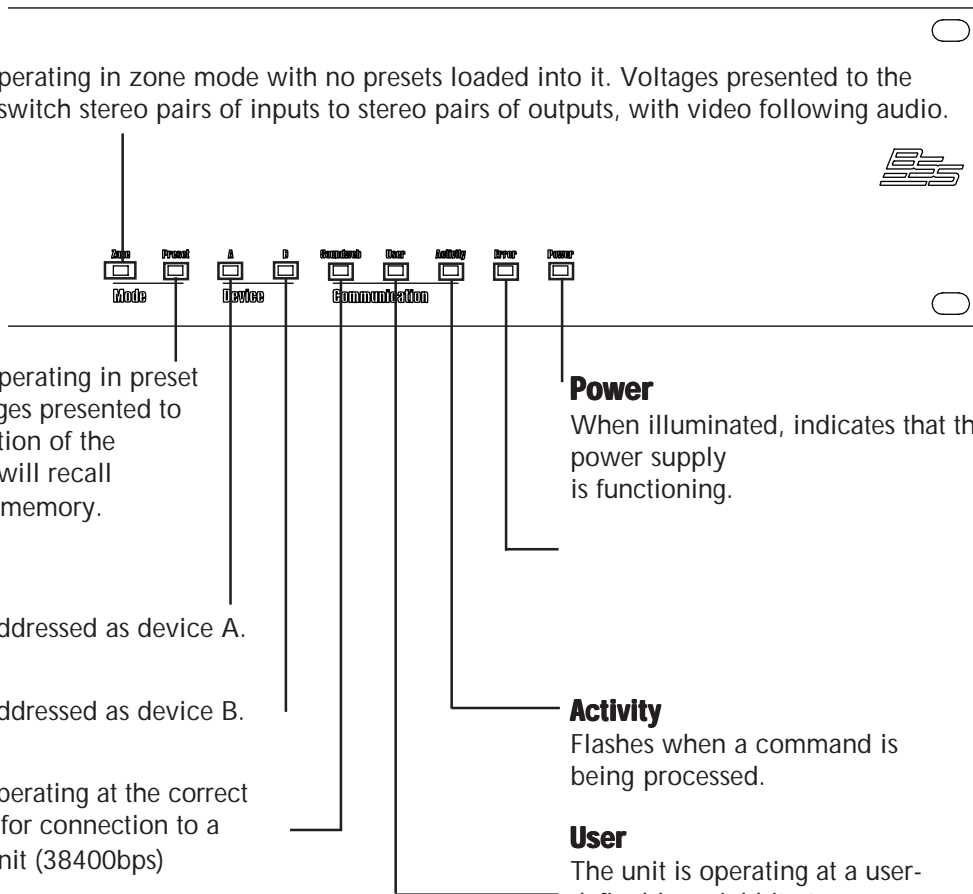



## Rear Panel Details

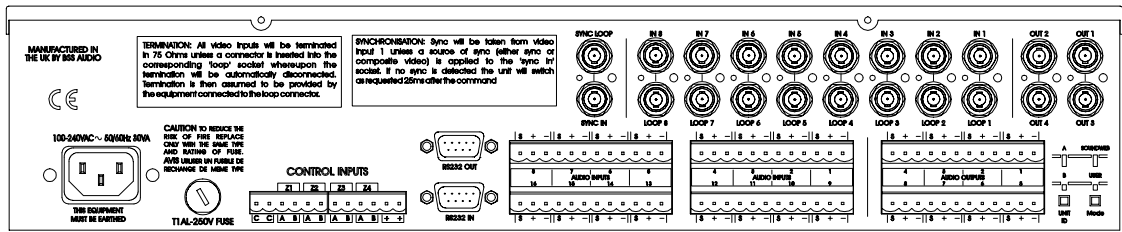

The 9016 audio and control connections are via Klippon (also known as BL, Phoenix or Combicon) pluggable terminal block connectors.

12 x 6-way female Klippon connectors are supplied for making these connections. For audio cables and looms, see the Product Overview 2000 catalogue from:

Direct Cable Systems Ltd.

Tel: (020) 7485 0899

www.directcable.co.uk

Phoenix-XLR audio cable

P/N 100521

**Balanced** wiring - The convention for balanced wiring (2-core plus shield) is:

**Balanced connection**

**9016 connection**

Pin 3 : Cold '-'  
Pin 2 : Hot '+'  
Pin 1 : Shield

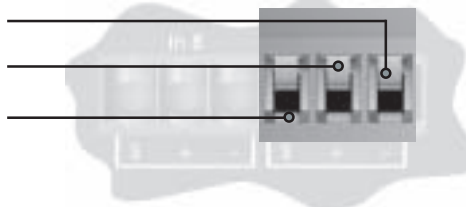

**Unbalanced** wiring - The convention for unbalanced wiring to the inputs (1-core plus shield) is:

**Unbalanced connection**

**9016 connection**

Pin 1 : Shield  
Pin 2 : Hot '+'  
Pin 3 : Link to Pin 1  
(Optional for 9016 inputs)

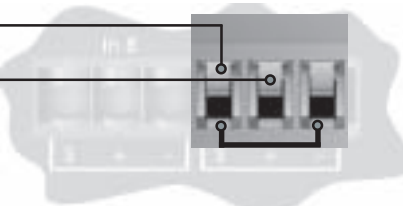

### Mains inlet

IEC power connector, for connection to mains supply (100-270V AC, 50/60Hz).

### Mains fuse holder

Requires a 20mm T1A type fuse. Do not replace with anything other than the recommended fuse.



**Video Inputs and Outputs**

The video connections are on BNC connectors on the rear of the unit.

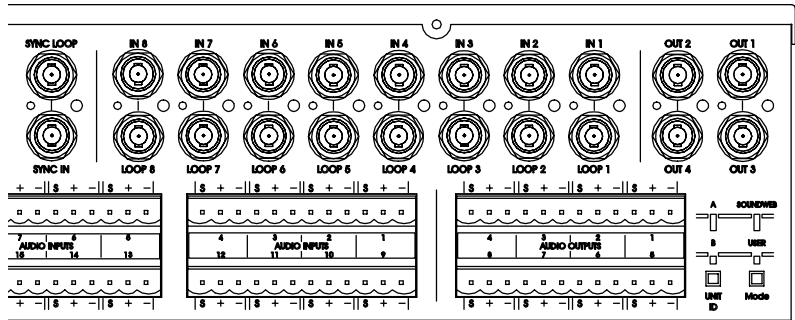

There are 8 inputs, each with a loop-through socket. If nothing is plugged into the loop connectors, then the video signal will be 75-ohm terminated inside the unit. If the loop sockets are connected, then whatever is plugged into them will have to provide 75-ohm termination itself. There are four video outputs.

The “sync in” socket should be connected to a pure sync or composite video source of synchronisation which the unit will use when instructed to set a video crosspoint. If nothing is plugged into this socket, the unit will take it’s synchronisation from the composite video source connected to video input 1. If the unit does not receive a sync pulse within 25ms of a command to switch being received, it will switch anyway. The “sync loop” socket outputs whatever has been used as the sync source.

**RS-232**

The RS232 port is for connecting the unit directly to a PC, or the rear port of a Soundweb 9088ii, 9000, 9000ii or 9008 device.

Soundweb devices can be connected to two 9016 units as follows:

Soundweb 9088ii, 9008, 9000 or 9000ii

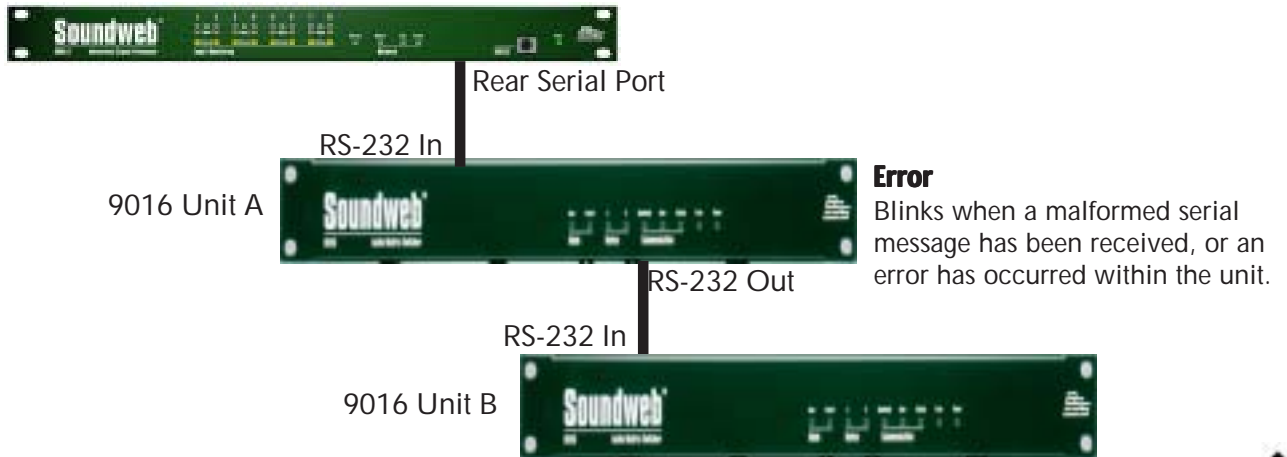

## Soundweb 9016 Installation Guide

Note: if there is only one 9016 device, it must be addressed as unit A.

For use with the PC control application, or any other device capable of implementing the unit's protocol through its RS232 port, four devices can be connected like this:



## RS-232 Port Connection Information

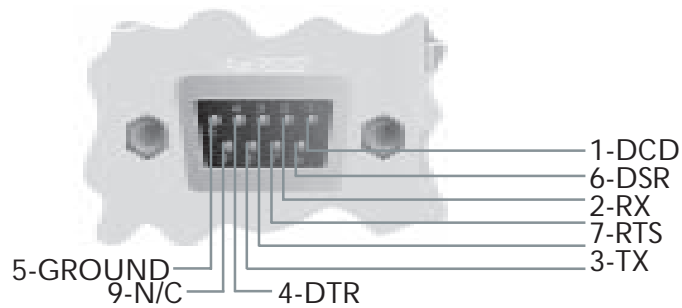

## Control Inputs

The control ports are designed to be used with a 9012 wall panel or simple switches and faders or potentiometers. There are four sets of ports, or "zones", marked Z1 - Z4. The control port facilities are used in conjunction with the PC setup software; see its online help for more details, and for electrical specifications of the 9012 and its resistor values, see Soundweb Designer's online help (under "control inputs and logic outputs").

The "A" pin of any given zone should be connected to a potentiometer for gain control. The "B" pin should be connected to a resistor ladder for preset recall/individual crosspoint control.

The unit is in "zone mode" when there are no presets loaded. (Note that these are presets within the unit and nothing to do with Soundweb Designer presets). With each 9012, you can control the routing of a stereo pair of audio channels and one video channel (a "zone"). Up to four 9012s can be connected, so all the outputs can be controlled.

The outputs controlled by each 9012 are dictated by which "Z" pair of terminals (see wiring section) they are connected to.

For example, a 9012 plugged into Z1 with the unit in zone mode will:



- let you control the gain on outputs 1&2 (stereo pair) with the pot
- let you control the source of the signals routed to audio out 1&2 and video out 1 using the selector switch. With a 9012, this can be any of the first 5 inputs.

So with the selector in position '2' in the example above:

- Audio input 5 would be routed to audio output 1.
- Audio input 6 would be routed to audio output 2.
- Video input 3 would be routed to video output 1.

The pair of inputs routed to a given output corresponds to the number printed on the 9012 control +1 e.g 0 = inputs 1+2

In "preset mode", only the 9012 wall panel connected to "Z1" has any effect. The selector will recall the unit's five internally installed presets. (again, position 0 on the selector means preset 1 will be recalled).

## Control port pin-outs

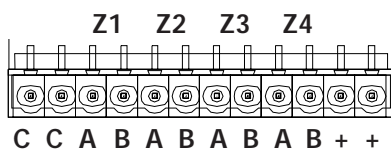

### Preset/Zone Trigger Inputs

Pin 1 is on right when viewed from rear:  
 Pin 1, 2, : +5V. Pin 11, 12 : Common  
 Zone Mode  
 Pin A Source Select, Pin B Gain  
 Preset Mode  
 Use Z1 connections only



## 9016 Technical Specifications

---

<b>Video Inputs</b>	8 Composite Video inputs (CBVS or SVideo) on BNC connectors with BNC loopthrough connectors
Video Standard	PAL or NTSC (auto selected)
Video Bandwidth	150Mhz
Video Crosstalk	<70dBR up to 10MHz
Sync	Automatically either Channel 1 or 'Sync' input
Impedance	75 Ohm self-terminating
Routing	8x4 Video Matrix
<b>Video Outputs</b>	4 x 75Ohm Composite Video Outputs on BNC connectors
<b>Audio Inputs</b>	16 Balanced Audio inputs on Phoenix Combicon removable screw connectors.
Routing	16x8 Audio Matrix, each channel independently addressable
Input Impedance	10kOhm
Maximum Input Level	+20dBu
Input gain	adjustable, -inf to +20dB (via PC App or 9012 in zone mode)
THD	<0.02%
Frequency Response	20Hz-20kHz +0/-0.2dB
S/N Ratio	>110dBR at unity gain
Crosstalk	<-100dB
CMRR	>40dBR
<b>Audio Outputs</b>	8 Balanced Audio Outputs on Phoenix/Combicon removable screwconnectors.
Output gain	adjustable, -inf to +20dB
<b>Control &amp; Presets</b>	
Presets	8 presets per video output zone when used with standalone PC application
Serial Control Port	RS-232 connects to Soundweb 9088ii, 9008ii, 9000 or 9000ii or PC
Dimensions	2RU (3.5") high, 19" wide, 6.6" deep (89mm x 445mm x 168mm)
Weight	3kg (6.6lbs) unpacked

*BSS Audio have a policy of continued product improvement and accordingly reserve the right to change features and specifications without prior notice.*





# Soundweb™

9026 Audio Switcher

## Installation Guide

Soundweb™



## Important Safety Information - Read this carefully

This equipment has been tested and found to comply with the following European and international Standards for Electromagnetic Compatibility and Electrical Safety:

Radiated Emissions (EU):	EN55013	(1996)
RF Immunity (EU):	EN55013-2	(1996)
Electrical Safety (EU):	EN60065+A11	(1998)
Electrical Safety (USA):	UL6500/ETL	(2000)
Electrical Safety (CAN):	CAN/CSA-E65/ETLc	(1994)



Before using the apparatus, read these instructions. Follow all instructions, heed them and keep them in a safe place.

- \* Clean only with a damp cloth.
- \* Do not block any of the ventilation openings. Install in accordance with the manufacturers instructions.
- \* Do not place objects filled with liquid on this apparatus.
- \* Do not defeat the safety purpose of the grounding type plug. A grounding plug has two blades and a third grounding prong. The third prong is provided for your safety. When the provided plug does not fit into your outlet, consult an electrician for replacement of the obsolete outlet.
- \* Protect the power cord from being walked upon or pinched, particularly at plugs, convenience receptacles and the point where they exit from the apparatus.
- \* Only use attachments/accessories specified by the manufacturer.
- \* Unplug this apparatus during lightning storms or when not in use for a long time.

**WARNING - TO REDUCE THE RISK OF FIRE OR SHOCK, DO NOT EXPOSE THIS APPARATUS TO RAIN OR MOISTURE.**

**DO NOT REMOVE COVERS. NO USER SERVICEABLE PARTS INSIDE - REFER SERVICING TO QUALIFIED SERVICE PERSONNEL.**

**THIS EQUIPMENT MUST BE EARTHED.**



**IT SHOULD NOT BE NECESSARY TO REMOVE ANY PROTECTIVE EARTH OR SIGNAL CABLE SHIELD CONNECTIONS TO PREVENT GROUND LOOPS. ANY SUCH DISCONNECTIONS ARE OUTSIDE THE RECOMMENDED PRACTICE OF BSS AUDIO AND WILL RENDER THE EMC OR SAFETY CERTIFICATION VOID.**

For continued compliance with international EMC regulations, it is important that all cables be screened, and connected as follows:

- Audio cable screens to their 9026 connector ground.
- Control cable screens to the ground screws adjacent to the connector.



## Mechanical Installation

If the unit is likely to undergo extreme vibration through extensive road trucking and touring, it must be supported at the rear and/or sides to lessen the stress on the front mounting flange. Use either a ready-built rack tray or mount the 9026 unit between other units. Damage caused by insufficient support is not covered by the warranty. To prevent cosmetic damage to the front panel finish, use protective plastic cups under the rack mounting bolts.



## Front Panel LED Functions

### Zone

The unit is operating in zone mode with no presets loaded into it. Voltages presented to the control port switch stereo pairs of inputs to stereo pairs of outputs, with video following audio.

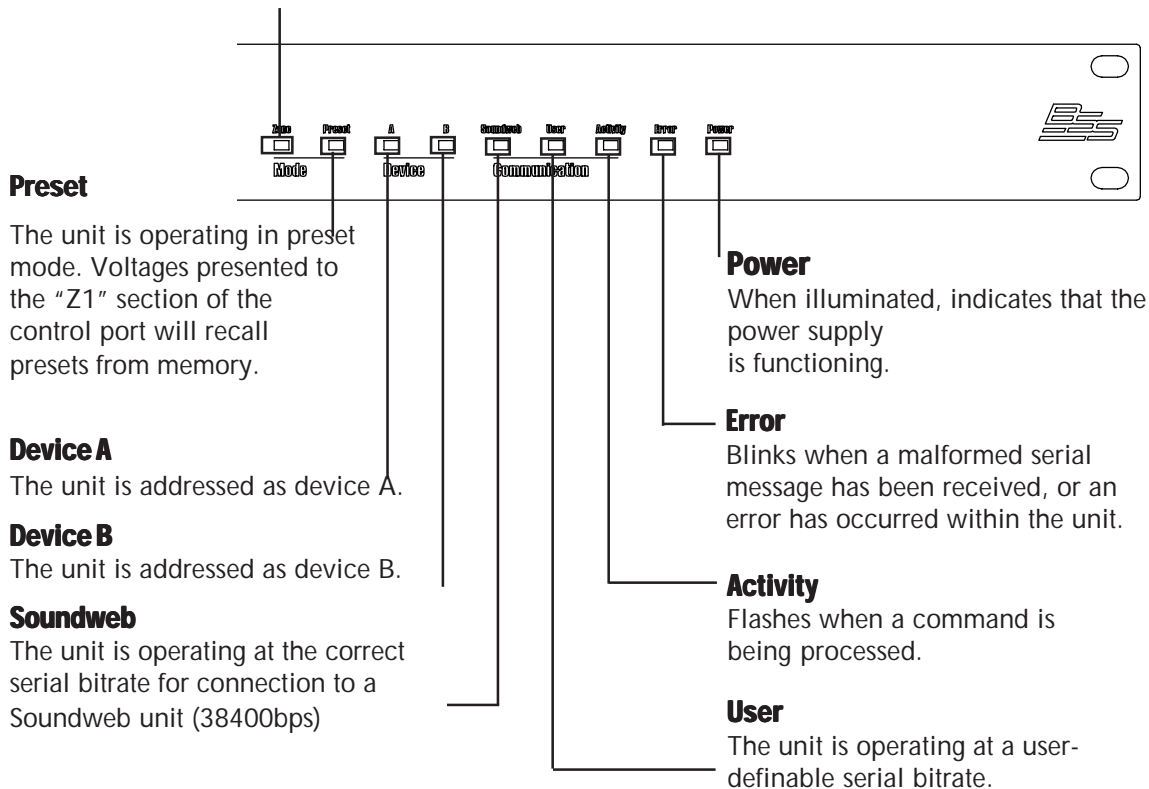



## Rear Panel Details

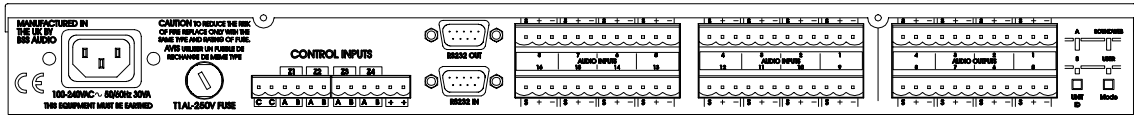

The 9026 audio and control connections are via Klippon (also known as BL, Phoenix or Combicon) pluggable terminal block connectors.

12 x 6-way female Klippon connectors are supplied for making these connections.

For audio cables and looms, see the Product Overview 2000 catalogue from:

Direct Cable Systems Ltd.

Tel: (020) 7485 0899

www.directcable.co.uk

Phoenix-XLR audio cable

P/N 100521

**Balanced** wiring - The convention for balanced wiring (2-core plus shield) is:

**Balanced connection**

**9026 connection**

Pin 3 : Cold '-'

Pin 2 : Hot '+'

Pin 1 : Shield

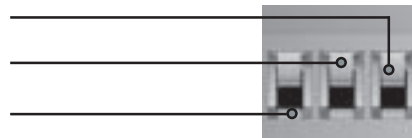

**Unbalanced** wiring - The convention for unbalanced wiring to the inputs (1-core plus shield) is:

**Unbalanced connection**

**9026 connection**

Pin 1 : Shield

Pin 2 : Hot '+'

Pin 3 : Link to Pin 1

(Optional for 9016 inputs)

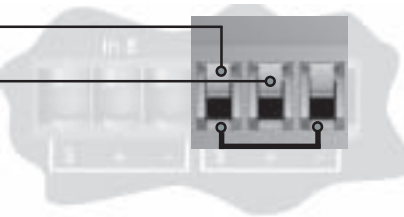

### Mains inlet

IEC power connector, for connection to mains supply (100-270V AC, 50/60Hz).

### Mains fuse holder

Requires a 20mm T1A type fuse. Do not replace with anything other than the recommended fuse.



## RS-232

The RS232 port is for connecting the unit directly to a PC, or the rear port of a Soundweb 9088ii, 9000, 9000ii or 9008 device.

Soundweb devices can be connected to two 9026 units as follows:

Soundweb 9088ii, 9008, 9000 or 9000ii



Note: if there is only one 9026 unit available, you can connect the PC control application to the unit's protocol through its RS232 port.



unit A.

able of implementing the protocol connected like this:



## RS-232 Port Connection Information

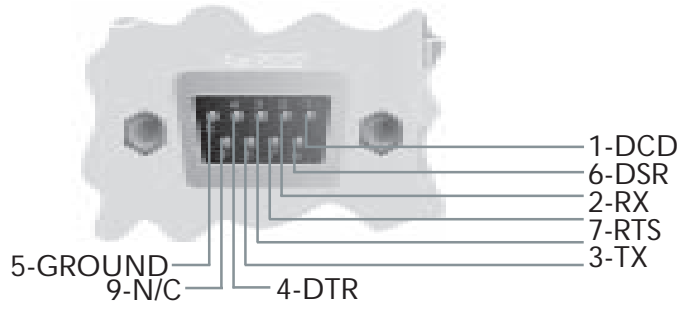

## Control Inputs

The control ports are designed to be used with a 9012 wall panel or simple switches and faders or potentiometers. There are four sets of ports, or "zones", marked Z1 - Z4. The control port facilities are used in conjunction with the PC setup software; see its online help for more details, and for electrical specifications of the 9012 and its resistor values, see Soundweb Designer's online help (under "control inputs and logic outputs").

The "A" pin of any given zone should be connected to a potentiometer for gain control. The "B" pin should be connected to a resistor ladder for preset recall/individual crosspoint control.

The unit is in "zone mode" when there are no presets loaded. (Note that these are presets within the unit and nothing to do with Soundweb Designer presets). With each 9012, you can control the routing of a stereo pair of audio channels (a "zone"). Up to four 9012s can be connected, so all the outputs can be controlled.

The outputs controlled by each 9012 are dictated by which "Z" pair of terminals (see wiring section) they are connected to.

For example, a 9012 plugged into Z1 with the unit in zone mode will:



- let you control the gain on outputs 1&2 (stereo pair) with the pot
- let you control the source of the signals routed to audio out 1&2 using the selector switch. With a 9012, this can be any of the first 5

So with the selector in position '2' in the example above:

- Audio input 5 would be routed to audio output 1.
- Audio input 6 would be routed to audio output 2.

The pair of inputs routed to a given output corresponds to the number printed on the 9012 control +1 e.g 0 = inputs 1+2

In "preset mode", only the 9012 wall panel connected to "Z1" has any effect. The selector will recall the unit's five internally installed presets. (again, position 0 on the selector means preset 1 will be recalled).

### Control port pin-outs

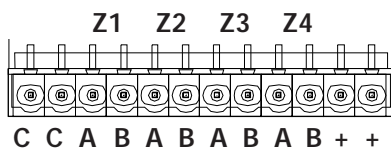

#### Preset/Zone Trigger Inputs

Pin 1 is on right when viewed from rear:

Pin 1, 2, : +5V. Pin 11, 12 : Common

Zone Mode

Pin A Source Select, Pin B Gain

Preset Mode

Use Z1 connections only



## 9026 Technical Specifications

---

<b>Audio Inputs</b>	16 Balanced Audio inputs on Phoenix Combicon removable screw connectors.
Routing	16x8 Audio Matrix, each channel independently addressable
Input Impedance	10kOhm
Maximum Input Level	+20dBu
Input gain	adjustable, -inf to +20dB (via PC App or 9012 in zone mode)
THD	<0.02%
Frequency Response	20Hz-20kHz +0/-0.2dB
S/N Ratio	>110dBR at unity gain
Crosstalk	<-100dB
CMRR	>40dBR
<b>Audio Outputs</b>	8 Balanced Audio Outputs on Phoenix/Combicon removable screwconnectors.
Output gain	adjustable, -inf to +20dB
<b>Control &amp; Presets</b>	
Presets	8 presets per video output zone when used with standalone PC application
Serial Control Port	RS-232 connects to Soundweb 9088ii, 9008ii, 9000 or 9000ii or PC
Dimensions	1RU (1.75") high, 19" wide, 6.6" deep (45mm x 445mm x 168mm)
Weight	2.3kg (5lbs) unpacked

*BSS Audio have a policy of continued product improvement and accordingly reserve the right to change features and specifications without prior notice.*

### BSS Audio

A Division of Harman International Industries Ltd

Cranborne House, Cranborne Road, Potters Bar, Herts EN6 3JN England

Tel +44 (0)1707 660667 Fax +44 (0)1707 660755 <http://www.bss.co.uk>



Limited warranty	288
Introduction	288
The Serial Interface Kit FAQ	289
Hardware	292
Messaging protocol	293
Message Format	293
Message Body Format	294
Message Types	294
Protocol details	295
Implementing the Soundweb/AMX protocol on other equipment	296
Sending out a message	296
Receiving a message	297
AMX control	298
Equipment required:	298
AMX touch panel	298
Procedure	299
Example code	300
Object detail	301
Interfacing to Non-AMX Equipment	302
Debugging	302
Setting up a device for raw messages	302
Message Format	303
Processing Object Handles	303
Processing Object Methods	303
Method Values	303
Activating Presets	305
Activating Parameter Presets	305
Sending and Receiving Messages	307
Example Messages	308
Messages	309



Appendix A - Processing Object Methods	310
Soundweb 9088 DSP	310
Gain	311
Delay	311
Parametric Eq	311
Crossover	312
Mixers	313
Matrix Routers and Mixers	316
Graphic Eq	318
Metering Point	319
Source Selector	319
Compressor	320
Limiter	320
Leveller	320
Filter High Pass And Low Pass	321



## Limited warranty

**No warranties:** BSS Audio expressly disclaims any warranty for the 'Soundweb Interface Kit'. The 'Soundweb Interface Kit' and any related documentation is provided 'as is' without warranty of any kind, either express or implied, including, without limitation, the implied warranties or merchantability, fitness for a particular purpose, or non infringement. The entire risk arising out of use or performance of the 'Soundweb Interface Kit' remains with you.

**No Liability for damages:** In no event shall BSS Audio or its suppliers be liable for any damages whatsoever (including, without limitation, damages for loss of business profits, business interruption, loss of business information, or any other pecuniary loss) arising out of the use of, misuse of, or inability to use this BSS Audio product, even if BSS Audio has been advised of the possibility of such damages. Because some states/jurisdictions do not allow the exclusion or limitation of liability for consequential or incidental damages, the above limitation may not apply to you.

BSS Audio is a division of Harman International Industries Ltd., 4<sup>th</sup> floor, Windsor House, Pepper Street, Chester CH1 1DF, United Kingdom.

## Introduction

This document is intended for Soundweb users who wish to provide their own user interface for a Soundweb system. The user interface can be based on an PANJA system, a PC running a custom application, or even a custom piece of hardware.

There are two ways in which the developer can control a Soundweb network. There's the PANJA interface which is a very simple RS232 protocol designed for use with PANJA devices running the AXCESS development system. However, the PANJA RS232 protocol is tailored for PANJA, and is therefore not generic enough to control all of Soundweb's processing objects. For this reason we created the RAW\_MSG extension which gives almost complete control of a Soundweb network via RS232.

Both protocols share the same message protocol and use the rear RS232 port of a Soundweb device.





## The Serial Interface Kit FAQ

v1.4 29/11/00

- Q1. AMX interfacing - where do I start?
- Q2. Are there any examples?
- Q3. What if I already have an AMX system in use?
- Q4. How do handles work?
- Q5. Where do I get handles from?
- Q6. So, what are method codes then?
- Q7. Are presets global?
- Q8. How do I control a matrix mixer?
- Q9. What's the most efficient way to switch between two configurations with the control port?

### Q1. AMX interfacing - where do I start?

A1. A complete walk-through of setting a system up to interface with an AMX panel is in the Soundweb help. It describes both hardware and software requirements and is for a user who wants to add a panel to his Soundweb network. The idea is that you should not need to write any code if you just want a panel on your system.

### Q2. Are there any examples?

A2. Yes. There is a file called Example.SDF available which is a system with various objects already set up.

### Q3. What if I already have an AMX system in use?

A3. If, after generating the code from Soundweb Designer, you have channel codes that conflict with ones already on the panel, you can edit SWFUNC.AXI which is where PUSH events (etc.) meet our messaging functions. You must include the library functions which are to be run inside mainline for messages to be sent and received.

### Q4. How do handles work?

A4. Each processing object in a design file (.SDF) is allocated a unique number to identify it when the design is compiled. If there is more than one unit in the design, a range of numbers are allocated to each box. This range is big enough for more processing objects than you could possibly need or even fit in one unit. It is 100000 in hexadecimal (written 0x100000 or



100000h) which is 1048576 in decimal.

For example a gain element in the first unit may be allocated the number 2. The first handle, 1, is reserved for the box itself for permanent objects associated with the box rather than the design you have created such as phantom power on the inputs, gain trim on the outputs.

The second unit in a design will have the handle 0x100001 and processing objects will start from 0x100002. Because of these ranges, the number will always be a dword, or 4 bytes or 32 bit value when used in a messaging protocol.

## Q5. Where do I get handles from?

A5. They do not exist until you have compiled your design file (.SDF) in Soundweb Designer. Once compiled, you can find them by moving the mouse over the object in the design and the handle will appear in the status bar which is in the bottom left of the main Soundweb designer window. This is one of the places where an application would normally tell you what buttons do as you pass the mouse pointer over them.

## Q6. So, what are method codes then?

A6. Each processing object has a unique handle to identify it but this one reference is not enough to uniquely identify a particular control. For example, our gain element has three controls associated with it. These are the gain itself or the fader, the mute button and the phase button. We give these three controls numbers which we call method codes because they identify a function or method of an object. You may have noticed that these numbers are re-used on different processing objects - this is because the handle makes the control unique.

Think of method codes like doors, windows and chimneys and handles as the house number. Two houses can have the same chimney but will be unique if referred to with the house number as well. Method codes are also dwords or 4 bytes or 32 bit values, however you like to think of them.

## Q7. Are Presets global?

A7. There are two type of presets. Parameter presets involve all the controls on the map window in which they are created. A common technique is to have a special map window for the controls your are interested in and make the preset there. This preset bar is then copied to your main control panel.

Major presets have the option to include devices at your discretion to save memory. These

presets can affect the entire network. Each box has a copy of the control ids and parameter values for each control in the preset. Activation is a single message rather than all the values sent around. If a box doesn't contain any controls in the preset, it doesn't need a copy of the preset.

## Q8. How do I control a matrix mixer?

- A8. The gain of each route channel is controlled by using a method code calculated as follows:  
Identify the output you want to route.  
Find the base method code for this in this Soundweb interface kit document. They start at 0x01000800.  
Add to this the input channel-1.

Routing is similar but the base method codes start at 0x01001000, e.g. the button for Output 5 Input 4 has a method of  $0x010010C0+4-1 = 0x010010C3$ .

## Q9. What's the best way to switch between two configurations with the control port?

- A9. Use a couple of Presets. We recommend two momentary buttons. If you change to each configuration and store this in a preset, you can add a preset button for each, then drag these preset buttons onto control inputs.

See the section on Presets in the online help in Soundweb Designer for further information.

## Hardware

### Soundweb to AMX

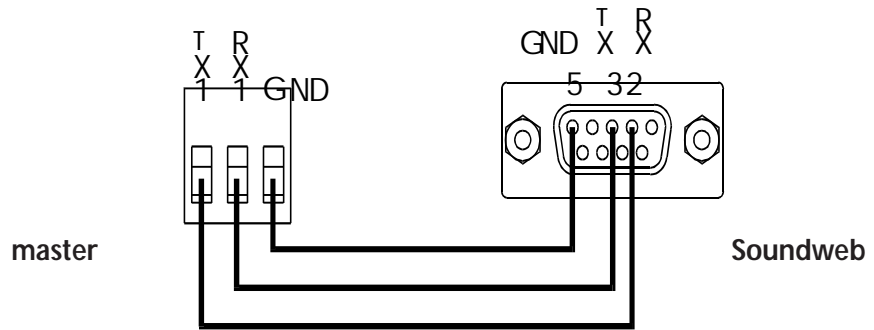

3-wire Null modem cable for AMX to Soundweb connection.

### PC to Soundweb (Rear RS232) Cable

7-wire Null modem cable.

## Messaging protocol

- Always use 8-bit data with no parity.
- Bit rate 38400 bps.

The following bytes have special meanings:

- 0x02 **STX**
- 0x03 **ETX**
- 0x06 **ACK**
- 0x15 **NAK**
- 0x1B **Escape**
- Any other single byte can be used within a message body

To use one of the special bytes within a message body, do the following:

- 0x02 - substitute with 0x1B 0x82
- 0x03 - substitute with 0x1B 0x83
- 0x06 - substitute with 0x1B 0x86
- 0x15 - substitute with 0x1B 0x95
- 0x1B - substitute with 0x1B 0x9B

The following bytes are command bytes to appear at the beginning of a message after **STX**.

- 0x80 **SET\_VALUE**
- 0x81 **SET\_STRING**
- 0x82 **REQUEST\_VALUE**
- 0x83 **REQUEST\_STRING**
- 0x84 **RAW\_MSG**

## Message Format

*<message>* = *<STX>* *<Body>* *<Checksum byte>* *<ETX>*

*<Checksum byte>* is the xor of all the bytes in *<Body>*

### Note:

If the checksum is one of the special characters it must be substituted in the same way as body bytes.



## Message Body Format

This is one of the following:

<Body> = <SET\_VALUE> <group> <id> <value Hi> <value Lo>  
 or <SET\_STRING> <group> <id> <char 0> <char 1> <char 2>...<Zero>  
 or <REQUEST\_VALUE> <group> <id>  
 or <REQUEST\_STRING> <group> <id>  
 or <RAW\_MSG> <Soundweb Message>

<group>

a byte identifying which type of control you are changing.

<id>

a byte uniquely identifying which control of the group you are changing.

<Value Hi> <value Lo>

a sixteen bit value.

<char 0> <char 1> <char 2>...<Zero>

an ASCII null-terminated string in the standard Windows character set.

<Soundweb Message>

a raw Soundweb message.

The following group numbers are allocated.

SW_AMX_BUTTON	= 0	(* MOMENTARY BUTTONS (255) *)
SW_AMX_TOGGLE	= 1	(* LATCHING BUTTONS. (255) *)
SW_AMX_LED	= 2	(* LED'S (255) *)
SW_AMX_PRESET	= 3	(* MOMENTARY, AND LINKED TO PAGE CHANGE. *)
SW_AMX_SPIN	= 4	(* CONTINUOUSLY SENDS WHILST HELD DOWN. *)
SW_AMX_LEVEL	= 5	(* THERE ARE 32 LEVELS - FADERS AND BARGRAPHS *)
SW_AMX_SOURCE	= 6	(* SOURCE SELECTORS - MUTUALLY EXCLUSIVE *)
SW_AMX_TEXT	= 7	(* THERE ARE 255 SUB TEXT FEEDBACKS *)

## Message Types

**SET\_VALUE** is sent from Soundweb to AMX to indicate that a value has been changed which must be reflected on the PANJA controller. The same message from AMX to Soundweb indicates that the user has moved a control which must be reflected on the Soundweb system.

On issuing a **SET\_VALUE** the Soundweb to PANJA messaging code detects when a value has been changed as a result of activity on the PANJA system, but does NOT echo the changes. The AMX system is expected to do the same - this is necessary in order to avoid an endless loop whereby the two systems send messages to each other continuously.



**RAW\_MSG** is used to send raw Soundweb messages to and from external equipment via the RS232 port. The AMX system ignores these messages.

**SET\_STRING** is reserved for future use.

**REQUEST\_VALUE** is reserved for future use.

This message would be sent by one or other side in order to demand a **SET\_VALUE** for a particular parameter and would typically be used at start-up to ensure that the two sides are in sync. The other side responding with a **SET\_VALUE** message.

**REQUEST\_STRING** is reserved for future use.

This would be sent in order to demand a piece of text. The correct response is a **SET\_STRING** message.

## Protocol details

When a message is received successfully, an **ACK** is returned. This should be done within one second of receiving the **ETX**.

When a message is received unsuccessfully, (determined by the checksum being incorrect or the frame incorrectly formed with start and end characters), a **NAK** is returned. This should be done within one second of receiving the **ETX** (or the last character received).

If an **ACK** or **NAK** is not received within 1 second of sending a message, then the message should be resent.



## Implementing the Soundweb/AMX protocol on other equipment

It is quite possible for other equipment to talk to a Soundweb device using the Soundweb/AMX protocol. It is simply a matter of implementing the protocol on the chosen platform.

### Sending out a message

The following pseudo code sends a message by putting in escape characters, checksum **STX** and **ETX**.

```
SEND (STX)

CHAR CHECKSUM = 0

FOR EACH CHARACTER IN MESSAGE BODY
{
    CHECKSUM = CHECKSUM XOR CHARACTER

    IF (IS_SPECIAL (CHARACTER))
    {
        SEND (ESCAPE)
        SEND (CHARACTER + 128)
    }
    ELSE
    {
        SEND (CHARACTER)
    }
}

IF (IS_SPECIAL (CHECKSUM))
{
    SEND (ESCAPE)
    SEND (CHECKSUM + 128)
}
ELSE
{
    SEND (CHECKSUM )
}

SEND (ETX)

/* NOW WAIT FOR AN ACK OR NAK */
```





## Receiving a message

The following pseudo code receives a message, takes out escape characters, and makes sure the message is valid by looking at the checksum.

```
/* TELLS US THAT THE PREVIOUS CHARACTER WAS ESCAPE*/
BOOL GOT_ESCAPE

CHAR CHECKSUM = 0

ON RECEIVED CHARACTER
{
    IF (CHARACTER = STX)
    {
        /* START OF MESSAGE */
        CHECKSUM = 0

        /* CLEAR THE MESSAGE BUFFER */
        CLEAR_MESSAGE_BUFFER()
        GOT_ESCAPE = FALSE
    }
    ELSE IF (CHARACTER = ETX)
    {
        /* END OF MESSAGE, CHECK THE CHECKSUM */
        IF (GET_LAST_BYTE_IN_MESSAGE_BUFFER() = CHECKSUM)
        {
            /* THE MESSAGE IS OK */
            SEND (ACK)
        }
        ELSE
        {
            SEND (NAK)
        }
        GOT_ESCAPE = FALSE
    }
    ELSE IF (CHARACTER = ESCAPE)
    {
        GOT_ESCAPE = TRUE
    }
    ELSE
    {
        IF (GOT_ESCAPE = TRUE)
        {
            ADD_BYTE_TO_MESSAGE_BUFFER (CHARACTER - 128)
            CHECKSUM = CHECKSUM XOR (CHARACTER - 128)
        }
        ELSE
        {
            ADD_BYTE_TO_MESSAGE_BUFFER (CHARACTER)
            CHECKSUM = CHECKSUM XOR CHARACTER
        }
        GOT_ESCAPE = FALSE
    }
}
```



## AMX control

### Equipment required:

- AMX AXCESS or NETLINX master device
- AMX touch panel or other input device
- 12V DC supply
- AX link cable

## AMX touch panel

There are 255 available channels which can be assigned to buttons or icon objects on the panel. These allow presses to be processed and sent to Soundweb and for visual feedback to be echoed to the panel. In addition to this, there are 32 level channels which are linked to level controls or bar graph meters.

The library functions make use of a variable number for every control on the touch panel. How this variable number maps to a channel code is explained below for each control, the result being that some channel codes are not used. We recommend that channel codes for other devices in a shared system, i.e. one that has device control in addition to Soundweb on the same master, be allocated from outside the range of channel codes used by the export process, even if it appears they are not being used.

For example:

A level control requires a variable number to store its value and subsequently this variable number will not be available for use as a channel code within the Panja to Soundweb communication system.

Source selectors require a channel code for each button in the exclusive group but only use one variable number to store the overall state.

Spin pairs require a channel code for each of the up and down buttons but have only one variable to store the current setting.

All other controls: presets and buttons have a direct mapping of channel code to variable number.

The master, AXB-EM232, is one of a number of available masters which stores and executes the AXCESS programming language.

The library, SWLIB.AXI has been written in such a way that it can be compiled for Netlinx or AXCESS.



## Procedure

1. Having designed your Soundweb audio layout, open the **Serial** Input/Output map window.
2. Place the controls you wish to export to AMX on this map window.
3. Go to the Serial menu and choose Panja export to generate the file **SWFUNC.AXI**.

This file contains functions to map Soundweb controls to equivalents on the touch panel. When opened in a text editor, the file will contain comments at the top describing how to assign channel codes on the touch panel.

4. Run the **AXCESS** compiler program or PANJA Studio and create a new project, importing the files **BSSMAIN.AXS**, **SWLIB.AXI** and **SWFUNC.AXI**.

5. **BSSMAIN.AXS** is supplied as an example minimum to get your system running. For Soundweb controls to coexist with controls for other systems the relevant calls from this file may be placed in another .AXS file or you may add extra functions to this one.

Avoid using the channel codes that have been allocated in **SWFUNC.AXI**.

6. Compile as **AXCESS** or **Netlinx** as appropriate (the export and library are compatible with both) and download to the **Master**.

Before anything will work, you must have buttons and levels on the panel with the correct channel codes as described in the **SWFUNC.AXI** comments.

7. Set up the buttons with the following attributes:
  - Toggling buttons are to be channel feedback.
  - Text objects have a variable text number and a channel number of zero.
  - Level objects have a unique level number from 1 to 32.
  - Preset change buttons can have a page change associated with them and are momentary feedback.
  - Spin pairs are momentary feedback.
  - Source selectors are momentary buttons and have mutually exclusive and latching attributes associated with them in the master. This is done automatically by the exported code.

8. Finally, compile the Soundweb layout and load the Soundweb device.

Upon loading, the back serial port will be configured for PANJA control (currently at 38,400 baud 8N1 and no handshaking) and messaging will commence.



## Example code

Parts of **SWFUNC.AXI** will look like this:

```
(* --> 'U1/P5/Mute' *)
    PUSH [TP, 10]
        CALL 'SW TOGGLE BUTTON' (10,SW_TOGGLE)
    [TP,10] = SW_CONTROL_VAL[10]
(* <-- *)
```

Placelholding comments surround each exported control:

```
(* --> *)
(* <-- *)
```

All calls to **SWLIB**, the library module, start with **SW**.

**SWLIB.AXI** provides the background handling of buttons, level controls, spin pairs, metering and all the messaging to the Soundweb unit. This has much more functionality as library functions than the exported code puts to use. It serves as an example of more complex control types that can be implemented on an AMX touch panel.

All the designer need do to get a system up and running is to have an **INCLUDE 'SWFUNC.AXI'** statement at the top of the main file and the following two calls:

```
DEFINE_START
CALL 'SW INIT CONTROLS'

DEFINE_PROGRAM
CALL 'SW RUN CONTROLS'
```

In this way, Soundweb controls and background messaging can coexist with any other code in the master by being completely encapsulated in the include files.



## Object detail

A toggle button is realised by using script for updating the feedback and sending the status to the Soundweb unit each time it changes. Similarly, Soundweb can toggle the control on the touch panel.

- An LED is a button with attributes that can be changed remotely. Its presses are not serviced.
- A preset is a momentary button which fires off a message. Soundweb Designer exports a list of associated controls in an exclusive group. Source selectors are set up in a similar way.

Controls in a parameter preset need to be set up as mutually exclusive. It is also necessary for these controls to be defined as latching. The AMX master handles update of mutually exclusive controls so all that is required is an ON message for a particular source or preset and the others are cleared.

In order for the relevant controls to come in and out of scope for a particular preset, it is proposed that a preset change involves a change in touch panel page so that there is no chance of a user pressing a button that is not relevant for that preset. If the user changes page, it is up to the designer to ensure that the Soundweb unit is notified with a preset change at the same time.

This can be done by allocating the page change button a channel code and sending a preset change. SWFUNC contains some extra code associated with preset buttons for changing page.

Uncomment this and change to your page name:

```
(* --> `U1/Preset 1' *)
    PUSH [TP, 20]
        CALL `SW RECALL PRESET' (20)
(* uncomment the next line and change to your page name *)
(*      CALL `SW SEND PAGE CMD' (``Page name'')      *)
(* <-- *)
```

- A level control is an on-screen fader which is continuously monitored by AXCESS. Any changes in these controls will be sent to the Soundweb unit.



## Interfacing to Non-AMX Equipment

Most external equipment will use the RAW\_MSG message to communicate with Soundweb, as this enables detailed and accurate control of every processing object. However, if you are using control equipment such as Crestron and Dataton, and require a simpler, less accurate method, SET\_VALUE type message strings can be used by entering them into the design software.

To generate these strings and to serve as a test application, we have supplied the Soundweb message tool. This application allows you to construct messages with a simple dialogue and send them to a Soundweb device. The actual bytes sent are displayed in a text field in hexadecimal.

e.g.

SET\_VALUE, Button, 1, 1 translates as:

2, 80, 0, 1, 0, 1, 80, 3

Hex 80 may also be written as \$80 or 0x80 or &H80 or 80H, depending on your control system.

## Debugging

A good way of debugging a system is to be connected to the front port of a Soundweb device from Soundweb Designer and to run the message tool connected to the rear port of the device. With this method, messages can be tested from both directions; sending from the unit by adjusting a control in Soundweb designer and by sending from the message tool. Messages sent from Soundweb will appear in the incoming box and serve as examples of message construction for sending from your piece of equipment, (since they will be the same).

Remember, start simple with perhaps just a couple of mute buttons to establish you have everything cabled correctly and each device configured correctly.

A Soundweb Designer file ( Example.sdf) is supplied which has an example of each type of control that can be remotely controlled with this method.

Refer also to the Serial Interface Kit FAQ for more details.

## Setting up a device for raw messages

Soundweb devices do not normally send and receive the Soundweb messages out of the rear RS232 port. Instead the back port is usually used as an alternative to the front port for connecting to Soundweb Designer. Therefore the device must be told to use the back port for Soundweb messages. This is done by renaming the device object in the layout so that the name ends with the characters '+s' e.g. "MyDevice +s". The device will need rebooting after the name change for the change to take effect.

NOTE: This naming convention is only used as a temporary device until a version of Soundweb Designer is released which allows the user to set the back port mode explicitly.



## Message Format

The format of the RAW\_MSG message is:

**RAW\_MSG** <*Soundweb Message*>

where the format of the '*Soundweb Message*' is

<**Handle**> <**Method**> <**Value**>

where

- **Handle** (32 bit) is the identifier of the object that the message is to/from.
- **Method** (32 bit) is the object's 'method' that has changed.
- **Value** (16 or 32 bit) is the new value of the method.

NOTE: In the following paragraphs, numbers are represented in both decimal and hexadecimal depending on context. Hexadecimal numbers are preceded by the characters '0x'.

Any numbers NOT preceded by '0x' are decimal.

## Processing Object Handles

Each audio processing object in a Soundweb device is given a network **Handle**. This handle is a 32 bit unique number which allows Soundweb Designer to communicate with it. Once a device has been compiled, you can find the handles for the objects by placing the mouse over each object in turn, and reading the handle displayed in the status bar.

## Processing Object Methods

A **method** of a processing object is a 'property'. For example, a gain processing object has 3 methods: Mute, Gain and Phase. If you look at the gain control panel you will see the three controls which are used to change those three methods. For processing object method numbers see Appendix A.

## Method Values

Soundweb uses 16 bit and 32 bit methods values. These values are the actual settings for the objects controls. For example, the gain method might have a value of +3dB, or the mute method might have a value of OFF.

- Object methods come in two flavours **continuous** and **discrete**.
  - Continuous: Decibels, Hz,  $\mu$ s or scalar (generic floating point values).
  - Discrete: Anything that can be represented by a fixed number of states. For example, a mute method has two states (on and off).



Nearly all continuous and discrete values are 16 bits. To represent a realistic range of values, each type is encoded in a different way.

### ***Decibels***

16 bits, a signed word in the range -32,768 to +32,767.

To find the value in dBs simply divide by 256.0.

#### *Example*

+1536 represents +6 dB.

$(1536/256 = 6)$ .

### ***Hz***

16 bits, unsigned word in the range 0 to 65535.

The frequency is 10 to the power of (value divided by 10000).

#### *Example*

33010 represents 2000 Hz.

$(10 \text{ to the power of } (33010/10000) = 2000)$ .

### ***μS***

32 bits, unsigned long in the range 0 to 4,294,967,295.

#### *Example*

1530000 represents 1.53 seconds.

### ***Scalar***

16 bits, a signed word in the range -32,768 to 32,767.

To find the value simply divide by 256.

#### *Example*

320 represents -1.25.

$(-320/256 = -1.25)$ .





## Activating Presets

Presets are activated by sending a broadcast message. A broadcast message has a handle of 0xFFFFFFFF. The method should be set to 0x0000000B and the value is the preset ID (32 bits). The preset ID is a unique identifier which is its index in the list of presets.

To find a preset's ID goto the preset view and find the preset:



Now counting from the top, the presets have the ID's 0, 1, 2, 3, 4 etc. So, the three presets shown above have the following Ids:

- Show Preset 0
- Setup Preset 1
- Test Preset 2

## Activating Parameter Presets

Parameter presets are activated in a similar way, except that the preset ID is made up of two numbers, the *parameter preset ID*, and the *state*. The *parameter preset ID* can be found by letting the mouse pause over a parameter preset bar, and a **tool tip** will pop up with the ID:

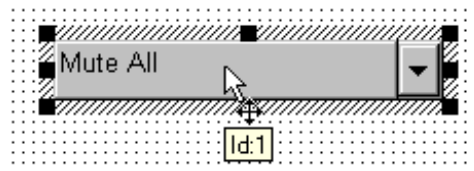

Note: The *parameter preset ID* can only be found once the system has been loaded.

Once you have the *parameter preset ID*, you need to find the *state index* in the parameter preset:

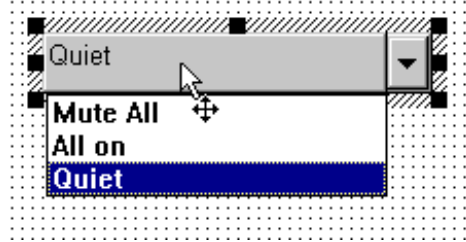

The *state index* is simply its index in the list. So, for the above parameter preset the states have these indices

- Mute All 0
- All On 1
- Quiet 2

Once you have found the *parameter preset ID*, and the *state index*, you are ready to create the preset ID. The preset ID is 32 bits long, 16 bits for the *parameter preset ID* and 16 bits for the *state index*:

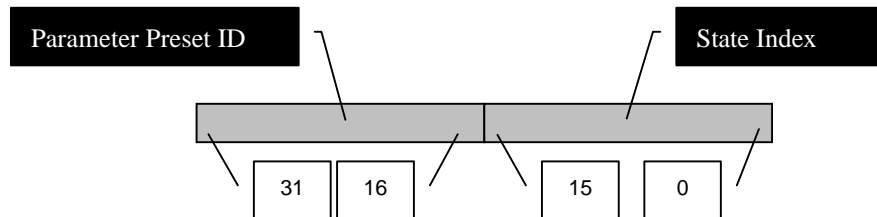

As with normal preset messages, Presets are activated by sending a broadcast message. A broadcast message has a handle of 0xFFFFFFFF. The method should be set to 0x0000000B and the value is the preset ID (32 bits).

## Sending and Receiving Messages

When a Soundweb device has been set up to send and receive Soundweb messages, then messages can be sent to any control via the RS232. However, when controls are changed via the PC or control ports a message will only be sent out of the RS232 if the control is placed on the Serial Input/Output panel of the device.

In the example Serial Input/Output panel below, the mute and level controls of a gain have been placed on U1's panel. Therefore, when the mute or level is changed a message will be sent out of U1's rear RS232 port. However, it is still possible to control other properties, such as phase, by sending messages to U1.

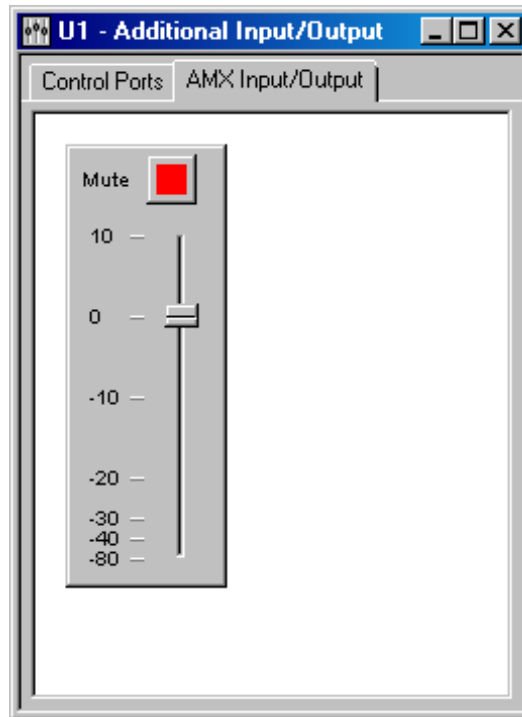

## Example Messages

The following messages would be sent to the Soundweb device to control the following configuration

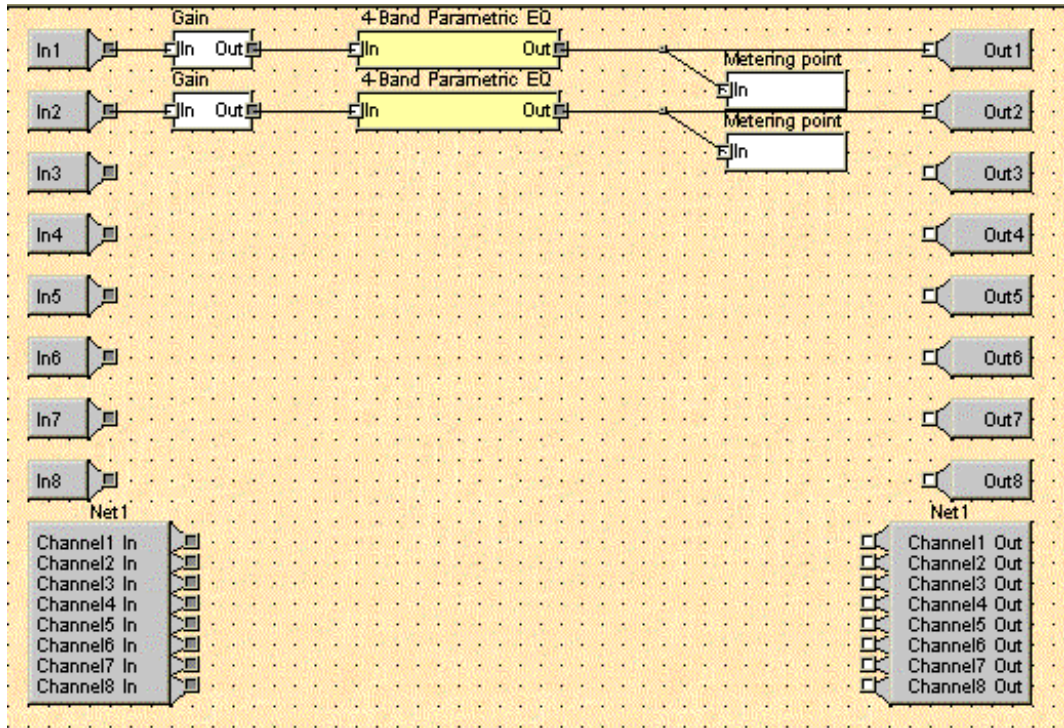

Object handles in *italics*:

Gain Objects: Gain1 (*2*) and Gain2 (*3*)

4-Band Parametric Eqs: Eq1 (*4*) and Eq2 (*8*)

Metering Points: Meter1 (*12*) and Meter2 (*13*)



## Messages

To unmute Gain1:

Handle	Method Id	Value
2	0x01000801 (Mute)	0 (off)

To unmute Gain2:

Handle	Method Id	Value
3	0x01000801 (Mute)	0 (off)

Change Eq1 filter 1 to 2000Hz, +10.0 dB, Width 1.0, bell filter type:

Handle	Method Id	Value
4	0x01000801 (Frequency)	$\log_{10}(2000.0) \times 10000$
4	0x01000802 (BoostCut)	10x256
4	0x01000803 (Width)	1x256
4	0x01000804 (FilterType)	0

Change Eq1 filter 2 to 3000Hz, -5.0 dB, Width 2.0, bell filter type:

Handle	Method Id	Value
5	0x01000801 (Frequency)	$\log_{10}(3000) \times 10000$
5	0x01000802 (BoostCut)	-5x256
5	0x01000803 (Width)	2x256
5	0x01000804 (FilterType)	0

Example messages received from meters Meter1 and Meter2:

Handle	Method Id	Value	Decoded Value
12	0x01000800 (Level)	-2476	- 9.67 dB
13	0x01000800 (Level)	-8947	- 34.95 dB
12	0x01000800 (Level)	-10	- 0.039 dB
13	0x01000800 (Level)	+258	+ 1.008 dB

Activating preset 0:

Handle	Method Id	Value
0xFFFFFFFF	0x0000000B (Preset Activate)	0

Activating preset 5:

Handle	Method Id	Value
0xFFFFFFFF	0x0000000B (Preset Activate)	5



## Appendix A - Processing Object Methods

### Soundweb 9088 DSP

These are the methods for the 9088 DSP device. These control the input and output gains, phase and phantom power.

Method Name	Method Id	Type
Phase1	0x01000809	Discrete 0 = off 1 = on
Phase2	0x0100080a	Discrete 0 = off 1 = on
Phase3	0x0100080b	Discrete 0 = off 1 = on
Phase4	0x0100080c	Discrete 0 = off 1 = on
Phase5	0x0100080d	Discrete 0 = off 1 = on
Phase6	0x0100080e	Discrete 0 = off 1 = on
Phase7	0x0100080f	Discrete 0 = off 1 = on
Phase8	0x01000810	Discrete 0 = off 1 = on
Phantom1	0x010008011	Discrete 0 = off 1 = on
Phantom2	0x010008012	Discrete 0 = off 1 = on
Phantom3	0x010008013	Discrete 0 = off 1 = on
Phantom4	0x010008014	Discrete 0 = off 1 = on
Phantom5	0x010008015	Discrete 0 = off 1 = on
Phantom6	0x010008016	Discrete 0 = off 1 = on
Phantom7	0x010008017	Discrete 0 = off 1 = on
Phantom8	0x010008018	Discrete 0 = off 1 = on
LineGain1	0x01000819	Discrete 0 = 0dB 1=12dB
LineGain2	0x0100081a	Discrete 0 = 0dB 1=12dB
LineGain3	0x0100081b	Discrete 0 = 0dB 1=12dB
LineGain4	0x0100081c	Discrete 0 = 0dB 1=12dB
LineGain5	0x0100081d	Discrete 0 = 0dB 1=12dB
LineGain6	0x0100081e	Discrete 0 = 0dB 1=12dB
LineGain7	0x0100081f	Discrete 0 = 0dB 1=12dB
LineGain8	0x01000820	Discrete 0 = 0dB 1=12dB
MicGain1	0x01000821	Discrete. Values are 0=0, 1=6, 2=12, 3=18, 4=24, 5=30,6=36 7=42, 8=48, 9=54, 10=60, 11=66, 12=72
MicGain2	0x01000822	As above.
MicGain3	0x01000823	As above.
MicGain4	0x01000824	As above.
MicGain5	0x01000825	As above.
MicGain6	0x01000826	As above.
MicGain7	0x01000827	As above.
MicGain8	0x01000828	As above.
OutGain1	0x01000829	dB (-15 to +15)
OutGain2	0x0100082a	dB (-15 to +15)



OutGain3	0x0100082b	dB (-15 to +15)
OutGain4	0x0100082c	dB (-15 to +15)
OutGain5	0x0100082d	dB (-15 to +15)
OutGain6	0x0100082e	dB (-15 to +15)
OutGain7	0x0100082f	dB (-15 to +15)
OutGain8	0x02000830	dB (-15 to +15)

## Gain

Method Name	Method Id	Type
Value	0x01000800	dB
Mute	0x01000801	0 = off, 1 = on
Phase	0x01000802	0 = off, 1 = on

## Delay

Method Name	Method Id	Type
Value	0x02000800	ms

## Parametric Eq

The parametric eq comes in 5 different configurations: 1, 2, 4, 6 and 12 bands. Each band is a separate processing object, and therefore has it's own *handle*. Soundweb will display the handle for the first eq band on the status bar when the user moves the mouse over the parametric object. The other bands in the parametric eq can be found by incrementing the handle for each band. For example, if a 4 band parametric eq displays a handle of 23, then the individual eq band objects have handles of 23, 24, 25 and 26. So, to change filter 3, send messages to object 25.

Each eq band has the follow methods:

Method Name	Method Id	Type
Bypass	0x01000800	0 = off, 1 = on
Frequency	0x01000801	Hz
BoostCut	0x01000802	dB
Width	0x01000803	Scalar (0.05 - 3.0)
FilterType	0x01000804	Discrete. Values are: 0 = Bell 1 = High Shelf 2 = Low Shelf



## Crossover

Like the parametric eqs, the crossover comprises of several individual bands which are separate objects. There are currently 5 different crossovers defined :- 1,2,3,4 and 5 bands. There is also the mon sub object which is basically a 2:1 mixer followed by a crossover band.

Method Name	Method Id	Type
LowPassType	0x01000800	Band type (see below)
HighPassType	0x01000801	Band type (see below)
LowPassFrequency	0x01000802	Hz
HighPassFrequency	0x01000803	Hz
BandGain	0x01000804	dB
Threshold	0x01000805	dB

Band types are:

**0** = Out , **1** = But, **2** = 12But, **3** = 12Bess, **4** = 12LR, **5** = 18But, **6** = 24But, **7** = 24Bess, **8** = 24LR, **9** = 48But, **10** = 48LR.

The monosub crossover object is a 2:1 mixer followed by a crossover band. The mixer's handle is 1+ the crossover band's handle. For the 2:1 mixer methods see the section headed **Mixers**.





## Mixers

All the mixers share the same basic format, each input channel has mute, gain and phase controls (plus pan if a stereo mixer). The mixer will have one output if mono or two if stereo. Each output has a mute and level. Optionally a mixer can have 1 or 2 aux buses which adds extra level controls for each input.

Method Name	Method Id	Type
Gain1	0x01000800	dB
Gain2	0x01000801	dB
Gain3	0x01000803	dB
Gain4	0x01000804	dB
Gain5	0x01000805	dB
Gain6	0x01000806	dB
Gain7	0x01000807	dB
Gain8	0x01000808	dB
Gain9	0x01000869	dB
Gain10	0x0100086a	dB
Gain11	0x0100086b	dB
Gain12	0x0100086c	dB
Gain13	0x0100086d	dB
Gain14	0x0100086e	dB
Gain15	0x0100086f	dB
Gain16	0x01000870	dB
GainOut (mono)	0x01000809	dB
GainOutL (stereo)	0x0100080a	dB
GainOutR (stereo)	0x0100080b	dB
Pan1	0x01000810	Scalar (0.0 - 1.0)
Pan2	0x01000811	Scalar (0.0 - 1.0)
Pan3	0x01000812	Scalar (0.0 - 1.0)
Pan4	0x01000813	Scalar (0.0 - 1.0)
Pan5	0x01000814	Scalar (0.0 - 1.0)
Pan6	0x01000815	Scalar (0.0 - 1.0)
Pan7	0x01000816	Scalar (0.0 - 1.0)
Pan8	0x01000817	Scalar (0.0 - 1.0)
Mute1	0x01000818	0 = off, 1 = on
Mute2	0x01000819	0 = off, 1 = on
Mute3	0x0100081a	0 = off, 1 = on
Mute4	0x0100081b	0 = off, 1 = on
Mute5	0x0100081c	0 = off, 1 = on
Mute6	0x0100081d	0 = off, 1 = on
Mute7	0x0100081e	0 = off, 1 = on
Mute8	0x0100081f	0 = off, 1 = on



Mute9	0x01000850	0 = off, 1 = on
Mute10	0x01000851	0 = off, 1 = on
Mute11	0x01000852	0 = off, 1 = on
Mute12	0x01000853	0 = off, 1 = on
Mute13	0x01000854	0 = off, 1 = on
Mute14	0x01000855	0 = off, 1 = on
Mute15	0x01000856	0 = off, 1 = on
Mute16	0x01000857	0 = off, 1 = on
MuteOut (mono)	0x01000828	0 = off, 1 = on
MuteOutL (stereo)	0x01000829	0 = off, 1 = on
MuteOutR (stereo)	0x0100082a	0 = off, 1 = on
Phase1	0x01000880	0 = off, 1 = on
Phase2	0x01000881	0 = off, 1 = on
Phase3	0x01000882	0 = off, 1 = on
Phase4	0x01000883	0 = off, 1 = on
Phase5	0x01000884	0 = off, 1 = on
Phase6	0x01000885	0 = off, 1 = on
Phase7	0x01000886	0 = off, 1 = on
Phase8	0x01000887	0 = off, 1 = on
Phase9	0x01000888	0 = off, 1 = on
Phase10	0x01000889	0 = off, 1 = on
Phase11	0x0100088a	0 = off, 1 = on
Phase12	0x0100088b	0 = off, 1 = on
Phase13	0x0100088c	0 = off, 1 = on
Phase14	0x0100088d	0 = off, 1 = on
Phase15	0x0100088e	0 = off, 1 = on
Phase16	0x0100088f	0 = off, 1 = on
AuxGain1a	0x01000840	dB
AuxGain1b	0x01000841	dB
AuxGain2a	0x01000842	dB
AuxGain2b	0x01000843	dB
AuxGain3a	0x01000844	dB
AuxGain3b	0x01000845	dB
AuxGain4a	0x01000846	dB
AuxGain4b	0x01000847	dB
AuxGain5a	0x01000848	dB
AuxGain5b	0x01000849	dB
AuxGain6a	0x0100084a	dB
AuxGain6b	0x0100084b	dB
AuxGain7a	0x0100084c	dB
AuxGain7b	0x0100084d	dB
AuxGain8a	0x0100084e	dB



AuxGain8b	0x0100084f	dB
AuxGain9a	0x01000858	dB
AuxGain9b	0x01000859	dB
AuxGain10a	0x0100085a	dB
AuxGain10b	0x0100085b	dB
AuxGain11a	0x0100085c	dB
AuxGain11b	0x0100085d	dB
AuxGain12a	0x0100085e	dB
AuxGain12b	0x0100085f	dB
AuxGain13a	0x01000860	dB
AuxGain13b	0x01000861	dB
AuxGain14a	0x01000862	dB
AuxGain14b	0x01000863	dB
AuxGain15a	0x01000864	dB
AuxGain15b	0x01000865	dB
AuxGain16a	0x01000866	dB
AuxGain16b	0x01000867	dB
AuxPreFade	0x01000868	0 = off, 1 = on



## Matrix Routers and Mixers

To save space in this document, the methods are listed in groups of 48 buttons. Each group corresponds to a row of buttons or rotaries on the control panels. To find the method of a particular button or rotary, simply look down the table for the group corresponding to the output number (e.g. Output 5 methods start at 0x010010C0). Take the input number, subtract one, and add it to the start method. So, the button for **Output 5 In 4** has a method of  $0x010010C0+4-1 = 0x010010C3$ .

Methods	Method Ids	Type
Route inputs (1-32) to output 1	0x01001000 + (Input-1)	0 = off, 1 = on
Route inputs (1-32) to output 2	0x01001030 + (Input-1)	0 = off, 1 = on
Route inputs (1-32) to output 3	0x01001060 + (Input-1)	0 = off, 1 = on
Route inputs (1-32) to output 4	0x01001090 + (Input-1)	0 = off, 1 = on
Route inputs (1-32) to output 5	0x010010C0 + (Input-1)	0 = off, 1 = on
Route inputs (1-32) to output 6	0x010010F0 + (Input-1)	0 = off, 1 = on
Route inputs (1-32) to output 7	0x01001120 + (Input-1)	0 = off, 1 = on
Route inputs (1-32) to output 8	0x01001150 + (Input-1)	0 = off, 1 = on
Route inputs (1-32) to output 9	0x01001180 + (Input-1)	0 = off, 1 = on
Route inputs (1-32) to output 10	0x010011B0 + (Input-1)	0 = off, 1 = on
Route inputs (1-32) to output 11	0x010011E0 + (Input-1)	0 = off, 1 = on
Route inputs (1-32) to output 12	0x01001210 + (Input-1)	0 = off, 1 = on
Route inputs (1-32) to output 13	0x01001240 + (Input-1)	0 = off, 1 = on
Route inputs (1-32) to output 14	0x01001270 + (Input-1)	0 = off, 1 = on
Route inputs (1-32) to output 15	0x010012A0 + (Input-1)	0 = off, 1 = on
Route inputs (1-32) to output 16	0x010012D0 + (Input-1)	0 = off, 1 = on
Route inputs (1-32) to output 17	0x01001300 + (Input-1)	0 = off, 1 = on
Route inputs (1-32) to output 18	0x01001330 + (Input-1)	0 = off, 1 = on
Route inputs (1-32) to output 19	0x01001360 + (Input-1)	0 = off, 1 = on
Route inputs (1-32) to output 20	0x01001390 + (Input-1)	0 = off, 1 = on
Route inputs (1-32) to output 21	0x010013C0 + (Input-1)	0 = off, 1 = on
Route inputs (1-32) to output 22	0x010013F0 + (Input-1)	0 = off, 1 = on
Route inputs (1-32) to output 23	0x01001420 + (Input-1)	0 = off, 1 = on
Route inputs (1-32) to output 24	0x01001450 + (Input-1)	0 = off, 1 = on
Route inputs (1-32) to output 25	0x01001480 + (Input-1)	0 = off, 1 = on
Route inputs (1-32) to output 26	0x010014B0 + (Input-1)	0 = off, 1 = on
Route inputs (1-32) to output 27	0x010014E0 + (Input-1)	0 = off, 1 = on
Route inputs (1-32) to output 28	0x01001510 + (Input-1)	0 = off, 1 = on
Route inputs (1-32) to output 29	0x01001540 + (Input-1)	0 = off, 1 = on
Route inputs (1-32) to output 30	0x01001570 + (Input-1)	0 = off, 1 = on
Route inputs (1-32) to output 31	0x010015A0 + (Input-1)	0 = off, 1 = on
Route inputs (1-32) to output 32	0x010015D0 + (Input-1)	0 = off, 1 = on
Mix inputs (1-32) to output 1	0x01000800 + (Input-1)	dB



Mix inputs (1-32) to output 2	0x01000830 + (Input-1)	dB
Mix inputs (1-32) to output 3	0x01000860 + (Input-1)	dB
Mix inputs (1-32) to output 4	0x01000890 + (Input-1)	dB
Mix inputs (1-32) to output 5	0x010008C0 + (Input-1)	dB
Mix inputs (1-32) to output 6	0x010008F0 + (Input-1)	dB
Mix inputs (1-32) to output 7	0x01000920 + (Input-1)	dB
Mix inputs (1-32) to output 8	0x01000950 + (Input-1)	dB
Mix inputs (1-32) to output 9	0x01000980 + (Input-1)	dB
Mix inputs (1-32) to output 10	0x010009B0 + (Input-1)	dB
Mix inputs (1-32) to output 11	0x010009E0 + (Input-1)	dB
Mix inputs (1-32) to output 12	0x01000A10 + (Input-1)	dB
Mix inputs (1-32) to output 13	0x01000A40 + (Input-1)	dB
Mix inputs (1-32) to output 14	0x01000A70 + (Input-1)	dB
Mix inputs (1-32) to output 15	0x01000AA0 + (Input-1)	dB
Mix inputs (1-32) to output 16	0x01000AD0 + (Input-1)	dB
Mix inputs (1-32) to output 17	0x01000B00 + (Input-1)	dB
Mix inputs (1-32) to output 18	0x01000B30 + (Input-1)	dB
Mix inputs (1-32) to output 19	0x01000B60 + (Input-1)	dB
Mix inputs (1-32) to output 20	0x01000B90 + (Input-1)	dB
Mix inputs (1-32) to output 21	0x01000BC0 + (Input-1)	dB
Mix inputs (1-32) to output 22	0x01000BF0 + (Input-1)	dB
Mix inputs (1-32) to output 23	0x01000C20 + (Input-1)	dB
Mix inputs (1-32) to output 24	0x01000C50 + (Input-1)	dB
Mix inputs (1-32) to output 25	0x01000C80 + (Input-1)	dB
Mix inputs (1-32) to output 26	0x01000CB0 + (Input-1)	dB
Mix inputs (1-32) to output 27	0x01000CE0 + (Input-1)	dB
Mix inputs (1-32) to output 28	0x01000D10 + (Input-1)	dB
Mix inputs (1-32) to output 29	0x01000D40 + (Input-1)	dB
Mix inputs (1-32) to output 30	0x01000D70 + (Input-1)	dB
Mix inputs (1-32) to output 31	0x01000DA0 + (Input-1)	dB
Mix inputs (1-32) to output 32	0x01000DD0 + (Input-1)	dB



## Graphic Eq

Method Name	Method Id	Type
BandGain1	0x01000820	dB
BandGain2	0x01000821	dB
BandGain3	0x01000822	dB
BandGain4	0x01000823	dB
BandGain5	0x01000824	dB
BandGain6	0x01000825	dB
BandGain7	0x01000826	dB
BandGain8	0x01000827	dB
BandGain9	0x01000828	dB
BandGain10	0x01000829	dB
BandGain11	0x0100082a	dB
BandGain12	0x0100082b	dB
BandGain13	0x0100082c	dB
BandGain14	0x0100082d	dB
BandGain15	0x0100082e	dB
BandGain16	0x0100082f	dB
BandGain17	0x01000830	dB
BandGain18	0x01000831	dB
BandGain19	0x01000832	dB
BandGain20	0x01000833	dB
BandGain21	0x01000834	dB
BandGain22	0x01000835	dB
BandGain23	0x01000836	dB
BandGain24	0x01000837	dB
BandGain25	0x01000838	dB
BandGain26	0x01000839	dB
BandGain27	0x0100083a	dB
BandGain28	0x0100083b	dB
BandGain29	0x0100083c	dB
BandGain30	0x0100083d	dB
Selectivity	0x01000841	Scalar (1.0 - 1.5)
Bypass	0x01000842	0 = off, 1 = on



## Metering Point

To implement metering in an external device it must be able to receive meter messages. These will be *MeterLevel* messages from a metering point object.

Method Name	Method Id	Type
MeterLevel	0x01000800	dB
MeterAttack	0x02000801	ms
MeterRelease	0x02000802	ms
MeterReference	0x01000803	dB

## Source Selector

Method Name	Method Id	Type
SourceSel	0x01000800	Discrete. Values are: 0 = none 1 = Input 1 2 = Input 2 3 = Input 3 4 = Input 4 5 = Input 5 6 = Input 6 7 = Input 7 8 = Input 8 9 = Input 9 10 = Input 10 11 = Input 11 12 = Input 12 13 = Input 13 14 = Input 14 15 = Input 15 16 = Input 16



## Compressor

Method Name	Method Id	Type
CompBypass	0x01000800	Discrete . Values are 0=off , 1 = bypass
CompThreshold	0x01000801	dB
CompRatio	0x01000802	Scalar
CompAttack	0x02000803	ms
CompRelease	0x02000804	ms
CompGainReduction	0x01000805	dB
CompGain	0x01000807	dB
CompAutoRelease	0x01000808	Discrete . Values are 0=off, 1 = Auto Release

## Limiter

Method Name	Method Id	Type
LimThreshold	0x01000801	dB
LimAttack	0x02000803	ms
LimRelease	0x02000804	ms

## Leveller

Method Name	Method Id	Type
LevBypass	0x01000800	Discrete. Values are 0 = off, 1 = Bypass
LevRatio	0x01000801	Scalar
LevThreshold	0x01000802	dB
LevMeter	0x01000804	dB
LevTarget	0x01000805	dB
LevMax	0x01000806	dB
LevSpeed	0x02000807	ms
LevActive	0x01000808	Discrete. Values are 0 = off, 1 = Leveller Active





## Filter High Pass And Low Pass

Method Name	Method Id	Type
FilterBypass	0x01000800	Discrete. Values are 0 = off, 1 = bypass
Filter Frequency	0x01000801	dB
FilterType	0x01000804	Discrete. Values are 0=Out 1=6But 2=12But 3=12Bess 4=12LR 5=18But 6=24But 7=24Bess 8=24LR 9=48But 10=48LR

## Audio Networking White Paper Building Soundweb Networks

Background 1 - packet networks	323
Background 2 - streaming networks	323
The Soundweb network	324
Delays in a Soundweb network	325
Resilience in a Soundweb network	325
Synchronisation	325
Connecting up Soundweb boxes with the network	325
Example 1: connecting up two daisy chain boxes	326
Example 2: using a hub device	326
Example 3: connecting up four daisy chain boxes	327



## White paper – audio networking and Soundweb

This paper explains some of the concepts which underlie the Soundweb network, and explains some of the background to the techniques used.

### Background 1 - packet networks

The most common type of network system for transmitting data is a packet network. This is found in the Ethernet systems used to hook up most office computers, and the X.25 networks used to link banking transactions. The Internet is a rather large form of packet network.

Packet networks operate in a particular way; a quantity of data to be sent (usually anything up to a couple of kilobytes or so) is bundled together and sent out from one network station to another. The main issue for the designers of packet networks is so-called "Access to the medium": when two stations desire to transmit a packet at the same time, how is one to prevent them clashing?

Many techniques are used for this. The technique employed in Ethernet, the most widespread packet network, is called "CSMA/CD", which stands for "Carrier Sense Multiple Access with Collision Detection". In this method, if two stations start to transmit at the same time, the packets collide. This is detected; a jamming signal is put out on the network to ensure that both packets are trashed, and the stations retry after a random wait. If there is a second collision, they wait again for a longer random period, and retry again – this is repeated until the packets get through (or some maximum limit is reached).

This technique is disastrous for real time audio transmission. The collision process can introduce delays of many tens of milliseconds, which, worse still, cannot be predicted. Raw Ethernet is not a suitable system for transmitting audio in real time, unless very large delays can be tolerated.

When it comes to transmitting audio, any packet network (even one not suffering from the CSMA/CD collision problem) requires the audio to be bundled into packets before being sent out over the network. This inevitably causes delay through the network hardware. It also requires relatively expensive hardware, since substantial buffer memory is required in which to store the packets, together with circuitry for packet assembly and disassembly.

### Background 2 - streaming networks

The most widespread audio network (which is now mostly digital) is the Public Switched Telephone Network. This takes quite a different approach: that of the streaming protocol. In this sort of system, a flow of audio samples is sent at a fixed rate. The audio fills the entire signal, so any control information must be buried in well-defined parts of the stream.

In the professional audio world, point to point digital audio transmission has followed this model, as exemplified by the AES-3 or SP-DIF interfaces. There are two reasons for this:



- Because A/D and D/A converters work on the basis of a steady stream of audio samples, the hardware needed to reformat the stream to be placed on the network is minimal. It is not necessary to have substantial packet buffer memory and DMA processing.
- Since there is no packet assembly or disassembly, the delay through the network hardware is also minimal – it is often below a single sample for one particular network station.

The digital telephone network provides a good example of a streaming audio network with multiple addressable stations. However, this technology is not immediately applicable to professional audio because of its restricted sample size and data rate (8 bit samples at 7 or 8 kHz sample rate), and because the telephone system tends to use very large switches with very small (one or two line) stations.

## The Soundweb network

The Soundweb network clearly follows the second paradigm – that of the streaming protocol. In the case of Soundweb, both audio and control data are transmitted as a series of 256-bit frames, one per sample time (20.8333us). Each frame holds up to eight 24-bit audio samples, with the remaining bits providing a control channel: this gives about 3 Mbit/s of control information when all eight audio streams are in use.

The custom IC which controls Soundweb networking has the ability to insert and extract control information in the “spare” part of the frame. This information is formatted into packets: the interface to the microprocessor which controls the box looks very like a conventional Ethernet solution, even though the underlying transmission technology is totally different.

The network uses a multiple point-to-point topology: each network port on a station is connected to a single port on another, with no shared medium as is found on Ethernet. In terms of its technical heritage, Soundweb can be thought of as a telephone network for professional audio.

Soundweb has one unique feature which sets it apart from telephone technology: this is the ability to string several stations together without the use of a central hub. It is this feature which allows two-box or three-box Soundweb networks to be cost-effective. The feature is implemented by forming a logical ring between all the stations. Each station can choose to relay its eight audio streams to the next station in the ring; alternatively, it can choose to overwrite one or more streams with audio signals from its inputs, or from internal processing.

Another unusual feature is the choice made for the bandwidth/distance trade-off. When using category 5 cable, a modern Fast Ethernet solution picks a speed of 100 Mbit/s with distance limited to 100 metres. Soundweb was designed for audio installations where the 100 metre limit could have been a significant constraint, and the choice was made to operate at a data rate of 12.288 Mbit/s, but with a maximum distance between nodes of over 300 metres.



## Delays in a Soundweb network

When a network is formed out of several Soundweb boxes daisy-chained together, the principle on which the network operates is that the audio must travel around the ring in less than one sample time. When audio is simply forwarded between stations, the delay between any two units varies according to the cable length, but is certainly less than one sample time (20.83333us). If a station processes audio before forwarding it, a single sample time is added.

A Soundweb hub forms the interlock point between rings. The transition across a hub always involves the addition of a further sample time of delay.

## Resilience in a Soundweb network

Soundweb networks are as resistant as possible to failure of one of the boxes on the network, given that audio and control is unable to pass through a box which has failed.

If a Soundweb box fails, the remaining boxes on the network will detect its absence and re-initialise communication. They will be able to pass control information to other units to which they are still connected, and any audio paths which did not pass through the failed unit will also be unaffected.

## Synchronisation

In any distributed digital audio system, the question of synchronisation inevitably arises. Each box in a Soundweb network is tightly synchronised to word clock. One unit is the “clock master” for the network; the other units phase-lock their word clock to the master.

The decision as to which unit is to be clock master is negotiated between units when the network is powered up, and re-negotiated if it should need to be re-initialised for any reason (such as the failure of a unit). In the absence of Soundweb units with digital input, the choice is arbitrary. When a Soundweb unit supporting digital input is designed, it will be possible to designate it as the preferred clock master for the network, allowing the whole network to be synchronised to an external word clock. Note, however, that Soundweb operates strictly at 48 kHz sample rate: other digital input sample rates can only be supported via sample rate converters.

## Connecting up Soundweb boxes with the network

The Soundweb network carries both audio and control information between Soundweb boxes over low-cost category 5 twisted pair cable. The cable is connected to a Soundweb box via RJ-45 type 8-pin jacks - similar to the jacks used in most data cabling applications and many telecommunications installations.

A Soundweb network cable carries up to 8 channels of 24-bit 48 kHz digital audio in either direction,



plus control information.

Box types and connector types

As far as the network is concerned, Soundweb boxes come in two types:

- *Daisy chain boxes* have two network jacks: one is labelled NET IN and one is labelled NET OUT. An example of a daisy chain box is the Soundweb 9088 Networked Signal Processor.
- *Hub boxes* have a larger number of network jacks and are used to build up more complex networks. An example of a hub box is the Soundweb 9000 Active network hub. Network jacks in a hub may be labelled INnnn or OUTnnn where nnn is a network port number.

Jacks labelled IN and OUT have identical functions, and indeed are quite identical except for one thing: their connections are reversed. This means that a standard straight through cable is used to connect an input jack to an output jack. Such a connection is compatible with industry standard structured cabling systems.

In some circumstances (when working with multiple hubs), it may be necessary to connect two output jacks together, or two input jacks together. This will work OK, but only if a crossover cable is used.

### **Example 1: connecting up two daisy chain boxes**

Connect a cable from the NET OUT jack of one box to the NET IN jack of the other.

Control information can pass between the two boxes, and 8 channels of audio are available in either direction on the cable.

### **Example 2: using a hub device**

For large systems, connectivity can be provided by the Soundweb 9000 hub unit.

Each cable from U2, U3 or U4 to the hub can carry 8 channels of audio in either direction. The hub permits any channel on any network jack to be routed to any other, giving a high degree of flexibility in the way the audio can be routed around the system.



### Example 3: connecting up four daisy chain boxes

For medium-sized systems where the cost of a hub would be unjustified, it is possible to string many daisy chain boxes together. However, care is required, as well as a reasonable understanding of the paths provided in each daisy chain box.

Connect a cable from NET OUT of one box to NET IN of the next, and continue doing this until all four boxes are connected together.

Control messages can flow freely between all four boxes. Audio, however, is limited by the fact that only 8 channels of audio can pass over the cable.

8 audio channels come into U2 through the NET IN port. These are all available as inputs to the signal processing circuitry in U2. The output channels sent on the NET OUT port can be one of two things: they can be audio outputs from U2 itself, or they can be signals forwarded directly from the NET IN port (for use by U3 or U4).

In addition to the paths from U1 to U2 to U3 to U4, the cables also provide a return path from U4 to U1. This forms the boxes into a logical ring, so that any box can send audio to any other, but the restriction of 8 channels of audio applies.

It would be possible, for example, to send 6 channels from U1 to U2, 2 channels from U1 to U3, 6 channels from U2 to U4, 2 channels from U3 to U4 and 8 channels from U4 to U1. Figure 4 shows what the signal path would look like within U2:

It would not be possible to send 4 channels from U1 to U2 and 5 channels from U1 to U3, because the cable link between U1 and U2 would need 9 channels and would overflow its 8 channel limit.

For the same reason, it would not be possible to send 8 channels from U1 to U4, and 1 channel from U2 to U3.



<b>Cables and connections</b>	<b>330</b>
Q. What is the pin-out of the connectors?	330
Q. What audio connectors do I need?	330
Q. What do I do if I want to use XLRs?	330
Q. Can I use standard Ethernet cabling for the network?	330
Q. Is shielded cat-5 cable required for system stability?	330
Q. What is the maximum length of a Soundweb network?	331
Q. What is the maximum number of boxes on a Soundweb network?	331
<b>Serial ports and external control</b>	<b>332</b>
Q. How far can the PC be from a Soundweb unit?	332
Q. Can you plug in two PCs into a Soundweb network?	332
Q. Why are there two serial ports?	332
Q. Can I connect using a modem?	332
Q. What physical/hardware interface is provided for contact closure/logic voltage I/O?	332
<b>About the DSP</b>	<b>333</b>
Q. What DSP chip is being used?	333
Q. What sampling rate is used?	333
Q. What are the estimated propagation delay through the unit?	333
Q. What happens if I run out of DSP power?	333
Q. What are the limitations of Soundweb regarding large matrix designs?	333
Q. How long should it take to activate a Preset or Parameter Preset	333
<b>Dealing with failures, and behaviour when power is switched off and on</b>	<b>334</b>
Q. What happens to the audio signal at power-on or (reboot)?	334
Q. In the event of a 9088 failure/lock-up, what happens to the signal path, input to output? Is there any transient audio noise at moment of failure (or reboot)?	334
Q. What happens if a network cable fails during operation?	334
Q. What happens if a Soundweb box fails or is switched off during operation?	334
Q. What ability does Soundweb have for redundancy?	334
<b>Hardware issues</b>	<b>335</b>
Q. How do I prevent a high level mic signal from overloading the A/D inputs?	335
Q. Why is there no selector switch for 110V/220V/240V operation?	335
Q. What does the battery do?	335
Q. How much heat is generated by a 9088 unit, and what recommendations are proposed for stacking units in a rack, etc?	335
<b>The PC for Soundweb Designer</b>	<b>335</b>
Q. What versions of Windows work with Soundweb Designer?	335
Q. What is the minimum specification of the PC required to operate Soundweb Designer software?	335
<b>Soundweb Designer features</b>	<b>336</b>
Q. Will Soundweb Designer run on a Macintosh?	336
Q. How is the software shipped?	336
Q. Does Soundweb include provisions for embedding control objects in bitmaps?	336
Q. Does the designer/installer have any way to control what addresses are assigned to specific units or channels?	336
Q. What method do we provide for the designer/installer to monitor which system device is being addressed at any moment?	336





- Q. *How can you be sure you are on-line?* 336
- Q. *While online, can your PC be unplugged from one box and plugged into another and remain online?* 336



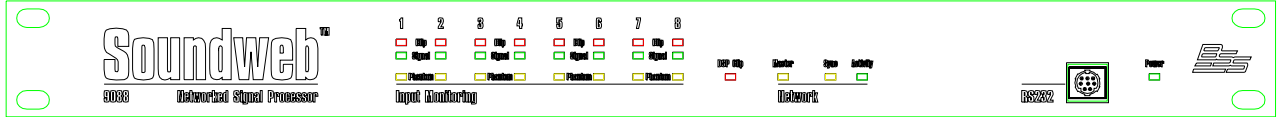

## Cables and connections

- Q. What is the pin-out of the connectors?**  
**A.** This is described in the Soundweb Designer on-line Help under the topic 'Connector pinouts'.
- Q. What audio connectors do I need?**  
**A.** The analogue audio connections use two-part screw terminal connectors: these have several names, such as Phoenix, Euro, Klippon or Combicon. The male connectors are mounted on the unit, and the mating female connectors are shipped with each unit, so you should not need to purchase additional connectors.
- Q. What do I do if I want to use XLRs?**  
**A.** The assumption made is that the XLRs will be in a wall panel or an input panel of your rack, and not used for the connection to the Soundweb box itself. There are no plans at present to produce a 2U version of the 9088 with 16 XLRs.
- Q. Can I use standard Ethernet cabling for the network?**  
**A.** Passive Ethernet components such as RJ-45 connectors, patch leads, cat-5 cables, wall boxes, etc. can be used – although you must ensure that they connect all eight cores of the cable, including the ones that ordinary Ethernet does not use. Soundweb is not compatible with active Ethernet components hubs, routers or repeaters.
- Q. Is shielded cat-5 cable required for system stability?**  
**A.** Unshielded cat-5 cable (UTP) will work fine, and is indeed recommended because it will work over the full 300 metre distance. Shielded (STP) cat 5 cable should be used to comply with EMC regulations.

**Q. What is the maximum length of a Soundweb network?**

**A.** When the network is a series of hubs, there is no theoretical maximum. A single daisy-chain of 9088s has a maximum length which is computed according to the following (approximate) table (note that 1 metre is approximately 3.28 feet):

Number of Nodes	Max distance (metres)	Number of nodes	Max distance (metres)	Number of nodes	Max distance (metres)
2	300	9	1,534	16	1,195
3	600	10	1,485	17	1,147
4	900	11	1,437	18	1,099
5	1,200	12	1,389	19	1,050
6	1,500	13	1,340	20	1,002
7	1,631	14	1,292		
8	1,582	15	1,244		

**Q. What is the maximum number of boxes on a Soundweb network?**

**A.** This will depend on system design and complexity. In practice, you are likely to be limited by the speed of Soundweb Designer, which will gradually slow down as the system gets very large, or by the distance limits mentioned above.

Currently, we have tested single-network systems without 9000ii hubs (a single daisy-chain of 9088's, up to a maximum of 25 units (whether these are 9088 or 9010 remote devices or mixed). Larger networks using 9000ii hubs have been tested to 100 units (mixed 9000ii, 9088 and 9010 devices), and therefore it is recommended that this number should be used as a limit for single network systems. If you anticipate using more than this, please contact BSS Audio prior to finalising a system design.

### *Serial ports and external control*

**Q. *How far can the PC be from a Soundweb unit?***

**A.** The RS-232 connection from the PC has a theoretical limit of 15m, although considerably longer distances seem to work in practise. If you want to take the PC further from the unit, it is recommended that you use one of the many RS-232 extender products available at fairly low cost. These products usually work by converting RS-232 to RS-422 or RS-485, although some use their own protocol. Note that you will need to extend the handshake lines also. A separate document is available detailing the use of converters.

**Q. *Can you plug in two PCs into a Soundweb network?***

**A.** Yes, in the Soundweb Designer >Preferences>Application>Comms section, you can assign different system addresses for each PC connected. As an alternative to using the front RS-232 port, you can connect into a 9088 device using the rear RS-232 port, but not both on one unit. Theoretically, you can assign a number of PC's in the network, as long as each has a different address.

**Q. *Why are there two serial ports?***

**A.** The front panel serial port is provided so that you can plug in a notebook PC for configuration. The rear panel is there to allow you to plug in an external control device such as an AMX/Crestron controller, although it can also be used to plug in the PC as an alternative to the front panel port.

**Q. *Can I connect using a modem?***

**A.** Version 1.18.2 of Soundweb Designer includes modem support, so that using a modem connected to the rear port of a 9088/9000ii, you can dial-up and connect with your local PC, and control the system.

**Q. *What physical/hardware interface is provided for contact closure/logic voltage I/O?***

**A.** The 9088 and 9000ii hub provides 8 "control inputs". Each control input is assigned to an ADC channel, has a 4.7 k pull-up resistor, and accepts a voltage between 0 and 5V. You can connect a switch between the signal pin and common and use the port as a simple contact closure input, or you can use a potentiometer (which must be 47k logarithmic) and use it as a continuous parameter control. The software allows you to configure the control inputs for each 9088/9000ii. The 9088/9000ii also provides 8 logic outputs, which can drive either 0 or 5V, protected by a 440 Ohm series resistor. They can be used to drive LEDs or possibly relays.

An additional logic output is opto-isolated, and coupled directly to the watchdog output. This will energise when the system is up and running OK; if power fails, or if the software crashes, the opto-isolator will stop conducting. The connections to all these inputs and outputs are provided on a two-level 24 way Phoenix connector. Seen from the back of the unit, the connections look like this:

Cmn	Cmn	In1	In2	In3	In4	In5	In6	In7	In8	Cmn	Cmn
Opto+	Opto-	Out1	Out2	Out3	Out4	Out5	Out6	Out7	Out8	Cmn	Cmn



### About the DSP

**Q. What DSP chip is being used?**

**A.** The **Soundweb 9088** has two chips running in parallel at 80 MHz each. These execute one instruction per clock cycle, hence the figure of 160 MIPS (Million Instructions Per Second). The **Soundweb 9000ii and 9088ii** use 100MHz DSP chips, and have 200 MIPS of dsp resource.

**Q. What sampling rate is used?**

**A.** Internally, Soundweb uses a fixed 48 kHz sampling rate, which cannot be changed. The AES/EBU digital i/o interfaces support other rates via sample rate conversion.

**Q. What are the estimated propagation delay through the unit?**

**A.** Each A/D converter and each D/A converter adds an estimated delay of less than 2ms in total. Other delays internally are counted in samples (1/48 kHz each, or approximately 20.8 microseconds). Note: Soundweb uses a 48KHz sampling rate. A typical delay due to processing and intra-DSP communication might be 5 samples, or 104 microseconds. The maximum delay for a network chain of 9088's is one sample, and each 9000ii hub inserts one additional sample: in other words, the network contributes only a very small amount to the overall delay.

**Q. What happens if I run out of DSP power?**

**A.** The DSP power cannot be increased internally, but there are several things that you can do:

1. You can 'turn off' delay compensation in the devices.
2. If you don't need all the DSP power at the same time, you can split your design into different configurations, and only activate the power you need at a particular time.
3. If you have several Soundweb units in your system, you can try to move some of the processing into a different box.
4. Finally, you can buy extra boxes (either 9000ii's or 9088's) and route signals to and from the extra boxes across the network.

**Q. What are the limitations of Soundweb regarding large matrix designs?**

**A.** The main limitations are to do with the number of analogue inputs and outputs in each box. A single box can do an 8x8 matrix mixer; a pair of boxes connected by a single network cable can do a 16x16 matrix mixer. In order to create configurations larger than 16x16 one or more 9000 network hubs is necessary. If you add enough hubs you can create a system with a number of inputs and outputs which is essentially unlimited. However, if you try to allow the user to make every output and arbitrary mix of every input, you will run into bottlenecks both in DSP power, your ability to simultaneously route all the signals, and in your ability to create a sensible control panel. For example, a full 96:48 matrix mixer is possible but uses 12 hubs in addition to the 12 x 9088s, and designing the control panel is quite difficult. A new processing object, the SOURCE MATRIX, has been added to streamline matrix resource usage, where each output is tied to only one input.

**Q. How long should it take to activate a Preset or Parameter Preset**

**A.** Depending on the number of processing objects and number of controls, a Preset will take anywhere from a small fraction of a second to several seconds.



### ***Dealing with failures, and behaviour when power is switched off and on***

**Q. *What happens to the audio signal at power-on or (reboot)?***

**A.** The audio outputs remain muted by relay until the unit's software has completed initialisation. The unit will restore the audio path to the configuration and settings that were in place at the last time the unit was switched off.

**Q. *In the event of a 9088 failure/lock-up, what happens to the signal path, input to output? Is there any transient audio noise at moment of failure (or reboot)?***

**A.** Hardware failures can have unforeseen consequences which may include transient noise, although the majority of hardware failures are not like this. If the hardware is OK but there is a software crash, the watchdog timer will kick in and reboot the unit.

**Q. *What happens if a network cable fails during operation?***

**A.** The audio processing of all the units will continue as normal, although any audio signals being passed down the network may not be available. (Warning – at present, this can mean that an unexpected audio signal is routed: it is a wishlist item to ensure that network audio inputs mute if their source becomes disconnected.) The control processing will work fine for units which are still connected to each other, so there will be two sub-networks remaining which will work OK internally. Naturally, any control information which would have been routed across the failed cable will not operate correctly.

**Q. *What happens if a Soundweb box fails or is switched off during operation?***

**A.** The remaining units will continue to function as normally as is possible given the fact that some of their audio sources may be missing, and they may no longer have a physical means of receiving control information. If a box simply loses power, the network will automatically reconfigure itself when power is reapplied. However, any Preset changes will not be applied to a box which was switched off at the time the Preset was activated. Soundweb Designer software will still think that the system is on-line, but you will be unable to access the unit which was switched off. This also applies to any other units which are on the far side of it, since there will be no path for network messages from your PC to reach them.

**Q. *What ability does Soundweb have for redundancy?***

**A.** The 9088 and 9000ii provide an opto-isolated output which works from the watchdog. If the opto-isolator is conducting, then the hardware is on and the software is working OK. If power is removed from the hardware, or if the software crashes for any reason, the opto-isolator will cease to conduct. This output can be used to trigger an alarm, or to switch in a backup system automatically.

Here is an example of how this might work: you could connect two 9088s to your system, with a box of relays to switch between the two 9088s. The opto output of the *primary* unit would energise the relays so that all signals pass through the primary unit.

Should the primary unit fail, the opto would cease to conduct, so the relays would flip over to bring the *secondary* 9088 into the circuit. Conceivably, the backup unit could have a different, non-critical, function when in the normal mode, and double as a backup for the main unit. A DCLR system is also incorporated, where two sets of cat 5 cables are used to create a redundant ring network. If one cable is damaged, the other still transmits the signals around the network.



### *Hardware issues*

- Q. *How do I prevent a high level mic signal from overloading the A/D inputs?***  
**A.** The quad mic preamp card has programmable gain, which is applied before the A/D converter. You should set the gain such that the maximum output level of the microphone will not reach +20dB, even if someone is singing very close to the microphone. This setting forms part of your Presets, so you can have different settings for different microphone types or even different types of event.
- Q. *Why is there no selector switch for 110V/220V/240V operation?***  
**A.** Because the unit doesn't need one. The 9000 and 9088 both contain universal power supplies which can be plugged in to any ac mains voltage between 95V and 245V.
- Q. *What does the battery do?***  
**A.** 9088s and 9000s do not have batteries, firmware and settings are held in flash EPROM. The object inside that looks like a battery is in fact a button with the unique hardware serial number of the unit. This is provided in detachable form because there are plans to use it in future as the decryption key for copy-protected software, and it is desirable that this can be swapped between units in case of failure.
- Q. *How much heat is generated by a 9088 unit, and what recommendations are proposed for stacking units in a rack, etc?***  
**A.** No special precautions are required compared to any other DSP products, and it should be possible to stack several units adjacent to each other in a rack. We would of course recommend that normal precautions be taken, particularly if the rack contains power amplifiers.

### *The PC for Soundweb Designer*

- Q. *What versions of Windows work with Soundweb Designer?***  
**A.** Soundweb Designer requires a 32-bit version of Windows; that is Windows 95, 98, 2000, Windows NT Workstation (version 4.0 or later), or XP.  
 Soundweb Designer will NOT work on Windows 3.10 or 3.11.
- Q. *What is the minimum specification of the PC required to operate Soundweb Designer software?***  
**A.** Soundweb Designer requires a recommended P266 PC with 48MB RAM. Hard disk space requirement is roughly 20MB.

System speed will depend on system (network) size and computer speed. For large systems (20 boxes plus), a much faster PC is required.

System design files will take up additional space, approximately 250KB for a typical small system layout. Although the software is usable on 640x480 screen resolution, 800x600 is considerably more comfortable, and 1024 x 768 is even better. Higher resolutions are better still, of course, particularly if you are doing a complex design.





### *Soundweb Designer features*

- Q. *Will Soundweb Designer run on a Macintosh?***  
**A.** There is no version of Soundweb Designer specially written for the Macintosh, nor is it supported for the MAC. The program is working in the field on MAC computers, under Soft-Windows / Virtual PC Emulation, but requires a change in the serial cable.
- Q. *How is the software shipped?***  
**A.** The software is shipped on CD-Rom, and is available for download on the website.
- Q. *Does Soundweb include provisions for embedding control objects in bitmaps?***  
**A.** Yes, by adding a bitmap object to a newly created map window, and dragging appropriate controls onto it. Alternatively, you can set a bitmap as the background of the map window. You may also edit the background colour of these controls to be transparent.
- Q. *Does the designer/installer have any way to control what addresses are assigned to specific units or channels?***  
**A.** Each DSP box has an address set by the 'Location' item on its right-click menu. Once the system is configured, and the addresses of the actual hardware devices matches the addresses in the system design, the addresses stay correct forever: the user need not be aware of the hardware addresses.
- Q. *What method do we provide for the designer/installer to monitor which system device is being addressed at any moment?***  
**A.** Each DSP box has an 'activity' LED that is lit when data is being transferred to or from it. When setting up the system, if you click on the name of a unit in the network window (while on-line!), all the LEDs on the unit will flash so that you can tell which physical hardware unit matches the name on your screen.
- Q. *How can you be sure you are on-line?***  
**A.** The status bar (at the bottom of your Soundweb Designer window) will show the word 'OFFLINE' if you are offline. The corresponding area is blank if you are on-line. Alternatively, go to network view: if you are on-line, the 'go on-line' button will be greyed out. There is also now a network status toolbar which shows whether you are on or off line.
- Q. *While online, can your PC be unplugged from one box and plugged into another and remain online?***  
**A.** No – the connection will be lost a couple of seconds after unplugging from the first unit. The correct procedure is to go off-line, unplug the PC from the first unit, plug it into the second unit, and then go on-line again.

Soundweb FAQ Last updated 28/11/00





### Converting Soundweb's RS-232 connection for long distance RS-422 use

BSS Audio have tested the configurations shown below with an RS232 to RS422 converter supplied by Mutek Transcom Ltd., Farleigh House, Frome Rd., Bradford on Avon, Wiltshire, BA15 1LE, U.K.

Tel +44 (0)1225 866501 <http://www.mutek.co.uk/>

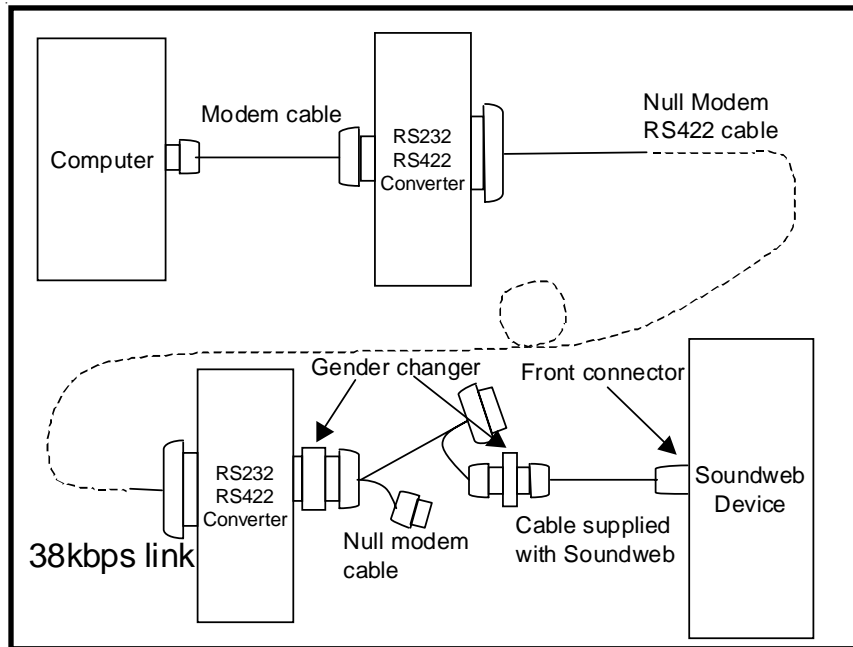

Only the 38kbps link is guaranteed to work as this is the maximum rated speed of the converter box. The limitation is due to the RS232 chips used. However, we have tested standard converters with a 115kbps link over 200m of CAT-5 cable and very short RS232 cables with no problem.

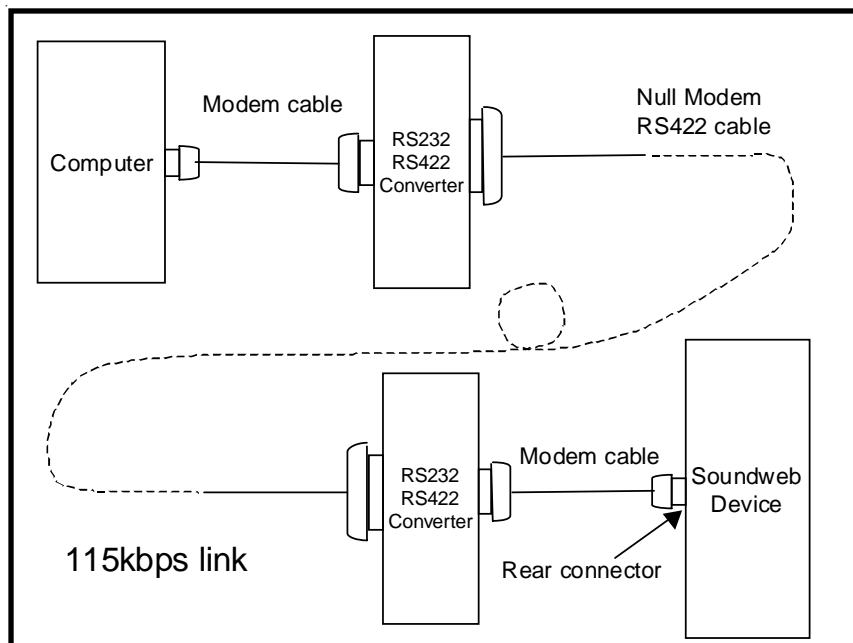

## Connections required for the Null Modem RS422 cable

	Computer Side	Soundweb Side
TXD+	4	6
TXD-	22	24
RXD+	6	4
RXD-	24	22
RTS+	7	9
RTS-	25	27
CTS+	9	7
CTS-	27	25

Both ends require a DB-37 male plug.  
The table on the left shows the pin connections.  
A suitable cable type is CAT-5 or any other similar data cable containing twisted pairs.  
Ensure that each wire pair shown in the table corresponds to a twisted pair in the cable.

Mutek also offer to make converter boxes with faster RS232 chips on request for a small additional charge. This can not be guaranteed to work but based on our experience probably will. Be prepared to revert to the 38kbps link if need be.

In the US, Hullspeed Data Products Inc. make a converter, the AD U232-422.  
Contact details: P.O. Box 1749 Melbourne, Florida USA 32902-1749  
Phone: 800-771-4855 or 407-768-0063  
<http://www.hullspeed.com/>

Note: We have not tested this converter but the spec. and connections are the same or better.

If another manufacturer of RS232 to RS422 converter is used please ensure the following specifications are met...

- 1) Must operate to at least 38kbps,
- 2) Must handle the RTS and CTS lines, not just RXD and TXD.



## RS-232 to RS-485 conversion

The serial connection between PCs and Soundweb devices can also be extended using RS-485, this providing higher noise immunity due to the use of a balanced differential. Distances up to 1200 meters (4000feet) can be realised using this protocol.

Patton Electronic Co. offer a small converter, the 2089f, to provide a four wire RS485 link between Soundweb and PC. A converter is required at both ends, the connections are as follows:

Converter at PC end	Converter at Soundweb end
RCV+ RCV- XMIT- XMIT+	XMIT+ XMIT- RCV- RCV+

The dip switches found on both top and bottom of the converter are set up as shown below:

Converter viewed from top

Converter viewed from below

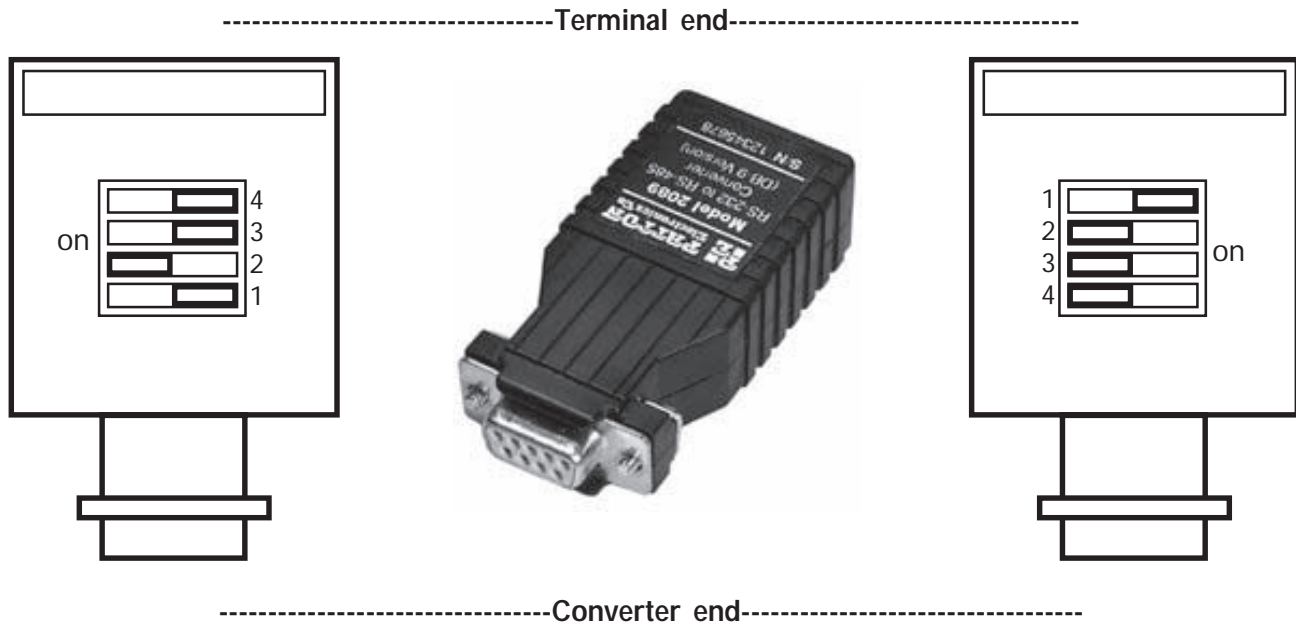



The 9010 remote control unit is normally powered from a single 24V dc, 1.2A power supply that is connected directly to the unit. In larger network systems, where multiple 9010 units are needed, power can be supplied in a variety of configurations.

If a large enough power supply, i.e. capable of supplying many amps, is available then each 9010 can be connected directly from the supply itself, see below. This is possible up to a maximum of 25 units and within the correct current output rating of the power supply.

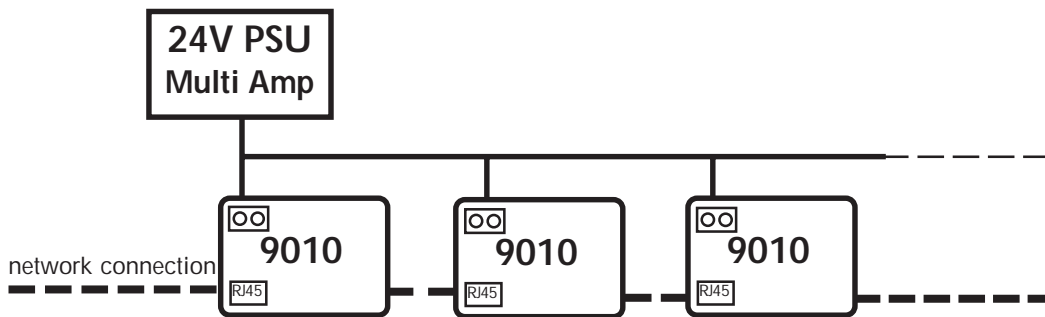

 Green Screw Terminals

If a large power supply is not an option, either because one is not available or through cost, then a network containing multiple 9010s can be powered using lower rated PSUs as demonstrated in the following diagrams.



BSS Audio 9011 Network Power Interface

The basic rule is that up to four 9010 units can be powered from a single 1.2A PSU using the 9011 network power interface. The 9011 accepts power from the supply and then relays it across the network to the 9010 units and, acts both as a power distributor and an isolator when used in conjunction with more than four 9010s. If you intend to use multiple instances of 9010 remote controls then BSS Audio recommends the following solutions using the 9011 interface.



BSS Audio 9010 Power Supply

## Powering multiple 9010s with 1.2A PSUs and 9011

The 9010 is capable of relaying power to other 9010s in the system via the network using the optional 9011 network power interface.

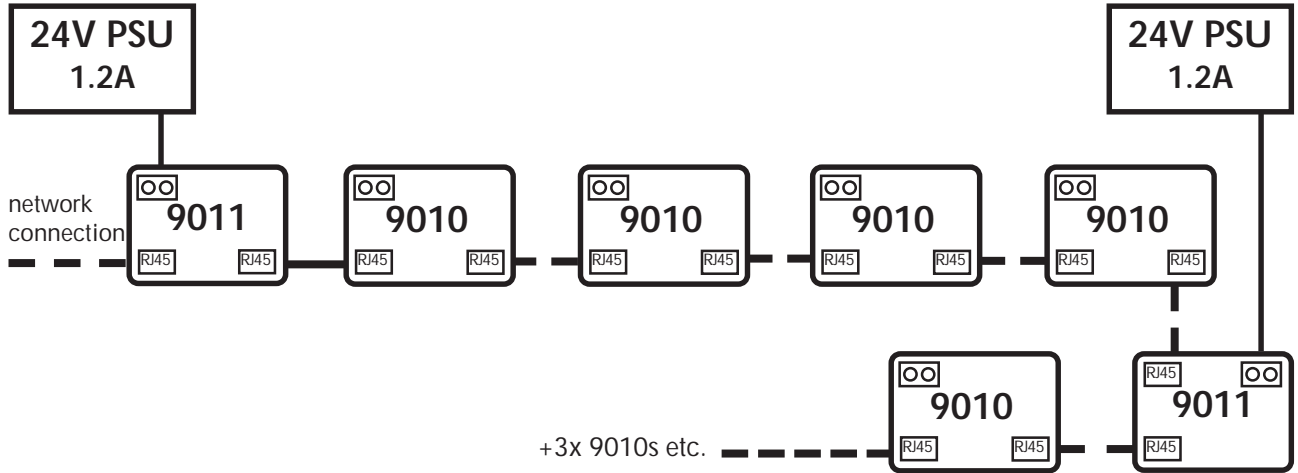

## Powering 9010s directly and with 9011 interface

In this example the first 9011 is omitted and the 9010 is powered directly. Note that it is still necessary to use a 9011 after the fourth 9010 to break the power and isolate the second batch of 9010s from the first block.

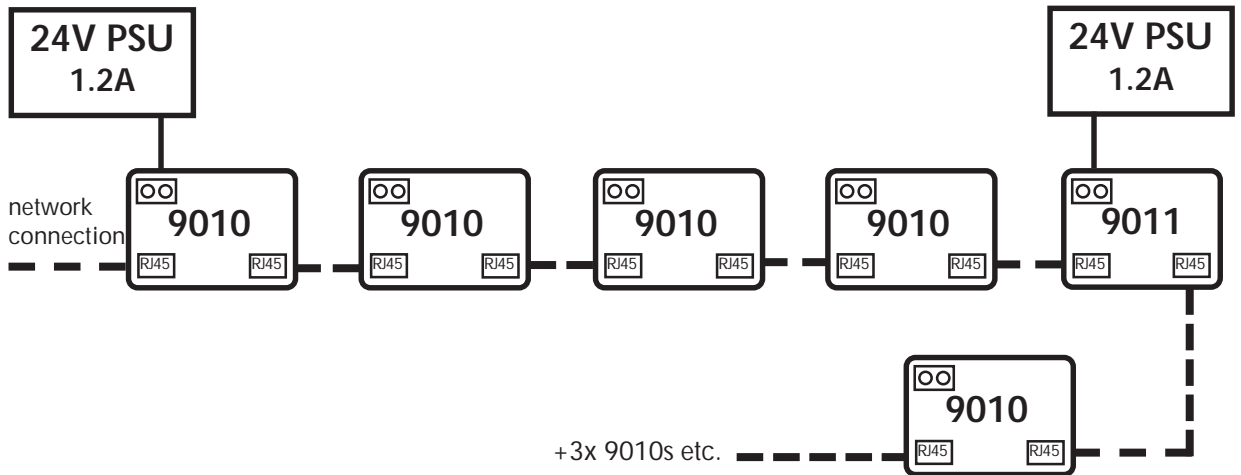

## Powering 9010s with 2.4A PSUs

In this example a 2.4A supply is used to provide power for between five and eight 9010 units. Further supplies would be needed to run more remotes.

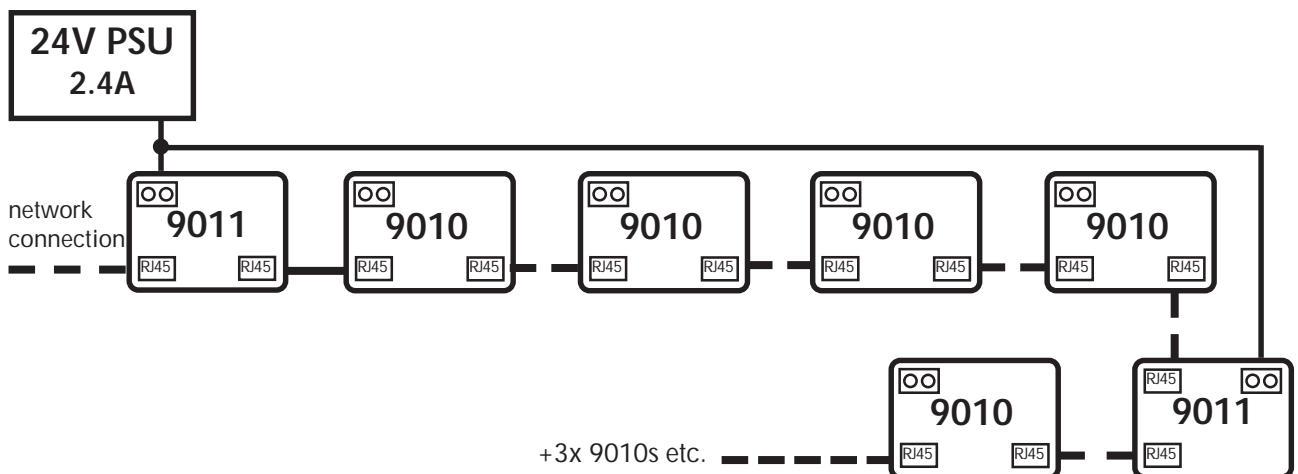

---

## DXF Format drawings for use in CAD programs, documentation etc

### Contents

Front view : Filename 9088fron.dxf	343
Rear view : Filename 9088rear.dxf	343
Side view : Filename 9088side.dxf	343
Front view : Filename 9000fron.dxf	344
Rear view : Filename 9000rear.dxf	344
Side view : Filename 9000side.dxf	344
Front view : Filename 9010fron.dxf	345
Sideview : Filename 9010side.dxf	345
Architects and Engineers Specifications	346
Soundweb 9014 Fibre Interface Additional Specifications	347

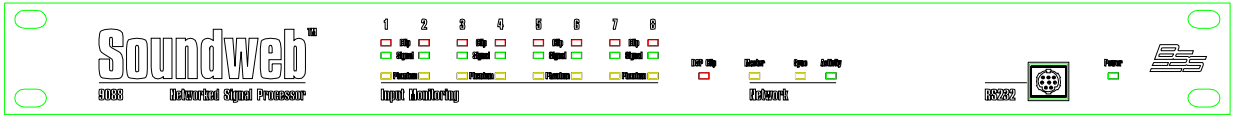

Front view : Filename 9088fron.dxf

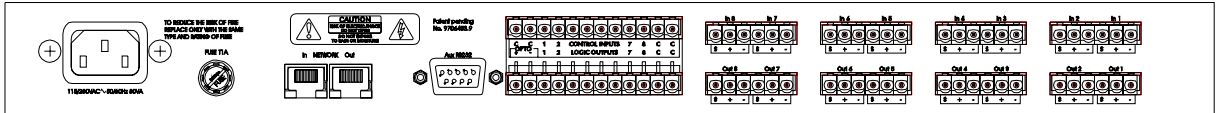

Rear view : Filename 9088rear.dxf

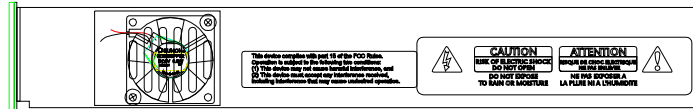

Side view : Filename 9088side.dxf



Front view : Filename 9000fron.dxf

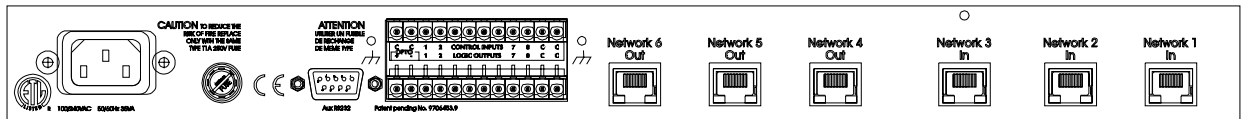

Rear view : Filename 9000rear.dxf

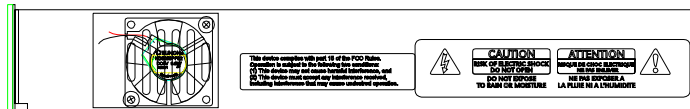

Side view : Filename 9000side.dxf





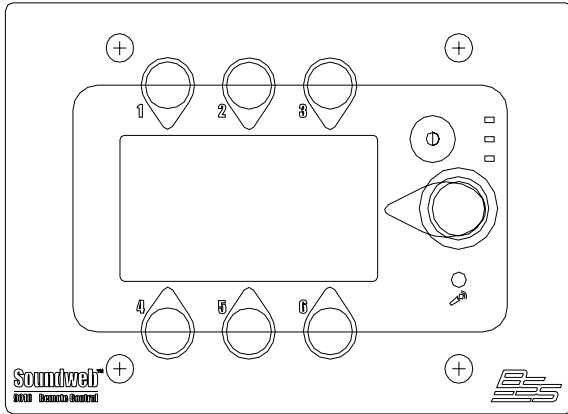

Front view : Filename 9010fron.dxf

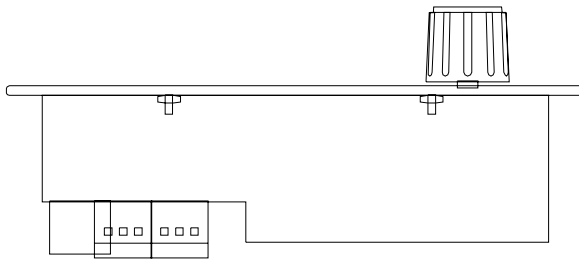

Sideview : Filename 9010side.dxf

## Architects and Engineers Specifications

November 2000

The Digital Signal Processor shall be a stand-alone unit of one rack space, capable of providing a fully-functional system with 8 analogue inputs and 8 analogue outputs, without the need for a dedicated, on-line computer system. The Analogue inputs shall have a remotely adjustable gain stage prior to A/D conversion.

The system designer shall be provided complete flexibility in system configuration.

Line inputs or combination Microphone/Line inputs shall be provided, together with channel-selectable 48 volt phantom power for the microphone inputs. The unit shall provide a tamper-proof front-panel with no user-adjustable controls. Front panel LED indicators will provide monitoring of signal presence clip and network status. Analogue/Digital/Analogue conversion shall be by 24-bit A-D converters and 24-bit D-A converters to provide maximum operating headroom and performance. The Dynamic Range shall be 105dB minimum (unweighted, 108dB A-weighted), with a THD figure of less than 0.01%.

Optional AES/EBU Digital input/output cards shall be available, each card having 2 stereo inputs and 2 stereo outputs. Input sample rates shall be accepted from digital sources with rates from 32kHz to 96kHz, and the user shall be able to select output sample rates of 44.1kHz, 48kHz, 88.2kHz, 96kHz or any sample rate between 32kHz and 96kHz using external clock synchronisation. Clock synchronisation shall be possible with the first digital input, the internal clock or an external word clock on a BNC connector.

Input and Output connections are provided via modular, Phoenix/Combicon style hardware. Mating connectors (Phoenix/Combicon MSTB 2.5/6-ST-5.08 or equivalent) shall be supplied with each unit on delivery or in advance.

The Signal Processor shall also be networkable over Category 5 cable (as established in the TIA/EIA-568-B standard), to provide 8 channels of audio signals and control data routing between processors for system expansion or communication. This network shall be terminated on RJ-45 connectors, and be stable over distances up to 1000 feet between units. There shall be available a fibre-optic converter to extend this distance to 1.2 miles. The network shall allow system expansion at a later date through the addition of further Signal Processors.

System Configuration shall be by a Personal Computer, which may be disconnected after configuration without affecting installed operation of the unit. Up to 12 System Configurations shall be stored in each processing device, and these configurations shall not be limited by factory-only presets or pre-determined processing. It shall be possible to configure a number of system presets, which may be recalled at any time via the PC or external control devices.

The unit's software shall provide a palette of audio processing objects for use in system designs to include, but not be restricted to: Automatic Microphone Mixers, Ambient Noise Compensators, Crossovers, Compressors, Gates, Duckers, Expanders, Limiters, Gain blocks, Graphic Equalisers, Parametric Equalisers, Stereo Parametric Equalisers, Filters, Metering points, Delays, Mixers, Matrix Routers, Matrix Mixers, Source Matrices, Tone Generators, and Source Selectors. The software shall provide the facility to construct user-defined control panels incorporating elements of the processing object parameter controls. Multi-level password-based security shall protect the integrity of the system.



The device configuration window shall provide a DSP gauge to inform the designer as to the percentage of DSP usage. The system design software shall be compatible with either Windows 95 or Windows NT4, 32 bit operating systems.

The software shall provide a facility to create personalised, custom processing objects for use in system designs, with provision for intellectual property cloaking via Macros.

It shall be possible to connect standard potentiometers and switches or control voltages to 8 control input ports to allow non-technical operators to change system presets or variable parameters. An additional 8 control output ports shall provide logic outputs for purposes of signal indication, external switching systems, or other similar system control applications. An opto-isolated failsafe indicator shall be provided on an open-collector output.

Two RS-232 ports shall be provided to allow control of the unit from Multimedia Systems such as AMX, Crestron, Dataton, Avenger or other PC devices communicating in a serial mode, as well as independent, simultaneous control and programming from a PC operating Soundweb Designer software. The RS232 port on any device shall provide access to all devices that are properly networked together. It shall be possible to use multiple PC's connected to separate signal processors in a network to control the system. It shall also be possible to remotely control the system network using a PC & modem to connect over telephone lines to another modem connected to the system network.

To aid in system management, the software shall provide a method of event logging so that system diagnostics are available. This event log shall include failures, warnings and information notices, and shall display the time of the event occurrence and the device to which the event applies and the design file originally loaded.

The Digital Signal processor shall be the BSS Audio Soundweb 9088ii.

## **Soundweb 9014 Fibre Interface Additional Specifications**

(to be used in conjunction with the above)

The wide-area fibre interface shall take a network cable feed from the Digital Audio system, and translate the data into a form which can be transmitted down fibre-optic cable. The signal shall be stable over a minimum distance of 1.2 miles (2 kilometres), and shall operate fully with signals attenuated up to 10dB from the originating signal. Two interfaces shall be required to transmit 8 channels of digital audio in both directions on the network between digital audio devices, with control data, each block of 8 channels in each direction requiring a separate fibre cable.

The fibre interface shall use Multimode 62.5/125um or Multimode 50/125um fibre cable, which shall terminate at the interface module on snap-in SC connectors.



## Soundweb 9016 Video/Audio Matrix Switcher

Architects and Engineers Specifications

April 2002

The Video/Audio Matrix Switcher shall accept up to eight video inputs on BNC connectors, and be capable of switching these to any or all of 4 video outputs. These outputs shall also be on BNC connectors. The video source standard shall be automatically recognised from either PAL or NTSC video sources, and shall be either SVideo or CBVS composite video format.

There shall be a loop-through BNC connector paralleled to each input, which may be used to pass the video input signal onwards. Termination of the input source shall be automatically provided internally unless a cable is plugged into the loop-through connector.

Sync for the unit shall be taken either from the sync input connector, or in the absence of such a signal, the sync shall be derived from the source signal on input 1. A Sync output connector shall be provided for onward transmission of sync source.

There shall be 16 balanced Audio inputs on Phoenix/Combicon type connectors, which may be configured as 8 stereo pairs or 16 mono inputs. It shall be possible to matrix these to 8 mono or 4 stereo pairs of outputs. It shall be possible to assign audio destinations independently of video destinations if desired.

The unit shall contain sufficient memory to store 8 matrix configurations per video output zone. These configurations shall be recalled via a standalone PC application software controller, by which it shall be possible to setup and recall matrix configurations.

There shall be a connector for external control devices, which shall allow the selection of these matrix configurations, and also provide control of the stereo audio output level for each output zone. If no configurations are in memory, it shall be possible to connect a switch to select an input source for each output zone, along with audio output level control via a potentiometer.

It shall be possible to connect the video/audio matrix switcher to a Soundweb DSP device, such as an SW9088ii, SW9008 or SW9000ii, using an RS-232 cable. It shall be possible for the switcher to receive configuration change data from the Soundweb system by way of Preset configuration data. Such commands will override any matrix configurations stored in the switcher's own internal memory.

It shall also be possible to control the switcher's matrix configurations using RS-232 control string commands from other external equipment such as multimedia control systems.

The video/audio matrix switcher shall have a video bandwidth of at least 150MHz.

The video/audio matrix switcher shall be the **BSS Audio Soundweb SW9016**.



## Soundweb SW9026 Audio Matrix Switcher

Architects and Engineers Specifications

April 2002

The Audio Matrix Switcher shall accept up to 16 balanced Audio inputs on Phoenix/Combicon type connectors, which may be configured as 8 stereo pairs or 16 mono inputs. It shall be possible to matrix these to 8 mono or 4 stereo pairs of outputs.

The unit shall contain sufficient memory to store 8 matrix configurations per output zone. These configurations shall be recalled via a standalone PC application software controller, by which it shall be possible to setup and recall matrix configurations.

There shall be a connector for external control devices, which shall allow the selection of these matrix configurations, and also provide control of the stereo audio output level for each output zone. If no configurations are in memory, it shall be possible to connect a switch to select an input source for each output zone, along with audio output level control via a potentiometer.

It shall be possible to connect the video/audio matrix switcher to a Soundweb DSP device, such as an SW9088ii, SW9008 or SW9000ii, using an RS-232 cable. It shall be possible for the switcher to receive configuration change data from the Soundweb system by way of Preset configuration data. Such commands will override any matrix configurations stored in the switcher's own internal memory.

It shall also be possible to control the switcher's matrix configurations using RS-232 control string commands from other external equipment such as multimedia control systems.

The audio matrix switcher shall be the **BSS Audio Soundweb SW9026**.



<b>1.30 Build 54 to 1.40 Build 58 Update</b>	<b>351</b>
<b>1.30 Build 53 to 1.30 Build 54 update</b>	<b>351</b>
<b>1.30 Build 52 to 1.30 Build 53 update</b>	<b>351</b>
<b>1.20 Build 23 to 1.22 Build 25 update</b>	<b>352</b>
<b>Software changes in Soundweb Designer V1.18.2 to V1.20</b>	<b>353</b>
<b>Soundweb Designer V1.16 to V1.181</b>	<b>356</b>
<b>Software changes in Soundweb Designer V1.16 to V1.18</b>	<b>356</b>
<b>Software changes in Soundweb Designer V1.16 to V1.16 update 1</b>	<b>357</b>
<b>Software changes in Soundweb Designer V1.14 to V1.16</b>	<b>358</b>
<b>Soundweb Designer V1.10 to V1.14 update</b>	<b>360</b>
<b>Soundweb Designer V1.08 to V1.10 update (and 9088 embedded V1.14 to V1.16)</b>	<b>362</b>
<b>Soundweb Designer V1.06 to V1.08 update (and 9088 embedded V1.10 to V1.14)</b>	<b>363</b>
<b>Soundweb Designer V1.04 to V1.06 update (and 9088 embedded V1.08 to V1.10)</b>	<b>365</b>
<b>Soundweb Designer V1.02 to V1.04 update (and 9088 embedded V1.06 to V1.8)</b>	<b>366</b>
<b>Soundweb Designer V1.00 to V1.02 update (and 9088 embedded V1.00 to V1.6)</b>	<b>368</b>



## 1.30 Build 54 to 1.40 Build 58 Update

### New Features

1. Added support for 3088 device.
2. Added firmware version list in network dialog.
3. Added buttons to turn on and off multiple eventlog filters.

### Bug Fixes

1. Fixed various power down flash problems.
2. More consistent parameter presets for handles in different configurations.
3. Error in frequency response in digital cards (9088 devices only).

### Firmware changes

9088 v1.58 to v1.60	9088II V1.18 to V1.20	9088IIs v1.10 to v1.12
9000 V1.48 to V1.50	9000IIs v1.04 to v1.06	9010 V1.32 to v1.34
9008 V1.10 to V1.12	9008IIs v1.06 to v1.08	3088 V1.00

## 1.30 Build 53 to 1.30 Build 54 update

No fixes or enhancements to Soundweb Designer 1.30

### Firmware changes

9088 v1.56 to v1.58	9088II V1.16 to V1.18	9088IIs v1.04 to v1.10
9000 V1.46 to V1.48	9000IIs v1.02 to v1.04	9010 V1.30 to v1.32
9008 V1.08 to V1.10	9008IIs v1.00 to v1.06	

## 1.30 Build 52 to 1.30 Build 53 update

### Bug Fixes

Fixed Video Switch flag is not lost in properties.

### Firmware changes

9088II V1.14 to V1.16	9088IIs v1.02 to v1.04	9000 V1.44 to V1.46
9000IIs v1.00 to v1.02	9010 V1.28 to v1.30	9008 V1.06 to V1.08
9008IIs v1.00		

## 1.28 Build 42 to 1.30 Build 52 update

### New Features

1. Video and Audio switch support.
2. Support in the loader for 9000iis.

### Bug Fixes

1. Buttons placed on Control Ports as toggle buttons no longer get left out of presets and param. presets.
2. ID info for parameter presets is now shown in the status bar rather than on a tooltip.
3. Parameter presets in 'Button Mode' now 'depress' like normal buttons when clicked.
4. Any changes in a devices serial window will now signal the need to re-load the device.



## Firmware changes

9088 V1.54 to V1.56

9000 V1.42 to V1.44

9008 V1.04 to V1.06

9088II V1.12 to V1.14

9000IIs v1.00

9088IIs v1.00 to v1.02

9010 V1.28 to v1.30

## 1.20 Build 23 to 1.22 Build 25 update

### New Features

1. Auto-Online - it is now possible to launch the application with a specified design file and the PC will go online to the devices, and load the design file.
2. It is now possible in a security enabled design file to Log Out, then Log In as a different user without closing and re-opening the design file, as was previously required.
3. Full Screen Mode - enlarges a map window to full screen size.
4. Link Buttons can now have bitmaps and also be used to exit the application, and to log in/out in a security enabled file.
5. Export handles function (i.e. for SMAART) is now a permanent part of Designer.
  - Added Class ID
  - Added File version number and Soundweb version number to start
6. New Processing Object - Modulator.
7. New Groups:
  - 'Primitives' - containing Modulator
  - 'Tools' - containing Tone Generator, Metering Point, Noise Generator & Network Selector ( 'Special' group has been Removed)
8. Macro Control panels which are bigger than the Soundweb Designer window are now resizable and scrollable.
9. Multiple ports can now be created simultaneously in the Macro creation view
10. Duplicate Macros (different Macro-files containing Macros with the same name) are handled much more clearly by new startup dialogues
11. Old design files with *lost* Macro links are recognized and a list of the affected macros is shown to the user

### Bug Fixes

1. The control port setting now takes precedence over settings in Presets when controls are placed on control ports and also included in Presets & parameter presets.
2. Asymmetric boost/cut now works in Macros.
3. Closing a design file whilst online no longer cause problems.
4. Linking parametric controls no longer causes all controls to affect band 1.
5. Shift - double click for default settings of parametrics now working properly.
6. Changing the property of a boost/cut control of a parametric no longer shifts the 0db position incorrectly.
7. Groups are no longer 'lost' when created with Macros.
8. links in Macros are now much more stable.
9. Macros containing gains with default value set to -INF no longer cause problems.
10. Control properties [RANGE] are now stored for Macros.
11. Linking controls from Device control panels (e.g. analogue output gains) no longer causes problems
12. Copy Settings & Paste Settings between Parametric EQ control panels now works properly.
13. Inaccuracies in Parametric EQ curve display, especially for notch settings. Now fixed.



Note: AMX is now called Panja.

SW9088 embedded software changes V1.48 to V1.50



## Software changes in Soundweb Designer V1.18.2 to V1.20

### New Features

#### 1. Dynamic Metering

It is now possible to visually monitor the existence of a signal through the dsp layout on the PC screen using a flying meter probe.

#### 2. Warning dialogues

On deleting device or processing objects from the layout. Reintroduced.

#### 3. Presets

Loss of information warning dialogue when deleting Presets introduced.

Faster Preset activation achieved.

More memory now available for storage of Presets in devices.

#### 4. Undo

A simple undo facility has been added that can reverse recent operations.

#### 5. About dialogue enhancements

The About dialogue now displays extra information including a list of any Macros that are installed for use with the active copy of Soundweb Designer.

#### 6. 9088ii support

This includes new device control panels for the AES digital cards. Also a 9088 object in a layout can be transformed into a 9088ii device.

#### 7. 9088 analogue output control panel additions

Both the 9088 and 9088ii analogue output control panels have been updated to include edit boxes under the faders for the input of accurate output level values. It is also now possible to link these outputs when used in a custom control panel.

#### 8. Configuration windows

Are now read only when the system is online. A safety feature to prevent accidental offlining whilst observing a configuration layout.

#### 9. New Layout tools

In Design mode it is now possible to align multiple objects, remove gaps between them and make them the same size as a chosen object.

#### 10. New clip event

A new event has been added to the Event Log functionality that registers the presence of over peak signals in the dsp of a Soundweb device.

#### 11. New Gain Processing objects

There is now a new category of processing objects - 'Gains'. 2 in, 4 in and 8 in gains have been included to accompany the single Gain control.



## 12. FIR Filter

A new filter processing object that can import mathematically created FIR filter coefficients exported from other applications as comma separated value (.csv files) or .dat format files.

## 13. Parametric EQ revisions

Parametric EQ processing objects now include extra controls to adjust parameters such as frequency, slope, type, width and boost/cut for each band.

## 14. Momentary buttons

Control panel buttons, e.g. mutes, can now be used in momentary mode, i.e. the button will be active as long as the mouse is kept clicked on it.

## 15. Network status additions

A new toolbar indicates the network status of Designer, i.e. either 'Online' or 'Offline'.

## 16. Control port support for three wire connections

Linear potentiometers or faders can now be used as continuous controllers via the 9088ii control port connectors. In the Control Ports window there are now two buttons to select whether the device functions in 2 or 3 wire mode (2-wire mode emulates the original 9088/9000 control ports).

Select '3-wire' mode to use linear controls and '2-wire' mode to use logarithmic controls. Note: only one mode can be used per device although different configurations could have either mode set up.

## 17. 'Inverted Direct Action' option

A third option has been added to the possible operation of a button attached to a control port.

Inverted Direct Action is basically the same as Direct Action but in reverse, i.e. this could be used as a Press to talk as opposed to a press to mute.

## 18. Rename Object

A 'Rename' function is now available in the right click menu of a processing object. This changes its unique id assigned by Designer, e.g. P12, to a name of the user's choice.

## 19. 9010 bitmaps

In the Button Setup screen for the 9010 remote there is now an extra button which can load in a 128x64 pixel monochrome bitmap image to display on the remote's screen, e.g. a company logo.

## 20. New online help system, specially rebuilt for version 1.2

**SW9088 embedded software changes V1.44 to V1.46**

**SW9000 embedded software changes V1.32 to V1.34**

**SW9010 embedded software changes V1.20 to V1.22**



## **SW9088 embedded software changes V1.42 to V1.44**

1. For Designer 1.18.2 compatibility with issue 1 AES cards.

## **SW9088 embedded software changes V1.40 to V1.42**

## **SW9000 embedded software changes V1.30 to V1.32**

## **SW9010 embedded software changes V1.18 to V1.20**

1. Fixes mastership issues
2. Fixes Hub crashing problem
3. Reduces rogue noises

## **SW9088 embedded software changes V1.38 to V1.40**

## **SW9000 embedded software changes V1.28 to V1.30**

## **SW9010 embedded software changes V1.16 to V1.18**

1. FIR Filter processing object has been added

## **SW9088 embedded software changes V1.36 to V1.38**

## **SW9000 embedded software changes V1.26 to V1.28**

## **SW9010 embedded software changes V1.12 to V1.16**

1. Release to Fix Network polling

## **SW9088 embedded software changes V1.34 to V1.36**

## **SW9000 embedded software changes V1.24 to V1.26**

1. Fibre Tmix fix



## Soundweb Designer V1.16 to V1.181

SW9088 embedded software changes V1.24 to V1.34

SW9000 embedded software changes V1.14 to V1.24

SW9010 embedded software changes V1.06 to V1.12

Software problems corrected:

1. The network is now more robust.
2. On 9088s the mic gain was not being recalled correctly from presets.
3. Controls on the control ports were not being read correctly after a preset change.
4. Parameter preset buttons on control ports would activate continuously if the button was held down. This caused problems when used with latching buttons.

Software additional features:

1. Parameter preset lists can now be added to the 9010.
2. Source selectors are now more efficient.
3. All Parametric EQ's now have a stereo equivalent, and 8-band parametrics have been added.
4. An ambient noise compensator object has been added.
5. Support has been provided for modem operation of Soundweb networks.
6. Meters used to stop working with a release of more than five seconds. This has been fixed.
7. Source matrix processing objects have been added.

## Software changes in Soundweb Designer V1.16 to V1.18

Software problems corrected:

1. Updates to the resource bar (configuration view) are now delayed whilst changes are being made to a configuration. This stops editing from being slowed down.
2. An installation problem with Windows NT has now been resolved.
3. The Flat button in the parametric has been removed - shift double-clicking the parametric curve will still serve the same purpose.
4. Window layouts for map windows are now accurately restored after save.
5. Screen "artefacts" were being left behind when editing in some configurations. This has now been resolved.
6. The kit list now displays wires which start and end on different map windows correctly.
7. Files which refer to macros which have subsequently been removed can now be opened - the references to macros will be removed when the file is opened. Warnings about missing macros will now be displayed once per missing macro type rather than per missing macro instance.



8. Feedback loops no longer result in multiple compiler warnings.
9. Multiple wires connected to the same box output or processing object input in a configuration window will now show as red to highlight the error.
10. Soundweb Designer will now go offline if a box resets.
11. Scale objects now work in macros.
12. Mixer control panels have been tidied up.
13. Compressor processing objects used to have problems with resizing when sidechains were enabled. This has been fixed.
14. When you copy a compressor the sidechain settings are now copied also.

### Software additional features:

1. Presets / Parameter presets can now be controlled by a resistor ladder on a control port.
2. The 9010 simulator window can now accept keyboard input.
3. The PC can now log events and faults from Soundweb units and display them for reference and / or troubleshooting.
4. Excluding devices from presets now turns the mouse cursor into an hourglass whilst busy.
5. Source matrix objects have been added.
6. Preset lists can now be added to the 9010.
7. Connections in the kit list are now sorted.
8. You can now double-click in the the "Go to map window" view as an alternative to selecting a window and click "OK".
9. Copy / Paste control values has been added to allow copying of settings which needn't force Soundweb to go offline.
10. All Parametric EQ's now have a stereo equivalent, and 8-band parametrics have been added.
11. An ambient noise compensator object has been added.
12. Support has been provided for modem operation of Soundweb networks.
13. Some PCs would crash when loading devices which had AMX controls or control links.
14. In some circumstances a parametric EQ filter could move to the wrong position when clicked on and released without moving it.

### Software changes in Soundweb Designer V1.16 to V1.16 update 1

#### Software problems corrected:

1. Some PCs would crash when loading devices which had AMX controls or control links.
2. In some circumstances a parametric EQ filter could move to the wrong position when clicked on and released without moving it. 1.14 to 1.16 update (9088 V1.20 to V1.22, 9000 V1.10 to V1.12 & 9010 V1.00 to V1.04).



## Software changes in Soundweb Designer V1.14 to V1.16

Software problems corrected:

1. Radio grouped buttons placed on control ports did not function correctly.
2. Several large matrix mixers on-screen at once could interfere with each other when selecting different tabs.
3. Designer now detects when the serial cable is disconnected.
4. It was possible for users to see map windows which they did not have access to.
5. In a secure design file there were menu options which were still accessible to users who did not have access.
6. There were circumstances when deleting the last visible map would cause designer to crash.
7. Designer did not warn the user when they had exceeded their preset limit.
8. There were problems with parameter synchronisation which caused designer to incorrectly sync to devices which did not need it.
9. Start maps for users did not work.
10. It was not possible to delete the last macro in an SDF file.
11. Designer did not launch correctly when the user clicked on an SDF file in explorer.
12. When a fader's 'Max' and 'Min' were changed, the values were lost on saving and then opening the file again.
13. Parametric Eq curves were sometimes displayed incorrectly when first created.
14. There were problems with non-ascii characters in configuration names. This would cause problems when using non-english versions of Windows.

Software additional features:

1. You can now 'morph' a combo control into buttons.
2. Now fully compatible with the new 9000ii hub.
3. LEDs can now be inverted on logic outputs.
4. A phase processing object has been added.
5. There is now a 'Paste control values only' menu option so that designer is not taken offline when copying the settings from one processing object to another.
6. You can now have several PCs online at the same time.
7. Larger matrix devices have been added.
8. There are now 'Network Selectors' which can be used to create fault tolerant networks.
9. A 'Locate Object' menu item has been added for finding processing objects in a configuration.



### **SW9088 embedded software changes V1.20 to V1.22**

Software problems corrected:

1. The networking is now much more robust.

Software additional features:

1. There are now 'Network Selectors' which can be used to create fault tolerant networks.

### **SW9000 embedded software changes V1.10 to V1.12**

Software problems corrected:

1. The networking is now much more robust.

Software additional features:

1. There are now 'Network Selectors' which can be used to create fault tolerant networks.

### **SW9010 embedded software changes V1.00 to V1.04**

Software problems corrected:

1. Controls which are inactive are now displayed as a 'no entry' sign.

Software additional features:

1. There are now 'Network Selectors' which can be used to create fault tolerant networks.





## Soundweb Designer V1.10 to V1.14 update

(9088 V1.16 to V1.20, 9000 V1.06 to V1.10).

Software problems corrected:

1. Parameter preset bar added to ADD menu
2. Generation of corrupt presets was possible in V1.10
3. Parameter preset bar on AMX window crashed Designer on closing
4. Delay/distance conversion accuracy improved
5. After deleting many links Designer could crash on close of file
6. Tone generators didn't work in macros
7. Preset button colour option removed to avoid confusion
8. Stereo linking was not working in macros
9. Changing control port set up did not kick you off line.
10. Save as/first save did not save file as 'compiled', so forced a compile on loading
11. Editing macros could cause SD crash
12. Not saving changes to presets could cause crashes
13. Meters from dynamics did not work in macro control panels
14. Bypass EQ's in parametrics didn't update graphics when used in presets.
15. Deleting linked controls which are in a parameter preset could cause a crash
16. Auto mixers (8:1 & 16:1) had no master out selection.
17. Copied (duplicated) parameter preset bars could cause problems

Software additional features:

1. Linking now works on most control types
2. Stereo linking across devices now possible
3. New Device Dialog now allows options to be set
4. Crossovers now include (optionally) delays, meters, phase and mutes.
5. Progress bar added to splash screen at startup
6. Designer can now detect a change in the network layout
7. Can now place macros into groups
8. Reverse action property added to led object on control ports
9. Presets controlled from control ports now allows permanent selection
10. All-flat button added to graphic equalisers
11. Bypass button added to Parametric and Graphic equalisers
12. Leveller added
13. Changed phi to POL on gain and mixer panels
14. Sidechain property added to expanders
15. Faster and more efficient compiler
16. 9010 compatibility
17. Resource gauge is now absolutely accurate
18. Compiler now allows you to omit compensation delays if >100%





## SW9088 embedded software changes V1.16 to V1.20

Software problems corrected:

1. 6dB/Octave crossovers could go unstable and oscillate
2. PC and control port toggles could get out of sync
3. Had to press toggle switches twice after Preset/load/power-up
4. Network reliability improved for large systems

Software additional features:

1. Ducker range increased
2. Soundweb Interface Kit now available for extended RS232 control
3. Linking now works on most control types
4. Stereo linking across devices now possible
5. Crossovers now include (optionally) delays, meters, phase and mutes.
6. Reverse action property added to led object on control ports
7. Presets controlled from control ports now allows permanent selection
8. Leveller added
9. Maximum number of control links increased

## SW9000 embedded software changes V1.06 to V1.10

Software problems corrected:

1. 6dB/Octave crossovers could go unstable and oscillate
2. PC and control port toggles could get out of sync
3. Had to press toggle switches twice after Preset/load/power-up
4. Network reliability improved for large systems

Software additional features:

1. Linking now works on most control types
2. Stereo linking across devices now possible
3. Crossovers now include (optionally) delays, meters, phase and mutes.
4. Reverse action property added to led object on control ports
5. Presets controlled from control ports now allows permanent selection
6. Leveller added
7. Maximum number of control links increased
8. Ducker range increased
9. Soundweb Interface Kit now available for extended RS232 control



### Soundweb Designer V1.08 to V1.10 update (and 9088 embedded V1.14 to V1.16)

Software problems corrected:

1. Aux bus B on 16 to 1 mixer produced no sound.
2. Devices with nonsense names were being found on the network.
3. Comms had to closed manually (with CTRL-ALT-DEL) if Soundweb crashed.
4. Comms remained open when Soundweb couldn't find a device.
5. Crash when number of decimal places in scale control properties was set above 20.
6. Config change from control port window wouldn't take Designer offline.
7. Device name was allowed to exceed limit set by hardware.
8. Odd graphical behaviour when notching symmetrical parametric eqs.
9. 16x8 matrix devices imported from v1.02 wouldn't control audio properly.
10. Soundweb always forced compile after load under some circumstances.
11. Parameter sync had problems with send all / receive all.
12. Soundweb could crash on closing documents with amx controls.
13. Selecting OK in the gallery when empty caused a crash.
14. Crash occurred intermittently on loading some boxes.
15. Designer was not updated to reflect control port settings on loading a config.

Software additional features:

1. Application loader integrated into Designer.
2. Controls for 1 band peq can now be placed on control ports.
3. Improved configuration loading reliability.

### SW9088 embedded software changes V1.14 to V1.16

Software additional features:

1. Code added to support new integrated loader.

### SW9000 embedded software changes V1.04 to V1.06:

Software additional features:

1. Code added to support new integrated loader.



## Soundweb Designer V1.06 to V1.08 update (and 9088 embedded V1.10 to V1.14)

### Software problems corrected:

1. Mini preset bars sometimes did not work in minimised windows.
2. Loading a device could 'time out' (fail) for very complex configurations or large number of presets.
3. Could get 101% compile error on some designs.
4. Pulling up a new Parametric EQ filters could remove a nearby one.
5. Mini preset bar would not 'drop down' if close to the bottom of screen.
6. PC Crashed at load time when parameter preset put on a control port.
7. Graceful recovery when (unavailable) 9010s found in designs.
8. Choose title block dialoge box should default to .enh not .wmf.
9. Configuration names could be reserved names.
10. Deleting map window was not setting modified flag, so did not prompt to save.
11. Was not going off line when deleting Devices.
12. Control sub-ranging was wrong, so changing the range of a control had incorrect effect.
13. Pressing Go Offline button in network view did not move device name from everything OK box.
14. Cutting/copying inputs and outputs in macro view caused crash.
15. Resource leaks in tabs - could cause PC crash after extended use.
16. Parametric EQ Controls which grey out on pulling a filter to 0db didn't grey out on flattening the eq (dbl-click).
17. Occasionbally PEQ filters showed as 1 oct on PC but were 0.05 in device.
18. Macros in macros could fail to pass audio.
19. Adjusting an unselected Parametric EQ filter shape using the right-click menu did not adjust the parameters correctly.
20. Controls in macros were not defaulting correctly.
21. Presets did not change filter type in crossovers.
22. Crossover slopes jumped to out when adjusted.

### Software additional features:

1. Symmetrical boost/cut property added on Parametric EQs.
2. Now checks data when going online to determine whether device needs reloading.
3. Now allows one device configuration to be changed without muting rest of devices.
4. Presets can now exclude nominated devices.



## SW9088 embedded software changes V1.08 to V1.10

Software problems corrected:

1. 16x8 matrix mixer version fixup from pre V1.06 was wrong.
2. Meter attack times were resetting to minimum value.
3. Mic gain was incorrect when networked audio was used on the same device.
4. Automixer o/ride stopped channel 'on' LED action.
5. Presets did not change filter type in crossovers.
6. Upgrading from 9088v108 to 9088v110 allowed incompatible data.
7. Single band parametric eq's didn't store curves which had been flattened in parameter presets.
8. Mixer controls now work on AMX panel.
9. Audio channels could occasionally get swapped over the network.
10. Very large configurations with many presets could cause data to be lost at power-up.
11. Some layouts could cause DSPs to crash.
12. Large networks could become fragmented at startup.

## SW9000 embedded software changes V1.02 to V1.04

Software problems corrected:

1. Hub could crash if a double ring was connected.
2. Large networks could become fragmented at startup.
3. Hub sometimes did not recognise changes to network connections.



## Soundweb Designer V1.04 to V1.06 update (and 9088 embedded V1.08 to V1.10)

Software problems corrected:

1. The network window has been updated, and now gives more information when devices fail to load.
2. Devices would not load correctly when presets or configurations had names longer than 21 characters. It is now impossible to enter names which are too long.
3. Soundweb Designer files have correct icon when viewed in Explorer and file dialogs.
4. Soundweb was crashing on opening some files containing macros which were no longer present. This has been fixed.
5. Soundweb is now able to recognise when a device is running software which is more recent than itself. When it is unable to work with a device, this will be conveyed to the user.
6. Rotary controls on matrix processing objects will now display their value whilst being adjusted.
7. When exporting macros, the design file will retain the name of the last exported macro file - making it easier to keep track of your macros.
8. Designs which had more than one feedback path to the same object would crash on compile.
9. Designer would allow you two have configurations with the same name. This has been fixed.

Software additional features:

1. It is now possible to specify different control port and logic output setups for different configurations.
2. Links can now relate up to 512 controls. In line with this, "stereo link" has been renamed to "soft link"
3. The default frequency settings for High Pass and Low Pass filters have been swapped.
4. "Mini-presets" have been renamed to "Parameter-presets" as this is considered a less ambiguous name.
5. Matrix processing objects have been optimised and new, larger matrix objects have been added. In order to make these more usable, navigation buttons have been added to the control panels.

N.B.

Matrix mixers / routers have been improved for the new version of Soundweb. However, this may impact old files. The following should be noted:

Push-buttons copied from a matrix device to a custom control panel will perform in reverse. Switching the colours on the operation tab of the button properties will solve this problem. This will also be true of matrix control panels which have been renamed.

Push-buttons copied from matrix devices onto control ports / logic outputs will also perform in reverse - this may require some rearrangement of controls.



### SW9088 embedded software changes V1.08 to V1.10

1. The default state of the logic outputs may have been incorrect after initialisation.
2. Some parameter changes made before power off were not reinstated when powering up.
3. Occasional crash when changing presets. Caused by DSP memory not being correctly initialised.
4. Some network communications when units power up could be lost. As a result the state of some control inputs and logic outputs were not correct.
5. Incompatible configuration files from older versions of Soundweb Designer could be loaded and caused the DSP to crash. This has been prevented by adding version number checking on configuration files.

### Soundweb Designer V1.02 to V1.04 update (and 9088 embedded V1.06 to V1.8)

Software problems corrected:

1. Pasting controls to a Control Port window often led to them being pasted to the AMX window. This is now fixed.
2. Soundweb failing to open the com port could lead to five dialogs with the text 'Could not start comms'. This has been fixed to only appear once.
3. Having a mini preset bar on an AMX view could cause a crash on loading. This has been fixed.
4. There were problems with creating presets which contained buttons controlling stereo links. These have now been remedied.
5. An aux-bus port on the 4:2 mixer was being displayed as an input.
6. The capture facility on the preset button now accurately restores window positions.
7. The step size on delay spin switches is now 1 sample.
8. Preset changes now correctly set crossover parameters.
9. Input and output ports in the macro-creation view can now be deleted and checking has been added to make sure that no ports have the same name.
10. Buttons controlling stereo links now copy correctly and the copies will reflect changes in each other.
11. Radio groups are now correct and handling has been added for the case where the currently on button is pressed.
12. The crossover filters no longer jump erratically when the control has been copied.
13. The compressor release control is now labelled correctly.

Software additional features

1. The graphics in the 'Control Ports' window are now clearer with new 'Inputs' and 'Outputs' text labels.
2. The network labels on the 9088 Dsp and 9000 Hub are labelled more clearly.
3. Buttons can now be placed on control ports as either direct action or momentary



- action.
4. The gain control panel has been updated.
  5. Soundweb designer is now ready to be used with 9000 Hub devices.
  6. Compiling a device now sets the 'needs saving' flag for the file, so that the user is prompted to save the file before closing it.
  7. A dialog box will now request confirmation on deleting devices and macros.
  8. 4:1, 8:1 and 16:1 Automixers have now been added.
  9. Further speed and efficiency improvements have been made to the compiler. These will particularly affect configurations containing matrix devices.
  10. Linked controls are now highlighted in design mode. Links can be deleted by deleting all copies of the linking control.
  11. Deleting large groups of processing objects has been accelerated.
  12. A cancel button has been added to the compiler dialog.

### **SW9088 embedded software changes V1.06 to V1.08**

#### Software problems corrected:

1. Microphone input gain control corrected.
2. Incompatibility issues between previous Soundweb Designer version and 9088v1.06 caused configuration problems. File version checking has been updated to cope with this.
3. Using matched group link buttons occasionally failed to action the audio processing. This had been fixed
4. Radio group button links did not work properly.
5. Some radio group button operations informed the audio processing but did not reply to the PC when on-line.
6. A preset change which is triggered whilst another preset change is already taking place can cause the unit to restart.
7. Changing presets took too much time.
8. Outputs not in phase. This had been fixed

#### Software additional features:

1. Noise generators
2. Network start-up compatibility for new SW9000 units.





## Soundweb Designer V1.00 to V1.02 update (and 9088 embedded V1.00 to V1.6)

Software problems corrected:

1. Compiler would crash if a user macro contained crossovers with more than one band.
2. Compiler is more efficient and more designs will compile with less than 100% resource usage. The resource gauge is now more accurate.
3. Soundweb is more resilient with handling missing or corrupted temporary files. In cases of doubt it will force a recompile.
4. Preset changes were not correctly handling some parameters, such as crossover slopes.
5. Stereo linked gains would not work correctly when dragged down to minus infinity. The fader being dragged would go to minus infinity, but the linked fader would only go to -60 dB.
6. Stereo link button status is now stored correctly in .SDF files.
7. The compiler would crash when a wire had been duplicated and connected to the same inputs and outputs as the original.

Software additional features:

1. Separate directories for data files and design files.
2. Gains now go down to -80 dB before snapping to minus infinity.
3. Mini-presets can now be assigned to control ports.
4. The communications have been improved for increased reliability.
5. Soundweb Designer now detects the Hardware configuration of devices. With older versions of the SW9088 this can result in extra compilation when going 'on line'.
6. The help file has been updated to document new features.
7. AMX control has been added to Soundweb Designer. See help file for details.
8. The Soundweb Designer configuration compiler now produces smaller files, resulting in shorter load times and space for more configurations in a device.

## SW9088 embedded software changes V1.02 to V1.06

Software problems corrected

1. Stereo linking could fail to control linked objects in certain situations.
2. Stereo linked faders could allow signal through when fully down.
3. Mixer controls could start with random settings.
4. 'Open' Led on gate did not initialise correctly.
5. Expander meter did not initialise correctly.
6. Mixer Auxiliary bus did not initialise correctly.
7. DSP delay compensation corrected for EQs, Crossovers and Filters.

Software additional features

1. AMX control interface using rear comms. port (see Soundweb Designer Help).





2. Configuration loading speed increased.
3. Total Configuration space increased.
4. Communications stability improved.

## **SW9088 embedded software changes V1.00 to V1.02**

1. File truncation problem, could cause processing objects in large configurations to lose some functionality. This has been fixed.



# WHISEWORKS - Neville Thiele Method\* Crossover Filters



BSS Audio

## New Crossover designs

### What is the WHISEWORKS - Neville Thiele Method \* Crossover Filter?

A WHISEWORKS - Neville Thiele Method Crossover Filter (WHISEWORKS - NTM) is a new type of electrical/acoustical filter offering significant performance advantages over all previous crossover filter types in audio applications. The filter was developed by Neville Thiele (pronounced "Teel").

### Technical overview

It is not possible to provide one loudspeaker driver to cover all audible frequencies. Even if the frequency response could be achieved, the large size of the driver required to shift enough air at low frequencies would offer an impossibly directional beam at high frequencies because at small wavelengths, the differing path lengths from the extremities of the diaphragm to the listener would cause cancellations off-axis. It is necessary to provide more than one driver and to split the bands with an electrical filter or crossover. This filtering can be done by passive, active or digital means, external to or within the loudspeaker cabinet.

Ideally, the filtering is done so that when acoustically combined, the drivers produce a constant output across the whole range of frequencies of interest. Some crossover filter designs do not achieve this. Additionally, the signal phase behavior with frequency should offer smooth transitions to achieve a constant group delay. Many crossovers do not achieve this either.

Another important consideration is that the crossover should control the beaming properties so that listeners off-axis do not hear anomalies in the response. Many crossovers do not achieve this.

Finally, the signal should be quickly attenuated outside the optimum band of operation for each driver to avoid driver anomalies such as resonance and over-excursion distortion at low frequencies. Here some other crossover shapes have limitations.

The WHISEWORKS - NTM Crossover Filter achieves all these objectives.

- It sums to give constant output against frequency.
- It has a well-behaved phase response.
- It keeps the phase difference between adjacent drivers at zero degrees throughout the crossover region to prevent beam shifting.
- It has the highest known rate of attenuation in the stop band of all conventional analogue or analogue-equivalent filters of similar order.

### How does it work?

The WHISEWORKS - NTM crossover uses a unique notched response to achieve a very steep roll-off rate outside the pass-band. The 4<sup>th</sup> order NTM crossover amplitude response looks like the diagram overleaf. You will see that notches in the responses speed-up the rate of roll-off. Beyond the notch, the response rises again, but remains respectably attenuated.

\* WHISEWORKS - NTM and WHISEWORKS - Neville Thiele Method are trademarks of Precision Audio Pty Ltd

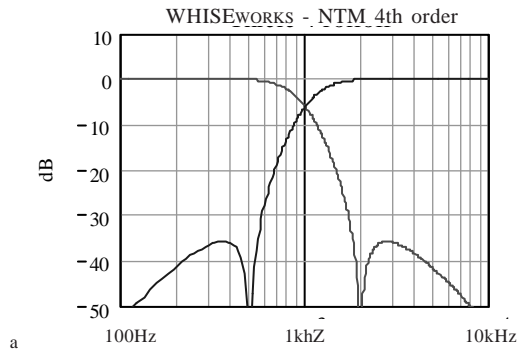

## Advantages

A WHISEWORKS - NTM Crossover Filter sums precisely to give constant output and well defined phase response, which is identical between the drivers (zero degrees difference) throughout the crossover region.

At the same time the WHISEWORKS - NTM filters enable far greater rates of attenuation with frequency outside the pass band for each speaker.

Shape	Order	Amplitude Response Flatness	Group Delay Flatness	Polar Response	Roll-off Rate
BUT 6	1 <sup>st</sup>	●●●●●●	●●●●●●	●	●
BUT 12*	2 <sup>nd</sup>	●	●●●●●●	●●●●●●	●●
BES 12*	2 <sup>nd</sup>	●●●●●●	●●●●●●	●●	●
L-R 12*	2 <sup>nd</sup>	●●●●●●	●●●●●●	●●●●●●	●●
BUT 18*	3 <sup>rd</sup>	●●●●●●	●●●●●●	●●	●●●
BUT 24	4 <sup>th</sup>	●	●●●●●●	●●●●●●	●●●●
BES 24	4 <sup>th</sup>	●●	●●●●●●	●●●●●●	●●●
L-R 24	4 <sup>th</sup>	●●●●●●	●●●●●●	●●●●●●	●●●●
BUT 48	8 <sup>th</sup>	●	●	●●●●●●	●●●●●●
L-R 48	8 <sup>th</sup>	●●●●●●	●●	●●●●●●	●●●●●●
NTM 36	4 <sup>th</sup>	●●●●●●	●●●●●●	●●●●●●	●●●●●●
NTM 52	8 <sup>th</sup>	●●●●●●	●●	●●●●●●	●●●●●●

The advantages are:

- Controlled frequency/phase response
- Faster roll-off rates enabling lower distortion and/or smaller drivers for a given low corner frequency of reproduction. This is particularly valuable in applications where space is at a premium. Driver and cabinet design constraints are also eased since designers can work 'closer to the edge' where resonance, breakup, or other anomalies may occur.

It can be seen from these comparisons that the 4<sup>th</sup> Order WHISEWORKS - NTM crossover shape offers the best group delay flatness of any crossover shape with a roll-off of at least 24dB/Octave.

Furthermore, the 8<sup>th</sup> order WHISEWORKS - NTM shape offers the steepest roll-off rate of all the crossover shapes compared here.

\* Requires polarity inversion

BUT is Butterworth, BES is Bessel, L-R is Linkwitz-Riley

NTM is WHISEWORKS - Neville Thiele Method

For many years, Linkwitz-Riley crossovers have been the 'industry standard' as they offered the best compromise for most of the important parameters.

The new WHISEWORKS - NTM crossover shapes now represent the optimal combination of characteristics for most applications, assuring it at least a place alongside Linkwitz Riley, if not becoming the new industry standard.

### BSS Audio

A Division of Harman International Industries Ltd  
 Cranborne House, Cranborne Road,  
 Potters Bar, Herts EN6 3JN, England  
 T: +44 (0)1707 660667  
 F: +44 (0)1707 660482  
 email: info@bss.co.uk  
 www.bss.co.uk

**H** A Harman International Company

## Soundweb in Control

If you have designed with, sold, and/or installed Soundweb, or would like to, this is for you. This document focuses on a new way to look at Soundweb in terms of control and opportunity.

Advanced control and automation systems are comprehensive and easy to navigate after installation and programming. They are often the right choice for the customer. At times they are the only solution. That comes at a price, as they are costly in hardware and programming labor. Many projects can and do accommodate the expense. However, these systems help bust budgets frequently, or more often the budget is reduced (“value engineered”). This presents an opportunity for Soundweb to control the action instead of being the first to get cut out of it!

### What does Soundweb offer as an alternative?

Let’s start with control interfaces. Soundweb offers two clever options: **Designer** software in Full Screen mode on a touch screen and the SW9010 ‘**Jellyfish**’ remote control.

Graphically Designer is the best-developed and most flexible software GUI in the installed sound DSP market because of its easy to program and use custom control windows. In addition, many are unaware of Designer’s “Full Screen Mode” which, on an inexpensive touch screen, completely takes over and functions very much like the costly touch screens the ‘advanced control and automation systems’ use.

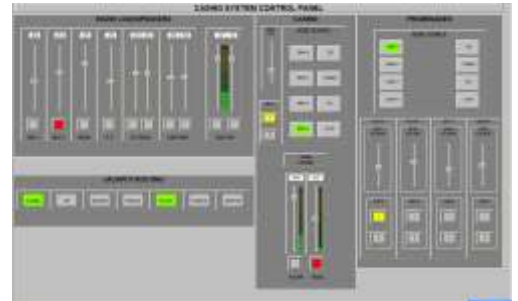

Soundweb as well boasts the 9010 Jellyfish, which is also acclaimed for being an easy to program and simple to operate control interface, with the tactile advantage of real buttons and a real knob. Built in mic, second mic input, local audio outputs, networked audio I/O, 999 custom pages possible with unlimited password protection, gain control range limits available; the list of Jellyfish advantages is extensive.

### That’s great, but how can Soundweb control external devices?

How about the little-noticed **Output Control Ports** on Soundwebs’ DSP units? Did you know that every Soundweb DSP unit has 8 logic control output ports? That includes the 9088iis networked signal processor, the 9008iis networked output expander, the 9000iis active network hub, and the newer, lower cost, non-networked 3088 Soundweb Lite.



We know Soundweb is not a show controller or an integrated control system, nor has it been presented as such. But what if we could convert our output control ports to the following, using low cost third party logic converters?

- Infrared Control
- High Current Relay
- Latching Relay
- Momentary Relay
- MIDI Control
- Serial Control



We have identified and are testing products from Radio Design Labs (RDL), Xantech, Lutron MIDI Solutions, and others. Most of them fall into a price range of \$10 to \$100 per Soundweb control port. Cost effective and simple.



# Soundweb™



The bottom line? You can successfully convert to the superior Soundweb DSP and control platform when all of the following conditions are present:

- An advanced, “control any device” automation system is specified.
- Lower priced, lower performing audio DSP has been specified, or is being considered to replace Soundweb due to ‘value engineering’.
- The list of external control commands required fits the total number of output control ports if Soundweb were to be specified. *It is important to note that it can be significantly less expensive to add one or more Soundweb DSP units JUST FOR THEIR CONTROL PORTS when more control is required!*
- Complex functionality is not required, i.e.: sophisticated feedback from external Devices, video streaming in a window on a touch screen, etc.

Depending on which Soundweb control interface is chosen (and what is being replaced), these conversions should result in significant savings compared to using the most commonly used control/automation systems. An interesting result from switching to SW9010 Jellyfish controllers is that the Soundweb portion of the project budget actually grows as the overall cost goes down! And touch screens running customized Designer control panels is a very satisfying GUI experience with the added bonus of superior audio performance with Soundweb replacing inferior DSP.

The conference room example below uses two Soundweb 9088iis units, which provide a total of 16 output control ports. They are converted to infrared with a Xantech 590 and to three types of relays with three different RDL “Logic Control Relays” as listed.

Soundweb DSP	Logic Converter	Control Type	Command
9088iis #1 (port 1)	Xantech 590 (port 1 of 16)	Infrared DVD	Stop
(port 2)	(port 2 of 16)		Play
(port 3)	(port 3 of 16)		Previous
(port 4)	(port 4 of 16)		Next
(port 5)	(port 5 of 16)	VCR	Stop
(port 6)	(port 6 of 16)		Play
(port 7)	(port 7 of 16)		FF
(port 8)	(port 8 of 16)		RR
9088iis #2 (port 1)	(port 9 of 16)	Projector	On
(port 2)	(port 10 of 16)		Off
(port 3)	(port 11 of 16)		Input 1
(port 4)	(port 12 of 16)		Input 2
(port 5)	(port 13 of 16)		Input 3
(port 6)	RDL LCR-1 Momentary relay	Screen	Projection screen up/down
(Port 7)	RDL LCR-1H High current relay	AC power	AC power to A/V system
(port 8)	RDL LCR-2 Latching relay	Lighting	2 lighting system presets

This is only one example! If you have an opportunity to take advantage of Soundweb in Control and in turn ensure the sound system will benefit from Soundweb’s superior performance, please contact us for more information and design assistance!

## BSS Audio

Cranborne House, Cranborne Road, Potters Bar, Herts EN6 3JN, England  
Tel +44 (0)1707 660667 Email info@bss.co.uk

## BSS Audio USA

Harman Music Group, 8760 S. Sandy Parkway, Sandy, Utah 84070  
Tel: 801-566-8800 Fax: 801-568-7662

**H** A Harman International Company



# Soundweb™

Harnessing the power of  
programmable DSP with  
flexible control

Clubs  
Hotels

Venues

Theatres

Law Courts

Theme Parks

Sports Stadia

Cruise Liners

Paging Systems

Leisure Centres

Function Rooms

Teleconferencing

Corporate Offices

Distance Learning

Houses of Worship

Convention Centres

Conference Centres

Live Sound Production

Performing Arts Centres

Universities, Colleges and Schools

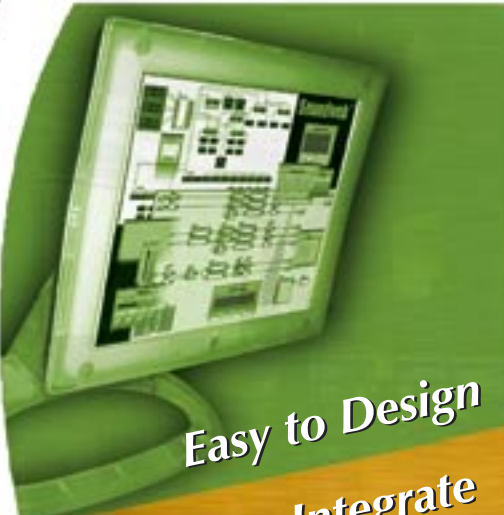

Easy to Design

Easy to Integrate

Easy to Install

Easy to Operate



The advent of programmable DSP systems has dramatically changed the way audio systems are installed. Tedious changeovers between sessions with large amounts of equipment to re-program and re-patch are a thing of the past, and gone are the large racks full of audio processing gear and complicated multi-way cabling between areas.



# Soundweb™

*A free design programmable DSP system means that you can have virtually any audio system design.*

*It means that you can change what your audio system is doing according to the type of event you are holding, just by recalling a preset.*

*It means that you can easily and quickly add more processing to the system without increasing the hardware budget.*

*It means that any specification changes during or after the design phase can easily be implemented.*

But while there are many DSP systems to choose from, Soundweb has a complete system approach unrivalled by virtually any manufacturer. A client base that includes the World's premier theme bar and Hotel chains is testimony to BSS's total approach to providing a universal system.

Soundweb is a set of audio processing units that can be linked by a digital communications network. The units are completely flexible; you program the signal paths and block diagram of the processing using a PC, choosing the processing blocks from an extensive library. Soundweb units can be fitted with microphone pre-amplifiers, so you can create almost any audio system, including all of the processing, all the way from microphone to power amplifier.

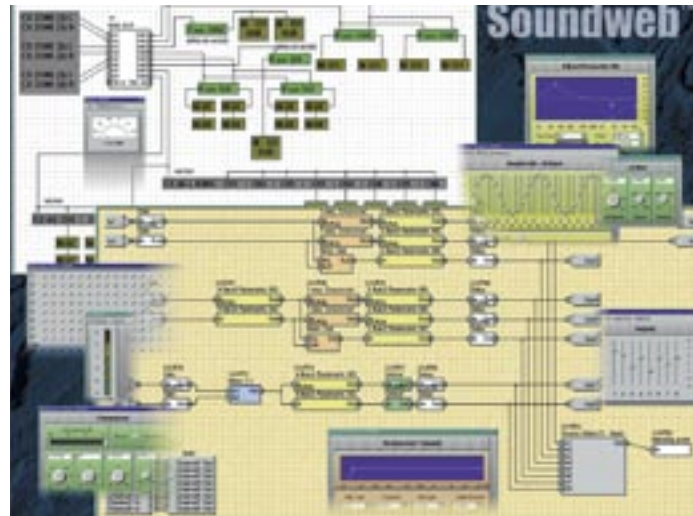

## FEATURES

- ❑ Distributed processing, networking and DSP means that hardware can be installed where it's needed.
- ❑ Proprietary networking that requires no external networking hardware or setups.
- ❑ Network carries both control data and 8 channels of bi-directional 24-bit 48kHz digital audio for pristine audio performance throughout the system.
- ❑ Proprietary and simple networking needs no IT skills to implement.
- ❑ High network tolerance and stability.
- ❑ Very low network latency makes Soundweb ideal for use in Live Event and Theatre applications.
- ❑ A variety of control options and interfaces mean that you can give your clients the exact level of control they need.
- ❑ Systems can easily be expanded or updated.

## What makes Soundweb so special?

Flexibility, easy expansion, digital audio networking over long distances, quality, heritage, simplicity of control, security and power — Soundweb by BSS Audio probably has more than any other digital matrix or processing system.

## Pristine Audio Quality

Vitaly, you can be sure of the highest audio quality, with Soundweb's 24-bit internal processing, headroom management, and advanced A/D and D/A conversion.

Importantly for your peace of mind, any Soundweb system can easily be expanded with further devices at a later date. Start-up costs for small systems are low, while sophisticated large-scale installations are cost-effective and very powerful.



## Easy to Design

All your audio system design is done offline (even while travelling on an aeroplane, if you like!). Using BSS's own Soundweb Designer software, you can build your system, design the processing path, set initial gains, routing, equalisation and dynamics processing. When you're ready, connect the PC to one device in the system, and upload.

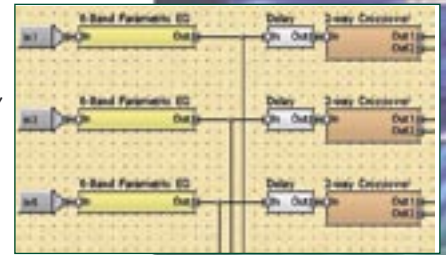

Soundweb offers a library of DSP processing objects that contains most of the commonly used audio processing functions. These include: automatic mic mixing, levelling, mixing, equalisation, filtering, crossovers, delay, and dynamics processing, as well as utility functions such as tone generators and meters, and macros allow you to create your own proprietary DSP objects.



## Easy to Install

Soundweb's audio and control network runs over standard computer Cat 5 cable, so installation is both low cost and simple. The network runs up to 300 metres/1,000 feet between devices with no degradation in audio quality.

Each Soundweb DSP device is totally self-contained, and the network means that you can install devices locally to their amplifier racks rather than in any one centralised location, and the low network latency (possibly the lowest in use) means that signal delays are minimal.

Each Cat 5 cable carries 8 channels of bi-directional 48kHz digital audio, so arrives at each point in the chain with exactly the same performance, even over very long distances. No other manufacturer provides such integrated audio and control networking capabilities over a single cable and network, at distances up to 300 metres/1,000 feet.



## Easy to Operate

From untrained operators and staff to fully-trained engineers, you can leave a Soundweb system with whatever degree of local control you like, whether it's no control whatsoever, or simple volume and switches for waiters and bar staff, or more sophisticated programmable control using the 9010 'Jellyfish' controller. This latter option provides customisable menu screens and a rotary encoder that can control virtually any system parameter that you choose to assign to it.

The most control obviously comes from leaving a PC on-line to the system with the original design file running. If you leave this PC for local control, ten levels of password protection offer your design the security you'll be happy with.



## Easy to Integrate

Soundweb also has comprehensive RS-232 serial interfacing, so that you can control the audio from external multimedia systems such as AMX or Crestron panels. Creating the control scripts for these systems is made easy within Soundweb Designer, while a complete serial interface programmers development kit is readily available and supplied with every unit on CD.



Soundweb doesn't stop at audio. Integrate audio with video using the SW9016 Video/Audio Matrix Switcher to control the simultaneous routing of video and audio sources to several zones, all under Soundweb control, or through AMX/Crestron multimedia systems.

## A New Filter Design for Outstanding Performance

The new Version 2.0 firmware includes new filter designs in the shape of the WHISEWORKS – NTM\* topology. This new design, developed by Neville Thiele and patented by Australia's Precision Audio, provides the fastest roll-off slopes outside of the pass band in modern IIR filter designs, while maintaining zero phase difference between adjacent bands throughout the crossover region, preventing beam-tilting. Listening tests have shown a marked and noticeable enhancement in performance over traditional Linkwitz-Riley 48dB filters. The new filters are kinder on the ear, and like the L-R design also maintain a flat frequency response throughout the crossover region.

**So if you want the best for your clients, and a future-proof installation, there can only be one choice —  
Soundweb by BSS Audio.**

\*The words "WHISEworks", "Neville Thiele Method" and NTM logotype are trademarks of Precision Audio Pty. Ltd. Manufactured under licence from Precision Audio Pty. Ltd.





## The Soundweb Network



The Soundweb network is based on a proprietary custom FPGA, which allows the transmission of 8 channels of 24 bit, 48 kHz audio in each direction, and also provides around 3 Mbit/s of bandwidth for control packets - these are used to send parameter changes, meter data, and various other control items.

Soundweb was one of the first systems to offer both audio and control networking on a single cable, and remains one of the easiest to install and use. Designed to incur only a very low latency, Soundweb systems are ideal for use in delay-sensitive applications such as Theatre Sound and other live events, including use on monitor systems.

The network uses standard category 5 cable, and connection is made via readily available RJ-45 connectors. No IT or network management knowledge is required, nor is any external networking hardware.



### SIMPLE SYSTEMS

The simplest Soundweb network is formed by connecting one RJ-45 cable between two Soundweb 9088iis's, which can be up to 300 metres/1,000 feet long. This enables 8 channels of audio plus control to travel between the two units. The existence of the control path means, for example, that a potentiometer connected to the control inputs on one unit can be used to control the output gain of a mixer in the other unit, and also allows a PC plugged into either one of the units to reload programs and adjust parameters on both devices.

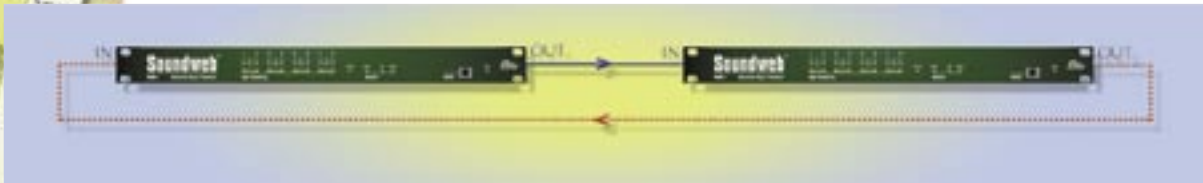
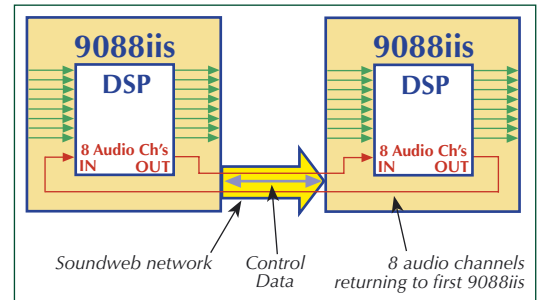

The dotted line shows the 'virtual' return path of the audio; no physical connection is made between these other network ports.

### LARGER SYSTEMS

For larger systems, daisy-chain a number of 9088iis's. In this case the network 'Out' jack of the first device is connected to the network 'In' jack of the second, then the 'Out' jack of this unit is connected to the 'In' jack of the third, and so on.

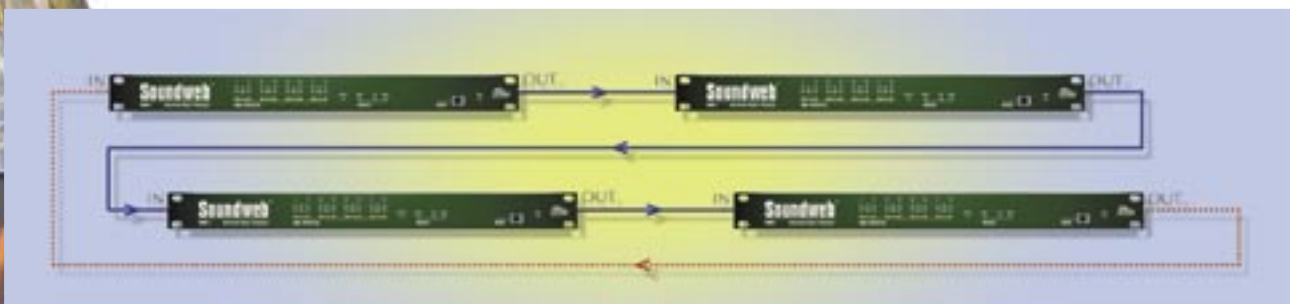
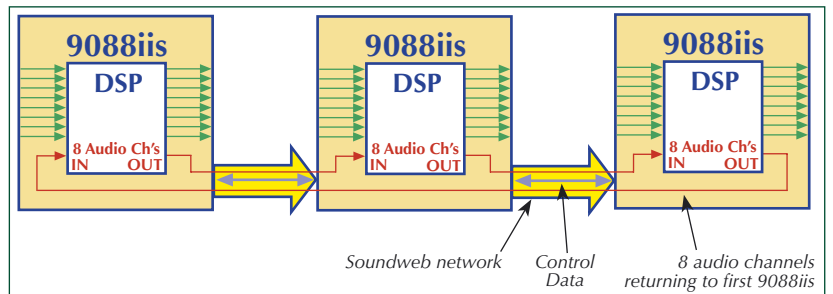

The 9088iis's form an audio ring in which 8 channels travel from the first unit to the last and then back to the first. At each device a channel can either be passed on from the previous unit in the ring or, replaced by an audio signal from one of the inputs or processing objects.

## COMPLEX SYSTEMS

To produce more complex networks, the Soundweb 9000iis hub is used. Each hub has six network jacks; each generating a full 8 channels of audio in each direction. It is possible to hook a chain of 9088s to each hub jack, so that the hub forms the interlock point between the audio rings. Multiple hubs can be connected together, and multiple connections can be made between these hubs to increase the number of channels available. Working on this principle a 'web' of processing devices can be built up; so naming the product.

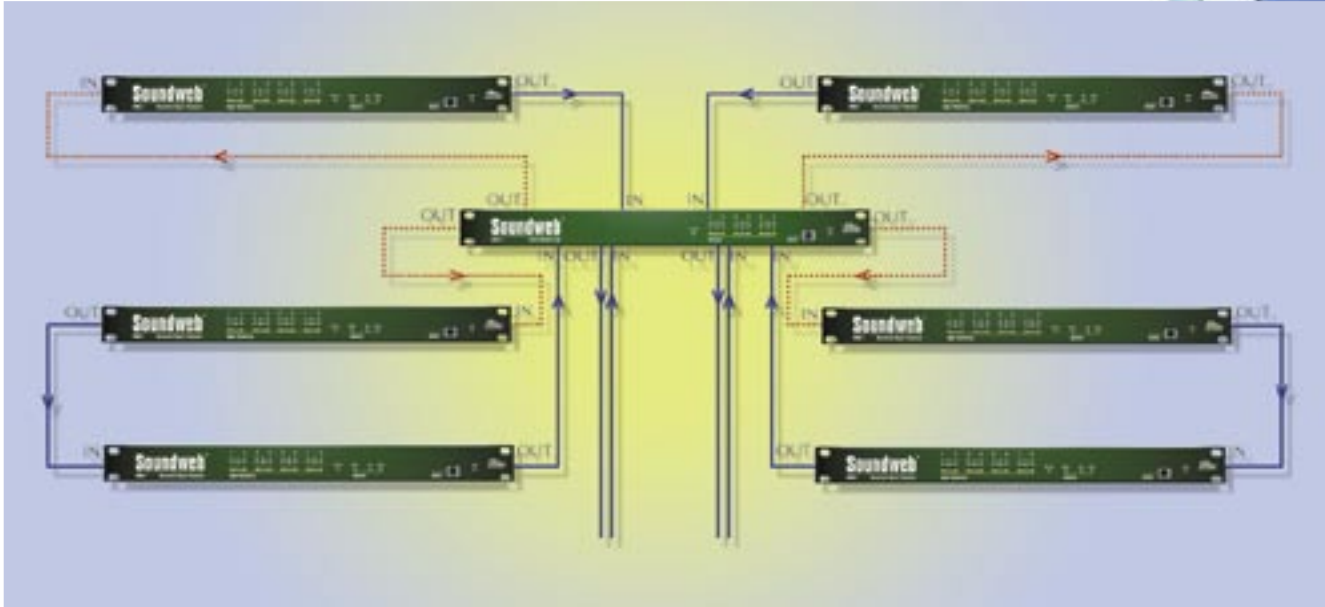

If a

Soundweb unit should lose contact with the rest of the network (perhaps because of a cable fault or power failure downline in another unit), it will continue operating according to its current audio settings. If power is removed and re-applied, it will recover the settings which were in force at the time that the power failed. The reason that this is possible is because of Soundweb's distributed processing.

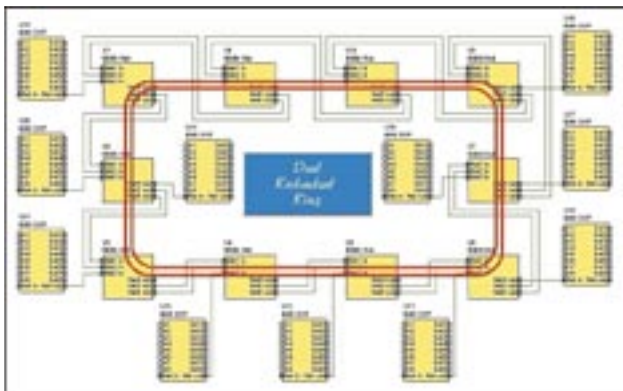

A dual redundant ring fault tolerant system has been developed for critical voice-evacuation situations using the 9000iis network hubs. The system will detect a break in a network cable, and choose the routing of the audio signals accordingly.



# Soundweb™



## Flexibility is the key

### CLUBS AND RESTAURANTS



#### Caddy Shack, USA

The SW 9016 Audio/Video Matrix Switcher was recently installed at the new Murray Bros. Caddy Shack theme restaurant in Myrtle Beach. Taking its name from the hit 1980 Warner Bros. film co-written by Brian-Doyle Murray and starring his famous brother, Bill, as loony greens keeper Carl Spackler, the two Murrays and their four other brothers are all partners in the venture.

Orlando-based production company Paradise Sound and Light, won the bid for the audio and video systems based on a design by Dave Becker, A/V Systems Integration Division.

*"This is probably the sixth or seventh installation I've done with Soundweb devices and they always amaze me," notes Becker. "You can get so much performance out of such a small package. The heart of Caddy Shack's entire audio and video system is pretty much contained within four single-rack-space units."*

Becker describes how the 9016 is being implemented: "All of the restaurant's video sources are patched into the BSS matrix switcher, including eight satellite receivers that are combined in one dish system as well as DVDs, VCRs and other sources. Aside from routing signals out to numerous televisions throughout the facility, the 9016 feeds out to a video splitter, the four outputs of which are tied into an NTSC quad generator allowing four games to be shown at once on each of the restaurant's 150-inch TVs in the Bunker Bar. It worked out really well and looks very nice."

Along with the 9016, the Murray Bros. Caddy Shack system includes several other Soundweb products, including a 9088ii DSP unit, one 9008 output expander and one 9010 programmable "Jellyfish" remote controller.

#### Chicago Rock Café, UK

Luminar Leisure have carried out a major £1m conversion of their Chicago Rock Café in Northampton, UK, providing the company with a flagship venue and increasing the capacity to 1500. With the relocation of the stage to its own mezzanine level, the venue is centred around live music. The large venue (with a massive 18 metres floor-to-ceiling height) is divided into three areas — the main room, the restaurant and Cuba Bar, situated inside the main entrance — and this is configured as a 16-zone system.



The primary task facing installer Lynx Lighting was the ability to change the venue's soundscape — with automatic

adjustment of the room's EQ settings in accordance with the different modes of music. This they did with the aid of four BSS 9088 Soundwebs and a 9010 Jellyfish remote. Via Soundweb, each area can select local sources, such as satellite — or multiplay CD in the Cuba Bar — while still receiving announcements from the main DJ booth.

Four BSS 9012 wall-mount panels provide the local user interface — featuring a five-way switch and rotary fader. However, in the live mixing area on the balcony, the house engineer has access to the Jellyfish and this allows him to override the system at any time.

The idea is to use the different processing blocks from each Soundweb to route around the whole network. The DSP is used for matrix routing and storing gain settings and limiting — delays in particular are used heavily depending on the different loudspeaker set-ups. As soon as a band takes the stage, emphasis switches to the front of the room and the delay settings will change. The engineer will type a preset and reconfigure in the Jellyfish.

*System Designer Jerry Denning states "Soundweb proves itself every time. This is because engineers' requirements change once you are on site. And so rather than have to add another analogue processor at the 11th. hour, it's simply a case of a few minutes' re-programming to extend his virtual dynamics."*

## Paging and simple control



### *Furzefield Centre, UK*

Major leisure and fitness centre — the Furzefield Centre in Potters Bar, UK — had been experiencing communications difficulties since undergoing a major refurbishment programme a few years ago. Local company Promedia Systems diagnosed that an audio cabling redesign and deployment of a BSS Soundweb system, with a touchscreen-driven front end, would provide the best solution to their public address requirements, and facilitate paging messages to the correct zones.

*The result is a system that the front-of-house reception desk staff have been able to embrace with the minimum of training.*

They rationalised all the cables and replaced all the amplifiers that weren't working – as well as specifying two 9088ii Soundwebs and a touchscreen to handle the front end. Via Soundweb, Promedia even applied tone generation to two duckers, linked together, to create the classic paging 'bing bong' sound.

Promedia also adopted the feature that allows Soundweb to load automatically at computer switch-on, whereupon it goes online and full screen (in this instance to a 15.1" TFT touchscreen resistive panel). The control surface is broken down into the 12 different zones around the venue (14 including induction loops). The zones can be highlighted and the respective mic activated at the press of the button.

This is a highly intuitive system, even with a lot of background music implemented, – from a general CD player as well as a dedicated gym CD player and a tuner – staff can easily select each music source in any of the zones from the touch panel. Soundweb also stores parametric EQ settings for the zones.

### *Ford Field, USA*

Ford Field, the new \$500M home turf of the NFL's Detroit Lions, benefits from BSS Audio processing thanks to local contractor Sound Media who installed the entire audio system based on a general specification provided by WJHW of Dallas, Texas.



A Soundweb system comprised of five 9088ii DSP units and a 9000ii network hub is called upon to provide signal processing and routing for Ford Field's extensive back-of-house areas, including concourses, suites, concessions areas, restrooms, press facilities, interview rooms, locker rooms and other locations. Most of the 1.85M square foot facility's BOH spaces rely on JBL Control 25 loudspeakers for uniform audio coverage throughout.

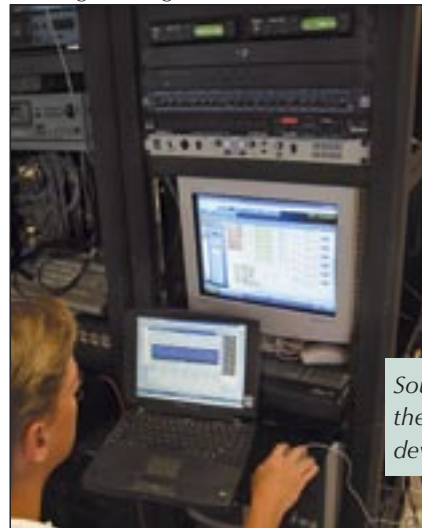

Steve Robinson, president of Sound Media, elected to install BSS components right from the start. "I use BSS primarily for one reason: because it works. I put Soundweb into the Greektown Casino here in Detroit a while back and it runs great. No problems. No reliability issues. Just solid, dependable performance."

Robinson further cited "ease of programming with Soundweb Designer" and "helpful tech support" as other key reasons for choosing BSS gear.

*Soundweb Designer running on a desktop PC provides control over the BOH system at Ford Field, while control over the other BSS devices in the bowl is via Soundbench software on a laptop.*



# Soundweb™



## HOUSES OF WORSHIP



### Distributing the Word

#### *New Birth Missionary Church, USA*

The New Birth Missionary Baptist Church in the Atlanta suburb of Livonia, GA is a very good example of how technology is becoming increasingly important and increasingly integral to the design and building of church and multimedia facilities, and particularly how sound has become very critical to the entire media design of the building.

Crucial to Custom Sound Designs' ability to meet all of the church's media needs was the choice of the Soundweb system controller and processing system. The ultimate goal was phenomenal sound to every seat in the house, and the sound sources range from a single voice in the pulpit to a six-hundred-voice choir with fifteen musicians and ten more solo singers. The Soundweb enabled the designers to connect the dots between the huge number of sound sources and the ultimate goal of perfect sound for everyone.

The system includes 20 SOUNDWEB DSP modules, a pair of 9000ii Hubs and five 9010 remotes. The control system also addresses audio system elements in a second building.

*"Any of the church's technical personnel can use it easily to essentially send any signal, anywhere, anytime they want, as the circumstances change. Once it's in, there's not a whole lot that has to be done."*

*"That kind of adaptability and flexibility is not only nice to have, but absolutely necessary these days, because situations can change quite radically very quickly."*

Doug Hood, General Manager of Custom Sound Designs

#### *Salisbury Cathedral, UK*

BSS Soundwebs are at the heart of an installation at Salisbury Cathedral, designed to make audio preset distribution a simple task for members of the vestry. The brief handed out by audio designer John Del Nero to BSS Audio for the routing of sound around Salisbury Cathedral's digital highway was to make the system conform to the traditional style of presentation, in an operator-friendly fashion. This was achieved using nine Soundweb 9088s, a 9000 hub and a 9010 'Jellyfish' remote. Vergers can select the type of service required, whereupon the system will reconfigure and the desired touch screen control panel will present itself.

The greatest challenge for BSS was in setting the correct delays. "Traditionally if a speech was being delivered from the East end of the cathedral, you would delay from East to West – and vice versa. But the problem comes when people start speaking in the middle of the nave. We solved this by putting delays on the inputs." Rather than the traditional technique of mixing mic signals together and delaying each speaker send, John Del Nero's design uses five discrete time delays for each cabinet, utilised dependant on where the signal originates.

BSS also use a Fujitsu Stylistic PC touch screen working on a radio-wave LAN, which can be operated from any part of the Cathedral. The main page has a plan of the cathedral and dropped onto that are little LEDs to show the status of each microphone - using a similar graphical representation of the loudspeaker zones, with presets which activate the system components required for a given service.



#### *Soo Young Roo Church, Korea*

major new-build house of worship in Pusan, Korea's second largest city, has its audio communication through the various auditoria networked via a number of 9088ii Soundweb digital devices.

main 5,000-seat sanctuary at the Soo Young Ro Presbyterian Church is joined by an 1800-seat and several 900-seat satellite chapels, all within a single complex.

design is based around 18 Soundwebs and other BSS processing hardware, and installed by Daiyoung, distributor. These take a live mix from the choir and floating mics used by the clergy, via a Soundcraft Series FIVE console and also routes the audio from the recording studio, based on the site. There is also an editing room, and the audio tracks are also processed through Soundweb. Services in the main sanctuary be televised and relayed into the smaller chapels.



## Audio Visual



### *Hodler-Saal, Germany*

Installers Horn Audio-Video-Systeme won the contract to install a BSS Soundweb system — comprising eight 9088MM and two 9010 Jellyfish — bringing Hanover's historic Hodler-Saal town hall into the 21st century.

The requirement was for a system that would enable council discussions to be heard with clarity and monitored with ease. Essentially the new discussion system needed to be tactfully integrated into this historical room in a way that would not disturb the optics of

the hall. The system needed to be practically invisible, user friendly and enable multiple and individual control for each member present.

Consultant Wolfgang Kintscher chose Soundweb on the strength of its flexibility. The Soundweb system controls over 60 microphones available to the members, each of whom can activate his or her microphone manually. Automatic mixers then control the levels, whilst the overall volume can be controlled by the chairman — allowing him the ability to direct the forum efficiently. The system is also designed to automatically prevent more than four mics being active at

### *Gonzales Convention Center, USA*

Soundweb Processors were selected to outfit the Gonzales Convention Center expansion in San Antonio, Texas. Over seventy 9088/9000 DSP processors and an additional eighty 9010 'Jellyfish' remote controls are in use. The Soundweb Network is used to transport audio signals originating from the main A/V room, such as background music, paging and audio for video, to the various rooms throughout the convention center.

The recent Gonzales expansion consists of three exhibit halls, which can be combined or divided, one large banquet/meeting/performance hall, pre-function area and 26 meeting rooms. Additional rooms have also been constructed.

Conference room mixing and combining is done utilising the Gain-sharing automixer algorithm and matrix mixing between rooms. Soundweb processing was chosen for the versatility the network provides as well as the plethora of control options available for each room. In addition, the Soundweb system is expandable, making the next two phases of expansion just as easy.

Richard Bertrand of ASC says of the Soundweb system, "It's amazing! With simple CAT 5 networking, we are able to eliminate miles of analogue multi pair wire. Control is seamless. When you operate a remote control to bring up the background music, you forget you are operating a device over a half mile away! The digital delivery of audio via the Soundweb network saved the client hundred of thousands of dollars and resulted in vastly improved quality. It was the only solution available for this venue to work."

The design features an elaborate three stage paging override in the design to allow for local, wide area or emergency override paging. Design and installation was supervised by ASC Company of Dallas, Texas.



**BOARDROOMS &  
CONFERENCE  
CENTRES**



## System Design and Soundweb Designer

Systems are designed around three basic hardware devices: The 9088iis DSP unit with 8 analogue inputs and outputs, the 9008iis output expander with 8 analogue outputs, and the 9000iis network hub. Each of these devices contains its own DSP power that can be programmed the way you want.



Another device, the 3088 Soundweb Lite, has all the functionality of a 9088iis, but with no networking capability. For simple 8x8 systems, the 3088 provides an elegant, lower-cost solution.

The system design software, Soundweb Designer, runs on a PC under Windows™ 95, 98, NT, 2000, or XP.

### Soundweb Designer

The main screen in Soundweb Designer is where the system layout begins. The Soundweb devices are simply added to this screen to produce the necessary input/output configuration, and hubs added where network demands mean more signals are fed around.

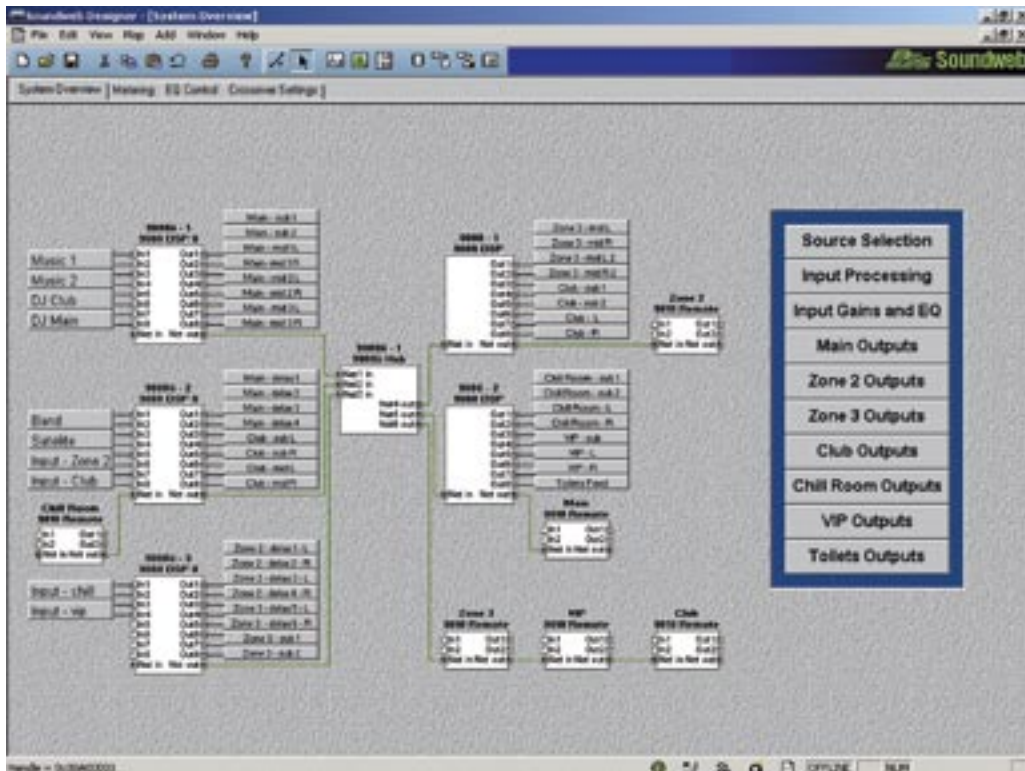

This overall system design can incorporate images of the installation, text boxes and equipment icons, so that a total representation of the complex is shown. Once your design is complete, you can export this as a Windows™ Metafile for inclusion in other documentation or CAD programs.

These 'Map' windows can contain system designs, or used to create custom control panels (see page 12). Custom control panels could be, for example, a set of meters for instant monitoring, or a set of EQ controls for each area. Navigating between multiple windows is because you can place linking buttons on each window, or use tabs on the top of each window.

Your finished design can then be exported as a 'shopping list' using the View Kit List function. This allows you to print a complete list of devices and network connections for inclusion in bid specifications.

## Designing your processing layout

To design your signal processing path, double-click on one of the DSP devices. Here you're presented with the input, output and network nodes, and a clear screen for you to design the processing you need. The layout of the processing is completely flexible. Processing objects are represented on the PC screen by boxes with connection points for their inputs and outputs; these are simply hooked up using a CAD-like interface, to produce any layout that may be desired. To add an object, simply drag its item from the palette list on the left.

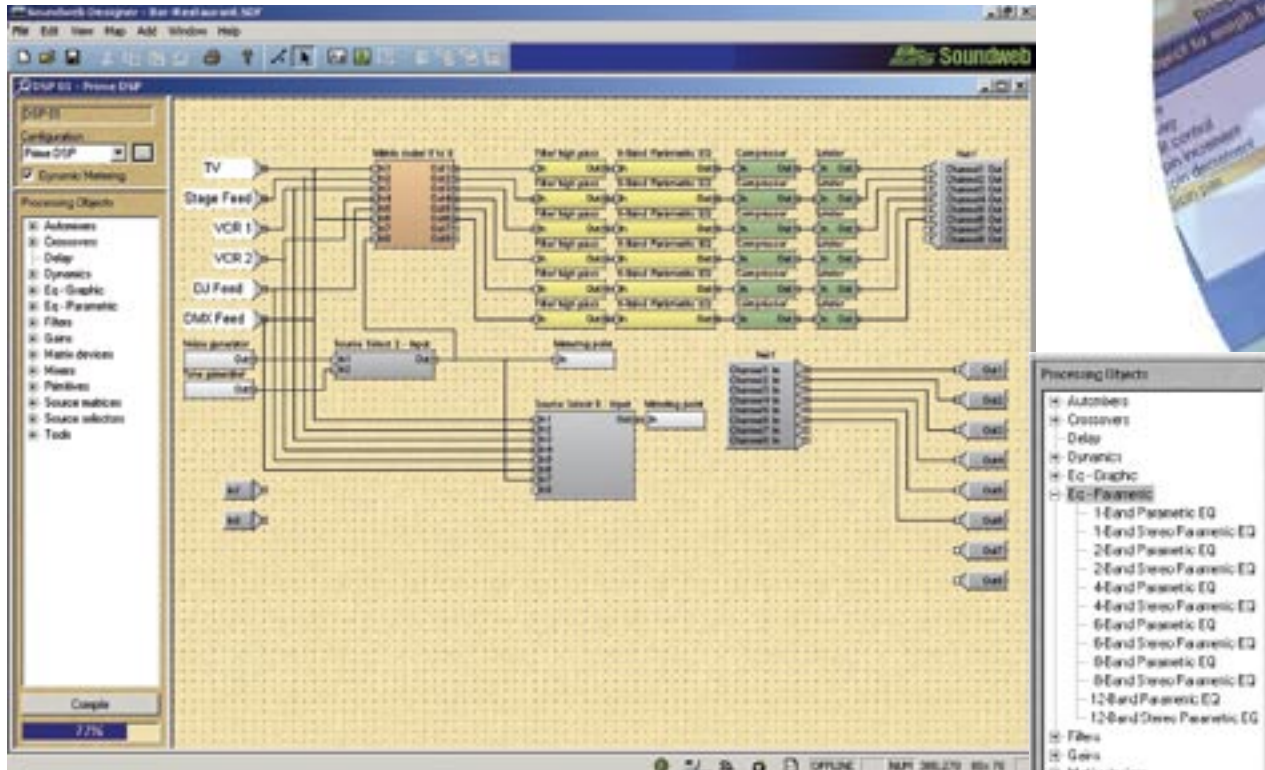

Simply interconnect the processing objects with the 'wire' mode, complete the design, and compile the DSP. You're ready to upload the design to a Soundweb device.

## DSP Power – how much can you have?

The amount of DSP power in a Soundweb device is 200MIPS (million instructions per second). The amount of power needed for processing the audio depends on the design complexity, but in real terms a single Soundweb 9088iis could for example, implement 14 channels of 12-band parametric EQ; or 8 channels with a compressor and gate in each; or a stereo 4-way crossover with limiters, delays and 12 bands of parametric EQ on each output and a stereo compressor on the input.

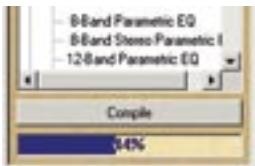

The configuration window includes a DSP resource meter that shows how much DSP processing capacity you are using in that device. You will normally find that you have more than enough capacity for quite complex systems. However, in a networked system, it is possible to utilize spare DSP in another device by sending a signal across the network and back after processing.

Once you have designed your DSP layout, it is saved as a CONFIGURATION. By starting a new configuration you can have a completely different set of DSP objects and routing as another design, and save that.

Each Soundweb device can store about 60 completely different DSP configurations in memory, which can be recalled simply either within the configuration window or as part of a system-wide PRESET (see page 12). This allows you to completely change a system's setup for a different event at the touch of a single button.



## Control panels

Soundweb Designer provides default control panels to allow the adjustment of each audio processing object, which are activated by double-clicking on the object when in the processing design window.

In addition to using these, you can build your own 'custom' control panels. The software allows a great deal of customisation of the panel layouts, including the use of colour or images as backgrounds, and control over the shape, size, colour and edge styles of particular control items such as faders or buttons. Some types of object can be 'morphed' into other types, such as a fader into a rotary pot or a pair of 'up/down' spin buttons.



## Control Options & Control Ports

Using the control inputs and logic outputs, it is possible to provide a custom hardware control panel for the facility. This can be built from readily available off the shelf components, and can be made to whatever cosmetic styling is required; an engraved brass plate for a hotel reception would be an example. We offer standard simple devices, such as the 9012 Wall Panel that combines a 5-way switch (source selector or preset switcher, for example) and a rotary fader (for level).



The logic outputs can be used to provide an indicator for any binary output function such as a gate open light, or to provide a tally for a switch.

## Cost-Effective Control of External Devices

Every Soundweb DSP unit has eight logic control output ports. That includes the 9088iis networked signal processor, the 9008iis networked output expander, the 900iis active network hub and the newer, lower cost non-networked 3088 Soundweb Lite.

Using low-cost, third party logic converters, these output control ports can provide the following functions:

- Infrared Control
- High Current relay
- Latching Relay
- Momentary Relay
- MIDI Control
- Serial Control

The bottom line? You can successfully convert to the superior Soundweb DSP and control platform when all of the following conditions are present:

- An advanced, "control any device" automation system is specified.
- Lower priced, lower performing audio DSP has been specified, or is being considered, to replace Soundweb due to "value engineering".
- The list of external control commands required fits the total number of output control ports if Soundweb were to be specified.
- Complex functionality is not required, i.e. sophisticated feedback from external devices, video streaming in a window on a touch screen, etc.

Depending on which Soundweb control device is chosen (and what is being replaced), these conversions should result in significant savings compared to using the most commonly specified control/automation systems.

## Presets – full system changes or just parameters

Soundweb Designer allows you to specify 'presets'; these are complete records of the state of your system that can be stored or recalled as necessary. 'Parameter presets' are a variation on this that allow you to store and recall the state of a particular group of parameters, without affecting the whole system.

Most commonly, presets are used to recall different sets of parameter adjustments. However, they can do more than this. If a preset being recalled requires a different dsp 'configuration' from the currently active layout within a Soundweb device, the unit will mute its outputs and reload the DSP with the appropriate program before continuing. Each Soundweb unit can store up to 60 totally different DSP layouts or configurations.



## Password Protection for security

Soundweb Designer allows you to specify multi-level password protection for your system. You can define different users, assign security levels to each user, and then dictate that certain features of the system require a particular security level in order to allow them to be operated. You can also specify that a particular user should be forced into a particular control panel at start-up, thus ensuring that personnel get just the control screens that you have in mind for them.



## Macros

Macros allow you to group together frequently used collections of processing objects, complete with their usual settings. Once defined, a macro looks to the user exactly like any other processing object.

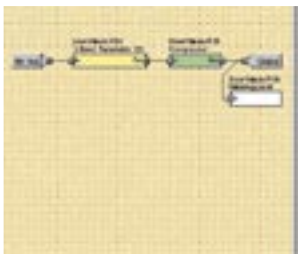

Macros can be used as a way of protecting a consultant's intellectual property. Details of the macro definition are not available to the end user, who only sees the form of the macro, i.e. its inputs and outputs, and the parameters that are available for adjustment.

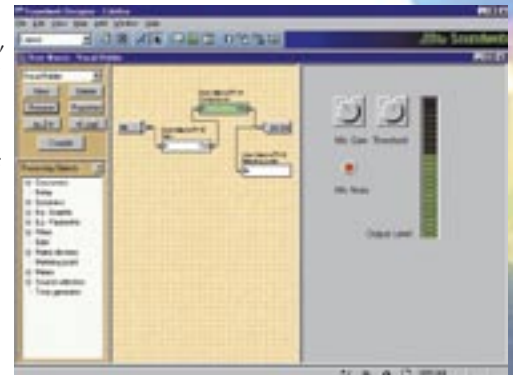

## Serial Control

The serial port connector on the back of a Soundweb device can be used to interface to an external control system. Currently devices supported include AMX, Crestron, Dataton and Avenger.

Requirements differ for interfacing to these systems. For an AMX system, the user exports a header file suitable for inclusion with the AMX program (BSS provide a suitable library file to support the AXCESS compiler). With Crestron systems, the user edits the Crestron control data to map the control icons to the Soundweb elements. Similarly, other systems can use the RS-232 control strings to access Soundweb parameters.



## Watching for problems

System performance can be monitored using Soundweb's Event Logging system. Events that can be allocated to be recorded include failures, warnings and information notices. The time of the event occurrence, the device to which the event applies and the design file originally loaded are all displayed. An auto backup facility ensures that the logs generated by larger systems remain manageable.





## SW9088iis Networked Signal Processor

The Soundweb 9088iis DSP unit is the heart of the Soundweb system. As a standalone single rack space device it has all the facilities required for a sound system processor - 8 inputs, 8 outputs, a DSP engine, networking for connection and signal distribution to other soundweb units, Analogue GPI control interfacing, and RS232 ports for external control by PC or AMX/Crestron type systems. Plug in an audio source, an amplifier, and speakers and you are away.

- ❑ 8 Analogue Mic/Line Inputs and 8 Analogue Outputs.
- ❑ Optional AES/EBU digital input/output (2 x stereo) cards with external word clock input.
- ❑ 200MIPS of DSP resource.
- ❑ Integral multi-voltage PSU, (85V - 270V AC).
- ❑ Analogue control ports for GPI hardware interfacing; eg faders, switches & LEDs.
- ❑ Front and rear access RS232 ports for PC control.
- ❑ Integral memory holds up to 60 DSP system designs, depending on complexity.
- ❑ Optional cable lacing bar.



All the facilities are included in a 9088iis, there is no additional Soundweb system hardware required to begin building physical systems. The only option decision to make is a choice of line input, mic/line input cards or AES/EBU Digital input/output cards. Each analogue card handles four inputs and each input can be switched individually, together with phantom power and phase reversal. Each digital card accepts 2 stereo inputs at sample rates from 32kHz to 96kHz, and has two stereo digital outputs at selectable rates of 44.1, 48, 88.2, and 96kHz. When digital inputs are used, the analogue outputs remain in use as a mirror version of the digital output.



I/O connections are made via 'Phoenix' style two-part screw terminals; the female connectors are shipped with the Soundweb unit, so installation can be made with no soldering and no extra connectors to buy.

Each Soundweb 9088iis can typically hold up to 60 completely different system designs in its own memory. Programming the unit is accomplished via the Soundweb Designer software, available free of charge from BSS Audio ([www.bss.co.uk](http://www.bss.co.uk)).

Front and rear RS232 ports are provided for programming, firmware upgrade access and for connection to control systems such as AMX, Crestron or similar.

For safety-critical systems, the Soundweb 9088iis has an opto-isolated output which functions as a watchdog: the opto-isolator conducts when power is applied to the unit and the software is functioning correctly; it is cut off if there has been a power failure or other fault. This function can be used to trigger alarm systems or to construct redundant systems.

## Soundweb lite 3088 Signal Processor

For simple standalone 8x8 DSP processing, the Soundweb Lite 3088 draws on the phenomenal success of the larger networked Soundweb 9088iis and associated products, but provides a less-expensive alternative for situations where the design requires a maximum of 8 inputs and 8 outputs. There are no network facilities on the 3088, hence the lower price.

This device will fulfil many applications such as small houses of worship, theme bars, boardrooms and clubs.



- ❑ 8 Analogue Mic/Line Inputs and 8 Analogue Outputs.
- ❑ Optional AES/EBU digital input/output (2 x stereo) cards with external word clock input.
- ❑ 200MIPS of DSP resource.
- ❑ Integral multi-voltage PSU, (85V - 270V AC).
- ❑ Analogue control ports for GPI hardware interfacing; eg faders, switches & LEDs.
- ❑ Front and rear access RS232 ports for PC control.
- ❑ Integral memory holds up to 60 DSP system designs.
- ❑ Optional cable lacing bar.

The 3088 has all the capabilities of the networked version — totally free-design DSP layout, a large palette of processing objects, custom control panels etc, and runs under the common Soundweb Designer platform. This means that Consultants and Contractors who are familiar with Soundweb already will be able to incorporate designs using the 3088 immediately.

Control options for the 3088 are similar to the 9088iis, with PC control (custom control panels), simple control from the 9012 and 9015 wall panels and control ports, or serial control from AMX, Crestron and other serial-based control systems. However, as there is no network, the 9010 controller cannot be used with the 3088.

All standard input configuration options are available for the 3088, including mic, line and AES/EBU digital I/O. The 3088 will also integrate with the 9016 Video/Audio and 9026 Audio switchers.

## Soundweb 9008iis Output Expander/Processor

The 9008iis hardware device is an expansion unit for Soundweb systems where more outputs are needed, but input sources are already covered using 9088iis. The 9008iis is almost identical to the 9088iis, and delivers the same DSP and control capabilities, but lacks any input circuitry. By dispensing with the input cards, and associated sockets the 9008iis is cost effective in situations where extra inputs are unnecessary.



- ❑ 8 Analogue Outputs only, no input capability except via network.
- ❑ 200MIPS of DSP resource.
- ❑ Integral multi-voltage PSU, (85V - 270V AC).
- ❑ Analogue control ports for GPI hardware interfacing; eg faders, switches & LEDs.
- ❑ Front and rear access RS232 ports for PC control.
- ❑ Integral memory holds up to 60 DSP system designs.
- ❑ Optional cable lacing bar.

The unit is envisaged to be especially useful providing additional outputs for larger systems where each additional 9008iis can route and process up to 8 channels of audio to its balanced outputs. Also with its built in networking capabilities the 9008iis can communicate with all the other Soundweb devices on the network.

# SW9000iis Network Hub

The Soundweb 9000iis Network hub is used to expand the routing capabilities of the Soundweb system. It has all the processing facilities of the 9088iis DSP unit; 200MIPS of DSP horsepower, analogue GPI control interfacing, and RS232 ports for external control by PC or AMX/Crestron type systems; but has 6 network ports instead of analogue inputs and outputs.



Like the 9088iis, each 9000iis can hold up to 60 completely different system designs in its own memory. The DSP in a 9000iis hub is most often used for matrixing, mixing, and routing the signals from 9088iis devices, which are then free for signal processing.

The 9000iis Hub occupies just a single rack space (1U) and includes its own power supply. Programming the unit is also accomplished via the Soundweb Designer software.

The 9000iis can be used to extend the matrixing and signal routing capabilities of a Soundweb System Network, and large systems can be constructed using one or more 9000iis hubs to interface with 9088iis devices.

- ❑ 6 Network ports.
- ❑ 200MIPS of DSP resource with all the DSP processing objects of the 9088iis.
- ❑ Integral PSU.
- ❑ Control ports for analogue GPI hardware interfacing.
- ❑ Front and rear access RS232 ports for PC control.
- ❑ Integral memory holds up to 60 DSP system designs.

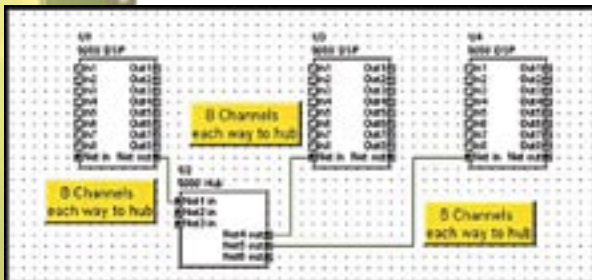

As an example, a single 9000iis hub linked to three 9088iis devices can produce a fully matrixed 24 x 24 system.

Hubs can also be connected to each other to form large signal busses. Again, as an example, a 24-way bus could be designed quite easily.

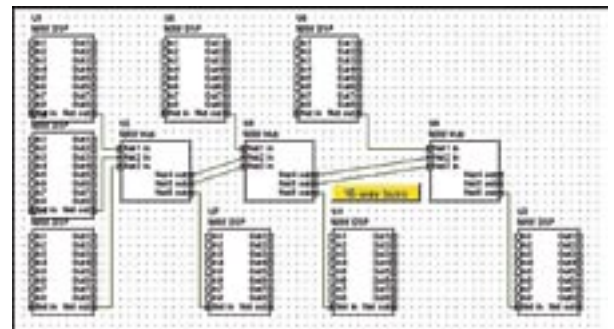

For safety-critical systems, the Soundweb 9000iis has an opto-isolated output which functions as a watchdog: the opto-isolator conducts when power is applied to the unit and the software is functioning correctly; it is cut off if there has been a power failure or another fault.

This function can be used to trigger alarm systems or to construct redundant systems.

## Dual Redundant Ring System

Using Soundweb 9000iis hubs, it is possible to create a dual-redundant ring, where two network cables carry audio and control around a ring in both directions, so that if one cable is accidentally damaged, the other intelligently routes the signals to continue full operation. (see page 5).



## SW9016 Video/Audio Switcher

## SW9026 Audio Switcher

The SW9016 and SW9026 Matrix Switchers allow video and audio sources to be routed by Soundweb Designer presets or simple remote control.

The SW9016 Video/Audio Matrix Switcher features 8 video source inputs (NTSC or PAL) on BNC connections, along with 16 balanced audio inputs which allow easy input expansion for Soundweb audio inputs. Four video output zones are fed from BNC connectors with 8 balanced audio outputs.



The SW9026 Audio Matrix Switcher features 16 balanced audio inputs, and 8 balanced outputs which can then feed a Soundweb 9088iis for processing and further zone distribution.



Integrating Soundweb Audio Processing and Networking with these switchers provides a unique and totally integrated multimedia processing system for Theme Bars, Restaurants, Clubs, Home Theatre Systems, Videoconferencing, Corporate Boardrooms, Classrooms and other environments where there may be several areas, each requiring its own video/audio feed possibilities. In these systems, the theme is very much 'video follows audio' in that the video feeds are switched when the audio sources are re-routed according to event need, with the ability to break audio and video sources. This means, for example, that a zone could have Sport video with radio audio playing.

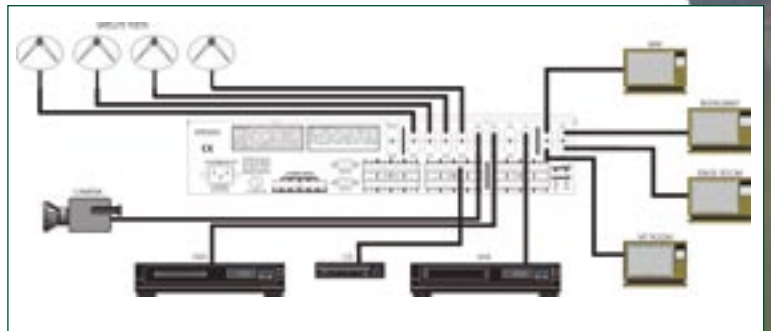

- SW9016 - 8 Video input sources and 16 audio inputs matrixable to 4 video outputs and 8 balanced audio outputs, either audio follows-video or independently, with audio output level controls.
- SW9026 - 16 audio inputs matrixable to 8 balanced audio outputs, with audio output level controls.
- Controlled via Soundweb Designer or 9010/9012 controller presets, or a standalone PC application, MatrixMate.
- Simple control via simple switches.
- Two units may be cascaded to increase capacity.

There are many instances where only a number of signals from multiple sources are required simultaneously, and the SW9026 permits low-cost input expansion for Soundweb systems, as well as offering a standalone solution for source selection and matrixing.

In addition to seamless integration within Soundweb systems, the SW9016 and SW9026 switchers are equally suited to stand alone operation. When used in this way they can be used as simple routing switches or alternatively loaded with up to eight pre-sets that allow any combination of audio/video routing and audio level to be instantly recalled in up to four independent zones. If no pre-sets are loaded, the units automatically default to a simple four zone source selector with 'audio follows video' routing, audio level control being independent for each zone.

Control can be remote via RS232 using simple string commands, or local from a contact closure port, for example using up to four 9012 panels.

BSS Audio supplies a standalone PC program, MatrixMate, that can be used to both set-up and control the devices when they are not part of a Soundweb system.

# SW9010 'Jellyfish' Programmable Remote Controller

The Soundweb 9010 Remote control is the long awaited solution to the problem of providing a sophisticated system control interface that requires no technical knowledge to operate.

The 9010 extends the already outstanding flexibility of the Soundweb system by providing multi-purpose programmable remote control. The 9010 has a rotary encoder and 6 push buttons which are labelled by a graphic LCD display.

The encoder and each button can be used to adjust almost any processing parameter within a Soundweb network: the user sets up the functions in the Soundweb Designer software. Multiple "control pages" can be constructed with navigation between them and password protection; a button can have a different function in each page.



- ❑ Backlit graphic liquid crystal display with programmable layout.
- ❑ One programmable continuous rotary encoder to adjust parameters.
- ❑ Six programmable pushbuttons.
- ❑ Internal electret capsule microphone with computer-controlled gain.
- ❑ External dynamic microphone input with computer-controlled gain.
- ❑ Two channel audio output.
- ❑ Available in green or beige finish.



## Mechanical Installation

The 9010 Remote is designed to fit into a standard US 3-gang wallbox (available from BSS Audio) using the screws provided with the unit. We also offer a decorative bezel that fits around the 9010 when mounted in this box.

In addition to its control facilities, the 9010 provides an internal capsule microphone, an external microphone input, and two channels of audio output. With suitable external amplification and loudspeakers, these audio outputs can be used for local monitoring of network signals or local communications.

The 9010 connects into the Soundweb network using RJ-45 connectors and CAT 5 cable, just like any other Soundweb device. The 9010 is powered from a standard 24V DC power supply; BSS can provide a suitable supply capable of powering four 9010s. The optional 9011 adapter allows the power to be sent to a daisy chain of 9010's down the network cable.

## Programming the 9010

To program the 9010, the 'Button Setup' function within Soundweb Designer opens a design window, which allows the user to decide the functions of each button and the encoder, whether it is to adjust parameters, trigger presets or change menu pages. The 9010 can control virtually any parameter of any Soundweb DSP device on the network.

To assign a button to a fader to control gain, for example, it is simply a matter of opening the fader control panel (in design mode) and dragging the fader onto the desired button. The button adds default text which may be changed with the text tool. When the button is pressed on the actual remote, the encoder will then control that fader.

Parameter controls, presets and parameter presets can all be placed onto buttons. Buttons can also be used to address new menu pages, by first creating a new page, then programming a button to access that page. These pages can be password protected for security. In this way, some functions can be left for general facility staff to operate, while other functions are secured for technician's use.



Programming can be totally checked off-line on the PC with the powerful 'simulate' mode.



## SW9012 Wall Panel



The Soundweb 9012 Wall Panel is a simple hardware interface to the Soundweb Programmable DSP system. It provides a quick and easy way for designers to provide a rotary fader control and source select (or other multiway switch function) in a standard UK-sized light switch panel mounting.

- ❑ Rotary fader for Volume control etc.
- ❑ 5-way rotary switch for source select etc.
- ❑ Standard UK light-switch fitting mounting size, in green.
- ❑ Available in USA single gang switch fitting in beige.



Using Soundweb Designer to 'map' functions onto the Soundweb device control ports, these hardware controls can then be used to provide local control of, for example, volume, source select, or parameter presets.

Connection is via the Soundweb standard Phoenix/Combicon removable screw terminal connectors. Three terminals are used for common, switch output and fader output.

The switch has blank ident areas for marking the switch positions, either directly onto the white area or on self-adhesive labels. A set of 'standard' labels in four languages (English, French, German & Spanish) are supplied with the 9012 which should cover most locational requirements.

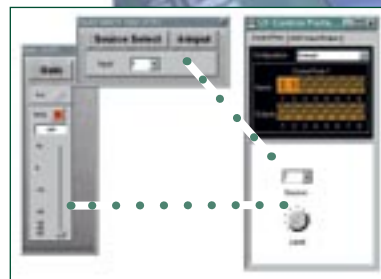

## SW9015 Wall Panel

The SW9015 Wall Panel is similar to the SW9012, except that the rotary eight settings and the rotary level control is replaced by up and down buttons. (Green) or USA (Beige) single gang switch fittings.



switch allows  
Available in UK

## SW9014 Fibre Interface

### Fibre for long distance

The 9014 Fibre Interface has been designed to extend the networking capabilities of the Soundweb system. Using the 9014 Fibre System, the distance between Soundweb devices can be increased to 2km/1.2 miles.

A pair of 9014 Fibre Interface units is used to replace a standard CAT 5 Soundweb network cable. Each fibre cable will transfer 8 channels of digital audio plus control data.

To utilise the fibre system, each end of the fibre link requires one 9014 device. Each device is equipped with an RJ-45 Soundweb network cable jack into which the network cable is connected, and two snap-in SC type fibre connectors. Two fibre cables are then required to connect between 9014 devices — this is to enable the bi-directional audio transfer.

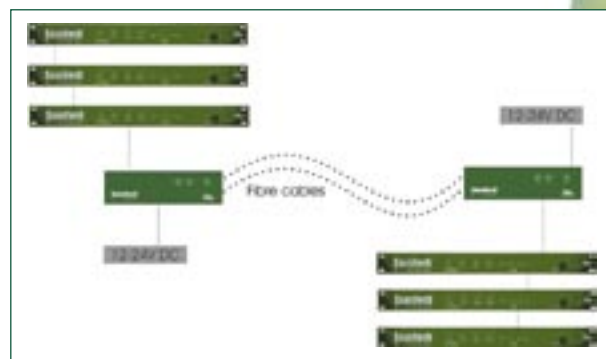

Each 9014 device requires a DC supply of 12V to 24V DC (BSS part Z-999-PSU). This PSU is capable of powering eight 9014 Fibre Interface modules. Power can be shared with the 9010 Remote Control, but not via the network cable.

### Fibre for noise immunity

The added advantage of using a fibre system is that fibre itself is totally immune to outside noise and interference, so your audio signals remain pristine from end to end.

### Multiple 9014 Interfaces

A mounting panel is available so that up to three 9014 devices may be installed in a single rack space.





## Soundweb 9088iis, 9008iis, 3088 and 9000iis devices

DSP capability 200MIPS (Million Instructions Per Second)

### Input Section (9088iis, 3088)

8 Analogue, electronically balanced, on Phoenix/Combicon removable screw connectors.  
Line Inputs: Nominal gain 0dB, electronically switchable to +12dB gain, input impedance 10kOhm  
Mic/Line Inputs: Nominal gain 0dB, electronically switchable up to +72dB, in +6dB steps, input impedance 3.5kOhm  
Maximum input level: +20dBu with 0dB input gain (+8dBu with 12dB gain)  
CMRR: >75dB at 1KHz  
Equivalent Input Noise: <-128dBu typ with 150 Ohms source (EIN)  
Phantom power: 48V nominal, selectable per input

### Digital Input/Output option (9088iis, 3088)

2 x 2-channel inputs and 2 x 2-channel outputs per card, on Phoenix/Combicon removable screw connectors. Corresponding Analogue outputs remain live and in parallel with Digital outputs.  
Interface standard: AES/EBU  
Digital resolution: 24bit  
Supported input sampling rates: 32-96kHz  
Supported output sampling rates: 44.1, 48, 88.2, 96kHz (independent for each output)  
Output clock source: Internal, Inputs 1 & 2, External Word Clock or System Clock (48kHz)  
Input clock source: Independent or System Clock

### Output Section (9088iis, 9008iis, 3088)

Maximum output level: +20 dBu  
Frequency response ( $\pm 0.5$  dB): 15 Hz to 20 kHz ( $\pm 0.5$ dB)  
Total Harmonic Distortion (THD): <0.01% (20Hz to 0kHz, +10dBu output)  
Dynamic range: 105 dB typical (22 Hz to 22 kHz unweighted)  
108dB typical (A-weighted)  
Inter-channel crosstalk: <-75 dB

## SW9016/9026 — Video/Audio Switcher and Audio Switcher

Video Inputs (SW9016): 8 Composite Video inputs (CBVS or SVideo) on BNC connectors with BNC loophrough connectors  
Video Standard: PAL or NTSC (auto selected)  
Video Bandwidth: 150Mhz  
Video Crosstalk: <70dB up to 10MHz  
Sync: Automatically either Channel 1 or 'Sync' input  
Impedance: 75 Ohm self-terminating  
Routing: 8x4 Video Matrix  
Video outputs: 4 x 75Ohm Composite Video Outputs on BNC connectors  
Audio Inputs (SW9016/SW9026): 16 Balanced Audio inputs on Phoenix/Combicon removable screw connectors.  
Routing: 16x8 Audio Matrix, each channel independently addressable  
Input Impedance: 10kOhm  
Maximum Input Level: +20dBu  
THD: <0.02%

### Control Ports (All devices)

Control input voltage: 0 to 4.5v  
Control input impedance (2 wire): 4.7kOhms to +5V  
Control input impedance (3 wire): >1mOhm  
Logic output voltage: 0 or +5v unloaded  
Logic output impedance: 440 Ohms  
Opto. output current: 14mA max  
Opto. output withstanding voltage: 80V max  
Opto. output series impedance: 220 Ohms (isolated)

### Network (9000iis, 9088iis, 9008iis)

Maximum network cable length: 300m/1000ft between any two devices

### Power & Dimensions (9000iis, 9088iis, 9008iis, 3088)

Mains supply: Integral multi-voltage switching PSU, 85-270V AC, 50/60Hz  
Power consumption: <35VA  
Dimensions (h (U) x w x d): 1.75" (1U) x 19" x 11.3" (45mm x 483mm x 287mm)  
Weight: 6.6lbs (3kgs)

### Soundweb 9010 Programmable Controller

Mic Input: 18 Bit A/D Conversion  
External Input Specifications  
Dynamic Range: 81dB (22Hz to 22kHz unweighted)  
Gain Control Range: 34dB to 72.5dB  
Max Input Level: -17dBu  
EIN: -106dBu @ 150 Ohm  
Audio Output: 18 Bit D/A Conversion  
Dynamic Range: >88dB (22Hz to 22kHz unweighted)  
Frequency Response: 30Hz to 20kHz, +0/-0.5dB  
THD: <0.05% (20Hz-20kHz, 0dBu)  
Max Output Level: +4dBu  
Channel Separation: 80dB, 20Hz-20kHz  
Power Requirements: +24V DC, <5VA

Frequency Response: 20Hz-20kHz +0/-0.2dB  
S/N Ratio: >110dB at unity gain  
Crosstalk: <-100dB  
CMRR: >40dB  
Audio Outputs: 8 Balanced Audio Outputs on Phoenix/Combicon removable screw connectors.  
Output gain: adjustable, -inf to +20dB

### Control & Presets

Presets: 8 presets per video output zone when used with standalone PC app  
Serial Control Port: RS232 connects to Soundweb 9088iis,9008iis 3088, 9000iis or PC

### Dimensions (h (U) x w x d):

SW9016: 3.5" (2U) x 19" x 6.6" (89mm x 445mm x 168mm)  
SW9026: 1.75" (1U) x 19" x 6.6" (44.5mm x 445mm x 168mm)  
Weight SW9016: 3kgs (6.6lbs)  
SW9026: 2.3kgs (5.3lbs)

## SW9014 — Fibre Interface

Power  
DC Supply: 12-24V DC, <5VA Connector: Phoenix screw terminal or 2.4mm inline barrel connector  
Network: Single RJ-45 Can be input node or output node - auto-sensed (no setup required)  
Fibre Connections: Snap-in SC fibre input, Snap-in SC fibre output  
Fibre cable: Multimode 62.5/125um, or Multimode 50/125um  
Optical Power Budget: 10dB  
Indicators: Power led, Fibre Link Active led, Network cable present led  
Max fibre length: 2,000 metres/6,550 feet/1.2 miles  
Dimensions (h x w x d): 1.4" x 5.3" x 5.5" (36mm x 135mm x 139mm)

Three 9014 devices can be mounted side-by-side in a 1U panel (available from BSS Audio). The panel can be used to rackmount a single or two 9014 devices if required, and can be fitted with the Z-999-PSU in this case.

BSS Audio offer a universal AC input +24V DC power supply (Z-999-PSU) for the 9010 and 9014 devices and an interface adapter for the 9010(Z-SW9011). The PSU may connect directly to an SW9010, or connect via the Interface adapter where power will be supplied via the network.

BSS Audio reserves the right to change product designs and specifications without notice in the interest of product development. E&OE  
This product is designed and produced by BSS Audio, England  
All trademarks acknowledged. All use of client photographs and images within this publication is gratefully acknowledged.

## BSS Audio

A Division of Harman International Industries Ltd.  
Cranborne House, Cranborne Road, Potters Bar, Herts,  
England EN6 3JN  
Tel: +44 (0)1707 660667 Fax: +44 (0)1707 660755  
e-mail: info@bss.co.uk www.bss.co.uk

## BSS Audio USA

The Harman Music Group  
8760 S. Sandy Parkway, Sandy, Utah 84070, USA  
Telephone: 801-566-8800 • Fax: 801-566-7662  
web: www.bssaudio.com  
e-mail: BSSAudioUSA@harman.com

