

**ÖLEVIA**

**User's Manual**

**LCD TV**

**HDTV**

**5-Series**

**ÖLEVIA**

Syntax-Brilliant Corporation  
20480 East Business Parkway  
City of Industry, California 91789 USA  
1-866-9-OLEVIA



# Table of Contents

<b>Important Information</b> .....	1
<b>Important Safety Precautions</b> .....	2
<b>Introducing the Syntax-Brilliant OLEVIA TV</b> .....	5
<b>Accessories</b> .....	7
<b>TV Installation And Connection Guide</b> .....	
Identifying Front Controls and Rear Panels .....	8
- Descriptions of Connector Types .....	10
- Connecting the Power Cord .....	11
Installation .....	12
- Connecting to an Antenna or Video Equipment with Antenna Outlet .....	13
- Connecting to a Set-Top-Box with HDMI Cables .....	14
- Connecting to a Satellite Receiver or Cable Box with Component Connectors .....	15
- Connecting to a DVD Player with A/V or S Video Cables .....	16
- Connecting to a DVD Player with Component Cables .....	17
- Connecting to a DVD Player with HDMI Cables .....	18
- Connecting to a Satellite Receiver or Cable Box with A/V Cables .....	19
- Connecting to a VCR, PVR, or DV with A/V Cables .....	20
- Connecting to a Blue-Ray DVD Player or HD-Receiver with HDMI Cables and a PC with VGA Cables .....	21
- Connecting to a D-VHS with HDMI Cables .....	22
- Connecting to a D-VHS with Component Cables .....	23
- Connecting to an Audio Receiver .....	24
- Connecting to a Home Theater System or Earphone Set .....	25
- Instruction for Uploading New Firmware .....	26
<b>Remote Control Guide</b> .....	
Remote Function Keys & Description .....	27
Programming the Remote Control .....	28
Battery Installation .....	29
<b>On Screen Display (OSD)</b> .....	30
Introduction .....	30
Operating in the OSD .....	30
<b>PICTURE OSD</b> Adjusting TV Picture Settings .....	31
- Description of Settings .....	31
- Initial Screen .....	31
- Selecting the Picture Mode .....	32
- Adjusting the Picture Quality .....	33
<b>AUDIO OSD</b> Adjusting Sound Quality .....	35
- Description of Settings .....	35
- Adjusting the Audio Settings .....	35
- MTS System for Stereo TV .....	36
<b>SCREEN OSD</b> Adjusting Screen Modes .....	37
- Description of Settings .....	37
- Changing the Screen Mode .....	37
- Selecting the Picture/Video Source .....	40
<b>SETUP OSD</b> Adjusting Personal TV Settings .....	41
- Description of Settings .....	41
- Searching the TV Channels .....	42
- Editing Channels .....	43
- Closed Caption Options .....	47
- Setting up Parental Control Password .....	48
- Activating the Parental Control Feature .....	48
- Resetting the Password .....	54
- Setting the Date and Time .....	55
- Setting the TV Timer .....	56
- Timeout Settings for OSD Menu .....	56
- TV OSD Languages .....	57
- Setting DPMS .....	57
- Factory Default Option .....	57
- Displaying the Firmware Version .....	57
<b>Specifications</b> .....	58
<b>Timing Mode for VGA and DVI</b> .....	60
<b>Pixels Policy</b> .....	61
<b>Glossary</b> .....	62
<b>Code Number Lists for Remote Control</b> .....	66



# Important Information



**Caution**  
Risk of electronic shock  
Do not open



To reduce the risk of electronic shock, do not remove cover (or back).  
No user-serviceable parts inside.  
Refer service to qualified Repair Technician or Repair Center.



Read the following context indicated by the following symbol to the left. It indicates important literature in operating the product.



Read the following context indicated by the following symbol to the left. It indicates a potential high voltage hazard that may compromise your safety.



## Caution

Take caution when moving the product on a cart. Quick stops, excessive force, and uneven surfaces may cause the display unit and cart combination to overturn.

## Caution

To prevent electric shock, match wide blade of plug to wide slot, fully insert.

## Caution

This product satisfies FCC regulations when shielded cables and connectors are used to connect the unit to other equipment. Prevent electromagnetic interference from electrical appliances such as radios and televisions. Please use shielded cables and connectors for connections.

## Warning

FCC Regulations state that any unauthorized changes or modifications to this equipment not expressly approved by the manufacturer could void the user's authority to operate this equipment.

# Important Safety Precautions

## Cleaning

Remember to unplug the AC cord from the AC outlet before cleaning the display unit.

Then spray small amount original WINDEX window clearer (blue stuff), not Ammonia-added clearer, on cloth to clean the display.

Remember to use only soft cotton cloth such as an old 100% cotton T-shirt, not sponges brillo abrasive material, to clean the display.

No drips allowed.

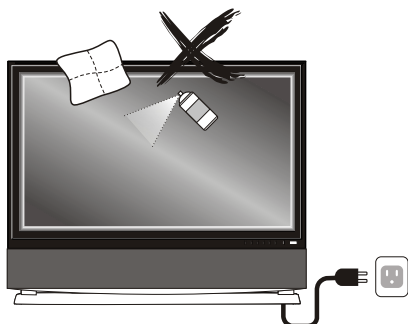

## Stand

Do not place the display unit on an unstable place.

The TV may fall resulting in serious personal injuries to nearby people as well as damage to the display unit.



## Ventilation

Do not cover or block these vents and openings located on the top and back of the display. Inadequate ventilation may cause overheating and shorten the lifespan of the display.

Do not place in an enclosed area such as a built-in shelf, unless proper ventilation is provided or the manufacturer's instructions are followed. Keep the distance of 10cm minimum between the display unit and wall. Never install the display unit as indicated in the picture below.

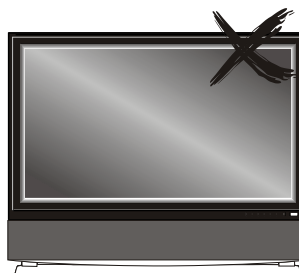

Air circulation is blocked

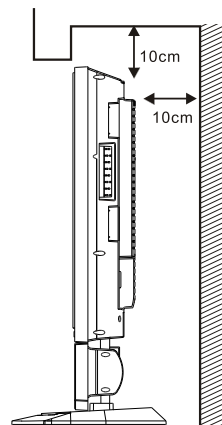

Air circulation is blocked

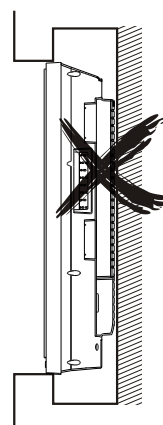

## Never insert objects or spill liquid into the display unit

Never insert any object into the display unit through openings or spill liquid on the display unit. High voltage flows in the display unit, and inserting an object can cause electric shock and/or short internal parts.



## Keep away from water and moisture

Do not place the display in areas where moisture is present or where the unit may get wet such as bathrooms, kitchen, pool area or in a wet basement.

## Keep away from heat sources

Keep the display unit away from heat sources such as radiators, heaters, stoves and other heat-generating products.

## The liquid crystal panel used in this product is made of glass

Do not hit the panel. Be careful to prevent from getting hurt by broken glass pieces in case the panel breaks.

## Follow operating instructions

All operating instructions must be followed.

## Servicing

Do not attempt to service the display unit yourself. Removing covers expose you to high voltage and other dangerous conditions. Request a qualified service technician to perform the service.

## Precautions when transporting the display

Carrying the display requires two or more people.

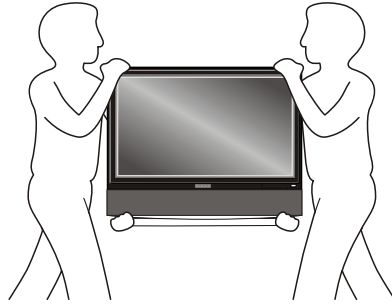

## Attachments

Do not use attachments not recommended by the manufacturer. Use of inadequate attachments may result in accidents to nearby people or to the unit.

## Power source

This product must operate on a power source specified on the specification label. If you are not sure of the type of power supply used in your home, consult your dealer or local power company. For units designed to operate on batteries or another power source, refer to the operating instructions.

## AC cord protection

The AC cords must be routed properly to prevent people from stepping on them or objects from resting on them. Check the cords at the plugs and product.

## Wall mounting

Be sure to install the display unit according to the method recommended by the manufacturer. Use only the mounting hardware recommended by the manufacturer.

## Overloading

Do not overload AC outlets or extension cords. It may result in electric shock or start a fire.

## Replacement parts

In case the display unit needs replacement parts, make sure that the service technician uses replacement parts specified by the manufacturer, or those with the same characteristics and performance as the original parts. Use of unauthorized parts can result in fire, electric shock and/or other danger.

## Safety checks

Upon completion of service or maintenance, request the service technician to perform safety checks to ensure that the display unit is in proper operating condition.

## Repair

When the display unit displays an abnormal condition, any noticeable abnormality in the display unit indicates that the display unit needs servicing. If any of the following conditions occurs, unplug the AC cord from the AC outlet, and request a qualified service person to perform repairs.

1. A liquid was spilled on the display unit or objects have fallen into the display unit.
2. The display unit has been exposed to rain or water.
3. The display unit has been dropped or damaged.

## Environment

The display unit only operates within the temperature 0°C to 40°C. Operation outside of the recommended may cause damage to your product.

### Warning



When installing or realigning an outside antenna system, extreme care should be taken to keep from touching such power lines or circuits. Contact with them could be fatal.

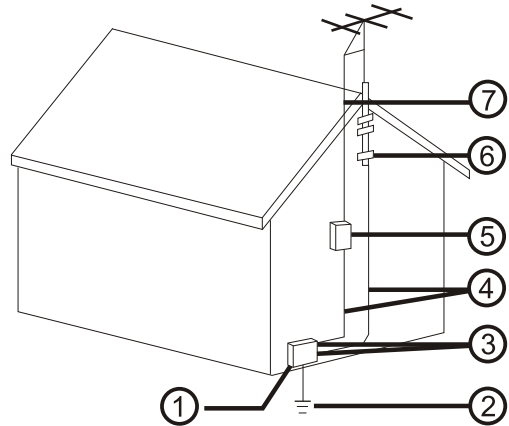

Antenna and satellite grounding

Reference	Grounding component
1	Electric service equipment
2	Power service grounding electrode system (NEC Art 250. Part H)
3	Ground clamps
4	Grounding conductors (NEC Section 810-21)
5	Antenna discharge unit (NEC Section 810-20)
6	Grounding clamp
7	Antenna lead-in wire

# Introducing the Syntax-Brilliant™ OLEVIA TV

## Welcome!

Thank you for purchasing a Syntax-Brilliant™ OLEVIA LCD HDTV. This manual is to be used with the following model:

### OLEVIA 5 Series

This manual is designed to help you through setting up and operating your LCD HDTV as quickly as possible. The model and serial numbers are on the back cover of your TV. Write these numbers in the space provided in this manual for your records. Please read all the safety and operating instructions carefully, and keep this manual for future reference.

#### Owner's Record

The model and serial numbers are located at the rear of the display unit, or on the side of the media receiver unit on the cartons (white label). Record these numbers in the spaces provided below. Refer to them whenever you call Syntax-Brilliant™ Groups Corporation or local dealer regarding this product.

**Model No.** \_\_\_\_\_

**Serial No.** \_\_\_\_\_

## Package Contents

- Syntax-Brilliant™ OLEVIA display unit
- Remote Control
- 1 AC power cord
- Quick Start Guide
- Warranty Card

These items are all you need to set up and operate the TV in its basic configuration.

**Note:** Most components (VCRs, DVD players, etc.) come with the necessary cables to connect them. If you want to set up a complex system, you may need to buy extra cables, connectors, etc. Be sure to have these on hand before you start to connect your system.

Syntax-Brilliant™ OLEVIA LCD HDTV includes many features, you will enjoy throughout the usage of your TV. These highlighted features include:

**Fully Integrated HDTV (High Definition TV):**

HDTV delivers a stunning picture far beyond the quality of standard televisions. These programs offer crystal clear video with amazing detail played with enhanced audio quality of digital television programs. You can enjoy better sound and picture in movies, prime time TV shows, and other HD broadcasts in dynamic television settings through cable, satellite or even free broadcasts over the air.



**HDMI (High Definition Multimedia Interface):**

The next generation of DVI, HDMI provides the best interface between a DVD player and compatible products such as digital set top box for uncompressed digital audio/video connections. When matched with a Syntax-Brilliant™ OLEVIA TV, multi-channel digital audio signals, uncompressed DVI digital video and intercommunication between high multimedia interfaces are combined through a single interconnecting cable.



# Accessories

## Supplied Accessories

Remote control & batteries (AA x 2)

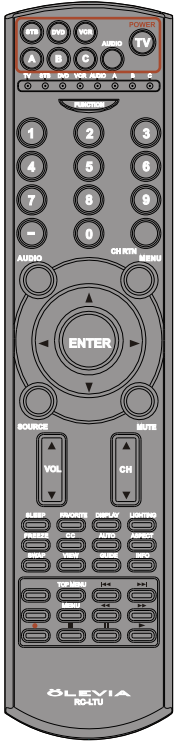

Power cord x 1



User manual  
(CD-ROM) x 1



QSG x 1

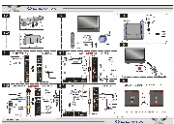

Warranty Card x 1



## Optional Accessories

Wall Mount Set

Model # WM30D

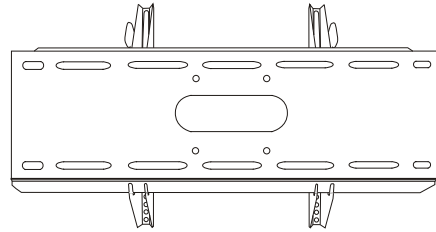

1. Before using the wall mount, please read its Quick Start Guide and follow assembly guide.
2. For safety purpose, please purchase wall mount that will support the LCD HDTV weight.
3. Following installation instruction is only for your reference.
4. Please consult authorized service personnel for the installation of wall mount.

# TV Installation and Connection Guide

## Identifying Front and Rear Panels

### Front Panel



**POWER** Turns display on/off.

**MENU** Displays the On Screen Display(OSD) menu. In OSD menu, press it to return to the previous screen or to exit.

**CH▲ / CH▼** Adjusts Channel. In the OSD menu, both keys are used to navigate within menu.

**VOL+/VOL-** Adjusts Volume. In the OSD menu, both keys are used to navigate within menu. Vol+ is used to select the highlighted option.

**SOURCE** Press to switch the input sources.

**IR SENSOR** Contains Infra-red light for digital data transmission by the remote control. Please point remote control at IR Sensor for function.

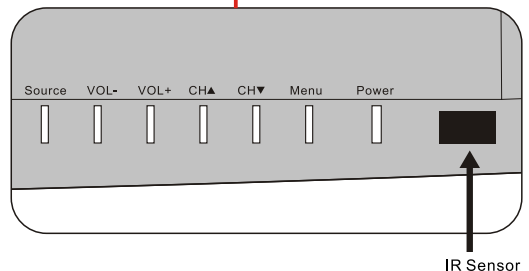







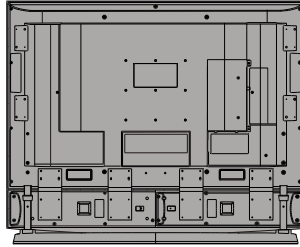



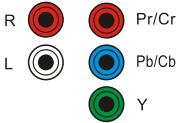

## Identifying Front and Rear Panels





### Rear Panel



<b>1 Power Connections</b>	
<b>AC In</b> 	The power cord connects here.
<b>2 Computer / TV Signal Connections</b>	
<b>RF Terminal</b> 	To receive signals from VHF / UHF antennas or a cable system (For TV Models Only)
<b>Component 1/2</b> 	(5 RCA jacks) Used to connect A/V equipment with component video outputs, such as a DVD player, Digital Satellite Receiver, or compatible Video Game System.  <b>NOTE:</b> The component inputs have a superior quality of picture than the S-Video or AV (composite video) inputs.
<b>Video 1/2</b> 	<b>AV (Composite Video: 3 RCA jacks):</b> Used to connect a VCR, Super VHS (S-VHS), DVD player, or other video devices to the TV. OR <b>S-Video :</b> (1 DIN and 2 RCA jacks) Used to connect video devices to the TV. However, they have a better quality of picture than a composite video signal.
<b>HDMI/DVI</b> 	Used to connect digital video equipment with a HDMI/DVI output. <b>NOTE:</b> Preferred connection for HDMI/DVI Satellite or Set-Top-Box equipment.
<b>VGA/Audio Input (PC) Port</b> 	Used for analog RGB signals from a personal computer. VGA has one set of Audio R/L inputs. OR As a computer input with VGA to RCA Adapter.
<b>Audio Input</b> 	To send an AV receiver or other equipment's connected audio signals to the TV
<b>Firmware Upgrade Port</b> 	To download some information from website to TV for user
<b>RS232C Port</b> 	Only for Service Technician use, not an interface for other devices. <b>Warning !</b> This RS232 control port is for service purpose only, and should be used by trained serviceman only. Any random connection may cause damage to this unit.
<b>Earphone</b> 	Used for audio output to earphone.
<b>Coaxial/Optical</b> 	To send the TV's connected digital audio signals to an AV receiver or other equipment, such as the amplifier

## Descriptions of Connector Types

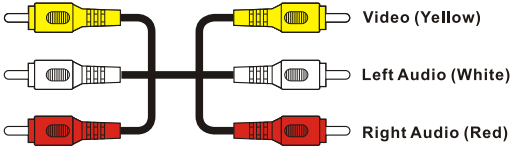
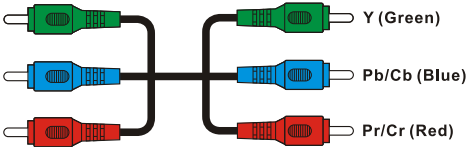
You may find it necessary to use some of the following cable types during setup.

<p><b><u>75-ohm Coaxial Cable</u></b></p> 	<p>For TV/cable connection</p>
<p><b><u>S-Video Cable</u></b></p> 	<p>Used for transferring video signal, which is split into two signals, brightness and color.</p> <p>Through this connection, you can view a better picture than AV (Composite Video) connection.</p>
<p><b><u>Audio/Video Cable</u></b></p>  <p>Video (Yellow)</p> <p>Left Audio (White)</p> <p>Right Audio (Red)</p>	<p>Used for transferring audio and video signal.</p> <p>This connection is the most commonly found on A/V equipment.</p>
<p><b><u>Component Cable</u></b></p>  <p>Y (Green)</p> <p>Pb/Cb (Blue)</p> <p>Pr/Cr (Red)</p>	<p>Used for transferring video signal, which is split into three signals, one brightness and two color.</p> <p>Through this connection, you can view a better high definition picture than S-Video or AV (Composite Video) connection.</p>
<p><b><u>HDMI Cable</u></b></p> 	<p>Used for transferring digital uncompressed video and audio signals to the TV.</p> <p>HDMI signal is purely digital and provides a crystal clear technology better than component, S-Video or Video connections. It is strongly recommended to use this connection if you have this function on your equipment.</p>

## Connecting the Power Cord

Complete other connections prior to connecting the power cord:

1. Connect the power cord to the AC IN connector of the TV.

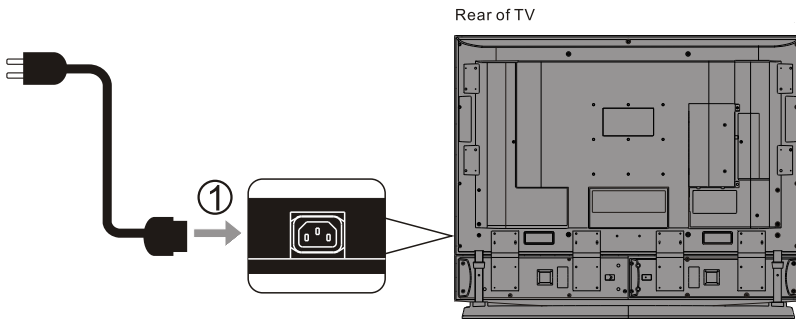

2. Connect the other end of the power cord to the wall outlet.



## Installation

In the following pages, you will find directions on how to install your tv and choice of video equipment.

- **Connecting to an Antenna or Video Equipment with Antenna outlet**
- **Connecting to a Set-Top-Box with HDMI Cables (Preferred TV connection)**
- **Connecting to a Satellite Receiver or Cable Box with Component Connectors  
(Secondary Preferred after HDMI)**
- **Connecting to a DVD Player with A/V or S Video Cables**
- **Connecting to a DVD Player with Component Cables**
- **Connecting to a DVD Player with HDMI Cables**
- **Connecting to a Satellite Receiver or Cable Box with A/V Cables**
- **Connecting to a VCR, PVR, or DV with A/V Cables**
- **Connecting to a Blue-Ray DVD Player or HD-Receiver with HDMI Cables  
and a PC with VGA Cables**
- **Connecting to a D-VHS with HDMI Cables**
- **Connecting to a D-VHS with Component Cables**
- **Connecting to an Audio Receiver**
- **Connecting to a Home Theater System or Earphone Set**
- **Instruction for Uploading New Firmware**

## Connecting to an Antenna or Video Equipment with Antenna outlet (For TV and DTV Source)

**⚠ Disconnect all power sources before making any connection.**

1. Connect a 75-ohm coaxial cable (or choice of Antenna Cable) from your cable or antenna to the TV's Antenna jack (RF Terminal).

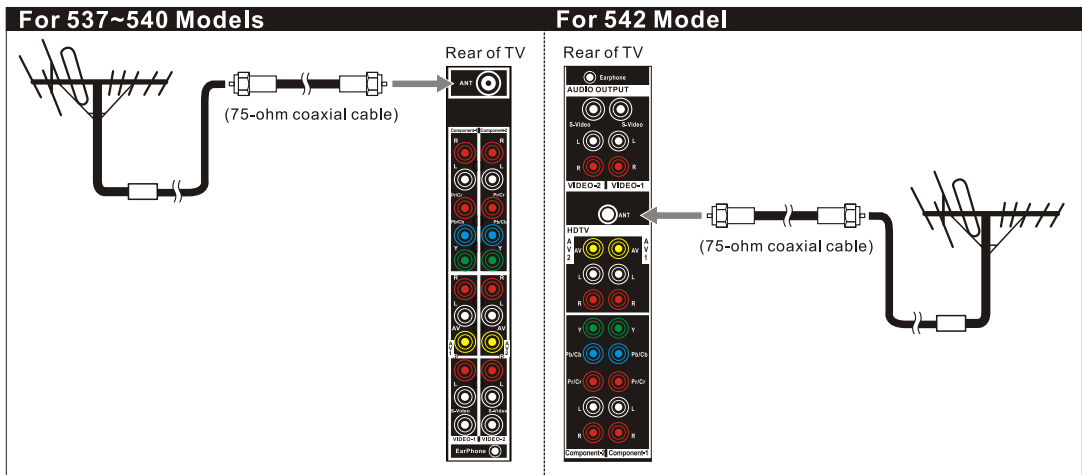

## If connecting to Video Equipment with Antenna outlet

1. Connect a 75-ohm coaxial cable (or choice of Antenna Cable) from your cable or antenna to the Video Equipment's IN jack.
2. Connect another 75-ohm coaxial cable from the Video Equipment's OUT jacks to the TV's Antenna jacks (RF Terminal).

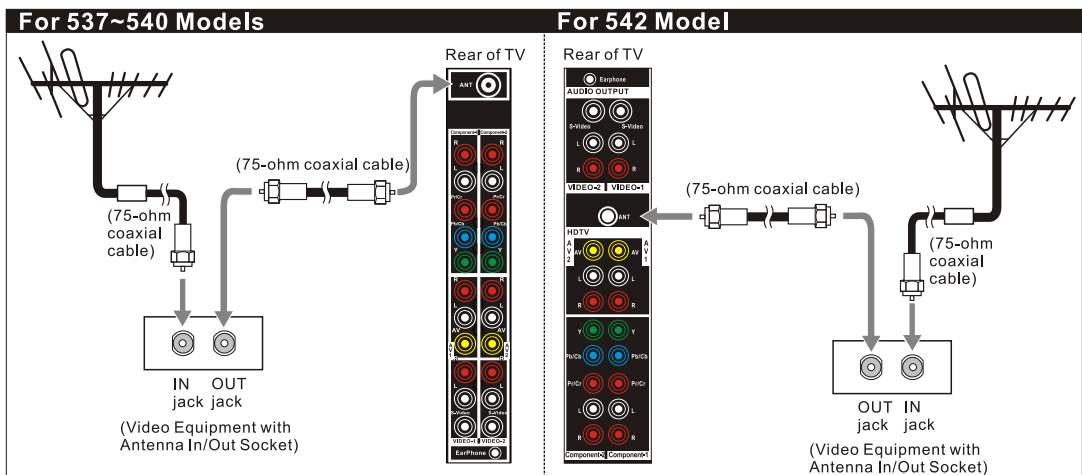

## Connecting to a Set-Top-Box with HDMI Cables (Preferred TV connection)

**⚠** Disconnect all power sources before making any connection.

1. Connect a 75-ohm coaxial cable (or choice of Antenna Cable) from your cable or antenna to the Set-Top-Box's Antenna jack (RF Terminal).
2. Connect a HDMI cable from the Set-Top-Box's HDMI OUT jacks to the TV's HDMI IN jacks.

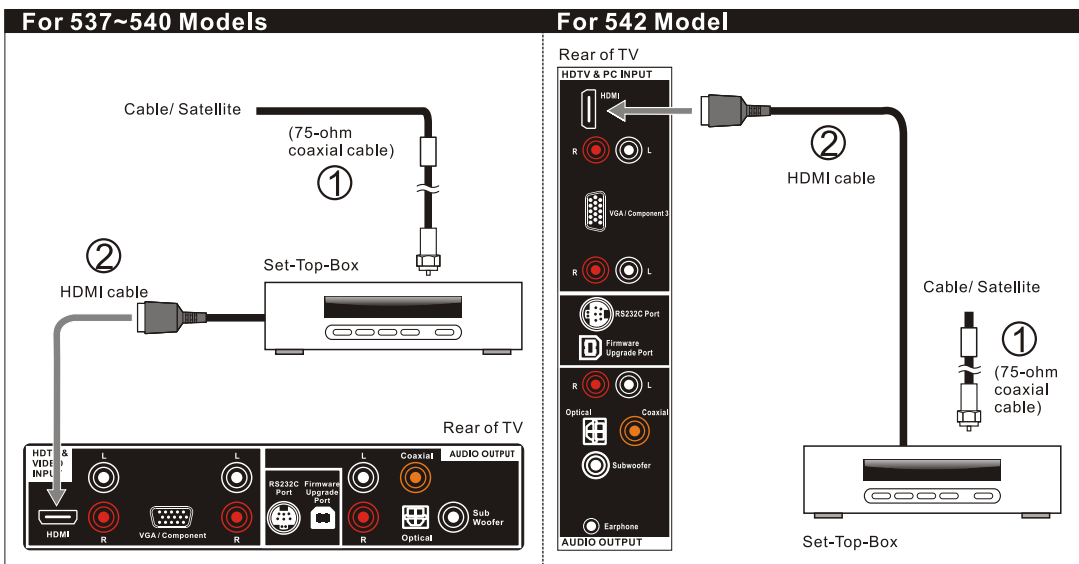

**Note:** HDCP is a copy protected digital connection that receives analog or digital video and audio signals from equipment with a HDMI output that features the HDCP function. HDMI allows the transfer of digital uncompressed data to the TV. This connection is superior when compared to the Component, S Video or AV (composite) connections.

**Note:** HDMI signal is purely digital and provides a better picture, it is better than component, S-Video or Video connections. It is strongly recommended to use this connection if you have this function on your equipment.

## Connecting to a Satellite Receiver or Cable Box with Component Connectors (Secondary Preferred after HDMI)

**⚠ Disconnect all power sources before making any connections.**

Use this method of connection if your Satellite Receiver or Cable Box has component (Y, Pb, Pr) jacks.

1. Using a component video cable, connect the Satellite Receiver or Cable Boxes' Y, Pb and Pr jacks to the Y, Pb and Pr jacks on the TV.

### Colors on Component Video connectors:

**Y:** Green

**Pb** (also identified as Cb, CB or B-Y): Blue

**Pr** (also identified as Cr, CR or R-Y): Red

**Note:** The Y, Pb and Pr jacks on your Satellite Receiver or Cable Box are sometimes labeled as Y, Cb and Cr, or B-Y and R-Y. If so, connect the cables to the matching colors.

2. Using an Audio cable, connect the Satellite Receiver or Cable Boxes' Audio OUT jacks to the TV's Audio in jacks.

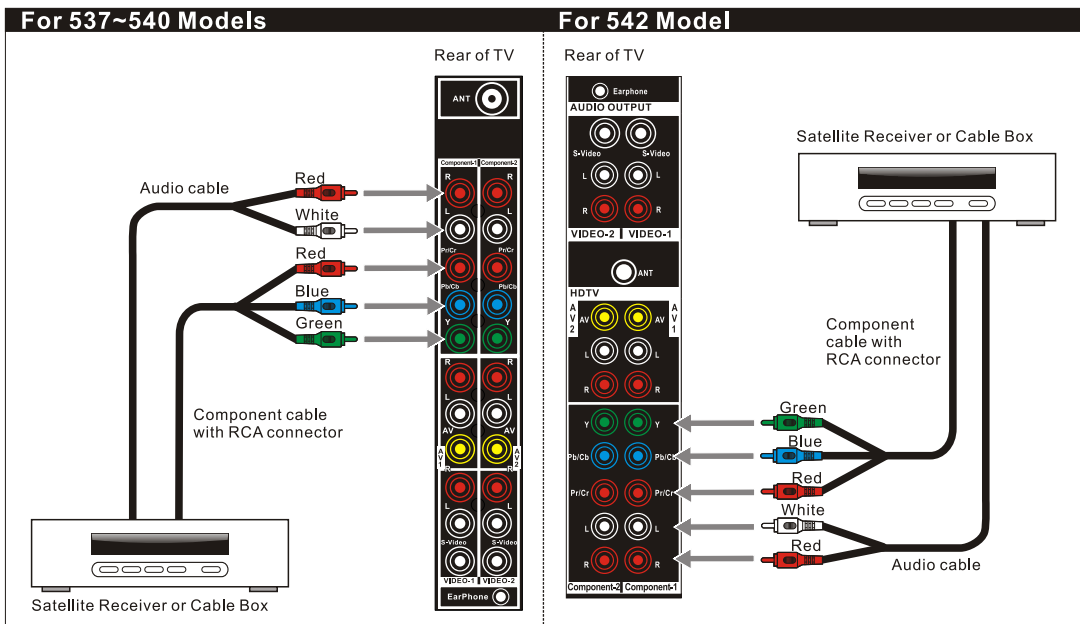

**Note:** The Y, Pb and Pr jacks do not provide audio, so audio cables must be connected to provide sound.

**Note:** The YPbPr connection provides the best quality of video signal compared to AV (composite) and S-Video connection.

**Note:** YPbPr is set at default to best perform with HD 720p and 1080i content, set Input to "Interlace DVD" for best performance with regular 480i and 480p content. (Menu - Picture - Mode - Input = "Interlace DVD")

## Connecting to a DVD Player with A/V or S Video Cables

**⚠** Disconnect all power sources before making any connections.

Use this method of connection if your DVD player does not have component (Y, Pb, Pr) jacks.

**Note:** If your DVD player has component video output connectors, for best picture quality, use the connection described for *Connecting to a DVD Player with Component Connectors.* (See page.17)

1. Using an A/V cable, connect the DVD player's Audio OUT jacks to the TV's Audio IN jacks.
2. Using an S-Video Cable, connect the DVD player's S Video OUT jack to the TV's S Video IN jack.

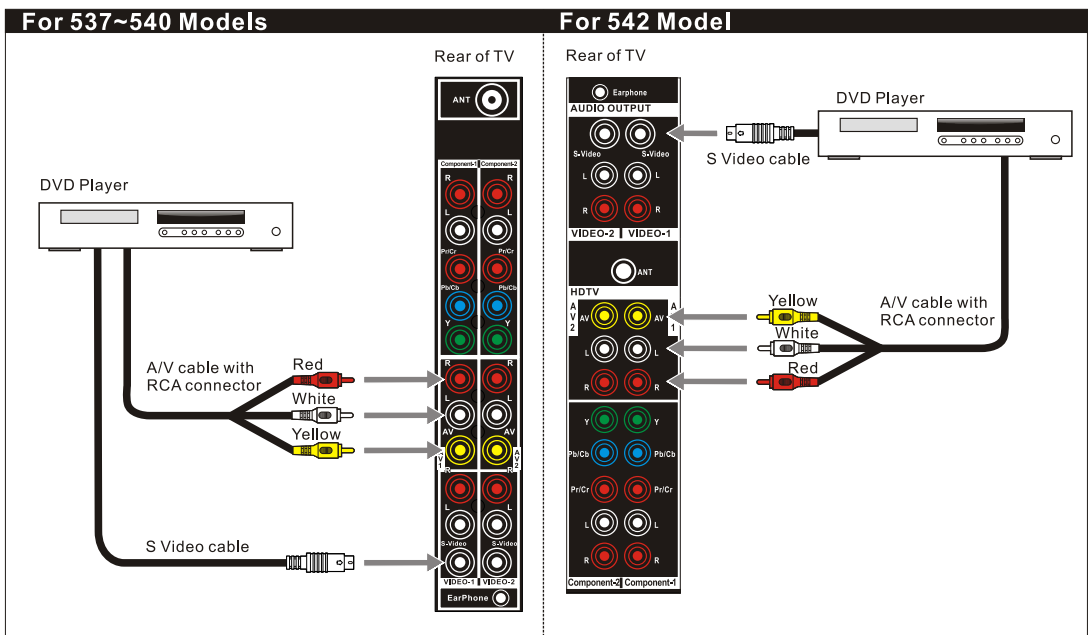

**Note:** When you connect video equipment to both the same Video and S-Video input jacks, the display will automatically select S-Video first.

To view Video signal, please disconnect the S-Video jack or turn off the Video signal on the video equipment.

S-Video is strongly recommended for use if your VCR or video equipment has the option.

S-Video input has better quality of picture than a composite Video signal.



## Connecting to a DVD Player with Component Cables

**⚠ Disconnect all power sources before making any connections.**

Use this method of connection if your DVD Player has component (Y, Pb, Pr) jacks.

1. Using a component video cable, connect the DVD Player's Y, Pb and Pr jacks to the Y, Pb and Pr jacks on the TV.

### Colors on Component Video connectors:

**Y:** Green

**Pb** (also identified as Cb, CB or B-Y): Blue

**Pr** (also identified as Cr, CR or R-Y): Red

**Note:** The Y, Pb and Pr jacks on your DVD player are sometimes labeled as Y, Cb and Cr, or B-Y and R-Y. If so, connect the cables to the matching colors.

2. Using an Audio cable, connect the DVD player's Audio OUT jacks to the TV's Audio in jacks.

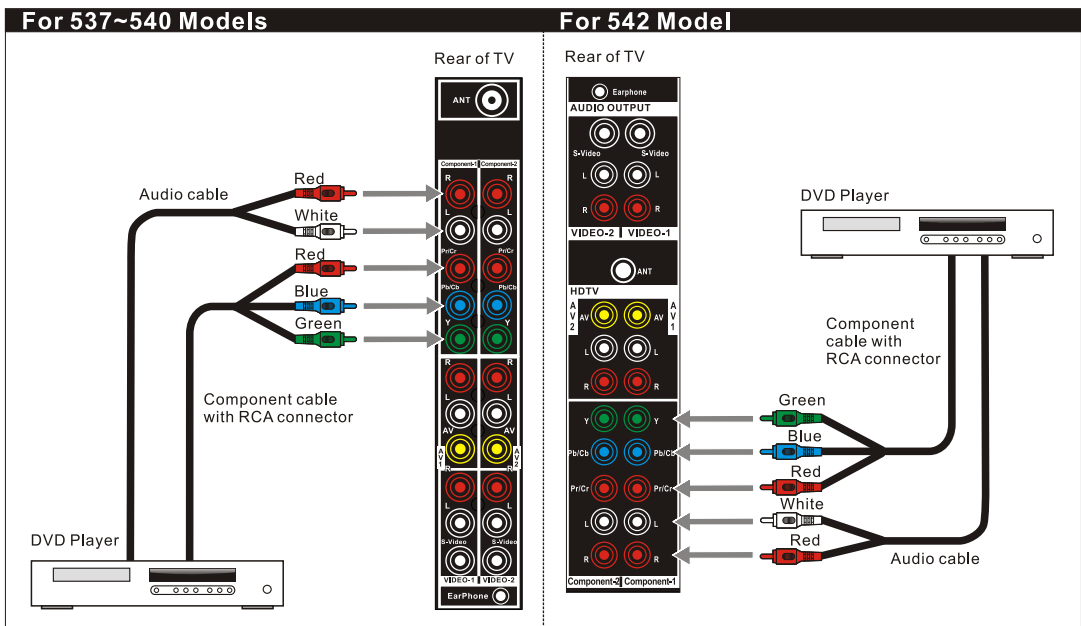

**Note:** The Y, Pb and Pr jacks do not provide audio, so audio cables must be connected to provide sound.

**Note:** The YPbPr connection provides the best quality of video signal compared to AV (Composite) and S-Video connection.

**Note:** YPbPr is set at default to best perform with HD 720p and 1080i content, set Input to "Interlace DVD" for best performance with regular 480i and 480p content. (Menu - Picture - Mode - Input = "Interlace DVD")

## Connecting to a DVD Player with HDMI Cables

**⚠ Disconnect all power sources before making any connections.**

Use this method of connection if your DVD Player has HDMI jacks.

1. Using a HDMI cable, connect the DVD Player's HDMI output terminal to the TV's HDMI-HDCP input terminal.

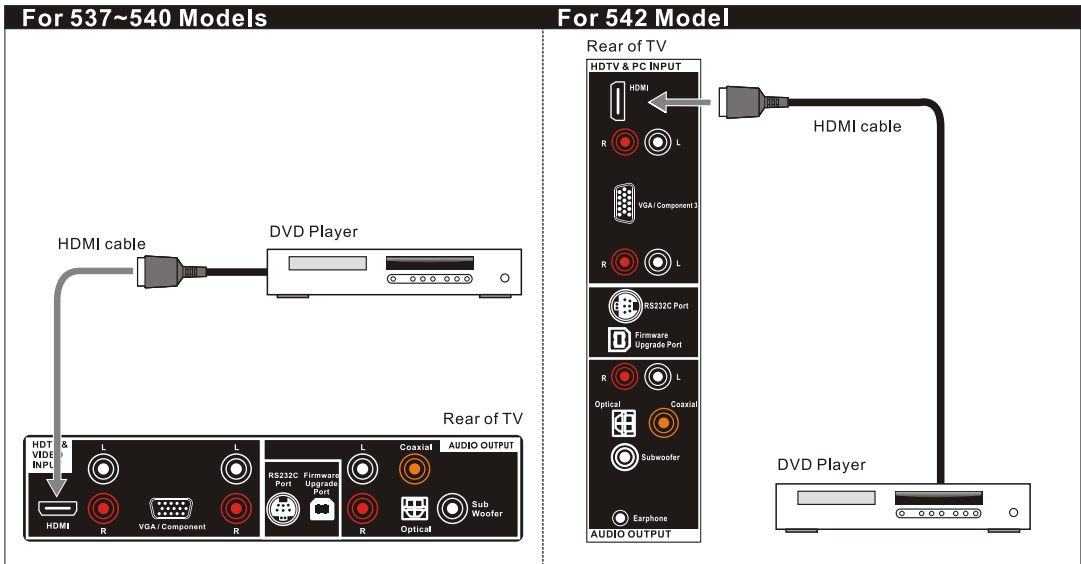

**Note:** HDCP is a copy protected digital connection that receives analog or digital video and audio signals from equipment with a HDMI output that features the HDCP function. HDMI allows the transfer of digital uncompressed data to the TV. This connection is superior when compared to the Component, S Video or AV (composite) connections.

**Note:** HDMI signal is purely digital and provides a better picture, it is better than component, S-Video or Video connections. It is strongly recommended to use this connection if you have this function on your equipment.

## Connecting to a Satellite Receiver or Cable Box with A/V Connectors

**⚠ Disconnect all power sources before making any connections.**

1. Connect a 75-ohm coaxial cable from your Cable TV to the Satellite Receiver's or Cable Box's Antenna jack.
2. Using Audio and S Video cables, connect the satellite receiver's Audio and S-Video OUT jacks to the TV Audio and S Video IN jacks.

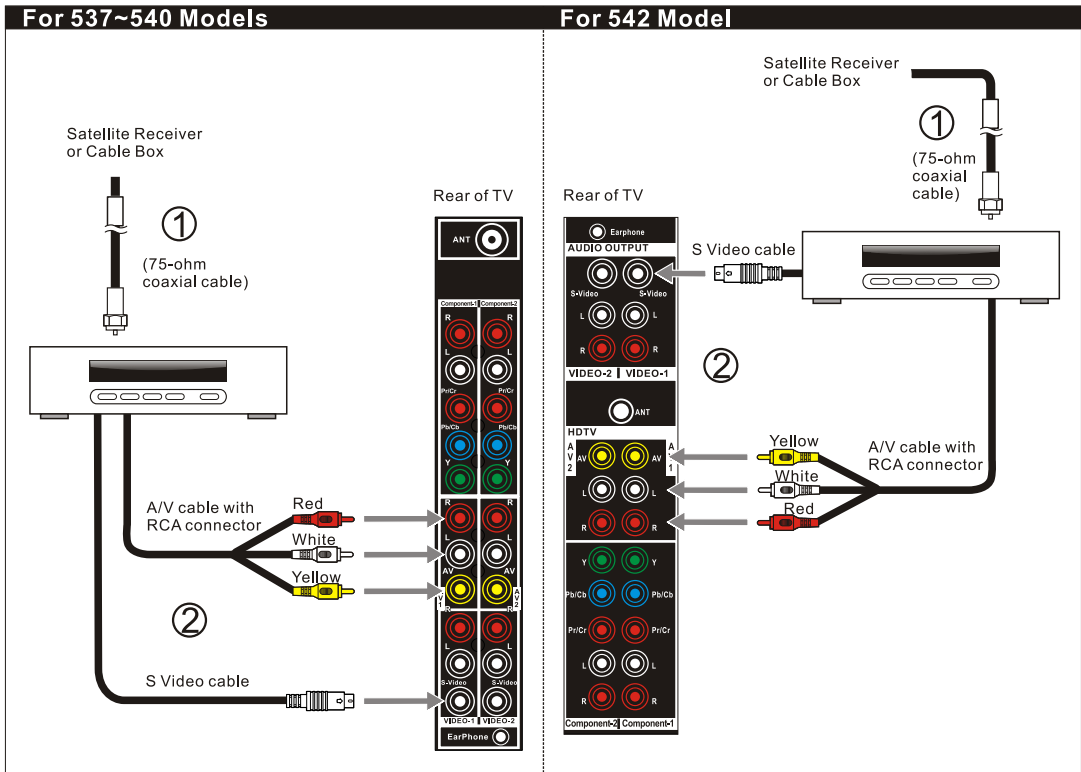

**Note:** When you connect video equipment to both the same Video and S-Video input jacks, display will automatically select S Video first.  
To view S-Video signal, please disconnect Video jack or turn off the Video signal on the video equipment.

S-Video is strongly recommended for use if your VCR or video equipment has it because S-Video input has better quality of picture than a composite Video signal.

## Connecting to a VCR, PVR, or DV with A/V Cables

**⚠** Disconnect all power sources before making any connections.

1. Using A/V cable and S-Video cables, connect the video equipment's Audio and S-Video OUT jacks to the TV's Audio and S-Video In jacks.

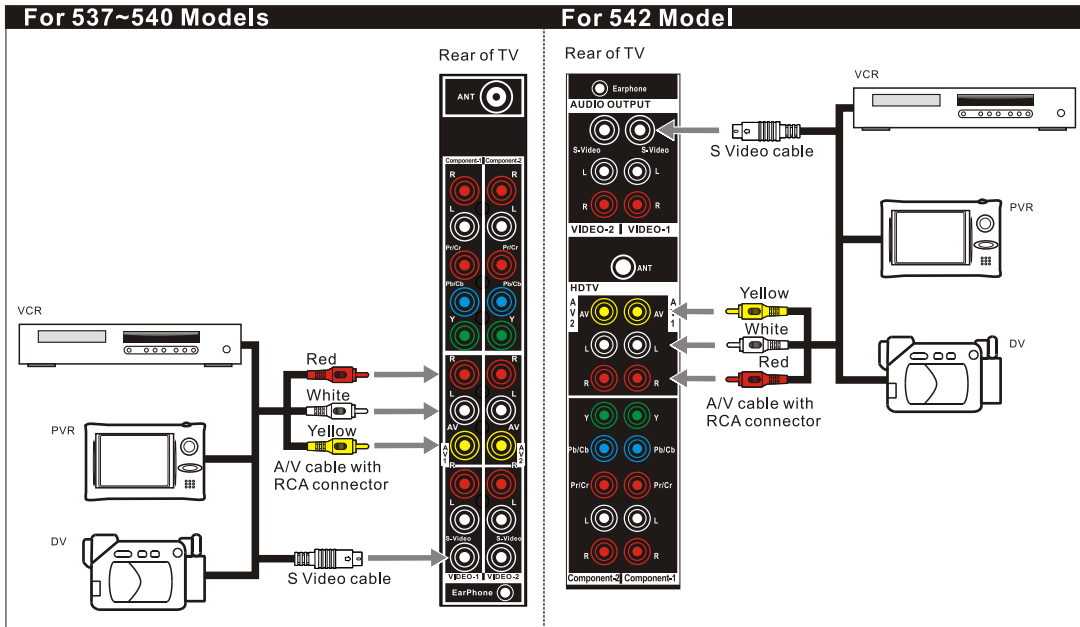

### Connecting both Video IN and S-Video IN

**Note:** When you connect video equipment to both the same Video and S-Video input jacks, display will automatically select S-Video first.

To view Video signal, please disconnect the S-Video jack or turn off the S-Video signal on the video equipment.

S-Video is strongly recommended for use if your VCR or video equipment has it. S-Video input has a better quality of picture than a composite Video signal.

## Connecting to a Blue-Ray DVD Player or HD-Receiver with HDMI Cables

**⚠ Disconnect all power sources before making any connections.**

1. Using a HDMI cable, connect the DVD's HDMI output terminal to the TV's HDMI-HDCP input terminal.

**Note:** HDCP is a copy protected digital connection that receives analog or digital video and audio signals from equipment with a HDMI output that features the HDCP function. HDMI allows the transfer of digital uncompressed data to the TV. This connection is superior when compared to the Component, S Video or AV (composite) connections.

**Note:** HDMI signal is purely digital and provides a better picture, it is better than component, S-Video or Video connections. It is strongly recommended to use this connection if you have this function on your equipment.

## Connecting to a PC with VGA Connector

**⚠ Disconnect all power sources before making any connections.**

- Using a D-Sub 15 pin cable, connect the VGA output terminal of the PC to the TV's VGA signal input terminal.
- You may need to use a Stereo mini jack to Audio in connectors to receive audio.

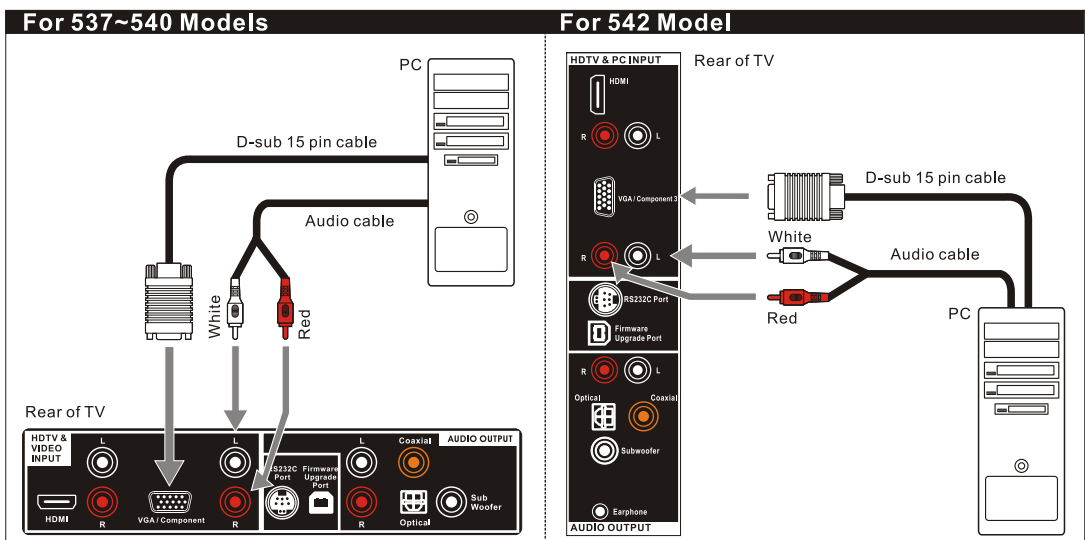
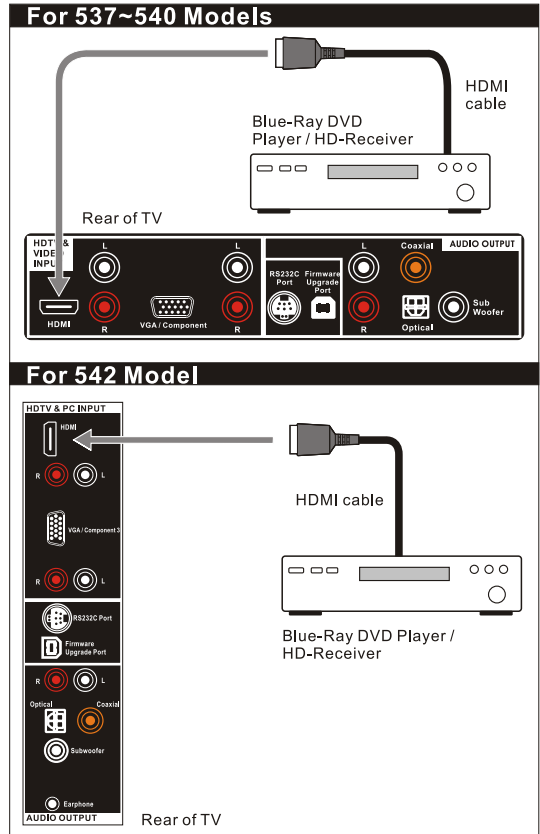

## Connecting to a D-VHS with HDMI Cables

**⚠ Disconnect all power sources before making any connections.**

1. Connect a 75-ohm coaxial cable from your cable or antenna to the Set-Top-Box's Antenna jack.
2. Using Audio and S-Video (YPbPr, or HDMI is strongly recommended) cables, connect the Set-Top-Box's Audio and S-Video OUT jacks to the TV's Audio and S-Video IN jacks.
3. Connect an I-Link cable from the Set-Top-Box to the D-VHS equipment for video transmission and record.
4. Using a HDMI cable, connect the D-VHS's HDMI OUT jack to the TV's HDMI IN jacks for watching the recorded videos.

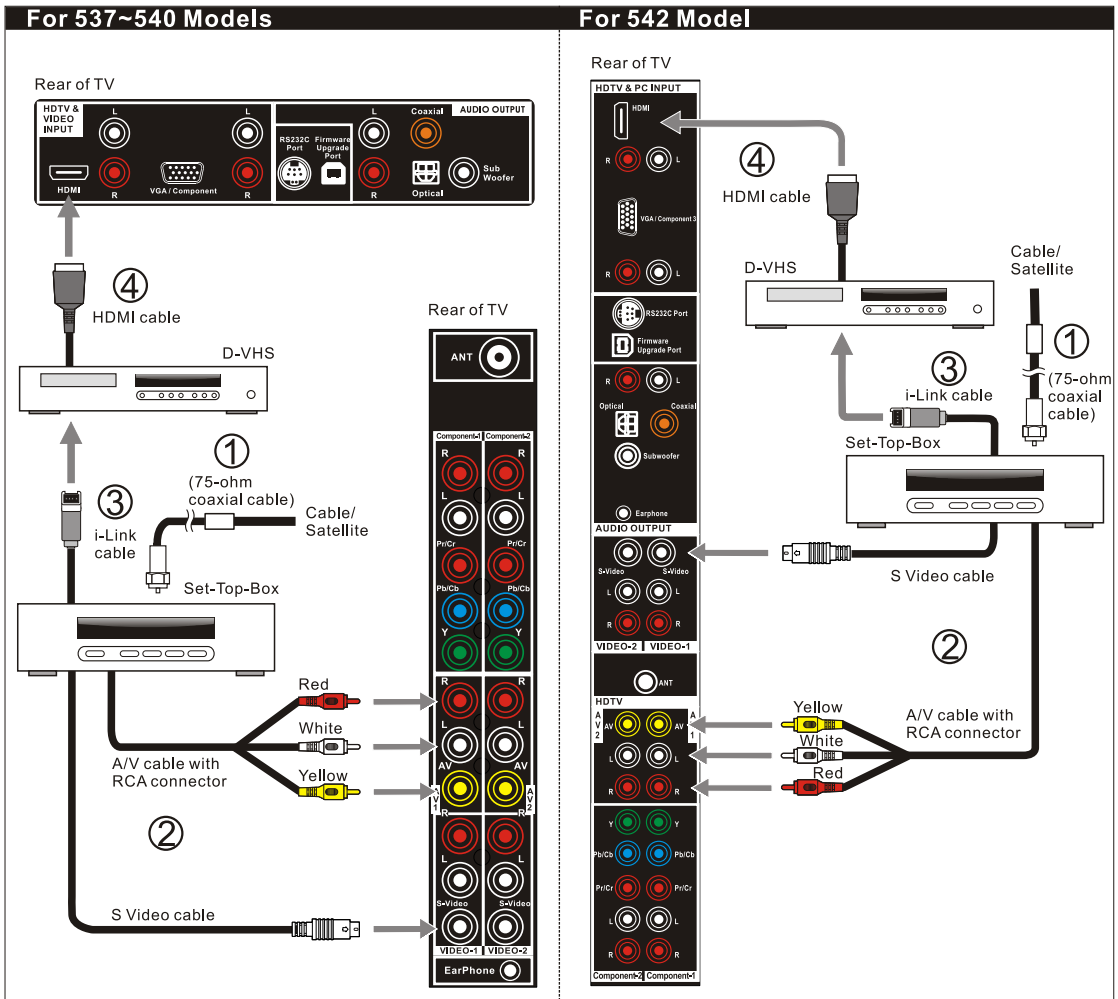

**Note:** HDCP is a copy protected digital connection that receives analog or digital video and audio signals from equipment with a HDMI output that features the HDCP function. HDMI allows the transfer of digital uncompressed data to the TV. This connection is superior when compared to the Component, S Video or AV (composite) connections.

**Note:** HDMI signal is purely digital and provides a better picture, it is better than component, S-Video or Video connections. It is strongly recommended to use this connection if you have this function on your equipment.

## Connecting to a D-VHS with Component Cables

**⚠ Disconnect all power sources before making any connections.**

Use this method of connection if your D-VHS has component (Y, Pb, Pr) jacks.

1. Connect a 75-ohm coaxial cable from your cable or antenna to the Set-Top-Box's Antenna jack.
2. Using Audio and S-Video (YPbPr, or HDMI is strongly recommended) cables, connect the Set-Top-Box's Audio and S-Video OUT jacks to the TV's Audio and S-Video IN jacks.
3. Connect an I-Link cable from the Set-Top-Box to the D-VHS equipment for video transmission and record.
4. Using Audio and Component video cables, connect the D-VHS's Audio and Y, Pb and Pr OUT jacks to the TV's Audio and Y, Pb and Pr IN jacks for watching the recorded videos.

### Colors on Component Video connectors:

**Y:** Green

**Pb** (also identified as Cb, CB or B-Y): Blue

**Pr** (also identified as Cr, CR or R-Y): Red

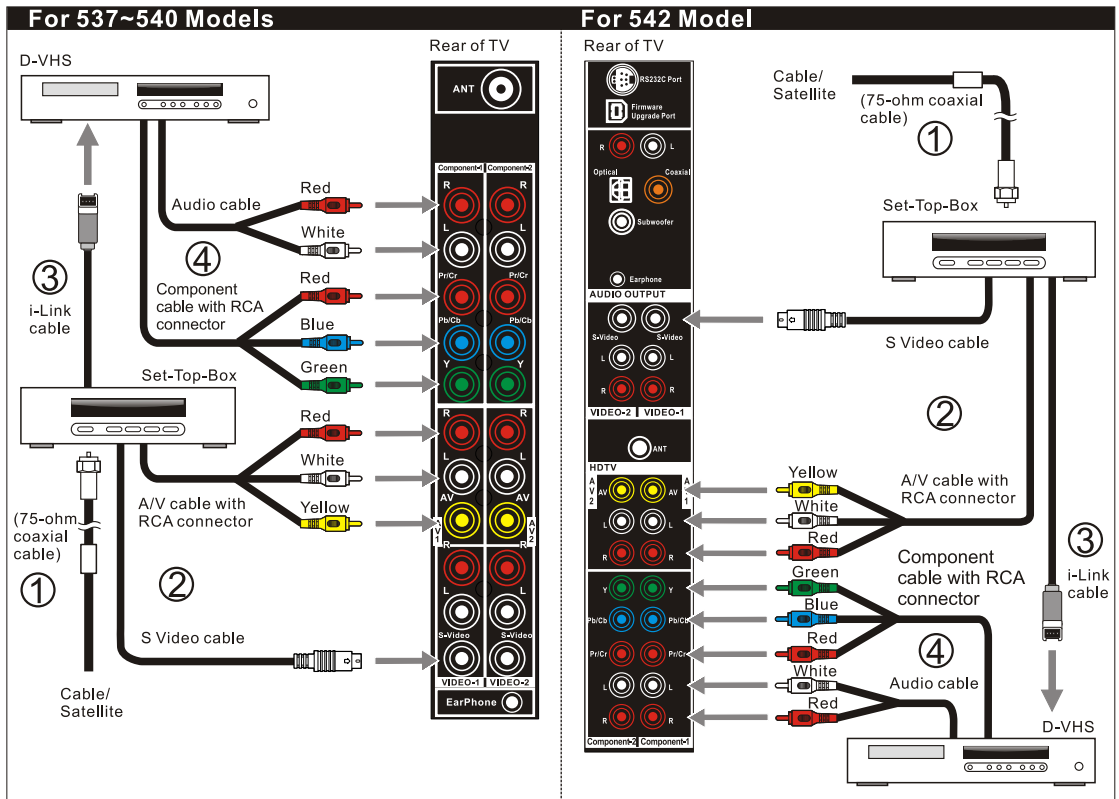

**Note:** The Y, Pb and Pr jacks do not provide audio, so audio cables must be connected to provide sound.

**Note:** The YPbPr connection provides the best quality of video signal compared to AV (Composite) and S-Video connection.

**Note:** YPbPr is set at default to best perform with HD 720p and 1080i content, set Input to "Interlace DVD" for best performance with regular 480i and 480p content.  
(Menu - Picture - Mode - Input = "Interlace DVD")

## Connecting to an Audio Receiver

**⚠ Disconnect all power sources before making any connections.**

(For Analog Audio Source)

1. Using the R/L audio cable, connect the TV's audio OUT jack to the audio receiver's audio IN or AUX IN jacks.

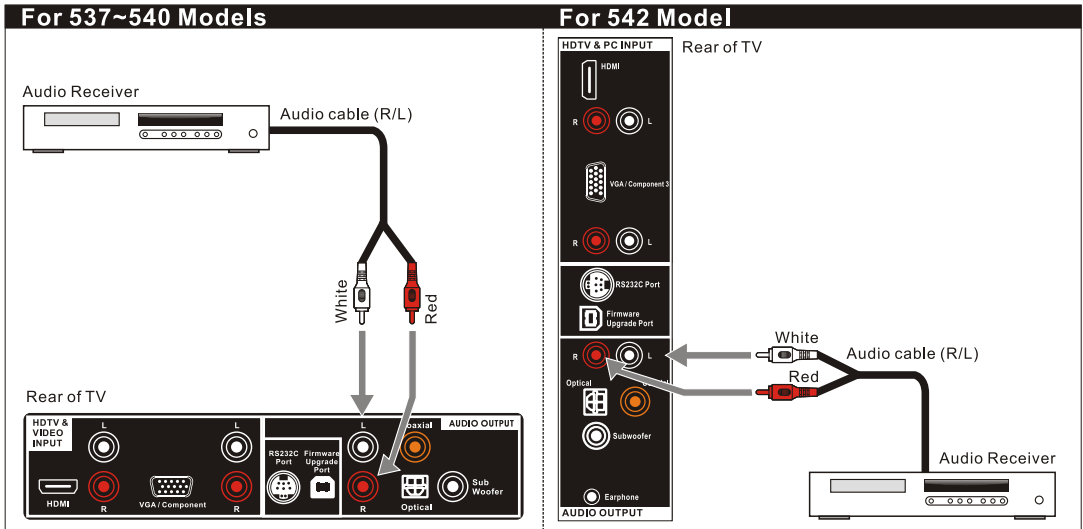

(For Digital Audio Source)

1. Using the Coaxial or Optical audio cable, connect the TV's audio OUT jack to the audio receiver's Coaxial or Optical IN jacks.

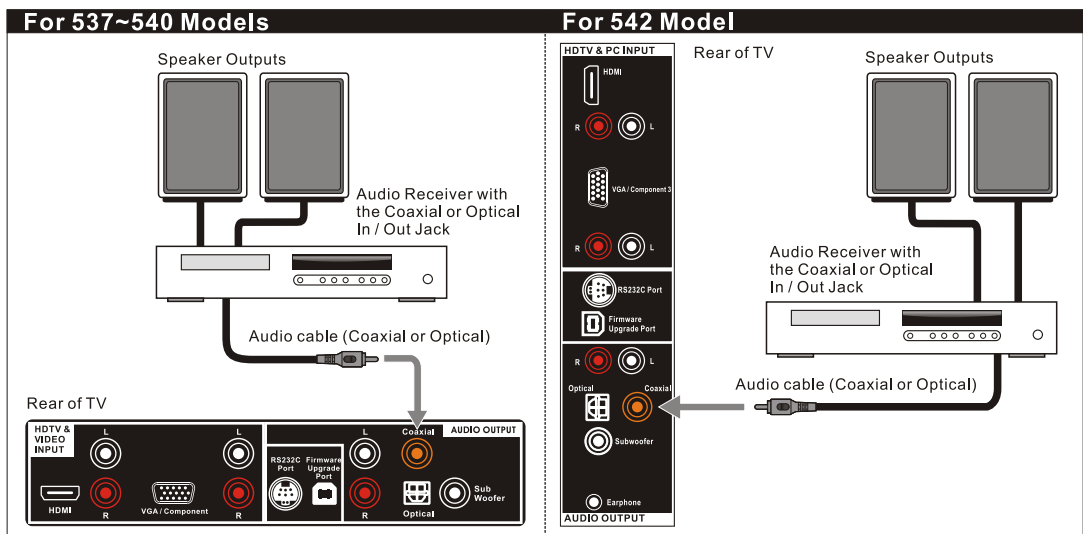

**Note:** Speakers must be amplified using an audio receiver such as a Home Theater System to amplify the audio from the TV.



## Connecting to a Home Theater System or Earphone Set

**⚠** Disconnect all power sources before making any connections.

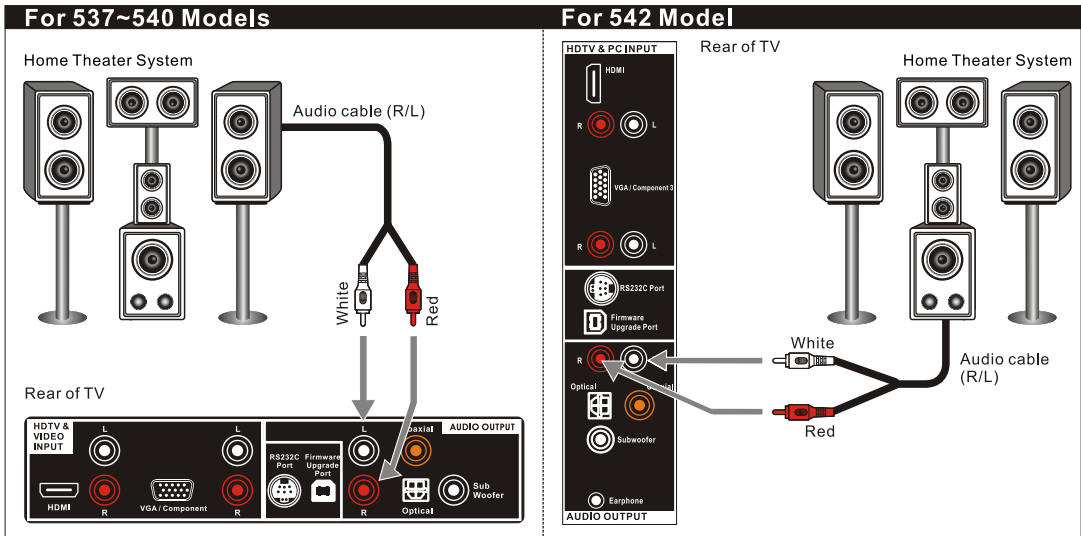

**Note:** When connecting an Audio output signal, an external Audio amplifier is necessary to amplify the signal for external speakers.

**Note:** If you connect a Home Theater Sound System, please disable the TV's speakers in the OSD by selecting off in audio section. Volume adjustment must be made on the Home Theater Receiver. By not disabling the TV's speakers it may cause the speakers or the TV itself damage.

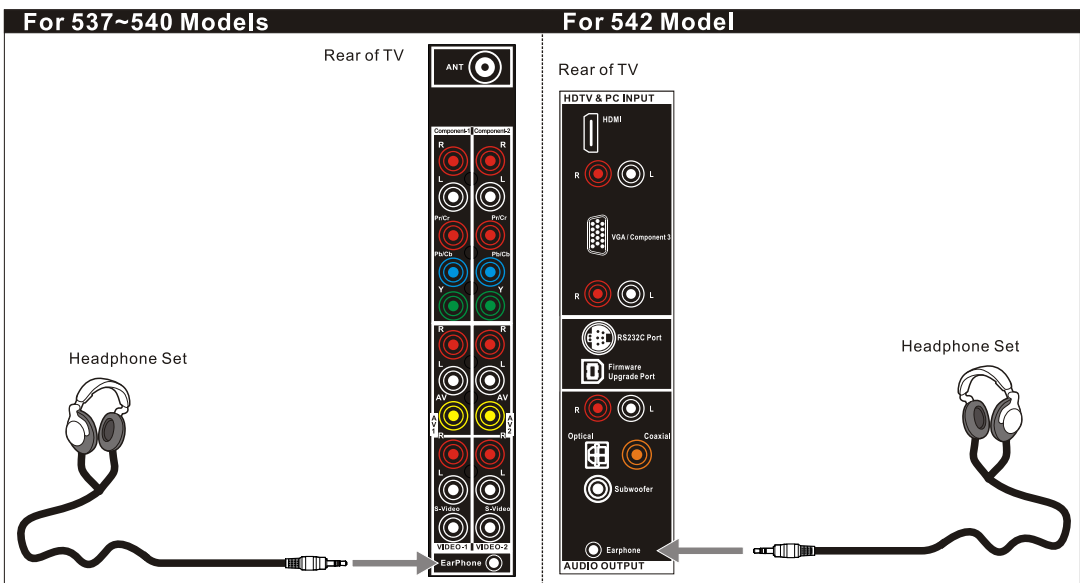

**Note:** When headphone is plugged in the speaker, it will turn into mute mode.

## **Instruction for Uploading New Firmware**

1. Please visit our website for the detail information.
2. Please register LCD HDTV on our website.
3. Please log on to the firmware download section by following the instructions.
4. Please review the available downloads, the bugs fixed, and the new features added.
5. Please follow the instructions on the website for their specific model for downloading the new firmware and for loading the firmware into the TV.

# Remote Control Guide

## Remote Function Keys & Description

- 1. POWER** Press to turn display on/off.
- 2. FUNCTION** Press to select the equipment item you want to program or operate.
- 3. NUMBER BUTTONS** Press to select channels on the display.
- 4. -** Press to select sub-channel.
- 5. AUDIO** Press to switch the TV Audio System between SAP, Mono or Stereo mode.
- 6. DIRECTION BUTTONS :**
  - ▲/▼ Press to select between four main sections or select the function item.
  - ◀/▶ Press to enter to Sub-Menu, select the function item or adjust the value bar.
- 7. SOURCE** Press to switch the source input between Tuner, Composite 1, Composite 2, S-Video 1, S-Video 2, Component 1, Component 2, HDMI, VGA.
- 8. VOL+ / VOL-** Press to adjust the volume.
- 9. CH RTN** Press to return the previous-channel.
- 10. MENU** Press to activate or close the On Screen Display menu.
- 11. ENTER** Press to enter to Sub-Menu, or highlight and set up menu.
- 12. MUTE** Press to mute the sound.
- 13. CH+ / CH-** Press to adjust channel up and channel down.
- 14. HotKeys** Press to directly access certain Shortcut TV functions.
  - 1. SLEEP** Press to automatically shut off the TV after a preset period of time has passed.
  - 2. FAVORITE** Press to select favorite channels. Can be preset in OSD Menu.
  - 3. DISPLAY** Press to display the information of current channel number.
  - 4. LIGHTING** Press to switch the lighting mode between Dark, Medium, Bright Room.
  - 5. FREEZE** Press to freeze the picture. Press again to unfreeze the picture.
  - 6. C.C.** Press to turn on/off the Closed Caption (CC) function.
  - 7. AUTO** Press to adjust screen position automatically when the screen image is not centered under VGA mode.
- 15. Other Buttons** They only can work when operating the other equipments such as DVD, or VCR device.

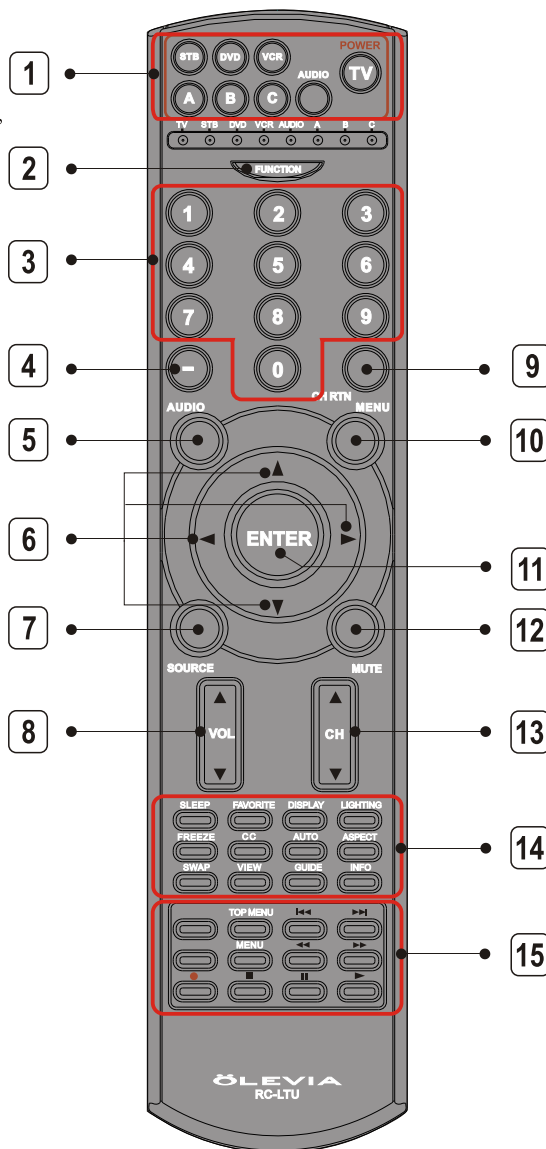

## Programming the Remote Control

If you have the other equipment you want to operate with the TV's remote control, do the following procedures to program the remote control.

1. Select the 4-digit code number for the equipment you want to operate from the lists on Page 66.
2. Press the "FUNCTION" button repeatedly to select the equipment item you want to operate.
3. Press the "ENTER" and "FUNCTION" buttons at the same time for 4-5 seconds.
4. Once the Indicator LED for the equipment item you select flashes orange light once, enter the 4-digit code number using the numeric buttons.

*Note: If there are more than one code on the list, try entering the code one by one until it is correct for the equipment.*

5. Afterwards, the Indicator LED will flash orange light for a while, and then stop flashing.
6. Check if the code number is correct by aiming the TV's remote control at the equipment and then press the equipment's POWER button, such as STB, DVD, or VCR...etc.

*Note: If it responds, the programming is completed. If not, try the other code again following the steps above.*

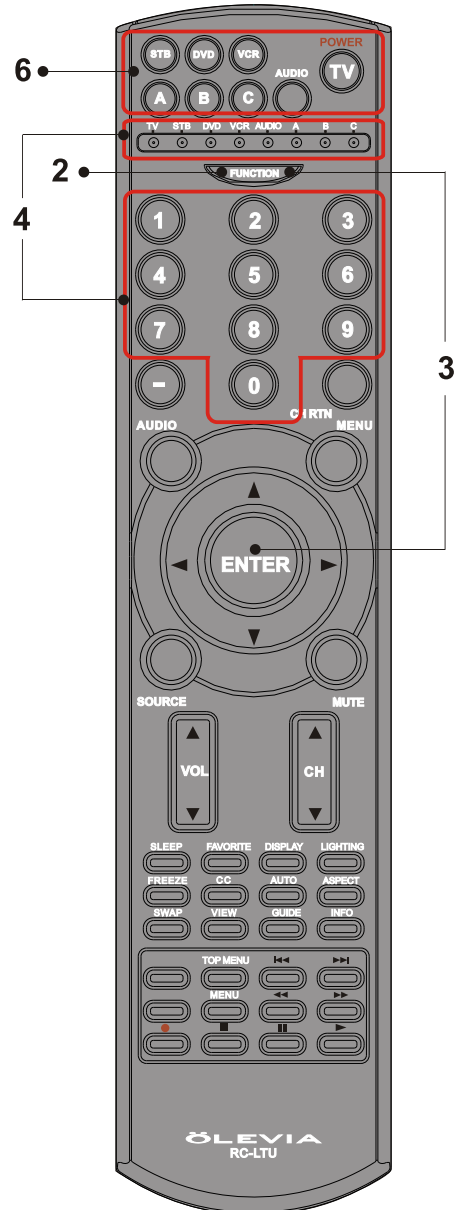

## Battery Installation

1. Push the tab and pull it out as illustrated below.
2. Insert two size AA batteries (supplied) by matching the (+) and (-) on the batteries to the diagram inside the remote control's battery department.
3. Replace the cover back and make sure the cover "snaps" into the remote control.

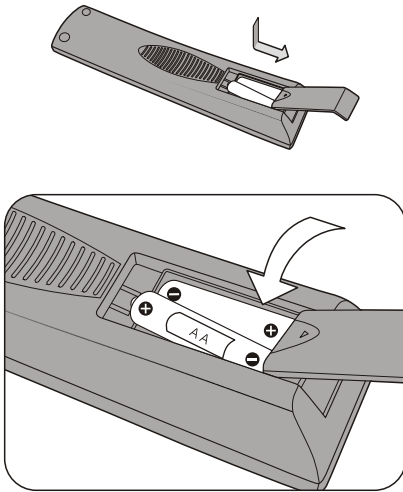

### Note:

1. The display unit comes with two new AA batteries as accessories. However, due to uncontrollable causes, the electricity of the accessorized batteries may be partially or completely drained. We do not warrant the quality of the batteries in any case since many factors are considered. If replacement is needed, please purchase two AA batteries.
2. Handle remote with care. Avoid dropping it, placing in direct sunlight, near a heater, high areas of humidity or getting it wet. If the remote gets wet, please wipe it dry immediately. In the event of the remote not working properly or is in operational, a replacement of remote control may be required.
3. If you do not use the remote control for a long period of time, please remove the batteries and store in a cool place to preserve battery life.
4. Do not mix new and used or with different types of batteries for operation.

# On Screen Displays (OSD)



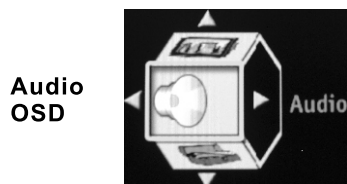
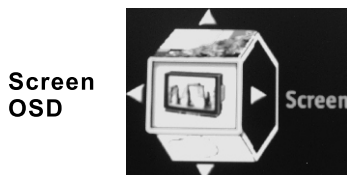

## Introduction

After you have finished connecting your TV, you are now ready to choose and personalize your TV settings in the OSD (On Screen Display) menu.

There are four main sections in the OSD Menu:



## Operating in the OSD

1. Press "  " button to enter OSD menu mode.
2. To select between four main sections, press the keys "▲" and "▼".
3. To enter to Sub-Menu, press the keys "◀", "▶" or "  ".
4. To select the function item, press the keys "▲", "▼", "◀", or "▶".
5. To adjust the value bar, press the keys "◀" and "▶".
6. To select and set up, press "  ".
7. To go back to last OSD Menu or exit the OSD menu, press "  " again or without action for 12 seconds of inactivity.

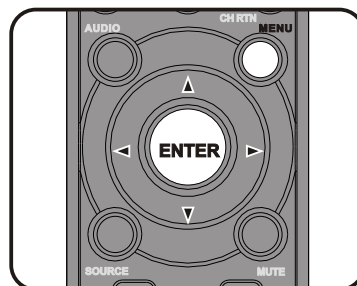
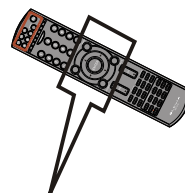

## Picture OSD Adjusting TV Picture Settings

### Description of Settings

Item	Adjustment	Function
Brightness		To adjust brightness contrast of the picture
Contrast		To adjust color contrast of the picture
Color temp		To adjust image color intensity
6500		
6500 User	Red Gain, Green Gain Blue Gain, Red Offset Green Offset, Blue Offset	To allow User to adjust RGB value
9300		
9300 User	Red Gain, Green Gain Blue Gain, Red Offset Green Offset, Blue Offset	To allow User to adjust RGB value
Native		To select the nature color tones of the picture
Color		To adjust the color intensity
Tint		To decrease or increase red or green tones of the picture
Sharpness		To adjust sharpness or softness of the picture
Mode		
Lighting	Dynamic AI, Dark, Medium, Bright Room	To adjust darkness or lightness of the screen
Input	VCR, Interlaced DVD, Progressive DVD, Standard Def TV, High Def TV, User	To select the video input source with varied qualities
Power Up	Show Room, Home	
Idea		
Black Level Extender	On, Off	To extend "gray" to "black" color for a more accurate picture
NR(Noise Reduction)	Low, Medium, High, Off	To reduce high frequency noise signal
Flesh Tone	On, Off	To tone down strong reds and produce more naturalistic color tones
Adaptive Luma Control	On, Off	To control the luminance adaptively
Contrast Enhance	On, Off	To enhance the contrast of the picture
White Peak Limiter	On, Off	To limit the signal amplitude varying degree resulted in brightness over saturation

### Initial Screen

#### ➤ Power Up

The first time you power on the TV, the options below will appear for your selection.

#### Show Room :

You may select it when watching in the show room.

#### Home :

You may select it when watching at home.

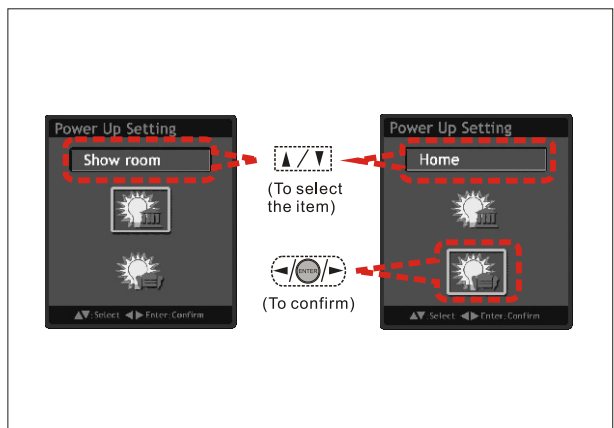

## Selecting the Picture Mode

### ➤ Mode

In this "Mode" Index, you can select one of the picture modes which is suitable for the program you are watching.

#### Lighting :

To adjust darkness or lightness of the screen

- \* **Dynamic AI** : To adjust the brightness and contrast of the dynamic video for quality enhancement
- \* **Dark Room** : To darken the screen
- \* **Medium Room**
- \* **Bright Room** : To brighten the screen

#### Input :

To select the video input source with varied qualities

- \* **VCR**
- \* **Interlaced DVD**
- \* **Progressive DVD**
- \* **Standard Def TV**
- \* **High Def TV**
- \* **User**

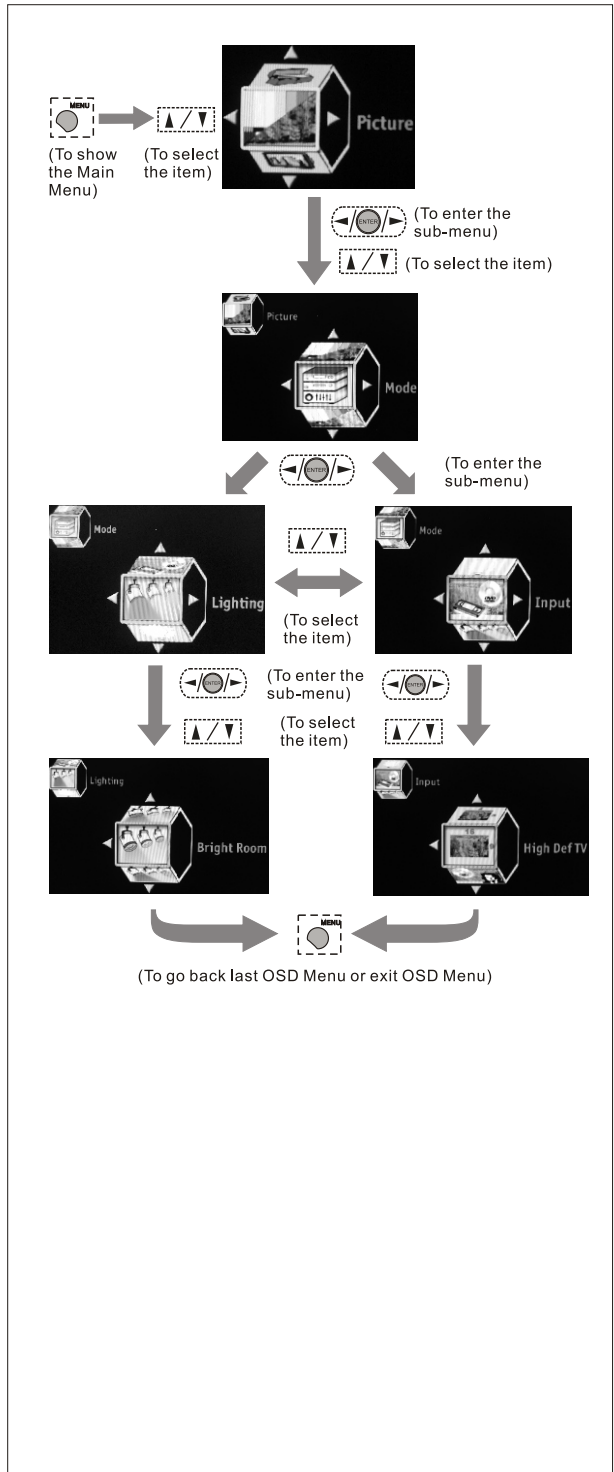



## Adjusting the Video or Picture Quality

In this Setup Index, you can adjust the video and picture settings to suit your personal preferences.

- **Brightness**  
To darken or brighten the picture
- **Contrast**  
To reduce(soften) or enhance(deepen) color contrast of the picture
- **Color**  
To decrease or increase color intensity of the picture
- **Tint**  
It allows you to decrease or increase red or green tones of the picture.
- **Sharpness**  
To soften or sharpen the picture
- **Color Temp**  
To customize the RGB settings

### 6500

#### 6500 User :

- \* **Red Gain**- To increase red tones of the picture
- \* **Green Gain**- To increase green tones of the picture
- \* **Blue Gain**- To increase blue tones of the picture
- \* **Red Offset**- To decrease red tones of the picture
- \* **Green Offset**- To decrease green tones of the picture
- \* **Blue Offset**- To decrease blue tones of the picture

### 9300

#### 9300 User :

The settings are as the same as the "6500 User" option.

#### Native :

To select the nature color tones of the picture

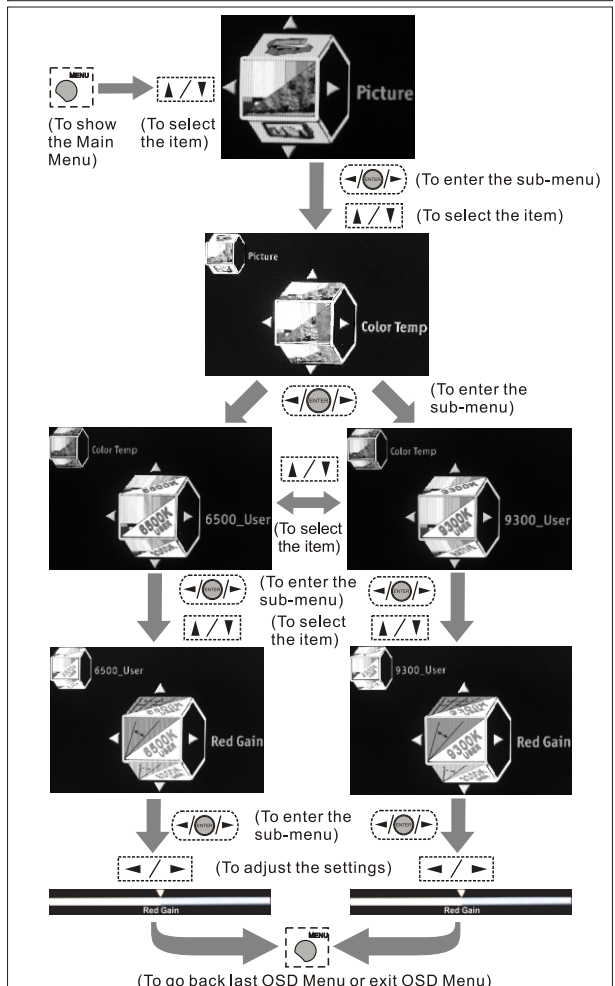
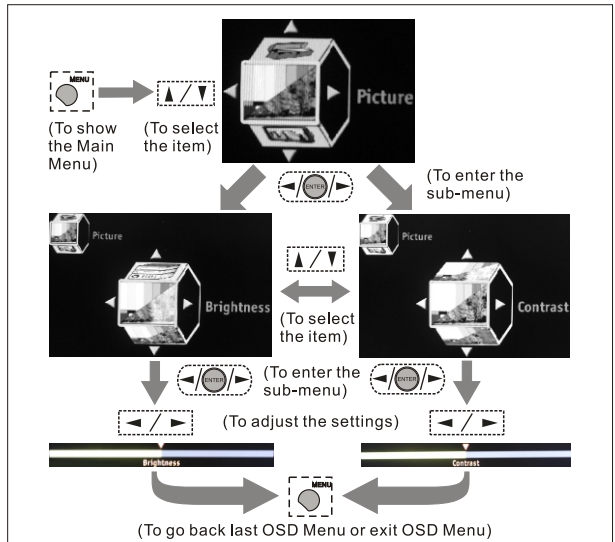

## ➤ Idea

### **Black Level Extender :**

Extends "grays" to black so a more accurate picture is produced with a wider contrast scale.

- \* **On** : To activate this function
- \* **Off** : To disable this function

### **NR(Noise Reduction) :**

Select Low/Medium/High to reduce noise.

- \* **Low** : To reduce parts of noise
- \* **Medium** : To reduce half of noise
- \* **High** : To reduce most of noise
- \* **Off** : Dynamic Noise Reduction is disable.

### **Flesh Tone :**

Most LCD TV's video processing solutions have a red push to the their color matrix. With the Flesh Tone Control option, it helps to tone down these strong reds and produce more naturalistic color tones.

- \* **On** : To activate this function
- \* **Off** : To disable this function

### **Adaptive Luma Control :**

Controls the luminance adaptively.

- \* **On** : To activate this function
- \* **Off** : To disable this function

### **Contrast Enhance :**

Enhances the contrast of the picture.

- \* **On** : To activate this function
- \* **Off** : To disable this function

### **White Peak Limiter :**

Limits the signal amplitude varying degree resulted in brightness over saturation.

- \* **On** : To activate this function
- \* **Off** : To disable this function

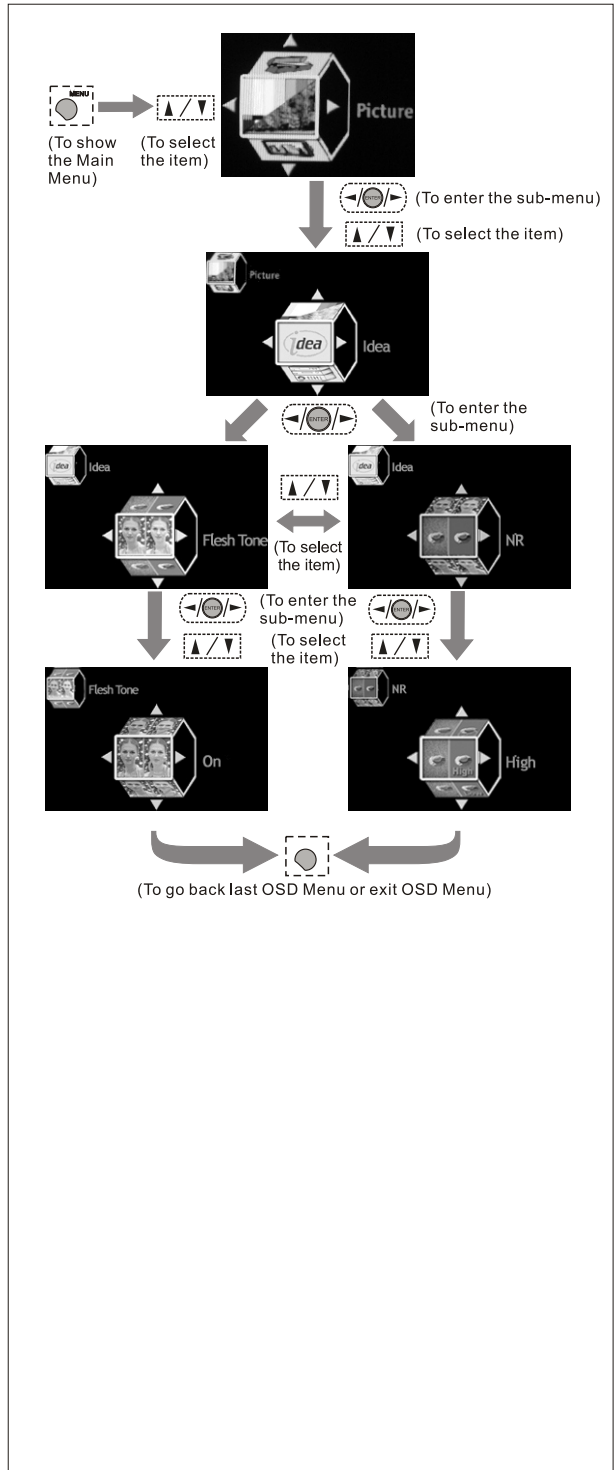

## Audio OSD Adjusting Sound Quality

### Description of Settings

Item	Adjustment	Function
Treble		It allows to adjust higher pitched sounds.
Bass		It allows to adjust lower pitched sounds.
Balance		It allows to adjust volume balance of the R/L speakers for the best stereo reproduction.
Language	English, Français, Español	There are three language formats available for program broadcasting.
MTS (Multi-channel Television Sound)	Mono, SAP, Stereo	It allows to select the sound reception of stereo, bilingual and mono programs between the TV Audio System.
Mute	On, Off	It allows to mute the sound.
Speaker	On, Off	It allows to turn On/Off the speakers of the TV when using a Receiver or Home Theater System.
iDIVA	Off, Rock, POP, Live, Classic, Soft, Concert, Living Room, Hall, Arena, Church	It allows to select the sound effect as occurred in an enclosed space of varying spaces.
Lip Sync		It allows to properly synchronize the audio and video.

### Adjusting the Audio Settings

In this Setup Index, you can adjust the audio settings to suit your personal preferences.

- **Treble**  
Decreases/Increases high pitch sounds.
- **Bass**  
Decreases/Increases low pitch sounds.
- **Balance**  
Adjusts volume to R/L speakers for the best stereo reproduction.
- **Language**  
There are three language formats available for program broadcasting. You may select from: English, Español, Français. (*Digital TV Channel Only*)
- **Mute**  
Mutes sounds.
- **Speaker**  
Turns TV speakers On/Off when using Home Theater System.

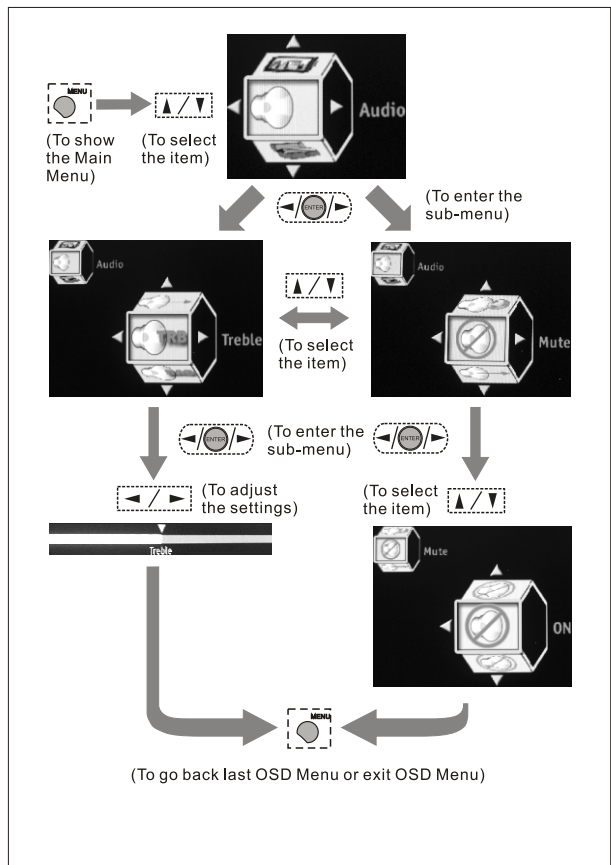

➤ **iDIVA**

It allows to select the sound effect as occurred in an enclosed space of varying spaces.

**Off** : To disable this function

**Rock** :

**POP** :

**Live** :

**Classic** :

**Soft** :

**Concert** :

**Living Room** :

**Hall** :

**Arena** :

**Church** :

➤ **Lip Sync**

When the sound and picture do not match and the sound is heard too early, use this setting to properly synchronize the audio and video.

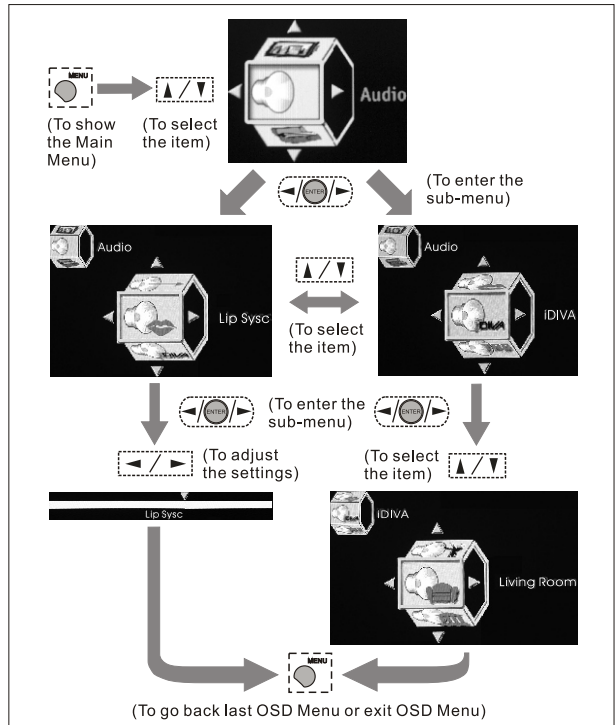

**MTS System for Stereo TV**

In this Setup Index, you can adjust the audio settings to suit your personal preferences.

➤ **MTS**

Toggles audio through Stereo, SAP and Mono.

**Mono** :

Selects Mono reception. (Uses to reduce noise during weak stereo broadcasts)

**SAP** :

Selects audio to Secondary Analog Program. (If no SAP signal is present, the TV remains in Stereo Mode)

**Stereo** :

Selects Stereo reception when viewing a program.

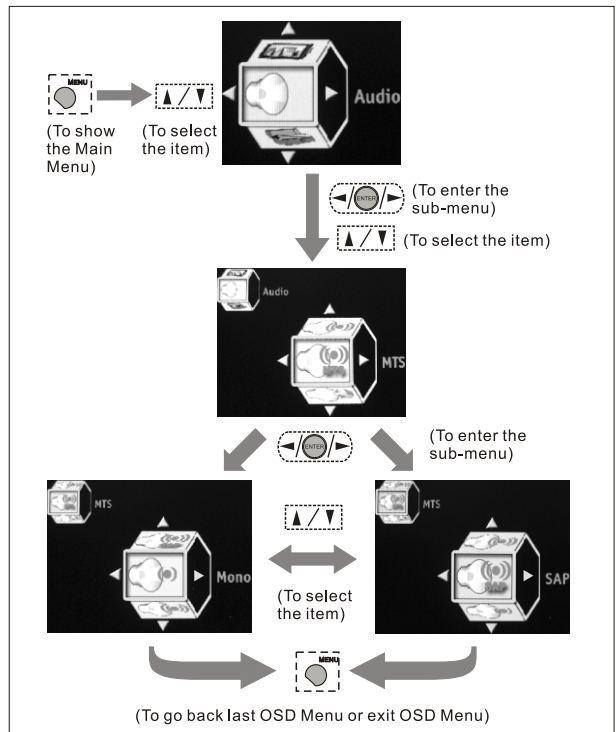

## Screen OSD Adjusting Screen Modes

### Description of Settings

Item	Adjustment	Function
<b>Adjustment</b>		
H.Position		It allows you to adjust the picture position horizontally.
V.Position		It allows you to adjust the picture position vertically.
Fine Tune		It allows you to enhance the picture quality.
<b>Auto Sync</b>		
Aspect Ratio	Aspect, Full Screen, Panoramic, Zoom 1, Zoom 2, 1:1 Mode	It allows you to select the aspect ratio of the picture you are watching.
Cropping	On, Off	Crops image and then enlarges it to fill the screen.
View	Full Screen, PIP, Split Screen	It allows you to select the view types of picture modes.
PIP Position	Low Right, Low Left, Upper Right, Upper Left	It allows you to change the position of Picture 2.
PIP Size	Small, Medium, Large	It allows you to change the size of Picture 2.
Swap		It allows you to switch the position of Picture 1 and Picture 2.
Main Picture Source	Tuner, Composite1/2, S-Video1/2, Component1/2, HDMI, VGA, VGA-Component	It allows you to select the main picture or video source you want to view.
Sub Picture Source	Tuner, Composite1/2, S-Video1/2, Component1/2, HDMI, VGA, VGA-Component	It allows you to select secondary picture or video source you want to view.

### Changing the Screen Mode

In this Setup Index, you can adjust the screen settings to suit your personal preferences.

#### ➤ Adjustment (Analog Source Only)

Adjusts the picture position and its quality.

##### **H.Position :**

Moves the picture left and right in the "Full Screen, Panoramic, and Zoom" modes.

##### **V.Position :**

Moves the picture up and down in the "Full Screen, Panoramic, and Zoom" modes.

##### **Fine Tune :**

Enhances picture quality by reducing horizontal flickering.

##### **Auto Sync :**

Adjust the image to its best position and automatically displays on the screen. (VGA mode only)

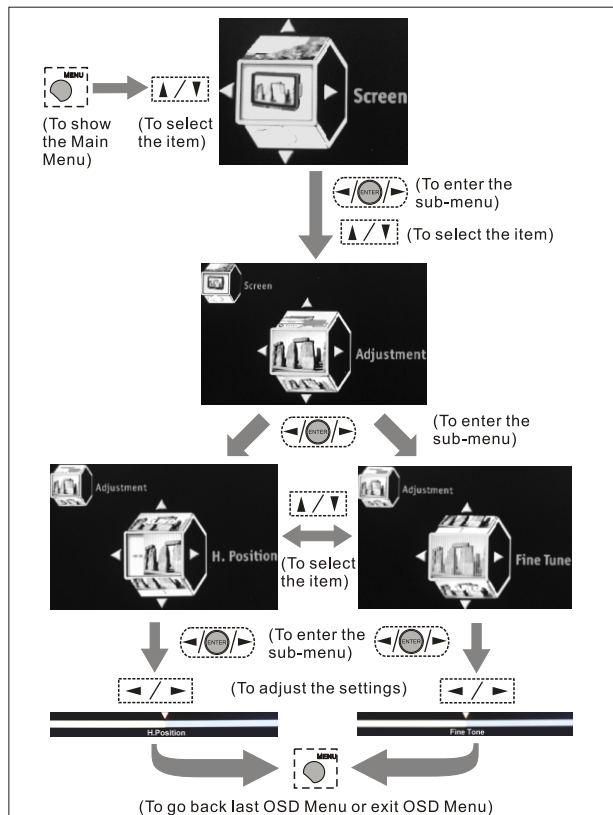

### ➤ Aspect Ratio

It allows you to select the aspect ratio of the picture you are watching.

**Aspect :**

Toggles picture between 16:9 / 4:3 aspect ratio.

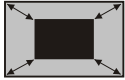

**Full Screen :**

Enlarges a 4:3 picture to fill the 16:9 screen.

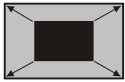

**Panoramic :**

Enlarges a picture from 4:3 to 16:9 by stretching it horizontally.



**Zoom 1 :**

Stretches the image both horizontally and vertically.



**Zoom 2 :**

Stretches the image both horizontally and vertically, which will lose part of the image on both ends.



**1:1 Mode :**

Returns the image to its original mode.



### ➤ Cropping

Crops image and then enlarges it to fill the screen.

*(Note: This feature helps remove any noise visible under both vertical and horizontal edges of the image.)*

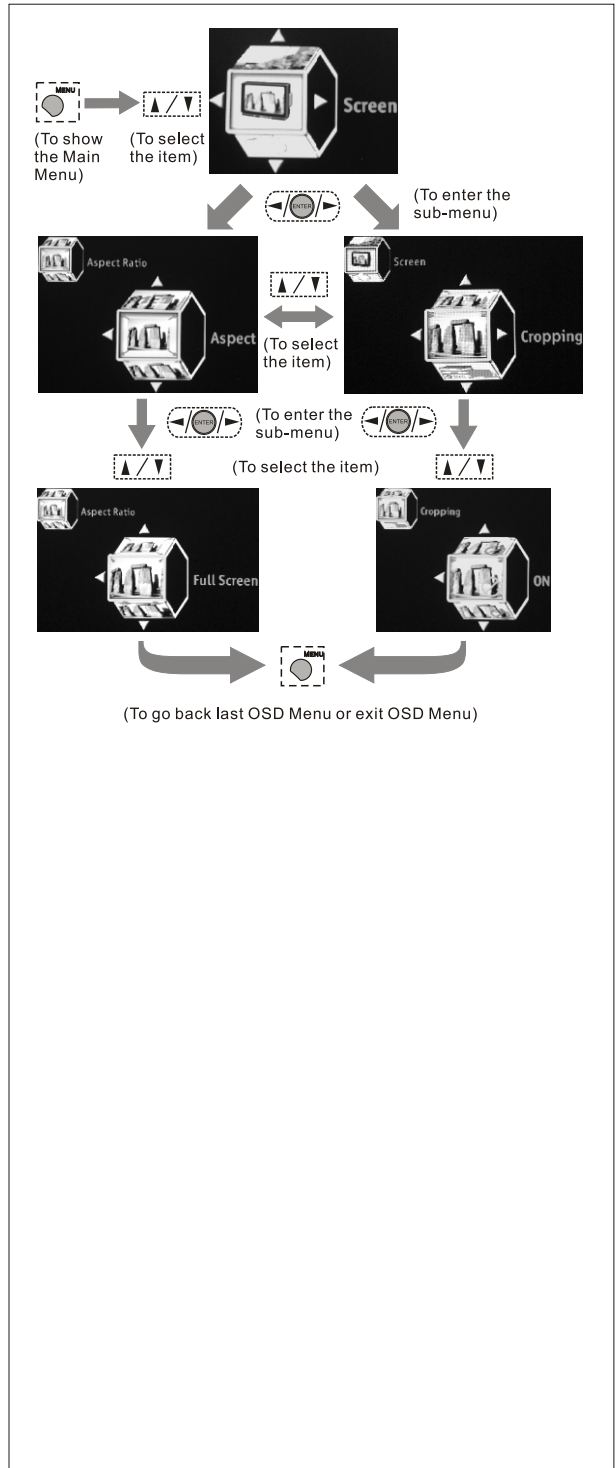

➤ **View**

You can select three view types of picture modes that best suits the program you are watching. You can set a different view mode for each video mode for each input and store it manually.

**Full Screen :**

Enlarges the image to full the screen.

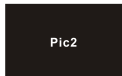

**PIP :**

Picture-in-Picture has a Main screen and small screen view.



**Split Screen :**

Full Screen splits in two Views.



➤ **PIP Position**

Changes the position of Picture 2 (small screen view).

**Low Right :**

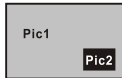

**Low Left :**



**Upper Right :**



**Upper Left :**



➤ **PIP Size**

Changes the size of Picture 2 (small screen view).

**Small :**

**Medium :**

**Large :**

➤ **Swap**

Switches the position of Picture 1 and Picture 2.

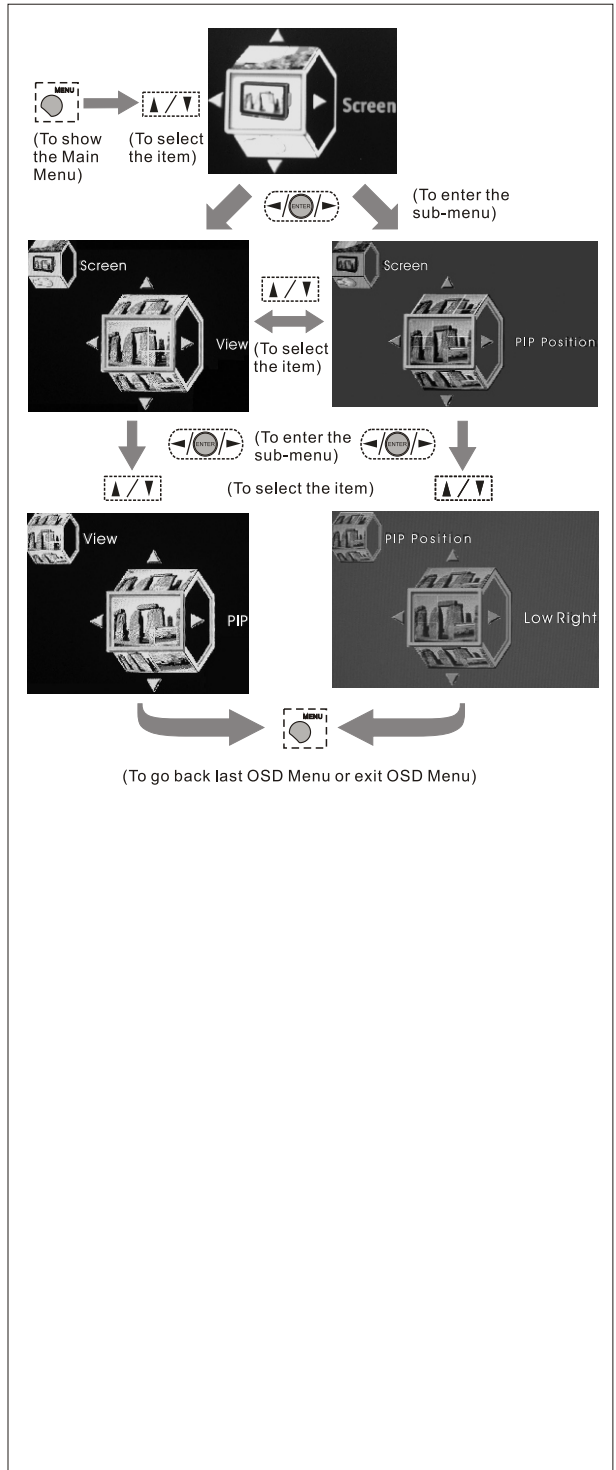

## Selecting the Picture or Video Source

In this Setup Index, you can select the input source of the picture or video you want to view.

### ➤ Main Picture Source

It allows you to select and view the main picture or video source from optional video equipment connected to this unit by selecting the appropriate input source.

**Tuner :**

**Composite 1/2 :**

**S-Video 1/2 :**

**Component 1/2 :**

**HDMI :**

**VGA :**

**VGA-Component :**

*(NOTE : While selecting "TV" as Pic 1 (Main) source, the other available sources except "TV" can be selected as Pic 2 (Sub) source.)*

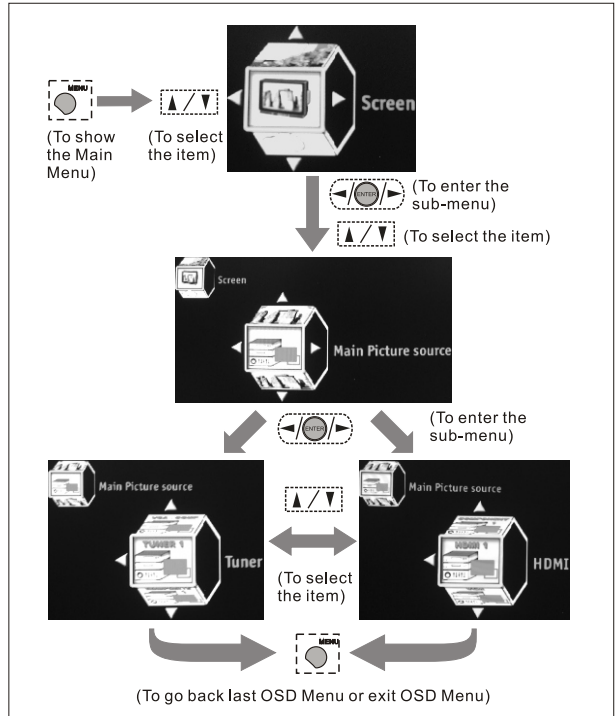

### ➤ Sub Picture Source

It allows you to select and view the secondary picture or video source from optional video equipment connected to this unit by selecting the appropriate input source. *(In PIP and Split Mode Only)*

**Tuner :**

**Composite 1/2 :**

**S-Video 1/2 :**

**Component 1/2 :**

**HDMI :**

**VGA :**

**VGA-Component :**

*(NOTE : While selecting "TV" as Pic 2 (Sub) source, the other available sources except "TV" can be selected as Pic 1 (Main) source.)*

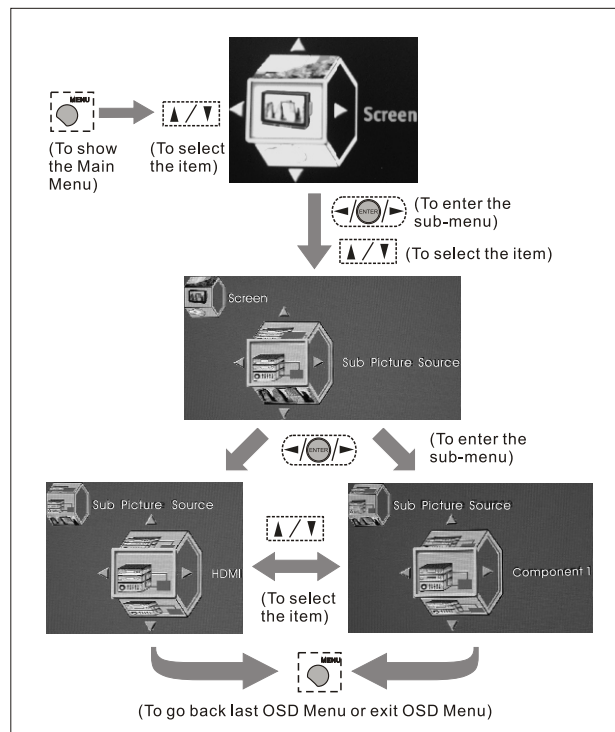



## Setup OSD Adjusting Personal TV Settings

### Description of Settings

Item	Adjustment	Function
<b>TV</b>		
Channel Setup	Favorite, Skip, Name	It allows you to set up Channel functions.
Auto Channel Search	Cable Standard, Air	It can auto scan the available channels of the TV or CATV.
Channel Add		It allows you to add channels to your favorite channel list.
Closed Caption		It allows you to select the Closed Caption type shown on the TV program.
Analog Type	CC1~4, T1~4	
Digital Type	Off, CS1~6	
Font	As Broadcaster, Stype1~7	
Size	As Broadcaster, Large, Medium, Small	
Font Color	Black, White, Green, Blue, Red, Cyan, Yellow, Magenta	
Background Color	Black, White, Green, Blue, Red, Cyan, Yellow, Magenta	
<b>Parental Control</b>		
Enter Password		
Rating	On, Off	
MPAA Rating	G, PG, PG-13, R/NC-17, X	
Block Unrating	On, Off	
TV Rating	TV-Y, TV-Y7, TV-Y7-FV TV-G, TV-PG(V,S,L,D), TV-14(V,S,L,D), TV-MA (V,S,L)	
Canada English Rating		
Canada French Rating		
Channel Block		
Change Password		
Timers	Sleep, Timer # 1, Timer # 2	It can be set to turn on / off the TV automatically at the set time.
Date and Time		It allows you to set the information of "Date and Time".
Menu Timeout	10, 20, 30	It can be set to shut off the TV automatically after a preset period of time has passed.
Language	English, Français, Español	It allows you to set the OSD Menu language.
DPMS	On, Off	TV and Backlight will shut off automatically when no video source is detected when DPMS is active.
Factory Settings		It can reset all parameters in OSD Menu Mode for all input sources.
Factory Settings by Input		It can reset all parameters in OSD Menu Mode for the source you select currently.
Firmware Version		

## Searching the TV Channels

In this Setup Index, you can pre-search all channels before watching the programs.

### ➤ Auto Channel Search

Will scan and preset all receivable channels automatically.

#### **Cable :**

Selects cable if using tuner as the input.

- \* Auto
- \* Standard
- \* HRC
- \* IRC

#### **Air :**

Selects air if using antenna.

*(NOTE: The Auto Scan is set to scan cable TV channels by default. You cannot receive and set the cable TV channels and VHF/ UHF channels at the same time.)*

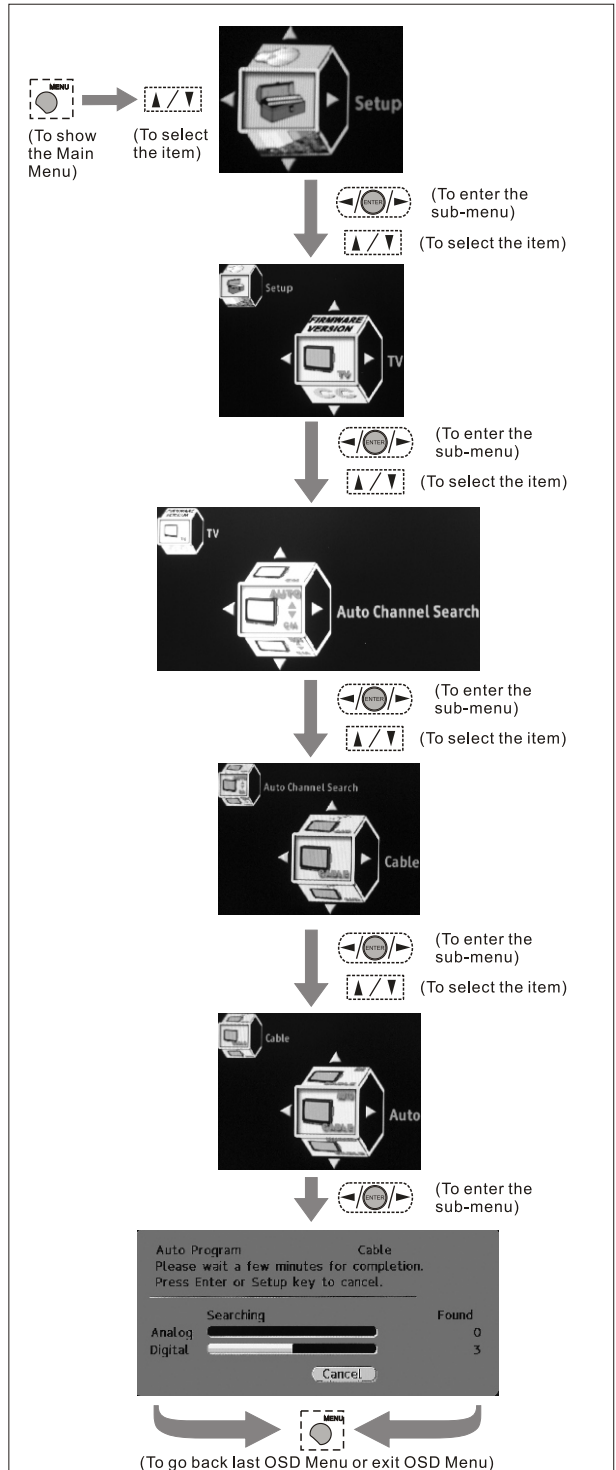

## Editing Channels

In this Setup Index, you can edit channels to suit your personal preferences.

### ➤ Channel Setup

Will scan and preset all receivable channels automatically.

### **Favorite :**

Selects and stores a list of favorite channels.

Browses through favorite channels by pressing Hotkey "FAVORITE".

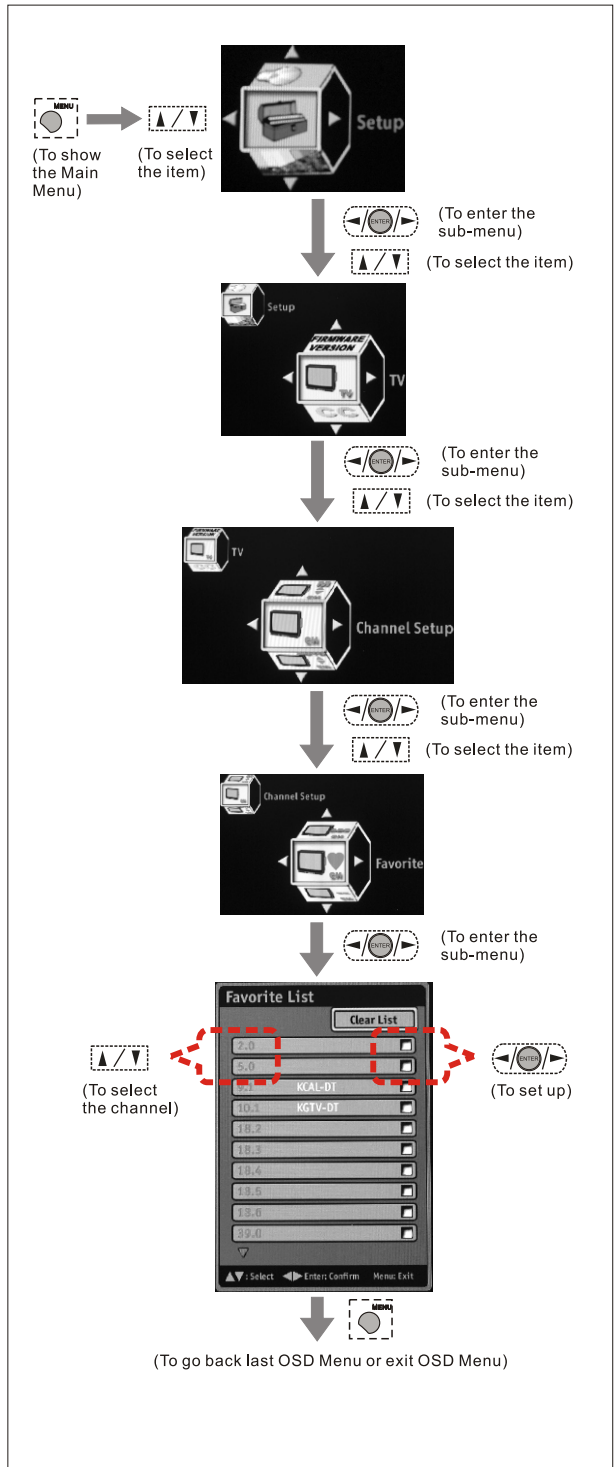

**Skip :**

Skips channels from viewing.

*(NOTE: Once this function is set, the skipped channels will not be displayed after searching. If you wish to view later, enter the channel number by pressing the numeric keys on the remote control.)*

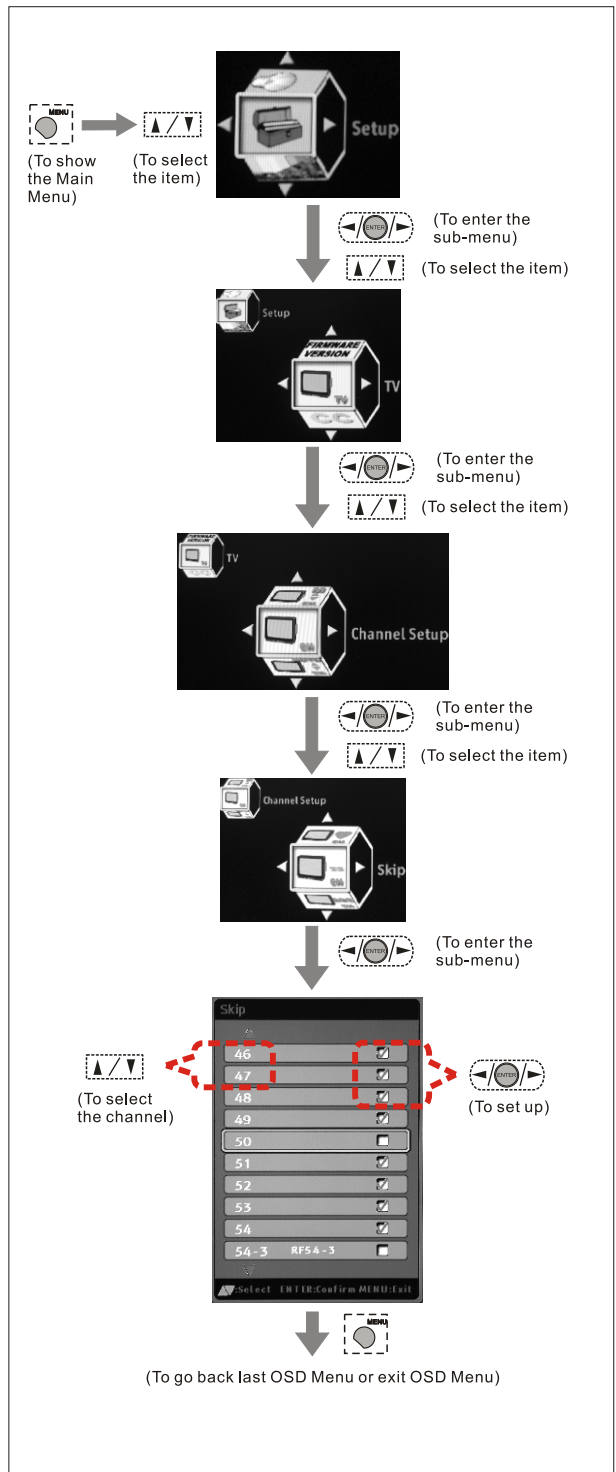

**Name :**

Creates a personal name for each channel.  
(Analog TV Channel Only)

Name will appear in the upper-right corner of the screen.

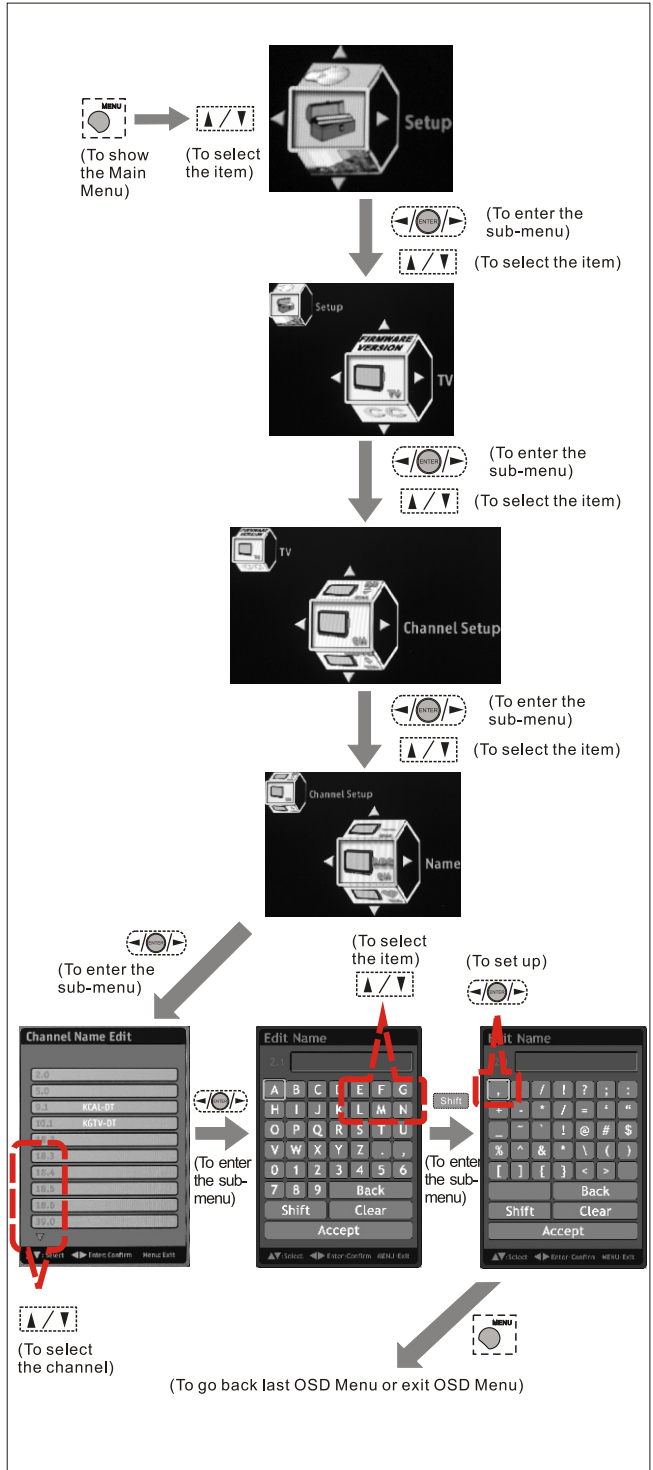

➤ **Channel Add :**

Adds channel currently on display to the FAVORITE channel list.

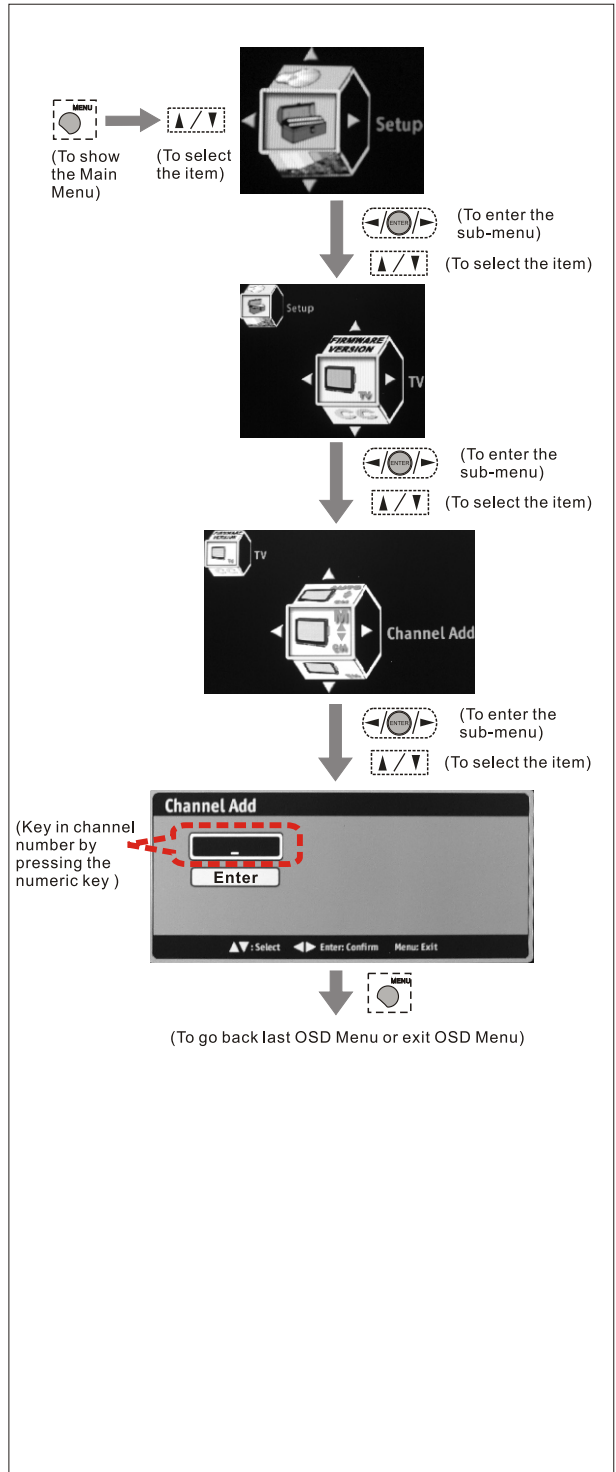

## Closed Caption Options

Displays the audio portion of a television signal as text on the television screen.

### ➤ Analog Type

If there is Closed Caption data shown on the analog TV channel, you can select your preferred Closed Caption type by scrolling through CC1~4, T1~4.

**CC1** : is used for most programs

**CC2** : may be used for alternate languages

**Text** : is used for network and station information, such as channel guides, schedules, or bulletin board, for Closed Caption programs.

### ➤ Digital Type

Selects preferred Close Caption type by scrolling through CS1 - 6.

### ➤ Font

Selects preferred font by scrolling through As Broadcaster, Style 1-7. *(Digital TV Channel Only)*

### ➤ Size

Selects preferred font size by scrolling through As Broadcaster, Large, Medium, Small. *(Digital TV Channel Only)*

### ➤ Font Color

Selects preferred font color by scrolling through As Broadcaster, Black, White, Green, Blue, Red, Cyan, Yellow, Magenta. *(Digital TV Channel Only)*

### ➤ Background Color

Selects preferred background color by scrolling through As Broadcaster, Black, White, Green, Blue, Red, Cyan, Yellow, Magenta. *(Digital TV Channel Only)*

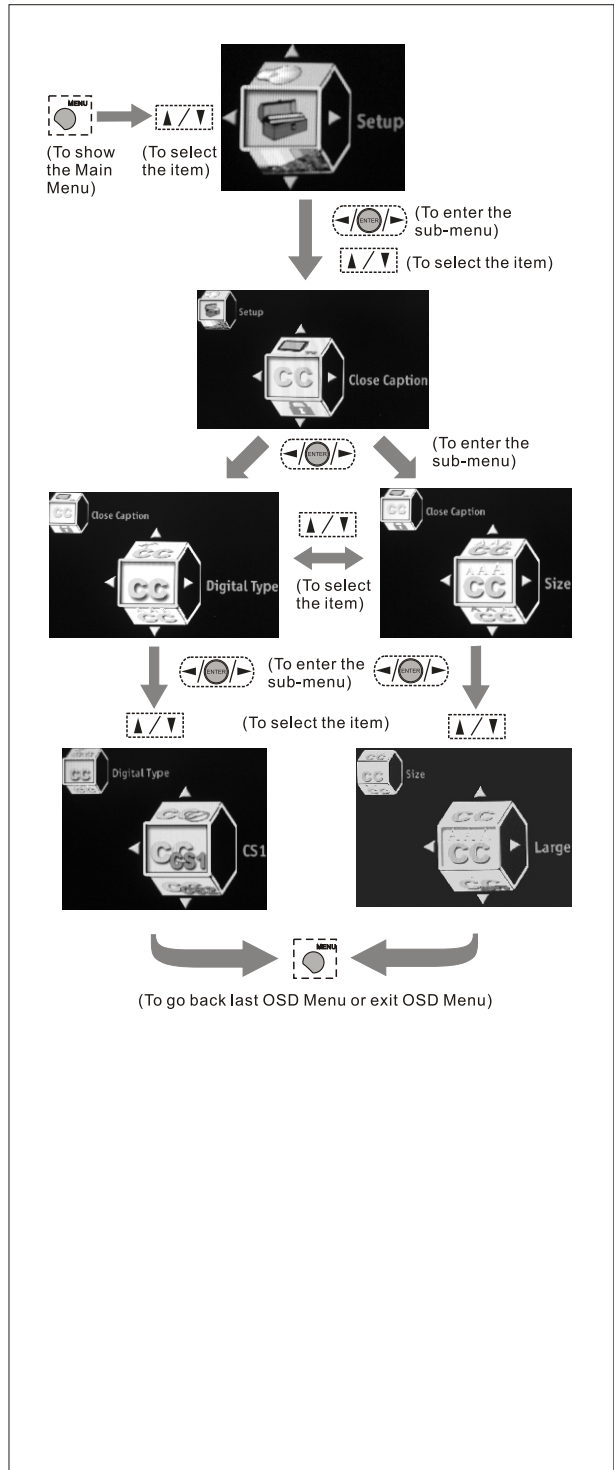

## Setting up Parental Control Password

This function allows programs to be restricted and controlled by parents.

### ➤ Enter Password

Password is necessary to enter and re-enter the Parental Control Menu screen.

*(NOTE: The Factory Default password is "314159".)*

## Activating the Parental Control Feature

Blocks programs based on programming rating system.

The TV Parental Control features by receiving the rating signal from your local broadcasting station or cable service provider.

### ➤ Rating

- \* **On-** To activate rating function
- \* **Off-** To disable all of rating functions

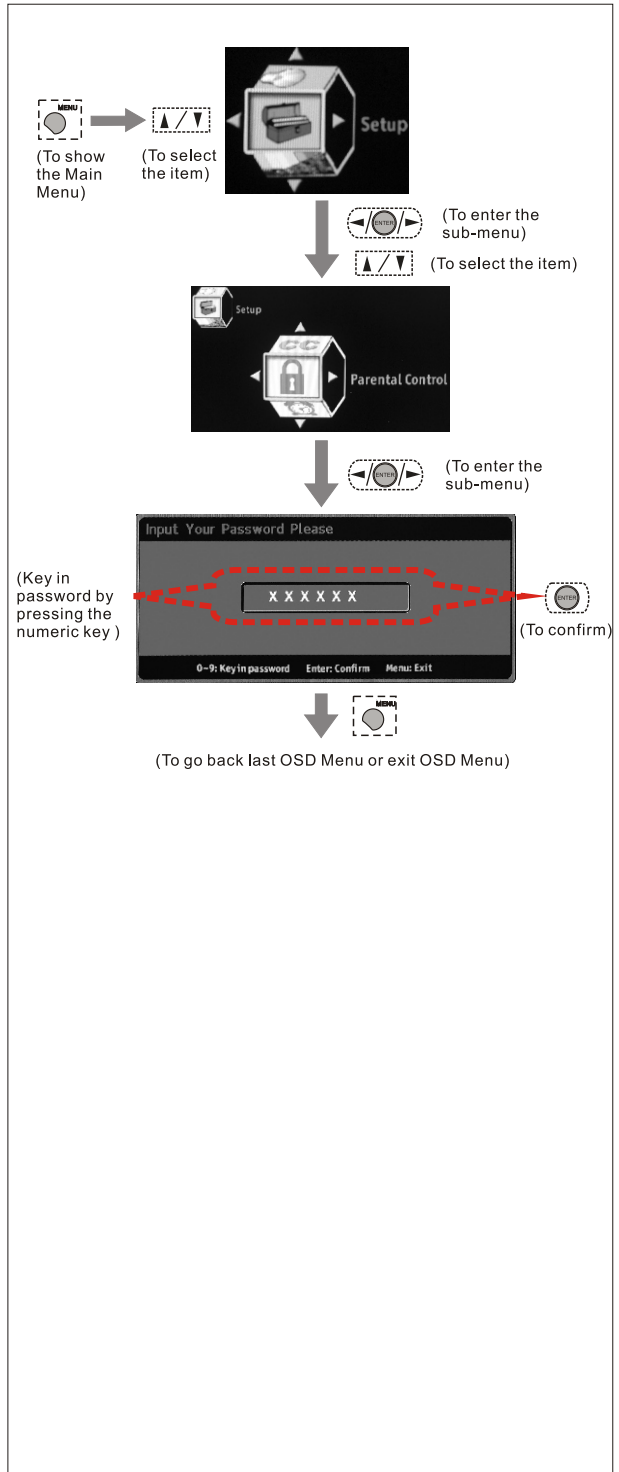



## ➤ MPAA Rating

Motion Picture Association of America provide movie ratings, including those shown on TV.

**G** : (General Audience) No restriction.

**PG** : (Parental guidance suggestion)  
Children under 13 should be accompanied by an adult.

**PG-13** : (Parents strongly cautioned)  
Children under 13 should be accompanied by an adult.

**R** : (Restricted) Viewers should be 17 or older.

**NC-17** : (Not classified) Viewers should be 17 or older.

**X** : (Adults only)

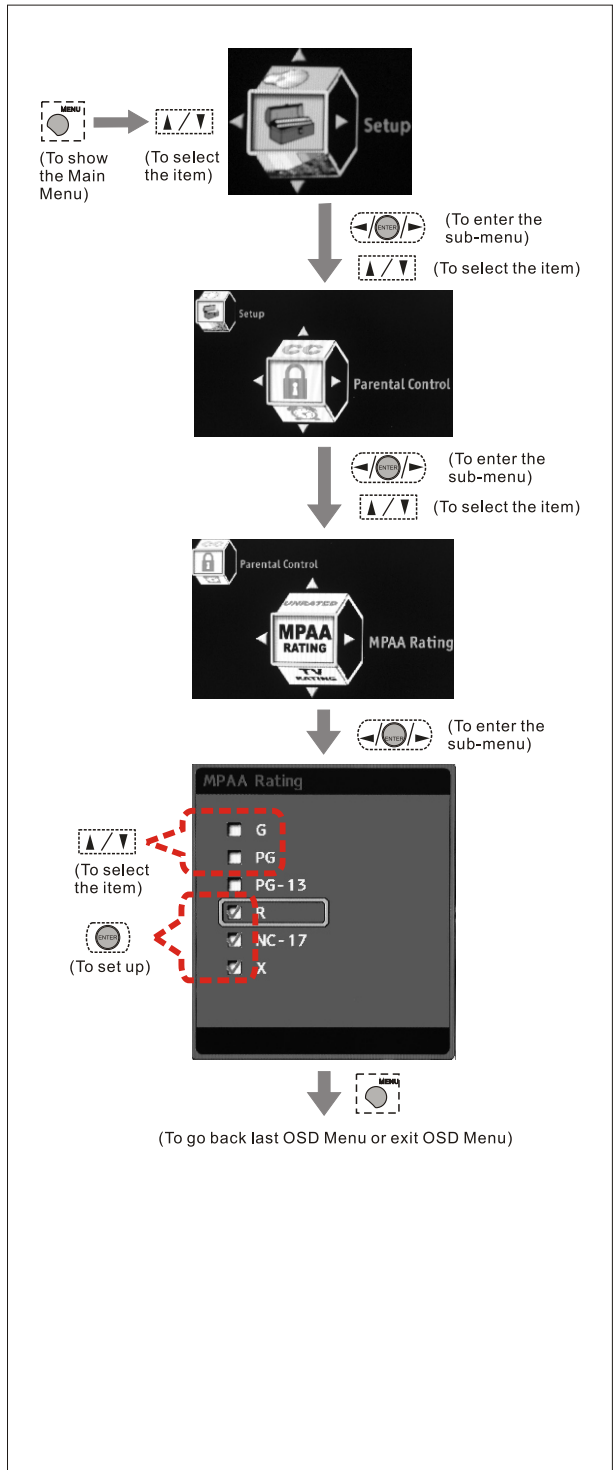

➤ **TV Rating**

U.S. TV ratings are for TV programs rated according to the U.S. Television Parental Guidelines.

**TV-MA/V/S/L** : (Mature audiences only)

**TV-14/V/S/L/D** : (Parents strongly cautioned)

**TV-PG/V/S/L/D** : (Parental guidance suggested)

**TV-G** : (General audience)

**TV-Y7/FV** : (Directed to children under 7 or older)

**TV-Y** : (All children)

*(NOTE: When you block the lower rating, the higher age-based ratings are blocked automatically.)*

➤ **Block Unrating**

You may select "On" for MPAA Unrated and TV Unrating. This allows you to block programs and movies that are broadcast without a rating.

To watch unrated channels, re-activate MPAA Unrated and TV Unrating to "Off".

*(NOTE: The unrated option is available only when you have selected U.S.A. as your country/region.)*

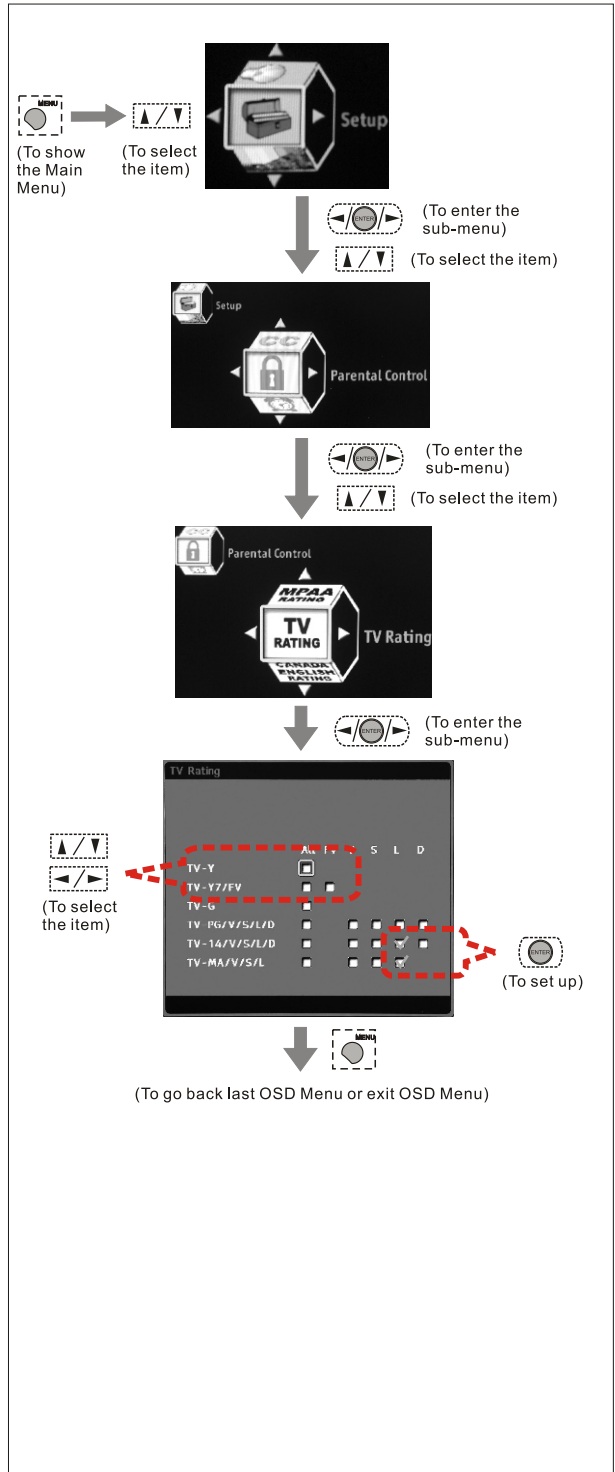

### ➤ Canada English Rating

It is available for TV programs in English broadcast in Canada.

**E :**

**C :** (Intended for children under 8)

**C8+ :** (Generally considered acceptable for children aged 8 and older to watch on their own)

**G :** (General Audience)

**PG :** (Parental Guidance) Parents may consider some content inappropriate for unsupervised viewing by children aged 8-13.

**14+ :** (Not suitable for viewers under the age of 14)

**18+ :** (Adult)

*(NOTE: When you block the lower rating, the higher age-based ratings are blocked automatically.)*

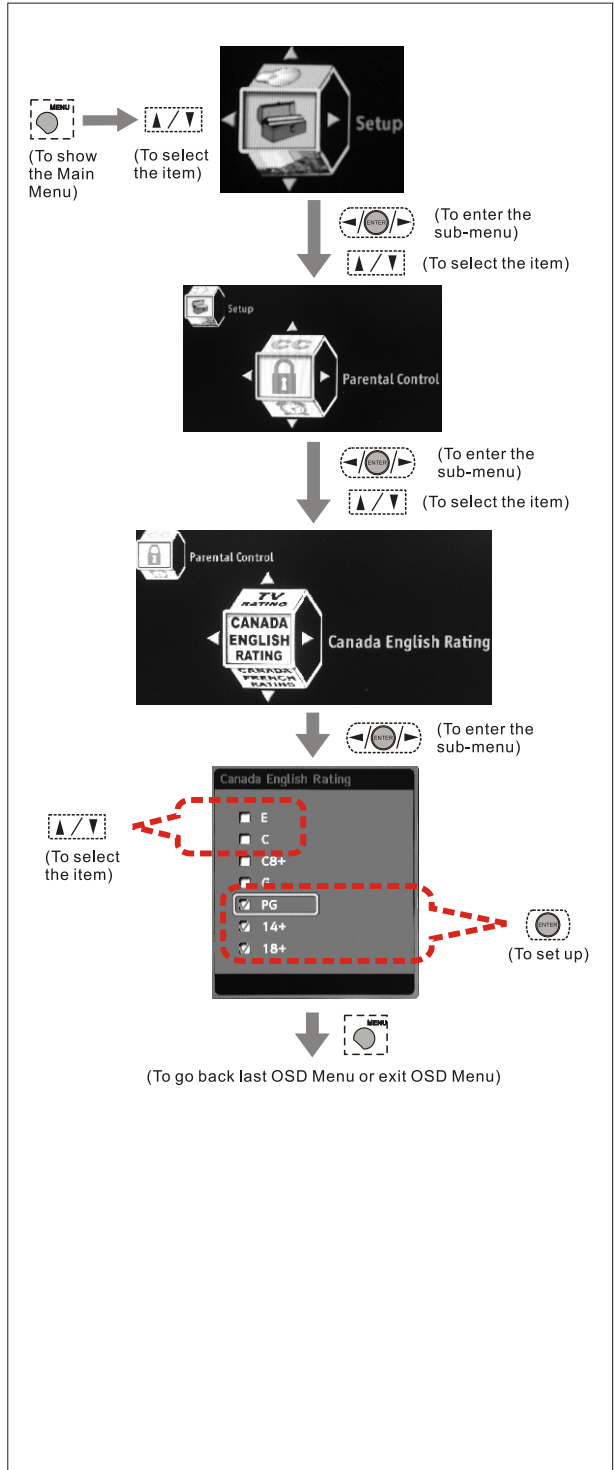

### ➤ Canada French Rating

It is available for TV programs in French broadcast in Canada.

**E :**

**G :** (General Audience)

**8 ans+ :** (8+ General--Not recommended for young children under the age of 8)

**13 ans+ :** (Not suitable for children under the age of 13)

**16 ans+ :** (Not suitable for children under the age of 16)

**18 ans+ :** (Restricted to adults)

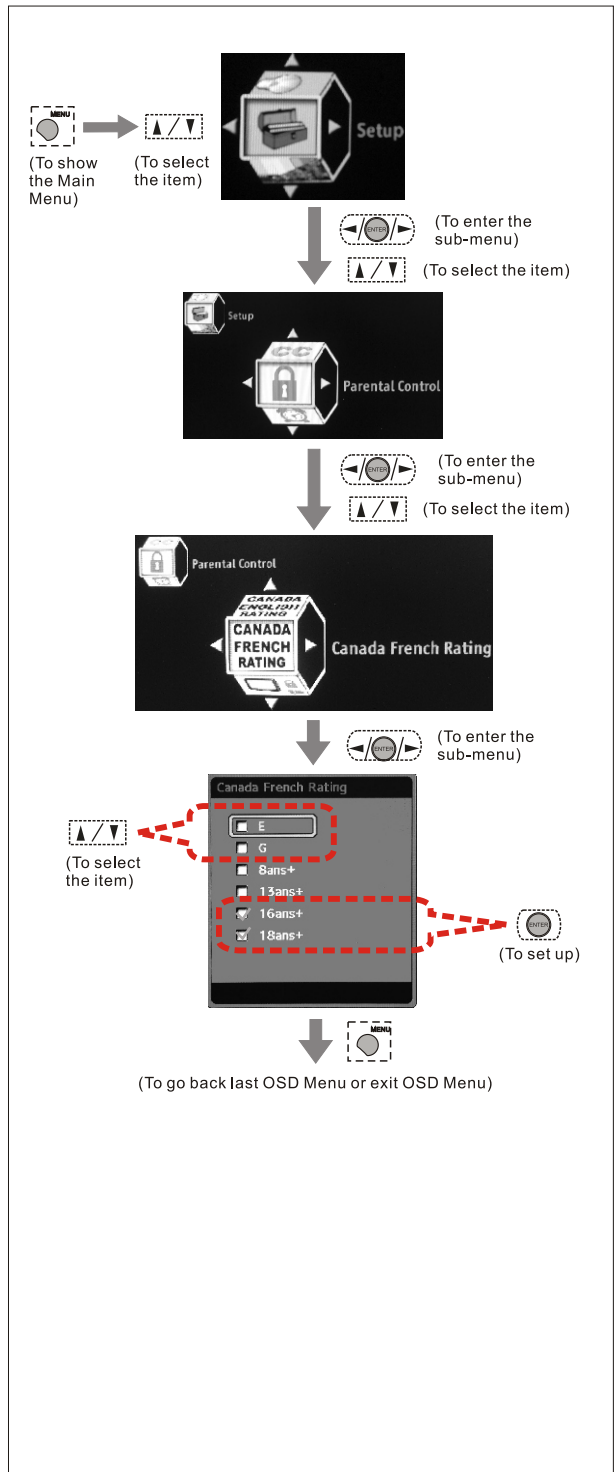

### ➤ Channel Block

In this Setup Index, you may select the blocked ratings to suit your personal preferences.

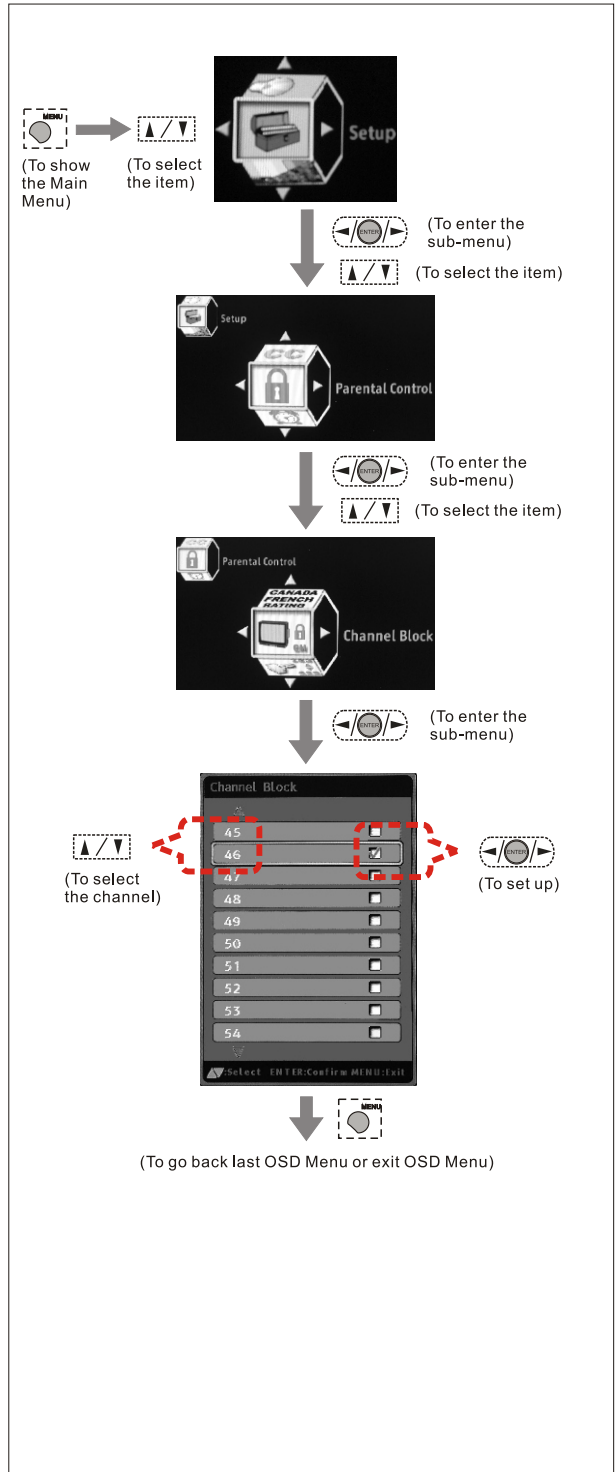

## Resetting the Password

### ➤ Change Password

You may change to a new preferred password by pressing the numeric key within 6 numbers.

*(NOTE: The Factory Default password is "314159".)*

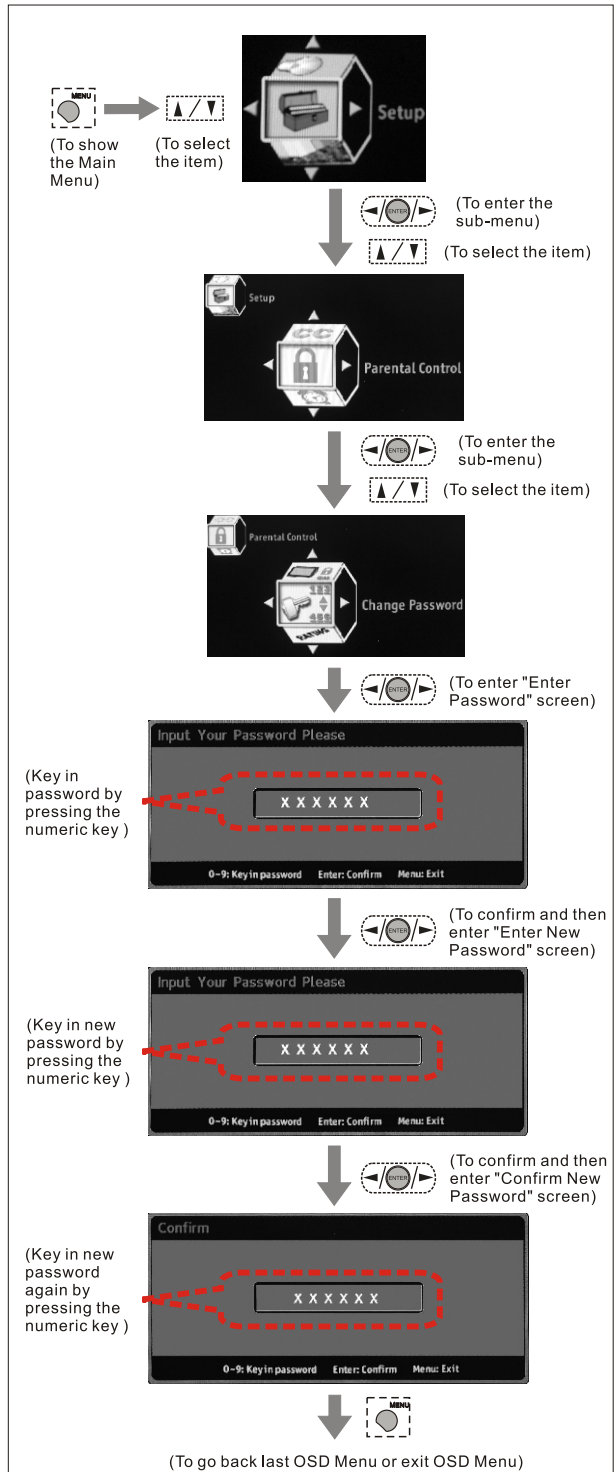

## Setting the Date and Time

### ➤ Date and Time

In this Setup Index, you can setup the Date, Week, Time Zone, and Current Time on the TV.

#### **Date :**

Date is set automatically when NTSC source is used. (Manual adjustment is necessary however, if not used)

#### **Week :**

It will be automatically displayed according to the Date setting.

#### **Time Zone :**

You can select available time zone where you live.

#### **Current Time :**

Time is set automatically when NTSC source is used. (Manual adjustment is necessary however, if not used)

#### **Daylight Savings :**

Option will be selected automatically based on settings above.

#### **Auto Calibration :**

Once activating this function, the information of "Date and Time" will be corrected automatically based on accurate time.

*(NOTE: Once marking the "Auto Calibration" setting, all settings shown on the "Date and Time" screen will be invalid.)*

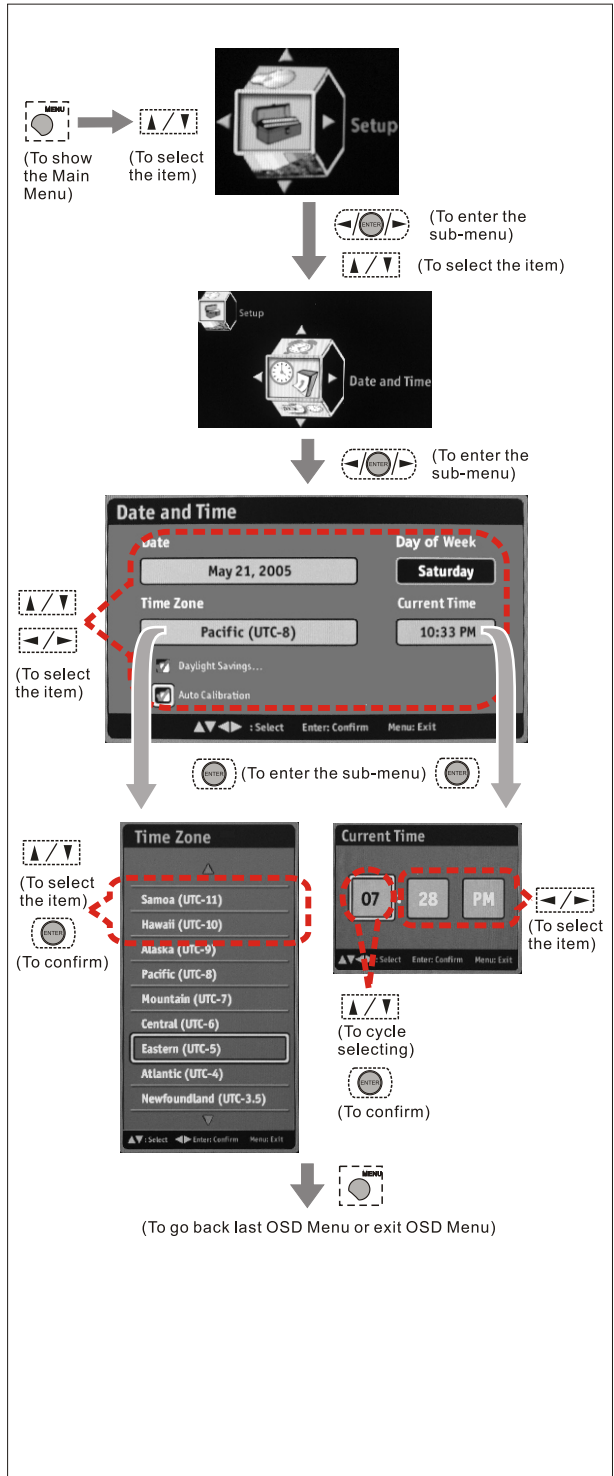

## Setting the TV Timer

### Timers

In this Setup Index, you can setup the Sleep Time, Start Time, and Stop Time on the TV.

#### Sleep :

Shuts off TV after a preset period of time has passed by scrolling through 30, 60, 90, 120 minutes.

#### Timer # 1 :

Turns display on/off at a set time by entering Week, Start time and Stop time.

#### Timer # 2 :

You can set another unit of timer.

*(NOTE: Please preset the "Date and Time" before setting the "Timer # 1 and 2" functions.)*

*(NOTE: If the "Timer # 1" and "Timer # 2" settings are overlap, they will be combined to be one.)*

*(NOTE: If the "Stop Time" is less than the "Start Time", the setting will be carried over to the next day.)*

## Timeout Settings for OSD Menu

### Menu Timeout

In this Setup Index, you can setup the OSD Menu display time before disappeared when no action is taken.

1. Press the ▲▼ button to select 10, 20, or 30 second.
2. Press the "ENTER" button to confirm.

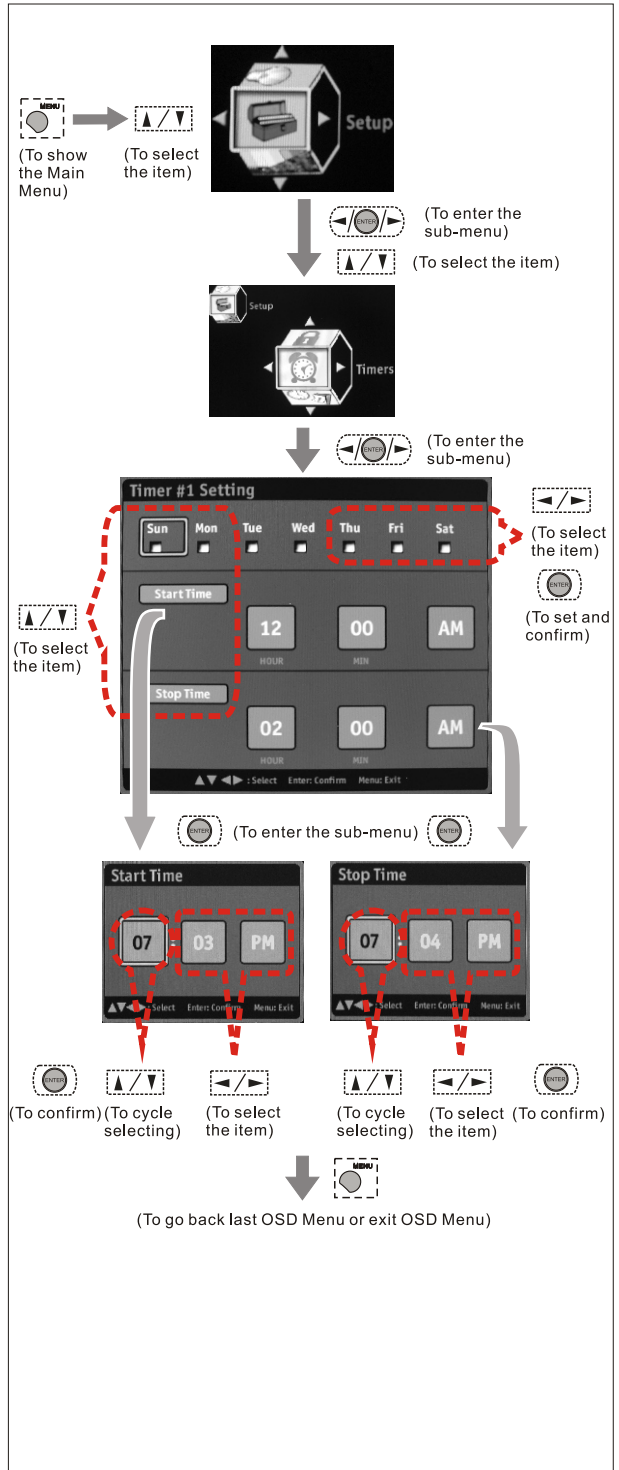



## TV OSD Languages

### ➤ Languages

There are three language formats available for the OSD Menu. You may select it doing the following: English, Français, Español.

## Setting DPMS

### ➤ DPMS

TV and Backlight will shut off automatically when no video source is detected when DPMS is active.  
(VGA Source Only)

- \* **On-** To activate this function
- \* **Off-** To disable this function

## Factory Default Option

### ➤ Factory Settings

You can reset all OSD settings to original manufacture settings for all input sources.

### ➤ Factory Settings by Input

You can reset all OSD settings to original manufacture settings for the source you select currently.

## Displaying the Firmware Version

### ➤ Firmware Version

You can see the firmware version here that installed in the HDTV unit.

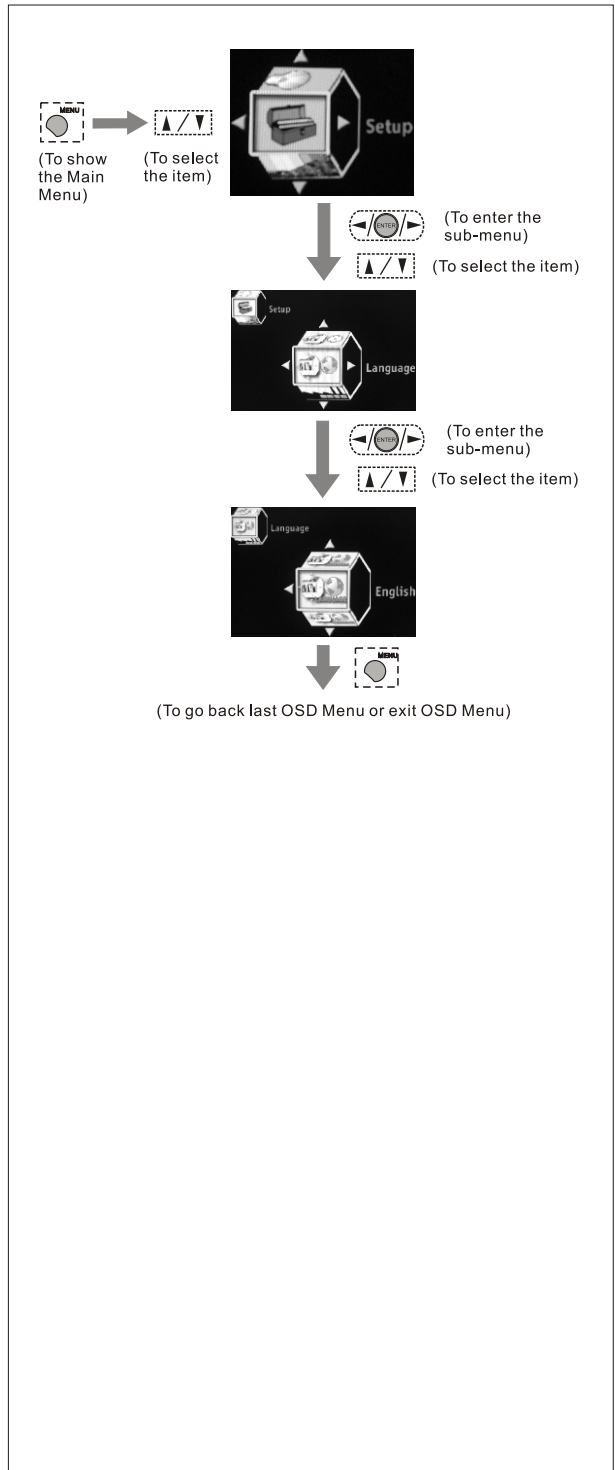

# Specifications

## TFT LCD Panel

Specifications			
Panel Size	37"	40"	42"
Aspect Ratio	16:9	16:9	16:9
Pixels	1366 X 768	1366 X 768	1366X768
Dynamic Contrast Ratio	800:1	1200:1	1000:1
H/V(View Angle)	178 ° (H) / 178 ° (V)	178 ° (H) / 178 ° (V)	176 ° (H) / 176 ° (V)
Gray to Gray Response Time	9 ms	8 ms	10 ms
Video/Graphic Processing			
PC Compatible Frequency	30~85 KHz(H) / 50~80Hz(V)Max. 1360x768 @60Hz		
Video Compatibility	NTSC		
DTV & HDTV Compatibility	480i, 480p, 720p, 1080i		
Aspect Ratio Adjustment	1:1, Aspect, Full Screen, Panoramic, Zoom 1, Zoom 2		
3D Comb Filter	Y		
3 : 2 / 2 : 2 Pull Down	Y		
Digital Noise Reduction	Y		
Adjustable Color Temperature	Native, 6500, 6500-User, 9300, 9300-User		
De-interlacer	Y		
VGA Auto Frequency Correction	Y		
TV Auto Frequency Detection	Y		
Audio Processing			
Auto Sound Level Control	Y		
Output Watt	2 (15W + 15W)	2 (20W + 20W)	
Sound Effect	MTS (Mono / Stereo / SAP)		
Input Terminals			
TV Tuner	Combo RF (NTSC/ ATSC) Tuner x1		
Video Input	Composite x1, S-Video x1, Y/Pb/Pr, Y/Cb/Cr x1, R/L x3		
HDTV & VIDEO Input	VGA/Component3 x1, HDMI x1, R/L x2		
Service Port	RS232C Port (Mini DIN 6 Pins) x1, Firmware Upgrade Port (B Type) x1		
Output Terminals			
Audio Output	Coaxial&Optical x1, R/L x1, SubWoofer x1, Earphone x1		

\* **NOTE** : Product Specification is Subject to Change without Notice.

## TFT LCD Panel

Others	37"	40"	42"
Power (Voltage)	100~240 VAC / 50-60 Hz		
(Power Consumption)	271W		
Stand-by	< 1W		
Dimensions (W x D x H)	36.73 in x 10.24 in x 29.33 in	39.36 in x 13.8 in x 32.08 in	43.3 in x 13.8 in x 34.65 in
Carton Dimensions (W x D x H)	40.28 in x 11.46 in x 31.2 in	43.7 in x 15 in x 36.3 in	47.4 in x 14.44 in x 37.8 in
Weight w/o stand	50.72 lbs	70.56 lbs	80.48 lbs
Weight w/ stand	52.9 lbs	86 lbs	95.9 lbs
Gross Weight	62.84 lbs	103.64 lbs	106.94 lbs

## Dimensional Drawing

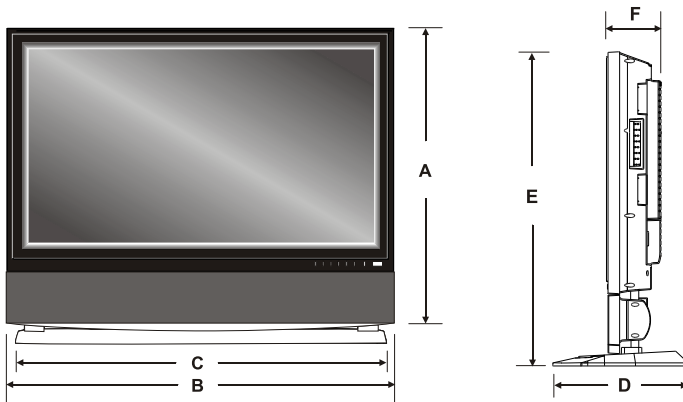

Model \ Size	A	B	C	D	E	F
37"	27.36 in	36.73 in	28.31 in	10.24 in	29.33 in	5.59 in
40"	30.67 in	39.36 in	37.64 in	13.80 in	32.08 in	5.55 in
42"	32.82 in	43.30 in	37.64 in	13.80 in	34.65 in	6.05 in

# Timing Mode for VGA and DVI

Source	Resolution	Vertical frequency (Hz)
YPbPr	480p	59.94
	720p	60
	1080i	30
VGA	640x480	60
		75
	800 x 600	60
		75
	1024 x 768	60
		75
	1280 x 768	60
	1280 x 1024	60
	1360 x 768	60
DVI	640 x 480	60
		75
	800 x 600	60
	1024 x 768	60
		75
	1280 x 720	60
	1280 x 768	60
	1360 x 768	60

# **Pixels Policy**

---

## **Syntax-Brilliant's D.O.A. Policy for LCD HDTVs for Defective Pixels on LCD Panels**

(Applicable to the LCD HDTV sold within USA & Canada only)

Syntax-Brilliant™ LCD HDTVs are evaluated at a distance of approximately 50 centimeters (approximately 20 inches) between the LCD panel and the eyes of the user at a 90 degrees viewing angle. All LCD panels have been tested to ensure they comply with our factory standards. Our evaluation is based on the number of defective pixels and the distance between any two defective pixels. Bright dots are dots that appear bright and unchanged in size when a LCD HDTV screen displays under a black pattern; dark dots are dots that appear dark and unchanged in size when a LCD HDTV screen is displayed under pure red, green, or blue patterns ("defective pixels"). Adjacent dots are dots located directly next to each other.

Customers are required to check their LCD panel immediately after purchase. To identify defective pixels, the LCD panel should be examined under normal operating conditions as mentioned above, preferably in its native display resolution, and with a 90 degrees viewing angle.

A LCD HDTV will be considered dead on arrival (D.O.A.) with regards to defective pixels on the LCD panel when any one of the following criteria is met:

- A total of 7 defective pixels including both bright dots and dark dots are present (the typical 30" LCD Television screen has 16.7 million pixels), or
- 2 or more pairs of adjacent bright dots are present, or
- 3 adjacent bright dots are present, or
- 3 adjacent dark dots are present.

In view of customers' concerns about dead pixels, Syntax-Brilliant™ would like to address that defective pixels are not ultimately avoidable with the current LCD industry standard panel manufacturing processes. We always strive to improve our technology and minimize the chance of occurrence of defective pixels by applying strict screening processes in our factory production processes. However, Syntax-Brilliant cannot guarantee that a return unit to our customers will be 100% free of defective pixels.

For questions, please call our toll free service number in the USA at 888-Syntax-Brilliant-8.

**"At Syntax-Brilliant™ Groups, a satisfied customer is our most important focus."**

# Glossary

**3:2 pull down** - Process of converting 24 frames per second film to video by repeating one film frame as three fields, then the next film frame as two fields.

1	1	1	2	2	1	1	1	2	2
---	---	---	---	---	---	---	---	---	---

**480I** - 480 lines of display every 1/60 of a second; image is displayed by interlace scanning. See also Interlaced

**480P** - 480 lines of display every 1/60 of a second; image is displayed by progressive scanning. See also Progressive.

**720P** - 720 lines of display every 1/60 of a second; image is displayed by progressive scanning. See also Progressive.

**1080I** - 540 lines of display x 2 every 1/30 of a second; image is displayed by interlace scanning. See also Interlaced

**16:9** - Aspect ratio under Hi Def. and theater movie formats. Also known as widescreen; see Aspect Ratio

**4:3** - Aspect ratio under SDTV; see Aspect Ratio

**Active Matrix TFT (Thin Film Transfer)** - A type of display technology where the three primary colors are modulated. Results in better contrast ratios suitable for video.

**Alarm** - Feature on the Syntax-Brilliant Olevia models. Allows the unit to power on from the stand by mode.

**Alarm Time** - Time specified as to when the unit will power on. See Alarm.

**Aspect Ratio** - The ratio of an image according to the width and height of a picture.

**ATSC** - Advanced Television Systems Committee; international, non-profit organization that is committed to developing standards for digital television.

Reference: <http://www.atsc.org>

**Bezel** - Refers to the plastic or metal frame that acts like a shell around the LCD glass.

**Backlight** - Refers to the component, that lights up the LCD display.

**Balance** - Feature on the OSD for the Syntax-Brilliant Olevia models that adjust the left and right sound output from the speakers.

**Background** - Feature on the OSD for the Syntax-Brilliant Olevia models, which allows the user to change the OSD background, display to transparent or opaque.

**Brightness** - The measurement of color that is illuminated. Colors range from black to white.

**CATV** - Community Antenna Television (Cable Television)

**Channel Favorite** - Feature on the OSD for the Syntax-Brilliant Olevia models that allows the user to scroll through a defined list of channels that the user sets up.

**Channel Edit** - Feature on the OSD for the Syntax-Brilliant Olevia models that allows the user add or delete a channel.

**Channel Source** - Feature on the OSD for the Syntax-Brilliant Olevia models that lets the user select the source of their channels. Select TV for antennae or CATV for cable television.

**Channel Auto Scan** - Feature on the OSD for the Syntax-Brilliant Olevia models that when initiated, will determine which channels are available and which are not. If a desired channel is not accessible, you can add the channel in manually. See Channel Edit.

**Channel Fine Tune** - Feature on the OSD for the Syntax-Brilliant Olevia models that enables the user to tune the channel for better reception.

**Chroma** - (Chrominance) Refers to the color characteristics of a video signal.

**CC** - Closed Caption

**Color** - The term refers to the amount of color present. This varies between each user, as each person perceives colors differently.

**Color Temperature** - Feature on the OSD for the Syntax-Brilliant Olevia models that enables warm, normal or cool color settings. Warm emphasizes red, cool emphasizes blue, and normal doesn't emphasize any of the primary colors. This setting may affect each person individually depending on how color is perceived.

**Comb Filter** - A filtering system designed to removal unwanted artifacts by rejecting certain frequencies while permitting others.

**Component** - A three RCA type input that uses high quality cables (one for brightness, and two for color). Process increases bandwidth resulting in more color information to be carried to the TV producing a more accurate picture.

**Composite** - Also known as CVBS, Technology that permits the combination of color information and brightness under one wire. A single video signal that carries both brightness and color information are contained in a single wire.

**Contrast** - Difference in luminance between the white and black colors.

**CRT** - Cathode Ray Tube.

**DB15** - Also referred to as VGA; See VGA

**De-Interlace** - Process of converting an interlaced video signal.

**Display Area** - The perimeter of the LCD glass the image is displayed on. See Video Resolution

**Dual Link** - See Single Link; Supports a maximum bandwidth of 2 x 165 MHz (1920 x 1080 @ 60 Hz, 1280 x 1024 @ 85 Hz).

**DVI** - Digital Video Interface Describes the technology that is used to take full advantage of a signal when paired with a high-end video card and flat panel displays

**DVI-A** - Digital Video Hi-Resolution Analog

**DVI-D** - Digital Video Interface Digital; Cable is used for direct connection from one digital source to the TV; See DVI

**DVI-I** - Digital Video Interface Integrated; Cable that supports analog and digital signals; See DVI

**DTV** - Digital Television

**Factory Default** - Feature on the OSD for the Syntax-Brilliant Olevia models that resets all menu options to factory default.

**F-Connector** - The standard connector found on video equipments that coaxial cables connect to.

**Flat-Panel Display** - ultra thin displays, usually found in notebooks are now entering the TV appliances sector as new technology enables wider/larger screens.

**Frame** - A complete picture that includes both even and odd lines. 30 video frames are present in 1 second.

**Gain** - Describes the amplification level of a particular signal.

**HDCP** - High bandwidth Digital Content Protection

**HDTV** - 1.High Definition Television 2. Designates as the unit having a built in ATSC tuner to decode High Definition signals (720P/1080I).

**HD-Ready** - A unit that supports the High Definition displays (720P/1080I) with the help of a Set-Top Box.

**Horizontal Resolution** - Refers to the number of vertical black and white lines defined along a horizontal line.

**IR** - Infrared

**Input** - term used in the On Screen Display

**Interlaced** - Images are the result of lines of data reassembled. Interlaced refers to the process of an image's odd lines reassembled from top to bottom taking about 1/60 of a second, before reassembling the even lines which results in a full picture. Antonym: Progressive

**Language** - Feature on the OSD for the Syntax-Brilliant Olevia models that enables the OSD to be read in different languages.

**LCD** - Liquid Crystal Display

**LCoS** - Liquid Crystal on Silicon

**LED** - Light Emitting Diode

**Luminance** - refers to the brightness of an image.

**Lux** - 1 Lux = 1 footcandle; measurement of brightness

**Moire** - A visual illusion in which a succession of parallel curved lines produces a pattern to the naked eye, but does not really exist. Otherwise known as the moire effect.

**NCTA** - National Cable Television Association

**Noise reduction** - Feature on the OSD for the Syntax-Brilliant Olevia models that enables channels from the tuner box to reduce noise displayed on the LCD unit.

**NTSC** - National Television systems Committee

**OSD** - On Screen Display; brought up by pressing the menu button on the TV or the Remote.

**Over Scanning** - An image displayed is larger than the display area

**PAL** - Phase Alternating Line

**Parental Control** - The ability to block access to specified content from an unsuitable audience.

**PIP** - Picture in Picture; feature that enables one source to be displayed on top of another source.

**Pixel Resolution** - Refers to the number of rows horizontal and vertical that produces the image.

**PIP** - Picture in Picture; Allows an image to be displayed in front of another image.

**Plug and Play** - Describes the hardware or software that is installed and does not require any configuration before using.

**Progressive** - An image or lines of data that is reassembled from top to bottom sequentially.

**Antonym:** Interlaced

**RGB** - Red, green & blue These primary colors provide the basis for many different colors.

**Refresh Rate** - Refers to the maximum number of frames that the monitor can display per second. Usually measured in hertz.

**Saturation** - The amount of a particular color present in an image.

**SCART** - An industry standard for interconnecting audio-video equipment developed by Peritel. Usually associated with PAL video equipment.

**SDTV** - Standard Definition Television usually in 480I/P format.

**SECAM** - Sequential Color with Memory or Sequential Couleur Avec Memoire

**Set-Top-Box** - box that is capable of receiving and decoding digital transmissions (i.e. High Definition Cable Box, Digital Cable box).

**Sharpness** - Tries to artificially enhance the edges of a picture.

**Single Link** - supports a maximum bandwidth of 165 MHz (1920 x 1080 @ 60 Hz, 1280 x 1024 @ 85 Hz).

**Split screen** - Feature that places two images side by side.

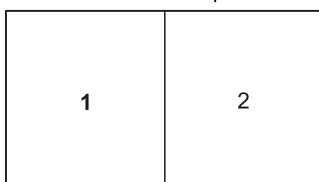



**Swap** - Button featured on the Olevia remote. Used in the POP3 or PIP12 views to swap the sub viewable boxes with the main viewable box.

**Tint** - Adjusts the whiteness level within the color. Similar to Hue.

**Under-** scanning Term used where the image displayed is smaller than the display area.

**Up convert** - Process of converting a 480P/I signals to 720P or 1080I.

**V-Chip** - Chip that controls access to forbidden content specified by an adult.

**VGA** - 1. Video Graphics Array (DB15) 2.

**Video Display** - Refers to the display resolution

### Video Resolution

Aspect Ratio 4:3		Aspect Ratio 16:9	
VGA	640 x 480	WXGA	1280 X 800
SVGA	800 x 600	SXGA	1280 X 1024
XGA	1024 x 768	WXGA+	1400 X 1050
QVGA	1280 x 960	WSXGA	1680 X 1050
SXGA+	1400 x 1050	WUXGA	1920 X 1200
UXGA	1600 x 1200	QSXGA	2560 X 2048
QXGA	2048 x 1536		
QSXGA+	2800 x 2100		
QUXGA	3200 x 2400		

**Viewable Angle** - Angle at which the screen is still viewable.

**Widescreen** - See 16:9

**YCbCr** - Used often with standard interlaced video equipment. See Component

**YPbPr** - Used often with progressive video equipment. See Component

# Code Number Lists for Remote Control

TV			
Manufacturer	Code		
Syntax-Brilliant (OLEVIA) 3 Series 5 Series 7 Series	0000 (Remote Default)		
Syntax-Brilliant (OLEVIA) HVE Series HVM Series HVS Series HVi Series HVX Series DLT-2711M DLT-3212M DLT-3712 LT27HV LT30HV LT32HV LT27HVS LT30HVS LT20HVK LT20S	0001		

DVD			
Manufacturer	Code		
Aiwa	2073		
Apex	2000	2001	2003
	2004	2016	2028
	2029	2030	
Audiovox	2074		
Blaupunkt	2078		
BOSE	2062	2071	
Broksonic	2045		
Cherry	2025		
Clarion	2046		
Classic	2047		
Daewoo	2079	2080	2113
Denon	2075	2095	2096
Emerson	2048	2049	
Fisher	2050	2076	
Funai	2049	2064	
GE	2005	2051	2102
Go Video	2068	2070	
GPX	2052		
Great Wall	2101		

DVD			
Manufacturer	Code		
Harman Kardon	2114		
Hitachi	2065	2067	
Irradio	2092		
JVC	2007	2010	2011
	2012	2013	
Kenwood	2097	2100	
Koss	2093		
Magnavox	2020	2035	
Marantz	2085		
Memorex	2087		
Mintek	2053		
Mitsubishi	2088	2089	2090
	2091		
NAD	2048	2081	
Nakamichi	2054		
Norcent	2055	2056	
Onkyo	2082	2086	
Oritron	2057		
Panasonic	2008	2036	2037
Philips	2002	2009	2021
	2022	2023	2043
	2027		
Pioneer	2027		
Polaroid	2111		
Proscan	2005	2099	
Qwestar	2057		
RCA	2005	2024	2038
	2110		
Sampo	2058		
Samsung	2006	2017	2033
	2041		
Sansui	2060		
Sanyo	2059	2063	
Sharp	2014	2031	
Sherwood	2061		

DVD			
Manufacturer	Code		
Sony	2015	2018	2034
	2039		
Sylvania	2049	2072	2077
Techwood	2083		
Toshiba	2019	2026	2040
	2042		
Yamaha	2084	2098	
Zenith	2069	2094	

HTIB			
Manufacturer	Code		
BOSE	2071		
Onkyo	2086		
RCA	2105		

DVD / VCR Combo			
Manufacturer	Code		
Go Video	2068	2070	
Hitachi	2067		
JVC	2010		
Polaroid	2111		
Samsung	2017		
Sanyo	2063		
Zenith	2069		

DVD Recorder			
Manufacturer	Code		
Irradio	2106		
Panasonic	2103		
Philips	2107		
Pioneer	2104		
RCA	2105		
Sony	2108		
Yamaha	2109		

TV / DVD / VCR Combo			
Manufacturer	Code		
Samsung	2041		
Sylvania	2072		
Toshiba	2040		

Portable DVD			
Manufacturer	Code		
CyberHome	2112		

TV / DVD Combo			
Manufacturer	Code		
Aiwa	2044		
Apex	2016		
Broksonic	2045		
JVC	2011		
Sansui	2060		
Toshiba	2042		

Amplifier			
Manufacturer	Code		
Kenwood	5048		
Pioneer	5041		
RCA	5069		
Yamaha	5001	5053	

AUDIO			
Manufacturer	Code		
Cambridge	5011		
Ibiza	5037		

Digital Audio Tape			
Manufacturer	Code		
Sony	5043		

Audio Cassette			
Manufacturer	Code		
Aiwa	5039		
Curtis Mathes	5041		
Denon	5052		
Fisher	5042	5049	
GE	5070		
Kenwood	5048	5056	
NAD	5040		
Nakamichi	5054		
Onkyo	5055		
Optimus	5041	5047	
Panasonic	5015	5050	
Philips	5013		
Pioneer	5018	5041	5045
Proscan	5070		
Quasar	5050		
Radio Shack	5047		
RCA	5070		
Sansui	5057		
Sanyo	5044		
Sherwood	5047		
Sony	5043		
Technics	5050		
Yamaha	5053		

HTIB			
Manufacturer	Code		
BOSE	5010		
Philips	5022		

Receiver / Amplifier			
Manufacturer	Code		
Yamaha	5001		

Audio System			
Manufacturer	Code		
Aiwa	5039		
Carver	5051		
Curtis Mathes	5041		
Denon	5052		
Harman Kardon	5046		
Kenwood	5048	5056	
Nakamichi	5054		
Panasonic	5015	5016	
Philips	5013	5014	
Pioneer	5018	5041	
RCA & Dimensia	5031	5032	5033
	5034	5035	
Sansui	5057		
Sanyo	5044		
Scientific Atlanta	5067		
Sony	5043		
Technics	5050		
Yamaha	5053		

Phono			
Manufacturer	Code		
Kenwood	5048		
Pioneer	5041		
Sony	5043		
Yamaha	5053		

DVR			
Manufacturer	Code		
Philips	1042		
RCA	1116		
RePlay	1115		
Tivo	1116		

Receiver / Tuner			
Manufacturer	Code		
Aiwa	5017	5036	5039
BOSE	5010		
Carver	5051		
Curtis Mathes	5041		
Denon	5006	5026	5027
	5052		
Fisher	5042	5044	5049
Gradiente	5062		
Harman Kardon	5008	5038	5046
Hitachi	5059		
JBL	5038		
Jensen	5061		
JVC	5007	5030	
Kenwood	5005	5028	5048
	5056		
Luxman	5064		
McIntosh	5058		
NAD	5040		
Nakamichi	5054		
NEC	5040		
Nikko	5063		
Onkyo	5055		
Optimus	5041	5047	
Panasonic	5009	5012	5016
	5029	5050	
Philips	5014	5022	
Pioneer	5004	5023	5041
	5045		
Quasar	5050		
Radio Shack	5047		
RCA	5071	5072	
Sansui	5057		
Sanyo	5042	5044	
Sharp	5060		
Sherwood	5047		

Receiver / Tuner			
Manufacturer	Code		
Sony	5024	5043	
Technics	5002	5020	5050
Yamaha	5048	5053	
Zenith	5065		

TV / VCR Combo			
Manufacturer	Code		
Action	1102		
Broksonic	1023	1106	
Daewoo	1014		
Emerson	1106		
GE	1040	1081	1087
Goldstar	1090		
Hitachi	1036	1037	
JVC	1019		
Panasonic	1002	1020	1090
Philips	1018		
Precision	1102		
Quasar	1090		
RCA	1012	1016	
Realistic	1105		
Samsung	1029	1035	
Sharp	1015		
Sony	1007		
Sylvania	1030		
Toshiba	1010		
Zenith	1038	1090	

DVD / VCR Combo			
Manufacturer	Code		
Go Video	1026	1028	
Hitachi	1025		
JVC	1000		
Samsung	1031		
Sanyo	1022		
Zenith	1027		

TV / VCR Tuner Combo			
Manufacturer	Code		
Panasonic	1009		

TV / DVD / VCR Combo			
Manufacturer	Code		
Samsung	1039		
Sylvania	1032		
Toshiba	1011		

PVR			
Manufacturer	Code		
Tivo	1111		

VCR			
Manufacturer	Code		
Admiral	1073	1074	1101
Adventura	1055		
Aiko	1056		
Aiwa	1055		
Akai	1044	1045	1068
	1069	1080	1093
American High	1053		
Asha	1050		
Audio Dynamics	1046	1047	
Audiovox	1051		
Beaumarck	1049	1050	1079
Bell & Howell	1048		
Broksonic	1023	1049	
Calix	1051		
Candle	1050	1051	1052
	1079	1083	1090
	1092	1095	1102
Canon	1053	1054	
Capehart	1067	1083	
Carver	1060	1110	
CCE	1056	1059	
Challenger	1001		

VCR			
Manufacturer	Code		
Citizen	1050	1051	1052
	1056	1095	
Colortyme	1046	1096	
Colt	1059		
Craig	1050	1051	1059
	1085	1090	1105
Criterion	1085		
Curtis Mathes	1043	1046	1050
	1053	1054	1077
	1079	1112	
Cybernex	1050		
Daewoo	1014	1052	1055
	1056	1067	1083
	1102		
Daytron	1067	1083	1102
DBX	1046	1047	
Denon	1088		
Dimensia	1043	1112	
Dixon	1013	1103	
Dynatech	1055		
Electrohome	1051	1090	
Electroponic	1051		
Emerson	1044	1049	1051
	1052	1053	1055
	1061	1069	1087
	1090	1106	
Fisher	1048	1089	1105
Fuji	1045	1053	
Funai	1055	1095	1113
Garrard	1055		
GE	1040	1043	1050
	1053	1054	1070
	1079	1112	

VCR			
Manufacturer	Code		
Go Video	1021	1024	1026
	1028	1079	1081
	1085	1086	
Goldstar	1046	1051	1079
	1090	1092	
Gradiente	1055	1090	
Harley Davidson	1055		
Harman Kardon	1046	1110	
Harwood	1059		
Headquarter	1048		
Hitachi	1025	1036	1037
	1057	1058	1065
	1068	1070	1088
Homeline	1090		
Instant Replay	1053		
JBL	1098		
JC Penney	1046	1047	1048
	1049	1050	1051
	1053	1054	1057
	1058	1059	1060
	1065	1079	1085
1088	1090		
JCL	1053		
Jensen	1057	1058	1068
JVC	1000	1019	1046
	1047	1048	1068
	1071	1087	1088
Kenwood	1046	1047	1048
	1068	1071	1077
KLH	1059		
Kodak	1051	1053	
LG	1051		
Lloyds	1077	1095	1105
Lloyd's	1055		
Logik	1059	1085	

VCR			
Manufacturer	Code		
LXI	1051		
Magnasonic	1085	1090	1102
Magnavox	1008	1053	1054
	1060	1064	1085
	1110		
Magnin	1051	1079	
Marantz	1046	1047	1048
	1053	1060	1077
	1092	1110	
Marta	1051	1090	
Matsushita	1053		
MEI	1053		
Memorex	1033	1048	1050
	1051	1053	1055
	1064	1073	1074
	1088	1090	1091
	1097	1105	1114
MGA	1061	1069	
MGN	1079		
MGN Technology	1050		
Midland	1095		
Minolta	1057	1058	1065
	1088		
Mitsubishi	1003	1005	1006
	1057	1058	1061
	1069	1071	1090
Montgomery Ward	1073	1074	
Motorola	1053	1073	1074
MTC	1050	1085	
Multitech	1050	1055	1059
NEC	1046	1047	1048
	1068	1071	1077
	1092		
Nikko	1051		
Noblex	1050		

VCR			
Manufacturer	Code		
Olympus	1053		
Optimus	1051	1073	1074
	1090	1094	
Optonica	1062		
Orion	1087	1090	1106
	1114		
Panasonic	1002	1004	1009
	1020	1053	1054
	1066	1085	1105
Pentax	1057	1058	1065
	1070	1077	1088
Philco	1053	1054	1060
	1088	1106	
Philips	1017	1018	1053
	1060	1062	1110
Pilot	1051		
Pioneer	1047	1057	1071
	1075	1078	1104
Portland	1067	1083	
Proscan	1043	1112	
Protec	1059		
Proton	1085		
Pulsar	1064	1079	1095
	1102		
Quarter	1048		
Quartz	1048		
Quasar	1053	1054	
Radio Shack	1051	1062	1074
	1090		
Radio Shack /	1048	1050	1051
Realistic	1053	1054	1055
	1062	1073	
Radix	1051		
Randex	1051		

VCR			
Manufacturer	Code		
RCA	1012	1016	1043
	1044	1050	1053
	1057	1058	1065
	1070	1078	1079
	1088	1107	1108
	1112		
Realistic	1048	1050	1051
	1052	1053	1054
	1055	1062	1073
	1074	1079	1090
	1094	1097	1105
Ricoh	1072	1076	
Runco	1064		
Samsung	1029	1031	1035
	1039	1050	1052
	1079	1095	
Sanky	1064	1073	1074
Sansui	1047	1068	1071
	1085	1114	
Sanyo	1022	1048	1050
	1089	1097	1105
Scott	1049	1052	1061
	1090		
Sears	1048	1051	1053
	1057	1058	1065
	1077	1088	1089
	1090	1097	1105
Sharp	1015	1062	1073
	1074	1091	1094
	1101		
Shintom	1045	1058	1059
	1085		
Shogun	1050		
Signature	1073	1074	
Signature 2000	1097	1101	

VCR			
Manufacturer	Code		
Singer	1053	1059	1072
	1076	1085	
Sony	1007	1045	1063
	1080	1082	1084
	1098	1099	
STS	1053	1065	
Sylvania	1030	1032	1053
	1054	1055	1060
	1061	1110	
Symphonic	1055	1077	1095
	1105	1113	
Tandy	1048		
Tashiko	1051		
Tatung	1068		
Teac	1055	1068	1107
Technics	1053	1066	
Teknika	1051	1053	1055
	1090		
TMK	1050		
Toshiba	1010	1011	1052
	1057	1061	1069
	1100	1102	1105
	1109		
Totevision	1050	1051	1090
Unitec	1095		
Unitech	1050		
Vector Research	1046	1047	1052
	1077		
Wards	1050	1051	1052
	1053	1055	1057
	1058	1059	1062
	1065	1073	1074
	1079	1090	1091
	1094	1105	1108
	1110		

VCR			
Manufacturer	Code		
Victor	1047		
Video Concepts	1046	1047	1052
	1069	1077	
Videosonic	1050		
White Westinghouse	1095	1113	
XR 1000	1085		
XR-1000	1053	1055	1059
Yamaha	1046	1047	1048
	1068	1077	
Zenith	1027	1038	1045
	1064	1072	1076
	1093		

Satellite			
Manufacturer	Code		
BSB	3003		
Directv	3001		
Echostar	3049	3051	3052
	3053		
GE	3046		
Hitachi	3045		
Hughes	3043	3047	
Mitsubishi	3002		
Panasonic	3036		
Philips	3000		
Proscan	3038	3044	
RCA	3037	3039	
Sony	3040	3042	
SuperDish	3025		
Uniden	3041		
Alphastar	3028		
Chaparral	3024		
DIRECTV	3048		
Drake	3027		
Echostar	3026		

Satellite			
Manufacturer	Code		
Express Vu	3030		
Fujitsu	3022		
GE	3004	3032	3033
General Instruments	3018	3019	
Hitachi	3023		
Hughes	3023	3048	
Hughes Network	3048		
Hughes Network	3048		
Janeil	3022		
JVC	3015		
Panasonic	3005	3011	
Proscan	3032	3033	
Radio Shack	3018	3019	
RCA	3032	3033	
Realistic	3014		
Rural Cable	3018		
Samsung	3006	3028	
Sony	3007		
Star Choice	3031		
Star Trak	3021		
STS	3020		
Toshiba	3008	3029	
Uniden	3016	3017	
Video Pall	3022		
Zenith	3009	3022	

Satellite Receiver / Recorder			
Manufacturer	Code		
Philips	3012		

SAT-DVR			
Manufacturer	Code		
DISH Network	3050		
RCA	3010		
Sony	3035		
Zenith	3013		

Cable Box			
Manufacturer	Code		
ABC	4000	4001	4002
	4030		
Antronix	4004		
Archer	4007		
Cabletenna	4004		
Cableview	4003		
Colour Voice	4009	4010	
Contec	4034		
Eastern	4035		
GE	4000		
Gemini	4012	4013	
General Instrument	4050		
General Instruments	4000	4032	
Hamlin	4036	4037	4038
	4040	4044	
Hitachi	4000		
Jerrold	4000	4012	4015
	4016	4026	4030
	4032		
Motorola	4031	4051	4052
Movie Time	4039		
NEC	4033		
NSC	4039		
Oak	4034	4041	
Panasonic	4027	4029	
Philips	4009	4010	4011
	4013	4018	4019
	4020		
Pioneer	4021	4022	4045
Proscan	4000		
RCA	4003	4029	4032
Regal	4038	4044	
Regency	4035		
Rembrandt	4000		

Cable Box			
Manufacturer	Code		
Samsung	4022		
Scientific Atlanta	4002	4023	4024
	4025	4048	
Signal	4012		
Signature	4000		
Sony	4049		
Sprucer	4029		
Standard Component	4042	4043	
Starcom	4012	4030	
Stargate	4012		
Starquest	4012		
Tocom	4001	4015	
Tusa	4012		
TV86	4039		
Unika	4004		
United Cable	4030		
Universal	4004	4007	
View Star	4034	4039	
Zenith	4028		