

H D2+ DLP Front Projector

User's Manual

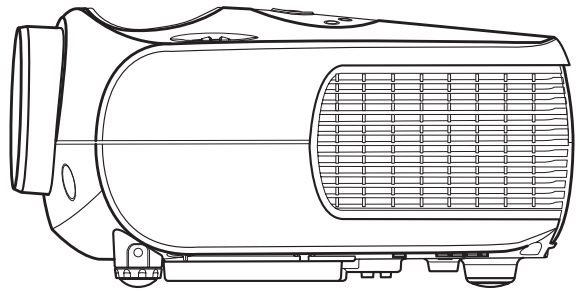

HD2+ DLP Front Projector

ABOUT THIS MANUAL

This manual is designed for use with the HD2+ DLP Front Projector. Information in this document has been carefully checked for accuracy; however, no guarantee is given to the correctness of the contents. The information in this document is subject to change without notice.

COPYRIGHT

© Copyright 2004

This document contains proprietary information protected by copyright. All rights are reserved. No part of this manual may be reproduced by any mechanical, electronic or other means, in any form, without prior written permission of the manufacturer

TRADEMARKS

All trademarks and registered trademarks are the property of their respective owners.

FCC COMPLIANCE

This device complies with Part 15 of the FCC Rules. Operation is subject to the following two conditions:

- (1) This device may not cause harmful interference, and
- (2) This device must accept any interference received, including interference that may cause undesired operation.

FEDERAL COMMUNICATIONS COMMISSION (FCC) STATEMENT

This equipment has been tested and found to comply with the limits for a Class B digital device, pursuant to part 15 of the FCC Rules. These limits are designed to provide reasonable protection against harmful interference in a residential installation. This equipment generates, uses and can radiate radio frequency energy and, if not installed and used in accordance with the instructions, may cause harmful interference to radio communications. However, there is no guarantee that interference will not occur in a particular installation. If this equipment does cause harmful interference to radio or television reception, which can be determined by turning the equipment off and on, the user is encouraged to try to correct the interference by one or more of the following measures:

Reorient or relocate the receiving antenna.

Increase the separation between the equipment and the receiver.

Connect the equipment to an outlet on a circuit different from that to which the receiver is connected.

Consult the dealer or an experienced radio/TV technician for help.

Notices



WARNING! To meet FCC requirements, a shielded power cord is required in order to prevent interference. It is essential that only the supplied power cord is to be used. Use only shielded cables to connect I/O devices to this equipment. You are cautioned that changes or modifications not approved by the party responsible for compliance could void your authority to operate the equipment.



WARNING! The projector cooling fan continues to run for approximately 90 seconds after the projector is turned off using the Power button on the control panel or remote control. Never unplug the power cable to power off the projector; damage to the lamp may result.



WARNING! High brightness light source. Do not stare into the beam of light, or view directly.

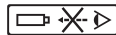

Be especially careful and ensure that children do not stare directly into the beam of light.



WARNING! To reduce the risk of fire or electric shock, do not expose this product to rain or moisture.



CAUTION! For minimal servicing and to maintain high image quality, we recommend that you use the projector in an environment that is smoke and dust free. When used in areas where there is a lot of smoke or dust, the filter and lens should be cleaned often to lengthen the service life of the projector.



WARNING! Some IC chips in this product include confidential and/or trade secret property belonging to Texas Instruments. Therefore you may not copy, modify, adapt, translate, distribute, reverse engineer, reverse assemble or decompile the contents thereof.



WARNING! The ventilation slots, lamp, and objects next to them may get extremely hot during operation. Do not touch these areas until they have sufficiently cooled down.

PRODUCT DISPOSAL

This projector utilizes a tin-lead solder, UHP Lamp containing a small amount of mercury. Disposal of these materials may be regulated due to environmental considerations.

Caution regarding the exhaust of the projector.

Do not put Air Conditioners or Flowers near the exhaust vent.

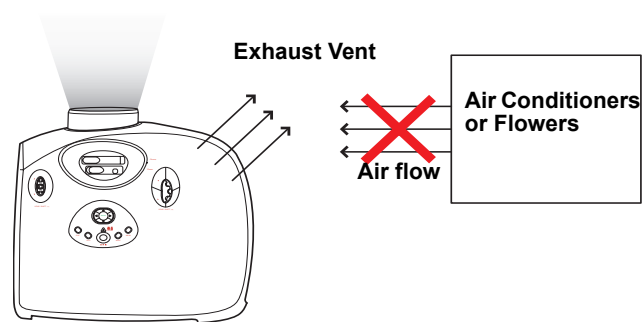

Before using the projector, please read this operation manual carefully.

To facilitate reporting the loss or theft of your Projector, record the Serial Number located on the bottom of the projector and retain this information. Before recycling the packaging, be sure that you have checked the contents of the carton thoroughly against the list of "Package Contents" on page 7.

WARRANTY

Promptly register the Projector's Warranty using the REGISTRATION CARD packed with the projector. The Warranty assures that you immediately receive the full benefit of the parts, service and labor warranty applicable to your purchase.

Contents

Preface	1
Notices	2

Introduction

Package Contents	7
Features	8
Components	9
Projector (Front and Top View)	9
Projector (Rear View)	10
Remote Control	11
Using the Remote Control	12
Available Range of the Remote Control	12
Inserting the Batteries	12

Connections and Setup

Connecting the Projector to Other Devices	14
Before Setting Up	14
Connecting the Power Cord	14
Connecting to Video Equipment	15
Connecting to Component Video Equipment	16
Connecting Using the DVI Cable	16
Connecting Using a DVI-D to HDMI Cable	17
Connecting the Projector to a Computer	18
Connecting the Cables	19
“Plug and Play” Function	19
Using the Adjustment Feet	20
Adjusting the Lens	21
Using the Lens Shift	21
Setting up the Screen	22
Screen Size and Projection Distance	23
Projection from behind the screen	25

Basic Operation

Image Projection	28
Basic Procedure	28
Selecting the On-screen Display Language	30
Menu Bar Items	31
Using the Menu Screen	33
Menu Selections (Adjustments)	33
Adjusting the Image	34
Adjusting Computer Images	38

Easy to Use Functions

Selecting the Picture Display Mode	40
H-V Position Function	43

H-V Keystone Function	44
White Enhance	45
Selecting the Economy Mode.....	45
Setting the Power Save.....	45
Automatic Power Off Function.....	46
Source Select	46
OSD Timeout.....	47
OSD Blending.....	48
Reversing/Inverting Projected Images.....	48
Setting the Projection Mode	48
Deinterlace	49
Reset	50
Lamp Timer Reset.....	50
Status Screen	51
Factory reset	51





Appendix

Maintenance	54
Cleaning the Ventilative Holes	55
Cleaning the Ventilative Holes	55
About the Lamp	56
Caution Concerning the Lamp	56
Replacing the Lamp	56
Temperature LED (Over Temperature).....	56
Removing and Installing the Lamp Unit.....	57
Resetting the Lamp Timer	58
Connecting Pin Assignments	59
Computer Compatibility Chart	60
Video Compatibility Chart.....	61
Troubleshooting.....	62
Product Specifications	64
Dimensions.....	65

Introduction

Package Contents

Open the package and ensure that you have the following items:

		
Remote control	Two “AAA” size batteries	Power cord (By country)
		
Quick Guide	Operation manual (this manual)	

Optional accessories

HD 15-pin VGA to HD 15-pin VGA cable
RS-232C cable (3M)
DVI-D to DVI-D cable (3M)
DVI-D to HDMI cable (3M)
Ceiling mount package



Note

- Some of the cables may not be available depending on the region. Please check with your nearest authorized dealer.

If anything is missing or appears damaged, contact your dealer immediately.

Features

- Newly developed DMD™ chip provides significantly improved optical efficiency and excellent contrast ratio.
- Newly developed LVDS (Low voltage differential signal) chip eliminates color breaking phenomena common with previous generation DLP™ projectors.
- The 250W high-output lamp gives high color purity and brightness. Natural images are possible with excellent color reproduction and powerful expression capabilities.
- Latest image quality circuitry gives you vivid images.
- New I/P conversion algorithm enhances motion.
- Extensive improvements in jagged edges and slanted lines in moving images.
- New Edge Up-Scaling.
- As a result of reducing jagged edges and flickering when up-scaling edges of slanted lines, even signals not reaching a panel resolution of 480I/P can be projected by converting them to 1280 × 720 resolution images.
- New Film mode.
- 3:2 pull-down enhancement for 480I, 576I and HDTV 1080I signals.
- Use of a DVI/HDCP terminal enables all processes from input to signal processing and projecting to be performed digitally. All-digital projection does not suffer the data loss of analog conversion. Home theaters using HTPC are supported.

Components

Projector (Front and Top View)

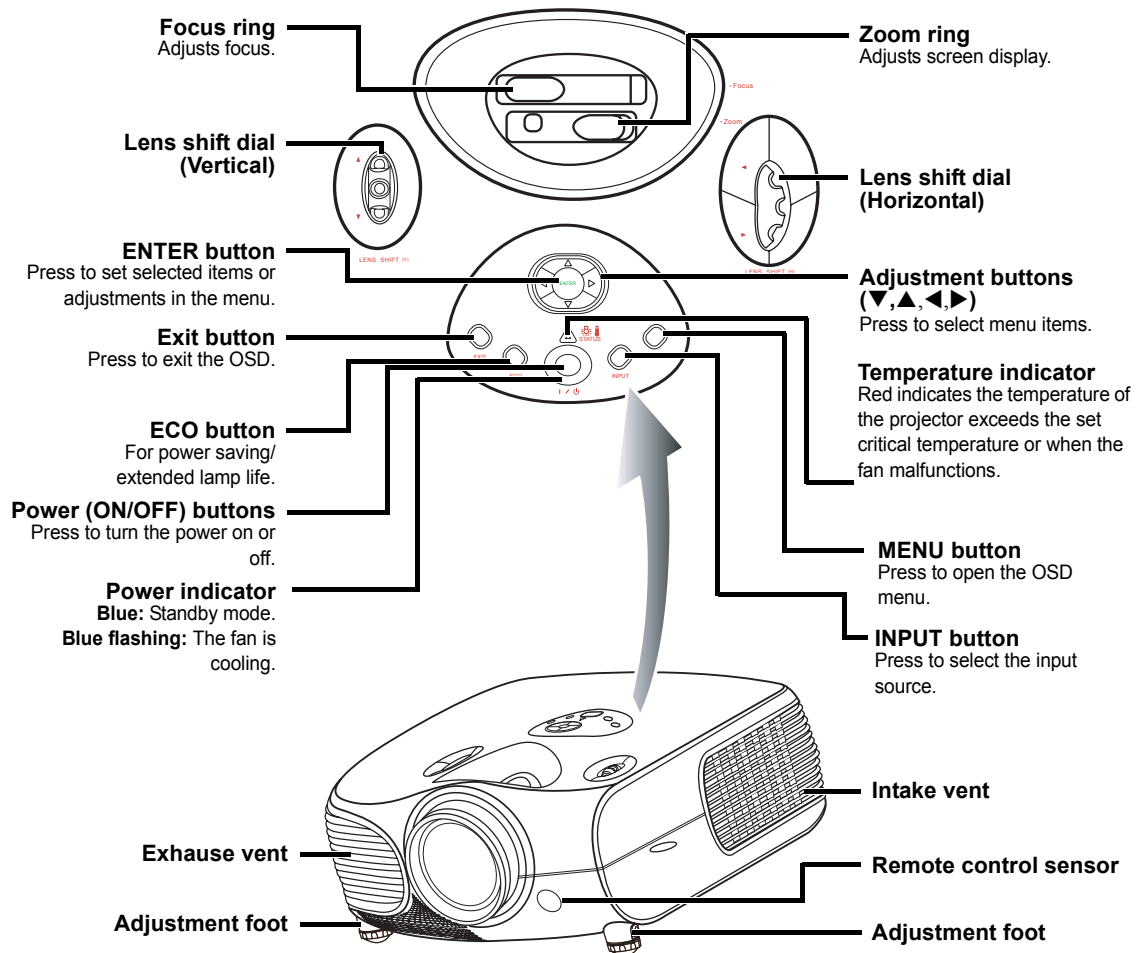

Temperature indicator

The projector has a temperature warning LED on the control panel. If the projector overheats because of a dirty filter or another problem, the LED will flash, and the projector lamp will turn off, after which a 90-second cooling off period occurs. After restarting the projector, if the unit doesn't operate normally, take the projector for servicing.

Projector (Rear View)

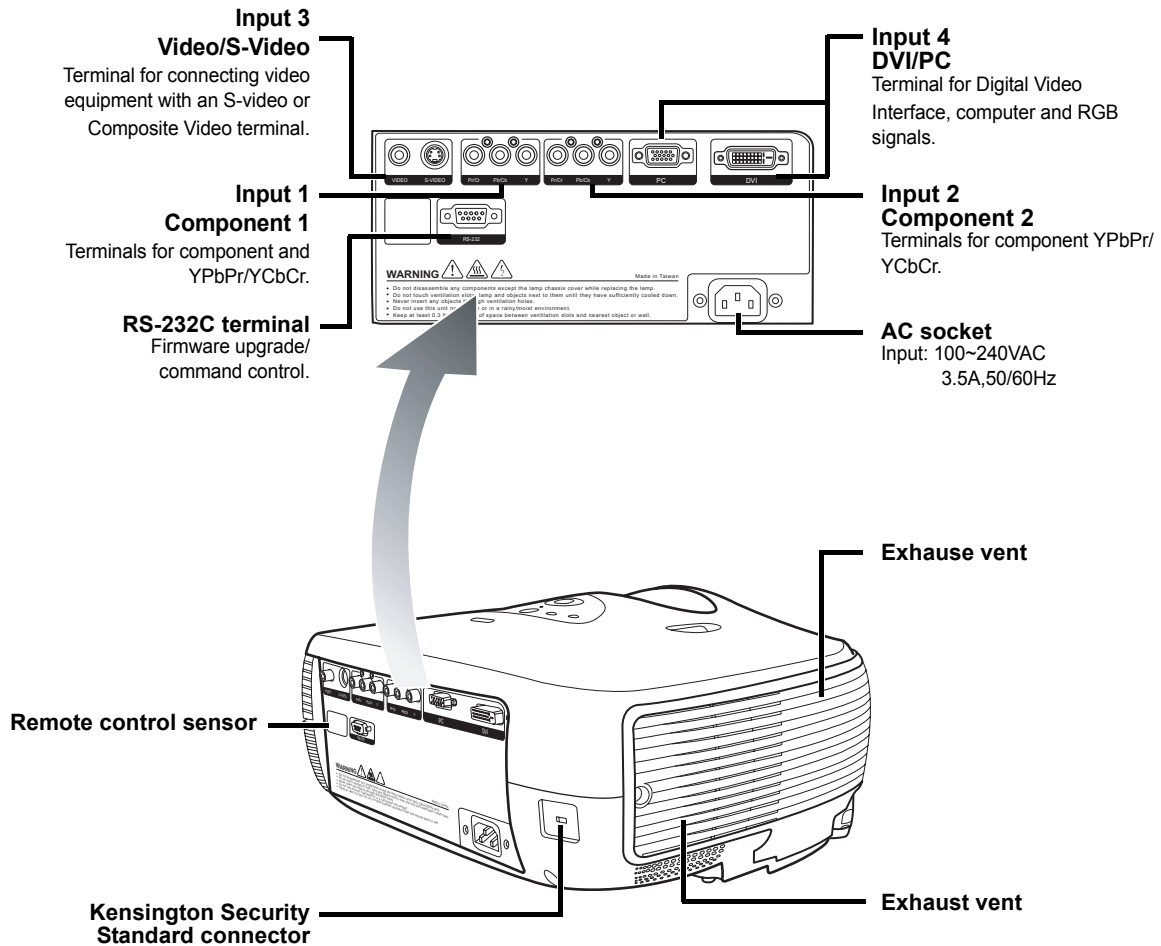

WARNING! The projector lamp can reach high temperatures, making air blowing out from the ventilation slots uncomfortably hot.

Using the Kensington Lock

This projector has a Kensington Security Standard connector for use with a Kensington MicroSaver Security System. Refer to the information that came with the system for instructions on how to use it to secure the projector.

Remote Control

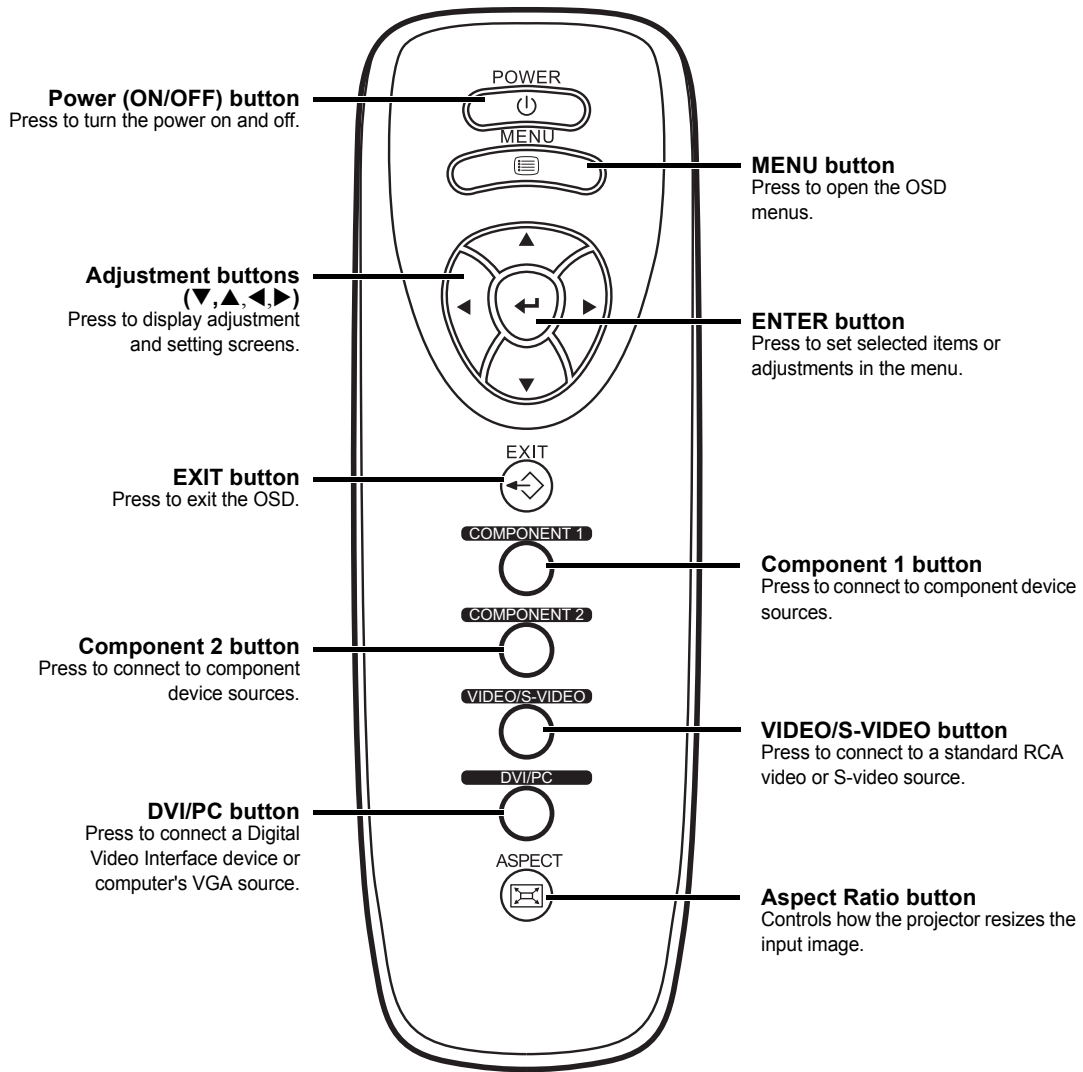

Using the Remote Control

Available Range of the Remote Control

- The remote control can be used to control the projector within the ranges shown in the illustration.

Note

- The signal from the remote control can be reflected by the screen. You can control the projector when it is behind you by bouncing the signal off the screen.

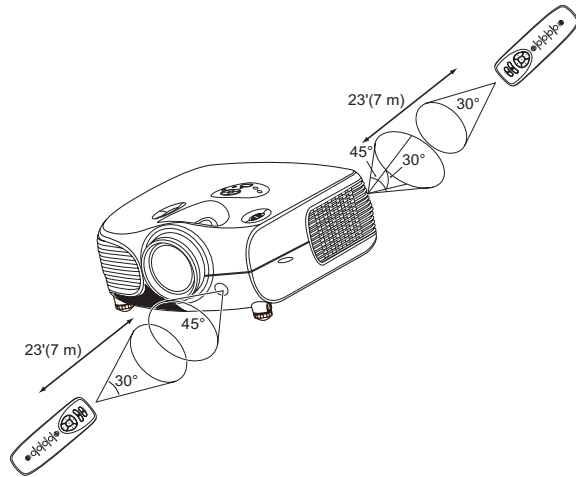

When using the remote control:

- Do not drop it, or expose it to moisture or high temperature.
- The remote control may not function correctly under fluorescent lamps. Operate the projector away from fluorescent lamps.

Inserting the Batteries

The batteries (two AAA) are included in the package.

- 1 Press down the tab on the cover and pull the cover towards the direction of the arrow.**
- 2 Insert the included batteries.**
Make sure the polarities correctly match the \oplus and \ominus marks inside the battery compartment.
- 3 Insert the lower tab of the cover into the opening, and press down the cover until it clicks in place.**

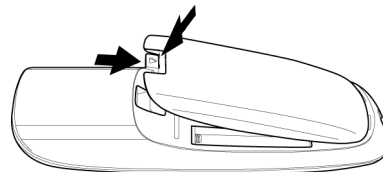
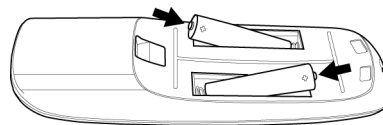
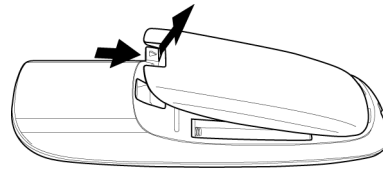

Connections and Setup

Connecting the Projector to Other Devices

Before Setting Up

 **Note**

- Before connecting, turn off both the projector and the devices to be connected. After making all connections, turn on the projector first and then the other devices. When connecting a computer, be sure that the computer is the last device turned on, after all connections are made.
- Read the operation manuals of the devices to be connected before making connections.

This projector can be connected to

Video equipment:

- A VCR, Laser disc player or other video equipment.
- A DVD player or DTV* decoder.

*DTV is the umbrella term used to describe the new digital television system.

A computer, using:

- A HD 15-pin VGA to HD 15-pin VGA cable (sold separately), or
- A DVI-D to DVI-D cable (sold separately), or
- An RS-232C cable (sold separately).

Connecting the Power Cord

Plug the supplied power cord into the AC socket on the rear of the projector.

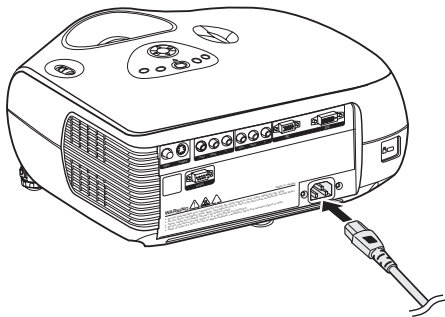
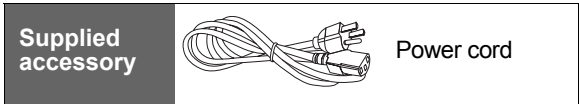

Connecting to Component Video Equipment

Using a Component Cable (INPUT 1 or 2)

Use a component cable when connecting component video equipment such as DVD players and DTV* decoders to the INPUT 1 or 2 terminals.

*DTV is an umbrella term used to describe the new digital television system.

 **Note**

- When connecting the projector to video equipment in this way, set "Input Source" to "Component 1 or 2" in the "Main" menu.

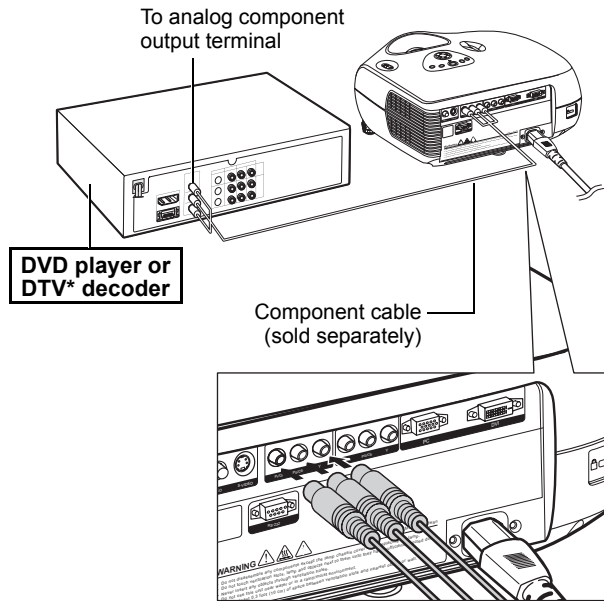

The device's component jacks may be labeled Y, CB and CR. Connect each jack as shown below.

Projector	Y	PB	PR
	↓	↓	↓
DVD player or DTV decoder	Y	CB	CR

Connecting Using the DVI Cable

Use the DVI cable when connecting video equipment with DVI output such as DVD players and DTV* decoders to the INPUT 4 terminal.

 **Note**

- Select the input signal type of the video equipment.

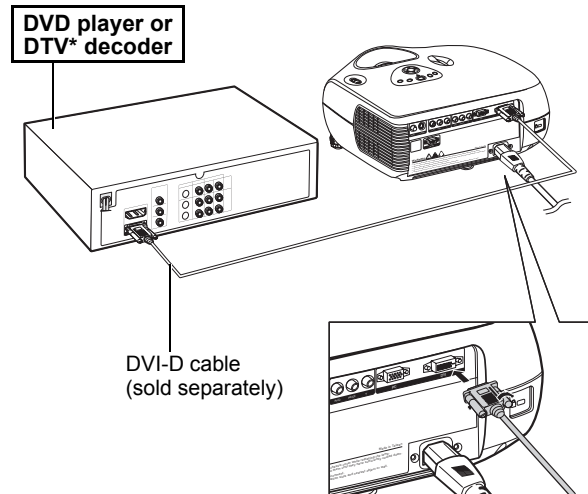
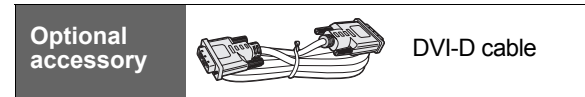

Connecting Using a DVI-D to HDMI Cable

Use a DVI to HDMI cable when connecting HDMI video equipment such as DVD players to the INPUT 4 terminal.

- 1 Connect a DVI-D to HDMI cable to the projector.**
 - Secure the connectors by tightening the thumbscrews.
- 2 Connect the above cable to the video equipment.**



Note

- Select the input signal type of the video equipment.

Optional
accessory

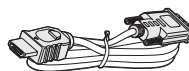

DVI-D to HDMI
cable

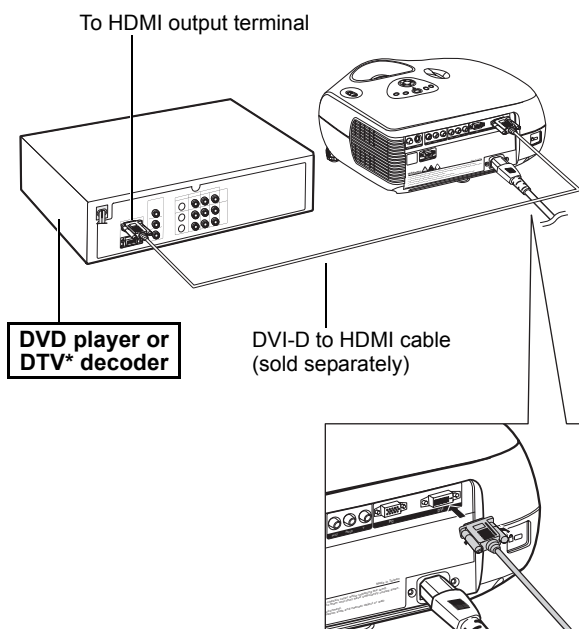

Connecting the Projector to a Computer

Connect the projector to the computer using an HD 15-pin VGA cable.

- Secure the cable connectors by tightening the screws on both sides of the plug.

Notes

- See page 60 “Computer Compatibility Chart” for a list of computer signals compatible with the projector. Using computer signals other than those listed may cause some of the functions not to work.
- When connecting the projector to a computer using an HD 15-pin VGA cable, set the “Input Source” to “PC” in the “Main” menu, or select RGB mode by pressing the DVI/PC button on the remote control.
- A Macintosh adaptor may be required for use with some Macintosh computers. Contact your nearest authorized service center or dealer.
- Depending on the computer you are using, an image may not be projected unless the signal output setting of the computer is switched to the external output. Refer to the computer operation manual for switching the computer signal output settings.

Optional
accessory



HD 15-pin
VGA cable

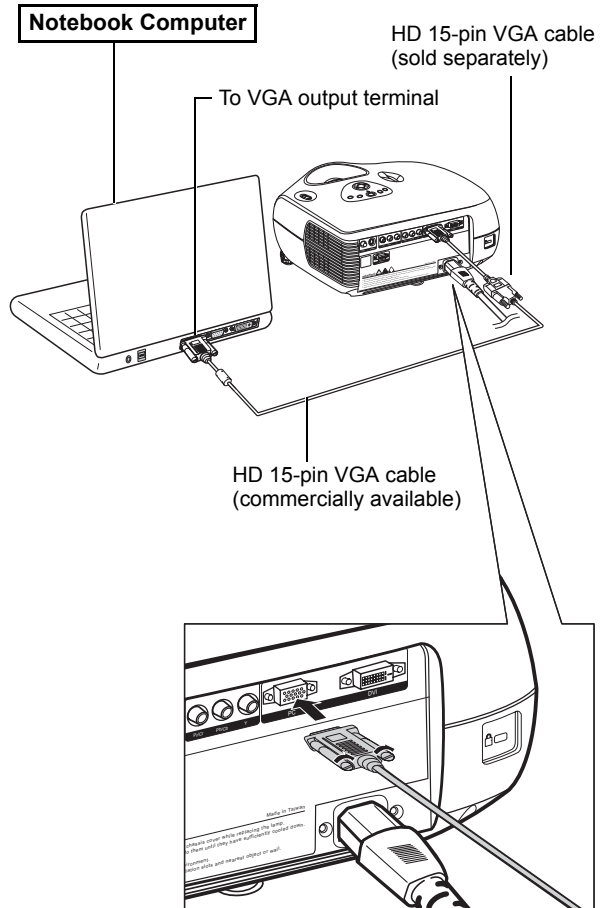

Connect the projector to the computer using a DVI-D cable (sold separately).

 **Note**

- Select the input signal type of the video equipment.

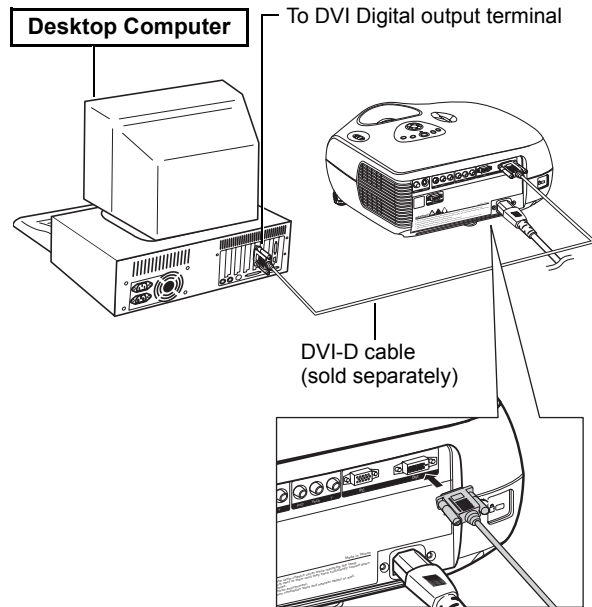
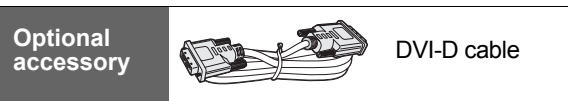

Connecting the Cables

- Connect the cable making sure that it fits correctly into the terminal. Secure the connectors by tightening the screws on both sides of the plug.
- Do not remove the ferrite cores attached to the cable.

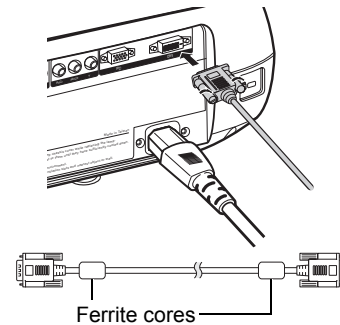

“Plug and Play” Function

- This projector is compatible with VESA-standard DDC 1/DDC 2B. The projector and a VESA DDC compatible computer automatically send settings, allowing for quick and easy setup.
- Before using the “Plug and Play” function, be sure to turn on the projector first and the computer last.

 **Note**

- The DDC “Plug and Play” function of this projector operates only when used in conjunction with a VESA DDC compatible computer.

Using the Adjustment Feet

Use the adjustment feet to level the projector when it is placed on an uneven surface or when the screen is slanted.

The projection can be made higher by adjusting the projector when it is in a location lower than the screen.

- 1 Press the foot releases and lift the projector to the desired angle.**
- 2 Remove your hands from the foot releases. When the adjustment feet have locked in position, place the projector down.**
 - If the screen is at an angle, the adjustment feet can be used to adjust the angle of the image.

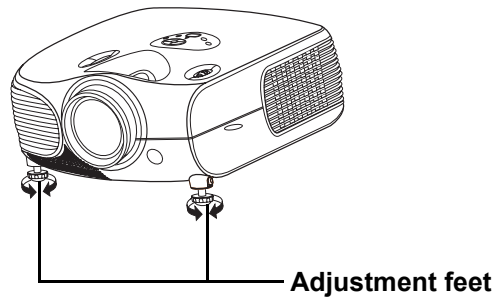
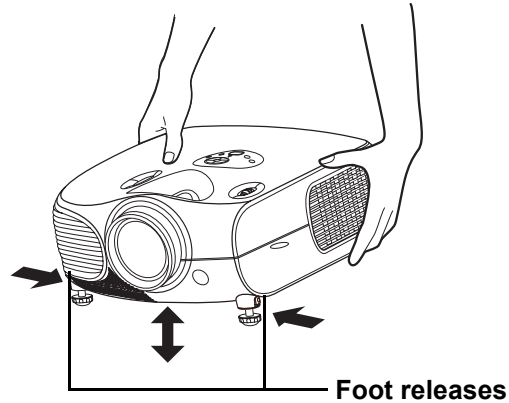

Notes

- The projector is adjustable up to approximately 11 degrees from the standard position.
- When the height of the projector is adjusted, the image may become distorted (keystoned), depending on the relative positions of the projector and the screen. See page 44 for details on keystone correction.

Info

- When lowering the projector, be careful not to catch your fingers in the area between the adjustment foot and the projector.

Adjusting the Lens

Adjust the lens using the focus and zoom rings to correct the image.

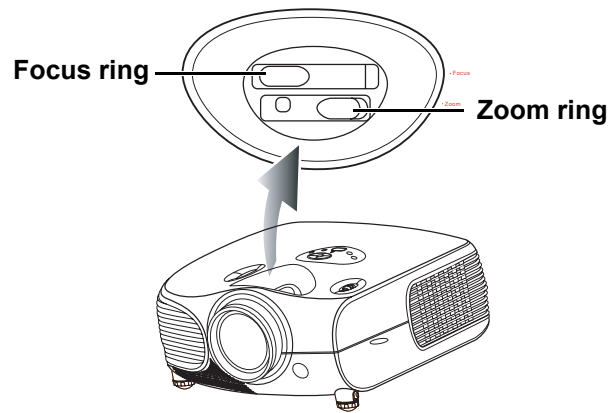

- 1 Adjust zoom by rotating the zoom ring.

Zoom ring

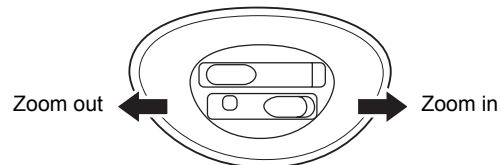

- 2 Adjust focus by moving the focus ring.

Focus ring

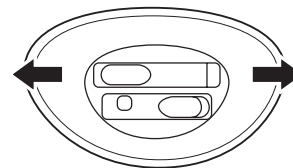

Using the Lens Shift

The height and width of the projected image can be adjusted to be within the shift range of the lens by rotating the lens shift dial at the top of the projector.

Note

- Do not forcibly turn the lens shift dial beyond the range of the upper left and lower right positions. This may cause the projector to malfunction.

Lens shift dial
(Vertical)

Lens shift dial
(Horizontal)

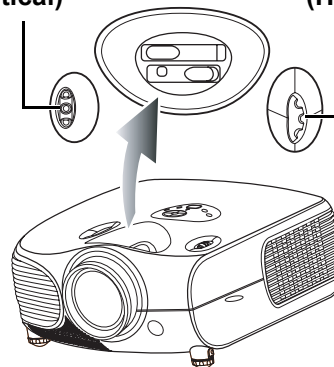

Setting up the Screen

Position the projector perpendicular to the screen with all feet flat and level to achieve an optimal image.

Notes

- The projector lens should be perpendicular (square-on) to the screen. If the horizontal line passing through the lens center is not perpendicular to the screen, the image will be distorted, making viewing difficult.
- For an optimal image, position the screen so that it is not in direct sunlight or room light. Light falling directly on the screen washes out the colors, making viewing difficult. Close curtains and dim the lights when setting up the screen in a sunny or bright room.
- A polarizing screen cannot be used with this projector.

Standard Setup (Front Projection)

- Place the projector at the required distance from the screen according to the desired picture size. (See page 23)

An Example of Standard Setup

Side View

Audience

Top View

- The distance from the screen to the projector depends on the size of the screen.
- The default setting can be used, when placing the projector in front of the screen. If the projected image is reversed or inverted, readjust the setting to "Front" for "PRJ Mode" in the "Options" menu.
- Place the projector so that an imaginary horizontal line that passes through the center of the lens is perpendicular to the screen.

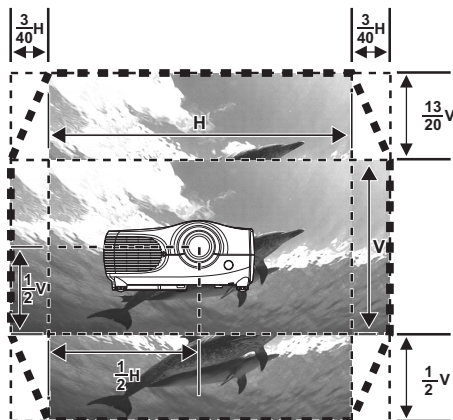

Notes

2D Lens Shift:

- The vertical display (Biggest) is (+13/20V / -1/2V) screen.
- The horizontal display (Biggest) is $\pm 3/40$ screen. ($\pm 15\%$)
- It is recommended that images be projected onto the dashed line octagonal area for fine image quality.
- There is a tolerance of $\pm 3\%$ in the formula above.

Screen Size and Projection Distance

When using a wide screen (16:9) project the image on the whole area of the 16:9 screen.

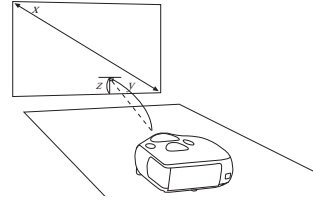
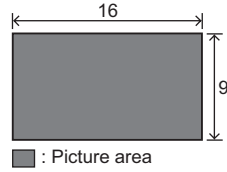

Screen Size (16:9)			Projection Distance		Distance from lens center to the lower edge of the image	
Diagonal	Width	Height	Max	Min	upper	lower
300" (762 cm)	261" (664 cm)	147" (374 cm)	37'6" (11.4 m)	29'10" (9.1 m)	0" (0 cm)	-12'3" (-374 cm)
250" (635 cm)	218" (553 cm)	123" (311 cm)	31'3" (9.5 m)	24'11" (7.6 m)	0" (0 cm)	-10'3" (-311 cm)
200" (508 cm)	174" (443 cm)	98" (249 cm)	24'12" (7.6 m)	19'11" (6.1 m)	0" (0 cm)	-8'2" (-249 cm)
150" (381 cm)	131" (332 cm)	74" (187 cm)	18'9" (5.7 m)	14'11" (4.6 m)	0" (0 cm)	-6'2" (-187 cm)
133" (338 cm)	116" (294 cm)	65" (166 cm)	16'7" (5.1 m)	13'3" (4.0 m)	0" (0 cm)	-5'5" (-166 cm)
106" (269 cm)	92" (234 cm)	52" (132 cm)	13'3" (4.0 m)	10'7" (3.2 m)	0" (0 cm)	-4'4" (-132 cm)
100" (254 cm)	87" (221 cm)	49" (125 cm)	12'6" (3.8 m)	9'11" (3.0 m)	0" (0 cm)	-4'1" (-125 cm)
92" (234 cm)	80" (204 cm)	45" (115 cm)	11'6" (3.5 m)	9'2" (2.8 m)	0" (0 cm)	-3'9" (-115 cm)
84" (213 cm)	73" (186 cm)	41" (105 cm)	10'6" (3.2 m)	8'4" (2.5 m)	0" (0 cm)	-3'5" (-105 cm)
72" (183 cm)	63" (159 cm)	35" (90 cm)	9'00" (2.7 m)	7'2" (2.2 m)	0" (0 cm)	-2'11" (-90 cm)
60" (152 cm)	52" (132 cm)	29" (75 cm)	7'6" (2.3 m)	6'00" (1.8 m)	0" (0 cm)	-2'5" (-75 cm)
40" (102 cm)	35" (89 cm)	20" (50 cm)	5'00" (1.5 m)	4'00" (1.2 m)	0" (0 cm)	-1'8" (-50 cm)

The formula for screen size and projection distance

$$y1(\text{max})=0.038089291x$$

$$y2(\text{min})=0.030344196x$$

$$z1(\text{Upper}) = 0$$

$$z2(\text{lower})=1.245263549x$$

x: Screen size (diag.) (meter)

y: Projection distance (feet)

z: Distance from the lens center to the lower edge of the image (centimeter)



Notes

- There is a tolerance of $\pm 3\%$ in the formula above.
- Values with a minus (-) sign indicate the distance of the lens center below the bottom of the image.

When using a normal screen (4:3) project the image to the full horizontal width of the 4:3 screen.

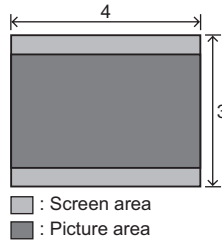

Screen Size (4:3)			Projection Distance		Distance from lens center to the lower edge of the image	
Diagonal	Width	Height	Max	Min	upper	lower
250" (635 cm)	200" (508 cm)	150" (381 cm)	28'8" (8.7 m)	22'10" (7.0 m)	0" (0 cm)	-9'5" (-286 cm)
200" (508 cm)	160" (406 cm)	120" (305 cm)	22'11" (7.0 m)	18'3" (5.6 m)	0" (0 cm)	-7'6" (-229 cm)
150" (381 cm)	120" (305 cm)	90" (229 cm)	17'2" (5.2 m)	13'8" (4.2 m)	0" (0 cm)	-5'8" (-171 cm)
133" (338 cm)	106" (270 cm)	80" (203 cm)	15'3" (4.6 m)	12'2" (3.7 m)	0" (0 cm)	-5'0" (-152 cm)
106" (269 cm)	85" (215 cm)	64" (162 cm)	12'2" (3.7 m)	9'8" (3.0 m)	0" (0 cm)	-4'0" (-121 cm)
100" (254 cm)	80" (203 cm)	60" (152 cm)	11'6" (3.5 m)	9'2" (2.8 m)	0" (0 cm)	-3'9" (-114 cm)
92" (234 cm)	74" (187 cm)	55" (140 cm)	10'7" (3.2 m)	8'5" (2.6 m)	0" (0 cm)	-3'5" (-105 cm)
84" (213 cm)	67" (171 cm)	50" (128cm)	9'8" (2.9 m)	7'8" (2.3 m)	0" (0 cm)	-3'2" (-96 cm)
72" (183 cm)	58" (146 cm)	43" (110 cm)	8'3" (2.5 m)	6'7" (2.0 m)	0" (0 cm)	-2'8" (-82 cm)
60" (152 cm)	48" (122 cm)	36" (91 cm)	6'11" (2.1 m)	5'6" (1.7 m)	0" (0 cm)	-2'3" (-69 cm)
40" (102 cm)	32" (81 cm)	24" (61 cm)	4'7" (1.4 m)	3'8" (1.1 m)	0" (0 cm)	-1'6" (-46 cm)

The formula for screen size and projection distance

$$y1 \text{ (Max.)} = 0.03466592x$$

$$y2 \text{ (Min.)} = 0.0276352x$$

$$z1 \text{ (Upper)} = 0$$

$$z2 \text{ (Lower)} = 1.143x$$

x: Screen size (diag.) (meter)

y: Projection distance (feet)

z: Distance from the lens center to the lower edge of the image (centimeter)

Notes

- There is a tolerance of $\pm 3\%$ in the formula above.
- Values with a minus (-) sign indicate the distance of the lens center below the bottom of the image.

Projection from behind the screen

Projecting a Reversed/Inverted Image

- Place a translucent screen between the projector and the audience.
- Set “PRJ Mode” to “Rear” in the “Options” menu.

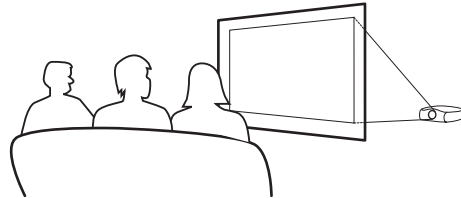

When using the default setting.

▼On-screen Display

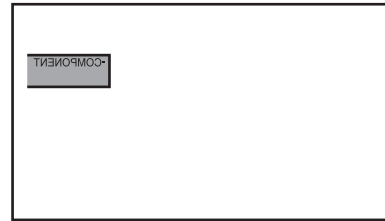

The image is reversed.

When using the default setting.

▼On-screen Display

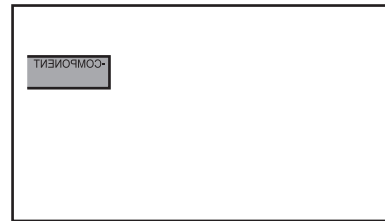

The image is reversed.

Projection using a mirror

- Place a mirror (normal flat type) in front of the lens.
- Set “PRJ Mode” to “Rear” in the “Options” menu, when the mirror is placed on the side where the audience is.

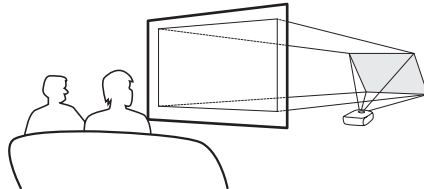

Info

- When using a mirror, be sure to carefully position both the projector and the mirror so that the light does not shine into the eyes of the audience.

Ceiling-mount setup

- The optional ceiling-mount bracket is recommended for this installation.
- Before mounting the projector, contact your nearest Authorized Service Center or Dealer to obtain the recommended ceiling-mount bracket (sold separately).
- Adjust the position of the projector to match the distance (Z) from the lens center position to the lower edge of the image, when mounting the projector on the ceiling.
- Invert the image by setting “Ceiling + Front” for “PRJ Mode” in the “Options Menu”.

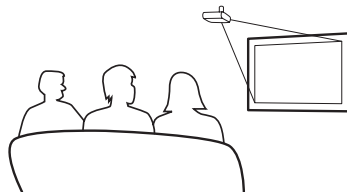

When using the default setting.

▼On-screen Display

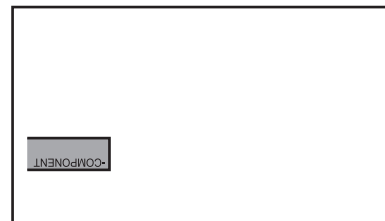

The image is reversed.

NOTES

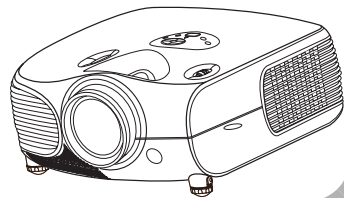

Basic Operation

Image Projection

Basic Procedure

Connect the required external equipment to the projector before following these procedures.

Info

- The preset language is English. To change the on-screen display to another language, reset the language according to the procedure on page 30.

1 Plug the power cord into the wall outlet.

- The power indicator illuminates blue, and the projector enters standby mode.

2 Press on the remote control or on the projector.

- The power indicator turns off.

Note

- The power indicator illuminates, indicating the status of the lamp.
Blue: The power is ready.
Blue blinking: The fan is cooling.

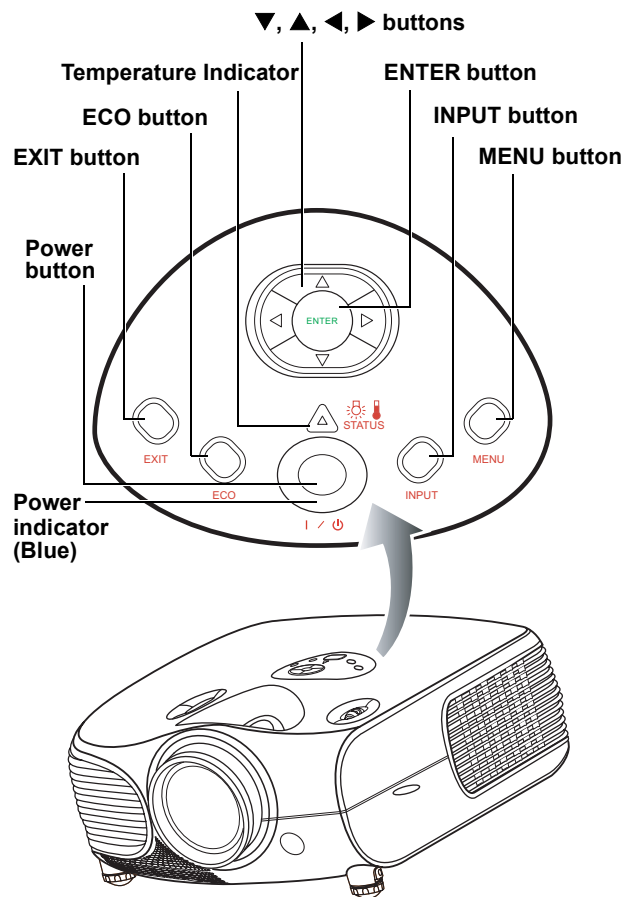

3 Press  on the projector to select the **INPUT** mode.

About the INPUT modes

S-Video	Use this option to select the S-Video input source.
Video	Use this option to select the composite video input source.
Component 1&2	Use this option to select a YPbPr, SDTV, or HDTV component input source.
DVI	Use this option to select the DVI input source.
PC	Use this option to select the computer as an input source.



 **Note**

- When a signal is not received, "Searching" will be displayed.

 **Note**

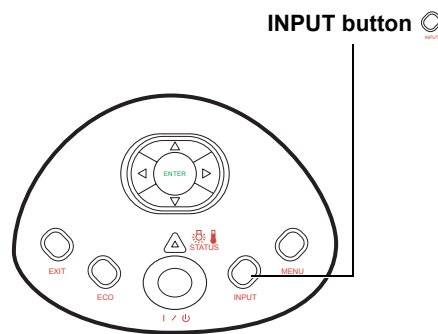
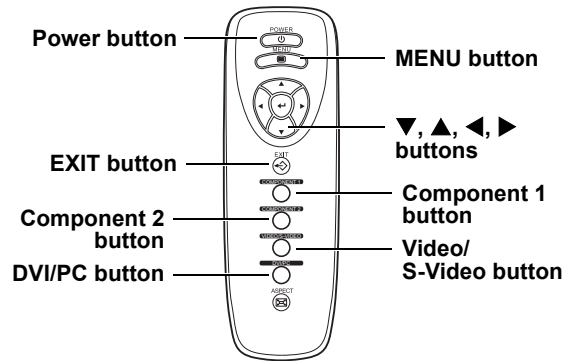
- If you select "Auto" as the input source, then the correct input source is selected automatically.



4 Press  on the remote control or  on the projector. Press  Enter to turn off the projector, when the confirmation message is displayed.

 **Note**

- If you accidentally press power  and do not want to turn off the projector, press Exit button or wait until the confirmation message disappears.
- Do not unplug the power cord during projection or cooling fan operation. This can cause damage due to the rise in internal temperature, as the cooling fan also stops.

Main Menu

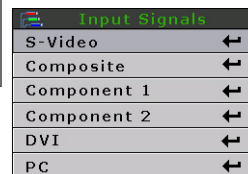
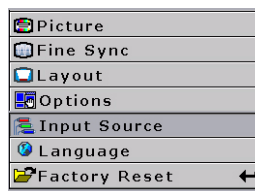

Selecting the On-screen Display Language

- The on-screen display language of the projector can be set to English, Français, Italiano, Deutsch, Español, 中文, 日本語, or 한국어 .

- Press “MENU”.
 - The menu displays.
 - Press ◀ or ▶ to select “Language”.
 - Press ▲ or ▼ to select the desired language, then press ◀.
- The selected language is set as the on-screen display.
- Press “EXIT”.

Main Menu

Picture	
Fine Sync	
Layout	
Options	
Input Source	
Language	
Factory Reset	◀

Language	
English	◀
Français	◀
Italiano	◀
Deutsch	◀
Español	◀
中文	◀
日本語	◀
한국어	◀

Menu Bar Items

This list shows the items that can be set in the projector.

■ Composite Video/S-Video, DVI Mode

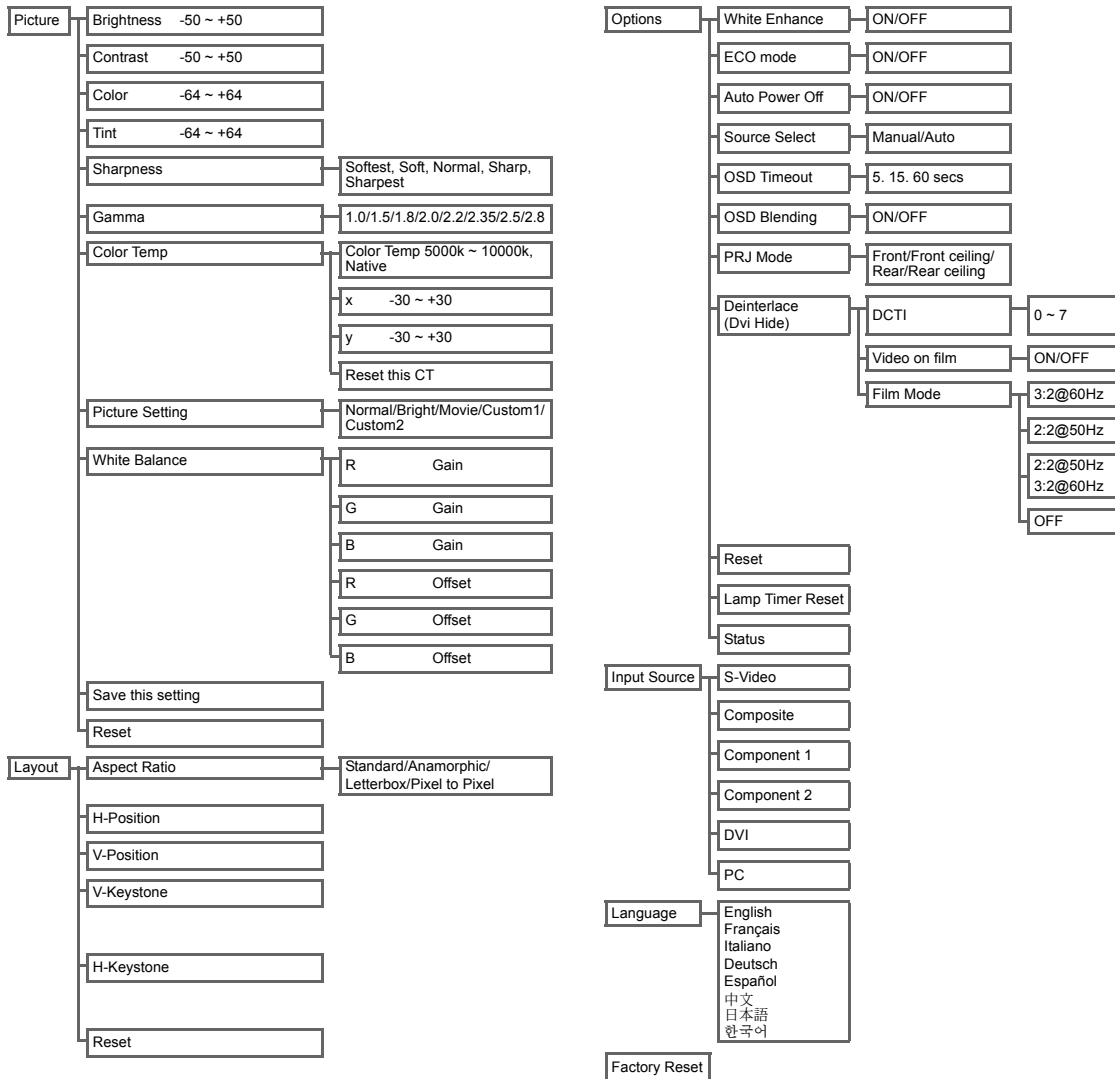

■ PC/Component 1&2 Mode

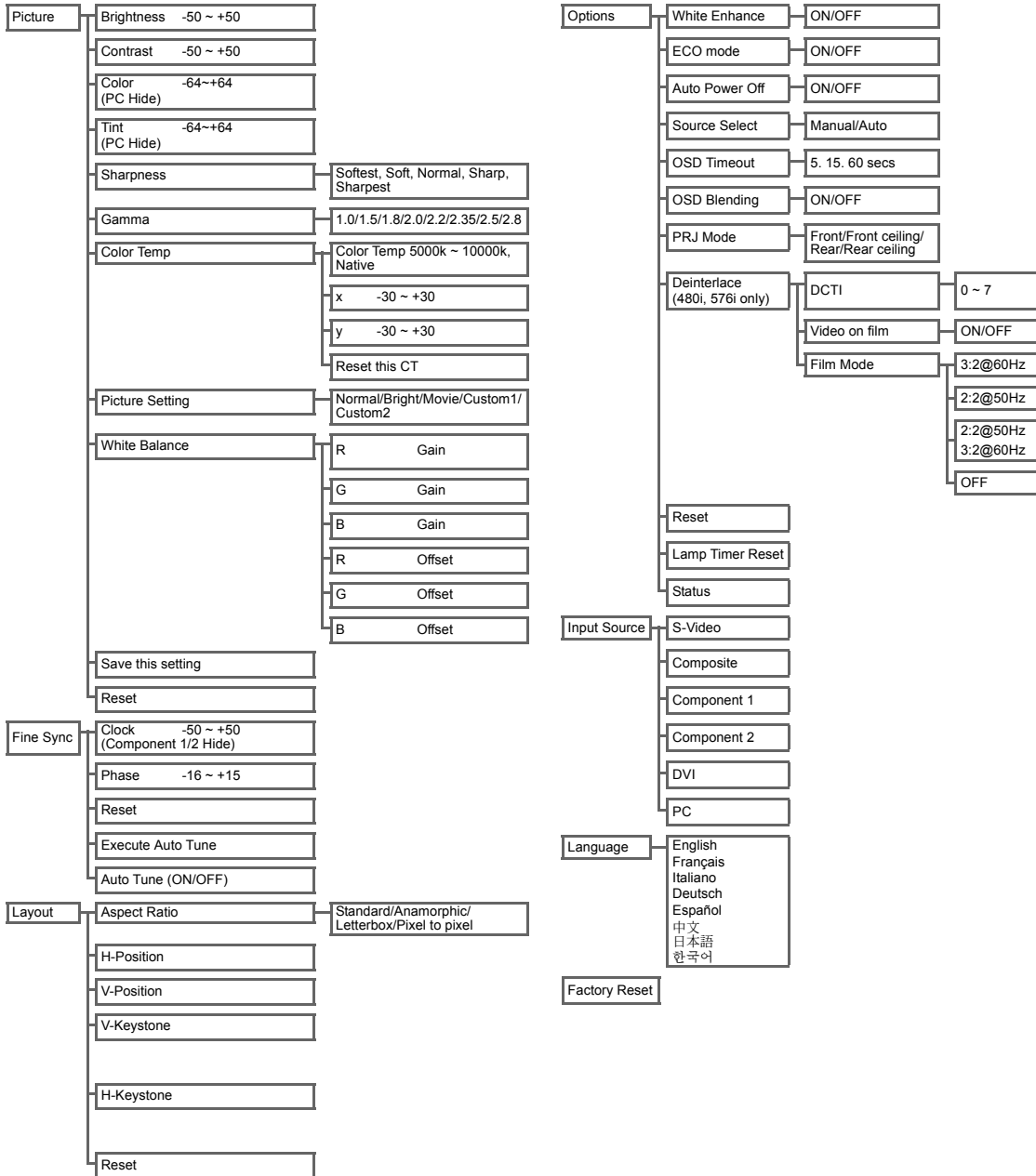

Using the Menu Screen

You can use the menu screens to adjust the image and projector settings. You can operate the menus from the projector or remote control using the following procedure.

Menu Selections (Adjustments)

- 1 Press on remote or on the keypad.

- The menu screen is displayed.

Note

- The “Picture” menu screen for the selected input mode is displayed.

- 2 Press or to select the menu you want to adjust.

- 3 Press or to reach the Sub-menu and then press or to select the item you want to adjust.

Note

- The selected item will be highlighted.

- 4 Press or to adjust the item selected.

- The adjustment is stored.

- 5 Press to return to “Main MENU”.

- 6 Press to close the menu screen.

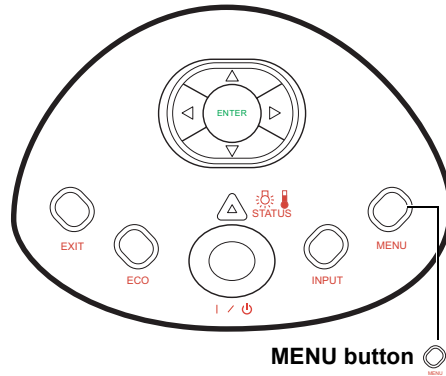

MENU button

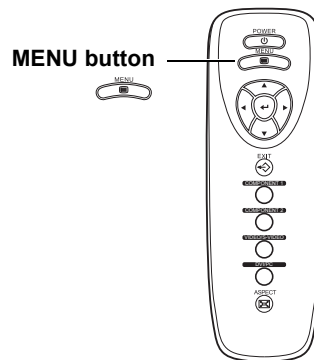

MENU button

Main Menu

Picture
Fine Sync
Layout
Options
Input Source
Language
Factory Reset

Picture	
Brightness	0
Contrast	0
Color	0
Tint	0
Sharpness	Sharpest
Gamma	Gamma 1.0
Color Temp	5000K
Picture Setting	Normal
White Balance	←
Save This Setting	←
Reset	←



Adjusting the Image

You can adjust the image with the following procedure.

Main Menu

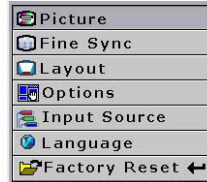

Selected item	Description		
Brightness	Adjusts the brightness	Decreases brightness	Increases brightness
Contrast	Adjusts the contrast level	Decreases contrast	Increases contrast
Color	Adjusts the color intensity	Decreases color intensity	Increases color intensity
Tint	Adjusts the tones	Skin tones become purplish	Skin tones become greenish

Brightness

Use this option to adjust the overall brightness of the image. Use in conjunction with contrast to fine-tune the display. The scale is from -50 to 50. The default setting is 0.



Contrast

Use this option to adjust the contrast of the image. Use this control in conjunction with contrast to fine-tune the display. The scale is from -50 to 50. The default setting is 0.



Color

Use this option to adjust the color intensity of the image.



Tint

Use this option to adjust the tint of your image. Press ► to make the image more green. Press ◀ to make the image more purple.



Sharpness

Use this option to adjust the clarity and focus of the image.

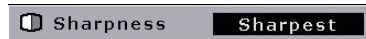

Color TEMP

Use this option to set the color temperature of the image. Higher color temperatures make the image look cool with a bluish hue. Lower color temperature makes the image look warmer with a reddish hue. The range is from 5000°K to 10000°K, in 500°K increments. When set to "NATIVE", the image has the maximum brightness.

Select x, y to adjust the color temperature.
For example:

- When you adjust the x, ►, y, ◀, the image will look red.
- When you adjust the x, ◀, y, ◀, the image will look blue.
- When you adjust the x, ◀, y, ►, the image will look green.
- When you adjust the x, ►, y, ►, the image will look yellow.

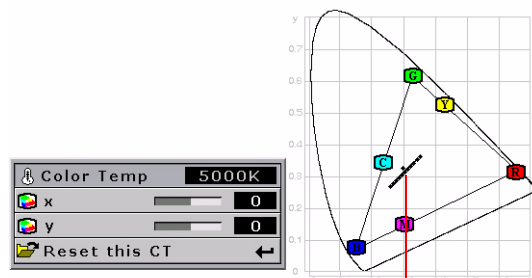

The point will move in the Black Body Curve.

Gamma

Use this option to adjust the gamma correction of the image. There are seven non-linear gamma corrections 1.0, 1.5, 1.8, 2.0, 2.2, 2.35, 2.5, and 2.8. The default setting is 2.2.



White Balance

The contrast and brightness for each color of the RGB Gain & Offset values in DLP can be individually adjusted.

White Balance	
R Gain	- 0 -
G Gain	- 0 -
B Gain	- 0 -
R Offset	- 0 -
G Offset	- 0 -
B Offset	- 0 -

Picture setting

This function stores Brightness, Contrast, Color, Tint, Sharpness, Gamma, Color Temp, Color Type, and White Enhance set in "Picture". Each stored setting is reassigned to each input mode.



Select "Picture Setting" from the "Picture" menu on the menu screen.
→For operating the menu screen, see page 33.

Note

- **When Recalling Saved Contents:**
When a saved memory number is selected, the contents of the "Picture" menu changes to the adjustment values of the saved memory number.
- **When Editing Saved Contents:**
Edit the contents of the "Picture" menu after selecting the memory number for which adjustment values are to be edited.

Save this setting

Use this option to save changes you made in "Picture setting" to custom 1 or custom 2.

Reset

Select this option to set to all items in the "Picture" menu to the factory default values.

Adjusting Computer Images

(Computer Source Signal Only)

Use the Fine Sync function in case of irregularities such as vertical stripes or flickering in portions of the screen.

When Auto Tune is OFF

When “Auto Tune” is “OFF”, interference such as flickering or vertical stripes may occur when displaying tiling or vertical stripes. Should this occur, adjust “Clock” and “Phase”, to obtain an optimum image.

Select “Clock”, “Phase”, in the “Fine Sync” menu on the menu screen.
For operating the menu screen, see page 33.

Main Menu

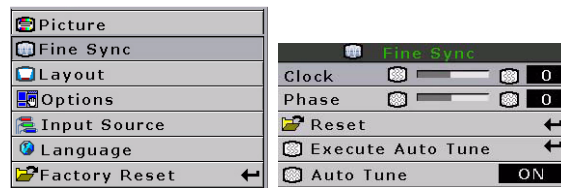

Selected item	Description
Clock	Adjusts vertical noise.
Phase	Adjusts horizontal noise (similar to tracking on your VCR).

Auto Tune adjustment

Automatically adjusts a computer image.

Select “Execute Auto Tune” from the “Fine Sync” menu on the menu screen.

For operating the menu screen, see page 33.

Screen display during Auto Tune

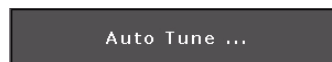

Note



- Auto Tune may take some time to complete, depending on the image stored in the computer connected to the projector.

Easy to Use Functions

Selecting the Picture Display Mode

You can modify the picture display mode to enhance the input image. Depending on the input signal, you can choose “Standard”, “LetterBox”, “Anamorphic” or “Pixel to Pixel” image.

Switching the Picture Display using Different input signals

Press  on the remote or  on the projector and select a layout.

- Pressing  cycles through the display modes

Info

- In the Pixel to Pixel Mode, images are displayed in the original resolution, and are not scalable.

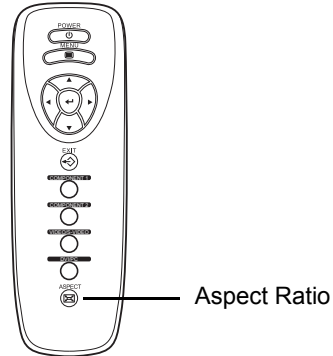

Aspect Ratio Function

You can control how the projector resizes the input image.

The following option are available:

Anamorphic

- Resolution 1280 × 720
- 4:3 input is stretched to fit 16:9 display
- Stretches entire image.

Pixel to Pixel

- Maintains input signal resolution. May have black borders around image.

Standard

- Resolution depends on the Input Signal
- 4:3 input scaled to fit display height
- Width scaled to maintain 4:3 aspect ratio
- Black bars on left and right (taking up 25% of the whole display)

LetterBox

- Resolution 1280 × 720
- 4:3 input scaled to fit display width
- Height scaled to maintain 4:3 aspect ratio: 1280 × 960
- 25% of the entire image on the top and bottom is cropped.

Main Menu

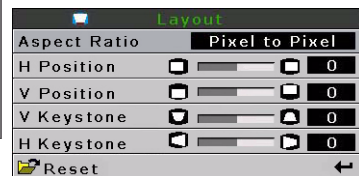
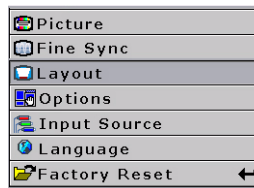

VIDEO

		Standard	Letterbox	Anamorphic	Pixel to Pixel
For 4:3 aspect ratio	480i 480P 576i 576P NTSC PAL SECAM	768X576	1280X720	1280X720	640X480i 640X480P 768X576i 768X576P 640X480 768X576 768X576
For 16:9 aspect ratio	480P 576P	768X576 768X576	1280X720 1280X720	1280X720	720X480 720X576
	720P	–	–	1280x720	–
	1080i	–	–	1280x720	–

	Input Signal	Output screen image			
		Standard	Letterbox	Anamorphic	Pixel to Pixel
480I 480P 576I 576P NTSC PAL SECAM	For 4:3 aspect ratio 	*			
	Letter box image 	*	*		
1080I	For 16:9 aspect ratio 			*	
720P				*	

Easy to Use Functions

COMPUTER

		Standard	Anamorphic	Pixel to Pixel
For 4:3 aspect ratio	VGA(640X480)	960X720	1280X720	640X480
	SVGA(800X600)	960X720	1280X720	800X600
	XGA(1024X768)	960X720	1280X720	1024X768

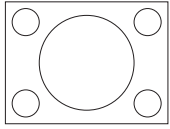
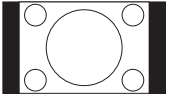
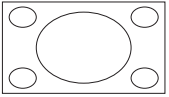
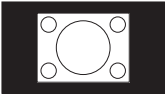
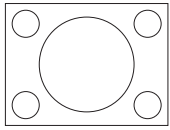
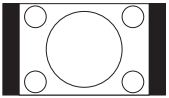
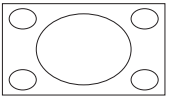
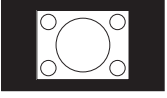
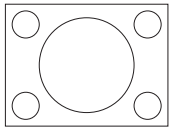
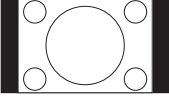
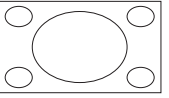
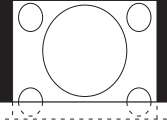
	Input Signal	Output screen image		
		Standard	Anamorphic	Pixel to Pixel
VGA	 <p>For 4:3 aspect ratio (640x480)</p>			
SVGA	 <p>For 4:3 aspect ratio (800x600)</p>			
XGA	 <p>For 4:3 aspect ratio (1024x768)</p>			

H-V Position Function

Use this to center the display vertically and horizontally.

- 1 In H Position, press “◀” or “▶”.
The display moves left or right.

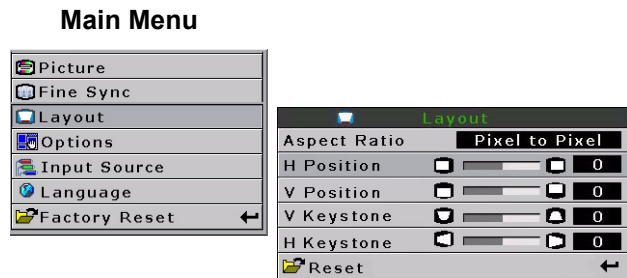

- 2 In V Position, press “◀” or “▶”.
The display moves upward or downward.

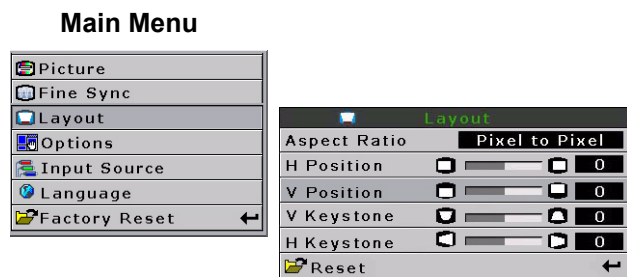

H-V Keystone Function

Correcting Trapezoidal Distortion and Adjusting Vertical Size.

This function allows for Keystone correction.

Note

- When the image is projected at an angle, the image becomes distorted trapezoidally. The function for correcting trapezoidal distortion is called Keystone Correction.

(On-screen Trapezoidal Distortion)

Correction and the adjustment of the vertical size of the picture.

Main Menu

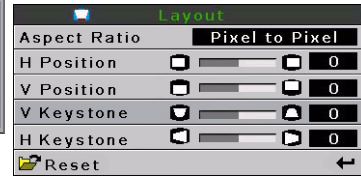
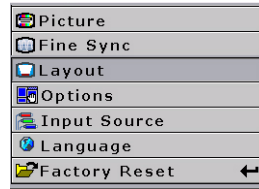

- Select "V-Keystone" or "H-Keystone" in the layout.

Selected item	Description
H Keystone	Horizontally adjusts the keystone settings.
V Keystone	Vertically adjusts the keystone settings.

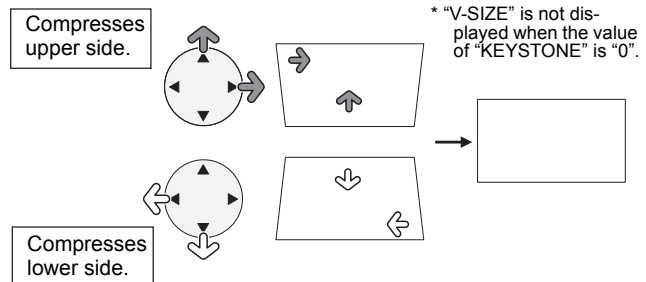

- Press "◀" or "▶" to adjust the keystone correction.

Note

- Straight lines or the edges of images may appear jagged while adjusting the image.

Horizontal Keystone Correction

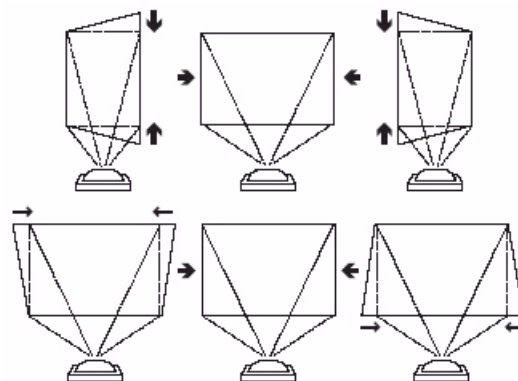

Vertical Keystone Correction

White Enhance

White enhance emphasizes the bright portions of images.

Main Menu

Picture
Fine Sync
Layout
Options
Input Source
Language
Factory Reset

Options	
White Enhance	ON
ECO. Mode	ON
Auto Power Off	ON
Source Select	Auto
RS-232C	9600
OSD Timeout	5 secs
OSD Blending	OFF
PRJ Mode	Rear
Deinterlace	←
Reset	←
Lamp Timer Reset	←
Status	

Selecting the Economy Mode

Economy mode reduces the power consumption of the projector.

Setting the Power Save

Select "ON" from the "Economy Mode" in the "Options" menu.

For operating the menu screen, see page 33.

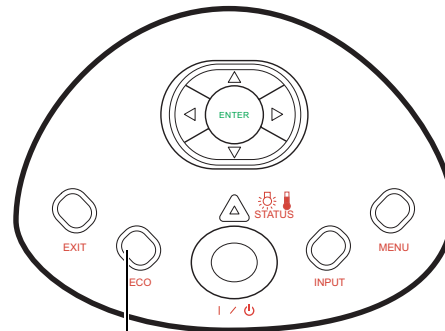

ECO Mode

Note

- Although noise is reduced when "ECO" is set to "ON", brightness decreases by 20%.
- "ECO" mode is "ON" by default.

Main Menu

Picture
Fine Sync
Layout
Options
Input Source
Language
Factory Reset

Options	
White Enhance	ON
ECO. Mode	ON
Auto Power Off	ON
Source Select	Auto
RS-232C	9600
OSD Timeout	5 secs
OSD Blending	OFF
PRJ Mode	Rear
Deinterlace	←
Reset	←
Lamp Timer Reset	←
Status	

Status	Brightness	Power consumption
ON (Low power mode)	80%	270W@110V
OFF (Standard mode)	100%	340W@110V

Easy to Use Functions

Automatic Power Off Function

When set to “ON”, the Auto Power Off switches the projector off if an input signal is not detected or you do not press any controls for 15 minutes.

Auto Power Off is disabled when set to “OFF”.

Select “Auto Power Off” from the “Options” menu on the menu screen. For operating the menu screen, see page 33.

Note

- When the Auto Power Off function is set to “ON”, a warning, “Power OFF in 5 min.” displays five minutes before the power turns off.

Main Menu

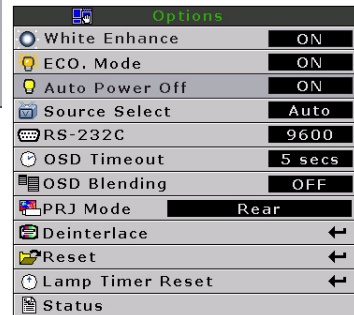
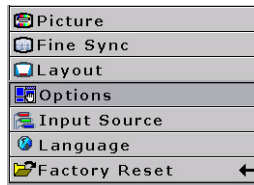

Source Select

This selects the input source automatically if no signal is detected on the current input.



Select “source select” from the “Options” menu on the menu screen. For operating the menu screen, see page 33.

Main Menu

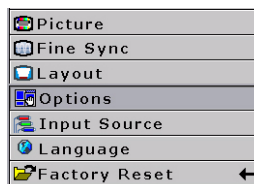

OSD Timeout

OSD Timeout is used to set how long the OSD stays open if no buttons are pressed.

OSD Timeout	5
	15
	60

Main Menu

- Picture
- Fine Sync
- Layout
- Options
- Input Source
- Language
- Factory Reset ←

- Options
- White Enhance ON
 - ECO. Mode ON
 - Auto Power Off ON
 - Source Select Auto
 - RS-232C 9600
 - OSD Timeout 5 secs
 - OSD Blending OFF
 - PRJ Mode Rear
 - Deinterlace ←
 - Reset ←
 - Lamp Timer Reset ←
 - Status

OSD Blending

This allows you to set the transparency of the OSD menu. When set to transparent, you can see the image behind the menu.

Select “OSD Blending” from the “Options” menu on the menu screen. For operating the menu screen, see page 33.

Selected item	Description
ON	OSD background will blend
OFF	Normal

Main Menu

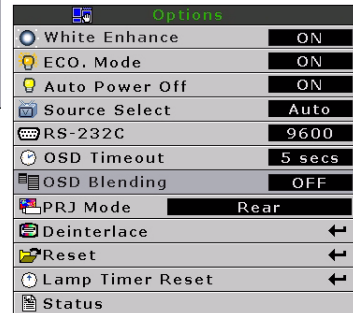
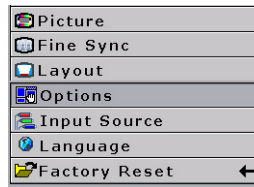

Reversing/Inverting Projected Images

The projector can reverse and invert images for various projection methods.

Setting the Projection Mode

Select “Projection Mode” from the “Options” menu on the menu screen. For operating the menu screen, see page 33.

Selected item	Description
Front	Normal image
Ceiling + Front	Inverted image
Rear	Reversed image
Ceiling + Rear	Reversed and inverted image

Main Menu

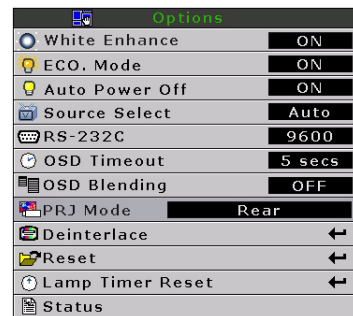
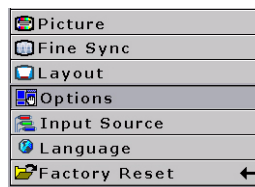

Note

- This function can be used for the reversed image and ceiling-mount setups.

Deinterlace

There are several different deinterlacing algorithms. Choose the setting that best matches the content you are watching.

Select “Deinterlace” from the “Options” menu on the menu screen. For operating the menu screen, see page 33.

Selected item	Description
DCTI	Enhances video by replacing the edges of the video with edges that have steeper rise and fall times. DCTI turns sloped or sinusoidal waveforms into rectangular or square waveforms with the same duty cycles and peak-to-peak amplitude. It is useful for 4:1:1 video sources. The range is from 0 to 7.
Video on film (VOF)	Identifies video artifacts while in film mode. VOF attempts to repair the artifacts using the low-angle interpolator while remaining in film mode.
Film Mode	Reproduces the image of the film source clearly. Displays the optimized image of film transformed with 3:2 pull down (NTSC and PAL60Hz) or 2:2 pull down (PAL 50Hz and SECAM) enhancement to progressive mode images.

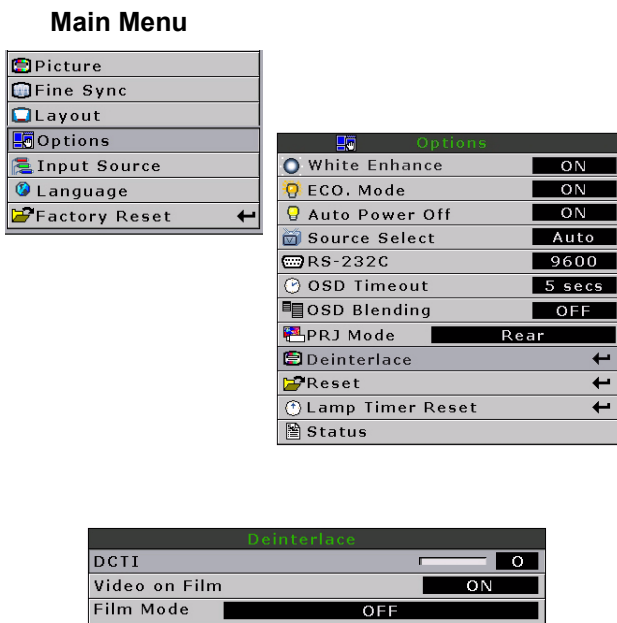

Note

- In PAL50Hz or SECAM, the 2:2 pull down enhancement is enabled only in film mode, after the film source has been entered.

Reset

This resets all values in the “Option” menu to the factory defaults.

Main Menu

Picture
Fine Sync
Layout
Options
Input Source
Language
Factory Reset ←

Options	
White Enhance	ON
ECO. Mode	ON
Auto Power Off	ON
Source Select	Auto
RS-232C	9600
OSD Timeout	5 secs
OSD Blending	OFF
PRJ Mode	Rear
Deinterlace	←
Reset	←
Lamp Timer Reset	←
Status	

Lamp Timer Reset

The projector keeps a record of the total time the lamp has been in use. You should reset the timer after you install a new lamp. The total lamp usage time is shown in the Status Screen.

Main Menu

Picture
Fine Sync
Layout
Options
Input Source
Language
Factory Reset ←

Options	
White Enhance	ON
ECO. Mode	ON
Auto Power Off	ON
Source Select	Auto
RS-232C	9600
OSD Timeout	5 secs
OSD Blending	OFF
PRJ Mode	Rear
Deinterlace	←
Reset	←
Lamp Timer Reset	←
Status	



Status Screen

The Status screen displays information about the current input signal.

Main Menu

Picture
Fine Sync
Layout
Options
Input Source
Language
Factory Reset ←

Options

White Enhance	ON
ECO. Mode	ON
Auto Power Off	ON
Source Select	Auto
RS-232C	9600
OSD Timeout	5 secs
OSD Blending	OFF
PRJ Mode	Rear
Deinterlace	←
Reset	←
Lamp Timer Reset	←
Status	

S-Video	Component 1
Resolution	676x460
Vert Freq	60Hz
Horz Freq	30KHz
Lamp Timer	30H

Factory reset

This resets all setting to the factory defaults. The logo is shown for about 20 seconds, then the projector is reset.

Main Menu

Picture
Fine Sync
Layout
Options
Input Source
Language
Factory Reset ←

Factory Reset ...

Screen display during Factory Reset

Easy to Use Functions

NOTES

Easy to Use Functions

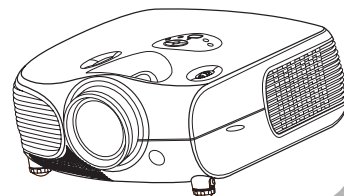

Appendix

Maintenance

Cleaning the projector

- Unplug the power cord before cleaning the projector.
- Avoid using benzene or thinner, as these can damage the finish on the cabinet and operation panel.
- Do not use volatile agents, such as insecticides, on the projector.
- Do not leave rubber or plastic objects in contact with the projector for long periods, as they may damage the finish of the projector.

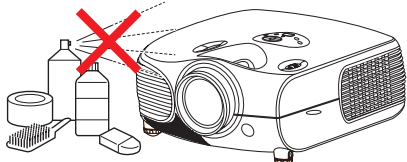

- Wipe off dirt gently with a soft flannel cloth.
- For hard-to-remove dirt, soak a cloth in a neutral detergent diluted with water, wring the cloth well and then wipe the projector.
Strong cleaning detergents may discolor, warp or damage the coating on the projector. Make sure to test on a small, inconspicuous area on the projector before using.

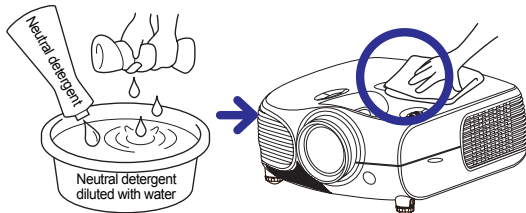

Cleaning the lens

- Use a commercially available blower or lens cleaning paper (for glasses and camera lenses) for cleaning the lens. Do not use any liquid cleaning agents, as they may wear off the coating film on the surface of the lens.

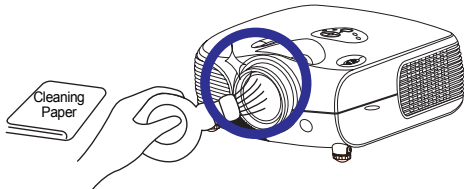

- The surface of the lens is easily damaged, do not to scrape or hit the lens.

Cleaning the exhaust and intake vents

- Use a vacuum cleaner to clean dust from the exhaust vent and the intake vent.

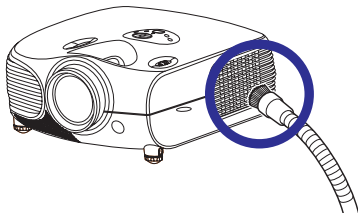

Cleaning the Ventilative Holes

- This projector has ventilative holes to ensure the optimal operating condition of the projector.
- Periodically clean the ventilative hole by vacuuming it off with a vacuum cleaner.
- The ventilative holes should be cleaned every 100 hours of use. Clean the ventilative holes more often when the projector is used in dirty or smoky locations.

Side and Rear view

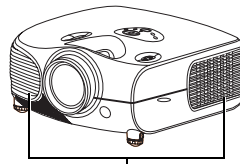

Ventilative holes

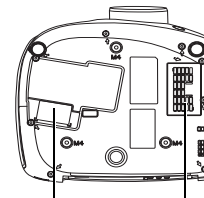

Bottom view



Ventilative holes

Cleaning the Ventilative Holes

- 1 Turn off the power and disconnect the power cord.**

Press  on the projector or  on the remote control to turn off the power. Wait until the cooling fan stops.

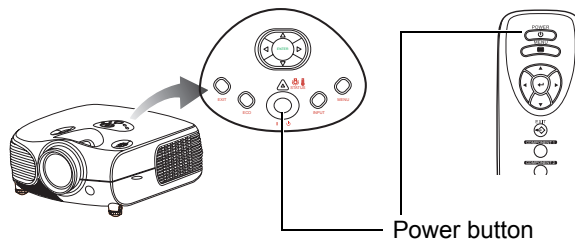

- 2 Unplug the Power Cord.**

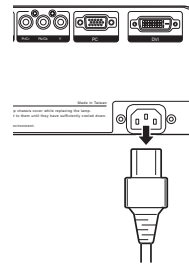

- 3 Clean the dust off by placing the cleaner hose on the intake and exhaust ventilative holes.**

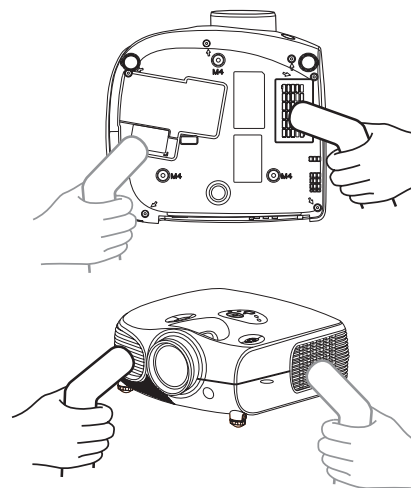

About the Lamp

The projector lamp has a life of 2000 hours. Maintain proper ventilation to keep the lamp operating throughout its lifetime. Do not subject the projector to unnecessary vibration to ensure that the lamp does not break.

- It is recommended that the lamp (sold separately) be replaced after approximately 2,000 cumulative hours of use or when you notice a significant deterioration in the picture and color quality. The number of hours the lamp has been used can be checked with “Lamp Timer” in the “Options” menu on the menu screen.
- For lamp replacement, please consult your nearest authorized service center or sealer.
- The actual lamp service life may be less than 2000 hours depending on the environment in which the projector is used.

Caution Concerning the Lamp

- This projector uses a pressurized mercury lamp. A loud sound may indicate lamp failure. Lamp failure is caused by excessive shock, improper cooling, surface scratches or deterioration of the lamp due to usage. The period of time up to failure largely varies depending on the individual lamp and/or the condition and the frequency of use. It is important to note that failure can often result in the bulb cracking.
- When the lamp replacement indicator and on-screen display icon are illuminated or are flashing, it is recommended that the lamp be replaced immediately, even if the lamp appears to be operating normally.
- If the lamp breaks glass particles may spread inside the lamp cage or gas contained in the lamp may be vented into the room from the exhaust vent. As the gas in this lamp contains mercury, ventilate the room well if the lamp breaks and avoid all exposure to the released gas. In case of exposure to the gas, consult a doctor as soon as possible.
- If the lamp breaks, there is also a possibility that glass particles may spread inside the projector. If this happens, it is recommended you contact your nearest authorized dealer to remove the damaged lamp and assure safe operation.

Replacing the Lamp



CAUTION! Do not remove the lamp unit immediately after operation of the projector. The lamp will be hot and touching it may cause injury. Wait at least one hour after the power cord is disconnected to allow the surface of the lamp unit to fully cool before removing the lamp unit.

Temperature LED (Over Temperature)

The over temperature alarm LED on the control panel alerts you when the projector lamp becomes too hot.

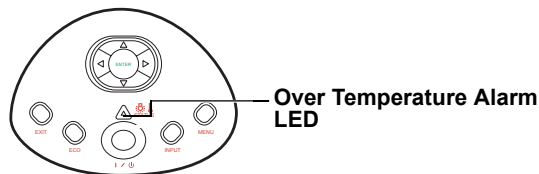

If the LED illuminates during operation, the lamp will shut off and the cooling fans will continue to run for approximately two minutes. You should ensure that the airflow around the projector is sufficient, and that the air filters are not clogged to ensure that the projector has proper ventilation.

Over Temperature !



When the temperature LED lights up, a warning also appears on the screen.

Removing and Installing the Lamp Unit

Follow these instructions to replace the lamp.

- Remove the lamp unit by the handle. Do not touch the glass surface of the lamp unit or the inside of the projector.
- To avoid injuring yourself and damage to the lamp, carefully follow the steps below.
- Do not loosen other screws except for the lamp unit cover and lamp unit.

(Only the silver screws are loosened).

1. **If the projector is running, press  on the projector or  on the remote control to turn off the power. Wait until the cooling fan stops.**

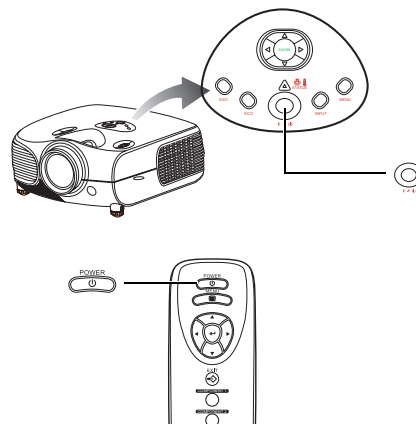

Warning!

Do not remove the lamp unit from the projector immediately after use. The lamp will be very hot and may cause injury.

2. **Disconnect the power cord and wait at least an hour for the lamp to cool.**

3. **Remove the lamp unit cover.**

- Loosen the user service screw that secures the lamp unit cover. Then open the cover in the direction of the arrow.

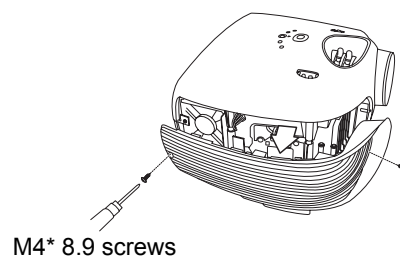

4. Remove the lamp unit.

- Loosen the securing screws from the lamp unit. Hold the lamp unit by the handle and pull it in the direction of the arrow.

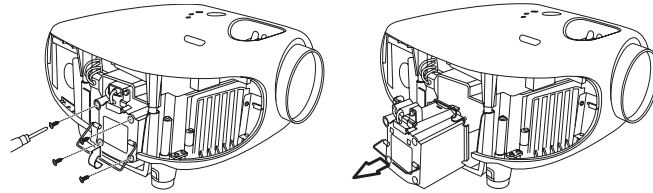

5. Insert the new lamp unit.

- Press the lamp unit firmly into the lamp unit compartment. Fasten the securing screws.
- Attach the lamp unit cover.
- Close the lamp unit cover in the direction of the arrow (to the close mark) on the side of the projector.
- Tighten the user service screw.

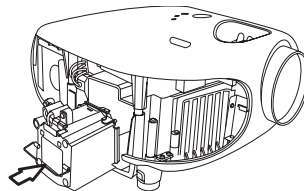

Info

- If the lamp unit and lamp cover are not correctly installed, the power will not turn on, even if the power cord is connected to the projector.

Resetting the Lamp Timer

Reset the lamp timer after replacing the lamp.

1. Connect the power cord.

- Plug the power cord into the AC socket of the projector.

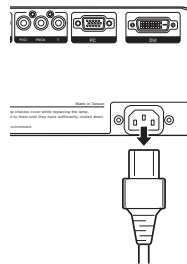

2. Reset the lamp timer.

- While holding down , and on the projector, press on the projector. (See page 50)
- "LAMP 0H" is displayed, indicating that the lamp timer is reset.

Info

Make sure to reset the lamp timer only when replacing the lamp. If you reset the lamp timer and continue to use the same lamp, this may cause the lamp to become damaged or explode.

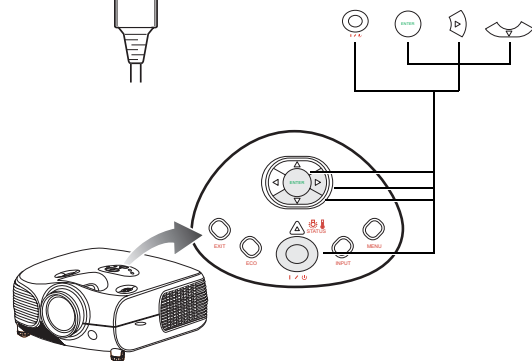

Connecting Pin Assignments

DVI-D port: 25 pin connector

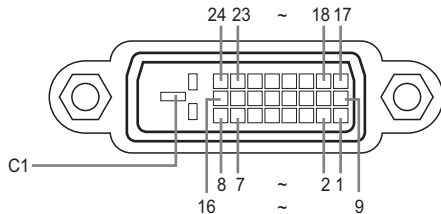

• DVI Digital INPUT

Pin No.	Signal	Pin No.	Signal
1	T.M.D.S data 2-	16	Hot plug detection
2	T.M.D.S data 2+	17	T.M.D.S data 0-
3	T.M.D.S data 2 shield	18	T.M.D.S data 0+
4	Not connected	19	T.M.D.S data 0 shield
5	Not connected	20	Not connected
6	DDC clock	21	Not connected
7	DDC data	22	T.M.D.S clock shield
8	Not connected	23	T.M.D.S clock+
9	T.M.D.S data 1-	24	T.M.D.S clock-
10	T.M.D.S data 1+	C1	Ground
11	T.M.D.S data 1 shield		
12	Not connected		
13	Not connected		
14	+5V power from graphic card.		
15	Ground		

RS-232C Port: 9-pin D-sub Female connector of the DIN-D-sub RS-232Cvt cable pin connector

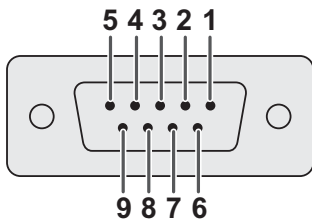

Pin No.	Signal	Name	I/O	Reference
1				Not connected
2	SD	Send Data	Input	Connected to internal circuit
3	RD	Receive Data	Output	Connected to internal circuit
4				Not connected
5	SG	Signal Ground		Connected to internal circuit
6				Not connected
7				Not connected
8				Not connected
9				Not connected

Computer Compatibility Chart

Computer

- Multiple signal support
Horizontal Frequency: 25–75 kHz, Vertical Frequency: 50–85 Hz, Pixel Clock: 25–108 MHz
- Compatible with sync on green and composite sync signals
- XGA compatible with advanced intelligent compression

The following is a list of modes that conform to VESA. However, this projector supports other signals that are not VESA standards.

PC/MAC/WS	Resolution	Horizontal Frequency (kHz)	Vertical Frequency (kHz)	VESA Standard	DVI Support
PC	640 x 350	31.5	70		✓
		31.5	60		
	640 x 480	37.9	72	✓	
		37.5	75	✓	
		43.3	85	✓	

PC/MAC/WS	Resolution	Horizontal Frequency (kHz)	Vertical Frequency (kHz)	VESA Standard	DVI Support	
PC	SVGA	800 x 600	35.1	56	✓	✓
			37.9	60		
			48.1	72		
			46.9	75		
	XGA	1024 x 768	48.4	60	✓	✓
			56.5	70		
			60.0	75		
			68.7	85		
MAC 13"	VGA	640 x 480	34.9	67		
MAC 16"	SVGA	832 x 624	49.6	75		
MAC 19"	XGA	1024 x 768	48.4	60	✓	

Resolution	Horizontal Frequency (kHz)	Vertical Frequency (kHz)	VESA Standard	DVI Support	Display	
DVI	720 x 480	31.5	60		✓	Upscale
	720 x 576	31.3	50			
	1280 x 720	45	60			
		37.5	50			
	1980 x 1080i	33.8	60			
28.1		50				

Note

- This projector may not be able to display images from notebook computers in simultaneous (CRT/LCD) mode. Should this occur, turn off the LCD display on the notebook computer and output the display data in "CRT only" mode. Details on how to change display modes can be found in your notebook computer's operation manual.
- When this projector receives 640 x 350 VESA format VGA signals, "640 x 400" appears on the screen.
- When projecting video images of an interlace video signal with the projector, the intended image may not be projected depending on the video signal when using the RGB input. In such cases, use the component input, S-video input or video input.

Video Compatibility Chart

	Resolution		H-Freq (kHz)	V-Freq (Hz)	Comp1 Support	Comp2 Support	S-Video Support	Compos-ite Support	VGA Support	DVI Support
SD Video	NTSC	640x480i	15.73	59.94/60	✓	✓	✓	✓		
	PAL	768x576i	15.63	50	✓	✓	✓	✓		
	SECAM	768x576i	15.63	50	✓	✓	✓	✓		
	NTSC-4.43				△	△	△	△		
	PAL-M				△	△	△	△		
	PAL-N				△	△	△	△		
	NTSC-J				△	△	△	△		
	PAL-60				△	△	△	△		
	NTSC-50									
ED TV	480P	720x480P	31.5	59.94/60	✓	✓			✓	✓
	576P	720x576P	31.3	50	✓	✓			✓	✓
HD TV	1080i/50	1920x1080i	33.8	50	✓	✓			✓	✓
	1080i/60	1920x1080i	28.1	59.94/60	✓	✓			✓	✓
	720P/50	1280x720P	37.5	50	✓	✓			✓	✓
	720P/60	1280x720P	45.0	59.94/60	✓	✓			✓	✓
HTPC	720P/48	1280x720P		48						
	720P/75	1280x720P		75						

1. Component 1/2 support signal formats are Y/Pb/Pr, Y/Cb/Cr
2. VGA port support signal formats are RGsyncB, RGBHV or RGBCsycs
3. "△" means manual setting is needed







DTV

Signal	Horizontal Frequency (kHz)	Vertical Frequency (Hz)	DVI Support
480P	31.5	60	✓
576P	31.3	50	✓
720P	45.0	60	✓
720P	37.5	50	✓
1080I	33.8	60	✓
1080I	28.1	50	✓

IR Remote Key Discrete Codes

Key	Code	Key	Code
IR POWER	0x00	IR_Aspect	0x0c
IR MENU	0x01	IR_PowerOff	0x0d
IR UP	0x02	IR_Standard	0x0e
IR DOWN	0x03	IR_Letterbox	0x0f
IR LEFT	0x04	IR_Anamorphic	0x10
IR RIGHT	0x05	IR_PixelToPixel	0x11
IR ENTER	0x06	IR_S_Video	0x12
IR_Exit	0x07	IR_Composite	0x13
IR_Source1	0x08	IR_Component1	0x14
IR_Source2	0x09	IR_Component2	0x15
IR_Source3	0x0a	IR_DVI	0x16
IR_Source4	0x0b	IR_PC	0x17

Troubleshooting

Problem	Check
 Projector does not start	<p>Projector power cord is not plugged into the wall outlet.</p> <p>Remote control batteries have run out.</p>
 No picture	<p>The selected input mode is wrong.</p> <p>Cables may be incorrectly connected to the rear panel of the projector.</p> <p>Power to the external connected device is off.</p> <p>The video signal format of the video equipment is not set correctly.</p>
 Color is faded	<p>Picture adjustments are incorrectly set.</p>
 Picture is blurred	<p>Focus is incorrectly set.</p> <p>The projection distance exceeds the focus range.</p>
 Picture noise appears.	<p>(PC input only)</p> <p>Try "Auto tune".</p> <p>Adjust the "Clock" setting.</p> <p>Adjust the "Phase" setting.</p>
 Picture is green on INPUT1 or 2 COMPONENT	<p>Change the input signal type of the video equipment.</p>



Picture is dark or bright and whitish

Picture adjustments are incorrectly set.



Picture is too bright and whitish

Picture adjustments are incorrectly set.

Product Specifications

Item	Description
Model No.	HD2+ DLP Front Projector
DLP Panel	Size 0.8" HD2+
	Display method: DMD by Texas Instruments
	Device method: Digital Light Processing (DLP™)
Display Type	DLP Chip, RGB optical shutter method
Resolution	1280 x 720 pixels
Lens	1-1.25 x zoom lens, F2.36~2.5, f= 24.0~30.1 mm
Projection Lamp	250 W / 200 W switchable UHP lamp
Input Sources	Video
	VGA
	YCbCr, YPbPr
	CVBS (Composite Video)
	S-Video
	DVI-D
	Control
	RS-232 (For computer)
	IR Receiver (For remote)
Computer Compatibility	VGA,SVGA, XGA
2D Lens Shift Ability	Up/Down: +115% / -100%
	Left/Right: ± 15%
Brightness	900 ANSI Lumen (Bright Mode)
Digital Keystone Correction	2D keystone correction
Projection Lens	Zoom lens with manual focus and manual zoom adjust
Contrast Ratio	4000:1
Uniformity	85%
Screen Size	30 ~ 300 inches
Throw Ratio (16:9)	1.34:1 ~ 1.68:1
Aspect Ratio	16:9 Native
Projection Distance	100" 3m
Video Enhance	4-Line Y/C separation(2D)
	DLTi, DCTi
Projection Method	Front / Rear, Desktop / Ceiling
OSD Control	Projector keypad
	IR remote control
Video system	NTSC 3.58 / NTSC 4.43 / PAL / PAL-M / PAL-N / PAL 60 / SECAM /
	EDTV480P /EDTV576P/HDTV720P /HDTV1080I
Dimensions	342 mm x 320 mm x 144 mm (13.5" x 12.5" x 5.6")(W x L x H)
Weight	14 lbs
Power Supply	100 ~ 240 V at 50 ~ 60 Hz
Power Consumption	370 W (Standby mode < 5W)
Operating Temperature	5°C to 35°C
Audible Noise	30 dBA (ECO mode)
Lamp Warranty	90 days or 500 hours
Product Warranty	2 years parts

Dimensions

Units: inches (mm)

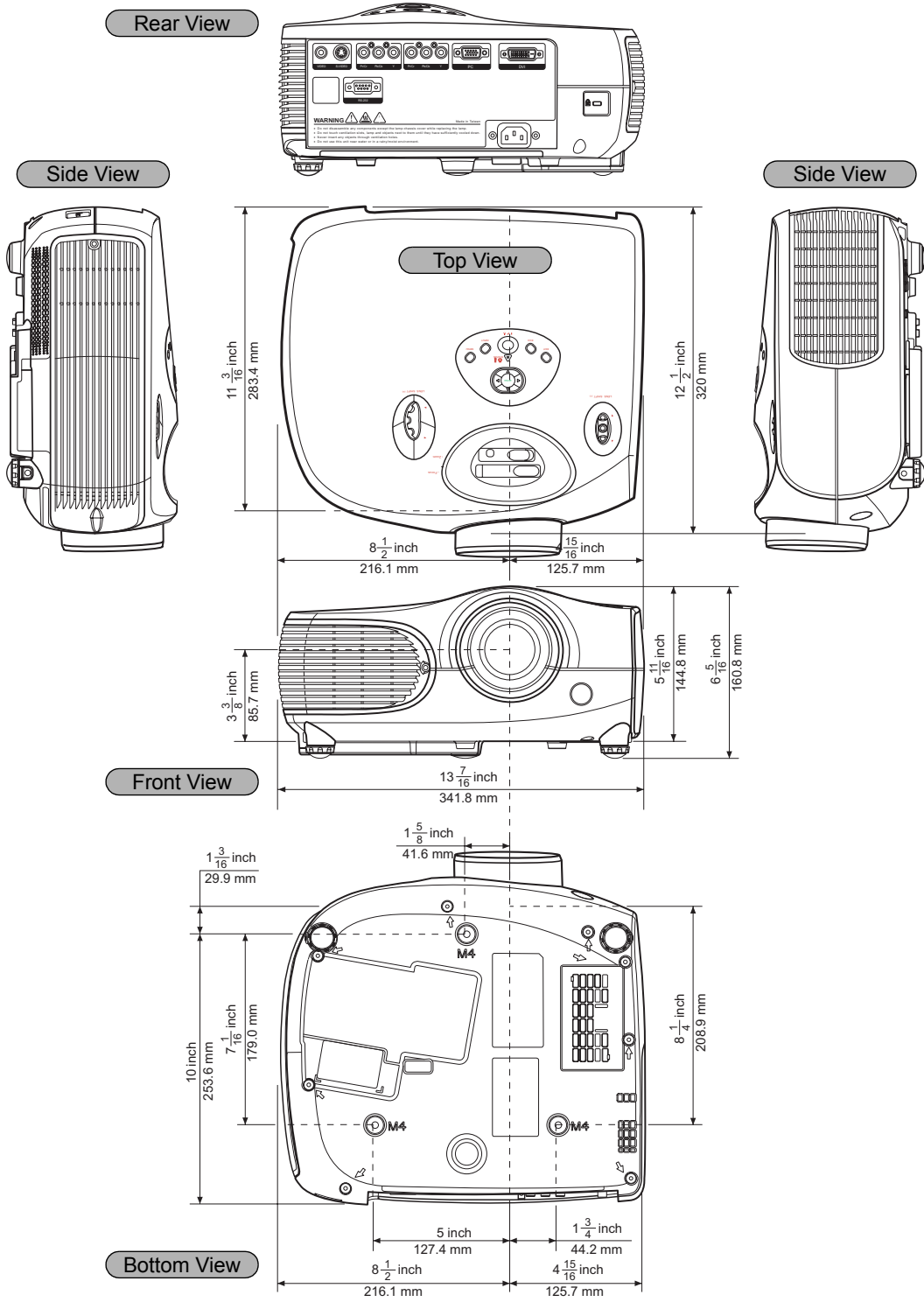

NOTES

A large, empty rectangular box with rounded corners, intended for taking notes. The box is defined by a thin gray border.

