

BOSE[®]

3·2·1 GS Series II

3·2·1 Series II

DVD HOME ENTERTAINMENT SYSTEMS

Owner's Guide



⚠ WARNING: To reduce the risk of fire or electric shock, do not expose the system to rain or moisture.

⚠ WARNING: This apparatus shall not be exposed to dripping or splashing, and objects filled with liquids, such as vases, shall not be placed on the apparatus. As with any electronic products, use care not to spill liquids in any part of the system. Liquids can cause a failure and/or a fire hazard.

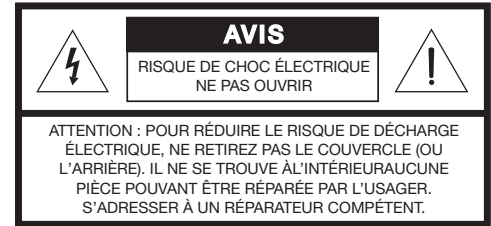
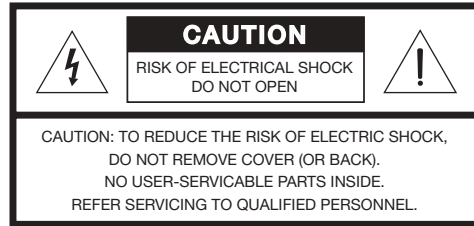

The CAUTION marks shown here are located on the bottom of your 3•2•1 Series II home entertainment system media center and the rear panel of the Acoustimass module:



The lightning flash with arrowhead symbol, within an equilateral triangle, alerts the user to the presence of uninsulated dangerous voltage within the system enclosure that may be of sufficient magnitude to constitute a risk of electric shock.



The exclamation point within an equilateral triangle alerts the user to the presence of important operating and maintenance instructions in this owner's guide.

⚠ CAUTION: To prevent electric shock, match wide blade of plug to wide slot, insert fully.

⚠ CAUTION: No naked flame sources, such as lighted candles, should be placed on the apparatus.

Class 1 laser product

The DVD player contained within the media center is classified as a CLASS 1 LASER PRODUCT according to EN60825-1:1994 + A11. The CLASS 1 LASER PRODUCT label is located on the bottom of the media center.

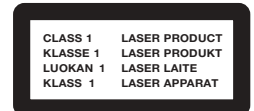

⚠ CAUTION: Use of controls or adjustments or performance of procedures other than those specified herein may result in hazardous radiation exposure. The DVD player should not be adjusted or repaired by anyone except properly qualified service personnel.

Class B emissions limits

This Class B digital apparatus meets all requirements of the Canadian Interference-Causing Equipment Regulations.



Batteries

Please dispose of used batteries properly, following any local regulations. Do not incinerate.

Additional safety information

See the additional instructions on the *Important Safety Information* sheet enclosed in the shipping carton.

Please read this owner's guide

Please take the time to follow this owner's guide carefully. It will help you set up and operate your system properly, and enjoy all of its advanced features. Save your owner's guide for future reference.

Introduction	5
Before you begin	5
Selecting compatible discs	5
Check for region code compatibility	5
MP3 compatibility	5
Glossary of terms	6
Limited warranty	7
For your records	7
System Setup	8
Unpacking	8
Selecting locations for your 3•2•1 Series II system components	9
Placing the media center	9
Placing the speakers	10
Placing the Acoustimass® module	11
Making system connections	12
Connecting the Acoustimass module to the media center	12
Connecting the speakers to the Acoustimass module	12
Connecting the supplied antennas	14
Connecting cable FM radio	14
Connecting your TV to the media center	15
Making audio connections	15
Making composite video connections	15
Connecting your TV and VCR to the media center	16
If your TV has audio output jacks	16
If your TV does not have audio output jacks	17
VCR considerations	18
Advanced setup options	18
Making S-video connections (higher quality video)	18
Making component video connections (highest quality video)	19
Connecting digital audio devices	20
Connecting your cable/satellite box, TV, and VCR to the media center	20
Connecting a game console	22
Installing the remote control batteries	23
Connecting the power cord	24
Checking your system setup	25
System Controls and Indicators	26
Remote control	26
The media center	29
Control panel	29
Display indicators	29
Operation	30
Turning your system on and off	30
Playing video DVDs	30
Basic DVD operations	31
Restricting access to video DVDs	31
Playing audio CDs	32
Basic CD operations	32
Listening to FM/AM radio	33
Tuning to a station	33
Storing stations as presets	33
Erasing a preset	34
Playing other sources	34
Using the sleep timer	34
Controlling Other Audio Devices	35
Setting up your remote to control other audio/video devices	35
Direct entry of a device code	35
Searching for a device code	36
Verifying an entered device code	38
Changing channel selection control	38

Contents

Changing Source Settings	39
Using the settings menus	39
To view the settings menus	39
To make changes in the settings menus	40
FM-AM settings menu	41
CD settings menu	41
DVD settings menu	42
TV, CBL-SAT, and AUX settings menu	43
Changing System Options	44
Using the System menu	44
To view the System menu	44
To change system options	45
Audio options	46
Video options	47
Media center options	48
Remote control options	49
DVD Lock options	50
Setting a password and restriction level	50
Motion Picture Association of America (MPAA) rating system	51
Maintaining Your System	52
Cleaning	52
Cleaning the media center	52
Cleaning the speakers	52
Cleaning discs	52
Replacing the remote control batteries	53
Accessories	53
Troubleshooting	54
Troubleshooting table	54
Customer service	55
Technical Information	56
Device Codes	A-1
Cable box device codes	A-1
Satellite box device codes	A-2
TV device codes	A-4
VCR device codes	A-9
Digital video recorder device codes	A-12

©2004 Bose Corporation. No part of this work may be reproduced, modified, distributed or otherwise used without prior written permission.

Dolby and the double-D symbol are trademarks of Dolby Laboratories. Manufactured under license from Dolby Laboratories. Confidential unpublished works. 1992-1997 Dolby Laboratories. All rights reserved.

This product incorporates copyright protection technology that is protected by method claims of certain U.S. patents and other intellectual property rights owned by Macrovision Corporation and other rights owners. Use of this copyright protection technology must be authorized by Macrovision Corporation, and is intended for home and other limited viewing uses only unless otherwise authorized by Macrovision Corporation. Reverse engineering or disassembly is prohibited.

"DTS" and "DTS Digital Surround" are registered trademarks of Digital Theater Systems, Inc.

MPEG Layer-3 audio compression technology licensed by Fraunhofer IIS and THOMSON multimedia.

This product incorporates copyright protected technology and other intellectual property rights owned by Cirrus Logic, Inc. and subject to the copyright protection of the U.S. as well as other licensing restrictions and protections. Use of this copyright protected technology is limited solely to use with the Cirrus Logic integrated circuits incorporated in this product. Reverse engineering or disassembly is prohibited.

Before you begin



Thank you for purchasing the Bose® 3•2•1 Series II or 3•2•1 GS Series II DVD home entertainment system, which offers superb sound, elegance, and simplicity in an advanced home audio setup. Using Bose proprietary signal processing technology, the 3•2•1 Series II systems provide improved spaciousness from stereo recordings, and bold movie effects from surround-encoded materials. Yet its few parts require little effort to set up, so you can enjoy your new system's performance right away.

Your system includes:

- Integrated AM/FM tuner and DVD/CD player in a small console
- Small, easy-to-place shelf speakers and an attractive hideaway Acoustimass® module
- Easy-to-use infrared remote control
- Console input jacks for connecting other audio devices (such as a VCR, cable or satellite box)

Selecting compatible discs

The DVD/CD player built into the 3•2•1 series II media center can play the following types of discs identified by their corresponding logos:

- Video DVDs 
- Video CDs 
- DVD-R, DVD+R
- Audio CDs 
- CD-R and CD-R/Ws
- MP3 CDs

Check for region code compatibility

For a DVD player and DVD disc to be compatible, their region code numbers must match. These numbers are allocated according to where the player and disc are sold. The 3•2•1 Series II DVD home entertainment systems have a region code which must also match the DVD discs.

Check the region code number on the carton of the 3•2•1 Series II DVD home entertainment system or on the bottom of the media center that comes in the carton. Then be sure to choose only DVD discs that show the same region number on the disc label or front cover. For example, a Region 1 DVD disc should display the following mark: 

MP3 compatibility

To be compatible with the 3•2•1 Series II or 3•2•1 GS Series II home entertainment systems, MP3s must meet the following criteria:

- All tracks must be burned in a single closed session
- The disc format must be ISO9660
- Each file must have a “.mp3” extension and have no other periods in the filename

Glossary of terms

Aspect Ratio – The shape of the rectangular picture in a TV set. It is the width of the picture relative to the height. Our standard TV picture, in terminology used by that industry, is 4 units wide by 3 units high, or 4:3 (read as 4 by 3) in aspect ratio. There are currently two standard TV aspect ratios, 4:3 and 16:9.

Chapter – In DVD-Video, a division of a title. Technically called a part of title (PTT).

Component Video – A video signal split into three parts: luminance and two color signals (marked as YPbPr). It provides the highest resolution video, but cannot be processed by all television sets.

Composite Video – A single video signal that contains luminance, color, and synchronization information. NTSC and PAL are examples of composite video systems.

Dolby Laboratories  – Developer of a perceptual coding system for audio.

Dolby Digital – a type of multi-channel surround sound format used on discs.



– the logo representing Dolby® Digital.

DTS – a type of multi-channel surround sound format used on discs.



– the logo representing DTS.

DVD – An acronym that is most commonly known to mean Digital Video Disc or Digital Versatile Disc. The audio/video/data storage system based on 12- and 8-cm optical discs.

DVD Video – A standard for storing and reproducing audio and video on DVD-ROM discs, based on MPEG video, Dolby Digital and MPEG audio, and other proprietary data formats.

IR – An acronym for infrared. Pertains to the type of remote that sends/receives commands on an infrared light beam.

Letterbox – The projected aspect ratio of feature films is often 16:9 rather than the 4:3 aspect ratio of most TVs. Therefore, it is becoming common practice to transfer films to video with black borders at the top and bottom of the picture. The film picture becomes a “letterbox” within the video.

MPEG – a type of data compression used for audio or video storage on disc.

MP3 – MPEG-1 Layer III audio. This is a compressed audio format that allows you to record many hours of music on a single CD.

NTSC – An acronym for National Television System Committee. The organization that developed both the American Black & White and Color television systems.

PAL – An acronym for Phase Alternate Line. A television format used extensively in Western Europe.

PCM – An uncompressed, digitally coded representation of an analog signal. This is the form of the digital audio signal used for both CD and laserdisc. It is a serial data stream that is coded for transmission or recording. PCM is also used for many other types of serial data communications.

S-video – A video interface standard that carries separate luminance and chrominance signals, usually on a four-pin mini-DIN connector. Also called Y/C. The quality of S-video is significantly better than composite video since it does not require a comb filter to separate the signals. Most high-end televisions have S-video inputs.

Title – numbered elements of the DVD contents, which may include more than the movie alone.

Track – Individual selections recorded on an audio tape or disc.

Limited warranty

The 3•2•1 Series II and 3•2•1 GS Series II home entertainment systems are covered by a limited transferable warranty. Details of the limited warranty are provided on the product registration card that came with your system. Please fill out the information section on the card and mail it to Bose. Failure to do so will not affect your limited warranty rights.

For your records

Serial numbers are located on the bottom of the media center and the rear of the Acoustimass® module. Please have your serial number ready before contacting Bose® Customer Service.

Model: 3•2•1 Series II 3•2•1 GS Series II Check one

Media center serial number: _____

Acoustimass module serial number: _____

Dealer name: _____

Dealer phone: _____ Purchase date: _____

We suggest you keep your sales receipt and product registration together with this owner's guide.

Unpacking

Carefully unpack your system. Save all packing materials, which provide the safest way to transport your system. Check to be sure your system includes the parts shown in Figure 1.

If any part of the system appears damaged, do not attempt to use it. Notify Bose or your authorized Bose® dealer immediately. For Bose contact information, refer to the address sheet included in the carton.

WARNING: To avoid danger of suffocation, keep the plastic bags out of the reach of children.

Figure 1

Contents of the shipping carton

Your system includes one of the following cords:



120 VAC power cord (US/Canada)

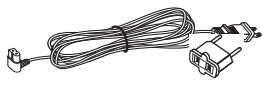

115/230 VAC power cord with adapter (US/Europe)



230 VAC power cord (Europe)

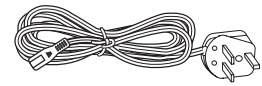

230 VAC power cord (UK/Singapore)



240 VAC power cord (Australia)

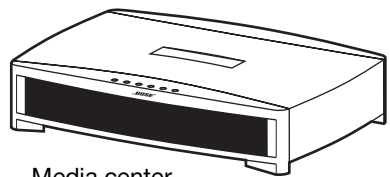

Media center



Acoustimass® module cable

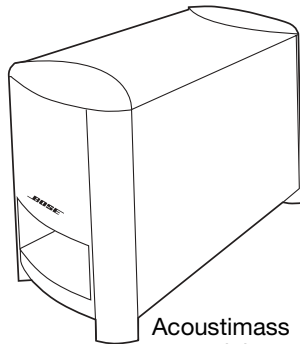

Acoustimass module



Speaker cable

Note: If you purchased a 3•2•1 GS Series II system, the left and right speaker cable connectors will be marked with a "GS".



Rubber feet for Acoustimass module

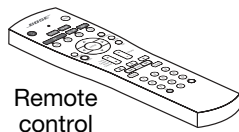

Remote control



Batteries

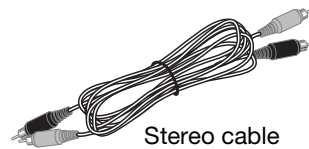

Stereo cable



Video cable



FM antenna

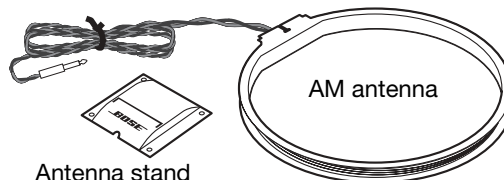

AM antenna

Antenna stand

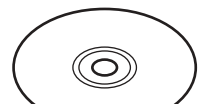

Setup and demo disc

Your system includes one of the following speaker types:

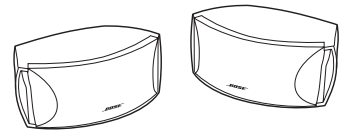

3•2•1 speakers

or

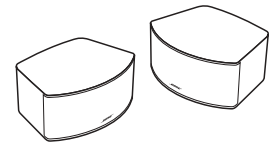

3•2•1 GS speakers

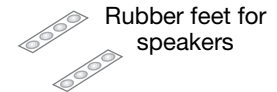

Rubber feet for speakers

Note: Now is a good time to find the serial numbers on the bottom of the media center and Acoustimass module. Copy these numbers onto your product registration card and in the space provided on page 7.

Selecting locations for your 3•2•1 Series II system components

Use the following guidelines and Figure 2 to choose locations and positions for the components of your 3•2•1 home entertainment system.

Note: While these guidelines are offered to help provide great system performance, you may find other placement choices that are more convenient and provide the sound you enjoy.

Placing the media center

CAUTION: Do not block any ventilation openings. For reliable operation of the product and to protect it from overheating, put the product in a position and location that will not interfere with its proper ventilation. For example, do not place the product on a bed, sofa, or similar surface that may block the ventilation openings. Do not put it in a built-in system, such as a bookcase or cabinet that may keep air from flowing through its ventilation openings.

- Place the media center where nothing obstructs opening the disc tray on its front panel.
- Make sure the media center will be placed close enough to the Acoustimass® module and the speakers so that all the cables will reach.
- Make sure the media center will be placed close enough to additional source devices (TV, VCR or cable box) so that all the cables will reach.

Note: Make sure that the front of the media center is unobstructed so that it may receive IR (infrared) commands from the remote control.

Figure 2

Sample media center and speaker placement

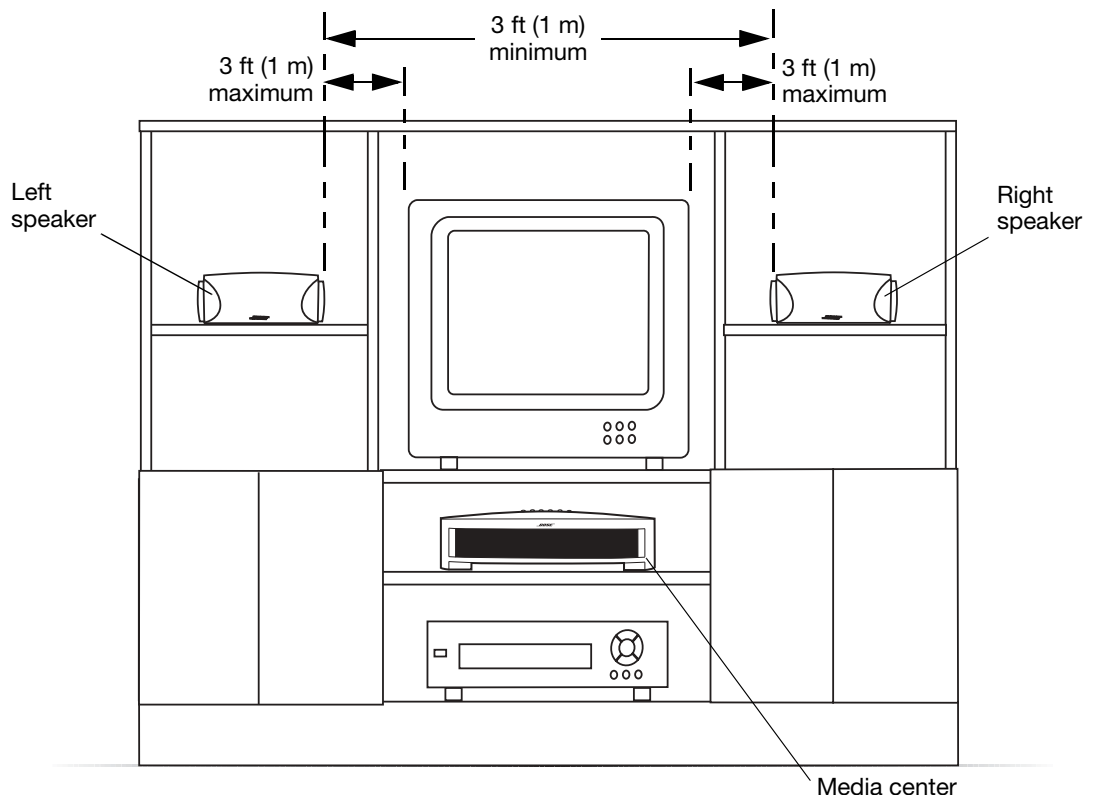

Note: The speakers are magnetically shielded to prevent interference with the TV screen.

Placing the speakers

Choosing a good location for the speakers will allow you to experience the audio surround effects that your 3•2•1 home entertainment system is designed to deliver.

- Place the two speakers either on top of the TV or at equal distance from the left and right of the TV screen (Figure 2). Keep both speakers at approximately the same height.
- Place each speaker **within 3 feet (1 meter) of the edge of the TV screen**. Placing the speakers more than 3 feet away from the TV can cause the sound to become separated from the picture.
- If you are using a bookshelf or a home entertainment unit, place each speaker at the **front edge** of its shelf. Positioning the speakers too far back in an enclosed space can change the overall quality of sound and alter the movie sound effects.
- Place the speakers at least **3 feet (1 meter) apart from each other** to optimize the surround sound experience.

⚠ CAUTION: Choose a stable and level surface for both speakers. Vibration can cause the speakers to move, particularly on smooth surfaces like marble, glass, or highly polished wood. If you are placing the speakers on a flat surface, be sure to attach the smaller of the two sets of supplied rubber feet to the bottom surface. You may obtain additional rubber feet (part number 178321) from Bose® Customer Service. To contact Bose, refer to the list of offices included in the product carton.

🎵 Note: The speakers can be mounted on Bose brackets, table stands, or floor stands. For ordering information, refer to “Accessories” on page 53. Additional or longer cables may also be ordered.

Figure 3

Recommended speaker placement

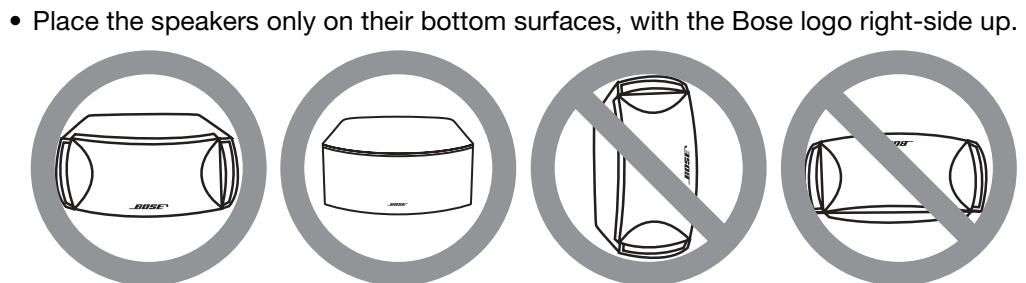

- Aim the speakers straight ahead toward the listening area. Do not place the speakers at an angle. **Angling one or both speakers into or away from the listening area significantly alters system performance.**

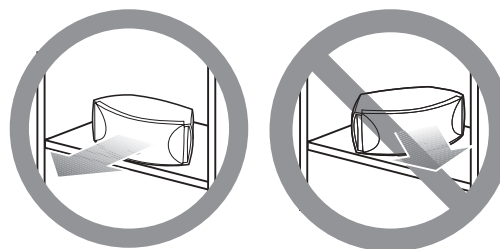

Placing the Acoustimass® module

- Place the Acoustimass® module within reach of the cable from the music center and an AC (mains) power outlet.
- Place the module at the same end of the room as the TV and the speakers (Figure 4).
- Keep the module at least 3 feet (1 meter) away from the TV to prevent the module from interfering with the TV screen.

Figure 4

Recommended Acoustimass module placement

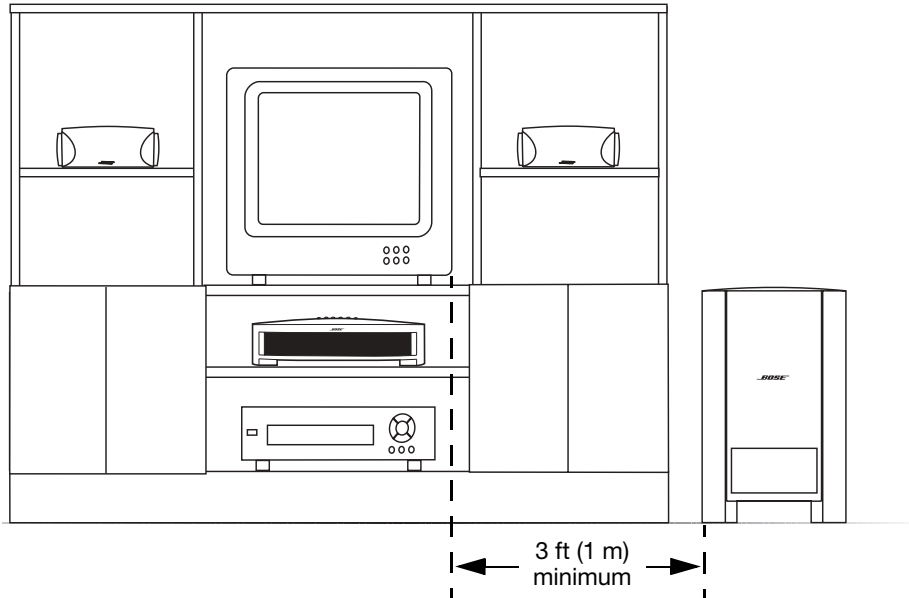

- Attach the medium-sized rubber feet to the bottom of each foot on the module. The rubber feet provide increased stability and protection from scratches.
- Choose a convenient location such as under a table, behind a sofa or chair, or behind drapes, but do not block the port opening.
- Aim the port of the module into the room or along the wall. This prevents a blocked port or over-powering bass.
- Stand the Acoustimass module on its feet. Do not lay it on its side or stand it on either end (Figure 5).

Figure 5

Recommended orientation of the module

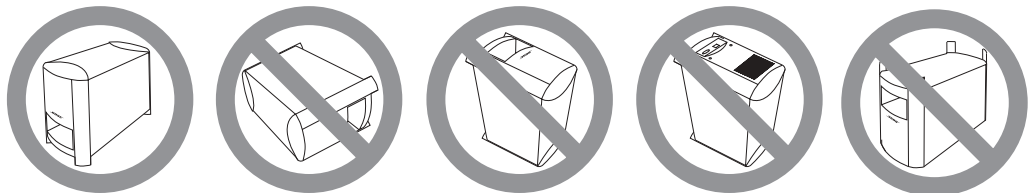

- CAUTION:** Do not block the openings on the back of the module, which provide ventilation for the built-in circuitry.
- CAUTION:** The Acoustimass module generates a magnetic field. Although this is not an immediate risk to your video tapes, audio tapes, and other magnetic media, you should not store any of these items directly on or near the module.

Making system connections

⚠ CAUTION: Do not plug the Acoustimass® module into an AC power (mains) outlet until all the components are connected.

🎵 Note: If additional audio cables or longer cables are needed to make these connections, contact Bose Customer Service. Refer to the list of offices included in the product carton.

Connecting the Acoustimass module to the media center

Plug one end of the Acoustimass module cable into the **Acoustimass Module** jack on the rear of the media center (Figure 6). Plug the other end of the cable into the input (⊖) jack on the rear of the Acoustimass module.

🎵 Note: The jacks for the Acoustimass module cable are keyed so that the cable connectors only plug in one way. Make sure that the arrow on the connector body faces up when plugging in the cable.

Figure 6

Acoustimass module-to-media center connection

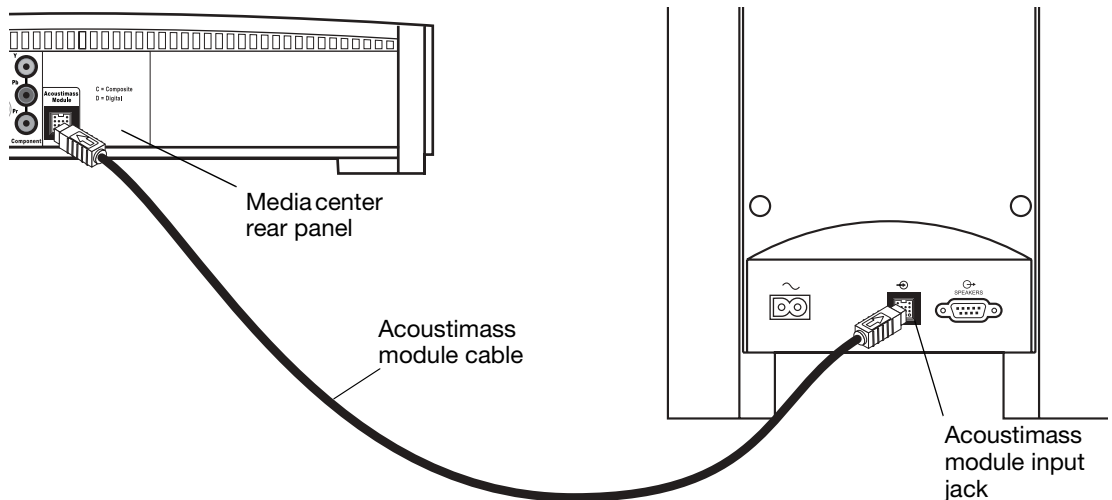

Connecting the speakers to the Acoustimass module

1. Insert the single-plug end of the speaker cable into the **SPEAKERS** jack on the rear panel of the Acoustimass module (Figure 7). Tighten both screws on the plug.

Figure 7

Speaker cable-to-Acoustimass module connection

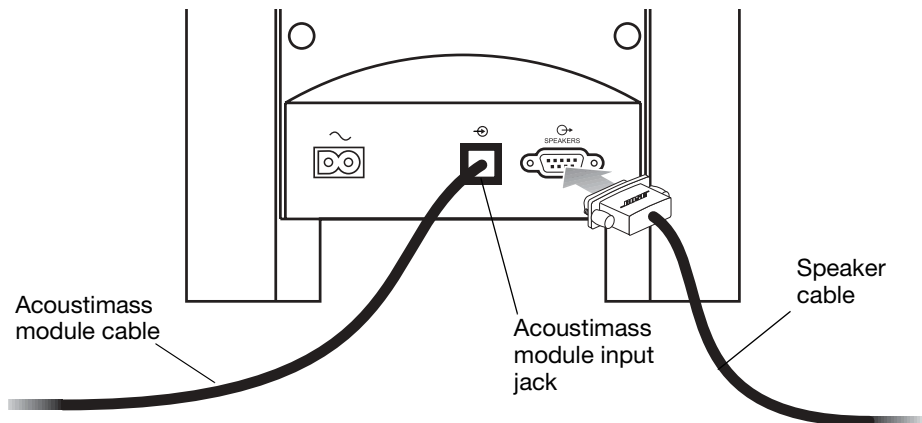

2. At the other end of the speaker cable, separate the left and right speaker cords as much as necessary to reach each speaker (Figure 8).

Figure 8

Separating left and right speaker cords

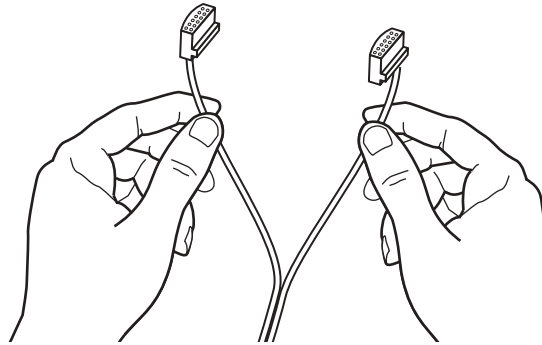

Note: If you purchased a 3•2•1 GS Series II system, the left and right speaker cable connectors will be marked with a "GS".

3. Plug the **LEFT** speaker cable into the rear jack of the left speaker (Figure 9). Plug the **RIGHT** speaker cable into the rear jack on the right speaker.

Figure 9

Left and right speaker connections

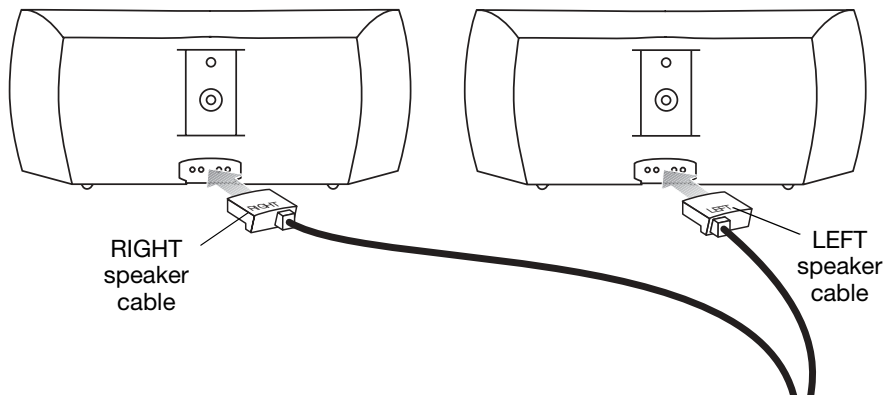

🎵 **Note:** Make sure cable connectors are fully inserted and seated firmly in the speaker jacks.

Connecting the supplied antennas

The rear panel of the media center provides jacks for the AM and FM antennas included with your system (Figure 10). Unwind the wires for each antenna to provide the best reception.

Figure 10

Antenna connections

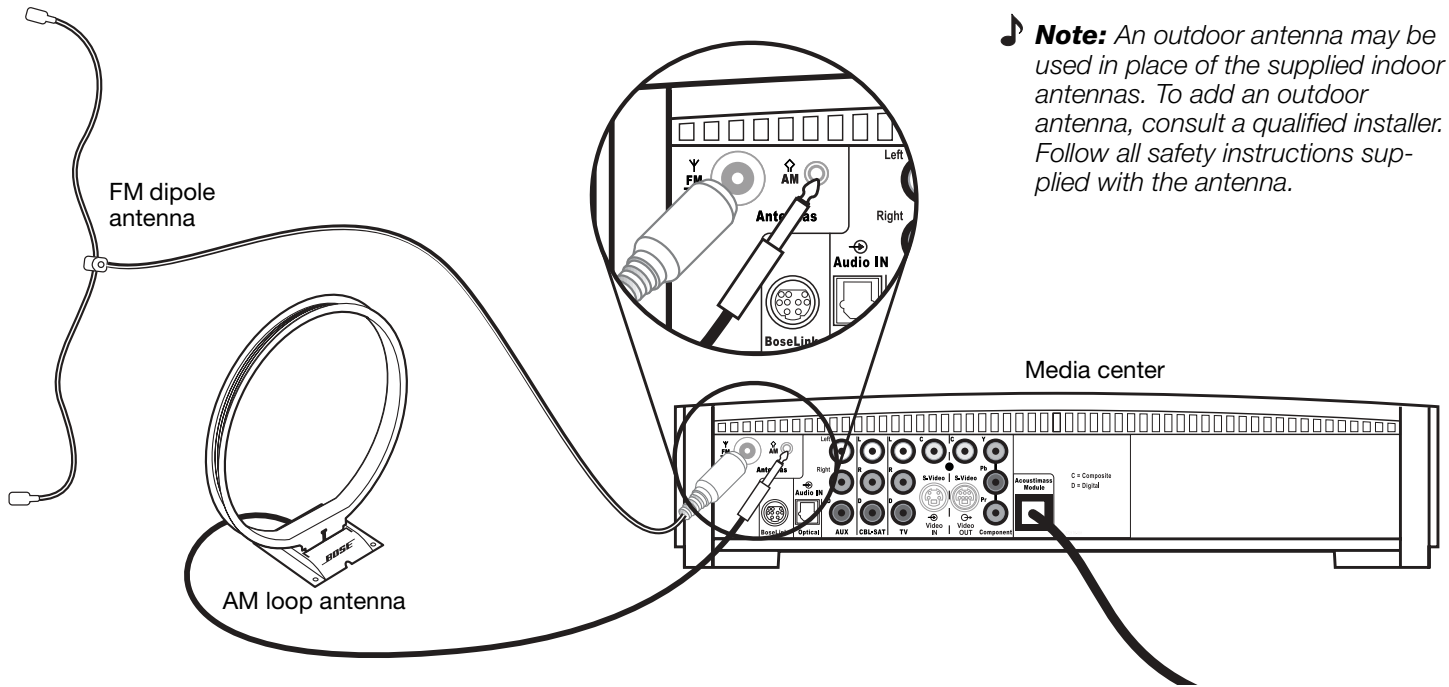

FM antenna

Plug the FM antenna into the **FM** jack on the media center rear panel. Spread out the antenna arms and move them around to establish optimum FM reception. Extend the antenna as far from the media center and other equipment as possible.

AM antenna

Plug the AM loop antenna into the **AM** jack on the media center rear panel. Place the antenna loop at least 20 inches (50 centimeters) away from the media center and at least 4 feet (1.2 meters) away from the Acoustimass® module. Experiment with positioning the loop for optimum AM reception. Follow the instructions enclosed with the AM loop antenna to stand it on the supplied base, or mount it to a wall.

Connecting cable FM radio

Some cable TV providers make FM radio signals available through the cable service to your home. This connection is made to the external FM jack on the back panel of the media center. To connect to this service, contact your cable TV provider for assistance.

♪ **Note:** Make sure that the cable radio installation includes a TV/FM splitter so that only the FM radio band, not the cable TV band, is received by the media center. If necessary, contact your cable company.

Connecting your TV to the media center

♪ **Note:** If you will be using the 3•2•1 system with both a TV and a VCR, skip this section and go to “Connecting your TV and VCR to the media center” on page 16.

Making audio connections

♪ **Note:** If your TV does not have audio output jacks, see “If your TV does not have audio output jacks” on page 17. Otherwise, continue.

1. Connect one end of the supplied stereo cable to the **TV Audio IN** jacks on the rear panel of the media center (Figure 11). Insert the white RCA plug into the **TV white L** jack. Insert the red RCA plug into the **TV red R** jack.
2. Connect the other end of the stereo cable to the audio output jacks on your TV. Insert the white RCA plug into the white **AUDIO OUT L** jack. Insert the red RCA plug into the red **AUDIO OUT R** jack.

Making composite video connections

♪ **Note:** Some older TVs with standard TV cable connectors do not have a composite video or an S-video input. Such TVs are not compatible with any DVD players and require use of an RF modulator for this connection. RF modulators are available at your local electronics store.

1. Insert one end of the supplied video cable (yellow) to the **Video OUT C** (composite) jack on the back of the media center (Figure 11).
2. Insert the other end of the video cable into one of the video input jacks on your TV.

Figure 11

TV (composite video)-to-media center connections

Remember the name of the TV video input you plugged the video cable into (for example: Video 1, Input 1, or Aux). Later, you will need to select the corresponding video input on your TV in order to view the 3•2•1 system video output.

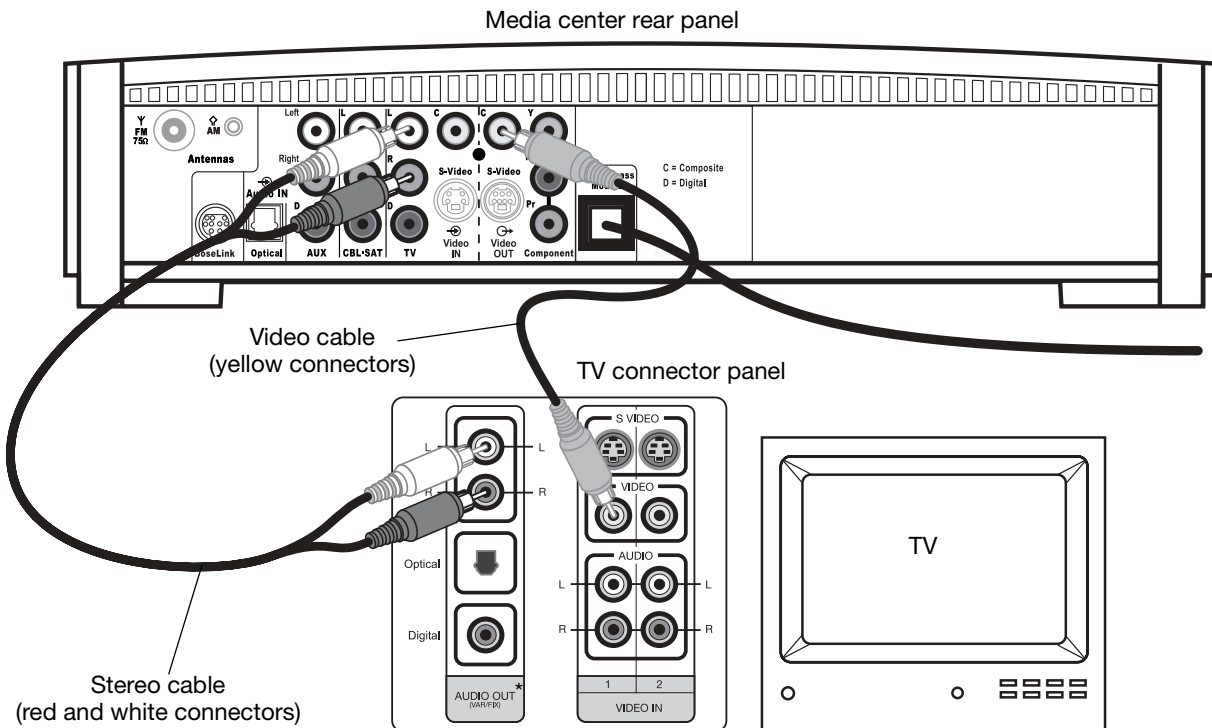

*Could be labelled “FIXED”, “MONITOR”, or “HiFi”.

Connecting your TV and VCR to the media center

Note: There are two options for connecting your TV and VCR to the media center. Before you proceed, you must determine if your TV has audio output jacks. Consult your TV owner's guide if you need assistance.

If your TV has audio output jacks

If your TV has audio output jacks, you can directly route the TV audio to the 3•2•1 home entertainment system (Figure 12).

1. Connect one end of the supplied stereo cable to the **TV Audio IN** jacks on the rear panel of the media center. Insert the white RCA plug into the **TV white L** jack. Insert the red RCA plug into the **TV red R** jack.
2. Connect the other end of the stereo cable to the audio output jacks on your TV. Insert the white RCA plug into the white **AUDIO OUT L** jack. Insert the red RCA plug into the red **AUDIO OUT R** jack.
3. Insert one end of the supplied video cable (yellow) to the **Video OUT C** (composite) jack on the back of the media center. Insert the other end of the video cable into one of the video input jacks on your TV.

Figure 12

TV and VCR connections with media center

Remember the name of the TV video input you plugged the video cable into (for example: Video 1, Input 1, or Aux). Later, you will need to select the corresponding video input on your TV in order to view the 3•2•1 system video output.

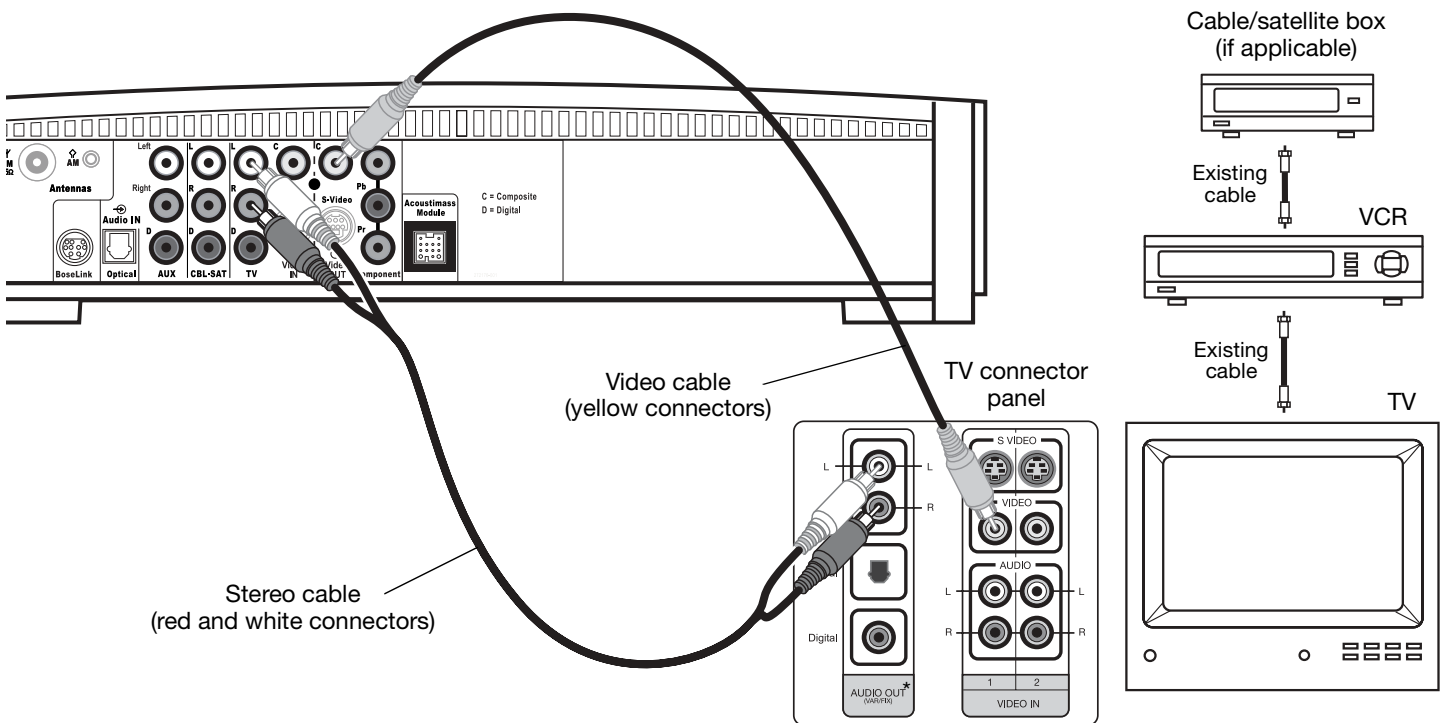

*Could be labelled "FIXED", "MONITOR", or "HiFi".

If your TV does not have audio output jacks

If your TV does not have audio output jacks, you will need to feed audio to the 3•2•1 home entertainment system through a secondary source, such as a VCR. To do this, you will need one additional video cable, which can be purchased at your local electronics store.

1. Connect one end of the supplied stereo cable to the **AUX Audio IN** jacks on the rear panel of the media center (Figure 13). Insert the white RCA plug into the **AUX white L** jack. Insert the red RCA plug into the **AUX red R** jack.
2. Connect the other end of the stereo cable to the **AUDIO OUT** jacks on your VCR. Insert the white RCA plug into the white **AUDIO OUT L** jack. Insert the red RCA plug into the red **AUDIO OUT R** jack.
3. Insert one end of the supplied video cable (yellow) into the **VIDEO OUT** jack on the back of your VCR. Insert the other end of the supplied video cable into the **Video IN C** (composite) jack on the back of the media center.
4. Insert one end of the second video cable (yellow) into the **Video OUT C** (composite) jack on the back of the media center. Insert the other end of the second video cable into one of the video input jacks on your TV.

Figure 13

System setup when TV has no audio output jacks

Remember the name of the TV video input you plugged the video cable into (for example: Video 1, Input 1, or Aux). Later, you will need to select the corresponding video input on your TV in order to view the 3•2•1 system video output.

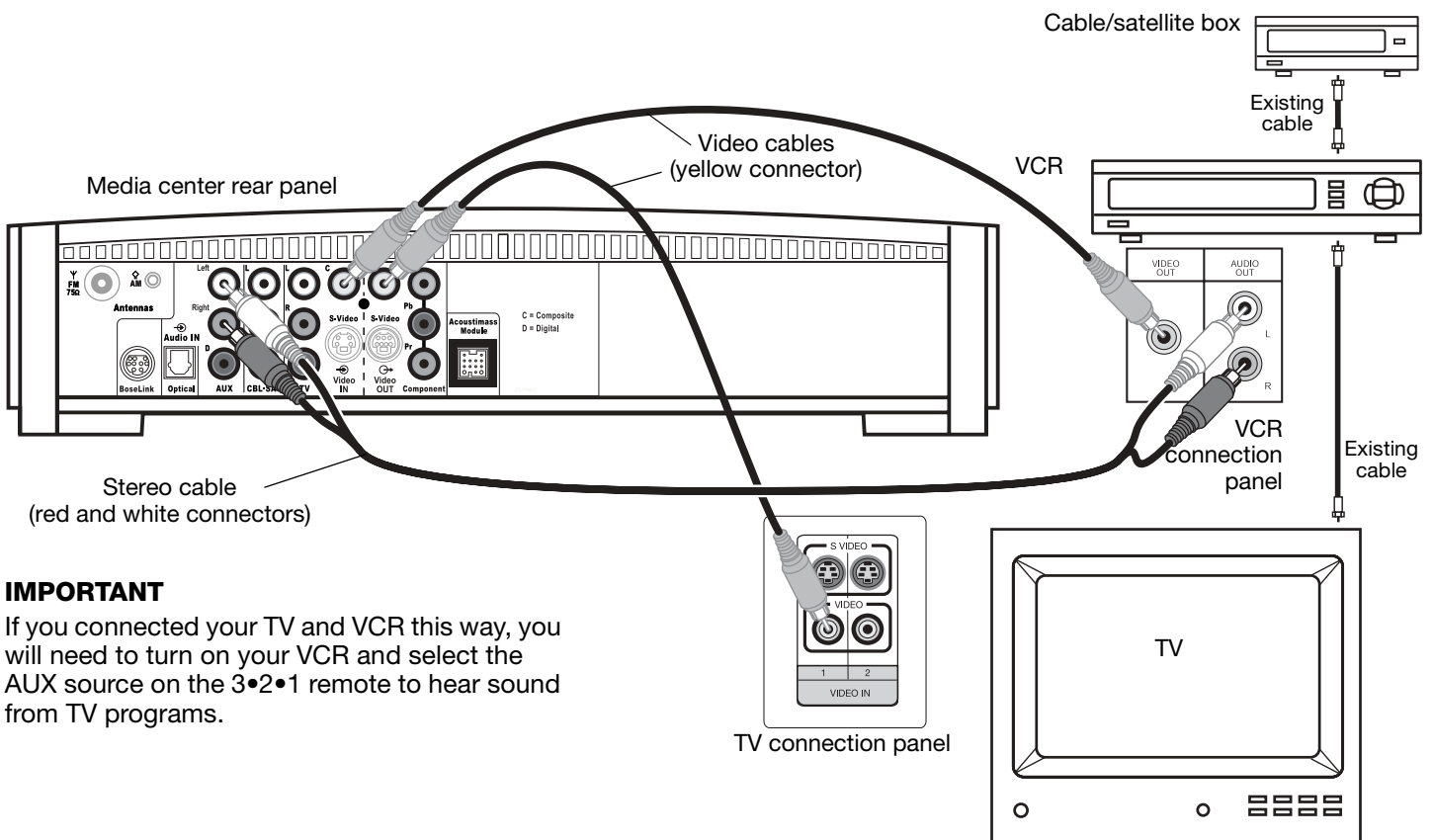

IMPORTANT

If you connected your TV and VCR this way, you will need to turn on your VCR and select the AUX source on the 3•2•1 remote to hear sound from TV programs.

VCR considerations

- Some combination TV/VCR units may not work with 3•2•1 Series II home entertainment systems. Please refer to your TV/VCR owner's manual for information.
- A stereo VCR is required for optimal sound performance. If your VCR has only one audio output and is not labeled **Stereo** or **Hi-fi**, you have a mono VCR. You will need a Y-adaptor cable (available at electronics stores) to connect audio to the media center. For this setup, you will need to select "Mono decoding" (see "TV, CBL-SAT, and AUX settings menu" on page 43) so your 3•2•1 system will simulate surround sound effects from a mono source. Otherwise, you will hear mono sound from both speakers.

Advanced setup options

Making S-video connections (higher quality video)

An S-video input jack, provided on many TVs, delivers a higher quality TV picture than the composite video output connection shown in Figure 11. For this connection you will need an S-video cable which can be purchased from your Bose dealer or a local electronics retailer.

- Insert one end of the S-video cable into the **S-Video OUT** jack on the media center (Figure 14).
- Insert the other end of the S-video cable into the **S-VIDEO IN** jack on your TV.

Figure 14

TV (S-video)-to-media center connections

IMPORTANT

If you use S-video to connect your TV to the media center, you must also use S-video to connect all other devices (such as a cable box and VCR) to the media center.

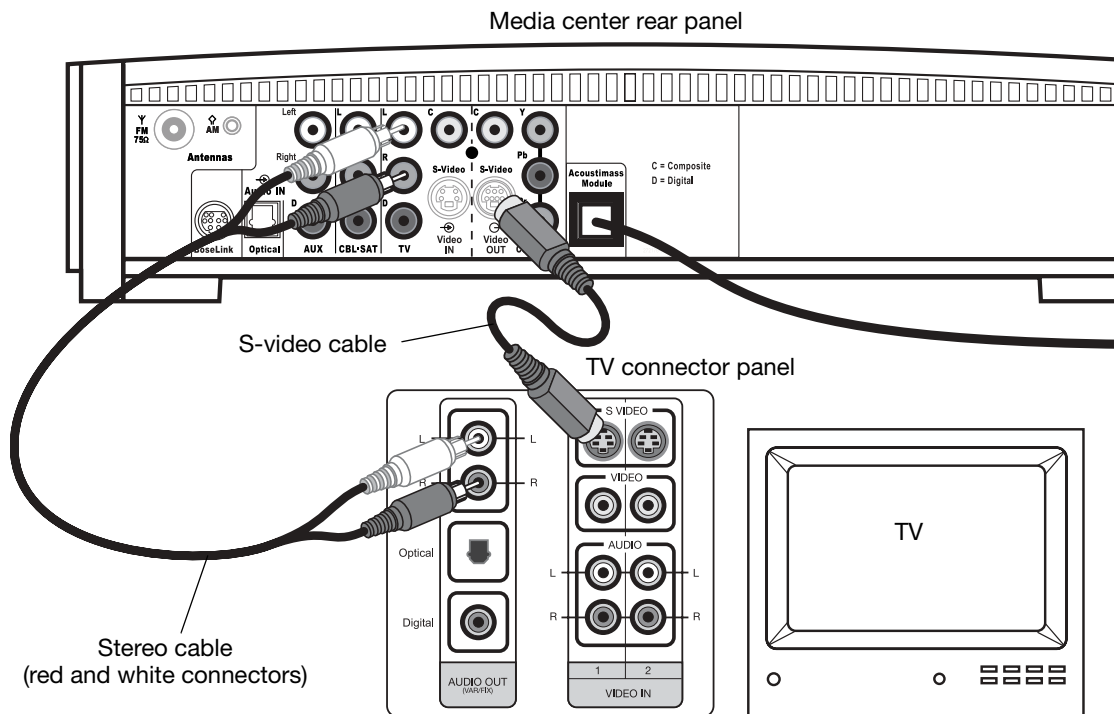

Making component video connections (highest quality video)

Note: Component video connections are required in order to use the progressive scan feature of your 3•2•1 system. Your TV must also support this feature. To turn on the progressive scan feature, see "Video options" on page 47.

For the highest quality video from DVDs, you may want to use a component video connection between the media center and the TV. To do so, your TV must provide component video jacks (typically labelled Y, Pb, and Pr). Refer to your TV owner's guide for more information.

To make component video connections you will need three video grade cables that are long enough to reach from the rear of the media center to your TV (Figure 15). If the cables are not supplied with your TV, you can purchase them separately.

1. On the media center rear panel, plug one video cable into the **Component Y, Pb, and Pr** video output jacks (Figure 15).
2. Plug the other end of each video cable into the corresponding (color or letter code) component video jack on the back of your TV.

Figure 15

TV (component video)-to-media center connections

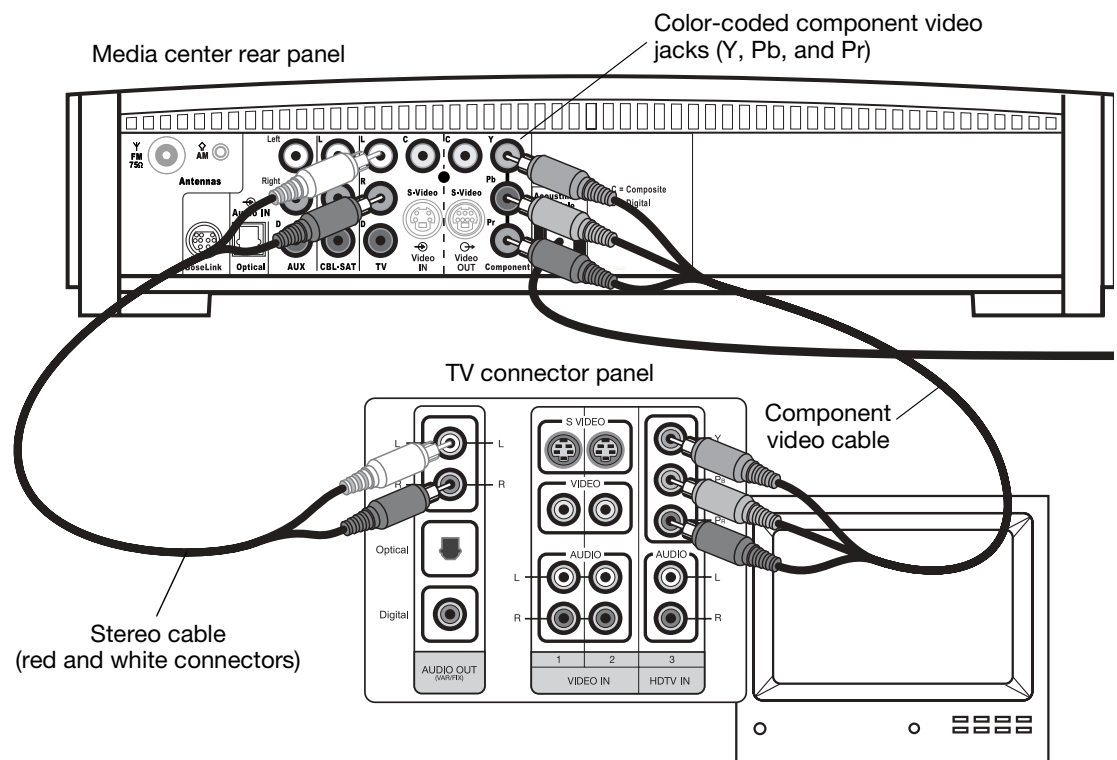

IMPORTANT FOR COMPONENT VIDEO USERS

Input signals received by the **C** (Composite) or **S-Video IN** jacks are not passed through to the **Component video OUT** jacks. If you connect an external video device to the **C** or **S-Video IN** jack, you must also connect the **C** or **S-Video OUT** jack on the media center to the respective video input jack on your TV. To view the external video input on your TV, you will need to select the TV video input used for that device. To view the onscreen menus of the 3•2•1 system, you will need to switch back to the TV's component video input.

Note: For more information, or to purchase the video cables, contact your local electronics store or authorized Bose dealer.

Connecting digital audio devices

Some audio devices may feature a digital audio output for optimum sound performance. Use an optical digital cable or a coaxial digital cable, as appropriate, to connect this output to the digital input on the media center. You can purchase the required cables at a local electronics store.

On the media center rear panel, an optical digital cable connects to the OPTICAL jack. A coaxial cable connects to the audio input jacks labeled **D**.

- ♪ **Note:** The digital audio inputs of the 3•2•1 system are not able to decode a DTS bitstream from an external audio device. Only a DTS bitstream from the internal DVD player can be decoded.
- ♪ **Note:** Before you can benefit from the optical connection, you will need to assign the optical connector to the audio source in the system settings menu. See “Media center options” on page 48.

Figure 16

Media center digital audio input jacks

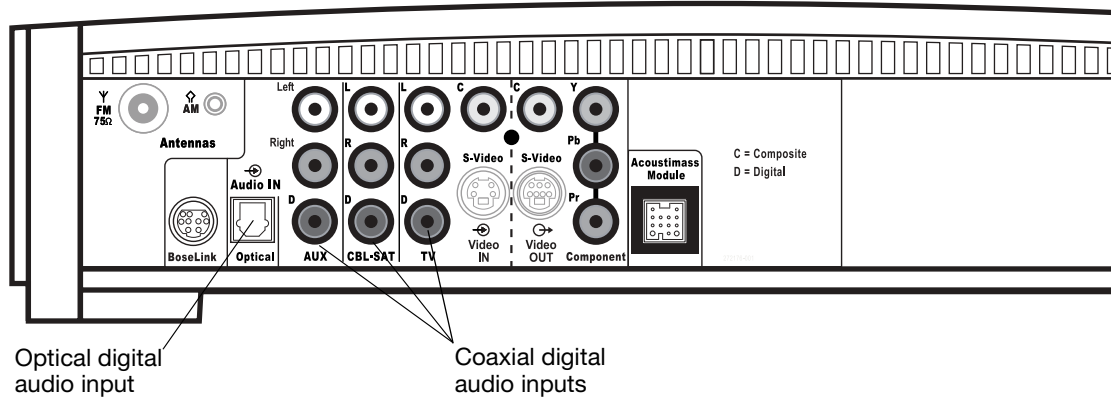

Connecting your cable/satellite box, TV, and VCR to the media center

The 3•2•1 home entertainment system provides flexibility for you to add up to three external audio devices, including your TV, directly to the media center.

Figure 17 shows you an advanced setup using a TV, VCR and cable/satellite box. In this setup, please notice the following:

- S-video connections are used to deliver the cable/satellite signal to the media center. Therefore, the media center output video is sent to the TV also through an S-video connection.
- Analog and digital coax audio connections are shown for the cable/satellite box. As an option, you may use an optical digital connection. However, before you can benefit from the optical connection, you will need to assign the optical connector to the cable/satellite box audio source in the system settings menu. See “Media center options” on page 48.
- When connecting an audio device to the media center jacks, remember to match the red jack to the right channel (R) and the white (or black) jack to the left channel (L).
- For further details on making the video connections between your VCR and TV, refer to the manuals for these video devices.

- ♪ **Note:** The recommendations contained in this owner’s guide are basic suggestions for connecting external devices to the 3•2•1 Series II system. Instructions and terminology pertinent to these external devices may vary, depending on the manufacturer. Consult the owner’s guide that came with the device for clarification on setup and usage before making any connections.

Figure 17

Advanced setup: TV, VCR and cable/satellite box

Media center

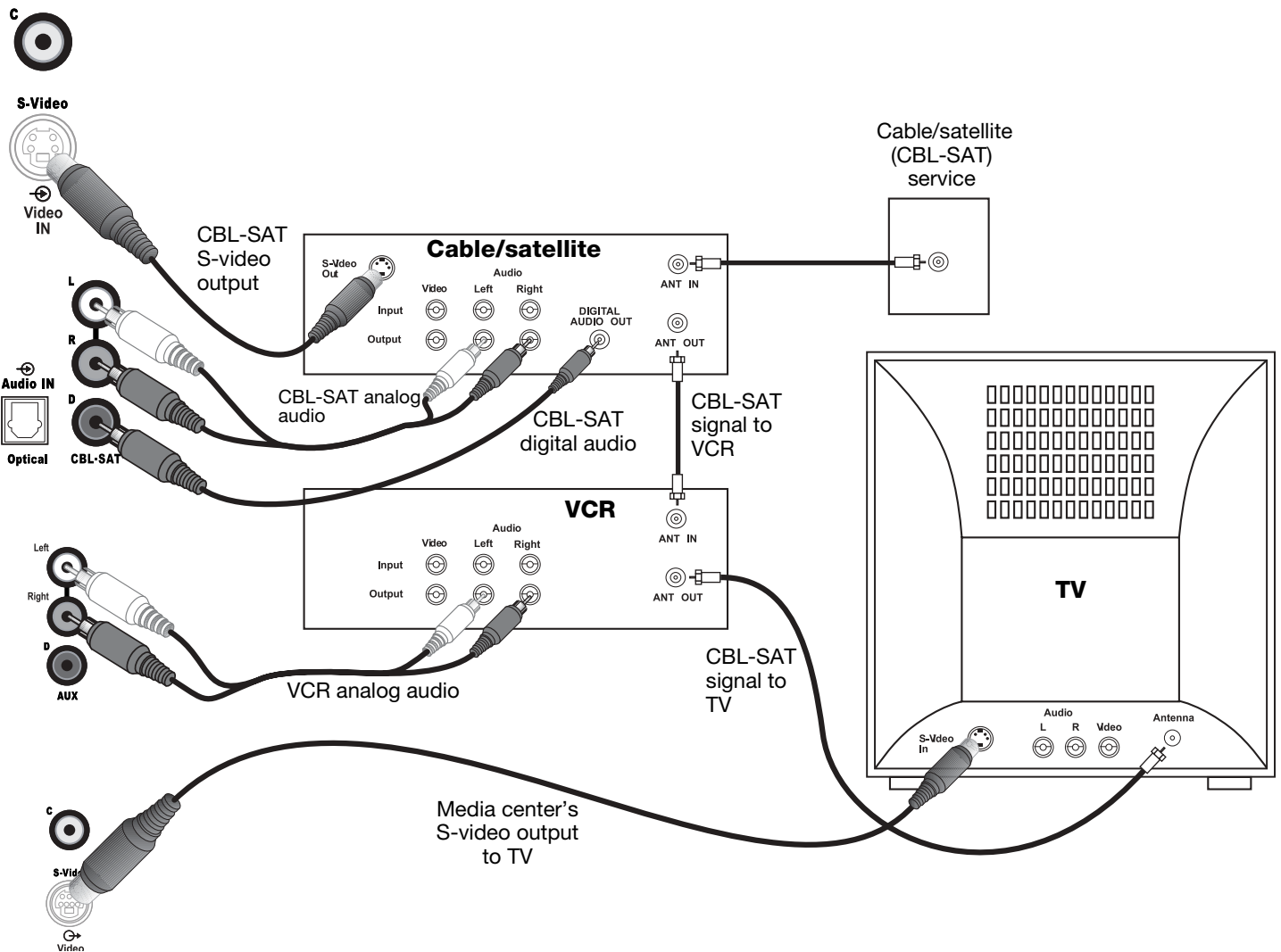
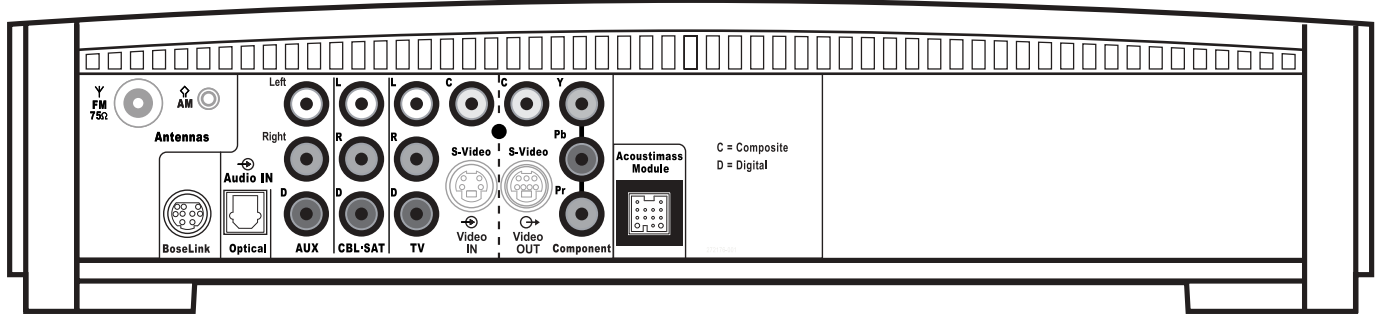

Note: For more information on advanced connections, refer to the DVD setup disc that came with your 3•2•1 Series II home entertainment system.

Connecting a game console

Connect the audio output of a game console to the **AUX Left** and **Right** input jacks. Connect the video output of the game console to the **C (composite) Video IN** jack.

Figure 18

Game console connections

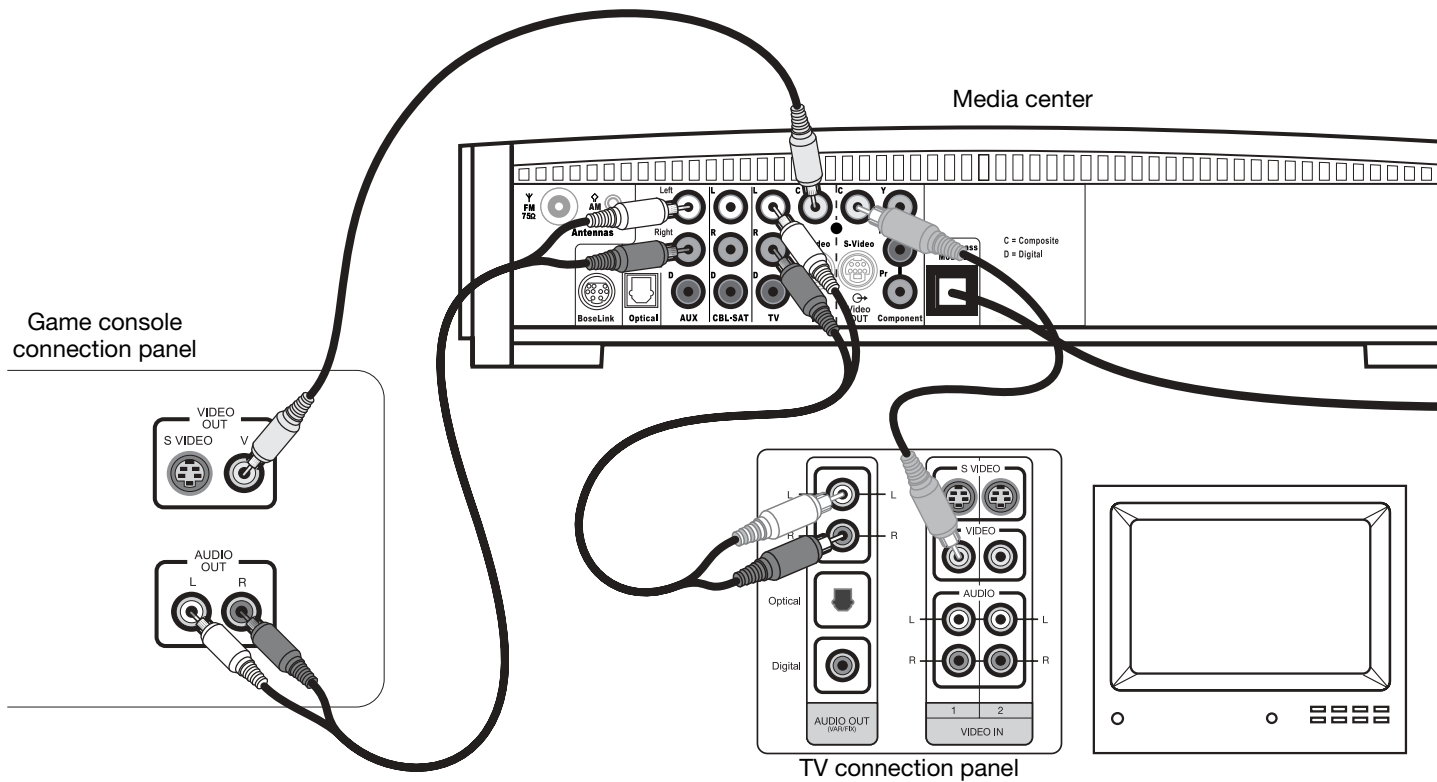

IMPORTANT

If you connected your game console this way, you will need to select the AUX source on the 3•2•1 remote in order to hear sound from the game console.

Installing the remote control batteries

1. On the back of the remote, slide open the battery compartment (Figure 19).
 2. Insert the two supplied AA (IEC-R6) 1.5V batteries, or their equivalent, as shown. Match the plus (+) and minus (-) marked on the batteries with the plus (+) and minus (-) inside the battery compartment.
 3. Slide the battery compartment cover back into place.
- Note:** Replace the batteries when the remote control stops operating or its range seems reduced.

Figure 19

Installing the batteries

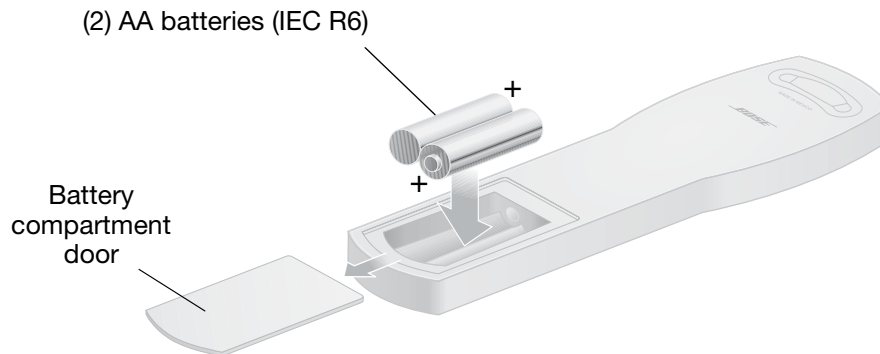

Connecting the power cord

⚠ CAUTION: For dual voltage models only, be sure to set the dual voltage switch on the back of the Acoustimass® module to the appropriate voltage for your area (115V or 230V) before connecting to power. If you are not sure about the proper voltage for your area, consult your local electrical authorities.

1. Insert the small connector end of the power cord into the AC INPUT connector on the Acoustimass module (Figure 20).
2. Insert the large end of the cord into an AC power (mains) outlet.

🎵 Note: On 220-240V models only, turn the Acoustimass module POWER switch to on (I).

Figure 20

Connecting to power

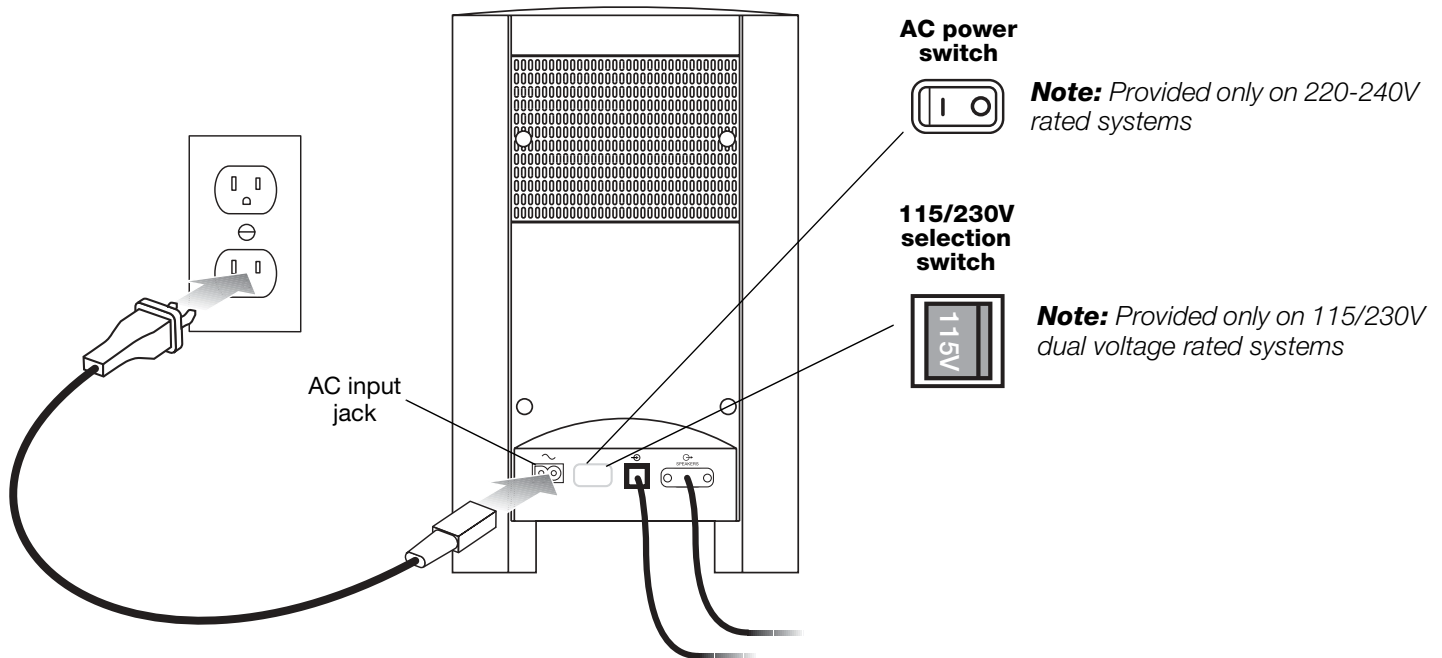

Checking your system setup

1. Check the following before you continue:

- All cables are connected for the setup you chose.
- The batteries were installed in the remote control.
- The power cord was installed and plugged into a live AC receptacle.

2. Turn on your TV. Use the remote control that came with your TV.

3. Select the right video input on your TV to view the 3•2•1 system video output.

- Refer to the name of the TV video input you used during setup.
- Use the remote for your TV to select the video input for your 3•2•1 system. The video input button might be labelled “TV Input”, “TV/VCR”, or “AV”. Refer to your TV’s owner’s guide for help.

4. Turn off the speakers on your TV.

- Refer to your TV’s owner’s guide for help.
- If your TV does not have an option to turn off the internal speakers, you may need to adjust both the 3•2•1 system volume and your TV volume until you find a level that produces the desired sound.
- In some TVs, when the internal speakers are turned off, you may need to raise the TV’s volume level by 75% to 100% in order to hear audio from the 3•2•1 home entertainment system. See your TV owner’s guide for help.

5. Turn on your 3•2•1 system.

- Point the 3•2•1 remote control at the media center and press **On-Off**.



6. Play the 3•2•1 setup DVD.

- Press **Eject** on the media center control panel.
- Insert the DVD setup disc into the disc tray.
- Press **Eject** again to close the tray. The DVD will automatically begin to play. If it does not, press the play button ().

 **Note:** Be sure to play the Setup DVD, included in the carton with your system, as soon as all the connections are completed. This will help you verify the connections you have made and confirm proper sound performance.

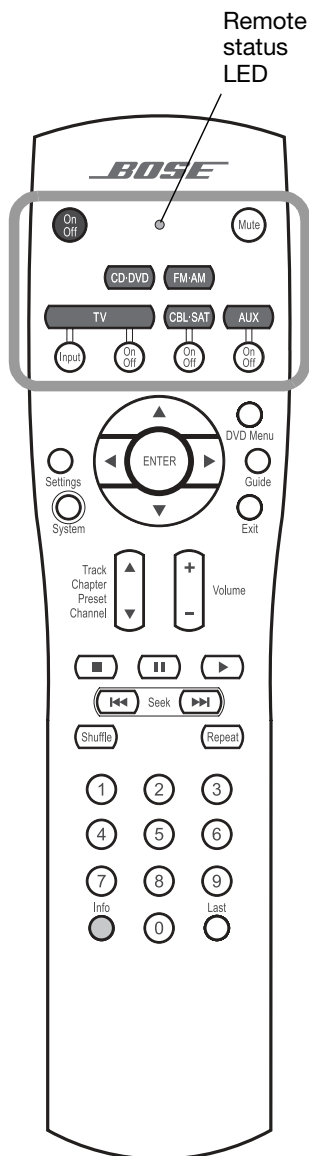
Remote control



-  Turns the system on or off.
-  Status LED:
 - Remains off (unlit) during normal operation.
 - Remains on during setup mode. Turns off briefly with each key press.
 - Blinks rapidly eight times if the wrong key is pressed during setup or if an unavailable device code is entered.
 - After ten seconds of no key presses, blinks rapidly eight times and the remote exits the setup mode.

 Silences or restores the sound from the current source.

 Selects the built-in CD/DVD player and turns the system on.





- Selects the built-in tuner and turns the system on to the previously selected FM/AM station.
- Switches between FM and AM when the tuner is selected.

 **TV:** Turns your system on and selects the TV input as the sound source.

 **Input:** Changes the external input to your TV. For example, your TV might have two external inputs where one is connected to your cable box and the other to your VCR. Pressing this button alternates between the cable box and the VCR.*

On/Off: Turns your TV on and off.*

 **CBL-SAT:** Turns your system on and selects the CBL-SAT input as the sound source.

 **On/Off:** Turns your cable/satellite box on or off.*

 **AUX:** Turns your system on and selects the AUX input as the sound source.

 **On/Off:** Turns a VCR or PVR that is connected to the AUX jack on or off.*

* Requires special remote settings. See "Setting up your remote to control other audio/video devices" on page 35.

Remote control – cont.

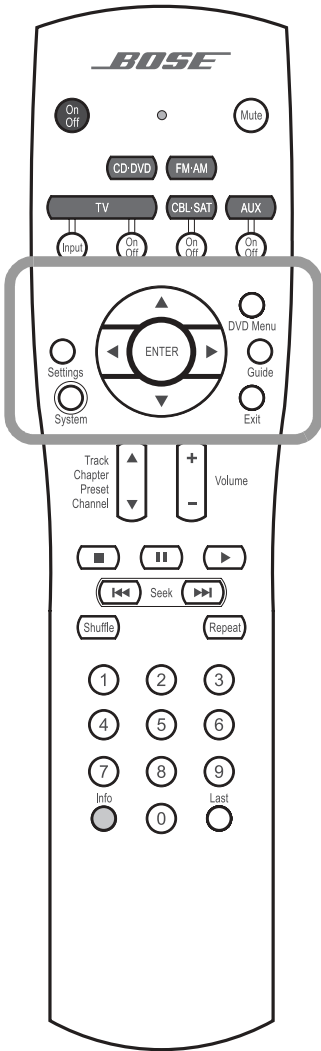

Settings

Puts the Settings menu for the current source on your TV screen or media center display.



System

Puts the System menu on your TV screen.



DVD Menu

- Puts the DVD menu of the currently loaded DVD disc on your TV screen.
- Puts the main menu of a cable/satellite box, VCR, or PVR on your TV screen (if supported).*



Guide

Puts the TV program guide (if supported) on your TV screen.



Exit

Dismisses the Settings menu, System menu, or TV program guide (if supported) from your TV screen or media center display.



- Tunes the FM or AM radio to the next higher or lower frequency.
- Selects the next item, up or down, in menus.

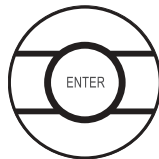

ENTER

Confirms a menu selection or introduces the next level of menu options.

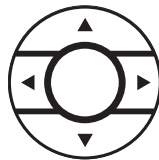

Moves up, down, left, or right in onscreen menus and media center displays.

* Requires special remote settings. See "Setting up your remote to control other audio/video devices" on page 35.

Remote control – cont.

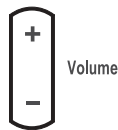
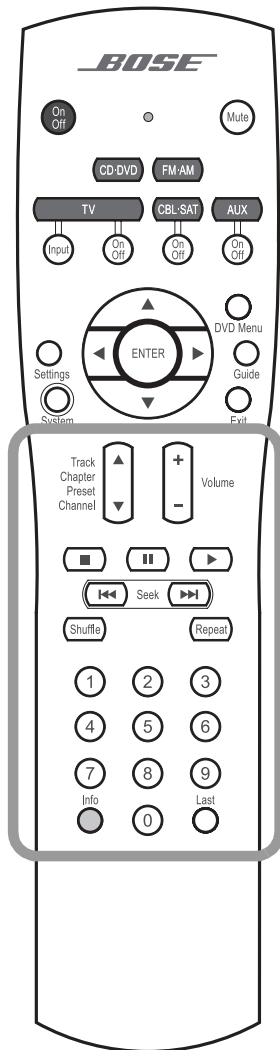

Volume

- Raises or lowers the volume of the current source.
- Pressing + restores muted sound from the current source.
- Pressing – lowers the volume of the current source, but does not restore muted sound.



Track
Chapter
Preset
Channel

Skips to the next or previous CD track, DVD chapter, radio station preset, or TV channel (if the remote is set up to control your TV).



- Stops the disc player.
- *For DVDs only*, the disc stops and the system saves the DVD play position. Pressing (▶) continues the DVD from the saved play position. Pressing (■) twice for a disc in play returns to the beginning of the disc.



- Pauses a currently playing disc.
- Pressing (⏸) again (or pressing (▶)) resumes play of a paused disc.
- After 20 minutes of no user interaction, the disc player stops and returns to the beginning of the disc to wait for the next command.



Starts the disc player.



- Skips backward or forward through CD tracks.
- Skips backward or forward through DVD chapters.
- Seeks backward or forward to the next strongest radio station.



Plays audio CD tracks in random order. Press again to cancel this mode.



Repeats a CD, CD track, DVD chapter, or DVD title. Press again to change the repeat mode.

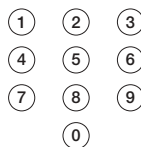

- Provides a means for selecting a CD track, DVD chapter, radio station preset, or TV channel.
- Allows you to change numerical values for some menu options.



Info

- Displays or dismisses a cable/satellite information window, if supported.
- If playing an MP3 CD, displays or dismisses artist and title information on the media center display panel.



Last

Skips to the previous TV channel (if supported by your TV).

The media center

The media center has a control panel on the top, a display area to show the current status of the system, and a disc tray that opens on the front of the console.

Control panel

The media center has six buttons located on the top control panel. Their functions are also available through use of the remote control.

Figure 21

Media center controls

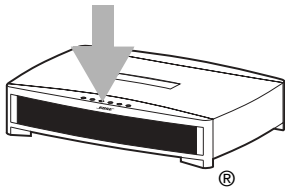

On-Off



Turns system power on or off.

Source



Steps through the available source selections.

- Volume +



Lowers or raises the volume level.



Enter



- Used to navigate through menus.
- Selects the next available FM/AM preset.

Eject



Opens or closes the disc tray.

Note: If you selected another source by pressing the **Source** button, you cannot control the new source with the remote until you press the button for that new source on the remote.

Display indicators

With the system turned on, the music center display lights up to show the state of the system. Not all possible choices, shown below, light up at once (Figure 22). The display changes with each adjustment or selection you make.

Figure 22

Sample media center display

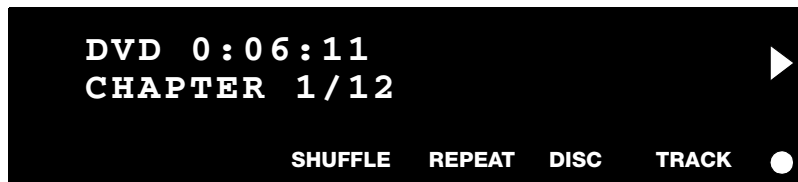

Lights to indicate disc is in play.

Lights briefly when a remote control command is received.

Lights to indicate shuffle mode is selected for the current disc.

Lights to indicate repeat mode is selected for current track or disc.

Lights to indicate "Repeat Disc" or "Shuffle Repeat Disc" mode is selected.

Lights to indicate "Repeat Track" mode is selected.

Turning your system on and off

To turn power on or off:

- Point the 3•2•1 remote at the media center and press **On/Off**.

OR

- Press **On-Off** on top of the media center.

To turn the system on to a source:

- Press **CD-DVD**, **FM-AM**, **TV**, **CBL-SAT**, or **AUX** on the 3•2•1 remote.

♪ **Note:** Your 3•2•1 remote control can be set up to control other audio devices such as your TV, VCR, or cable/satellite receiver. For instructions, see “Setting up your remote to control other audio/video devices” on page 35.

Playing video DVDs

Before you play your first DVD:

- Familiarize yourself with the 3•2•1 remote control. See “Remote control” on page 26.
- Be sure you understand how to switch between the available video inputs on your TV. To view a video DVD, you will need to select the video input on your TV that is connected to video output of the 3•2•1 media center (see “Connecting your TV to the media center” on page 15).
- If you are unable to select the correct video input on your TV, please consult your TV’s owner’s guide.
- Be sure that you play the 3•2•1 system setup DVD first. This will help you verify the connections you have made and confirm proper sound performance.

1. Turn on your TV.
2. On the 3•2•1 remote, press **CD/DVD** to turn the 3•2•1 system on to the CD/DVD source.
3. On the media center control panel, press **Eject** to open the disc tray.
4. Place the DVD disc in the disc tray.
5. Press **Eject** again to close the tray.

The DVD should begin to play automatically. If not, press **Play** on the 3•2•1 remote.

♪ **Note:** Not all DVDs offer the same features. For example, you can choose to display subtitles while watching a movie only if that particular disc provides subtitle information.

While a DVD video is playing, elapsed play time and chapter number are displayed on the media center front panel.

Figure 23

Sample display for a DVD video

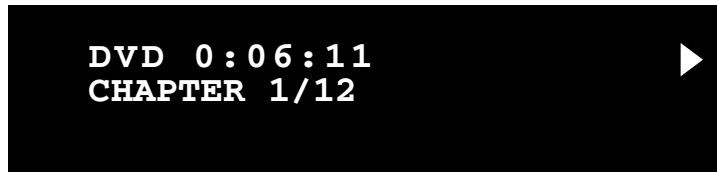

Basic DVD operations



- Press **Pause** to pause a movie.

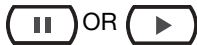

- Press **Pause** again, or press **Play** to resume playing a paused CD.



- Use the stop button (■) to interrupt a movie in play.
 - Press ■ once to interrupt a playing movie. The system holds the movie at the point of interruption. Press **Play** to resume play from the point of interruption.
 - OR
 - Press ■ twice. Play is interrupted and the system returns to the beginning of the disc. Press **Play** to restart the video.



- Press **Chapter ▲** to skip to the next chapter on the current DVD. Press **Chapter ▼** to skip to the previous chapter.



- Press **Repeat** while a chapter is playing to make it repeat.



- Press **◀◀** to scan backward through the current DVD. Press **▶▶** to scan forward.

Eject



- Press **Eject** on the media center to stop a disc and open the disc tray.

🎵 **Note:** For information on changing DVD-related source settings, see “DVD settings menu” on page 42.

Restricting access to video DVDs

The DVD Lock menu allows you to restrict access to video DVDs which may contain inappropriate material for certain members of your family. You can get to the DVD Lock menu by pressing the **System** button on the remote control. This feature allows you to set up password access for movies which have a certain rating. For instructions on using the DVD Lock menu, see “DVD Lock options” on page 50.

Playing audio CDs



1. On the 3•2•1 remote, press **CD/DVD** to turn the 3•2•1 system on to the CD/DVD source.

Eject



2. On the media center control panel, press **Eject** to open the disc tray.

3. Place the DVD disc in the disc tray.

Eject



4. Press **Eject** again to close the tray.



5. The audio CD should begin to play automatically. If not, press **Play** on the 3•2•1 remote.

Basic CD operations



- Press **Pause** to pause an audio CD.

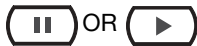

- Press **Pause** again, or press **Play** to resume playing a paused CD.



- Press **Stop** to stop an audio CD.



- Press **Track ▲** to skip to the next track on the current CD. Press **Track ▼** to skip to the previous track.



- Press and hold **Seek ◀◀** to scan backward through the current CD. Press and hold **Seek ▶▶** to scan forward.
- Press **Seek ▶▶** once to advance to the next song.



- Press **Repeat** once for REPEAT TRACK mode. Press **Repeat** again for REPEAT DISC mode. Press **Repeat** again to turn the repeat functions off (REPEAT OFF).



- Press **Shuffle** once for SHUFFLE DISC mode. Press **Shuffle** again to turn off the shuffle mode (SHUFFLE OFF).

Note: For information on changing CD-related source settings, see “CD settings menu” on page 41.

Note: If playing an MP3 CD, the **Info** button displays or clears artist and title information on the media center display panel.

Listening to FM/AM radio



On the 3•2•1 remote, press **FM-AM**. If the system is off, the radio will turn on to the most recently selected station.

Tuning to a station

You can tune to a radio station in any of the following ways:



- Press **FM-AM** to switch between the FM and AM bands.

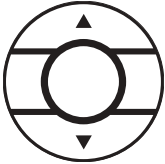

- Press **Tune ▲** to tune up the band. Press **Tune ▼** to tune down the band.



- Press **Seek ◀◀** to go to the previous station. Press **Seek ▶▶** to go to the next available station. Press and hold for rapid tuning. Release to stop at the next available station. To stop anytime, briefly press **Seek ◀◀** or **Seek ▶▶**. To begin seeking again without holding down the **Seek** button, briefly press **Seek ◀◀** or **Seek ▶▶** as soon as the first seek operation stops.



- Press **Preset ▲** to select the next stored station. Press **Preset ▼** to select the previous stored station.

OR

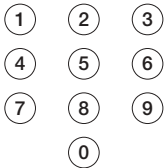

- Press the number of a stored station on the keypad.

🎵 **Note:** For information on changing FM/AM-related source settings, see “FM/AM settings menu” on page 41.

Storing stations as presets

Using your 3•2•1 remote control you can store up to 20 AM and 20 FM station presets. This enables you to tune to a favorite station quickly.

1. Tune to the preferred station.
2. Store the station with an assigned preset number.
 - For numbers 1-9, press the single number button and hold it. For numbers 10-20, press the first number. Immediately after, press the second number and hold it.
 - OR, press **Enter** on the media center to store the selected station at the next available preset number.

The newly assigned preset number appears briefly on the media center display.

🎵 **Note:** Assigning a preset number to a station will replace any previous assignment of that preset.

Erasing a preset

1. Tune to the preset station.
2. Press and hold the **0** button on the remote until the media center display tells you that the preset is erased.

Playing other sources

Turn on any component connected to the media center by using the remote for that component or controls on the component front panel. Use the 3•2•1 Series II or 3•2•1 GS Series II system remote to get started:

- Pressing **TV**, **CBL-SAT**, or **AUX** on the 3•2•1 or 3•2•1 GS system remote turns on the system and selects the audio for that component. Be sure a tape or disc is loaded, as needed.
- Use the **Volume** up or down arrows on the system remote or on the media center to raise or lower the volume of the system.

Using the sleep timer

Your system includes a sleep timer which can be set to turn your system off automatically after 1 to 90 minutes of listening to any source. This timer can be accessed through the Settings menu for any source. See “Changing Source Settings” on page 39.

 **Note:** *The sleep timer will not turn off the TV or other audio device.*

Setting up your remote to control other audio/video devices

Your remote can be set up to control other audio devices such as a TV, VCR, PVR or cable/satellite box by entering a device code while in the setup mode.

- **If you know the device code, follow the instructions under the heading, “Direct entry of a device code”** below. Device codes are listed in the back section of this owner’s guide and in the System menus under Remote Control options.
- **If you can’t find the device code and want to search the system for it, see “Searching for a device code” on page 36.**
- **If you want to verify the device code you have entered for an audio device, see “Verifying an entered device code” on page 38.**

♪ **Note:** More than one code may work with your particular brand of product. If you notice a lack of response or limited functionality after setting up the remote, try a different code.

♪ **Note:** The remote status LED flashes rapidly eight times if you press an invalid key, or enter an unavailable device code. Wait seven seconds for the error to clear and start again.

Direct entry of a device code

Device codes can be found at the back of this owner’s guide or in the System menu under Remote Control options. If you know the device code, you can do the following:

To set up the remote to control your TV

1. Turn on both the 3•2•1 system and your TV.
2. Press and hold the **TV** button until the remote LED is lit (about five seconds).
3. On the remote keypad, enter the four-digit device code for your TV. The LED will turn off temporarily as you press each key.
4. Check that the LED turns off after the code is entered. If the LED blinks, the code is invalid. Try again.
5. Point the remote at your TV and press the **TV On-Off** button. If your TV does not respond, go back to step 2 and try other codes. If you are still unsuccessful, see “Searching for a device code” on page 36.

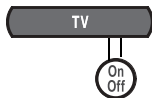

To set up the remote to control your cable/satellite box

1. Turn on both the 3•2•1 system and your cable/satellite box.
2. Press and hold the **CBL-SAT** button until the remote LED is lit (about five seconds).
3. On the remote keypad, enter the four-digit device code for your cable/satellite box. The LED will turn off temporarily as you press each key.
4. Check that the LED turns off after the code is entered. If the LED blinks, the code is invalid. Try again.
5. Point the remote at your cable/satellite box and press the **CBL-SAT On-Off** button. If your cable/satellite box does not respond, go back to step 2 and try other codes. If you are still unsuccessful, see “Searching for a device code” on page 36.



Controlling Other Audio Devices

To set up the remote to control your VCR or PVR (such as Tivo or Replay TV)

1. Turn on both the 3•2•1 system and your VCR or PVR.
2. Press and hold the **AUX** button until the remote LED is lit (about five seconds).
3. On the remote keypad, enter the four-digit device code for your VCR/PVR. The LED will turn off temporarily as you press each key.
4. Check that the LED turns off after the code is entered. If the LED blinks, the code is invalid. Try again.
5. Point the remote at your VCR or PVR and press the **AUX On-Off** button. If your VCR or PVR does not respond, go back to step 2 and try other codes. If you are still unsuccessful, see “Searching for a device code” on page 36.



Searching for a device code

Use this method if you do not know the device code for a device.

🎵 **Note:** This is a very time-consuming process. Use it as a last resort.

To set up the remote to control your TV

1. Turn on both the 3•2•1 system and your TV.
2. Press and hold **TV** until the remote LED is lit (about five seconds).
3. Alternately press **Channel ▲** and **TV On-Off** until your TV turns off.

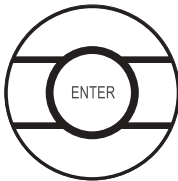
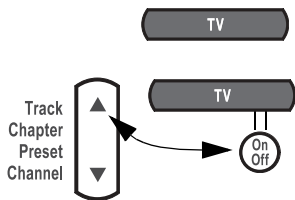

4. Press **Enter**. Check that the remote LED turns off.

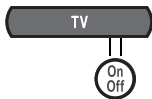

5. Point the remote at your TV and press **TV On-Off**. If your TV does not respond, go back to step 2 and try again.

To set up the remote to control your cable/satellite box

1. Turn on both the 3•2•1 system and your cable/satellite box.
2. Press and hold **CBL-SAT** until the remote LED is lit (about five seconds).
3. Alternately press **Channel ▲** and **CBL-SAT On-Off** until your cable/satellite box turns off.

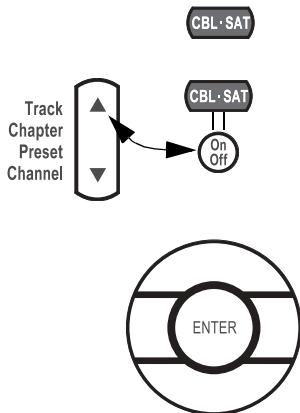

4. Press **Enter**. Check that the remote LED turns off.

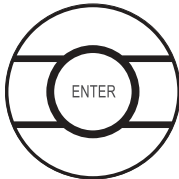

5. Point the remote at your cable/satellite box and press **CBL-SAT On-Off**. If your cable/satellite box does not respond, go back to step 2 and try again.



To set up the remote to control your VCR or PVR (for example, TiVo or Replay TV)

1. Turn on both the 3•2•1 system and your VCR/PVR.
2. Press and hold **AUX** until the remote LED is lit (about five seconds).
3. Alternately press **Channel ▲** and **AUX On-Off** until your VCR/PVR turns off.

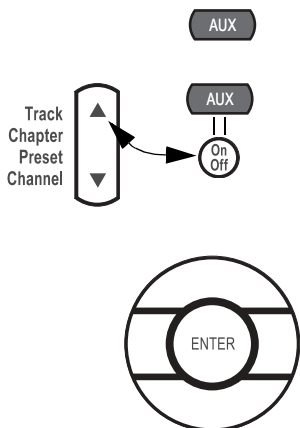

4. Press **Enter**. Check that the remote LED turns off.

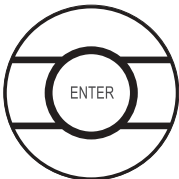

5. Point the remote at your VCR/PVR and press **AUX On-Off**. If your VCR/PVR does not respond, go back to step 2 and try again.



Verifying an entered device code

In case you need to check to see what code the remote is using for a particular audio device, do the following:



1. Press and hold a source key (**TV**, **CBL-SAT**, or **AUX**) until the remote LED lights (about five seconds)
2. Press the **Info** button.
3. Press **1** on the remote and count the number of times the LED blinks (zero is indicated by a long blink). This is the first digit.
4. Press **2** on the remote and count the number of times the LED blinks (zero is indicated by a long blink). This is the second digit.
5. Press **3** on the remote and count the number of times the LED blinks (zero is indicated by a long blink). This is the third digit.
6. Press **4** on the remote and count the number of times the LED blinks (zero is indicated by a long blink). This is the fourth digit.



7. Press **Exit**.

Changing channel selection control

If you are using your 3•2•1 home entertainment system with other audio devices, such as a VCR and cable/satellite box, you may wish to change channels using one of these other audio devices rather than your TV.

You can easily switch your 3•2•1 remote to change channels on another audio device:



1. Press and hold **Last** on the 3•2•1 remote. The remote status LED will illuminate and blink the number of times corresponding to the device controlling channel selection.

1 blink = TV
2 blinks = CBL-SAT
3 blinks = AUX

2. After the blinking stops, press the source button (**TV**, **CBL-SAT**, or **AUX**) that corresponds to the device you want to use for channel selection.



3. Press **Exit** on the 3•2•1 remote.

To confirm, press and hold **Last** on the 3•2•1 remote and count the number of blinks. If the change was made, press **Exit**. If not, repeat steps 2 and 3.

Using the settings menus

While watching a video or listening to music on your system, you can make quick adjustments that will increase your enjoyment of the program. For that purpose, each source you use with this system has its own Settings menu with features appropriate to that source.

To view the settings menus

You can see the Settings menu for each source on your TV screen (Figure 24) and on the display panel of your media center (Figure 25).

1. Turn on your TV and select the correct TV input to view your 3•2•1 system.
2. Press a source button on your 3•2•1 remote control.
3. Press **Settings** to display the Settings menu for the selected source.

If the list of menu items is too long for the screen, a small down or up arrow indicates that you need to scroll down or up to see other items.

4. Press **Exit** to dismiss the Settings menu.



Figure 24

Sample Settings menu on your TV screen

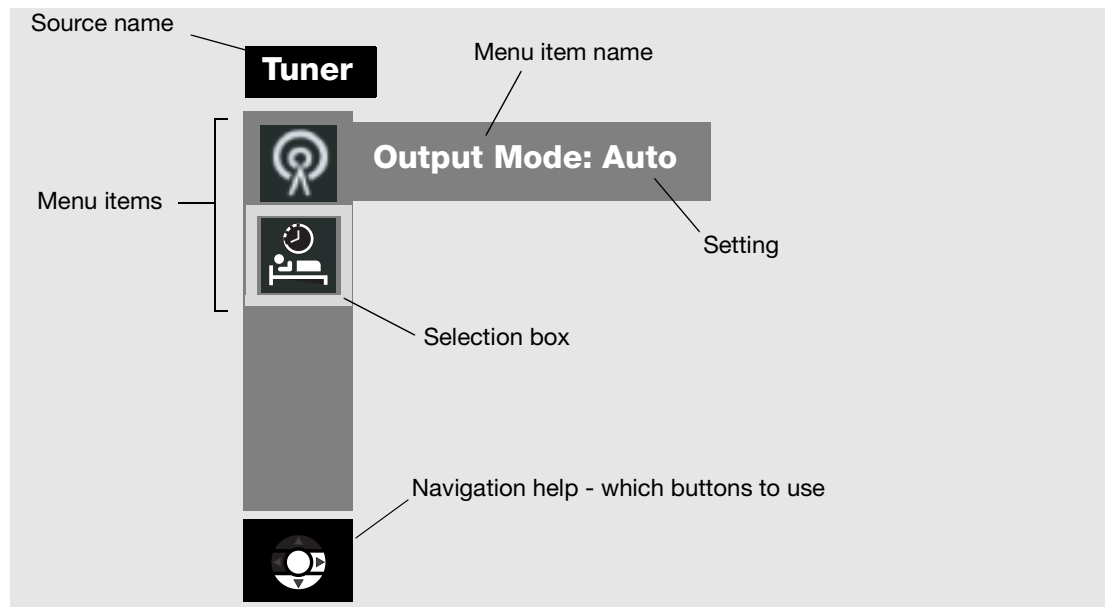

Note: Any changes made in the settings menu on your TV screen will also appear in the media center display panel.

On the media center display panel, menu items will scroll in and out of view as you press the up (▲) and down (▼) arrow buttons on the remote.

Figure 25

Sample Settings menu on the media center display

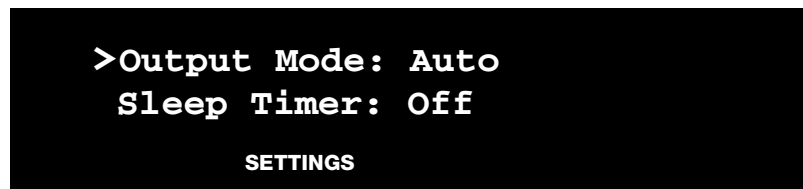

To make changes in the settings menus

Whether you use your TV screen or the media center display to change settings, the same instructions apply.

You can use the actions above to change back to the original (default) settings, too. Do that if you do not like the effect of a change you have made, or accidentally made a change you did not intend. The default settings for each source are shown in the menu tables on the following pages.

1. Turn on your TV and select the correct TV input to view your 3•2•1 system.
2. Press a source button on your 3•2•1 remote control.
3. Press **Settings** to display the Settings menu for the selected source.
4. Using the down (▼) and up (▲) arrow buttons, select the menu item you want to change.
5. Press the right arrow (▶) button to select the menu item setting.
6. Press the up (▲) or down (▼) arrow button to change the setting.
7. Press **Enter** or the left arrow (◀) button to save the setting.
8. Press **Exit** to dismiss the Settings menu.



The progression in Figure 26 shows output mode for the FM tuner being changed from Auto to Stereo.

Figure 26

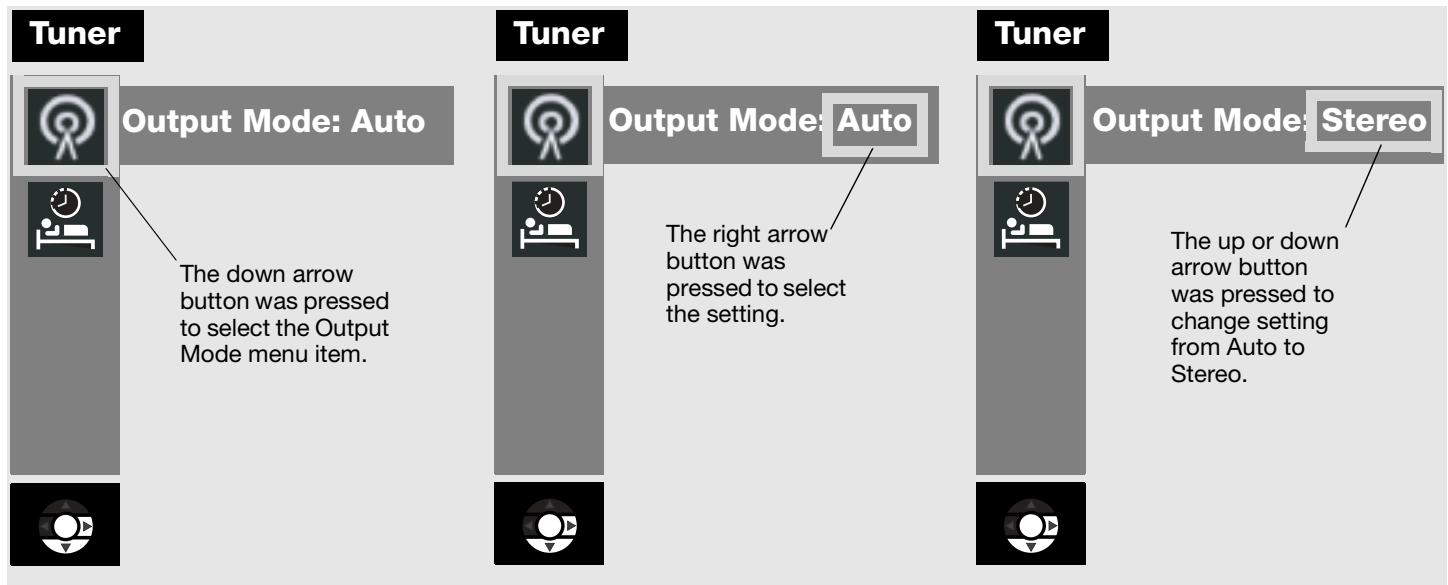

Changing the FM output mode setting



🎵 **Note:** You can restore all default settings by choosing **Restore Settings** in the Systems menu, under **Media Center** options. This reverts all source settings back to the factory default settings. It also changes the **Audio Processing** setting back to **Automatic** (found in the Systems menu under Audio options).



FM/AM settings menu

To see the FM/AM Settings menu, press **FM-AM** on the remote. Then press **Settings**. Press **Exit** to remove the menu from the screen.

<i>Item</i>	<i>Name</i>	<i>Settings</i>	<i>Default</i>	<i>Description</i>
	Output Mode (FM only)	Auto, Stereo, Mono	Auto	Allows you to listen to stereo broadcasts in either stereo or mono output.
	RDS Info (FM only, and only on some systems)	Off, On	Off	Displays station and program information (as available from Radio Data System).
	Sleep Timer	Off, 10-90 minutes	Off	Turns the system off after the set time expires. Choose off to deactivate the timer.

CD settings menu











To see the CD Settings menu, press **CD-DVD** on the remote while playing an audio CD. Then press **Settings**. Press **Exit** to remove the menu from the screen.

<i>Item</i>	<i>Name</i>	<i>Settings</i>	<i>Default</i>	<i>Description</i>
	Track	__ of __		Allows you to select a track on the current disc.
	Sleep Timer	Off, 10-90 minutes	Off	Turns the system off after the set time expires. Choose off to deactivate the timer.

Changing Source Settings

DVD settings menu

To see the DVD Settings menu, press **CD-DVD** on the remote while playing a DVD video disc. Then press **Settings**. Press **Exit** to remove the menu from the screen.





Item	Name	Settings	Default	Description
	Movie EQ*	On, Off	On	Optimizes the tonal balance for movies.
	Range Compression*	On, Off	On	Adjusts volume to maintain dialogue intelligibility. Keeps some sounds from overwhelming others.
	Mono Decoding*	On, Off	On	Engages Videostage® 5 mono decoding circuitry to process mono sound (one-channel audio) for your system.
	Time	_: _	0:00	Displays the elapsed time of the current DVD. Also, allows you to move to a new location in the movie by entering a new time.
	Title	__ of __		Selects a DVD title from the current disc, according to the number set. Some DVDs do not allow direct access to titles.
	Chapter	_____		Selects a DVD chapter from the current DVD movie, according to the number entered. Some DVDs do not allow direct access to chapters.
	Audio Track	Dependent on disc		Allows you to choose one of the available audio tracks on the current disc.
	Subtitle language	Dependent on disc		Allows you to choose one of the available subtitle languages (only if included on disc).
	Camera Angle	1 of _____		Allows you to select one of the available camera angles (only if included on disc).
	A-B Repeat	A, B		Repeats a segment of the DVD after the start and end points are defined. To begin: <ol style="list-style-type: none"> 1. Move backward or forward to the point in the DVD where you want the segment to start. 2. Press Enter. 3. Move to the point where you want it to end. 4. Press Enter. Repeats until you press the Exit or Settings button.
	Sleep Timer	Off, 10-90 minutes	Off	Turns the system off after the set time expires. Choose off to deactivate the timer.

*Available only when Audio Processing is set to User Adjustable. See "Audio options" on page 46 for more information.

TV, CBL-SAT, and AUX settings menu

The settings below affect programs on the TV, even when the source of the program is VCR, CBL/SAT or AUX. There are no separate setting menus for these sources.

Movie EQ, Range Compression and Mono Decoding appear in the menu only if **Audio Processing** is set to **User Adjustable**. Audio Processing can be found in the System menu under Audio options.

<i>Item</i>	<i>Name</i>	<i>Settings</i>	<i>Default</i>	<i>Description</i>
	Movie EQ*	On, Off	On	Optimizes the tonal balance for movies.
	Range Compression*	On, Off	On	Adjusts volume to maintain dialogue intelligibility. Keeps some sounds from overwhelming others.
	Mono Decoding*	On, Off	On	Engages Videostage® 5 mono decoding circuitry to process mono sound (one-channel audio) for your system.
	Dolby Digital 1+1**	1, 2, Both	1	Plays audio content of selected soundtrack(s). The content of the second soundtrack may be a second language, for example.
	Sleep Timer	Off, 10-90 minutes	Off	Turns the system off after the set time expires. Choose off to deactivate the timer.

*Available only when Audio Processing is set to User Adjustable. See “Audio options” on page 46 for more information.

** Available only when a Dolby Digital 1+1 signal is detected.

Using the System menu

Changes to system options are typically made only once. If your system operates as you want it to, there may be no need for any changes. In some cases, however, changes are required to make the system fully compatible with the installation options you have chosen.

To view the System menu

Unlike the source settings menus, the System menu only appears on your TV screen.

1. Turn on your TV and select the correct TV input to view your 3•2•1 system.
2. Press the **System** button on your 3•2•1 remote control. The System menu appears with Audio options selected, showing a list of the Audio options that can be changed.
3. Press **System** again, or press **Exit** to dismiss the System menu.



Note: Entering the System menu causes any DVD or VCD that is playing to pause.

Figure 27

Sample system menu showing audio options

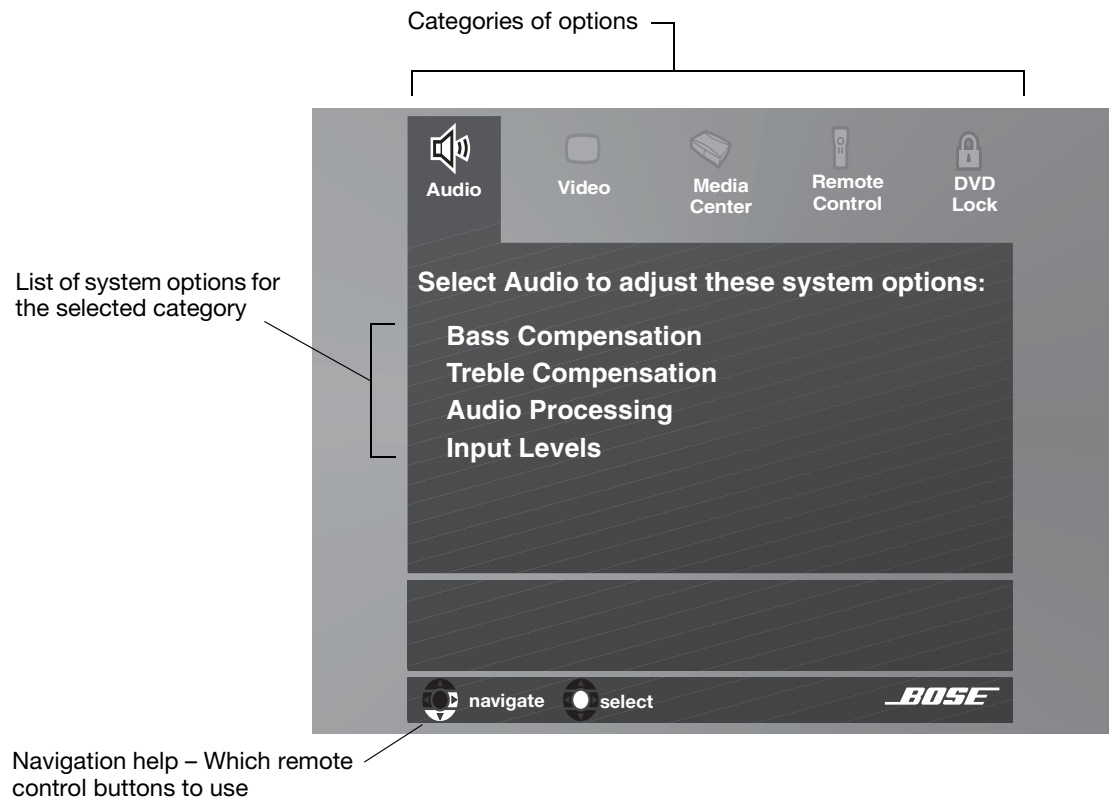

To change system options

Changing system options in this menu is similar to changing the settings for a source.

1. Turn on your TV and select the correct TV input to view your 3•2•1 system.
2. Press the **System** button on your 3•2•1 remote control.
3. Using the right (▶) and left (◀) arrow buttons, highlight one of the option categories (Audio, Video, Media Center, Remote Control, or DVD Lock).
4. Press **Enter** or the down (▼) arrow to select the option category.
5. Using the down (▼) and up (▲) arrow buttons, select the system option to change.
6. Press the right arrow (▶) button to see the system option settings.
7. Press the up (▲) or down (▼) arrow button to change the setting.
8. Press **Enter** or the left arrow (◀) button to save the setting.
9. Press **System** again, or press **Exit** to dismiss the System menu.



System



Exit

Audio options

The audio options affect the way the system sounds in your home.

🎵 **Note:** Listening to an audio source while you change audio options can be helpful. Some changes will be immediately noticeable and therefore useful in fine tuning your selections.

Figure 28

Audio system options

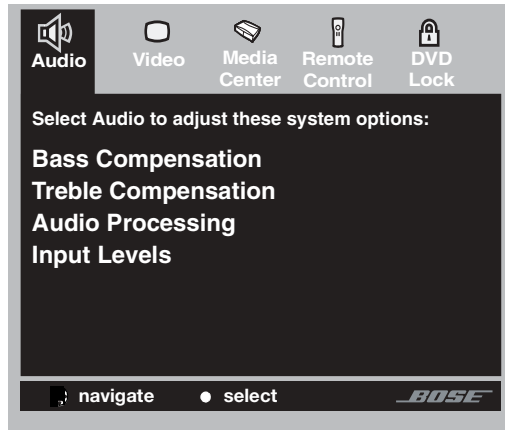

System Option	Settings	Description
Bass Compensation	0 [default] -14 to +14	Normal low-frequency reproduction. Decreased (-) or increased (+) low-frequency reproduction.
Treble Compensation	0 [default] -14 to +14	Normal high-frequency reproduction. Decreased (-) or increased (+) high-frequency reproduction.
Audio Processing	Automatic [default] User Adjustable	Standard Bose® processing applied. Processing options (Movie EQ, Range Compression, Mono Decoding) available in Source Settings menus.
Input Levels: TV Analog Input Level TV Digital Input Level CBL/SAT Analog Input Level CBL/SAT Digital Input Level AUX Analog Input Level AUX Digital Input Level	Normal [default] -6, -3, +3, +6	Standard signal level (loudness). Decreases or increases signal level (adjustable to match the levels of other audio devices). Note: You may want to adjust the input levels of external audio devices so they match the system's internal FM and CD levels.

Video options

The video options affect the way the picture looks on your TV.

Figure 29

Video system options

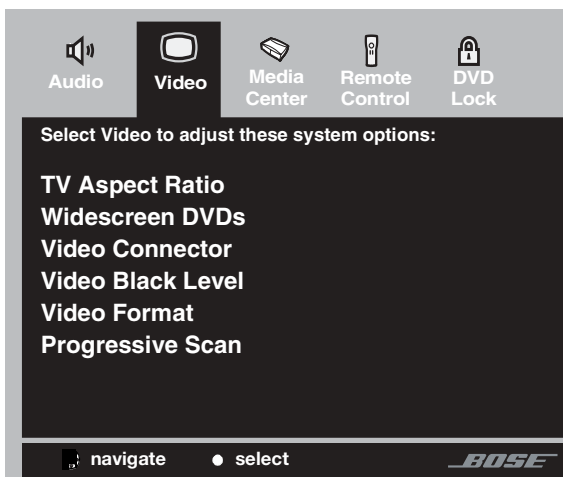

System Option	Settings	Description
TV Aspect Ratio	Normal [default] Widescreen	4:3 ratio screen display. 16:9 ratio widescreen display.
Widescreen DVDs	Modified [default] Unmodified	Modified [default]. Unmodified.
Video Connector*	Composite + S-Video [default] Component	Identifies the type of video connection made on the back panel of the media center.
Video Black Level	Normal [default] Extended	Screen black level generally appropriate for TVs. Increases screen black level, appropriate for certain TVs.
Video Format	NTSC [default] PAL	Correct for NTSC (US standard) monitors. Correct for PAL (European standard) monitors.
Progressive Scan**	Off [default] On	Screen image repaints in standard style. Screen image repaints in advanced style (if available on the TV).

* A read-only item that indicates the connection detected automatically by the system.

** Appears only when **Video Connector** is **Component**.

Media center options

The media center options affect the general operation of the system.

Figure 30

Media Center system options

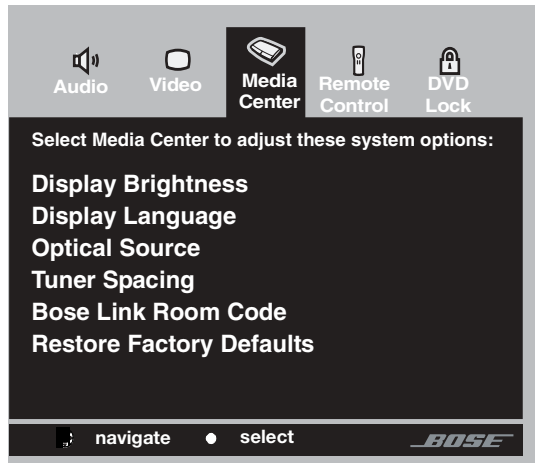

System Option	Settings	Description
Display Brightness	4 [default] 1 (darkest) to 4 (brightest)	Media center display lights with a mid-range brightness. Darkens or lightens the media center display.
Display Language	English [default] Dansk, Deutsch, Espanol, Francais, Italiano, Nederlands, Svenska	On-screen display menus appear in the selected language.
Optical Source	None [default] TV, CBL/SAT, AUX	No digital signal received via optical cable. Digital signal received via optical cable for selected source.
Tuner Spacing	US [default] European	Channel spacing for AM/FM radio stations set to selected region standard.
Bose link Room Code*	B [default], C, D, E, F, G, H, I, J, K, L, M, N, or O	Assigns a room code to your 3•2•1 Series II system when it is connected to a Bose® link source.
Restore Factory Defaults	No Yes	Maintains current system settings. Reverts system settings back to factory defaults.

** Appears only when a Bose® link source is connected.

Remote control options

The Remote Control options help you set up your remote to control other audio devices that are connected to your system.

Figure 31

Remote Control system options

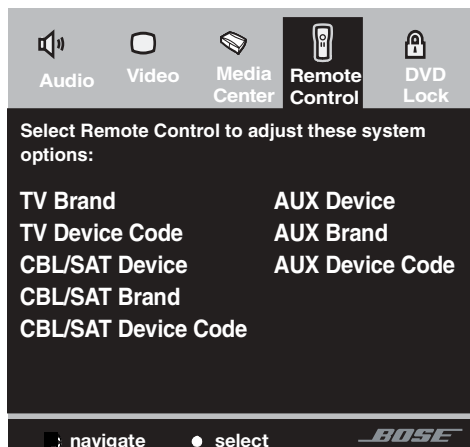

System Option	Settings	Description
TV Brand	Brand name	Provides a list of TV brands for the 3•2•1 remote control to operate.
TV Device Code	Code number	Provides a list of available device codes for the selected TV brand.
CBL/SAT Device	Cable, Satellite	Identifies which of two devices is connected to the CBL-SAT input.
CBL/SAT Brand	Brand name	Provides a list of cable/satellite box brands for the 3•2•1 remote control to operate.
CBL/SAT Device Code	Code number	Provides a list of available device codes for the selected cable/satellite box brand.
AUX Device	VCR, PVR	Identifies which of two devices is connected to the AUX input.
AUX Brand	Brand name	Provides a list of VCR/PVR brands for the 3•2•1 remote control to operate.
AUX Device Code	Code number	Provides a list of available device codes for the selected VCR/PVR brand.

Note: To find the brand and device codes for each component that can be connected to, and controlled by the 3•2•1 system, see “Device Codes” on page 57.

DVD Lock options

The DVD Lock options allow you to restrict viewing of DVD videos with certain ratings. To activate this feature, you need to set a level of restriction and establish a password in the DVD Lock section of the System menu.

Figure 32

DVD Lock system options

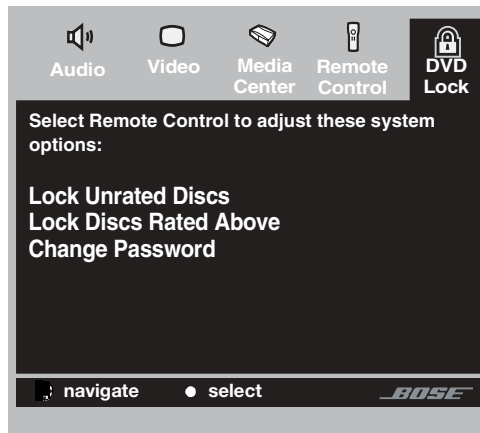

System Option	Settings	Description
Lock Unrated Discs	Off	No restriction applies to unrated DVD movies.
	On	Restricts viewing access to unrated titles when password is set.
Lock Discs Rated Above	1 to 8	Helps prevent viewing discs above the selected number when a password is created.
Change Password	----	Establishes a new four-number code to restrict access to movies with certain ratings.

Setting a password and restriction level

Your password will help prevent unauthorized viewing of DVD videos that have a higher rating than your restriction level. There are 8 levels to choose from, matched to movie ratings set by the Motion Picture Association of America (MPAA). See “Motion Picture Association of America (MPAA) rating system” on page 51.

1. Turn on your TV and select the correct TV input to view your 3•2•1 system.
2. Press the **System** button on your 3•2•1 remote control.
3. Using the right (▶) and left (◀) arrow buttons, highlight the DVD Lock option.
4. Press **Enter** or the down (▼) arrow key.



Note: If you are using the DVD Lock option for the first time, enter a four-digit password. Then enter it again to confirm.



5. Enter your four-digit password.
6. Using the down (▼) button, scroll down to Lock Discs Rated Above.
7. Press the right arrow (►) button to see the available settings.
8. Press the up (▲) or down (▼) arrow button to find the rating you want.
9. Press **Enter** or the left arrow (◄) button to save the setting.
10. Press **Exit** to dismiss the Settings menu.



Motion Picture Association of America (MPAA) rating system

<i>Parental Control Setting</i>	<i>MPAA Rating</i>	<i>Audience Restriction</i>
8		None
7	NC-17	Adult audiences
6	R	Mature audiences
5		Mature teenage audiences
4	PG-13	Teenage audiences
3	PG	Mature young audiences
2		Most audiences
1	G	General

Example: Choosing a Parental Control Setting of 4, restricts access to videos rated above PG-13. Videos with ratings above that may be viewed only after entering the password.

Your password also helps prevent others from changing the restriction level setting without permission.

Cleaning

Cleaning the media center

- Use only a soft, dry cloth to clean the outside surfaces of the media center.
- Do not use any sprays near the system. Do not use any solvents, chemicals, or cleaning solutions containing alcohol, ammonia, or abrasives.
- Do not allow liquids to spill into any openings.

Cleaning the speakers

- Clean the surface of your speakers with a soft, damp cloth. You can use an ammonia-free window cleaner on a soft cloth to maintain the finish.
- Do not use any sprays near the speakers. Do not use any solvents, chemicals, or cleaning solutions containing alcohol, ammonia, or abrasives.
- Do not allow liquids to spill into any openings.
- The speaker grilles require no special care, although you may vacuum them carefully if necessary.

Cleaning discs

- Handle discs by their edges to prevent fingerprints and scratches (Figure 33a).
- To remove stains or fingerprints from the surface of a disc, use a soft and dry lint-free, cloth. Wipe in straight movements from the center of the disc to the outside (Figure 33b). Do not use any chemical products; they can damage the disc.
- Do not use a circular motion to clean (Figure 33c).
- Do not write on or attach labels to the surface of a disc.
- To minimize exposure to dust and dirt, return discs to their cases after use. Store each disc in its case, away from direct sunlight, high temperatures, and humidity.

Figure 33

Disc care

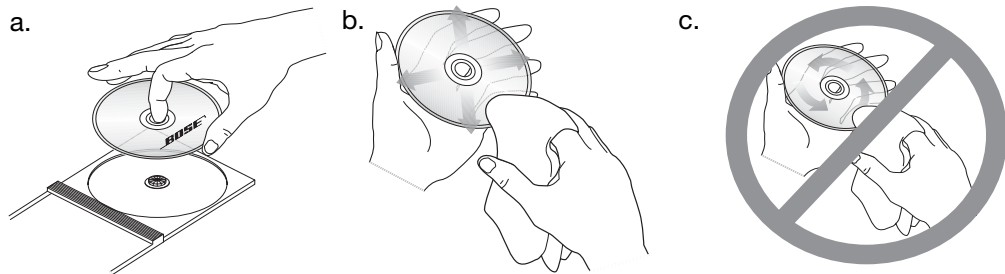

Replacing the remote control batteries



CAUTION: Please dispose of used batteries properly, following any local regulations. Do not incinerate.

- Slide open the battery compartment (Figure 34).
- Notice the polarity markings (+ and -) inside the compartment and install the batteries accordingly. Be sure to replace both batteries.
- Slide the battery compartment cover back into place.

Figure 34

Putting in the batteries

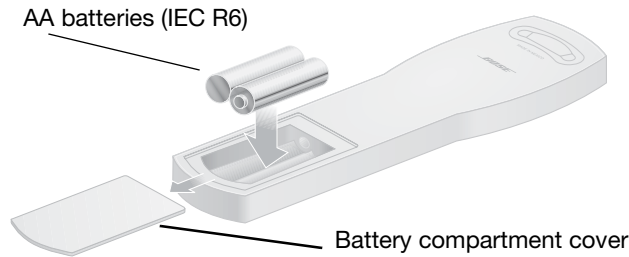

Accessories

The Bose® 3•2•1 Series II and 3•2•1 GS Series II system shelf speakers are compatible with Bose mounting accessories, including the UB-20 wall brackets, UFS-20 floor stands and UTS-20 table stands (Figure 35). Bose also offers cable adapters for use in running speaker cable through walls.

For further information or to order the mounting brackets, stands, or cable adapters, contact your Bose dealer or Bose Corporation directly. Refer to the address sheet included in the shipping carton.

Figure 35

Speaker accessories

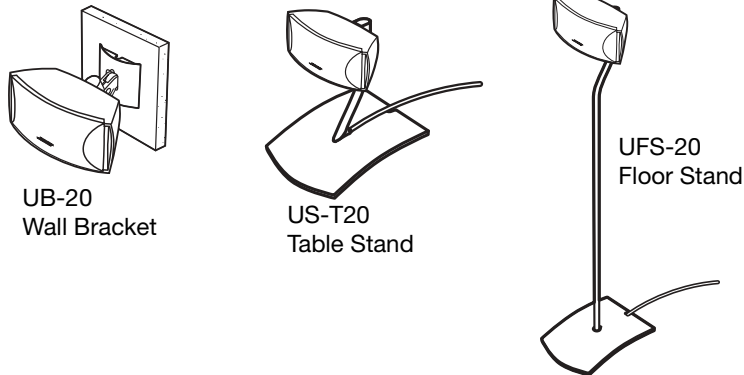

Troubleshooting table

Problem	What to do
System doesn't do anything	<ul style="list-style-type: none"> • Make sure the unit is turned on. Try pressing the remote On-Off button and the media center On-Off button. • Make sure the power cord is inserted securely into the Acoustimass® module and plugged firmly into an operating AC wall outlet. • Be sure to select a source (CD/DVD, AM/FM, etc.). • Unplug the Acoustimass module power cord from the outlet for one minute, then reconnect it. This allows the unit to reset itself. After reconnecting the power cord, wait for the message, "BOSE 3•2•1" to appear on the media center display.
Disc won't eject	<ul style="list-style-type: none"> • Turn off the unit. • Unplug the Acoustimass module power cord from the outlet for one minute, then reconnect it. This allows the unit to reset itself. • Before powering on, press and hold Eject on the media center.
No sound	<ul style="list-style-type: none"> • Increase the volume. • Check to see if MUTE is lit on the display. If it is, press the Mute button on the remote control to unmute the sound. • Make sure the Acoustimass module cable and speaker cable are firmly seated in their respective jacks and the multi-pin connector on the other end is firmly seated in the Acoustimass module jack. • Check speaker connections. • Turn the media center off for 10 seconds, then on again, to restore communication between the media center and the speakers. • Check the connections for any external audio devices. Be sure to select the correct source for the desired input. • Be sure the disc is placed correctly, label-side up, in the CD tray. • Connect the FM and AM antennas. • Unplug the Acoustimass module power cord from the outlet for a minute, then reconnect it. This allows the unit to reset itself. • If you are using an optical digital audio connection, make sure that the optical jack is correctly assigned in the System menu. • Make sure the volume is turned up on the TV. • Check input level settings for each connected device in the System menu.

Problem	What to do
Sound, but no picture	<ul style="list-style-type: none"> • Make sure the TV is on. • When playing a DVD or other video source, make sure the TV is set to the correct video input.
Remote control is inconsistent or does not work	<ul style="list-style-type: none"> • Check batteries and their polarity (+ and –). See “Replacing the remote control batteries” on page 53. • Point the remote control at the media center.
Radio does not work or has poor reception	<ul style="list-style-type: none"> • Make sure antennas are connected properly. • Move AM antenna at least 20 inches (50 cm) from the media center. • Adjust antenna position to improve reception. • AM antenna must be upright. • Move antennas farther from TV or other electronic equipment. • You may be in an area of weak signal coverage.
DVD or CD does not play	<ul style="list-style-type: none"> • Check to see if the Play symbol in the display is lit. • After pressing the CD/DVD button, wait a few seconds before pressing Play. • Make sure the disc is properly inserted (label-side up). • Eject the disc and try loading it again. • There may be dirt or dust on the disc. Clean the disc. See “Cleaning discs” on page 52. • The disc may be defective. Try another disc. • Make sure region codes for both the DVD and player match. See “Check for region code compatibility” page 5.
FM sound is distorted	<ul style="list-style-type: none"> • Adjust antenna position to reduce interference.
Sound is distorted	<ul style="list-style-type: none"> • Make sure speaker cables are not damaged and the connections are secure. • Reduce the output level from any external audio devices connected to the music center. • Reduce the input level setting for the connected device in the system menu.
Picture is black and white or rolling	<ul style="list-style-type: none"> • Check the video cable connections. • Check the Video Format setting and change to appropriate setting (NTSC or PAL). See “Video options” on page 47.
You forgot your password	<ul style="list-style-type: none"> • Enter the password 2673 to access the parental controls and create a new password.

Customer service

For additional help in solving problems, contact Bose® Customer Service. Refer to the address list included in the carton.

Power rating

USA/Canada: 120V ~ 50/60Hz 300W

International: 220-240V ~ 50/60Hz 300W

Dual voltage: 115/230V ~ 50/60Hz 300W

Audio inputs

AUX – Left, Right (analog); **D** (digital)

CBL-SAT – L, R (analog); **D** (digital)

TV – L, R (analog); **D** (digital)

Optical – SPDIF digital, mapped to input

Audio outputs

Acoustimass® Module – SPDIF

Video inputs

C (composite) – NTSC or PAL format

S-Video

Video outputs

C (composite) – NTSC or PAL format

S-Video

Component Y, Pb, Pr

Antennas

FM 75Ω – external FM antenna

AM – external AM antenna

Maximum ambient temperature

104°F (45°C)

Dimensions

Media center: 3¹/₄"H x 13³/₄"W x 10"D
(8.3 cm x 34.9 cm x 25.4 cm)

Remote control: 1¹/₈"H x 2¹/₂"W x 9"D
(3.0 cm x 6.5 cm x 22.9 cm)

3•2•1 speakers: 3¹/₂"H x 7⁷/₈"W x 5¹/₄"D
(8.7 cm x 19.9 cm x 13.6 cm)

3•2•1 GS speakers: 4"H x 5¹/₂"W x 2¹/₂"D
(10.5 cm x 14 cm x 6.4 cm)

Acoustimass module: 14¹/₂"H x 8³/₄"W x 19¹/₈"D
(36.7 cm x 22.2 cm x 48.5 cm)

Weights

Media center: 6.7 lb (3.0 kg)

3•2•1 speakers: 2.7 lb (1.2 kg) each

GS speakers: 1 lb (.45 kg) each

Acoustimass module: 23.3 lb (10.6 kg)

Finish

Media center: polymer

Speakers: polymer

Acoustimass module: polymer

Cable box device codes

ABC	0003, 0008, 0014, 0007, 0013, 0047, 0011, 0017, 0001	General Instrument	0476, 0810, 0276, 0003, 0014, 0015, 0011, 0098	Philips	0305, 0317, 0652, 0013, 0069, 0211, 0290, 0619, 0060, 0153, 0255, 0025, 0111, 0242
ADB	1063	GHZ	0078	Pioneer.....	0877, 1877, 0144, 0533, 1021
Ajinvision	1271	GMI.....	0057, 0015, 0797, 0069	Popular Mechanics.....	0400
Alcate	0896, 0897	Golden Channel.....	1063, 1110	Pulsar.....	0000
Allegro	0315, 0153	GoldStar	0144, 0040, 0838	PVP Stereo Visual Matrix.....	0003
Americast	0899	Goodmind.....	0797	Quasar	0000
Antronix	0022	Grundig.....	0529	RadioShack.....	0315, 0303, 0883, 0015, 0797
Anvision.....	0211, 0111	Hamlin.....	0009, 0273, 0259, 0034, 0020	Rampage	0255
Archer.....	0797, 0153, 0022	Hitachi.....	0014, 0011, 0255	RCA.....	0021, 0843
Belcor	0056	Hwalin.....	0303	Recoton	0400
Bell & Howell	0014	HyperVision	0619	Regal.....	0279, 0273, 0020, 0259
Bell South.....	0899	Hytex	0007	Regency.....	0002
Bestlink.....	0303	IEEC.....	1018	Rembrandt.....	0070, 0011
Birmingham Cable Communications.....	0276	Jasco	0015, 0315, 0153	Runco.....	0000
British Telecom.....	0003, 0105	Jebsee	0400	Sagem.....	0817
Cable & Wireless	1068	Jerrold.....	0476, 0810, 0276, 0003, 0012, 0014, 0098, 0047, 0011, 0015	Samsung.....	0000, 0144, 0702, 0070, 0840, 0040
Cable Star	0056	Leon.....	0069, 0015	Scientific Atlanta	0877, 1877, 0477, 0008, 0006, 0277, 0017
Cabletenna	0022	LG.....	0144, 0040, 0838, 0779	Seawoo	0073, 0780
Cabletime	0448, 0377, 0271, 0665	Magnavox.....	0069	Sharp	0313
Cableview.....	0022	Memorex.....	0000	Signal.....	0015, 0040
Century.....	0153	MNET.....	0443, 0019	Signature.....	0011
Citizen	0315, 0153	Motorola	0476, 0810, 0276, 1254, 1106	SL Marx.....	0040
Colour Voice.....	0025	Movie Time	0063, 0078	Sony.....	1006
Comtec.....	0274	Mr. Zap	1112	Sprucer	0021
Comtronics.....	0060, 0040	MS	0015, 1018, 0303, 0069	Starcom	0003, 0014, 0098, 0047, 0015
Contec.....	0019	NET.....	0274	Stargate	0797, 0040, 0015
Cryptovision	0600	Noos	0817	Starquest	0015
Daehan.....	0778	Now	0776	Storm	1018
Daeryung.....	0877, 1877, 0477, 0008, 0277	NSC	0063, 0070	Supercable.....	0276
Decsat	0423	NTL.....	1068	Sylvania.....	0001
Director.....	0476	Oak	0007, 0248, 0019	Tadiran	0040
Eastern	0418, 0274, 0002	Ono.....	1068	Tae Kwang	0068
Electricord	0078	Optimus.....	0021	Taepyung	0678
Emerson.....	0797	Pace.....	0237, 1060, 1068	Taihan.....	0778
Everquest	0015, 0040	Pacific.....	0678	Tandy	0258
Filmnet.....	0443	Pacific Bell.....	0843	Teac.....	1018
Focus.....	0400	Panasonic.....	0000, 0008, 0107, 0040, 0021	Tele+1.....	0443
France Telecom.....	0897, 0896, 0451	Paragon	0000	Television	0040
Funai.....	0019, 0248			Telewest.....	1068
Garrard.....	0153				
GC Electronics	0056				
Gemini	0070, 0057, 0797, 0015, 0242				

Cable box device codes

Texscan	0001	TS	0003, 0303, 0255, 1018	Videoway	0250
Thomson	1110	Tudi	0286	Viewmaster	0883
Timeless	0040, 0418, 0274	Tusa	0015	Viewstar	0111, 0063, 0258, 0060, 0211
Tocom.....	0012, 0013	TV86	0063	Visionetics.....	1064
TongKook	0840, 0777	UBS	0073	Westminster	0105, 0716
TopStone	1355	Unika.....	0153, 0022	Wiso	0078
Torx.....	0003	United Artists.....	0007	Zenith.....	0000, 0525, 0899
Toshiba	0000	United Cable.....	0003	Zentek.....	0400
Trans PX	0276, 0153, 0315, 0303	Universal.....	0022, 0153, 0078, 0056, 0191		

Satellite box device codes

ABsat.....	0832, 0123	Canal Satellite.....	0853	Echostar.....	2005, 1005, 2003, 0775, 1169, 0280, 0453, 0610, 0853, 1086, 0167, 0396, 0511, 1170, 0312, 2011, 0454, 0713, 0871
Akai	0515	Canal+	0853	EIF	0674, 0417
Alba	0455, 0421, 0613, 0515	Chaparral	0216, 0053	Elta	0364
Aldes	0288	CityCom.....	1176, 0818, 0115	Emanon.....	0421
AlphaStar.....	0772	Clark	0811	Engel	0450, 1017
Amstrad.....	0847, 0338, 0501, 0811, 0252, 0461, 0689, 1113, 0345, 0675	CNT	0520	Eurodec.....	0526
Ankaro	0288, 0713, 0220, 0519, 0369, 1094	Commlink	0288	Eurostar.....	0679, 1026, 1025
Anttron.....	0421, 0183	Connexions.....	0396	Expressvu	2003, 0775
Arcon.....	1043, 0834, 0368, 1205	Conrad.....	0607, 0115, 0809	Ferguson.....	0336, 0183, 0067, 0711
Armstrong.....	0243	Crossdigital.....	1109	Fidelity.....	0675, 0252, 0811
AST.....	0351, 0321	Crown	0243	Finlux	0397, 0108, 0455, 0414
Aston.....	1129, 0142	D-box.....	1127, 0873, 0723	Force NO AS.....	1101
Astra	0108	Dae Young	0735	Foxtel	0879
Astro	0501, 0358, 0548, 0173, 0520	Daeryung	0396	Fracarro.....	0871
Audioton.....	0364	Digenius.....	0299	Freecom.....	0421, 0335
Avalon.....	0396	DirecTV	2001, 0392, 0566, 2002, 0639, 1142, 0247, 0749, 1749, 0724, 0819, 1856, 1076, 1109, 0099	Fresat	0885
Axis.....	0530, 0369, 0834	Dish Network System.....	1005, 2005, 0775, 2003, 1170, 2011	FTE	0811, 0331, 0863
Best	0369	Dishpro	1005, 2005, 0775, 2003	Fuba.....	0369, 0417, 0172, 0414, 0396, 0421
Blaupunkt	0173	Distratel	0084, 0885	Funai	0338
Boca	0243, 0829, 0513	DMT	1075	G-Sat	0183
Brain Wave	0332	DNT.....	0396	Galaxis	0656, 0834, 1111, 0364, 0833, 1101, 0288, 0813, 0863, 0283
British Sky Broadcasting	1175, 0847	DX Antenna.....	0752	Galaxisat	0321
BT	0515, 0710, 0668	Dynasat.....	0679	Gardiner	0818
Bush	0067, 0522				
Cambridge.....	0515				
Canal Digital	0853				

Satellite box device codes

GE	0566	JVC	2003, 0775, 0571, 0492, 0515, 1170, 0506, 2011, 0505	Next Level	0869
General Instrument.....	0869	Kabil.....	0737	NextWave.....	0732
GOI	2003, 0775	Kathrein	0658, 0092, 0249, 0442, 0622, 1224, 0173, 0358, 0553, 1057, 0123, 0331, 0480	Nikko	0713
Gold Box	0853	KeyWest.....	0794	Nokia.....	0397, 0723, 1023, 0172, 0573, 0873, 0108, 0455, 0751, 1127
GoldStar	0335	Kosmos.....	0335, 0331	Now.....	0757
Gooding.....	0571	Kreiselmeier	0173	Oceanic.....	0586
Goodmans.....	1246	Kuang Yu	0635	OctalTV	2005, 1005
Gradiente	2004, 0887	Kyostar	0421	Orbit	1022
Grothusen.....	0335	L&S Electronic	1043	Orbitech	0501, 1100
Grundig	0173, 0805, 0140, 0750, 1150, 0139, 0571, 0847	LaSAT	0607, 0520, 0513	Origo	0498
HDT	1011, 1159	Lenco.....	0450, 0421, 0335	Orion	0522
Hinari	0183	Lennox.....	0592	Pace.....	1175, 0241, 0497, 0795, 0887, 0183, 0455, 0791, 0867, 2004, 0067, 0336, 0720, 0847
Hirschmann	0396, 0495, 0573, 0173, 0398, 0502, 1085, 0397, 0501, 0882	LG	1226, 0461, 0335	Palladium	0571
Hitachi	0819, 0455, 0491, 0489, 1250	Lifesat	1122	Palsat	0501
Homecable	0238	Logix.....	1017	Panarex.....	1159
Houston.....	0668	Lorenzen.....	0299	Panasat.....	0879, 0615
HTS	0775, 2003	Lupus.....	0369	Panasonic	0247, 0701, 0500, 0847, 0340, 0739, 1104
Hughes Network Systems.....	1142, 0749, 1749	Luxor.....	0172, 0108, 0573	Panda.....	0455
Humax.....	0863, 0283, 1176, 1048	Macab.....	0586, 0179	Pansat.....	1159
Hung Chang	0732	Magnavox.....	0724, 0722	Pantech.....	0747
Huth.....	0388, 0794, 0288, 0368, 0589, 0243, 0364, 0517, 0220, 0346	Manhattan.....	0520, 1017, 0455, 0765, 0592, 1083	Paysat	0724
Hwalin.....	0885	Maspro.....	0336, 0092, 0750, 0495	Philips	1142, 0749, 1749, 0724, 1076, 0722, 0099, 0133, 0571, 0853, 1118, 0455, 0710, 0805, 0292, 0667, 0750, 0898
Hyundai	1011, 0758, 1159	Matsui	0571	Phonotrend	0592, 0288, 1124
IEEC	0605	Matsushita	0500, 0340	Pioneer.....	0352, 0329, 0853, 0662
Ikusi Allsat	0368	Mediamarkt.....	0243	Pixx	0552
Indovision	2004, 0887	MediaSat	0853	Plasmatic	0442
Innova.....	0099	Memorex.....	0724	Praxis	1123
Intertronic	0631	Metronic.....	0713, 0084, 1215	Preisner.....	0132, 0513
Intervision	0592	Micronik	1003	Promax.....	0455
InVideo	0871	Minerva.....	0571	Prosat.....	0288
IQ.....	0210	Mitsubishi	0749, 0491	Proscan	0392, 2001, 0566
IQ Prism.....	0210	Morgan's.....	0132, 0683, 0513, 1103, 0243, 0829	ProVision.....	0118
IRTE.....	0816, 0609	Motorola	0869	Pyxis	0831
ISkyB	2004, 0887	Multichoice	0879, 0642	Quadral	0628, 0519
ITT	0108, 0172	Multistar.....	0331	RadioShack.....	0869
JiWon.....	0364	Muratto	0335	Radix.....	0882, 0396, 1255, 1113
Johansson.....	0332	Navex.....	0332		
JOK	0710	NEC	0499, 1270, 0496, 0508, 0507		
JSR.....	0364	Netsat	0099, 2004, 0887		
		Neuhaus	0501, 0220		
		Neusat	0692, 0834		

Satellite box device codes

RCA.....	2001, 0392, 0566, 0855, 0143	Skymaster.....	0628, 1062, 0240, 0605, 0880, 0519, 0713, 0288	Thorens.....	0586
Realistic.....	0052	SM Electronic.....	0713, 0240, 0157, 1200	Tonna.....	0668, 0346
RFT.....	0288, 0220	Smallear.....	1103	Topfield.....	1206
Saba.....	0690, 0520, 0885, 0336, 0710	Smart.....	0132	Toshiba.....	0749, 1749, 0790, 0486, 1285, 0082
Sabre.....	0455	Sony.....	2002, 0639, 1639, 0294, 0847, 0278, 0661	TPS.....	1253, 0820
Sagem.....	1253, 1114, 0820	Star.....	2004, 0887	Triad.....	0351, 0335, 0321
Salora.....	0172, 0108	Star Choice.....	0869	Triasat.....	0501, 0414
Samsung.....	1276, 1109, 1017, 0773, 1243	Star Trak.....	0421	Triax.....	0115
Sanyo.....	1219, 0493	Starland.....	1122	Twiner.....	0136
SAT.....	0321, 0461, 0351	Strong.....	0125, 0421, 1105, 0354, 1088, 0132, 0879, 1159	UltimateTV.....	2001, 0392, 0639, 2002
Satcom.....	0346, 0605	STS.....	0210	Uniden.....	0724, 0722, 0074, 0052, 0238, 0831
Satec.....	0183	STVI.....	0417	Unitor.....	0332
Satmaster.....	0346	Sunstar.....	0513, 0794	Universum.....	0173, 0571
SatPartner.....	0502, 0811, 0421, 0692, 0335, 0520, 0332	Supernova.....	2004, 0887	Victor.....	0506, 0505, 0492
Satplus.....	1009	Tada.....	0368	Visiosat.....	1042
Satstation.....	1083	Tae Kwang.....	0733	Vortec.....	0631, 0421
Schneider.....	0805	Tantec.....	0336, 0455	VTech.....	0690, 0351, 0321
Schwaiger.....	0552, 0183, 0116, 1111	Techniland.....	0346	Winersat.....	1045, 0332
Seemann.....	0530, 0396	TechniSat.....	0005, 1099, 0548, 1195, 0501, 1100	Wisi.....	0638, 0173, 0372, 0455, 0351, 0406, 0690, 0321, 0396
SEG.....	1087, 0742, 0421, 0369	Telefunken.....	0421	Xsat.....	0123
Sharp.....	0494	Teleka.....	0243, 0613	Yes.....	0887, 2004
Siemens.....	0683, 0173	Telesat.....	0605	Zehnder.....	0321, 0552, 0114, 0520, 1075, 0331, 0818
SKY.....	0856, 0099, 2004, 0847, 1175, 0887	Telestari.....	0114, 1100, 0501, 0157	Zenith.....	0856, 1856, 0635
Sky Television.....	1014	Televisa.....	2004, 0887	Zodiac.....	0396
Skylife.....	1255	Thomson.....	0455, 1012, 0853, 0711, 1046	Zwergnase.....	0794

TV device codes

A-Mark.....	0003	Aiwa.....	1914, 1910, 1916, 0701, 1915	Alba.....	0668, 0036, 0218, 0581, 0009, 0211, 0371, 0037, 0235
Abex.....	0032	Akai.....	1537, 0009, 0351, 0516, 0708, 0218, 0448, 0696, 0208, 0361, 0602	Albatron.....	0700
Acura.....	0009	Akito.....	0272	Allorgan.....	0294
Addison.....	0653, 0108	Akura.....	0264, 0218, 0493, 0358	Ambassador.....	0177
Admiral.....	0093, 0087, 0163	Alaron.....	0179, 0216	Amplivision.....	0400, 0217
Advent.....	0783, 1933, 0817, 0815			Amstrad.....	0171, 0009, 0177, 0412, 0371, 0516, 0037, 0354, 0433
Adventura.....	0046				
Adyson.....	0217, 0032				
AGB.....	0516				

TV device codes

Anam.....	0250, 0009, 0700, 0003, 0628	Bush.....	0036, 0698, 0218, 0294, 0363, 0519, 0009, 0668, 0211, 1900, 0282, 0355, 0374, 0581, 0037, 1037, 0272, 0349, 0371, 0552	Dansai.....	0037
Anam National.....	0250, 0650, 0055	Carrefour.....	0036	Dayton.....	0009
Anitech.....	0009	Carver.....	0170	Daytron.....	0019
AOC.....	0451, 0093, 0178, 0179, 0009, 0052, 0003, 0019, 0108, 0185, 0018	Cascade.....	0009	De Graaf.....	0208, 0548, 0363, 0227
Apex Digital.....	1943	Cathay.....	0037	Decca.....	0249, 0244, 0516, 0072, 0272, 0037
Arcam.....	0217, 0216	CCE.....	0217, 0037	Denon.....	0145
Archer.....	0003	Celebrity.....	0000	Digatron.....	0037
ASA.....	0104, 0087	Centurion.....	0037	Dixi.....	0037, 0009
Asuka.....	0218	Century.....	0087	Dual.....	0544, 0519, 0336
Atlantic.....	0206	CGE.....	0084, 0552, 0074, 0306, 0247	Dual Tec.....	0217
Audiosonic.....	0109, 0037	Ching Tai.....	0179, 0009, 0003	Dumont.....	0070, 0019, 0087
Audiovox.....	0451, 0003	Chun Yun.....	0000, 0009, 0700, 0003, 0179, 0033	ECE.....	0037
Autovox.....	0206, 0087, 0544, 0336	Chung Hsin.....	0053, 0108, 0036, 0033	Elbe.....	0259
Awa.....	0009, 0157	Cimline.....	0009	Electroband.....	0000, 0185
Axion.....	1937	Cineral.....	0451	Electrohome.....	0381
Baird.....	0343	Citizen.....	0039, 0186, 0056, 1928, 0046, 0280	Elin.....	0037, 0548
Bang & Olufsen.....	0565, 0087	Clairtone.....	0185	Elite.....	0320, 0218
Barco.....	0380, 0552	Clarivox.....	0037	Elta.....	0009
Basic Line.....	0218, 0009	Clatronic.....	0370, 0247	Emerson.....	0178, 0171, 0185, 0361, 1911, 0038, 1944, 0179, 0282, 1909, 0019, 1929, 0087, 0280, 1905, 1928, 0039, 0177
Baur.....	0361, 0535, 0349, 0512, 0554, 0037, 0505, 0544, 0010	Clayton.....	0385	Erres.....	0037, 0012
Beaumarck.....	0178	Colt.....	1906	Ether.....	0003, 0009
Beko.....	0714, 0486, 0370, 0715	Concerto.....	0056	Etron.....	0009
Belcor.....	0019	Condor.....	0320, 0370	Europhon.....	0516
Bell & Howell.....	0016	Contec.....	0036, 0216, 0009, 0185, 0157	Expert.....	0206
Beon.....	0037	Continental Edison.....	0205, 0198, 0196, 0399	Ferguson.....	0109, 0238, 0343, 0073, 0193, 0335, 0037, 0190, 0324, 0560
Binatone.....	0217	Crosley.....	0084, 0074, 0087	Fidelity.....	0544, 0216, 0432, 0193, 0363, 0361
Blaupunkt.....	0195, 0328, 0191, 0327, 0554, 0200, 0535	Crown.....	0039, 0579, 0037, 0418, 0009, 0370	Finlandia.....	0359, 0346, 0208, 0363
Blue Sky.....	0218, 1037, 0668	CS Electronics.....	0414, 0216	Finlux.....	0070, 0104, 0346, 0037, 0087, 0179, 0516, 0072, 0105, 0411
Blue Star.....	0282	CTC.....	0247	Firststar.....	0033, 0009
Bondstec.....	0247	Curtis Mathes.....	0451, 0093, 0145, 0166, 0056, 1919, 0039, 0466, 0016	Firstline.....	0217, 0321, 0216, 0294, 0009, 0247, 0668
Boots.....	0217	Cybertron.....	0218	Fisher.....	0159, 0303, 0555, 0104, 0217, 0544, 0208, 0370
BPL.....	0282	Daewoo.....	0451, 0178, 0700, 0019, 1921, 0039, 0170, 0634, 0009, 1909, 0037, 0108, 0374, 0628, 0003, 1902, 0032, 1928, 0056, 0499	Flint.....	0455
Brandt.....	0205, 0198, 0196, 0335, 0109	Dainichi.....	0218	Forgestone.....	0193
Brionvega.....	0559, 0087			Formenti.....	0087, 0037, 0552, 0320
Britannia.....	0216			Fortress.....	0093
Brockwood.....	0019				
Broksonic.....	0003, 1929, 1911, 1938, 1905, 1935				
Bruns.....	0087				
BSR.....	0294				
BTC.....	0218				

TV device codes

Frontech	0264, 0448, 0247, 0414, 0163, 0363	Hisawa	0400, 0282, 0455	Kendo	0235, 0037
Fujitsu	0206, 0186, 0179, 0683, 0072	Hinari	1908	Kennedy.....	0552
Funai.....	0171, 0179, 0303, 0294, 0264, 1904	Hitachi.....	0178, 0145, 0019, 0563, 0036, 0196, 0730, 0043, 0225, 1904, 0105, 0349, 0151, 0381, 0016, 0165, 0548, 0032, 0186, 0719, 0039, 0217, 1225, 0056, 0306, 0363, 0009, 0163, 0481, 0027, 0179, 0578, 0038, 0198, 1037, 0044, 0227, 0109, 0356, 0157, 0441	Kenwood.....	0019
GBC.....	0552			Kingsley	0216
GE	0451, 0178, 0560, 1919, 0021, 0135, 1917, 0055, 0282, 1907, 1922, 0027			Kioto.....	0706
GEC	0043, 0217, 0037, 0205, 0072, 0516			Kloss	0046, 0024
Geloso	0009	Hua Tun	0009	Kneissel.....	0435, 0259
General.....	0186, 0590	Huanyu	0374, 0216	Kolin	0053, 0033, 0108, 0036
Genexxa	0218, 0163	Hypson	0282, 0264, 0037	Konka.....	0703, 1940, 0638, 1939, 0632, 0707, 0628
Gibraltar.....	0019	ICE	0371, 0264, 0217	Korpel	0037
Gintai	0354	ICeS	0218	Korting	0087
GoldStar	0178, 0019, 0039, 0363, 0001, 0037, 0109, 0290, 1926, 0032, 0056, 0217, 0377	Imperial	0247, 0552, 0084, 0418, 0074, 0370, 0630	Koyoda.....	0009
Goodmans.....	0037, 0217, 0371, 0634, 0036, 0179, 0343, 0499, 1909, 0072, 0235, 0374, 1900	Indiana	0037	KTV	0217, 0185, 0039, 0280
Gorenje.....	0370	Ingelen	0163	Lenco	0585
GPM	0218	Inno Hit	0516, 0072	Leyco	0037, 0294, 0264, 0072
Gradiente.....	0053, 0170, 0056	Innova	0037	LG	0178, 0001, 0032, 0056, 0644, 1934, 0019, 0038, 0714, 0003, 0037, 0108, 0700
Graetz.....	0361, 0163	Interfunk.....	0361, 0247, 0163, 0512, 0037	Liesenk & Tter	0037
Granada.....	0037, 0146, 0217, 0359, 0072, 0208, 0351, 0516, 0045, 0201, 0339, 0363	Intervision	0102, 0377, 0037, 0264, 0217	Lloyd's.....	1904
Grandin.....	0610, 0282	IR	0074	Lloytron	0032
Grundig	0706, 0191, 0487, 0556, 1935, 0070, 0205, 0554, 0037, 0195, 0535, 0587	IRT	0628	Loewe	0087, 0512
Grunpy.....	0179	Isukai	0218	Logik	0016, 0001
Haier	0768	ITC	0552	Luma	0363, 0206
Hallmark	0178	ITS	0371	Luxman	0056
Hanimex	1908	ITT.....	0548, 0163, 0544, 0361, 0351	Luxor	0356, 0349, 0363, 0194, 0361
Hankook	0178, 0019, 0628, 0056	Janeil	0046	LXI.....	0178
Hanseatic	0361, 0556, 0320, 0544, 0037, 0428	JCB.....	0000	M Electronic.....	0104, 0163, 0374, 0057, 0109, 0346, 0037, 0105, 0217, 0480, 0009
Hantarex.....	0516	Jean	0003, 0179, 0009	Magnadyne	0102, 0544, 0087, 0516, 0247
Harley Davidson	1904, 0179, 0043	Jensen	0815, 1933, 0817	Magnafon	0516, 0102
Havermy	0093	JVC	0053, 0653, 0036, 0190, 0606, 1923, 0094, 0371, 0683, 0192	Magnasonic	1928, 1913
HCM	0282, 0009, 0412	Kaisui	0009, 0218, 0217, 0216, 0282	Magnavox	0706, 0036, 0186, 1931, 0024, 0179, 0386, 1913, 0020, 0096, 0187, 1904
Hello Kitty.....	0451	Kamp	0216	Magnin	1907
Hinari	0009, 0179, 0037, 0036, 0218	Kapsch.....	0163, 0206	Magnum.....	0648
		Karcher	0610	Majestic.....	0016
		Kathrein	0556	Manesth	0217, 0320, 0264, 0235
		Kawasho.....	0216	Marantz	0556, 0037, 0854
		Kaypani.....	0052	Marelli	0087

TV device codes

Mark	0037	Newave.....	0093, 0178, 0009	Philco	0178, 0145, 0084, 0247, 1911, 0032, 0074, 0096, 0186, 0628, 0020, 0056, 0087, 0552, 0019, 0037
Matsui.....	0211, 0272, 0355, 0011, 0443, 0037, 0544, 0208, 0235, 0354, 0009, 0371, 0036, 0516, 0177, 0217, 0294, 0363, 0035, 0487, 0072, 0579	Nicam	0544	Philex	0351
Matsushita.....	0250, 0650	Nicamagic.....	0216	Philips	0000, 0178, 0024, 0043, 0108, 0187, 0012, 0554, 0020, 0037, 0087, 0186, 0374, 0019, 0032, 0056, 0193, 0013, 0556
McMichael.....	0043	Nikkai.....	0032, 0072, 0264, 0037, 0218, 0035, 0216, 0337	Phoenix	0087
Mediator	0037, 0012	Nikko.....	0178	Phonola.....	0013, 0012, 0087, 0037
Medion	0668, 1037	Noblisko	0102	Pilot.....	0019, 0039
Megatron	0178, 0145, 0003	Nokia	1912, 0480, 0631, 0473, 0606, 0361, 0548	Pioneer.....	0166, 0109, 0423, 0038, 0163
MEI	0185	Nordmende.....	0198, 0196, 0560, 0109, 0343	Polytron.....	0697
Memorex	0250, 0178, 1920, 1927, 0009, 0179, 1911, 1926, 1037, 1924, 0016	Noshi	0018	Portland	0039, 0019
Memphis.....	0337	Oceanic	0567, 0361, 0163	Prandoni-Prince.....	0516
Mercury	0001	Onking	0280	Prima.....	0817, 0815, 0783, 1933
Metz	0087, 0388, 0367, 0535, 0275, 0447	Onwa	0433	Princeton.....	0700
MGA	0178, 0019, 1907	Optimus	0250, 0166, 1924, 1913, 0650, 1927	Profex.....	0009, 0363, 0361
Midland	0039, 0032, 0135	Optonica.....	0093, 0165	Proline.....	0321
Minerva.....	0487, 0070, 0554, 0535	Orion.....	1905, 0179, 0320, 0443, 0655, 1929, 0177, 0294, 0355, 0544, 1911, 0037, 0235, 0321, 0516	Proscan.....	1922
Minoka.....	0412	Osaki.....	0032, 0218, 0493, 0217, 0412, 0072, 0264	Protech	0552, 0037, 0247, 0418, 0009, 0217, 0337, 0668, 0102, 0264
Minutz.....	0021	Oso	0218	Proton	0178, 0003, 0052, 0644, 0001, 0039, 0466, 0009
Mirror.....	1900	Osume	0072, 0032, 0157	Pulsar	0019
Mitsubishi	0250, 0093, 0178, 0381, 0019, 1917, 0056, 0108, 0201, 0358, 0535, 0036, 0179, 0354, 0512, 0033, 0087	Otto Versand.....	0037, 0320, 0505, 0552, 0036, 0217, 0349, 0535, 0556, 0010, 0191, 0343, 0512, 0554	Pye.....	0037, 0012
Mivar.....	0291, 0609, 0290, 0516, 0216, 0292	Palladium	0363, 0418, 0370	Quasar	0250, 0650, 1924, 0165, 1919, 0055
Monivision	0700	Panama.....	0264, 0217	Quelle.....	0512, 0010, 0552, 0070, 0104, 0327, 0505, 0544, 0037, 0084, 0306, 0361, 0535, 0011, 0554, 0074, 0200, 0328
Motorola	0093, 0055	Panasonic	0250, 1930, 0126, 1947, 0226, 0340, 1650, 1927, 0055, 1946, 0214, 0274, 0650, 1924, 0037, 1941, 0163, 0367, 1919	Questa	0036
MTC.....	0019, 0216, 0185, 0512, 0056, 0349	Pathe Cinema	0320, 0238, 0216, 0552	R-Line	0037
Multitech.....	0009, 0217, 0216, 0102, 0363	Pathe Marconi	0198, 0196, 0205	Radiola.....	0037, 0012
Myryad	0556	Pausa.....	0009	Radiomarelli	0087, 0516
NAD	0178, 0361	Penney.....	0178, 0027, 0135, 1919, 0003, 0021, 0039, 1907, 0019, 0032, 1926, 0018	RadioShack.....	0178, 0032, 0165, 1920, 0019, 0056, 1904, 0039
National	0226	Perdio	0320	Rank Arena	0036
NEC	0178, 0019, 0056, 0455, 0009, 0046, 0170, 0381, 0036, 0165, 0186, 0704	Phase.....	0032	RBM.....	0070
Neckermann	0191, 0505, 0087, 0363, 0556, 0037, 0349, 0554				
NEI.....	0037, 0337				
Nesco	0414, 0179				
Netsat	0037				

TV device codes

RCA.....	0000, 0178, 0018, 0135, 1917, 1948, 0038, 1907, 1922, 0019, 1919	Scott.....	0178, 0019, 0179	Sunkai.....	0355, 0321, 0294
Realistic.....	0178, 0019, 0056, 0039, 0032, 0165	Sears.....	0178, 0171, 0159, 0179, 0146, 1926, 0056, 1904	SuperTech.....	0216
Rediffusion.....	0201, 0361, 0351	SEG.....	0036, 0552, 0264, 0217, 0668	Supra.....	0056
Reoc.....	0714	SEI.....	0516, 0087, 0294, 0010, 0177, 0544, 0102	Supre-Macy.....	0046
Revox.....	0037	Seleco.....	0206, 0163, 0411, 0259	Supreme.....	0000
Rex.....	0206, 0163, 0264, 0259	Sentra.....	0035	Susumu.....	0218
RFT.....	0428, 0087	Sharp.....	0093, 1093, 0039, 0165, 0650, 1917, 0036, 0157, 0386, 1193, 0032, 0256	Sylvania.....	0171, 0020, 0381, 1944, 0096, 1931
Rhapsody.....	0216, 0185	Shen Ying.....	0003, 0179, 0009	Symphonic.....	0171, 1904, 1913
Roadstar.....	0009, 0418, 0264, 0218	Sheng Chia.....	0093, 0009, 0179, 0033	Synco.....	0000, 0451, 0093, 0178, 0036
Rowa.....	0712, 0698	Shogun.....	0019	Sysline.....	0037
Saba.....	0343, 0087, 0196, 0335, 0163, 0205, 0109, 0198	Shorai.....	0294	T + A.....	0447
Saccs.....	0238	Siarem.....	0087, 0516, 0102	Tacico.....	0178, 0009, 0179
Sagem.....	0610	Siemens.....	0157, 0200, 0535, 0037, 0195, 0328, 0191, 0327, 0554	Tai Yi.....	0009
Saisho.....	0009, 0177, 0264, 0544, 0033, 0235, 0516, 0011, 0211, 0354	Signature.....	0016	Tandy.....	0093, 0163, 0414, 0218, 0072, 0217, 0039
Salora.....	0356, 0363, 0349, 0361, 0194, 0359, 0548, 0163	Silver.....	0036	Tashiko.....	0043, 0363, 0036, 0359, 0033, 0217, 0650
Sambers.....	0516, 0102	Simpson.....	0187, 0186	Tatung.....	0072, 0249, 0009, 0055, 0244, 0003, 0037, 0217, 0516, 0036
Sampo.....	0093, 0178, 0171, 0700, 0036, 0650, 0032, 0052, 0009, 0039	Singer.....	0087	Teac.....	0706, 0712, 1904, 0037, 1932, 0412, 0544, 1437, 0009, 1913, 0282, 0455, 0698, 1037, 1909, 0264, 1949, 0418, 0668
Samsung.....	0178, 0644, 0032, 0056, 0217, 0370, 0618, 0019, 0039, 0179, 0290, 0587, 0009, 1903, 0037, 0264, 0556	Sinudyne.....	0177, 0516, 0102, 0294, 0087, 0235, 0544, 0010	Tec.....	0247, 0217, 0552
Samsux.....	0039	Skantic.....	0356	Technema.....	0320
Sandra.....	0216	SKY.....	0037	Technics.....	0250, 0650
Sansei.....	0451	Skysonic.....	0696	Technol Ace.....	0179
Sansui.....	0706, 1929, 0655, 1911, 1904	Skyworth.....	0037	Techwood.....	0056, 0003
Sanyo.....	0157, 0280, 1907, 0045, 0146, 0208, 0381, 0036, 0104, 0159, 0339, 0011, 0072	Solavox.....	0032, 0351, 0163	Teco.....	0093, 0178, 0264, 0036, 0218, 0653, 0009, 0280
SBR.....	0037, 0013, 0193, 0012, 0043	Sonitron.....	0208	Teknika.....	0016, 0056, 0039, 0186, 0019, 0179
Schaub Lorenz.....	0361	Sonoko.....	0037, 0009	Teleavia.....	0343, 0205
Schneider.....	0218, 0336, 0544, 0057, 0303, 0394, 1137, 0037, 0247, 0371, 0668, 0013	Sonolor.....	0208, 0163	Telefunken.....	0084, 0262, 0343, 0625, 0074, 0109, 0335, 0498, 0056, 0101, 0306, 0471
Scimitsu.....	0019	Sontec.....	0037	Telemeister.....	0320
Scotch.....	0178	Sony.....	0000, 0010, 0080, 0650, 1505, 1925, 0036, 0505, 1010, 1904, 0011, 0111, 0651, 1651	Teletech.....	0009
		Soundesign.....	0178, 0186, 0179	Teleton.....	0186, 0349, 0036, 0217, 0206, 0363
		Soundwave.....	0037, 0418	Tensai.....	0294, 0218, 0320
		Sowa.....	0178, 0036, 0226	Tera.....	0466
		Spectricon.....	0003	Texet.....	0216, 0218
		Squareview.....	0171	Thomas.....	1904
		SSS.....	0019		
		Standard.....	0217, 0009, 0218		
		Stern.....	0259, 0206, 0163		

TV device codes

Thomson	0343, 0560, 0109, 0205, 0399, 0198, 0349, 0625, 0196	Triumph.....	0516, 0243, 0177	Visorex	0432
Thorn.....	0499, 0535, 0037, 0084, 0192, 0361, 0512, 0035, 0074, 0190, 0343, 0505, 0072, 0104, 0193	Tuntex	0009	Voxson	0087, 0163
Thorn-Ferguson.....	0343	Uher	0303, 0206, 0320	Waltham.....	0356, 0217
TMK.....	0178, 0177, 0056	Ultra	0192	Wards.....	0178, 0165, 0020, 0056, 0111, 0179, 0019, 0027, 0096, 0016, 0021, 0080
Tomashi	0282	Ultravox	0102, 0351	Watson.....	0037, 0320
Toshiba.....	0644, 1508, 1936, 0035, 0243, 0618, 0718, 1935, 0070, 0508, 0650, 1918, 1945, 0036, 0381	Universal.....	0027	Watt Radio	0544, 0102, 0552
Tosonic	0185	Universum.....	0421, 0552, 0037, 0105, 0370, 0535, 0104, 0346, 0492, 1901, 0074, 0264	Wega.....	0087, 0036
Totevision	0039	Vestel	0037	White Westinghouse	0216, 0186, 1909, 0037, 0320
Towada.....	0552	Victor	0250, 0053, 0036, 0650, 0653	Yamaha	0019
Transonic.....	0712, 0698	Videosat.....	0247	Yapshe	0250
Trical.....	0157	Videotechnic.....	0217	Yoko	0264, 0217, 0037
		Vidtech.....	0178, 0036, 0019	Zanussi	0363, 0206
		Viking	0046	Zenith.....	0178, 0016, 1909, 1904, 1929, 1911
		Vision	0320	Zonda.....	0003

VCR device codes

ABS	1972	Basic Line.....	0072, 0278, 0020	Crown	0072, 0278, 0020
Admiral	0048, 0209	Beaumarck	0240	Curtis Mathes.....	0060, 0035, 0162, 0041, 1035
Adventura.....	0000	Bell & Howell.....	0104	Cybernex	0240
Aiko	0278	Blaupunkt	0162, 0227, 0034, 0226, 0195	CyberPower	1972
Aiwa.....	0037, 0000, 0352, 0348, 0687, 0307, 0479	Brandt.....	0493, 0321, 0320	Cyrus.....	0081
Akai	0041, 0315, 0106	Brandt Electronic.....	0041	Daewoo.....	0045, 0104, 0278, 0642, 0637, 0020, 1278
Akiba	0072	Broksonic.....	0184, 0121, 0209, 0002, 0479, 0348, 1479	Dansai.....	0072
Alba	0209, 0072, 0278, 0352, 0315, 0293, 0020	Bush	0209, 0072, 0278, 0352, 0293	Daytron	0020
Alienware.....	1972	Calix.....	0037	De Graaf.....	0042, 0166
Ambassador.....	0020	Canon	0035	Decca.....	0081, 0000
America Action.....	0278	Capehart.....	0020	Denon	0042
American High.....	0035	Carver	0081	Dual.....	0041
Amstrad.....	0000	Catron.....	0020	Dumont	0081, 0000, 0104
Anam	0162, 0037, 0240, 0278, 0226	CCE	0072, 0278	Dynatech.....	0000
Anam National.....	0162, 0454, 0226, 1562	CGE	0000	Elbe.....	0038
Anitech	0072	Cimline.....	0072	Elcatech	0072
ASA	0037, 0081	Cineral	0278	Electrohome.....	0037
Asha	0240	Citizen.....	0037, 0278, 1278	Electrophonic.....	0037
Asuka	0037	Clatronic	0020	Emerex.....	0032
Audiovox	0037, 0278	Colt	0072	Emerson.....	0035, 0037, 0184, 0240, 0045, 0000, 0121, 0043, 0209, 0002, 0278, 1278, 0637, 0479, 1479
Baird.....	0000, 0104, 0041	Combitech.....	0352	ESC.....	0240, 0278
Bang & Olufsen	0499	Condor.....	0020		
		Craig	0037, 0047, 0240, 0072		

VCR device codes

Ferguson	0041, 0493, 0321, 0320	ITT.....	0240, 0104, 0041, 0384, 0106	Minerva	0195
Fidelity.....	0000	ITV.....	0037, 0278	Minolta	0042
Finlandia.....	0081, 0104	Jensen	0041	Mitsubishi.....	0081, 0067, 0043, 0041, 0807
Finlux.....	0081, 0000, 0042, 0104	JVC	0045, 0067, 0041, 0384, 0206, 0008	Motorola.....	0035, 0048
Firstline.....	0037, 0045, 0043, 0209, 0072	Kaisui.....	0072	MTC	0240, 0000
Fisher.....	0047, 0104	KEC.....	0037, 0278	Multitech.....	0000, 0072
Frontech.....	0020	Kendo	0209, 0106	Murphy.....	0000
Fuji.....	0035, 0033	Kenwood	0067, 0041, 0038, 0384	Myriad.....	0081
Fujitsu.....	0045, 0000	KLH.....	0072	NAD.....	0104
Funai.....	0000	Kodak	0035, 0037	National.....	0226
Garrard	0000	Kolin.....	0043, 0041	NEC.....	0035, 0037, 0048, 0104, 0067, 0041, 0038, 0008, 0206, 0040
Gateway	1972	Korpel	0072	Neckermann.....	0081
GE	0060, 0035, 0240, 1060, 0226, 1035, 0807	Lenco.....	0278	Nesco.....	0072
GEC.....	0081	Leyco.....	0072	Newave	0037
General.....	0045, 0020	LG.....	0037, 0045, 0042, 0209, 0038, 0040	Nikko.....	0037
Go Video.....	0432	Lloyd's	0000	Nikon.....	0034
GoldHand	0072	Loewe	0162, 0037, 0081, 0454, 0004, 1562	Noblex.....	0240
GoldStar	0037, 0209, 0038, 0225, 1237, 0226	Logik.....	0240, 0072, 0004	Nokia.....	0240, 0104, 0041, 0106
Goodmans.....	0037, 0000, 0072, 0278, 0062, 0637, 0020	Luxor.....	0048, 0104, 0043, 0062, 0106	Nordmende.....	0041, 0321, 0320, 0494, 0384
Gradiente.....	0000, 0008	LXI.....	0037	Northgate.....	1972
Graetz.....	0240, 0104, 0041	M Electronic.....	0000, 0038	Oceanic.....	0000, 0041
Granada.....	0081, 0104	Magnasonic	1278	Okano	0348, 0315
Grandin.....	0037, 0000, 0072	Magnavox	0035, 0039, 0081, 0000, 0149, 1781	Olympus.....	0035, 0226
Grundig	0081, 0072, 0195, 0347, 0293, 0226, 0034	Magnin.....	0240	Optimus	1062, 0162, 0037, 0048, 0104, 0454, 0432
Hanseatic	0037	Manesth.....	0045, 0072	Optonica	0062
Harley Davidson	0000	Marantz.....	0035, 0081, 0062	Orion	0184, 0121, 0209, 0002, 0348, 1479, 0004, 0479, 0352
Harman/Kardon.....	0081, 0038	Marta	0037	Osaki.....	0037, 0000, 0072
Harwood.....	0072	Matsui	0209, 0348, 0004, 0352	Otto Versand	0081
HCM	0072, 0293	Matsushita	0035, 0162, 0227, 0226	Palladium	0037, 0041, 0072
Hewlett Packard.....	1972	Media Center PC	1972	Panasonic	1062, 0035, 0162, 0225, 0454, 0836, 1562, 0227, 0616, 0226, 0459, 1035, 1662
HI-Q.....	0047	Medion.....	0348	Pathe Marconi.....	0041
Hinari	0240, 0072, 0293, 0352, 0004	MEI	0035	Penney	0035, 0037, 0240, 0042, 0038, 1237, 0040, 1035
Hitachi	0037, 0240, 0000, 0042, 0041, 0004, 0166	Memorex.....	0035, 0162, 0037, 0048, 0039, 0047, 0240, 0000, 0104, 0209, 0307, 0479, 0454, 0348, 1237	Pentax.....	0042
Hughes Network Systems.....	0042	Memphis.....	0072	Perdio.....	0000
Hypson.....	0072	Metz.....	0162, 0037, 0347, 1562, 0227, 0459, 0195, 0454	Philco	0035, 0000, 0209, 0038, 0479, 0226
iBUYPOWER	1972	MGA.....	0240, 0043	Philips	0035, 0081, 0000, 0226, 0618, 0062, 0384
Imperial.....	0000	MGN Technology.....	0240	Phonola.....	0081
Ingersol.....	0004	Microsoft.....	1972		
Interfunk	0081	Mind.....	1972		

VCR device codes

Pilot	0037	Scott	0184, 0045, 0121, 0043	Teleavia	0041, 0493
Pioneer	0081, 0042, 0067, 0206	Sears.....	0035, 0037, 0047, 0000, 0042, 0104, 1237	Telefunken.....	0041, 0384, 0321, 0494, 0320, 0493
Polk Audio	0081	SEG	0240	Tenosal.....	0072
Portland.....	0020	SEI	0081, 0004	Tensai.....	0000
Profitronic	0240	Seleco.....	0041	Thomas	0000
Proline	0000, 0293	Semp	0045	Thomson.....	0060, 0067, 0041, 0321, 0494, 0320, 0493, 0722, 0384, 0528
Proscan	0060, 1060	Sentra	0020	Thorn.....	0104, 0041
Protec.....	0072	Sharp	0048, 0209, 0062, 0807	TMK	0240
Pulsar	0039	Shintom	0104, 0072	Toshiba.....	0081, 0045, 0067, 0043, 0041, 0845, 0008, 0384, 1145
Pye	0081	Shogun	0240	Totevision.....	0037, 0240
Quasar.....	0035, 0162, 1035, 0454	Shorai	0004	Touch	1972
Quelle	0081	Siemens.....	0037, 0081, 0104, 0195	Uher	0240
Radiola	0081	Silva	0037	Unitech.....	0240
RadioShack.....	0000	Singer	0045, 0072	Universum.....	0037, 0081, 0240, 0000, 0106, 0195
Radix	0037	Sinudyne.....	0081, 0004	Vector.....	0045
Randex	0037	Solavox.....	0020	Vector Research.....	0038, 0040
RCA.....	0060, 0035, 0240, 0000, 0042, 0149, 0106, 1035, 0226, 0880, 0807, 1060	Sonic Blue	0614, 0616	Victor.....	0067, 0041, 0008, 0384
Realistic.....	0035, 0037, 0048, 0047, 0000, 0104, 0062	Sonolor	0062	Video Concepts	0045, 0040
Reoc.....	0348	Sontec	0037	Videomagic	0037
Rex	0041, 0384	Sony.....	0035, 0032, 0033, 0000, 0636, 1232, 0034, 1032	Videosonic	0240
Ricoh	0034	STS.....	0042	Viewsonic.....	1972
Roadstar.....	0037, 0240, 0072, 0278	Sunkai.....	0348	Villain.....	0000
Runco.....	0039	Sunstar	0000	Wards.....	0060, 0035, 0048, 0047, 0081, 0240, 0000, 0042, 0072, 0149, 0062
Saba	0041, 0320, 0494, 0206, 0384, 0321	Suntronic	0000	Wharfedale.....	0615
Saisho	0209, 0004	Sylvania	0035, 0081, 0000, 0043, 1781	White Westinghouse	0209, 0072, 0637
Salora	0043, 0106	Symphonic.....	0000	XR-1000.....	0035, 0000, 0072
Sampo.....	0037, 0048	Tagar Systems	1972	Yamaha	0041, 0038
Samsung	0240, 0045, 1014, 0432	Tandy	0000, 0104	Yamishi.....	0072
Sanky	0048, 0039	Tashiko.....	0037, 0000	Yokan	0072
Sansui.....	0000, 0067, 0209, 0041, 0479, 1479	Tatung	0081, 0045, 0000, 0067, 0041, 0008	Yoko	0240, 0020
Sanyo	0047, 0240, 0104	Teac	0000, 0041, 0278, 0642, 0637, 0307	Zenith.....	0039, 0033, 0000, 0209, 1479, 0637, 0034, 0479
Saville.....	0352	Tec	0020	ZT Group.....	1972
SBR	0081	Technics.....	0035, 0162, 0226		
Schaub Lorenz	0000, 0104, 0041	Teco	0035, 0037, 0048, 0041, 0038, 0040		
Schneider	0081, 0000, 0072	Teknika.....	0035, 0037, 0000		

Digital video recorder device codes

ReplayTV.....	0614, 0616
Tivo.....	0636, 0618, 0722

BOSE[®]
Better sound through research[®]

©2004 Bose Corporation, The Mountain,
Framingham, MA 01701-9168 USA
274558 AM Rev.00 CCM-000364