

**bodum**<sup>®</sup>

5670/5671

# ANTIGUA

ELECTRIC COFFEE GRINDER



tel 0870 207 4831 | email [mail@redmonkeycoffee.com](mailto:mail@redmonkeycoffee.com)

[www.redmonkeycoffee.co.uk](http://www.redmonkeycoffee.co.uk)

05-5671

[www.redmonkeycoffee.com](http://www.redmonkeycoffee.com)



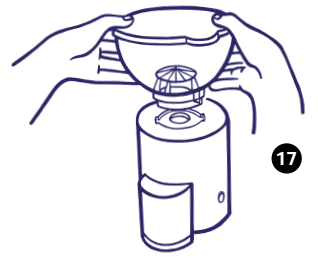
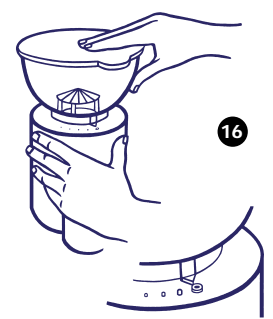
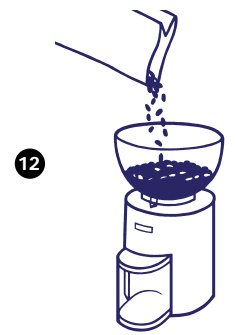
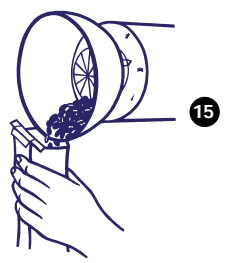
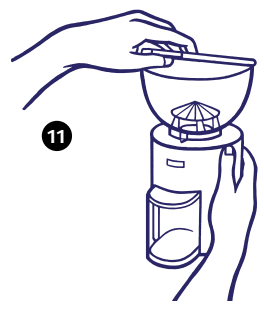
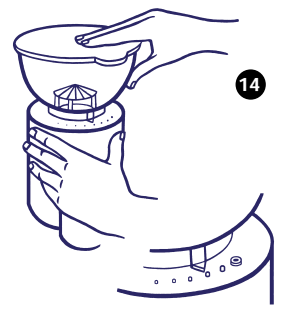
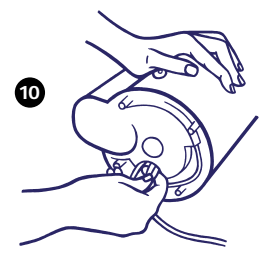
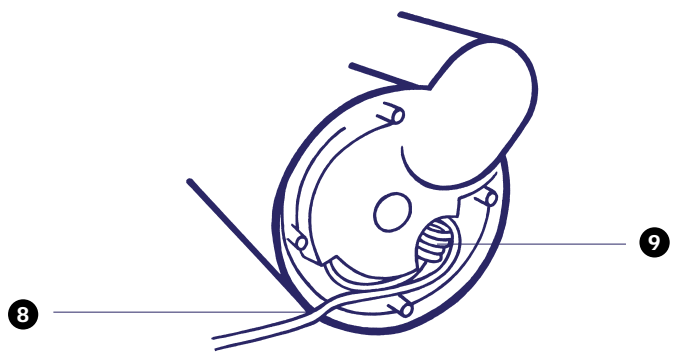
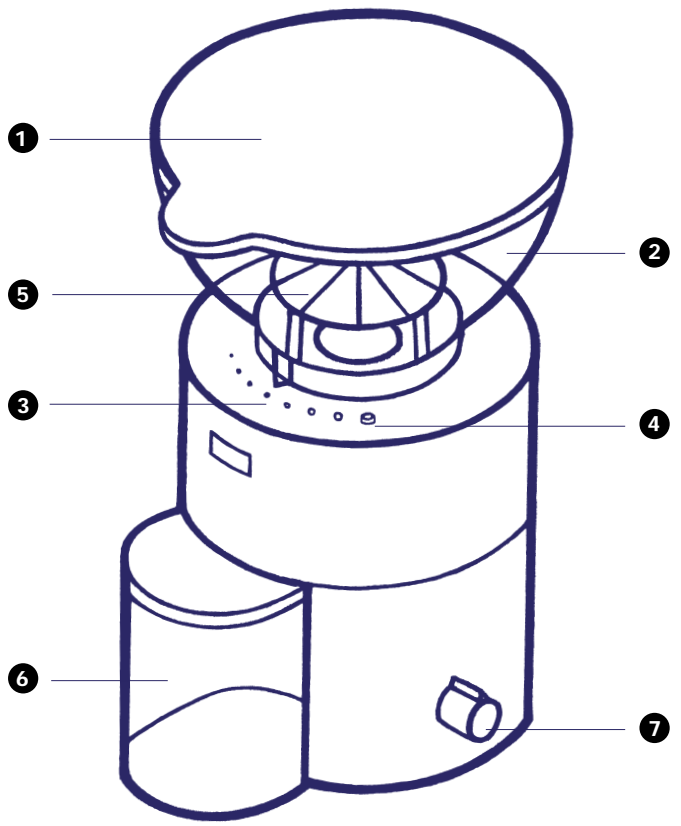

If the three adjustment positions do not precisely match your personal taste you can also grind your coffee by choosing any intermediate position.

**If the appliance has been filled with coffee beans, the grinding control must only be operated when the motor is running.**

### IMPORTANT INSTRUCTIONS

- The BODUM® coffee grinder is preset to position (medium grinding).
- **Only adjust the grinding control while the motor is running.**
- Always keep the lid (fig.1) of the bean container tightly shut in order to enjoy the full taste and aroma of your coffee beans. Never grind more coffee than you actually need.

### QUANTITY CONTROL

The BODUM® coffee grinder is equipped with a time/quantity control (fig.7).

Use it to set the coffee grinder to the desired grinding time and quantity. The appliance switches off automatically once the preset time has elapsed. If you want to interrupt grinding before the preset time has elapsed, simply turn the rotary knob back to the left until the appliance switches off.

The quantity of ground coffee you need to make your coffee depends on the type of bean, the degree of grinding and your personal taste.

**Warning: In order to prevent the motor from overheating, do not grind more than 2 complete units (2x12 cups) in succession. After wait 10 Min. to let the motor cool down before restart.**

**After each grinded unit (12 cups), empty the coffee container. This prevents the motor overheating.**

### STONE SAFETY CUT-OUT FEATURE

Given the huge quantities of coffee that are packed every day, very small stones may accidentally find their way into even the finest coffee beans. The appliance is equipped with a stone safety cut-out - or "friction clutch" - in order to prevent damage to the grinding gear. A stone in the grinding gear will cause a loud rattling noise. Switch the appliance off immediately, remove plug from wall outlet, open it as described in the section entitled "Maintenance" and remove the stone.

### MAINTENANCE

Cleaning the grinding gear

Disconnect the mains plug from the socket outlet. Remove any remaining beans in the bean container (fig.15) and take the latter off by twisting it in an anti-clockwise direction as far as the release area stop (fig.16). Lift the bean hopper from the housing (fig.17). The grinding ring can then be lifted out of the machine.

A soft-bristle brush is ideal for cleaning the grinding gear. Reassemble the machine by performing the above operation in reverse order. Housing and transparent parts can be cleaned easily using a damp cloth.

- Avoid contacting moving parts.
- Never unplug from the outlet when your hands are wet or by pulling the power cord.
- Never carry or pull the appliance by the power cord.
- Do not pull or jam the power cord against sharp edges, do not leave it hanging, do not run or hang it over hot objects, including the stove or a bare flame. Protect the power cord against heat or oil.
- Do not let cord hang over edge of table or counter.
- Only use an extension cord if you are sure that it is in perfect condition.

**Do not switch the appliance on** (immediately unplug from outlet) **if:**

- the appliance housing or power cord is damaged.
- a defect is suspected after dropping or damaging.
- the parts used are not the original parts.

In this case the appliance must be sent for repair to BODUM® or your specialist dealer.

- Electrical appliances must only be repaired by skilled persons.
- Inadequate repair can create significant hazards to users and is not covered by the guarantee.
- Do not operate any appliance with a damaged cord or plug or after the appliance malfunctions, or is dropped or damaged in any manner. Return appliance to the nearest authorized service facility for examination, repair or electrical or mechanical adjustment.
- **BODUM® cannot accept any liability for damage if the appliance is misused, incorrectly operated or inadequately repaired. Under these circumstances the guarantee will be void.**
- The use of attachments not recommended or sold by the manufacturer may cause fire, electric shock or injury.
- Place the appliance on a flat firm surface. Ensure that it cannot fall into water and that no water can splash onto electrical parts.
- Never place the appliance close to or in contact with liquids or steam.
- Only clean the appliance when dry using a brush or a damp cloth.

**Warning: It is essential to disconnect the mains plug before cleaning.**

## KEEP THESE INSTRUCTIONS

### INITIAL OPERATION

Place the appliance on a level surface. Unreel the required length of cord. **It is important to keep the cord short.** Insert the cord into the power cord inlet provided so that it is clamped and insert the plug into the socket outlet. Pack the excess cord length in the cord-tidy (fig.10). Open the lid (fig.11) of the bean container, fill the bean container with the desired quantity of coffee beans (250g max.) (fig.12) and close the lid (fig.13). The appliance is then ready to operate.

### SETTING THE GRINDING CONTROL

The main adjustment positions stated on the control for the degree of grinding are normally sufficient. The degree of grinding can be adjusted by twisting the bean container (fig 14).

 = fine grinding (e.g. for espresso coffee machines)

 = medium grinding (e.g. for filter coffee machines)

 = coarse grinding (e.g. for BODUM® French Press® coffee maker)

## GENERAL INFORMATION

- BODUM® electrical appliances comply with accepted engineering codes of practice and the Law on Safety of Appliances (EEC Directive 73/23). They have been tested by the SEV and UL.
- This appliance is radio-interference-suppressed in accordance with EC Directive 37/308/EEC.
- The packaging material can be disposed of without harming the environment.

## POLARIZATION

For US Customers only

**This appliance has a polarized plug (one blade is wider than the other).** To reduce the risk of electric shock, this plug will fit in a polarized outlet only one way. If the plug does not fit fully in the outlet, reverse the plug. If it still does not fit, contact a qualified electrician. Do not modify the plug in any way.

For UK Customers only

**For appliances supplied with fitted plug.** If the socket outlets in your home are not suitable for the plug supplied with your BODUM® appliance, it should be removed and appropriate plug fitted.

**Note:** Once plug has been cut from mains lead, dispose of immediately as a bare flexible cord on an attached plug is dangerous if placed into a live socket.

**Important:** If your electric coffee grinder is fitted with a non-rewirable plug please refer to the following section.

### Fitting a plug.

**Important:** The wires in this mains lead are coloured in accordance with the following code:

- **BLUE NEUTRAL**
- **BROWN LIVE**

As the colours of the wires in the mains lead of this appliance may not correspond with the coloured markings identifying the terminals in your plug. Proceed as follows.

The wire which is coloured blue must be connected to the terminal which is marked with the letter **N** or coloured black. The wire which is coloured brown must be connected to the terminal which is marked with the letter **L** or coloured red. If a 13 Amp (BSI 1363) plug is used a 3 Amp fuse must be fitted, or if any other type of plug is used a 5 Amp fuse must be fitted either in the plug or adaptor or at the distribution board.

Before connecting to the mains, check that the supply voltage is the same as that shown on the base of the electric coffee grinder. If you are in any doubt, consult a competent electrician or BODUM®.

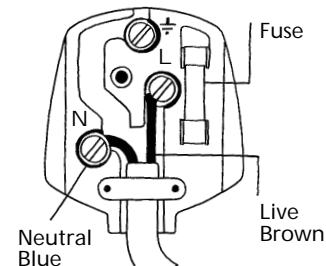

tel 0870 207 4831 | email [mail@redmonkeycoffee.com](mailto:mail@redmonkeycoffee.com)

[www.redmonkeycoffee.co.uk](http://www.redmonkeycoffee.co.uk)