

# Momentum Cyclonic

## BAGLESS VACUUM



### USER'S GUIDE

3910 SERIES 220-240V

- 3 Safety Instructions
- 4 Product View
- 5-6 Assembly
- 6-9 Operation
- 10-16 Maintenance and Care
- 17 Troubleshooting
- 18 Consumer Services
- 19 Replacement Parts
- 20 Warranty



## Thanks for buying a BISSELL vacuum

We're glad you purchased a BISSELL vacuum. Everything we know about floor care went into the design and construction of this complete, high-tech home cleaning system.

Your BISSELL vacuum is well made, and we back it with a limited one year warranty. We also stand behind it with a knowledgeable, dedicated Consumer Services department, so, should you ever have a problem, you'll receive fast, considerate assistance.

My great-grandfather invented the floor sweeper in 1876. Today, BISSELL is a global leader in the design, manufacture, and service of high quality homecare products like your BISSELL vacuum.

Thanks again, from all of us at BISSELL.

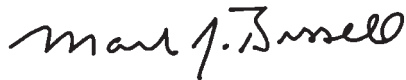

**Mark J. Bissell**  
President and Chief Executive Officer



# IMPORTANT SAFETY INSTRUCTIONS

When using an electrical appliance, basic precautions should be observed, including the following:

## READ ALL INSTRUCTIONS BEFORE USING YOUR UPRIGHT VACUUM.

**⚠ WARNING:** To reduce the risk of fire, electric shock, or injury:

- Use indoors only.
- Do not leave machine when it is plugged in.
- Do not use with damaged cord or plug.
- If appliance is not working as it should, has been dropped, damaged, left outdoors, or dropped into water, return it to a service agent.
- Do not handle unit with wet hands.
- Do not pull or carry by cord, use cord as a handle, close door on cord, pull cord around sharp corners or edges, run appliance over cord, or expose cord to heated surfaces.
- Do not unplug by pulling on cord. Unplug by grasping plug.
- Do not run appliance over cord.
- Do not handle plug or appliance with wet hands.
- Do not expose hair, loose clothing, fingers or body parts to openings or moving parts.
- Do not pick up hot or burning objects such as cigarettes, matches, or hot ashes.
- Do not pick up flammable or combustible materials (lighter fluid, petrol, kerosene, etc.) or use in the presence of explosive liquids or vapour.
- Do not use appliance in an enclosed space filled with vapours given off by oil base paint, paint thinner, some moth proofing substances, flammable dust, or other explosive or toxic vapours.
- Not intended for use by young children or infirm persons without supervision.
- Young children should be supervised to ensure that they do not play with the appliance.

- Remove plug from electrical outlet before cleaning or maintaining the appliance.
- If the supply cord is damaged, it must be replaced by the manufacturer or its service agent in order to avoid a hazard.
- Do not pick up toxic material (chlorine bleach, ammonia, drain cleaner, petrol, etc.).
- Do not allow to be used as a toy.
- Do not use for any purpose other than described in this User's Guide.
- Use only manufacturer's recommended attachments.
- Do not use with any opening blocked; keep free of dust, lint, hair, and anything that may reduce air flow.
- Keep appliance on a level surface.
- Turn off all controls before unplugging.
- Be extra careful when cleaning stairs.
- This appliance is provided with double insulation. Use only identical replacement parts.
- Do not use without debris tank and/or filters in place.
- Pay close attention when working around children.

## SAVE THESE INSTRUCTIONS.

THIS MODEL IS FOR HOUSEHOLD USE ONLY.

## IMPORTANT

FOR OPERATION ON A 220-240 VOLT A.C. 50/60 Hz POWER SUPPLY ONLY.

## FOR RESIDENTS OF THE UNITED KINGDOM ONLY

If your appliance is fitted with a nonrewireable BS 1363 plug it must not be used unless a 13 amp (ASTA approved to BS 1362) fuse is fitted in the carrier contained in the plug. (Spares may be obtained from your BISSELL supplier). If for any reason the plug is cut off, it must be disposed of, as it is an electric shock hazard should it be inserted into a 13 amp socket.

## Product view

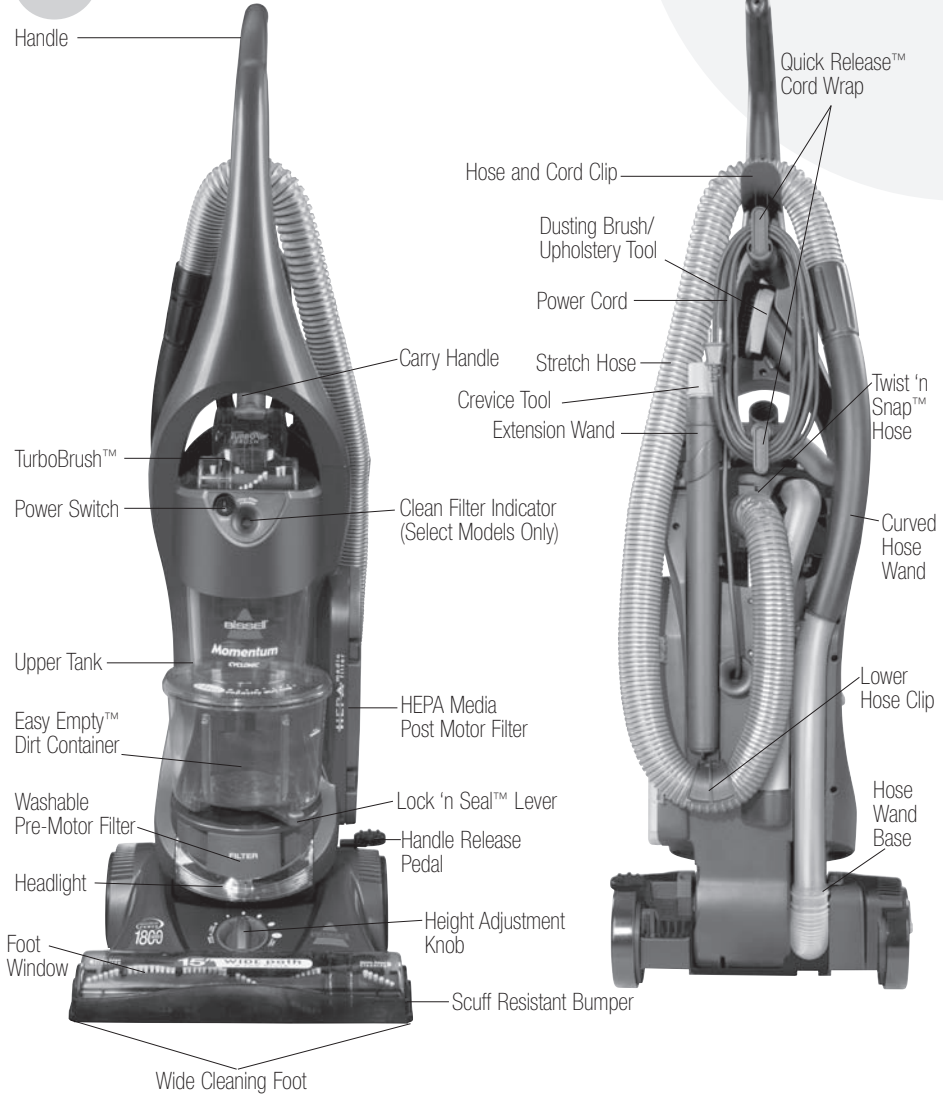

## Assembling your vacuum

The only tool you'll need to assemble your vacuum cleaner is a Phillips screwdriver.

### Attach handle to vacuum

1. Locate the handle and cord wrap. Remove the screw packet taped to the cord wrap.
2. Stand the vacuum upright and from the rear of the unit, slide the base of the handle firmly into the grooves at the top of the vacuum body.
3. **IMPORTANT** – before inserting the screws into the handle, slide the cord wrap into the handle.
4. Ensure that the handle and cord wrap are firmly fit to the vacuum body. If there are any gaps, continue to push firmly until the handle and cord wrap are flush.
5. Insert 2 of the screws provided (3 total) into the existing holes, attaching the cord wrap and handle to the body of the vacuum. Tighten securely with a screwdriver.
6. Attach the hose and cord clip by snapping it into the handle of the unit. Secure it by inserting the screw provided.
7. Attach the lower hose clip by snapping it into place and twisting to the right.

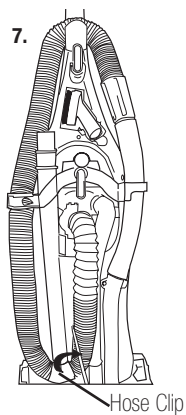

**CAUTION:**  
Do not plug in your vacuum cleaner until you are familiar with all instructions and operating procedures.

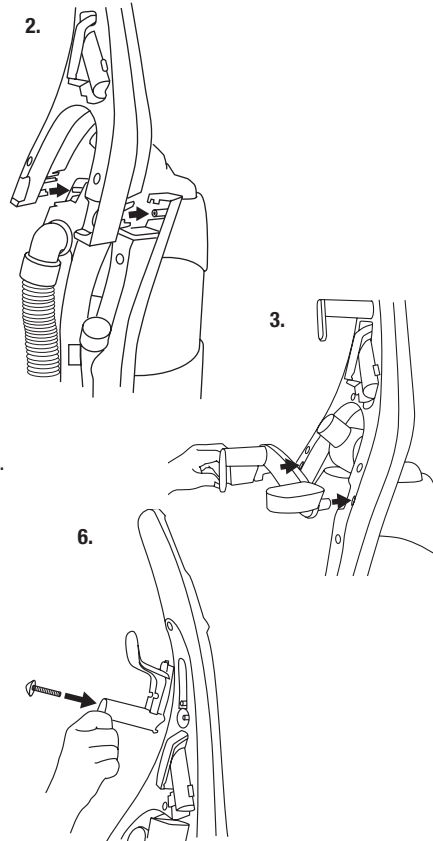

**WARNING:**  
Plastic film can be dangerous. To avoid danger of suffocation, keep away from babies and children.

## Assembling your vacuum

### Attach vacuum hose and tools

1. Line up the tabs on the base of the Twist 'n Snap hose with the corresponding notches on the hose collar as shown.
2. Turn the Twist 'n Snap hose to the **left** to lock the hose into place.
3. Connect the curved hose wand to the hose. Grasping the curved hose wand, slide the end of the curved hose wand onto the hose wand base. Snap the hose into the hose clip.  
**NOTE: The vacuum will not operate effectively unless the curved hose wand is firmly attached.**
4. Slide the extension wand and crevice tool together into the storage clip as shown.
5. Slide the dusting brush/upholstery tool into the storage clip as shown.
6. Attach the TurboBrush by snapping it onto the top cap of the upper tank.

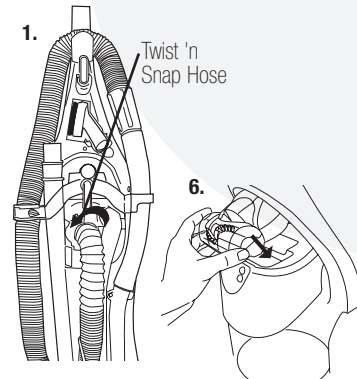

**CAUTION:**  
Before using your vacuum, make sure that the dirt container is in the locked position and that all filters (pre-motor and HEPA post-motor) are in place. Do not operate your vacuum without these filters.

**NOTICE:**  
For above floor cleaning, the floor brush continues to rotate but is raised above floor. To prevent carpet damage, do not lean on the vacuum or let the powerfoot tilt forward.

**CAUTION:**  
To avoid personal injury and to prevent the cleaner from falling when cleaning stairs, always place it at the bottom of the stairs.

## Operation

### Power switch

The power switch is located just below the handle on the front of the vacuum. Push the rocker switch "ON" (I) to vacuum, and "OFF" (O) when cleaning is complete.

## Operation

### Handle positions

Press the handle release pedal, located on the lower left side of the vacuum, with your foot to place your vacuum into one of three cleaning positions.

1. **Upright** – For storage and above floor cleaning with tools.
2. **Normal Cleaning** – Press handle release pedal once. Position used for most household floor cleaning tasks.
3. **Low Cleaning** – With the vacuum in normal cleaning position, press handle release pedal again. Use for reaching under low furniture such as tables, chairs or beds.

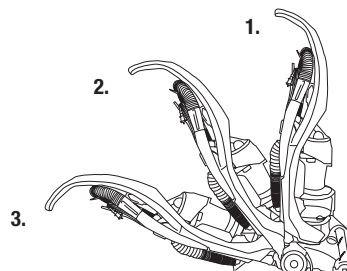

### Tip:

Before cleaning under low furniture, check area first for objects that might harm the unit or block the vacuum hose.

### Height adjustment

The powerfoot/rotating floor brush on your vacuum can be adjusted to clean several floor surfaces.

**NOTE:** For optimal cleaning performance, adjust to the lowest practical setting. If your cleaner is difficult to push, adjust to the next higher setting.

1. Turn height adjustment knob to desired setting.

<b>Bare Floor</b>	For non-carpeted, indoor surfaces
<b>Lowest Setting</b>	For short pile carpets
<b>Medium Setting</b>	For short and medium pile carpets
<b>Highest Setting</b>	For plush pile carpet

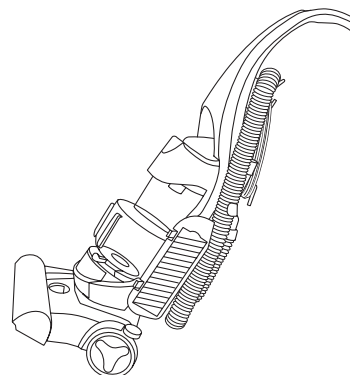
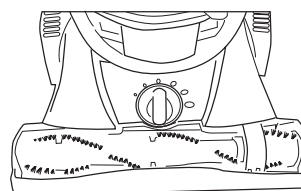

### Transporting cleaner

1. To move your cleaner from room to room, put the handle in the upright position, tilt the cleaner back on its rear wheels and push forward.
2. The cleaner can also be moved by using the carry handle.

2a. right way to carry

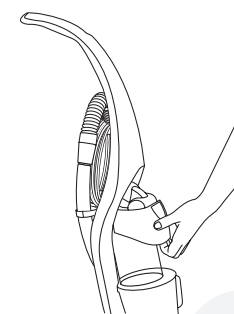
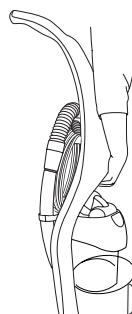

## Operation

### Clean filter indicator

#### Select Models Only

The clean filter indicator tells you when the airflow in your vacuum is reduced due to dirty filters or a clog in the hose. The clean filter indicator will remain green while the unit is running until the airflow is reduced by a clog or dirty filter. At that time, it begins to change to red or black. When it is fully red, the airflow is significantly reduced or clogged by a dirty filter. Follow the steps on page 11 to clean your filters. All filters in the vacuum should be cleaned or replaced when the clean filter indicator turns red.

If the indicator turns black, it means you have a clog in your hose. To check and remove the clog, remove the hose from the unit by turning the Twist 'n Snap hose to the **right**. Try to visually locate the clog. Once you have done this, use a blunt long object such as a broom handle to loosen and remove the debris. Once this is completed, reassemble the hose to the unit.

If the indicator remains red or black with the vacuum running, follow the steps on page 15 to check for and clear clogs.

**NOTE: When your vacuum is turned off, the clean filter indicator will go to the red color setting. The clean filter indicator only detects reductions in airflow when the vacuum power is on.**

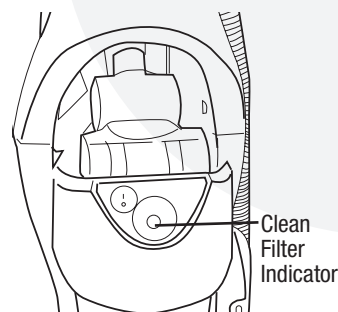

### NOTICE:

**While vacuuming, certain carpets and low humidity conditions may generate small static discharges. The discharges are entirely harmless and are not associated in any way with the main power supply.**

### Special on-board tools

**Your vacuum is not only a powerful carpet and rug cleaner, it's also a versatile above floor vacuum cleaner when you select one of the special tools.**

1. Raise the handle to the upright position.
2. Grasp the curved hose wand handle to separate from hose wand base.
3. Attach tools by firmly pushing onto vacuum hose, curved hose wand or extension wand. They are a friction fit, so be sure the hose and tool fit snugly together.

**Dusting Brush/Upholstery Tool:** Two types of cleaning tools in one attachment.

- Use the dusting brush to dust furniture, blinds, books, lamps, shelves and baseboards.
- Slide the brush off to use the upholstery tool on cushions, draperies and fabrics.

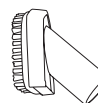
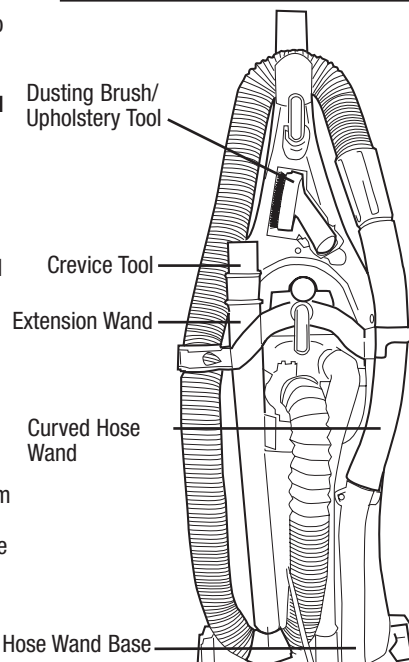



## Operation

**Crevice Tool:** Use in tight narrow spaces.

**Extension Wand:** Use with desired attachment for a longer reach.

**Curved Hose Wand:** Use with desired attachment for a longer reach or for cleaning hard to reach places.

**TurboBrush™:** Use rotating brush action for small areas such as stairs and upholstery.

**NOTE: Press gently when using the TurboBrush to maximize cleaning. Too much pressure will cause the brush to stop rotating.**

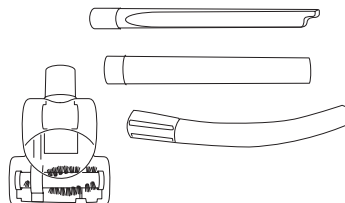

### Tip:

Hair, string and small objects can block the vacuum hose or tools. Check them occasionally for obstructions.

## Power cord usage

1. To use your vacuum, remove the cord and plug it into an electrical outlet. For your convenience, there are two quick release cord wraps for easy cord removal. There is also a cord clip that is part of the upper cord wrap where you can attach the cord when vacuuming.
2. When you are finished cleaning, turn vacuum cleaner off.
3. Unplug power cord by grasping the plug (NOT the cord) and disconnect from outlet.
4. Loop power cord around cord wraps on rear of vacuum cleaner. Be sure to first return the quick release cord wraps back to their original position before wrapping the cord.
5. Clip molded plug to power cord to secure.

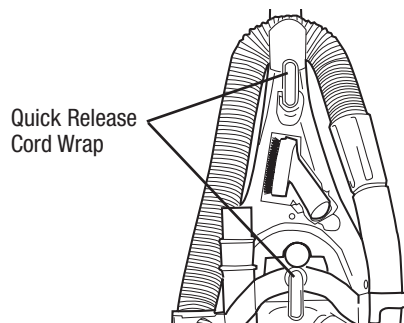

www.bissell.com



## NOTICE:

For above floor cleaning, the floor brush continues to rotate but is raised above floor. To prevent carpet damage, do not lean on the vacuum or let the powerfoot tilt forward.

## CAUTION:

The rotating floor brush continues to rotate while tools are in use. To reduce the risk of injury from moving parts, always move the cleaner with the carrying handle. Always place vacuum cleaner on the floor with handle in upright position when using tools. Never place your fingers under the cleaner when it is running. Never place powerfoot on furniture or uneven surfaces. Do not place vacuum cleaner close enough to objects to pull them into the rotating floor brush.

## Maintenance and care

To maximize your cleaning performance and extend the life of your vacuum, it is very important that you empty your dirt container and check and clean your filters frequently. Perform the following maintenance steps:

1. Empty the dirt container when the dirt reaches the "Full" line on the container, or more frequently to prevent overfills. For best performance, empty after each use.
2. Check the pre-motor filter and post-motor HEPA media filter at least once a month and clean or replace as needed.

**NOTE: Be sure to clean or replace your filters anytime the clean filter indicator (select models only) begins to turn red.**

3. Replace the post-motor HEPA media filter every three to six months.

**NOTE: More frequent filter cleaning may be necessary if you are vacuuming new carpet, fine dust, or have allergy concerns. Follow the instructions on the following pages to perform these simple maintenance steps.**

**⚠ WARNING:**  
To reduce the risk of electric shock, turn power switch OFF and disconnect plug from electrical outlet before performing maintenance or troubleshooting checks.

### Tip:

To maximize cleaning performance, check and clean or replace all filters as suggested.

## Empty dirt container

The dirt container needs to be emptied when the dirt reaches the "Full" line on the container.

1. Unplug the vacuum from electrical outlet
2. Slide the Lock 'n Seal Lever to the "Unlock" position.
3. Grasp handle and pull the dirt container straight out to remove from the vacuum.
4. Empty dirt into garbage container.

**NOTE: Emptying the dirt container after every use will help prevent overfilling and ensure that the vacuum is ready to go the next time you clean.**

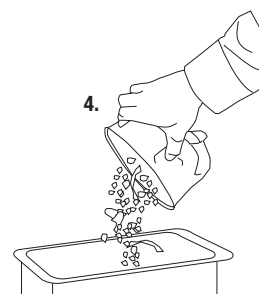
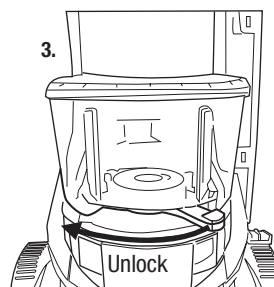

## Maintenance and care

### Cleaning the pre-motor and post-motor HEPA media filter

1. Unplug the vacuum from electrical outlet.
2. The pre-motor filter protects the motor from dirt particles. It is located in the side out tray underneath the dirt container. If the filter becomes dirty, pull out the tray, lift out the foam filter pad and clean it.

**NOTE: The pre-motor filter may be hand washed in cold water with mild detergent. Rinse well and air dry thoroughly before replacing.**

3. The post-motor HEPA media filter assists in the filtration process to return clean air to the room. It is located behind the door on the side of the vacuum. If the filter becomes dirty, open the door, remove the filter and replace.

**NOTE: The post-motor filter is a white, pleated HEPA media filter. This filter is NOT washable and must be replaced when it becomes dirty.**

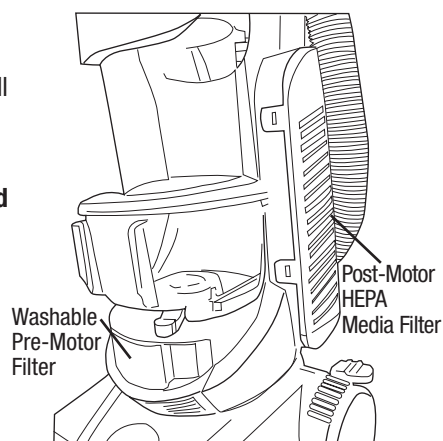

### **WARNING:**

**Do not operate vacuum cleaner with damp or wet filters or without all filters in place.**

## Maintenance and care

### Check rotating floor brush and drive belt

You should check your vacuum cleaners rotating floor brush and drive belt regularly for wear or damage. You should also clean the brush and brush ends of strings, hair and carpet fibers. This type of debris can wrap around the brush and hamper its ability to effectively clean your carpet. Also remove any debris that has accumulated under the brush cover.

1. Unplug the vacuum from electrical outlet.
2. Place handle in low position and turn vacuum cleaner over so bottom side is facing up.
3. Remove the screws marked 1 and 2. Release the latches marked 3 and 4. Lift off the brush cover.
4. Grasp rotating floor brush at both ends and lift.
5. Clean strings, hair and other debris from rotating floor brush, paying particular attention to brush ends.
6. Clean strings, hair and other debris from motor pulley and drive belt areas.
7. Check drive belt carefully for wear, cuts or stressed areas.
8. Check air passageway for obstructions. Remove debris from this area.



### **WARNING:**

To reduce the risk of injury from moving parts, turn power switch off and disconnect plug from electrical outlet.

3.

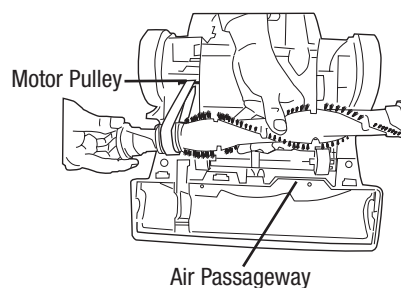
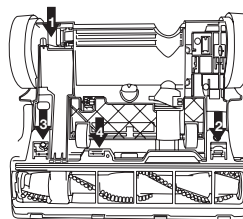

## Maintenance and care

### Replace drive belt

1. Unplug the vacuum from electrical outlet.
2. With rotating floor brush removed from vacuum cleaner (Steps 1-4 of check rotating floor brush and drive belt), grasp old drive belt and remove from motor pulley. Discard the old drive belt.
3. Place new drive belt over motor pulley and loop other end over rotating floor brush in the space between the bristles.

**NOTE: It is important that you use only genuine BISSELL replacement belts. Generic belts may not meet the exacting specifications required to keep your vacuum operating at its peak performance. The use of unbranded belts could lead to early failure of the vacuum and could void your warranty.**

4. Pull the rotating floor brush firmly into position, stretching the drive belt and placing ends of rotating floor brush down into the slots on sides. Alignment of brush ends in slots may be necessary to fully insert the brush.
5. Turn rotating floor brush by hand several times in the direction of motor pulley. If properly installed, drive belt will center itself on rotating brush crown.
6. Insert front edge of brush cover, rotate into place, snap two latches and replace two screws.

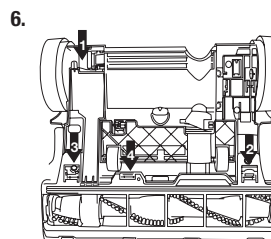
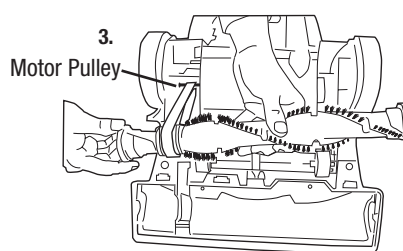

### Replace lightbulb

1. Unplug the vacuum from electrical outlet.
2. Using a flat bladed screwdriver, pry the tab on the left and right side out and pull out to remove the lens.
3. Remove the bulb from the socket by grasping the bulb and pulling gently. Install the new bulb by pushing it gently into the socket until the bulb snaps into place.
4. Reposition the lens and snap it back into place.

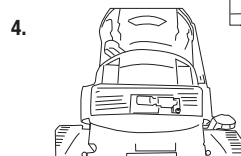
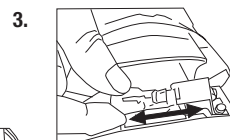
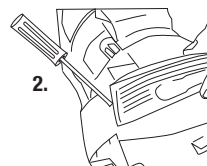

## Maintenance and care

### Maintaining TurboBrush

**The TurboBrush should be checked regularly for clogs or debris wrapping around the brush.**

1. Unplug the vacuum from electrical outlet.
2. If a clog is present or debris is visible, unscrew the two screws on the back of the TurboBrush to remove the faceplate and clear any obstructions.
3. To clean debris from the brush, remove the brush from the drive belt and clean debris.
4. Reposition the drive belt on the brush. Place ends of brush in slots on sides as shown. Reposition faceplate and secure with two screws.

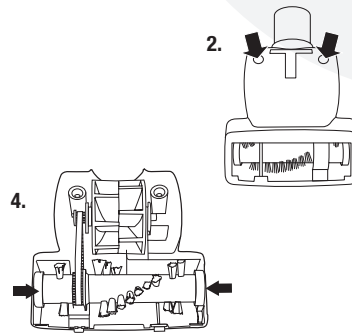

## Maintenance and care

### Clearing clogs

Low suction or poor pickup may be due to a clog in the vacuum cleaner. If you notice a change in the sound of the motor, check for clogs.

1. Unplug the vacuum from electrical outlet.
2. Empty dirt container.
3. Check upper tank for build up or clogs.
4. If you notice a clog in the upper tank, remove the separator plate (see section "Cleaning the Upper Tank" on page 16).
5. Grasp the curved wand and separate it from the hose wand base. Check for a clog in the base, the wand or in the hose.  
**NOTE: On select units that have the clean filter indicator, when the indicator reads black, there is a clog in the hose which is diminishing suction power. Remove the clog in the hose to restore full suction power.**
6. Remove the Twist 'n Snap hose from the vacuum by turning to the **right**. Straighten the hose and unclog with a long, narrow object.
7. If you notice debris or dirt clogged in the connecting tube, remove it by pulling it out at the top and lifting the tube out. Clean the tube of any debris and clear any possible clog from the port to the pre-motor filter. Reattach tube by first installing the base and then push in the top of the tube.
8. If the clog persists, follow the instructions for checking the rotating floor brush and drive belt on page 12 and inspect the air passageway for obstructions.

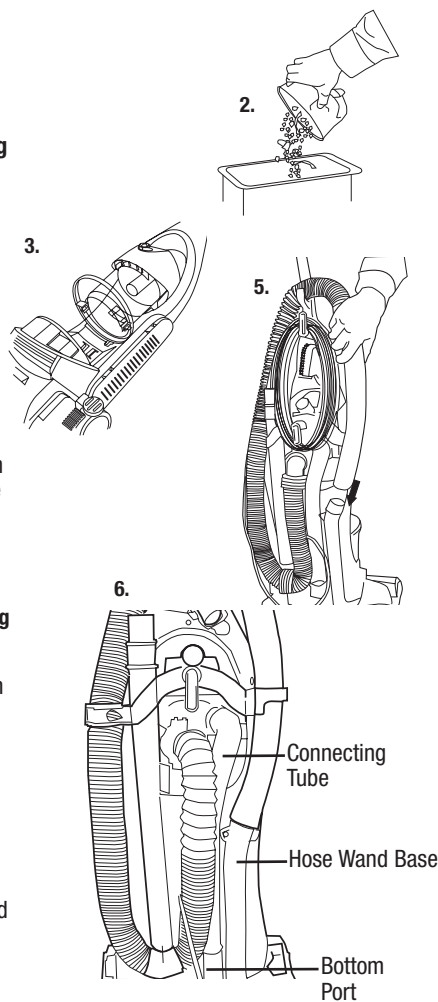

## Maintenance and care

### Cleaning the upper tank

1. Unplug the vacuum from electrical outlet.
2. Remove the dirt container as instructed in "Empty Dirt Container" on page 10.
3. Using a short Phillips screwdriver, take off the separator plate by removing the two screws that secure it to the upper tank.
4. Wipe out the inside of the upper tank and the separator plate with a damp cloth moistened with water or a mild cleaning solution.
5. Replace the separator plate and screws.
6. Replace the dirt container.

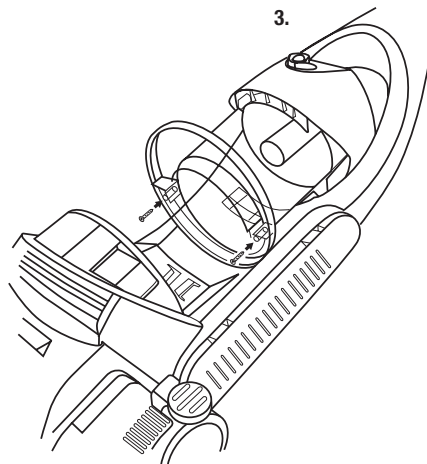



## Troubleshooting

### Vacuum cleaner won't run

#### Possible causes

1. Power cord not plugged in

### Vacuum cleaner and tools won't pick up dirt

#### Possible causes

1. Incorrect height adjustment
2. Hose not attached to suction opening
3. Twist 'n Snap hose not securely attached
4. Crack or hole in hose
5. Broken or worn drive belt
6. Rotating floor brush bristles worn
7. Rotating floor brush jammed
8. Clog in vacuum
9. Dirt container full
10. Dirt container not installed properly
11. Filters are dirty
12. TurboBrush is clogged or debris is wrapped around the brush roll

### Vacuum cleaner is difficult to push

#### Possible causes

1. Incorrect height setting

### Visible dirt escaping from cleaner

#### Possible causes

1. Dirt container full
2. Filters missing or installed incorrectly
3. Dirt container installed incorrectly

**Other maintenance or service not included in the manual should be performed by an authorized service representative.**

**Thank you for selecting a BISSELL product.**

**Please do not return this product to the store.**



## WARNING:

To reduce the risk of electric shock, turn power switch OFF and disconnect plug from electrical outlet before performing maintenance or troubleshooting.

#### Remedies

1. Check electrical plug

#### Remedies

1. Adjust powerfoot to correct height
2. Firmly push curved hose wand into hose wand base
3. Make sure Twist 'n Snap hose is snapped into locked position
4. Check hose and replace if needed
5. Replace drive belt, see pages 12-13
6. Replace brush
7. Remove brush and clean debris from brush ends
8. Clear clogs, see page 15
9. Empty dirt container
10. Position correctly and lock in place
11. Check and clean or replace pre-motor and post-motor filters
12. Check TurboBrush, see page 14

#### Remedies

1. Adjust powerfoot to correct height setting

#### Remedies

1. Empty dirt container
2. Check pre-motor and post-motor filters for correct installation
3. Pull out and re-insert dirt container correctly

## BISSELL Consumer Services

### If your BISSELL product should require service:

In the UK, Australia, or New Zealand, call BISSELL Consumer Services at the numbers below and we will give you the location of a BISSELL Authorized Service Center in your area. For all other countries, contact your local in country distributor for questions, service, or repair.

If you have questions about your warranty or need replacement parts please contact the numbers below.

#### For UK inquiries:

Monday - Thursday 9 am — 5 pm  
Friday 9 am — 4 pm

#### BISSELL Homecare (Overseas) Inc.

The Boat Yard  
105 Straight Road  
Old Windsor  
Berkshire, SL4 2SE  
United Kingdom  
Telephone: 0870-225-0109

#### For New Zealand inquiries:

Monday - Friday 9 am — 5 pm

#### Parex Appliances

103 Central Park Drive  
Henderson  
Auckland  
New Zealand  
Telephone: 0800-247-735

Or visit the BISSELL website - [www.bissell.com](http://www.bissell.com)

When contacting BISSELL, have model number of unit available.

Please record your Model Number: \_\_\_\_\_

Please record your Purchase Date: \_\_\_\_\_

**Note: Please keep your original sales receipt. It provides proof of date of purchase in the event of a warranty claim. See Warranty on page 20 for details.**

Please do not return this product to the store.

#### For Australian inquiries:

24 hours a day 7 days a week

#### E.D. Oates Pty Ltd

76 - 82 Newlands Road  
Reservoir VIC 3073  
Australia  
Telephone: 1-800-811-183

#### For all other inquiries:

Monday - Friday 8 am — 4 pm

#### BISSELL Homecare, Inc.

PO Box 1888  
Grand Rapids, MI 49501 USA  
Telephone: 01-616-453-4451  
Fax: 01-616-453-1383



## Replacement parts

Item	Part No.	Part Name
1	32074	Style 7/9/10/12/14 Drive Belt (2-Pack)
2	203-1297	Headlight Bulb
3	203-1063	Crevice Tool
4	203-1228	Dusting Brush/Upholstery Tool
5	203-2302	TurboBrush, clear top with black brush roll
6	203-1022	Extension Wand
7	203-2303	Curved Hose Wand
8	203-2304	Twist 'n Snap Vacuum Hose (clear)
9	203-2305	Wide Window Foot Brush Roll (gray)
10	3290	Style 7/8/14 Pre-Motor Foam Filter
11	3091	Style 8/14 HEPA Media Post-Motor Filter
12	203-2306	Hose & Cord Wrap
13	203-2307	Cord Clip
14	203-2308	Hose Clip

1



2



3



4

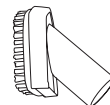

5

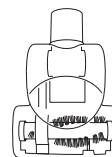

6



7



8

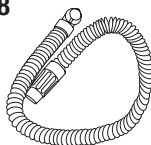

9



10



11



12

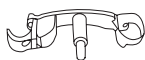

13



14



## Warranty - BISSELL Momentum Cyclonic Bagless Vacuum

This warranty gives you specific legal rights, and you may also have other rights which may vary from country to country. If you need additional instruction regarding this warranty or have questions regarding what it may cover, please contact BISSELL Consumer Services by telephone, or regular post as described below, or contact your local in country distributor.

### Limited One Year Warranty

Subject to the \*EXCEPTIONS AND EXCLUSIONS identified below, BISSELL Homecare, Inc., will replace (with new or remanufactured components), at BISSELL's option, free of charge from the date of purchase by the original purchaser, for one year any defective or malfunctioning part do to manufacturers defect.

This warranty applies to product used for personal, and not commercial or rental service. This warranty does not apply to fans or routine maintenance components such as filters, belts, or brushes. Damage or malfunction caused by negligence, abuse, or use not in accordance with the User's Guide is not covered.

#### For UK inquiries:

Monday - Thursday 9 am — 5 pm  
Friday 9 am — 4 pm

#### BISSELL Homecare (Overseas) Inc.

The Boat Yard  
105 Straight Road  
Old Windsor  
Berkshire, SL4 2SE  
United Kingdom  
Telephone: 0870-225-0109

#### For Australian inquiries:

24 hours a day 7 days a week

#### E.D. Oates Pty Ltd

76 - 82 Newlands Road  
Reservoir VIC 3073  
Australia  
Telephone: 1-800-811-183

#### For New Zealand inquiries:

Monday - Friday 9 am — 5 pm

#### Parex Appliances

103 Central Park Drive  
Henderson  
Auckland  
New Zealand  
Telephone: 0800-247-735

#### For all other inquiries:

Monday - Friday 8 am — 4 pm

#### BISSELL Homecare, Inc.

PO Box 1888  
Grand Rapids, MI 49501 USA  
Telephone: 01-616-453-4451  
Fax: 01-616-453-1383

**BISSELL HOMECARE INC. IS NOT LIABLE FOR INCIDENTAL OR CONSEQUENTIAL DAMAGES OF ANY NATURE ASSOCIATED WITH THE USE OF THIS PRODUCT. BISSELL'S LIABILITY WILL NOT EXCEED THE PURCHASE PRICE OF THE PRODUCT.**

#### \*EXCEPTIONS AND EXCLUSIONS FROM THE TERMS OF THE LIMITED WARRANTY

**THIS WARRANTY IS EXCLUSIVE AND IN LIEU OF ANY OTHER WARRANTIES EITHER ORAL OR WRITTEN. ANY IMPLIED WARRANTIES WHICH MAY ARISE BY OPERATION OF LAW, INCLUDING THE IMPLIED WARRANTIES OF MERCHANTABILITY AND FITNESS FOR A PARTICULAR PURPOSE, ARE LIMITED TO THE ONE YEAR DURATION FROM THE DATE OF PURCHASE AS DESCRIBED ABOVE.**



©2007 BISSELL Homecare, Inc.  
Grand Rapids, Michigan  
All rights reserved. Printed in Korea  
Part Number 603-2377  
Rev 2/07  
Visit our website at:  
[www.bissell.com](http://www.bissell.com)

