







Patent Pending  
**BILLY GOAT FORCE BLOWER**  
 F800  
**Owner's Manual**

**Accessories**

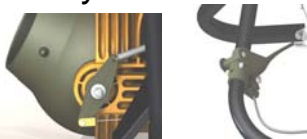
<p><b>HOLD DOWN KIT</b></p> <p><i>To secure blower for transportation on trailer floors.</i></p>  <p><b>P/N 440120</b></p>	<p><b>PARKING BRAKE</b></p> <p><i>Effective and Easy to use to prevent blower from rolling.</i></p>  <p><b>P/N 440140</b></p>	<p><b>FRONT AIR DIVERTER</b></p> <p><i>Simple to attach, allowing air to be directed forward.</i></p>  <p><b>P/N 440188</b></p>	<p><b>AIM AND SHOOT</b></p> <p><i>Allows up and down motion via a lever to easily move debris.</i></p>  <p><b>P/N 440128</b></p>	<p><b>THROTTLE CONTROL</b></p> <p><i>Positions throttle control at a convenient location.</i></p>  <p><b>P/N 440189</b></p>
--	--	--	--	--



**ABOUT THIS MANUAL**

**THANK YOU** for purchasing a BILLY GOAT® *FORCE Blower*. Your new machine has been carefully designed and manufactured to provide years of reliable and productive service. This manual provides complete operating and maintenance instructions that will help to maintain your FORCE Blower in top running order. Read this manual carefully before assembling, operating, or servicing your equipment.

**CONTENTS**

SERIAL PLATE DATA AND SPECIFICATIONS _____	3
GENERAL SAFETY _____	4-5
INSTRUCTION LABELS _____	6
PACKING CHECKLIST _____	7
ASSEMBLY _____	8
OPERATION _____	9
MAINTENANCE _____	10
TROUBLESHOOTING AND WARRANTY PROCEDURE _____	11
ILLUSTRATED PARTS LIST _____	12
PARTS LIST _____	13
MAINTENANCE RECORD _____	14



**SERIAL PLATE DATA**

Record the model number, serial number, date of purchase, and where purchased.

Purchase Date: \_\_\_\_\_

Purchased From: \_\_\_\_\_

		1803 S.W. Jefferson Lee's Summit, MO 64082 / USA Tel (816) 524-9606 Fax (816) 524-6983	
Model		Serial No.	
<input type="text"/>		<input type="text"/>	
Unit(Weight)		Engine Power	
<input type="text"/> lbs.	<input type="text"/> kg	<input type="text"/> kW	<input type="text"/> rpm

**Specifications**

**F800**

Engine: HP	8 HP (5.96kW)
Engine: Model	202432-0210-E9
Engine: Type	B & S
Engine: Fuel Capacity	4 qt. (3.78L)
Engine: Oil Capacity	28 oz. (0.8L)
Total Unit Weight:	144# (65.3Kg)
Overall Length:	58"(1.43m)
Overall Width	29.25" (0.74m)
Overall Height	45" (1.14m)



## GENERAL SAFETY INSTRUCTIONS and SYMBOLS

The safety symbols shown below are used throughout this manual. You should become familiar with them before assembling, operating, or servicing this equipment.



**WARNING:** This symbol indicates important information that will prevent injury to yourself or others.



This symbol indicates ear protection is recommended when operating this equipment.



This symbol indicates eye protection is recommended when operating this equipment.



This symbol indicates gloves should be worn when servicing this equipment.



This symbol indicates that this manual and the engine manufacturer's manual should be read carefully before assembling, operation, or servicing this equipment.



**CAUTION:** This symbol indicates important information that will prevent damage to your BILLY GOAT® FORCE Blower.



This symbol indicates the engine oil level should be checked before operating this equipment.

Read and make sure you thoroughly understand the following safety precautions before assembling, operating or servicing this equipment:



**READ** this manual and the engine manufacturer's manual carefully before assembling, operating, or servicing this equipment.



**EAR PROTECTION** is recommended when operating this equipment.



**EYE PROTECTION** is recommended when operating this equipment.



**BREATHING PROTECTION** is recommended when operating this equipment.



**WARNING:** **EXHAUST** from this product contains chemicals known to the State of California to cause cancer, birth defects or other reproductive harm.

**DO NOT** operate this equipment on any unimproved forested, brushy, or grass covered land unless a spark arrester is installed on the muffler as required by Section 4442 of the California Public Resources Code. The arrester must be maintained in good working order. Other states may have similar laws. Federal laws apply on federal lands.





















**DO NOT** run engine in an enclosed area. Exhaust gases contain carbon monoxide, an odorless and possibly fatal poison.



## FORCE BLOWER 8 Owner's Manual



**WARNING:**

-  **DO NOT** run this equipment indoors or in any poorly ventilated area. Refueling outdoors is recommended.
  -  **DO NOT** refuel this equipment while the engine is running. Allow engine to cool for at least two minutes before refueling.
  -  **DO NOT** store gasoline near an open flame.
  -  **DO NOT** remove gas cap while engine is running.
  -  **DO NOT** start or operate engine if strong odor of gasoline is present.
  -  **DO NOT** start or operate engine if gasoline is spilled. Move equipment away from spill until gasoline has completely evaporated.
  -  **DO NOT** smoke while filling the fuel tank.
  -  **DO NOT** check for spark with spark plug or spark plug wire removed. Use an approved spark tester.
  -  **DO NOT** operate engine without a muffler. Inspect muffler periodically and replace if necessary. If equipped with muffler deflector, inspect deflector periodically and replace if necessary.
  -  **DO NOT** operate engine with grass, leaves or other combustible material near the muffler.
  -  **DO NOT** touch muffler, cylinder, or cooling fins when hot. Contact with hot surfaces may cause severe burns.
  -  **DO NOT** leave equipment unattended while in operation.
  -  **DO NOT** park equipment on a steep grade or slope.
  -  **DO NOT** operate equipment with bystanders in or near the work area.
  -  **DO NOT** allow children to operate this equipment.
  -  **DO NOT** operate equipment with guards removed.
  -  **DO NOT** operate equipment near hot or burning debris or any toxic or explosive materials.
  -  **DO NOT** operate equipment on slopes greater than specified in Specifications section of this manual.
- ALWAYS** remove spark plug wire when servicing equipment to prevent accidental starting.
- ALWAYS** check fuel lines and fittings frequently for cracks or leaks. Replace if necessary.
- ALWAYS** keep hands and feet away from moving or rotating parts.
- ALWAYS** store fuel in approved safety containers.
-  **WARNING: Important**  
Do not run this machine without director cone attached or with improper air director cone.
-  **DO NOT** run this machine with a cracked or damaged impeller under any circumstances.



**INTENDED USE**

This machine is designed for cleaning outdoor surfaces, where the debris can be effectively blown into a consolidated area for convenient pickup and removal. Do not operate if excessive vibration occurs. If excessive vibration occurs, shut engine off immediately and check for damaged or worn impeller, loose impeller bolt, loose impeller key, loose engine or lodged foreign objects. Note: See parts list for proper impeller bolt torque specifications. (See trouble shooting section on page 12).

**INSTRUCTION LABELS**

The labels shown below were installed on your BILLY GOAT® FORCE Blower. If any labels are damaged or missing, replace them before operating this equipment. Item numbers from the Illustrated Parts List and part numbers are provided for convenience in ordering replacement labels. The correct position for each label may be determined by referring to the Figure and Item numbers shown.



LABEL READ OWNERS MANUAL  
ITEM #44 P/N890301



LABEL EAR EYE BREATHING  
ITEM# 45 P/N890254



DANGER FLYING DEBRIS  
ITEM # 46 P/N 810736

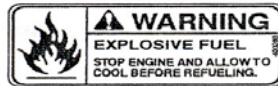

LABEL EXPLOSIVE FUEL  
ITEM # 43 P/N 400268

**ENGINE LABELS**

**BRIGGS AND STRATTON**





## PACKING CHECKLIST

**These items should be included in your carton. If any of these parts are missing, contact your dealer.**  
Your BILLY GOAT® *FORCE Blower* was shipped in one carton, completely assembled except for the Upper Handle Assembly and Front Diverter. Mounting hardware for the Upper Handle Assembly can be found in the parts bag.



**READ** all safety instructions before assembling unit.

**TAKE CAUTION** when removing the unit from the box the Handle Assembly is attached to the unit by cables.



**PUT OIL IN ENGINE BEFORE STARTING**

## PARTS BAG & LITERATURE ASSY

Warranty card P/N- 400972, Owner's Manual P/N-440187, Handle Hardware-Items #10(washer 8171003), #11(locknut 816002). and #36(cap screw 8041032).



### **Boxing Parts Checklist**

- Handle Upper Assembly  
Item #49 P/N-440185
- Parts Bag & Literature Assy  
P/N-440186
- B & S Intek 8 hp manual

**ASSEMBLY**



1. Follow the steps in figures A then securely tighten all hardware shown.
2. Connect spark plug wire.

**Figure A**

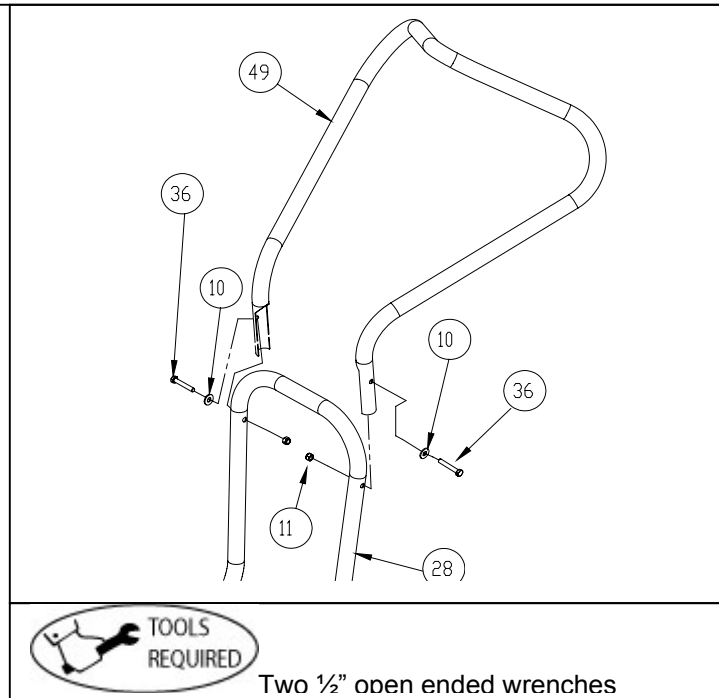
The hardware for attaching the upper handle to the lower is in the parts bag. Install upper handle (item 49), to preassembled lower handle (item 28) by sliding the upper over and down the outside of the lower handle. Using bolt (item #36), washers (item #10) & lock nut (item #11) to install upper handle to lower handle. Finish installing the other side of the upper handle assembly using screw and lock nut provided.



**OPERATION**

 Like all mechanical tools, reasonable care must be used when operating machine.  
**Inspect machine work area and machine before operating. Make sure that all operators of this equipment are trained in general machine use and safety.**  
 **PUT OIL IN ENGINE BEFORE STARTING**

**STARTING**



 **ENGINE:** See engine manufacturer's instructions for type and amount of oil and gasoline used. Engine must be level when checking and filling oil and gasoline.  
**FUEL VALVE:** Move fuel valve to "ON" position (when provided on engine).  
**STOP SWITCH:** Located on the engine. "ON" position.  
**CHOKE:** Operated with choke lever on side of engine.  
**THROTTLE:** Controlled by throttle lever on the engine. Pull starting rope to start engine.  
**ENGINE SPEED:** Under normal conditions, operate at minimum throttle to accomplish your current cleaning task.  
**IF YOUR UNIT FAILS TO START:**  
 See Troubleshooting on page 12.





**HANDLING & TRANSPORTING:**

Using two people to lift machine is recommended. Lift holding the handle and handle brace. Secure in place during transportation. See unit specifications on page 3 for unit weight.

-  Do not use the front grill as an anchor point when securing the unit for transport.
-  Never lift the machine while the engine is running.

**BLOWING OPERATION**

Your Billy Goat Force blower is equipped with an air director cone to allow the operator to direct the air stream up or down as required to assist in moving debris. This feature is extremely useful when debris has piled up to the point that it cannot be blown any farther. The air stream can be directed upward to blow the top of the debris pile over and allow the operator to continue moving more debris farther.

**ADJUSTING AIR DIRECTOR**

To adjust air direction, first loosen knob and then position air director cone to desired angle. When the cone is at a suitable position tighten knob to secure. DO NOT position director cone to where it will blow debris towards people, vehicles or other objects in vicinity. Flying debris may damage, harm, or cause injury to people or objects in air flow range.





**MAINTENANCE**

**PERIODIC MAINTENANCE**

Periodic maintenance should be performed at the following intervals:

Maintenance Operation	Every Use	Daily or Every 5 Hours	Every 25 Hours	Every 50 Hours	Every 100-150 Hours
Inspect for worn or damaged parts.	•				
Check for excessive vibration		•			
Inspect Impeller for cracks or damage					•
Inspect for loose parts.		•			

**IMPELLER REMOVAL**

1. Wait for engine to cool and disconnect spark plug.
2. Remove housing front cover, by removing (11) bolts and nuts, items #13 & #14, around outside of front cover.
3. Remove impeller bolt (item #35), lock washer (item #7) and washer (item #34).
4. DO NOT pry on impeller. Pull on center hub area only of impeller. If impeller slides off freely, proceed to (step 6).
5. If the impeller does not loosen, obtain a 3/4-16x1" (25.4mm) or longer bolt. Thread bolt by hand into nut until bolt rests against the shaft. Tighten the bolt slowly, which will pull the impeller away from the shaft, remove impeller from shaft. *Using a penetrating oil can help loosen a stuck impeller.*
6. Reinstall new impeller in reverse order of removal.
7. Tighten impeller bolt. Torque impeller bolt (see parts list on page 14 for proper impeller bolt torque specifications).

**TIRE AIR PRESSURE**

Check at regular intervals and maintain.

Front Tires - 24 Psi (165 kPa).

Rear Tires - 20 Psi (137 kPa).

**STORAGE**

⚠ Never store engine indoors or in enclosed poorly ventilated areas with fuel in tank, where fuel fumes may reach an open flame, spark or pilot light, as on a furnace, water heater, clothes dryer or other gas appliance.

**If engine is to be unused for 30 days or more, prepare as follows:**

⚠ Remove all gasoline from carburetor and fuel tank to prevent gum deposits from forming on these parts and causing possible malfunction of engine. Drain fuel outdoors, into an approved container, away from open flame. Be sure engine is cool. Do not smoke. Run engine until fuel tank is empty and engine runs out of gasoline.

**NOTE**

Fuel stabilizer (such as Sta-Bil™) is an acceptable alternative for minimizing the formation of gum deposits during storage. Add stabilizer to gasoline in storage container or fuel tank. Follow stabilizer manufacturer's instructions to determine proper mix ratio. Run engine at least 10 minutes after adding stabilizer to allow it to reach carburetor.



**TROUBLESHOOTING**

Problem	Possible Cause	Solution
Abnormal vibration.	<ul style="list-style-type: none"> <li>· Loose or out of balance impeller.</li> <li>· Loose engine.</li> </ul>	<ul style="list-style-type: none"> <li>· Check impeller and replace if required.</li> <li>· Check engine.</li> </ul>
Engine will not start.	<ul style="list-style-type: none"> <li>· Engine not in full choke position.</li> <li>· Out of gasoline or bad, old gasoline.</li> <li>· Spark Plug wire disconnected.</li> <li>· Gas valve off.</li> <li>· Dirty air cleaner.</li> </ul>	<ul style="list-style-type: none"> <li>· Check choke position.</li> <li>· Check gasoline.</li> <li>· Connect spark plug wire.</li> <li>· Turn on gas valve.</li> <li>· Clean or replace air cleaner. Contact a qualified service person.</li> </ul>
Engine is locked, will not pull over.	<ul style="list-style-type: none"> <li>· Engine problem.</li> </ul>	<ul style="list-style-type: none"> <li>· Contact an engine servicing dealer for engine problems.</li> </ul>

When servicing engine refer to specific manufacturers engine owner's manual. Engine warranty is covered by the specific engine manufacturer. If your engine requires warranty or other repair work contact your local servicing engine dealer. When contacting a dealer for service it is a good idea to have your engine model number available for reference (See table page 3). If you cannot locate a servicing dealer in your area you can contact the manufacturers national service organization.

To reach:

**Briggs and Stratton: 800-223-3723**

**WARRANTY CLAIM PROCEDURE**

Should a BILLY GOAT<sup>®</sup> machine fail due to a defect in material and/or workmanship, the owner should make a warranty claim as follows:

- The machine must be taken to the dealer from whom it was purchased or to an authorized Servicing BILLY GOAT Dealer.
- The owner must present the remaining half of the Warranty Registration Card, or, if this is not available, the invoice or receipt.
- The Warranty Claim will be completed by the authorized BILLY GOAT Dealer and submitted to their respective BILLY GOAT Distributor for their territory Attention: Service Manager. Any parts replaced under warranty must be tagged and retained for 90 days. The model number and serial number of the unit must be stated in the Warranty Claim.
- The distributor service manager will sign off on the claim and submit it to BILLY GOAT for consideration.
- The Technical Service Department at BILLY GOAT will study the claim and may request parts to be returned for examination. BILLY GOAT will notify their conclusions to the distributor service manager from whom the claim was received.
- The decision by the Technical Service Department at BILLY GOAT to approve or reject a Warranty Claim is final and binding.

For online product registration go to [www.billygoat.com](http://www.billygoat.com)

**ILLUSTRATED PARTS LIST**

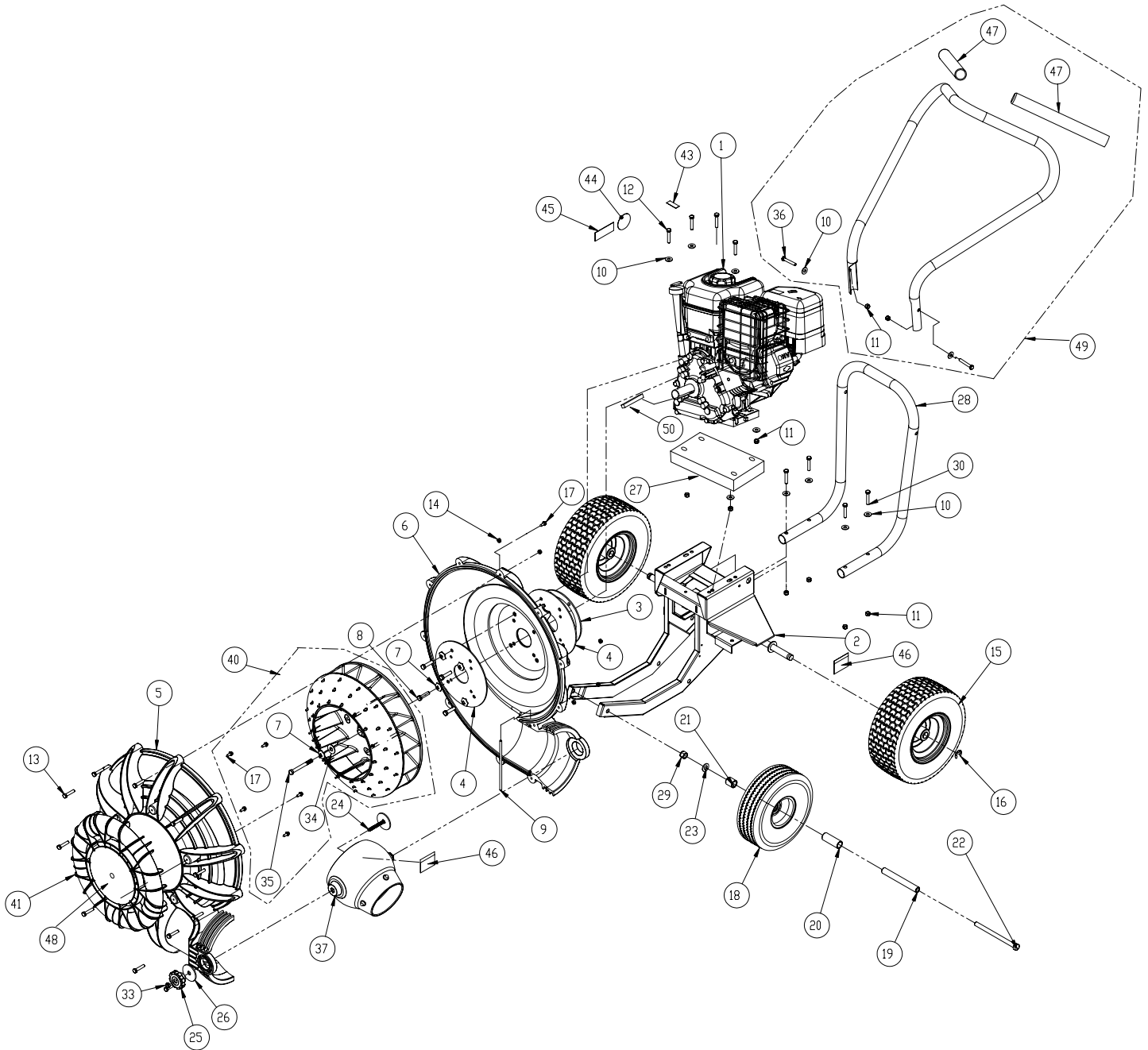



## FORCE BLOWER 8 Owner's Manual

### PARTS LIST

F800			
ITEM NO.	DESCRIPTION	PART NUMBER	QTY.
1	ENGINE 8 HP B&S	440181	1
2	BASE ENGINE WA	440011	1
3	SPACER RING ENGINE	440009	1
4	PLATE REINFORCE HOUSING	440010	2
5	HOUSING FRONT MOLDED	440023	1
6	HOUSING BACK MOLDED	440024	1
7	WASHER LOCK 3/8 TWISTED TOOTH	400502	4
	WASHER LOCK 7/16 S/T MED	8177013	1
8	SCREW CAP 3/8-16X1 1/2 ZP	8041052	4
9	ROD HAND STOP	440057	1
10	WASHER 5/16 FLATWASHER Z/P	8171003	16
11	NYLON INSERT LOCKNUT 5/16-18	8160002	10
12	SCREWCAP 5/16-18 X 2.5 ZP	8041034	4
13	SCREWCAP 1/4-20 x 1 1/2	8041008	11
14	NUT FLANGE 1/4-20	900455	11
15	WHEEL & TIRE 13" X 5" PNEUMATIC	440054	2
16	RING RETAINING 3/4	850230	2
17	SCREW SELF-TAP 5/16 NC X 3/4 HEX	8122082	7
18	WHEEL ASSY 10 " PNEUMATIC	400295	1
19	SPACER FRONT AXLE	440050	1
20	SPACER LH WHEEL	440052	1
21	SPACER RH WHEEL	440051	1
22	SCREWCAP 1/2-13 x 7"	8041235	1
23	WASHER FLAT 1/2" SAE	8172011	1
24	WASHER W/BOLT WA	440075	1
25	KNOB 3/8-16 SOLID HUB	811230	1
26	WASHER 2.25 OD x .515 ID x .134 ZP	610308-P	1
27	ENGINE SPACER	430355	1
28	HANDLE LOWER	440034	1
29	NYLON INSERT LOCKNUT 1/2-13	8160005	1
30	SCREWCAP 5/16-18 X 1.75 ZP	8041031	4
31			
32			
33	NUT LOCK 3/8-16 LT WT THIN ZP	8161042	1
34	WASHER 1.5 O.D.X 0.45 I.D. X 0.25	440153	2
35	SCREWCAP 7/16-20 X 3.5 GR.8 60ft-lbs	440150	1
36	SCREWCAP 5/16"-18 X 2" ZP	8041032	2
37	DIRECTOR CONE 4"	440046	1
		-	-
38			
39			
40	IMPELLER ASSEMBLY 17"	440110	1
41	GRILL FRONT BLOWER	440112	1
42			
43	LABEL HOT ENGINE	400268	1
44	LABEL READ	890301	1
45	LABEL EAR EYE BREATHING	890254	1
46	LABEL DANGER FLYING DEBRIS	810736	1
47	GRIP 1-1/4" ID x 13"	440012	2
48	LABEL FORCE	440182	1
49	HANDLE ASSY UPPER	440185	1
50	Key 1/4" SQ x 2.25	9201123	1



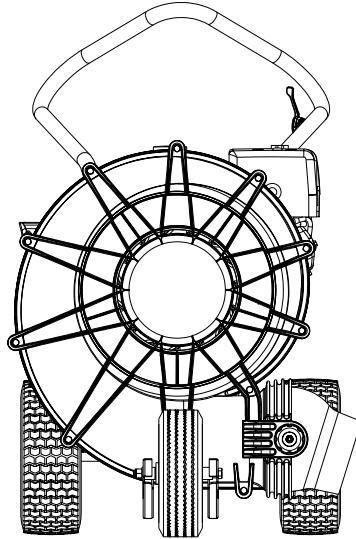

**FORCE BLOWER**

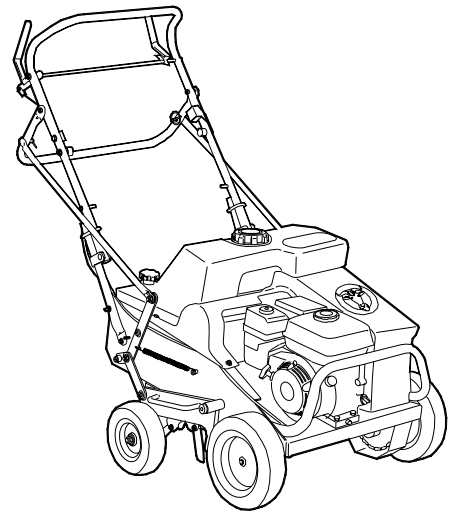

**AERATOR**

**BRUSH CUTTER**

If you liked this product please feel free to view our full line of quality lawn care, renovation, and debris removal products at [www.billygoat.com](http://www.billygoat.com)

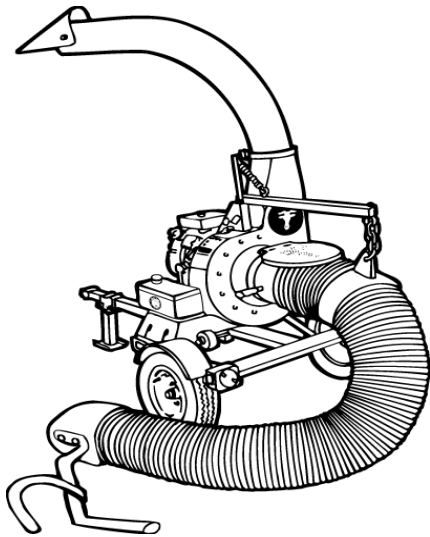

**QL VACUUM**

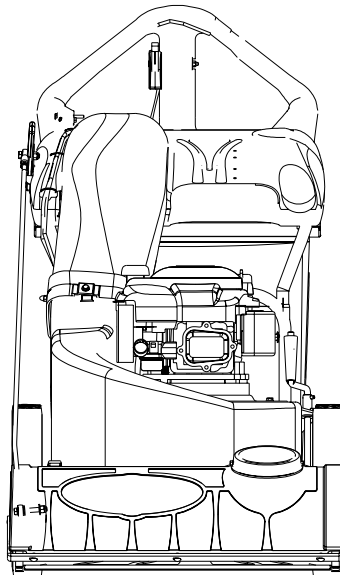

**MULTI VACUUM**

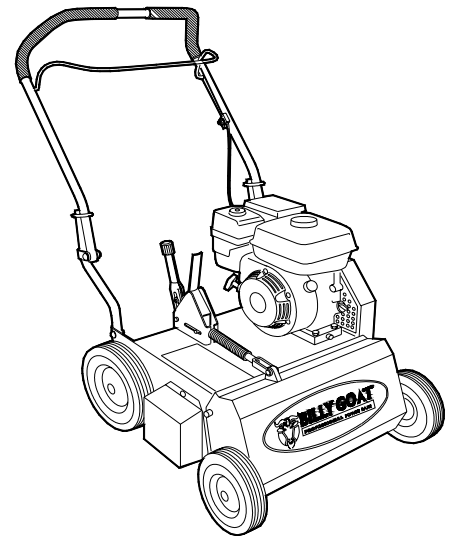

**POWER RAKE**

