

BiPAC 5200N

802.11n draft ADSL2+ Firewall Router

User Manual

Table of Content

Chapter 1	1
1.1 Introducing the BiPAC 5200N	1
1.2 Features of the BiPAC 5200N.....	3
1.3 Applications for the BiPAC 5200N	5
Chapter 2	6
2.1 Important note for using the BiPAC 5200N	6
2.2 Package Contents	6
2.3 The Front LEDs	7
2.4 The Rear Ports	8
2.5 Cabling	8
Chapter 3	10
3.1 Before Configuration	10
3.2 Step-by-Step Installation	15
3.3 Factory Default Settings	19
3.4 LAN and WAN Port Addresses	20
3.5 Information from your ISP	20
3.6 Configuring with your Web Browser	21
Chapter 4	22
4.1 Quick Start	23
4.2 Interface Setup	28
4.3 Advanced Setup.....	39
4.4 Access Management	51
4.5 Maintenance	59
4.6 Status.....	64
4.7 Help	69
Chapter 5	70
APPENDIX	72

1.1 Introducing the BiPAC 5200N

Welcome to the Billion BiPAC 5200N ADSL2+ Modem/Router. Your Billion router is an “all-in-one” unit, combining an ADSL modem, ADSL router and Ethernet network switch, providing everything you need to get the machines on your network connected to the Internet over your ADSL broadband connection.

The BiPAC 5200N complies with ADSL2+ standards for worldwide deployment and supports downstream rates of up to 24 Mbps and upstream rates of up to 1 Mbps. It is designed for small office, home office and residential users, enabling even faster speed Internet connections. User can enjoy ADSL services and broadband multimedia applications such as interactive gaming, video streaming and real-time audio much easier and faster than ever before.

The product supports PPPoA (RFC 2364 – PPP (Point-to-Point Protocol) over ATM Adaptation Layer 5), RFC 1483 encapsulation over ATM (bridged or routed), PPP over Ethernet (RFC 2516), and IPoA (RFC1577) to establish a connection with ISP. The product also supports VC-based and LLC-based multiplexing.

It is the perfect solution to connect a small group of PCs to a high-speed broadband Internet connection. Multi-users can have high-speed Internet access simultaneously.

This product also serves as an Internet firewall, protecting your network from being accessed by outside users. Not only provide the natural firewall function (Network Address Translation, NAT), it also provides rich firewall features to secure user’s network. All incoming data packets are monitored and filtered. Besides, it can also be configured to block internal users from accessing to the Internet.

The product provides two levels of security support. First, it masks LAN users’ IP addresses which are invisible to outside users on the Internet, making it much more difficult for a hacker

to target a machine on your network. Secondly, it can block and redirect certain ports to limit the services that outside users can access. For example, to ensure that games and other Internet applications will run properly, user can open some specific ports for outside users to access internal services in network.

Integrated DHCP (Dynamic Host Control Protocol) services, client and server, allow multiple users to get their IP addresses automatically on boot up from the product. Simply set local machines as a DHCP client to accept a dynamically assigned IP address from DHCP server and reboot. Each time local machine is powered up; the router will recognize it and assign an IP address to instantly connect it to the LAN.

For advanced users, Virtual Service function allows the product to provide limited visibility to local machines with specific services for outside users. An ISP (Internet Service Providers) provided IP address can be set to the product and then specific services can be rerouted to specific computers on the local network. For instance, a dedicated web server can be connected to the Internet via the product and then incoming requests for HTML that are received by the product can be rerouted to the dedicated local web server, even though the server now has a different IP address. In this example, the product is on the Internet and vulnerable to attacks, but the server is protected.

Virtual Server can also be used to re-task services to multiple servers. For instance, the product can be set to allow separated FTP, Web, and Multiplayer game servers to share the same Internet-visible IP address while still protecting the servers and LAN users from hackers.

1.2 Features of the BiPAC 5200N

● **ADSL Multi-Mode Standard**

Supports downstream rates of up to 24 Mbps and upstream rates of up to 1 Mbps. It also supports rate management that allows ADSL subscribers to select an Internet access speed suiting their needs and budgets. It is compliant with Multi-Mode standard (ANSI T1.413, Issue 2; G.dmt(G.992.1); G.lite(G992.2)), G.hs (G994.1), G.dmt.bis (G.992.3), G.dmt.bisplus (G.992.5)). The Annex A and B are supported in different H/W platforms.

● **Wireless Ethernet 802.11n**

With built-in 802.11n access point for extending the communication media to WLAN while providing the WEP, WPA and WPA2 for securing your wireless networks.

● **Fast Ethernet Switch**

A 10/100Mbps fast Ethernet switch is built in with automatic switching between MDI and MDI-X for 10Base-T and 100Base-TX ports. An Ethernet straight or cross-over cable can be used directly for auto detection.

● **Multi-Protocol to Establish A Connection**

Supports PPPoA (RFC 2364 - PPP over ATM Adaptation Layer 5), RFC 1483 encapsulation over ATM (bridged or routed), PPP over Ethernet (RFC 2516) and IPoA (RFC1577) to establish a connection with the ISP. The product also supports VC-based and LLC-based multiplexing.

● **Quick Installation Wizard**

Supports a WEB GUI page to install this device quickly. With this wizard, end users can enter the information easily which they get from their ISP, then surf the Internet immediately.

● **Universal Plug and Play (UPnP) and UPnP NAT Traversal**

This protocol is used to enable simple and robust connectivity among stand-alone devices and PCs from many different vendors. It makes network simple and affordable for users. UPnP architecture leverages TCP/IP and the Web to enable seamless proximity networking in addition to control and data transfer among networked devices. With this feature enabled, users can now connect to Net meeting or MSN Messenger seamlessly.

● **Network Address Translation (NAT)**

Allows multi-users to access outside resources such as the Internet simultaneously with one IP address/one Internet access account. Many application layer gateway (ALG) are supported such as web browser, ICQ, FTP, Telnet, E-mail, News, Net2phone, Ping, NetMeeting, IP phone and others.

● Firewall

Supports simple firewall with NAT technology and provides option for blocking access from Internet, like Telnet, FTP, WEB, SNMP and IGMP.

● Domain Name System (DNS) relay

Provides an easy way to map the domain name (a friendly name for users such as www.yahoo.com) and IP address. When a local machine sets its DNS server with this router's IP address, every DNS conversion request packet from the PC to this router will be forwarded to the real DNS in the outside network.

● Dynamic Domain Name System (DDNS)

The Dynamic DNS service allows you to alias a dynamic IP address to a static hostname. This dynamic IP address is the WAN IP address. For example, to use the service, you must first apply for an account from a DDNS service like <http://www.dyndns.org/>.

● PPP over Ethernet (PPPoE)

Provides embedded PPPoE client function to establish a connection. Users can get greater access speed without changing the operation concept, sharing the same ISP account and paying for one access account. No PPPoE client software is required for local computer. The Automatic Reconnect and Disconnect Timeout (Idle Timer) functions are provided, too.

● Virtual Server

User can specify some services to be visible from outside users. The router can detect incoming service request and forward it to the specific local computer to handle it. For example, user can assign a PC in LAN acting as WEB server inside and expose it to the outside network. Outside user can browse inside web server directly while it is protected by NAT. A DMZ host setting is also provided to a local computer exposed to the outside network, Internet.

● Dynamic Host Configuration Protocol (DHCP) client and server

In the WAN site, the DHCP client can get an IP address from the Internet Service Provider (ISP) automatically. In the LAN site, the DHCP server can allocate a range of client IP addresses and distribute them including IP address, subnet mask as well as DNS IP address to local computers. It provides an easy way to manage the local IP network.

● RIP1/2 Routing

Supports RIP1/2 routing protocol for routing capability.

● Simple Network Management Protocol (SNMP)

It is an easy way to remotely manage the router via SNMP.

● Web based GUI

Supports web based GUI for configuration and management. It is user-friendly and comes

with on-line help. It also supports remote management capability for remote users to configure and manage this product.

● Firmware Upgradeable

Device can be upgraded to the latest firmware through the WEB based GUI.

1.3 Applications for the BiPAC 5200N

BiPAC 5200N

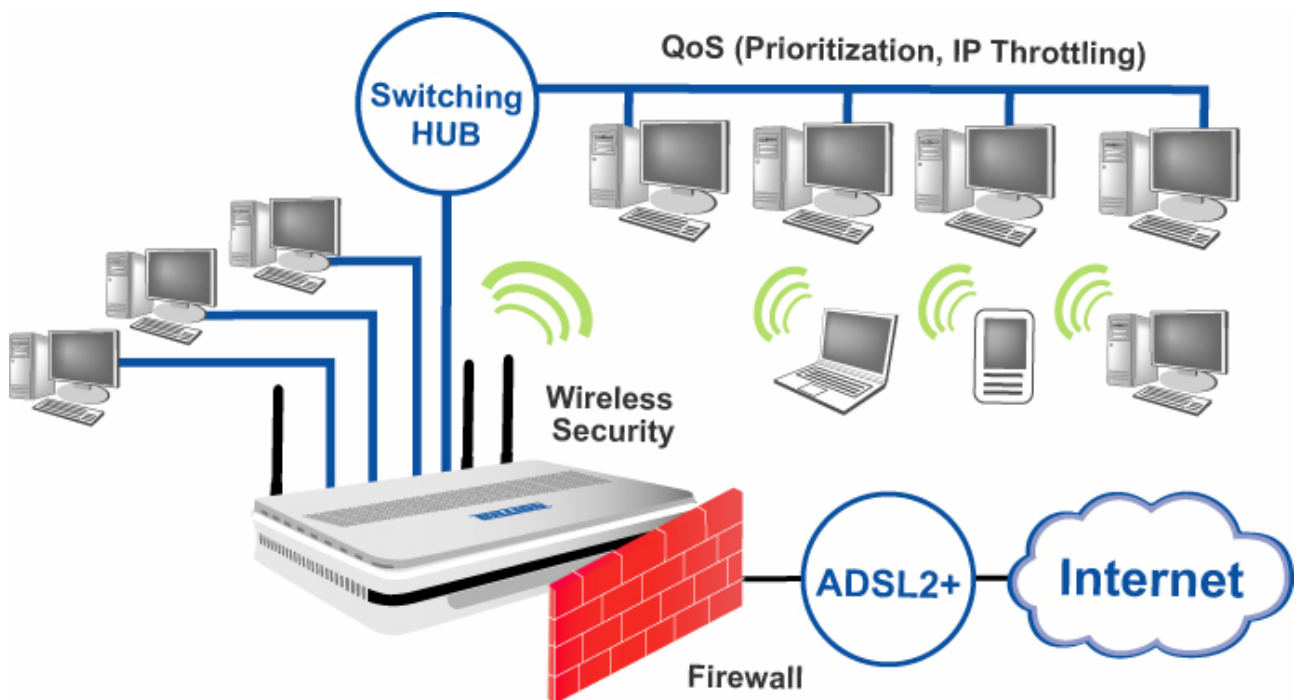

2.1 Important note for using the BiPAC 5200N



Warning

- ✓ Do not use the BiPAC 5200N in high humidity or high temperatures.
- ✓ Do not use the same power source for the BiPAC 5200N as other equipment.
- ✓ Do not open or repair the case yourself. If the BiPAC 5200N is too hot, turn off the power immediately and have it repaired at a qualified service center.
- ✓ Avoid using this product and all accessories outdoors.



Attention

- ✓ Place the BiPAC 5200N on a stable surface.
- ✓ Only use the power adapter that comes with the package. Using a different voltage rating power adaptor may damage the router.

2.2 Package Contents

- **BiPAC 5200N ADSL2+ Router**
- **CD-ROM containing the online manual**
- **RJ-11 ADSL/telephone Cable (1.8M)**
- **Ethernet (CAT-5 LAN) Cable (1.8M Straight)**
- **AC-AD power adapter (12V DC, 1A): for 5200N**
- **Quick Start Guide (105*150*mm)**

2.3 The Front LEDs

BiPAC 5200N

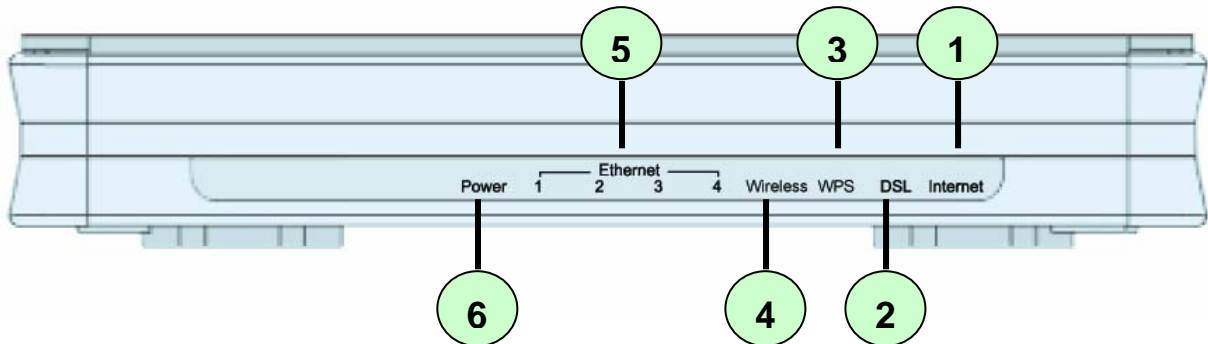

LED		Meaning
1	Internet :	<ul style="list-style-type: none"> ● Lit red when WAN port fails to get IP address. ● Lit green when WAN port gets IP address successfully.
2	DSL:	<ul style="list-style-type: none"> ● Lit when successfully connected to an ADSL DSLAM ("linesync").
3.	WPS: (Future Release)	<ul style="list-style-type: none"> ● LED flashes when WPS is in progress. ● When WPS ends the LED light will lit up brightly and then the light will turn off in 5 seconds.
4	Wireless:	<ul style="list-style-type: none"> ● Lit green when the wireless connection is established. ● Flashes when sending/receiving data.
5	Ethernet Port 1-4:	<ul style="list-style-type: none"> ● Lit when connected to an Ethernet device. ● Green for 100Mbps; Orange for 10Mbps. ● Blinking when data is Transmitted / Received.
6	Power :	<ul style="list-style-type: none"> ● When the power is plugged in, it will lit Red and when the system is ready, it will lit Green. Whilst the system is rebooting or firmware upgrading, the LED light flashes.

2.4 The Rear Ports

BiPAC 5200N

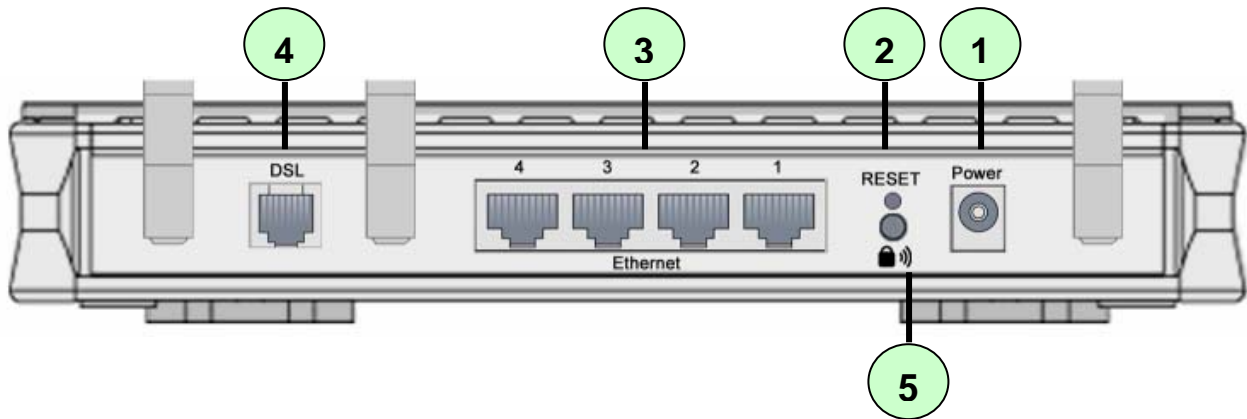

Port		Meaning
1	PWR	Connect the supplied power adapter to this jack.
2	RESET	After the device is powered on, press it to reset the device or restore to factory default settings. 0-3 seconds: reset the device 6 seconds above: restore to factory default settings (this is used when you can not login to the router, e.g. forgot the password)
3	LAN	Connect a UTP Ethernet cable (Cat-5 or Cat-5e) to one of the four LAN ports when connecting to a PC or an office/home network of 10Mbps or 100Mbps.
4	ADSL (LINE)	Connect the supplied RJ-11 (“telephone”) cable to this port when connecting to the ADSL/telephone network.
5	WPS Switch (Future Release)	Push the WPS button to trigger the Wi-Fi Protected Setup function.

2.5 Cabling

One of the most common causes of problems is bad cabling or ADSL line(s). Make sure that all connected devices are turned on. On the front of the product is a bank of LEDs. Verify that the LAN Link and ADSL line LEDs are lit. If they are not, verify that you are using the proper cables.

Ensure that all other devices connected to the same telephone line as your Billion router (e.g. telephones, fax machines, analogue modems) have a line filter connected between them and the wall socket (unless you are using a Central Splitter or Central Filter installed by a qualified and licensed electrician), and ensure that all line filters are correctly installed and the right way around. Missing line filters or line filters installed the wrong way around can cause problems with your ADSL connection, including causing frequent disconnections

Chapter 3

Basic Installation

The router can be configured with your web browser. A web browser is included as a standard application in the following operating systems: Windows 98/NT/2000/XP/Me, MAC, Linux, etc. The product provides a very easy and user-friendly interface for configuration.

3.1 Before Configuration

PCs must have an Ethernet interface installed properly and be connected to the router either directly or through an external repeater hub, and have TCP/IP installed and configured to obtain an IP address through a DHCP server or a fixed IP address that must be in the same subnet as the router. The default IP address of the router is **192.168.1.254** and the subnet mask is **255.255.255.0** (i.e. any attached PC must be in the same subnet, and have an IP address in the range of 192.168.1.1 to 192.168.1.253). The best and easiest way is to configure the PC to get an IP address automatically from the router using DHCP. If you encounter any problems accessing the router's web interface it may also be advisable to **uninstall** any kind of software firewall on your PCs, as they can cause problems accessing the 192.168.1.254 IP address of the router. Users should make their own decisions on how to best protect their network.

Please follow the steps below for your PC's network environment installation. First of all, please check your PC's network components. The TCP/IP protocol stack and Ethernet network adapter must be installed. If not, please refer to your Windows-related or other operating system manuals.



Any TCP/IP capable workstation can be used to communicate with or through the BiPAC 5200N. To configure other types of workstations, please consult the manufacturer's documentation.

Configuring PC in Windows XP

1. Go to **Start / Control Panel (in Classic View)**. In the Control Panel, double-click on **Network Connections**
2. Double-click **Local Area Connection**.
3. In the **Local Area Connection Status** window, click **Properties**.
4. Select **Internet Protocol (TCP/IP)** and click **Properties**.
5. Select the **Obtain an IP address automatically** and the **Obtain DNS server address automatically** radio buttons.
6. Click **OK** to finish the configuration.

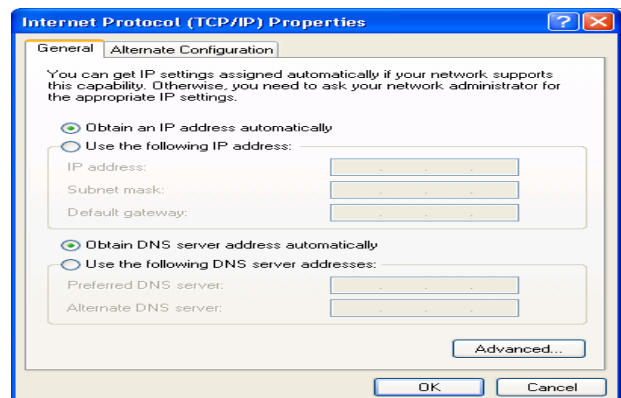
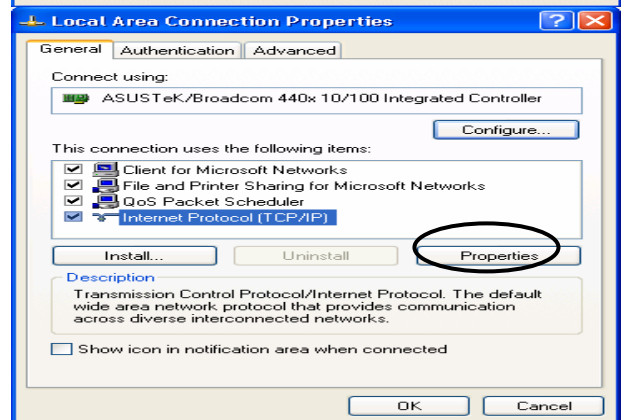
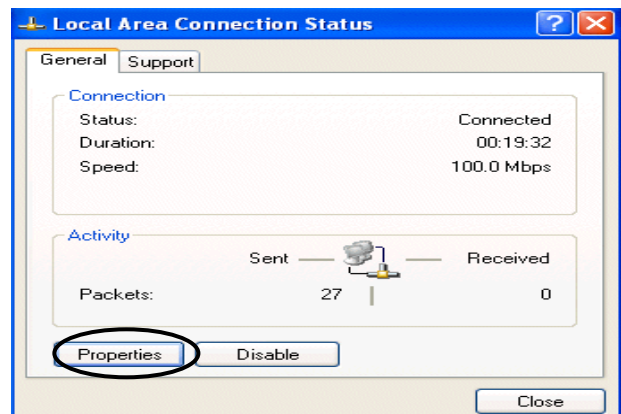
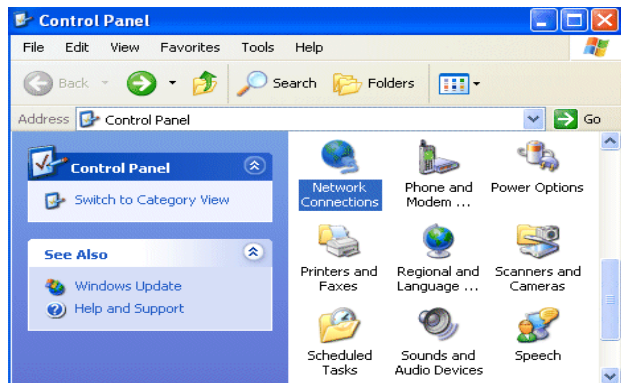

Configuring PC in Windows 2000

1. Go to **Start / Settings / Control Panel**. In the Control Panel, double-click on **Network and Dial-up Connections**.
2. Double-click **Local Area Connection**.

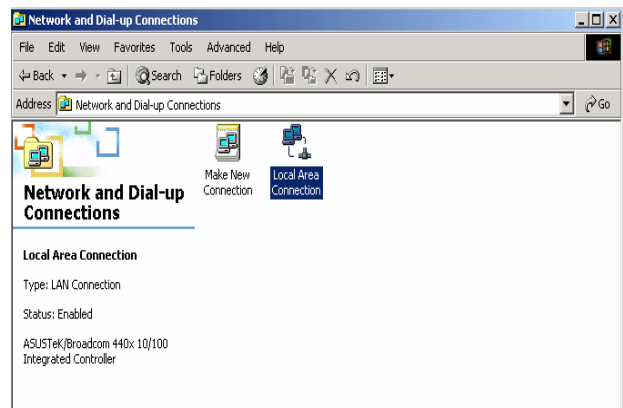

3. In the **Local Area Connection Status** window click **Properties**.

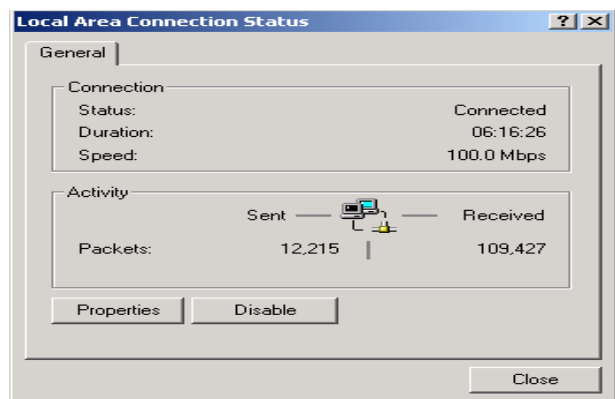

4. Select **Internet Protocol (TCP/IP)** and click **Properties**.

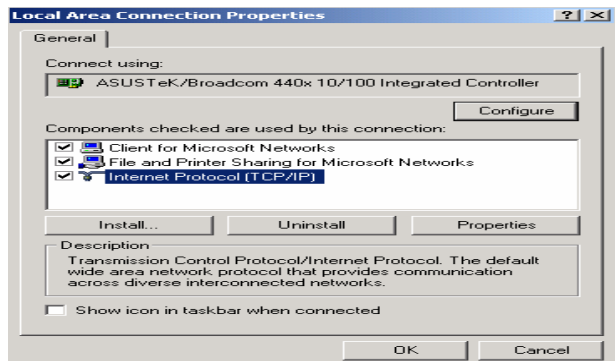

5. Select the **Obtain an IP address automatically** and the **Obtain DNS server address automatically** radio buttons.

6. Click **OK** to finish the configuration.

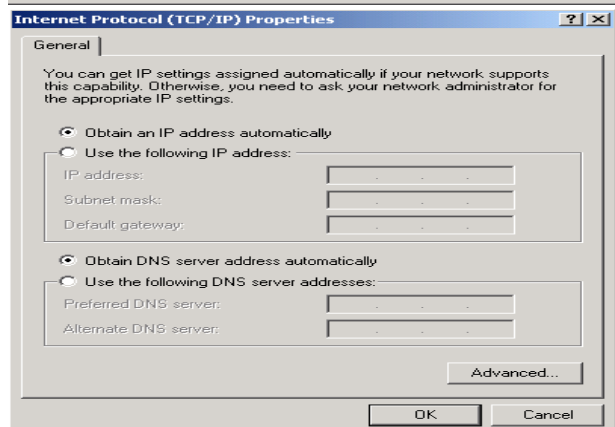

Configuring PC in Windows 98/Me

1. Go to **Start / Settings / Control Panel**. In the Control Panel, double-click on **Network** and choose the **Configuration** tab.
2. Select **TCP/IP ->NE2000 Compatible**, or the name of your Network Interface Card (NIC) in your PC.

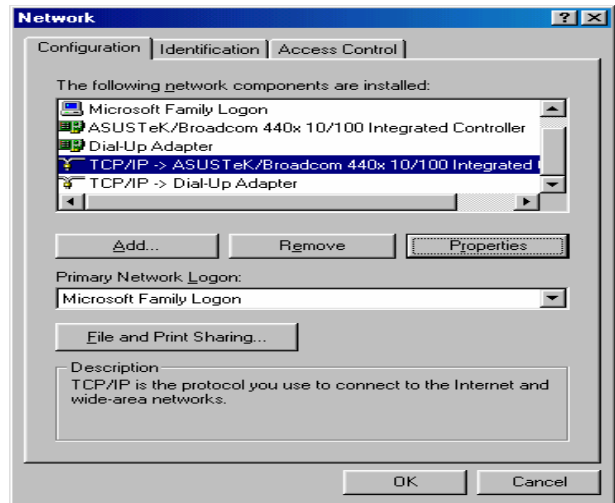

3. Select the **Obtain an IP address automatically** radio button.

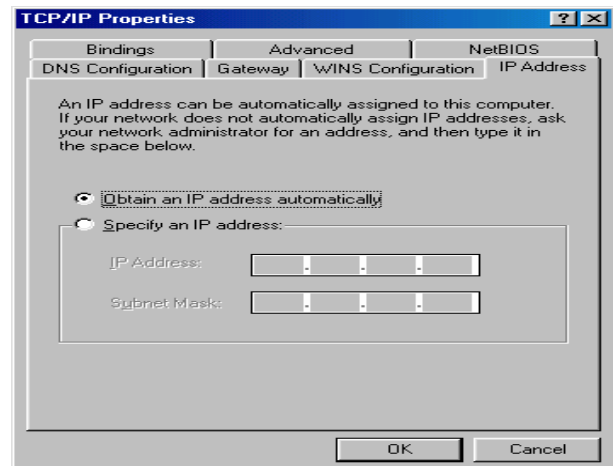

4. Then select the **DNS Configuration** tab.
5. Select the **Disable DNS** radio button and click **OK** to finish the configuration.

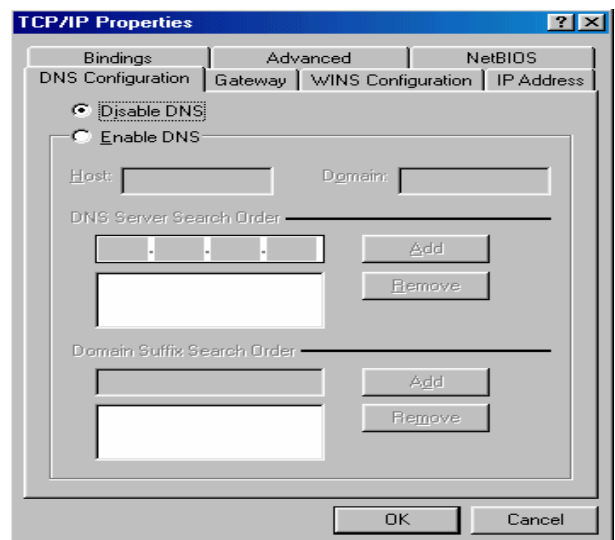

Configuring PC in Windows NT4.0

1. Go to **Start / Settings / Control Panel**. In the Control Panel, double-click on **Network** and choose the **Protocols** tab.
2. Select **TCP/IP Protocol** and click **Properties**.

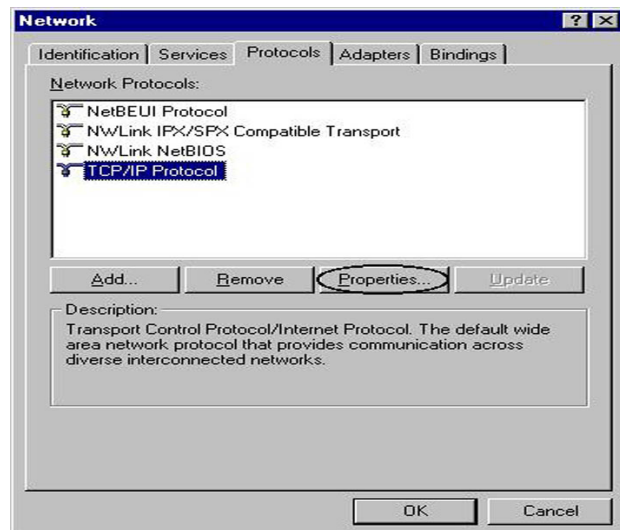

3. Select the **Obtain an IP address from a DHCP server** radio button and click **OK**.

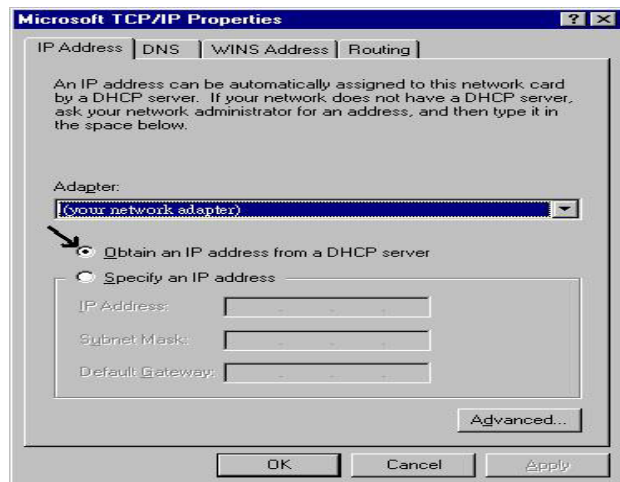

3.2 Step-by-Step Installation

1. Insert the CD-ROM into CD-ROM drive
2. Execute Windows Utility
3. The Welcome screen will appear, click Next



4. The Hardware Installation screen will appear. Four links are shown on the screen. Click them one by one and follow the guidelines to complete hardware installation.

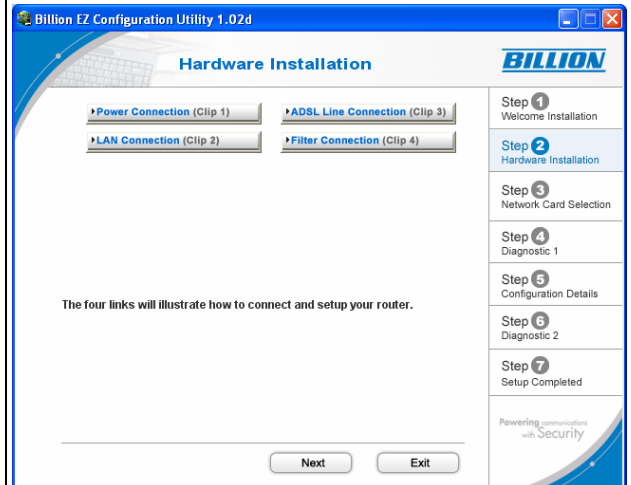

4.1 Power connection

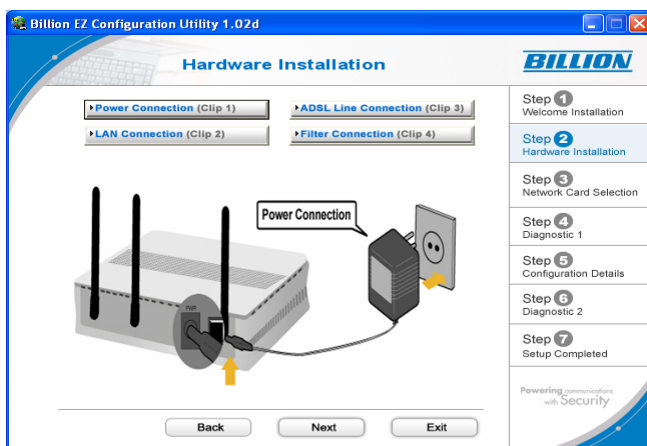

4.2 LAN connection

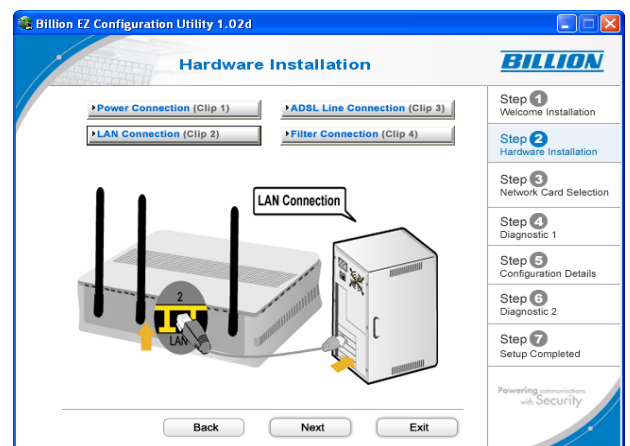

4.3 ADSL Line connection

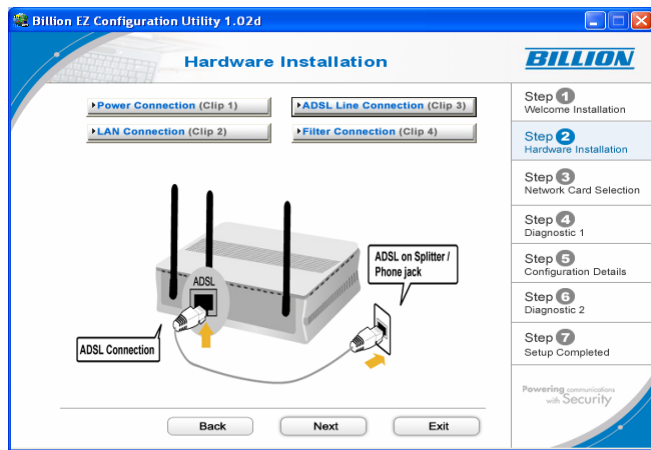

4.4 Filter connection

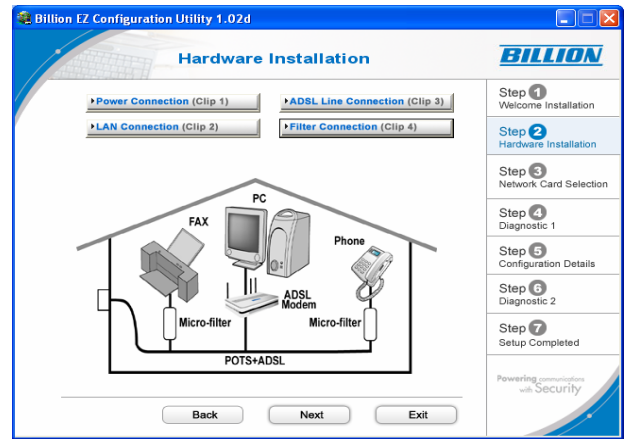

5. When finished Hardware Installation, click "Next" to proceed to next step, Network Card Selection.

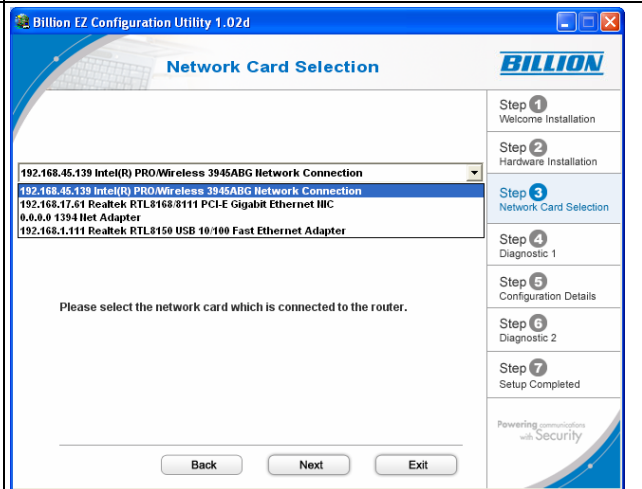

6. Diagnostic screen.
(If connection fails, the screen will show "FAIL", please check your router is connected correctly.)
7. Click Next to enter Configuration Details

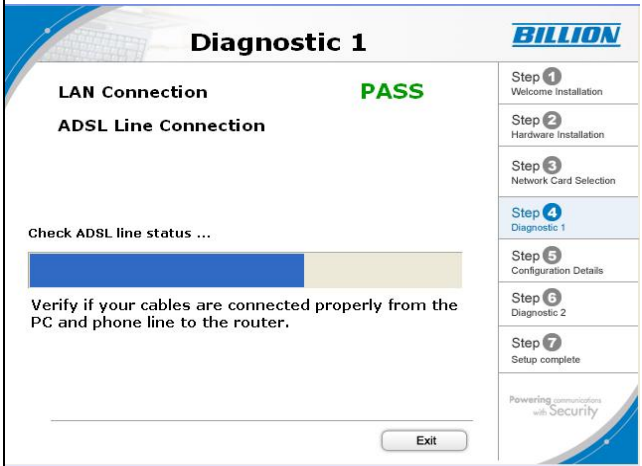

8. Set up more detailed settings such as VPI, VCI and MTU.

Configuration Details

Please choose your country and ISP (Internet Service Provider) from the list below, and then click Next to continue.

ISP Country:

ISP:

Protocol:

VPI:

VCI:

MTU:

Next Exit

Step 1 Welcome Installation
Step 2 Hardware Installation
Step 3 Network Card Selection
Step 4 Diagnostic 1
Step 5 Configuration Details
Step 6 Diagnostic 2
Step 7 Setup complete

Powering communications with Security

9. Please enter “Username” and “Password” as supplied by your ISP (Internet Service Provider) and click next.

Configuration Details

Please enter your Username and Password as supplied by your Internet Service Provider (ISP) and click Next.

Username:

Password:

Confirmed Password:

Back Next Exit

Step 1 Welcome Installation
Step 2 Hardware Installation
Step 3 Network Card Selection
Step 4 Diagnostic 1
Step 5 Configuration Details
Step 6 Diagnostic 2
Step 7 Setup complete

Powering communications with Security

10. Please configure the Wireless LAN setting and click next.
(If your router does not support wireless, please ignore this screen and it will not appear.)

Configuration Details

Please configure the Wireless LAN settings and click Next

ESSID Broadcast: Enable Disable

SSID:

Channel ID:

Authentication Type:

Back Next Exit

Step 1 Welcome Installation
Step 2 Hardware Installation
Step 3 Network Card Selection
Step 4 Diagnostic 1
Step 5 Configuration Details
Step 6 Diagnostic 2
Step 7 Setup complete

Powering communications with Security

11. Click Next to proceed to Diagnostic screen

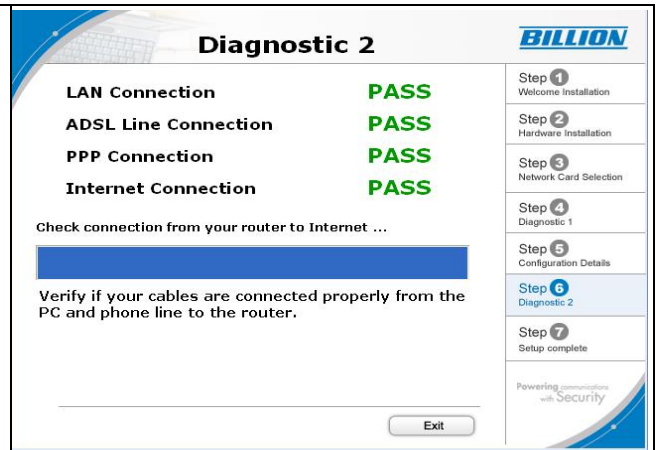

12. Congratulations!! You've completed the setup procedure and are ready for surfing the Internet.

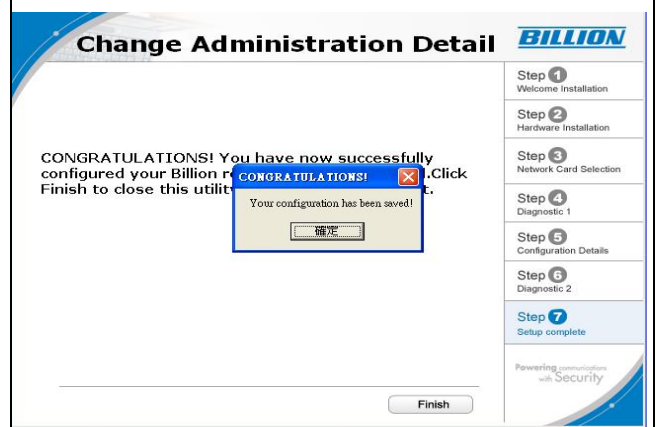

13. The IE browser will be opened automatically when you finish installing.



3.3 Factory Default Settings

Before configuring your, you need to know the following default settings.

● Web Interface:

- ✘ Username: admin
- ✘ Password: admin

● LAN Device IP Settings:

- ✘ IP Address: 192.168.1.254
- ✘ Subnet Mask: 255.255.255.0

● ISP setting in WAN site:

- ✘ PPPoE

● DHCP server:

- ✘ DHCP server is enabled.
- ✘ Start IP Address: 192.168.1.100
- ✘ IP pool counts: 100

3.3.1 Username and Password

The default username and password are “**admin**” and “**admin**” respectively.



Attention

If you ever forget the password to log in, you may press the RESET button up to 6 seconds to restore the factory default settings.

3.4 LAN and WAN Port Addresses

The parameters of LAN and WAN ports are pre-set in the factory. The default values are shown below.

LAN Port		WAN Port
IP address	192.168.1.254	The PPPoE function is <i>enabled</i> to automatically get the WAN port configuration from the ISP, but you have to set the username and password first.
Subnet Mask	255.255.255.0	
DHCP server function	Enabled	
IP addresses for distribution to PCs	100 IP addresses continuing from 192.168.1.100 through 192.168.1.199	

3.5 Information from your ISP

Before configuring this device, you have to check with your ISP (Internet Service Provider) what kind of service is provided such as PPPoE, PPPoA, RFC1483, or IPoA.

Gather the information as illustrated in the following table and keep it for reference.

PPPoE	VPI/VCI, VC-based/LLC-based multiplexing, Username, Password, Service Name, and Domain Name System (DNS) IP address (it can be automatically assigned by your ISP when you connect or be set manually).
PPPoA	VPI/VCI, VC-based/LLC-based multiplexing, Username, Password, and Domain Name System (DNS) IP address (it can be automatically assigned by your ISP when you connect or be set manually).
RFC1483 Bridged	VPI/VCI, VC-based/LLC-based multiplexing to use Bridged Mode.
RFC1483 Routed	VPI/VCI, VC-based/LLC-based multiplexing, IP address, Subnet mask, Gateway address, and Domain Name System (DNS) IP address (it is fixed IP address).

3.6 Configuring with your Web Browser

Open your web browser, enter the IP address of your router, which by default is **192.168.1.254**, and click “Go”, a user name and password window prompt will appear. **The default username and password are “admin” and “admin”.**

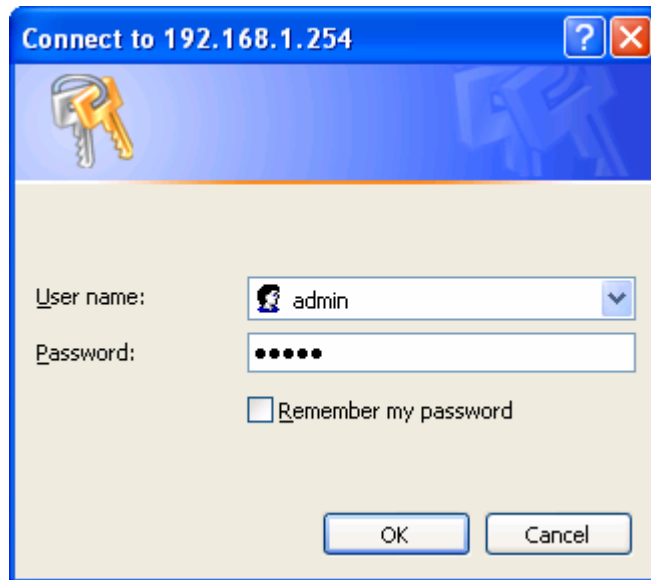

Congratulation! You are now successfully logon to the BiPAC 5200N ADSL2+ Router!

Chapter 4

Configuration

At the configuration homepage, the left navigation pane where bookmarks are provided links you directly to the desired setup page, including:

- **Quick Start** (wizard setup)
- **Interface Setup** (Internet, LAN, Wireless)
- **Advanced Setup** (Firewall, Routing, NAT, QoS, ADSL)
- **Access Management** (ACL, Filter, SNMP, UPnP, DDNS)
- **Maintenance** (Administration, Time Zone, Firmware, SysRestart, Diagnostics)
- **Status** (Device Info, System Log, Statistics)
- **Help**

Please see the relevant sections of this manual for detailed instructions on how to configure your Billion router.

4.1 Quick Start

The screenshot displays the web interface for a BILLION ADSL Modem/Router. At the top left is the BILLION logo. To the right, the text "ADSL Modem/Router" is displayed. Below the logo and text is a navigation menu with the following items: Quick Start, Interface Setup, Advanced Setup, Access Management, Maintenance, Status, and Help. The "Quick Start" item is highlighted in a darker blue. Below the navigation menu is a main content area with a sub-header "Quick Start". The main content area contains the following text: "This ADSL Router is ideal for home networking and small business networking. The 'Quick Start' wizard will guide you to configure the ADSL router to connect to your ISP (Internet Service Provider). The router's easy Quick Start will allow you to have Internet access within minutes. Please follow the 'Quick Start' wizard step by step to configure the ADSL Router." At the bottom of the main content area is a button labeled "RUN WIZARD".

For detailed instructions on configuring WAN settings, see the **Interface Setup** section of this manual.

The Quick Start Wizard is a useful and easy utility to help setup the device to quickly connect to your ISP (Internet Service Provider) with only a few steps required. It will guide you step by step to configure the password, time zone, and WAN settings of your device. The Quick Start Wizard is a helpful guide for first time users to the device.



Quick Start

The Wizard will guide you through these four quick steps. Begin by clicking on **NEXT**.

- Step 1. Set your new password
- Step 2. Choose your time zone
- Step 3. Set your Internet connection
- Step 4. Re-start your ADSL router

NEXT EXIT

Step1. Set your new password.



Quick Start - Password

You may change the **admin** account password by entering in a new password. Click **NEXT** to continue.

New Password :

Confirmed Password :

BACK NEXT EXIT

Step2: Choose your time zone



Quick Start - Time Zone

Select the appropriate time zone for your location and click **NEXT** to continue.

(GMT) Greenwich Mean Time : Dublin, Edinburgh, Lisbon, London

Step3: Set your Internet connection



Quick Start - ISP Connection Type

Select the Internet connection type to connect to your ISP. Click **NEXT** to continue.

- Dynamic IP Address Choose this option to obtain a IP address automatically from your ISP.
- Static IP Address Choose this option to set static IP information provided to you by your ISP.
- PPPoE/PPPoA Choose this option if your ISP uses PPPoE/PPPoA. (For most DSL users)
- Bridge Mode Choose this option if your ISP uses Bridge Mode.



Quick Start - PPPoE/PPPoA

Enter the PPPoE/PPPoA information provided to you by your ISP. Click **NEXT** to continue.

Username:

Password:

VPI: (0~255)

VCI: (1~65535)

Connection Type: 

BACK

NEXT

EXIT



Quick Start Complete !!

The Setup Wizard has completed. Click on **BACK** to modify changes or mistakes. Click **NEXT** to save the current settings.

BACK

NEXT

EXIT

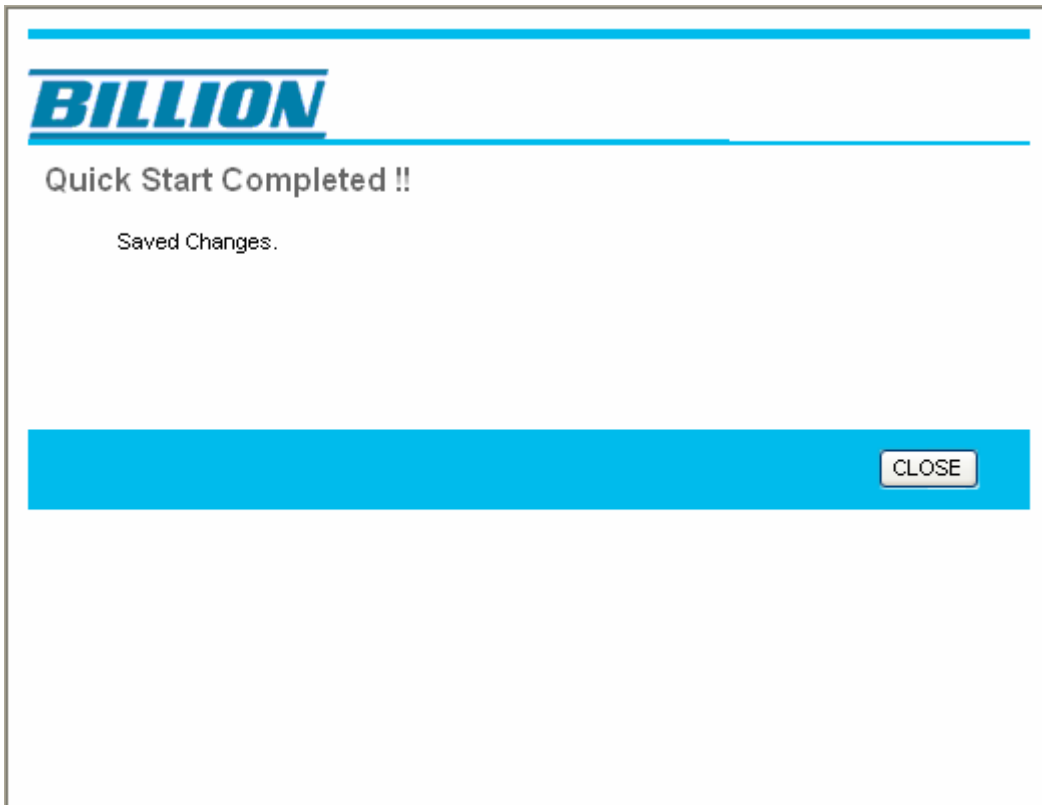

Step4: Restart your ADSL2+ Router

4.2 Interface Setup

Click this item to access the following sub-items that configure the ADSL2+ router: **Internet, LAN, and Wireless**

These functions are described in the following sections.

4.2.1 Internet



ADSL Modem/Router

Interface	Quick Start	Interface Setup	Advanced Setup	Access Management	Maintenance	Status	Help
	Internet	LAN	Wireless				
ATM VC							
QoS							
Encapsulation							
PPPoE/PPPoA							
Connection Setting							
IP Address							
<input type="button" value="SAVE"/>							

Virtual Circuit : PVC0

Status : Activated Deactivated

VPI : 8 (range: 0~255)

VCI : 35 (range: 1~65535)

ATM QoS : UBR

PCR : 0 cells/second

SCR : 0 cells/second

MBS : 0 cells

ISP : Dynamic IP Address
 Static IP Address
 PPPoA/PPPoE
 Bridge Mode

Servicename :

Username : username

Password :

Encapsulation : PPPoE LLC

Half Bridge : Activated Deactivated

Connection : Always On (Recommended)
 Connect On-Demand (Close if idle for minutes)
 Connect Manually

TCP MSS Option : TCP MSS(0:default) bytes

Get IP Address : Static Dynamic

Static IP Address :

IP Subnet Mask :

Gateway :

NAT : Enable

Default Route : Yes No

TCP MTU Option : TCP MTU(0:default) bytes

Dynamic Route : RIP1 Direction None

Multicast : Disabled

MAC Spoofing : Enabled Disabled

■ ATM VC

ATM settings are used to connect to your ISP. Your ISP provides VPI, VCI settings to you. In this Device, you can totally setup 8 VCs on different encapsulations, if you apply 8 different virtual circuits from your ISP. You need to activate the VC to take effect. For PVCs management, you can use ATM QoS to setup each PVC traffic line's priority.

● **Virtual Circuit:** VPI (Virtual Path Identifier) and VCI (Virtual Channel Identifier) define a virtual circuit.

● **PVC Summary:**



Service Information Summary

#	Active	VPI	VCI	ENCAP	Mux	IP Address	Status
PVC0	Yes	8	35	PPPoE	LLC	Dynamic	Idle
PVC1	No	0	34	RFC 1483	LLC	-	N/A
PVC2	No	0	35	RFC 1483	LLC	-	N/A
PVC3	No	0	36	RFC 1483	LLC	-	N/A
PVC4	No	0	37	RFC 1483	LLC	-	N/A
PVC5	No	0	38	RFC 1483	LLC	-	N/A
PVC6	No	0	39	RFC 1483	LLC	-	N/A
PVC7	No	0	40	RFC 1483	LLC	-	N/A

● **VPI:** The valid range for the VPI is 0 to 255. Enter the VPI assigned to you. This field may already be configured.

● **VCI:** The valid range for the VCI is 1 to 65535. Enter the VCI assigned to you. This field may already be configured.

● **ATM QoS:** Select the Quality of Service types for this Virtual Circuit. The ATM QoS types include CBR (Constant Bit Rate), VBR (Variable Bit Rate) and UBR (Unspecified Bit Rate). These QoS types are all controlled by the parameters specified below, including PCR, SCR and MBS.

Select **CBR** to specify fixed (always-on) bandwidth for voice or data traffic. Select **UBR** for applications that are non-time sensitive, such as e-mail. Select **VBR** for burst traffic and bandwidth sharing with other applications.

● **PCR:** Divide the DSL line rate (bps) by 424 (the size of an ATM cell) to find the Peak Cell Rate (PCR). This is the maximum rate at which the sender can send cells.

● **SCR:** The Sustain Cell Rate (SCR) sets the average cell rate (long-term) that can be transmitted.

● **MBS:** Maximum Burst Size (MBS) refers to the maximum number of cells that can be sent at the peak rate. Type the MBS, which is less than 65535

■ Encapsulation:

● **ISP:** Select the encapsulation type your ISP uses from the **Encapsulation** list.

Choices vary depending on what you select in the **Mode** field.

Dynamic IP: Select this option if your ISP provides you an IP address automatically. This option is typically used for Cable services. Please enter the Dynamic IP information accordingly.

Static IP: Select this option to set static IP information. You will need to enter in the Connection type, IP address, subnet mask, and gateway address, provided to you by your ISP. Each IP address entered in the fields must be in the appropriate IP form, which is four IP octets separated by a dot (x.x.x.x). The Router will not accept the IP address if it is not in this format.

PPPoA/PPPoE: Select this option if your ISP requires you to use a PPPoE connection. This option is typically used for DSL services. Select Dynamic PPPoE to obtain an IP address automatically for your PPPoE connection. Select Static PPPoE to use a static IP address for your PPPoE connection. Please enter the information accordingly.

■ PPPoE/PPPoA

Select this option if your ISP requires you to use a PPPoE connection. This option is typically used for DSL services. Select Dynamic PPPoE to obtain an IP address automatically for your PPPoE connection. Select Static PPPoE to use a static IP address for your PPPoE connection. Please enter the information accordingly.

● **Servicename:** Enter a name for the PPPoE/PPPoA connection.

● **Username:** Enter the user name exactly as your ISP assigned.

● **Password:** Enter the password associated with the user name above.

● **Encapsulation:** select Bridge in the Mode field, select either PPPoA or RFC 1483. select Routing in the Mode field, select PPPoA, RFC 1483, ENET ENCAP or PPPoE.

Multiplex: Select the method of multiplexing used by your ISP. Choices are VC or LLC.

● **Half Bridge:** The Half Bridge mode can only be used when a single IP address has been assigned by the ISP. It is used when the use of NAT is not desired and there is a single computer attached to the router.

● **Connection:** The schedule rule(s) have priority over your Connection settings.

Always on: Select Always on Connection when you want your connection up all the time.

Connect on Demand: Select Connect on Demand when you don't want the connection up all the time and specify an idle time-out in the Max Idle Timeout field

● **TCP MSS Option:** Enter the TCP Maximum Segment Size (MSS)

● **Get IP Address:** Choose Static or Dynamic

● **Static IP Address:** Enter the IP address of ADSL Router in dotted decimal notation, for example, 192.168.1.254 (factory default).

● **IP Subnet Mask:** The default is 0.0.0.0. User can change it to other such as 255.255.255.0. Type the subnet mask assigned to you by your ISP (if given).

● **Gateway:** You must specify a gateway IP address (supplied by your ISP) when you use **1483 Bridged IP** in the **Encapsulation** field in the previous screen.

● **NAT:** Select this option to Disabled/Enable the NAT (Network Address Translation) function for this VC. The NAT function can be activated or deactivated per PVC basis

● **Default Route:** If enable this function, the current PVC will be the default gateway to internet from this device

● **TCP MTU Option:** Enter the TCP maximum transmission unit (MTU)

● **Dynamic Route:**

RIP Version: (Routing Information protocol) Select this option to specify the RIP version, including RIP-1, RIP-2M and RIP-2B. RIP-2M and RIP-2B are both sent in RIP-2 format; the difference is that RIP-2M using Multicast and RIP-2 using Broadcast format

RIP Direction: Select this option to specify the RIP direction. None is for disabling the RIP function. Both means the ADSL Router will periodically send routing information and accept routing information then incorporate into routing table. IN only means the ADSL router will only accept but will not send RIP packet. OUT only means the ADSL router will only send but will not accept RIP packet.

● **Multicast:** IGMP (Internet Group Multicast Protocol) is a network-layer protocol used to establish membership in a Multicast group - it is not used to carry user data. The BiPAC 5200N supports both IGMP version 1 (IGMP-v1) and IGMP-v2. Select None to disable it

● **MAC Spoofing:** Select Enable and enter a MAC address that will temporarily change your router's MAC address to the one you have specified in this field. Leave it as Disabled if you do not wish to change the MAC address of your router.

4.2.2 LAN

A Local Area Network (LAN) is a shared communication system to which many computers are attached and is limited to the immediate area, usually the same building or floor of a building.

The screenshot shows the configuration page for the LAN interface of a BILLION ADSL Modem/Router. The page has a blue header with the BILLION logo and the title 'ADSL Modem/Router'. Below the header is a navigation menu with tabs: Interface, Quick Start, Interface Setup (selected), Advanced Setup, Access Management, Maintenance, Status, and Help. Under the 'Interface Setup' tab, there are three sub-tabs: Internet, LAN (selected), and Wireless. The main content area is divided into sections: Router Local IP, DHCP, and DNS. The Router Local IP section contains fields for IP Address (192.168.1.254), IP Subnet Mask (255.255.255.0), Dynamic Route (RIP1), Direction (None), Multicast (Disabled), and IGMP Snoop (Disabled). The DHCP section has a DHCP status set to Enabled and a DHCP Server section with Starting IP Address (192.168.1.100), IP Pool Count (100), and Lease Time (86400 seconds). The DNS section has a DNS Relay set to Use Auto Discovered DNS Server Only, and Primary and Secondary DNS Servers set to N/A. At the bottom, there are SAVE and CANCEL buttons.

Router Local IP

IP Address: Enter the IP address of ADSL Router in dotted decimal notation, for example, 192.168.1.254 (factory default).

IP Subnet Mask: The default is 255.255.255.0. User can change it to other such as 255.255.255.128.

Dynamic Route: Select the RIP version from RIP-1, RIP-2B and RIP-2M.

RIP Direction: Select the RIP direction from None, Both, In Only and Out Only.

Multicast: IGMP (Internet Group Multicast Protocol) is a network-layer protocol used to establish membership in a Multicast group - it is not used to carry user data. The BiPAC

5200N supports both IGMP version 1 (IGMP-v1) and IGMP-v2. Select None to disable it

● **IGMP Snoop:** Choose Disabled or Enabled IGMP Snoop function.

■ DHCP

DHCP (Dynamic Host Configuration Protocol, RFC 2131 and RFC 2132) allows individual clients to obtain TCP/IP configuration at start-up from a server.

● **DHCP:**

If set to **Enabled**, your BiPAC 5200N can assign IP addresses, an IP default gateway and DNS servers to Windows 95, Windows NT and other systems that support the DHCP client. If set to **Disabled**, the DHCP server will be disabled.

If set to **Relay**, the BiPAC 5200N acts as a surrogate DHCP server and relays DHCP requests and responses between the remote server and the clients. Enter the IP address of the actual, remote DHCP server in the Remote DHCP Server field in this case.

When DHCP is used, the following items need to be set.

● **Starting IP Address:** This field specifies the first of the contiguous addresses in the IP address pool.

● **IP Pool Count:** This field specifies the size or count of the IP address pool.

● **Lease Time:** The current lease time of client.

● **Primary DNS Server:** Enter the IP addresses of the DNS servers. The DNS servers are passed to the DHCP clients along with the IP address and the subnet mask.

● **Secondary DNS Server:** Enter the IP addresses of the DNS servers. The DNS servers are passed to the DHCP clients along with the IP address and the subnet mask.

4.2.3 Wireless

This section introduces the wireless LAN and some basic configurations. Wireless LANs can be as simple as two computers with wireless LAN cards communicating in a peer-to-peer network or as complex as a number of computers with wireless LAN cards communicating through access points which bridge network traffic to the wired LAN.

Interface	Quick Start	Interface Setup	Advanced Setup	Access Management	Maintenance	Status	Help
	Internet	LAN	Wireless				
Access Point Settings							
Access Point : <input checked="" type="radio"/> Activated <input type="radio"/> Deactivated Channel : UNITED STATES <input type="button" value="v"/> Channel01 2412MHz <input type="button" value="v"/> Current Channel: <input type="text" value="1"/> Beacon Interval : <input type="text" value="100"/> (range: 20~1000) RTS/CTS Threshold : <input type="text" value="2347"/> (range: 1500~2347) Fragmentation Threshold : <input type="text" value="2346"/> (range: 256~2346, even numbers only) DTIM : <input type="text" value="3"/> (range: 1~255) Wireless Mode : <input type="button" value="v"/> 802.11b+g+n <input type="button" value="v"/>							
11n Settings							
Channel Bandwidth : <input type="button" value="v"/> 20 MHz <input type="button" value="v"/> Guard Interval : <input type="button" value="v"/> 800 nsec <input type="button" value="v"/> MCS : <input type="button" value="v"/> AUTO <input type="button" value="v"/>							
SSID Settings							
SSID Index : <input type="button" value="v"/> 1 <input type="button" value="v"/> Broadcast SSID : <input checked="" type="radio"/> Yes <input type="radio"/> No WMM : <input type="radio"/> Enable <input checked="" type="radio"/> Disable SSID : <input type="text" value="wlan-ap"/> Authentication Type : <input type="button" value="v"/> Disabled <input type="button" value="v"/>							
Wireless MAC Address Filter							
Active : <input type="radio"/> Activated <input checked="" type="radio"/> Deactivated Action : <input type="button" value="v"/> Deny Association <input type="button" value="v"/> the follow Wireless LAN station(s) association. Mac Address #1 : <input type="text" value="00:00:00:00:00:00"/> Mac Address #2 : <input type="text" value="00:00:00:00:00:00"/> Mac Address #3 : <input type="text" value="00:00:00:00:00:00"/> Mac Address #4 : <input type="text" value="00:00:00:00:00:00"/> Mac Address #5 : <input type="text" value="00:00:00:00:00:00"/> Mac Address #6 : <input type="text" value="00:00:00:00:00:00"/> Mac Address #7 : <input type="text" value="00:00:00:00:00:00"/> Mac Address #8 : <input type="text" value="00:00:00:00:00:00"/>							
<input type="button" value="SAVE"/> <input type="button" value="CANCEL"/>							

■ Access Point Settings

● **Access Point:** Default setting is set to **Activated**. If you do not have any wireless, both 802.11g, 802.11b and 802.11n, device in your network, select **Deactivated**.

● **Channel ID:** The range of radio frequencies used by IEEE 802.11b/g/n wireless devices is called a channel. Select a channel from the drop-down list box.

● **Beacon interval:** The Beacon Interval value indicates the frequency interval of the

beacon. Enter a value between 20 and 1000. A beacon is a packet broadcast by the Router to synchronize the wireless network.

● **RTS/CTS Threshold:** The RTS (Request To Send) threshold (number of bytes) for enabling RTS/CTS handshake. Data with its frame size larger than this value will perform the RTS/CTS handshake. Setting this attribute to be larger than the maximum MSDU (MAC service data unit) size turns off the RTS/CTS handshake. Setting this attribute to zero turns on the RTS/CTS handshake. Enter a value between 1500 and 2347.

● **Fragmentation Threshold:** The threshold (number of bytes) for the fragmentation boundary for directed messages. It is the maximum data fragment size that can be sent. Enter a value between 256 and 2346.

● **DMIT:** This value, between 1 and 255, indicates the interval of the Delivery Traffic Indication Message (DTIM).

● **802.11b/g/n:** The default setting is **802.11b+g+n** (Mixed mode). If you do not know or have both 11g and 11b devices in your network, then keep the default in **mixed mode**. From the drop-down manual, you can select **802.11g** if you have only 11g card. If you have only 11b card, then select **802.11b** and if you only have 802.11n then select **802.11n**.

■ 11n Settings

● **Channel Bandwidth:** Select either **20 MHz** or **20/40 MHz** for the channel bandwidth. The higher the bandwidth the better the performance will be.

● **Guard Interval:** Select either **400nsec** or **800nsec** for the guard interval. The guard interval is here to ensure that data transmission do not interfere with each other, it also prevents propagation delays, echoing and reflections.

● **MCS:** There are options **0~15** and **AUTO** to select for the **Modulation and Coding Scheme**. We recommend users selecting **AUTO**.

■ SSID Settings

● **SSID Index:** Default SSID index is "1".

● **SSID:** The SSID is the unique name of a wireless access point (AP) to be distinguished from another. For security propose, change the default **wlan-ap** to a unique ID name to the AP which is already built-in to the router's wireless interface. It is case sensitive and must not excess 30 characters. Make sure your wireless clients have exactly the SSID as the device, in order to get connected to your network.

● **Broadcast SSID:** Select **Yes** to make the SSID visible so a station can obtain the SSID through passive scanning. Select **No** to hide the SSID in so a station cannot obtain the SSID through passive scanning.

● **WMM:** WMM (Wi-Fi Multimedia) is a simple QoS which prioritizes traffic based on 4 AC (Access Categories) voice, video, best effort and background but it does not provide a guarantee throughput. Choose **Enable** to activate the function or else leave it as **Disable**.

● **Authentication Type:** To prevent unauthorized wireless stations from accessing data transmitted over the network, the router offers highly secure data encryption, known as WEP.&WPA. If you require high security for transmissions, there are four alternatives to select from: **64-bit WEP, 128-bit WEP, WPA-PSK and WPA2-PSK**. WEP 128 will offer increased security over WEP 64.

You can disable or enable with WPA or WEP for protecting wireless network. The default type of wireless is **disabled** and to allow all wireless computers to communicate with the access points without any data encryption

■ WPS Settings (Future Release)

● **WPS State:** Displays whether the WPS is **configured** or **unconfigured**.

● **WPS Mode:** Select the mode which to start WPS, choose between **PIN Code** or **PBC** (Push Button). Selecting **Pin Code** mode will require you to know the enrollee PIN code.

● **WPS Progress:** Shows the current progress status of WPS.

● **SSID:** Type in the Service Set Identifier name, it is the unique name of a wireless access point (AP) to be distinguished from another.

● **Authentication Type:**

■ WEP

WEP

WEP 64-bits For each key, please enter either (1) 5 characters excluding symbols, or (2) 10 characters ranging from 0~9, a, b, c, d, e, f.

WEP 128-bits For each key, please enter either (1) 13 characters excluding symbols, or (2) 26 characters ranging from 0~9, a, b, c, d, e, f.

Key #1 : 0x0000000000

Key #2 : 0x0000000000

Key #3 : 0x0000000000

Key #4 : 0x0000000000

● **Key 1 to Key 4:** Enter the key to encrypt wireless data. To allow encrypted data transmission, the WEP Encryption Key values on all wireless stations must be the same as the router. There are four keys for your selection. The input format is in HEX style, 5 and 13 HEX codes are required for 64-bitWEP and 128-bitWEP respectively.

If you chose **WEP 64-bits**, then enter any 5 ASCII characters or 10 hexadecimal characters ("0-9", "A-F").

If you chose **WEP 128-bits**, then enter 13 ASCII characters or 26 hexadecimal characters ("0-9", "A-F").

You must configure all four keys, but only one key can be activated at any one time. The default key is key 1.

WPA-PSK & WPA2-PSK



WPA-PSK

Encryption : TKIP

Pre-Shared Key : (8-63 characters)

● **Encryption:** TKIP (Temporal Key Integrity Protocol) or AES (Advanced Encryption System) utilizes a stronger encryption method and incorporates Message Integrity Code (MIC) to provide protection against hackers.

● **Pre-Shared key:** The key for network authentication. The input format is in character style and key size should be in the range between 8 and 63 characters.

Wireless MAC Address Filter

The MAC filter screen allows you to configure the router to give exclusive access to up to 8 devices (Allow Association) or exclude up to 8 devices from accessing the router (Deny Association). Every Ethernet device has a unique MAC (Media Access Control) address. The MAC address is assigned at the factory and consists of six pairs of hexadecimal characters, for example, 00:AA:BB:00:00:02. You need to know the MAC address of the devices to configure this screen.

● **Active:** Select **Activated** to enable MAC address filtering.

● **Action:** Define the filter action for the list of MAC addresses in the MAC address filter table.

Select **Deny Association** to block access to the router, MAC addresses not listed will be allowed to access the router. Select **Allow Association** to permit access to the router, MAC addresses not listed will be denied access to the router.

● **MAC Address:** Enter the MAC addresses (in XX:XX:XX:XX:XX:XX format) of the wireless station that are allowed or denied access to the router in these address fields.

4.3 Advanced Setup

4.3.1 Firewall

Your router includes a firewall for controlling Internet access from your LAN and helping to prevent attacks from hackers. In addition to this, when using NAT (Network Address Translation) the router acts as a “natural” Internet firewall, since all PCs on your LAN use private IP addresses that cannot be directly accessed from the Internet.

The screenshot shows the BILLION ADSL Modem/Router web interface. The top navigation bar includes 'Quick Start', 'Interface Setup', 'Advanced Setup', 'Access Management', 'Maintenance', 'Status', and 'Help'. The 'Advanced Setup' menu is expanded to show 'Firewall', 'Routing', 'NAT', 'QoS', and 'ADSL'. The 'Firewall' sub-menu is selected, displaying the following settings:

- Firewall : Enabled Disabled
- SPI : Enabled Disabled

(WARNING: If You enabled SPI, all traffics initiated from WAN would be blocked, including DMZ, Virtual Server, and ACL WAN side.)

At the bottom of the page, there are 'SAVE' and 'CANCEL' buttons.

● **Firewall:** **Enabled:** As set in default setting, it activates your firewall function.

Disabled: It disables the firewall function.

● **SPI:** **Enabled:** As set in default setting, it activates your SPI function.

Disabled: It disables the SPI function.

4.3.2 Routing

If you have another router with a LAN-to-LAN connection, you may create a static routing on the router that is the gateway to Internet.

The screenshot shows the BILLION ADSL Modem/Router web interface. The top navigation bar includes 'Advanced', 'Quick Start', 'Interface Setup', 'Advanced Setup', 'Access Management', 'Maintenance', 'Status', and 'Help'. Under 'Advanced Setup', there are sub-menus for 'Firewall', 'Routing', 'NAT', 'QoS', and 'ADSL'. The 'Routing Table List' section displays a table with the following data:

#	Dest IP	Mask	Gateway IP	Metric	Device	Use	Edit	Drop
1	192.168.1.0	24	192.168.1.254	1	enet0	1017		
2	default	0	Node1	2	Idle	0		

Below the table is an 'ADD ROUTE' button.

- #: Item number
- **Dest IP:** IP address of the destination network
- **Mask:** The destination mask address.
- **Gateway IP:** IP address of the gateway or existing interface that this route uses.
- **Metric:** It represents the cost of transmission for routing purposes. The number need not be precise, but it must be between 1 and 15.
- **Device:** Media/channel selected to append the route.
- **Use:** Counter for access times.
- **Edit:** Edit the route; this icon is not shown for system default route.
- **Drop:** Drop the route; this icon is not shown for system default route.

ADD Route

The screenshot shows the 'Static Route' configuration page in the BILLION ADSL Modem/Router web interface. The navigation bar is the same as in the previous screenshot. The 'Static Route' section contains the following configuration fields:

- Destination IP Address:
- IP Subnet Mask:
- Gateway IP Address: PVC0
- Metric:
- Announced in RIP: (Yes)

At the bottom of the page are four buttons: 'SAVE', 'DELETE', 'BACK', and 'CANCEL'.

- **Destination IP Address** : This is the destination subnet IP address.
- **IP Subnet Mask** : It is the destination IP addresses based on above destination subnet IP
- **Gateway IP Address** : This is the gateway IP address to which packets are to be forwarded.
- **Metric** : It represents the cost of transmission for routing purposes. The number need not be precise, but it must be between 1 and 15.
- **Announced in RIP:** This parameter determines if the Prestige will include the route to the remote node in its RIP broadcasts. Set "No", it is kept private and is not included in RIP broadcasts. Set "Yes", the remote node will be propagated to other hosts through RIP broadcasts.

4.3.3 NAT

The NAT (Network Address Translation - NAT, RFC 1631) is the translation of the IP address of a host in a packet. The default setting is **Dynamic NAT**. It provides dynamic Network Address Translation capability between LAN and multiple WAN connections, and the LAN traffic is routed to appropriate WAN connections based on the destination IP addresses and Route Table. This eliminates the need for the static NAT session configuration between multiple LAN clients and multiple WAN connections.

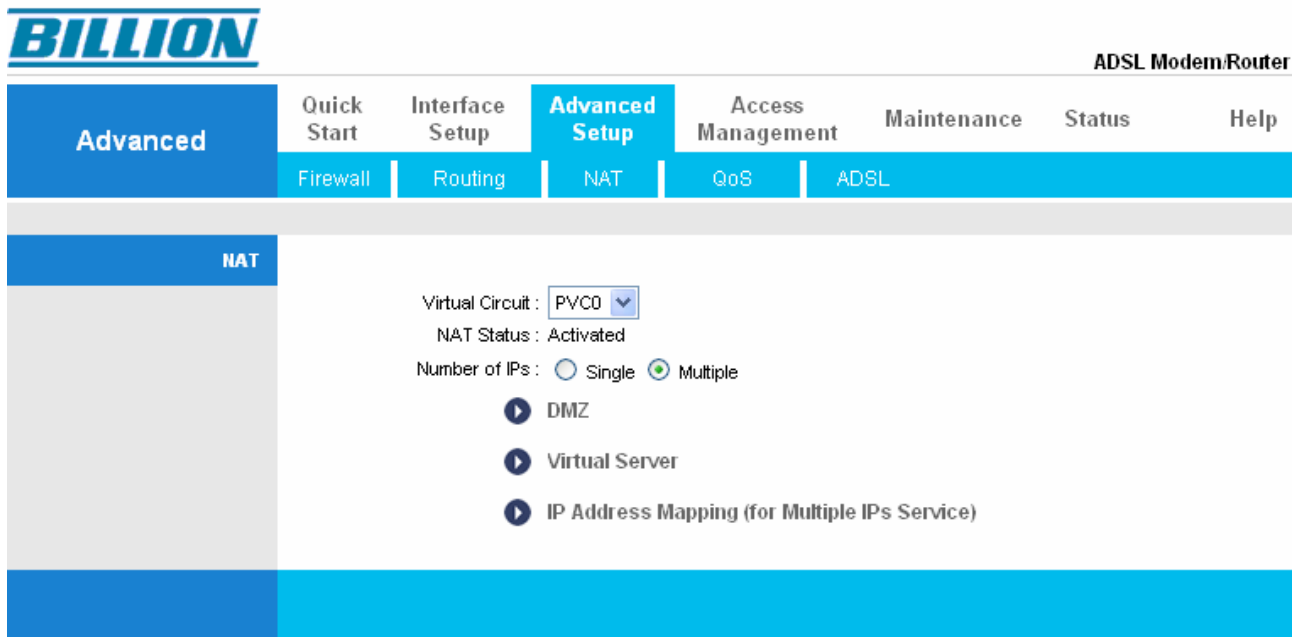

● **Virtual Circuit:** VPI (Virtual Path Identifier) and VCI (Virtual Channel Identifier) define a virtual circuit. There are eight groups of PVC can be defined and used.

● **NAT Status:** Show the NAT status, Activated or Deactivated.

● **Number of IPs:** User can select Single or Multiple.

■ DMZ

The DMZ Host is a local computer exposed to the Internet. When setting a particular internal IP address as the DMZ Host, all incoming packets will be checked by the Firewall and NAT algorithms then passed to the DMZ host, when a packet received does not use a port number used by any other Virtual Server entries.

Advanced	Quick Start	Interface Setup	Advanced Setup	Access Management	Maintenance	Status	Help
	Firewall	Routing	NAT	QoS	ADSL		

DMZ	DMZ setting for : PVC0 - Multiple IP Account DMZ : <input type="radio"/> Enabled <input checked="" type="radio"/> Disabled DMZ Host IP Address : <input type="text" value="0.0.0.0"/>
	<input type="button" value="SAVE"/> <input type="button" value="BACK"/>

● **DMZ setting for:** Show the PVC that DMZ will be applied for.

● **DMZ:** **Disabled:** As set in default setting, it disables the DMZ function.

Enabled: It activates your DMZ function.

● **DMZ Host IP Address:** Give a static IP address to the DMZ Host when **Enabled** radio button is checked. Be aware that this IP will be exposed to the WAN/Internet. Select the **SAVE** button to apply your changes.

■ Virtual Server

In TCP/IP and UDP networks a port is a 16-bit number used to identify which application program (usually a server) incoming connections should be delivered to. Some ports have numbers that are pre-assigned to them by the IANA (the Internet Assigned Numbers Authority), and these are referred to as “well-known ports”. Servers follow the well-known port assignments so clients can locate them.

If you wish to run a server on your network that can be accessed from the WAN (i.e. from other machines on the Internet that are outside your local network), or any application that can accept incoming connections (e.g. Peer-to-peer/P2P software such as instant messaging applications and P2P file-sharing applications) and are using NAT (Network Address Translation), then you will usually need to configure your router to forward these incoming connection attempts using specific ports to the PC on your network running the application. You will also need to use port forwarding if you want to host an online game server.

The reason for this is that when using NAT, your publicly accessible IP address will be used by and point to your router, which then needs to deliver all traffic to the private IP addresses used by your PCs. Please see the **WAN** configuration section of this manual for more information on NAT.

The device can be configured as a virtual server so that remote users accessing services such as Web or FTP services via the public (WAN) IP address can be automatically redirected to local servers in the LAN network. Depending on the requested service (TCP/UDP port number), the device redirects the external service request to the appropriate server within the LAN network.

BILLION ADSL Modem/Router

Advanced | Quick Start | Interface Setup | **Advanced Setup** | Access Management | Maintenance | Status | Help

Firewall | Routing | **NAT** | QoS | ADSL

Virtual Server

Virtual Server for : PVC0 - Multiple IP Account

Rule Index: 1

Application: -

Protocol: ALL

Start Port Number: 0

End Port Number: 0

Local IP Address: 0.0.0.0

Virtual Server Listing

Rule	Application	Protocol	Start Port	End Port	Local IP Address
1	-	-	0	0	0.0.0.0
2	-	-	0	0	0.0.0.0
3	-	-	0	0	0.0.0.0
4	-	-	0	0	0.0.0.0
5	-	-	0	0	0.0.0.0
6	-	-	0	0	0.0.0.0
7	-	-	0	0	0.0.0.0
8	-	-	0	0	0.0.0.0
9	-	-	0	0	0.0.0.0
10	-	-	0	0	0.0.0.0
11	-	-	0	0	0.0.0.0
12	-	-	0	0	0.0.0.0
13	-	-	0	0	0.0.0.0
14	-	-	0	0	0.0.0.0
15	-	-	0	0	0.0.0.0
16	-	-	0	0	0.0.0.0

SAVE DELETE BACK CANCEL

- **Rule Index:** Choose the rule number.
- **Application:** Choose the predefined rule from Application drop-down menu or enter a custom name.
- **Protocol:** Choose the Protocol Type, ALL, TCP or UDP.
- **Start Port Number:** Enter a port number in this field.
- **End Port Number:** Enter a port number in this field.
- **Local IP Address:** Enter your server IP address in this field.

IP Address Mapping

BILLION ADSL Modem/Router

Advanced | Quick Start | Interface Setup | **Advanced Setup** | Access Management | Maintenance | Status | Help

Firewall | Routing | **NAT** | QoS | ADSL

IP Address Mapping

Address Mapping Rule : PVC0
 Rule Index : 1
 Rule Type : One-to-One
 Local Start IP : 0.0.0.0
 Local End IP : N/A
 Public Start IP : 0.0.0.0 (0.0.0.0 for modem's WAN IP)
 Public End IP : N/A

Address Mapping List

Rule	Type	Local Start IP	Local End IP	Public Start IP	Public End IP
1	-
2	-
3	-
4	-
5	-
6	-
7	-
8	-

SAVE DELETE BACK CANCEL

● **Address Mapping Rule:** Shows the PVC where the rule will be applied to

● **Rule Index:** Choose the rule number.

● **Rule Type:**

⊙ One-to-one: This is the mode maps one local IP address to one global IP address. Note that port numbers do not change for the One-to-one NAT mapping type.

⊙ Many-to-One: This is the mode maps multiple local IP addresses to one global IP address. This is equivalent to Many to One (i.e., PAT, port address translation).

⊙ Many-to-Many Overload: This mode maps multiple local IP addresses to shared global IP addresses.

⊙ Many-to-Many No Overload: This mode maps each local IP address to an unique global IP addresses.

⊙ Server: This type allows you to specify inside servers of different services behind the NAT to be accessible to the outside world.

● **Local Start IP:** This is the starting range for Inside Local IP Address (ILA). Local IP addresses are N/A for Server port mapping.

● **Local End IP:** This is the end range for Inside Local IP Address (ILA). If your rule is for all local IP addresses, then enter 0.0.0.0 as the Local Start IP address and 255.255.255.255 as the Local End IP address. This field is N/A for One-to-one and Server mapping types.

● **Public Start IP:** This is the start range for Inside Public IP Address. Enter 0.0.0.0 here if you have a dynamic IP address from your ISP.

● **Public End IP:** This is the end range for Inside Public IP Address. This field is N/A for One-to-one, Many-to-One and Server mapping types.



Using port forwarding does have security implications, as outside users will be able to connect to PCs on your network. For this reason you are advised to use specific Virtual Server entries just for the ports your application requires, instead of using DMZ. As doing so will result in all connections from the WAN attempt to access to your public IP of the DMZ PC specified.



Attention

If you have disabled the NAT option in the WAN-ISP section, the Virtual Server function will hence be invalid.

If the DHCP server option is enabled, you have to be very careful in assigning the IP addresses of the virtual servers in order to avoid conflicts. The easiest way of configuring Virtual Servers is to manually assign static IP address to each virtual server PC, with an address that does not fall into the range of IP addresses that are to be issued by the DHCP server. You can configure the virtual server IP address manually, but it must still be in the same subnet as the router.

4.3.4 QoS

Quality of Service (QoS) helps to prioritize data as it enters your router. By attaching special identification marks or headers to incoming packets, QoS determines which queue the packets enter, based on priority. This is useful when there are certain types of data you want to give higher priority to, such as voice data packets given higher priority than Web data packets.

The main goal of QoS is prioritizing incoming data, preventing data loss due to factors such as jitter, delay and dropping. Another important aspect of QoS is ensuring that prioritizing one data flow doesn't interfere with other data flows.

QoS can be toggled Activated and Deactivated. QoS must be activated before you can edit the following options. When you are done making changes, click on **Add** to save your changes.

Click on **QoS Settings Summary** to view the list of QoS rules that have been added.

The screenshot shows the configuration interface for a BILLION ADSL Modem/Router. The top navigation bar includes 'Advanced', 'Quick Start', 'Interface Setup', 'Advanced Setup', 'Access Management', 'Maintenance', 'Status', and 'Help'. Under 'Advanced Setup', there are sub-menus for 'Firewall', 'Routing', 'NAT', 'QoS', and 'ADSL'. The 'Quality of Service' section is active, showing a 'Rule' configuration page. At the top of this section, there are radio buttons for 'QoS: Activated' and 'Deactivated', with 'Deactivated' selected. Below this is a 'Summary' field with a button labeled 'QoS Settings Summary'. The 'Rule' configuration is divided into two main sections: 'Rule' and 'Action'. The 'Rule' section includes: 'Rule Index' (dropdown set to 1), 'Active' (radio buttons for 'Activated' and 'Deactivated', with 'Deactivated' selected), 'Application' (dropdown), 'Physical Ports' (checkboxes for WLAN, Enet1, Enet2, Enet3, Enet4), 'Destination MAC' (text input), 'IP' (text input), 'Mask' (text input), 'Port Range' (two text inputs with a tilde separator), 'Source MAC' (text input), 'IP' (text input), 'Mask' (text input), 'Port Range' (two text inputs with a tilde separator), 'Protocol ID' (dropdown), 'Vlan ID Range' (two text inputs with a tilde separator), 'IPP/DS Field' (radio buttons for 'IPP/TOS' and 'DSCP', with 'DSCP' selected), 'IP Precedence Range' (two dropdown menus with a tilde separator), 'Type of Service' (dropdown), 'DSCP Range' (two text inputs with a tilde separator, note: '(Value Range: 0 ~ 63)'), and '802.1p' (two dropdown menus with a tilde separator). The 'Action' section includes: 'IPP/DS Field' (radio buttons for 'IPP/TOS' and 'DSCP', with 'DSCP' selected), 'IP Precedence Remark' (dropdown), 'Type of Service Remark' (dropdown), 'DSCP Remark' (text input, note: '(Value Range: 0 ~ 63)'), '802.1p Remark' (two dropdown menus with a tilde separator), and 'Queue #' (dropdown). At the bottom of the page, there are three buttons: 'ADD', 'DELETE', and 'CANCEL'.

■ Rule

You can set 16 different QoS rules. Each QoS rule has its detail setting conditions like: 802.1p,application, DSCP, IP, MAC, Protocol, TOS, VLAN...etc, you can modify the default value to any new one you wish. Please notice that only when the packet fulfill every detail setting conditions here, then this packet will be remarked as the priority queue of each rule. The non-selected setting part will be treated as “don’t care” and the system will not handle this setting part. If the original packet does not have 802.1q tagged header, system will not add header for this packet even the detail setting condition has adding 802.1p priority ability.

Rule

Rule Index : 1

Active : Activated Deactivated

Application :

Physical Ports : WLAN Enet1 Enet2 Enet3 Enet4

Destination MAC :

IP :

Mask :

Port Range : ~

Source MAC :

IP :

Mask :

Port Range : ~

Protocol ID :

Vlan ID Range : ~

IPP/DS Field : IPP/TOS DSCP

IP Precedence Range : ~

Type of Service :

DSCP Range : ~ (Value Range: 0 ~ 63)

802.1p : ~

- **Rule Index:** Select 16 different rules, each rule’s detail can be set and saved.
- **Active:** Select QoS is activated or deactivated.
- **Application:** Select 11 different applications: IGMP, SIP, H.323, MGCP, SNMP, DNS, DHCP, RIP, RSTP, RTCP, RTP.
- **Physical Ports:** Once you select the application, the associated ports will be displayed.
- **Destination MAC:** Set the Ethernet MAC value that you want to filter in destination side.
- **Destination IP:** Set the IP address value that you want to filter in destination side.
- **Destination Mask:** Set the subnet mask value that you want to filter in destination side.
- **Destination Port Range:** Set the port range value that you want to filter in destination side.
- **Source MAC:** Set the Ethernet MAC value that you want to filter in source side.

- **Source IP:** Set the IP address value that you want to filter in source side.
- **Source Mask:** Set the subnet mask value that you want to filter in source side.
- **Source Port Range:** Set the port range value that you want to filter in source side.
- **Protocol ID:** Set the protocol ID type that you want to filter.
- **Vlan ID Range:** Set the Vlan value that you want to filter.
- **IPP/DS Field:** Select IP QoS format.
- **IP Precedence Range:** Select the IP precedence range.
- **Type of Service:** Select 5 different type of service.
- **DSCP Range:** Set the DSCP value that you want to filter.
- **802.1p:** Set the remarked new 802.1p priority value on the packet that fulfill every detail setting condition of each rule.

■ Action

After finishing all rules detail condition setting, select the rule you want to execute and action here.

Action

IPP/DS Field : IPP/TOS DSCP

IP Precedence Remarking :

Type of Service Remarking :

DSCP Remarking : (Value Range: 0 ~ 63)

802.1p Remarking :

Queue # :

- **IPP/DS Field:** Select IP QoS format.
- **IP Precedence Remarking:** Select the remarking value of IP precedence.
- **Type of service Remarking:** Select the remarking value of type of service.
- **DSCP Remarking:** Select the remarking value of DSCP.
- **802.1p Remarking:** Select the remarking value of 802.1p.
- **Queue #:** Select four types of Queue: Low, Medium, High, Highest.

4.3.5 ADSL

The screenshot displays the configuration interface for a BILLION ADSL Modem/Router. The top navigation bar includes 'Advanced', 'Quick Start', 'Interface Setup', 'Advanced Setup', 'Access Management', 'Maintenance', 'Status', and 'Help'. Under 'Advanced Setup', sub-menus for 'Firewall', 'Routing', 'NAT', 'QoS', and 'ADSL' are visible. The 'ADSL' sub-menu is active, showing 'ADSL Mode' set to 'Auto Sync-Up' and 'ADSL Type' set to 'ANNEX A/L'. A dropdown menu for 'ADSL Type' is open, listing 'ANNEX A', 'ANNEX I', 'ANNEX A/L', 'ANNEX M', and 'ANNEX A/I/L/M'. A 'SAVE' button is located at the bottom of the configuration area.

● **ADSL Mode:** The default setting is **Auto Sync-Up**. This mode will automatically detect your ADSL, ADSL2+, ADSL2, G.DMT, G.lite, and T1.413. But in some area, multimode cannot detect the ADSL line code well. If it is the case, please adjust the ADSL line code to G.DMT or T1.413 first. If it still fails, please try the other values such as ALCTL, ADI, etc.

● **ADSL Type:** There are five modes “Open Annex Type and Follow DSLAM’s Setting”, “Annex A”, “Annex I”, “Annex A/L”, “Annex M” and “Annex A/I/L/M” that user can select for this connection.

4.4 Access Management

4.4.1 ACL

Access Control Listing allows you to determine which services/protocols can access BiPAC 5200N interface from which computers.

BILLION ADSL Modem/Router

Access Management | Quick Start | Interface Setup | Advanced Setup | **Access Management** | Maintenance | Status | Help

ACL | Filter | SNMP | UPNP | DDNS

Access Control Setup

ACL : Activated Deactivated

Access Control Editing

ACL Rule Index : 1

Active : Yes No

Secure IP Address : 0.0.0.0 ~ 0.0.0.0 (0.0.0.0 ~ 0.0.0.0 means all IPs)

Application : ALL

Interface : LAN

Access Control Listing

Index	Active	Secure IP Address	Application	Interface
1	Yes	0.0.0.0-0.0.0.0	ALL	LAN

SAVE DELETE CANCEL

- **ACL Rule Index:** This is item number
- **Secure IP Address:** The default 0.0.0.0 allows any client to use this service to remotely manage the BiPAC 5200N. Type an IP address to restrict access to a client with a matching IP address.
- **Application:** Choose a service that you may use to remotely manage the BiPAC 5200N.
- **Interface:** Select the access interface. Choices are **LAN**, **WAN** and **Both**.

4.4.2 Filter

You can Filter the packages by IP port , MAC and Application.

The screenshot shows the configuration interface for a BILLION ADSL Modem/Router. The main navigation bar includes 'Access Management', 'Quick Start', 'Interface Setup', 'Advanced Setup', 'Access Management', 'Maintenance', 'Status', and 'Help'. Under 'Access Management', there are sub-menus for 'ACL', 'Filter', 'SNMP', 'UPnP', and 'DDNS'. The 'Filter' sub-menu is selected.

The 'Filter' section is divided into several parts:

- Filter Type:** Filter Type Selection: IP / MAC Filter
- IP / MAC Filter Set Editing:** IP / MAC Filter Set Index: 1, Interface: PVC0, Direction: Both
- IP / MAC Filter Rule Editing:** IP / MAC Filter Rule Index: 1, Rule Type: IP, Active: No
- Source IP Address:** Source IP Address: (0.0.0.0 means Don't care), Subnet Mask: , Port Number: 0 (0 means Don't care)
- Destination IP Address:** Destination IP Address: (0.0.0.0 means Don't care), Subnet Mask: , Port Number: 0 (0 means Don't care)
- Protocol:** Protocol: TCP, Rule Unmatched: Forward
- IP / MAC Filter Listing:** A table showing the current filter set configuration.

#	Active	Src Address/Mask	Dest IP/Mask	Src Port	Dest Port	Protocol	Unmatched
1	-	-	-	-	-	-	-
2	-	-	-	-	-	-	-
3	-	-	-	-	-	-	-

Filter Type

Filter Type Selection: There are three types "IP/MAC Filter", "Application Filter", and "URL Filter" that user can select for this connection.

IP/MAC Filter Set Editing

IP/MAC Filter Set Index: This is item number

Interface: Select which channel (PVC) to configure.

Direction: Select the access to the Internet ("Outgoing") or from the Internet ("Incoming").or **Both**.

■ IP/MAC Filter Rule Editing

- **IP/MAC Filter Rule Index:** This is item number
- **Rule Type:** Choose “IP” or “MAC” rules
- **Active:** Select **Yes** from the drop down list box to enable IP filter rule.
- **Source IP Address:** The source IP address or range of packets to be monitored.
- **Subnet Mask:** It is the source IP addresses based on above source subnet IP
- **Source Port Number:** This Port or Port Ranges defines the port allowed to be used by the Remote/WAN to connect to the application. Default is set from range **0 ~ 65535**. It is recommended that this option be configured by an advanced user.
- **Destination IP Address:** This is the destination subnet IP address.
- **Subnet Mask:** It is the destination IP addresses based on above destination subnet IP
- **Destination Port Number:** This is the Port or Port Ranges that defines the application.
- **Protocol:** It is the packet protocol type used by the application, select either **TCP** or **UDP** or **ICMP**
- **Rule Unmatched:** Select action for the traffic unmatching current rule; Forward to leave it pass through, and NEXT to check it by the next rule.

■ IP/MAC Filter Listing

- **#:** Item number.
- **Active:** Whether the connection is currently active.
- **Src IP Mask:** The source IP address or range of packets to be monitored.
- **Dest IP Mask:** This is the destination subnet IP address.
- **Src port:** This Port or Port Ranges defines the port allowed to be used by the Remote/WAN to connect to the application. Default is set from range **0 ~ 65535**. It is recommended that this option be configured by an advanced user.
- **Dest Port:** This is the Port or Port Ranges that defines the application.
- **Protocol:** It is the packet protocol type used by the application, select either **TCP** or **UDP** or **ICMP**
- **Unmatched:** It show this profile’s setting :Forward or NEXT

■ Application Filter

Access Management	Quick Start	Interface Setup	Advanced Setup	Access Management	Maintenance	Status	Help
	ACL	Filter	SNMP	UPnP	DDNS		

Filter

Filter Type

Filter Type Selection : ▼

Application Filter Editing

Application Filter : Activated Deactivated

ICQ : Allow Deny

MSN : Allow Deny

YMSG : Allow Deny

Real Audio/Video : Allow Deny

- **Application Filter:** Select this option to Activated/Deactivated the Application filter.
- **ICQ:** Select this option to Allow/Deny ICQ.
- **MSN:** Select this option to Allow/Deny MSN.
- **YMSG:** Select this option to Allow/Deny Yahoo messenger.
- **Real Audio/Video:** Select this option to Allow/Deny Real Audio/Video.

■ URL Filter

Access Management	Quick Start	Interface Setup	Advanced Setup	Access Management	Maintenance	Status	Help
	ACL	Filter	SNMP	UPnP	DDNS		

Filter

Filter Type

Filter Type Selection : URL Filter

URL Filter Editing

Active : Yes No

URL Index : 1

URL :

URL Filter Listing

Index	URL
1	
2	
3	
4	
5	
6	
7	
8	
9	
10	
11	
12	
13	
14	
15	
16	

SAVE DELETE CANCEL

● **Active:** Select **Yes** to enable URL Filter.

● **URL Index:** This is item number.

● **URL:** Allow you to prevent users on your network from accessing particular websites by their URL.

4.4.3 SNMP

Simple Network Management Protocol (SNMP) is a protocol used for exchanging management information between network devices. SNMP is a member of the TCP/IP protocol suite. BiPAC 5200N supports SNMP agent functionality which allows a manager station to manage and monitor the router through the network.

The screenshot shows the configuration interface for a BILLION ADSL Modem/Router. The top navigation bar includes 'Access Management', 'Quick Start', 'Interface Setup', 'Advanced Setup', 'Access Management', 'Maintenance', 'Status', and 'Help'. Under 'Access Management', there are sub-menus for 'ACL', 'Filter', 'SNMP', 'UPnP', and 'DDNS'. The 'SNMP' sub-menu is selected, showing a configuration page with two input fields: 'Get Community' and 'Set Community', both containing the text 'public'. A 'SAVE' button is located at the bottom of the configuration area.

● **Get Community:** Type the Get Community, which is the password for the incoming Get-and GetNext requests from the management station.

● **Set Community:** Type the Set Community, which is the password for incoming Set requests from the management station.

4.4.4 UPnP

UPnP offers peer-to-peer network connectivity for PCs and other network devices, along with control and data transfer between devices. UPnP offers many advantages for users running NAT routers through UPnP NAT Traversal, and on supported systems makes tasks such as port forwarding much easier by letting the application control the required settings, removing the need for the user to control advanced configuration of their device.

Both the user's Operating System and the relevant application must support UPnP in addition to the router. Windows XP and Windows Me natively support UPnP (when the component is installed), and Windows 98 users may install the Internet Connection Sharing client from Windows XP in order to support UPnP. Windows 2000 does not support UPnP.

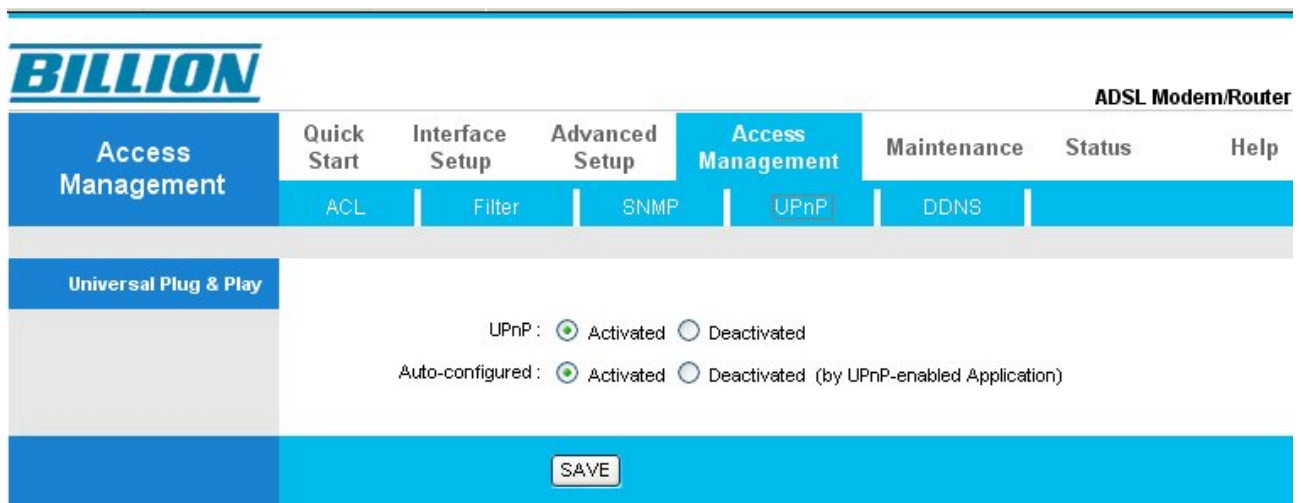

● **UPnP:** Select this checkbox to activate UPnP. Be aware that anyone could use a UPnP application to open the web configurator's login screen without entering the BiPAC 5200N 's IP address

● **Auto-configured:** Select this check box to allow UPnP-enabled applications to automatically configure the BiPAC 5200N so that they can communicate through the BiPAC 5200N, for example by using NAT traversal, UPnP applications automatically reserve a NAT forwarding port in order to communicate with another UPnP enabled device; this eliminates the need to manually configure port forwarding for the UPnP enabled application.

4.4.5 DDNS

The Dynamic DNS function allows you to alias a dynamic IP address to a static hostname, allowing users whose ISP does not assign them a static IP address to use a domain name. This is especially useful for hosting servers via your ADSL connection, so that anyone wishing to connect to you may use your domain name, rather than having to use your dynamic IP address, which changes from time to time. This dynamic IP address is the WAN IP address of the router, which is assigned to you by your ISP.

The screenshot shows the configuration page for Dynamic DNS on a BILLION ADSL Modem/Router. The page has a blue header with the BILLION logo and a navigation menu with tabs: Access Management, Quick Start, Interface Setup, Advanced Setup, Access Management, Maintenance, Status, and Help. Under the Access Management tab, there are sub-tabs: ACL, Filter, SNMP, UPnP, and DDNS. The DDNS sub-tab is selected, showing the Dynamic DNS configuration form. The form includes a 'Dynamic DNS' checkbox (currently unchecked), a 'Service Provider' field (pre-filled with 'www.dyndns.org'), and four input fields for 'My Host Name', 'E-mail Address', 'Username', and 'Password'. There is also a 'Wildcard support' checkbox (currently checked) with 'Yes' and 'No' radio buttons. A 'SAVE' button is located at the bottom of the form.

- **Dynamic DNS:** Select this check box to use Dynamic DNS.
- **Service Provider:** www.dyndns.org
- **My Host Name:** Type the domain name assigned to your BiPAC 5200N by your Dynamic DNS provider.
- **E-mail Address:** Type your e-mail address.
- **Username:** Type your user name.
- **Password:** Type the password assigned to you.
- **Wildcard support:** Select this check box to enable DYNDNS Wildcard.

4.5 Maintenance

4.5.1 Administrator

In factory setting, the default password is **admin**, and that for user is also password. You can change the default password to ensure that someone cannot adjust your settings without your permission. Every time you change your password, please record the password and keep it at a safe place.

The screenshot shows the BILLION ADSL Modem/Router web interface. The top navigation bar includes the BILLION logo and the text "ADSL Modem/Router". Below this is a menu with "Maintenance" selected. The "Maintenance" menu is expanded to show sub-options: Administration, Time Zone, Firmware, SysRestart, and Diagnostics. The "Administrator" section is active, displaying the following fields:

- Username : **admin**
- New Password :
- Confirm Password :

At the bottom of the form, there are two buttons: "SAVE" and "CANCEL".

- **New Password:** Type the new password in this field
- **Confirm Password:** Type the new password again in this field.

4.5.2 Time Zone

The router does not have a real time clock on board; instead, it uses the Simple Network Time Protocol (SNTP) to get the current time from an SNTP server outside your network. Choose your local time zone. After a successful connection to the Internet, the router will retrieve the correct local time from the SNTP server you have specified. If you prefer to specify an SNTP server other than those in the drop-down list, simply enter its IP address as shown above. Your ISP may provide an SNTP server for you to use.

The screenshot shows the BILLION ADSL Modem/Router web interface. The top navigation bar includes 'Quick Start', 'Interface Setup', 'Advanced Setup', 'Access Management', 'Maintenance', 'Status', and 'Help'. The 'Maintenance' menu is expanded, showing 'Administration', 'Time Zone', 'Firmware', 'SysRestart', and 'Diagnostics'. The 'Time Zone' page displays the current date and time as '01/01/2000 01:11:23'. Under 'Time Synchronization', there are three radio button options: 'NTP Server automatically' (selected), 'PC's Clock', and 'Manually'. Below these is a dropdown menu for 'Time Zone' set to '(GMT+08:00) Beijing, Hong Kong, Perth, Singapore, Taipei'. There are also radio buttons for 'Daylight Saving' set to 'Disabled'. At the bottom, there is a text input field for 'NTP Server Address' with the value '0.0.0.0' and a note '(0.0.0.0: Default Value)'. 'SAVE' and 'CANCEL' buttons are located at the bottom right.

- **Synchronize time with:** Select the time service protocol that your time server sends when you turn on the Router.
- **Time Zone:** Choose the time zone of your location. This will set the time difference between your time zone and Greenwich Mean Time (GMT).
- **Daylight Saving:** Select this option if you use daylight savings time
- **NTP Server Address:** Enter the IP address of your time server. Check with your ISP/network administrator if you are unsure of this information.

4.5.3 Firmware

Your router’s “firmware” is the software that allows it to operate and provides all its functionality. Think of your router as a dedicated computer, and the firmware as the software it runs. Over time this software may be improved and modified, and your router allows you to upgrade the software it runs to take advantage of these changes.

To upgrade the firmware of BiPAC 5200N, you should download or copy the firmware to your local environment first. Press the “**Browse...**” button to specify the path of the firmware file. Then, click “**Upgrade**” to start upgrading. When the procedure is completed, BiPAC 5200N will reset automatically to make the new firmware work.

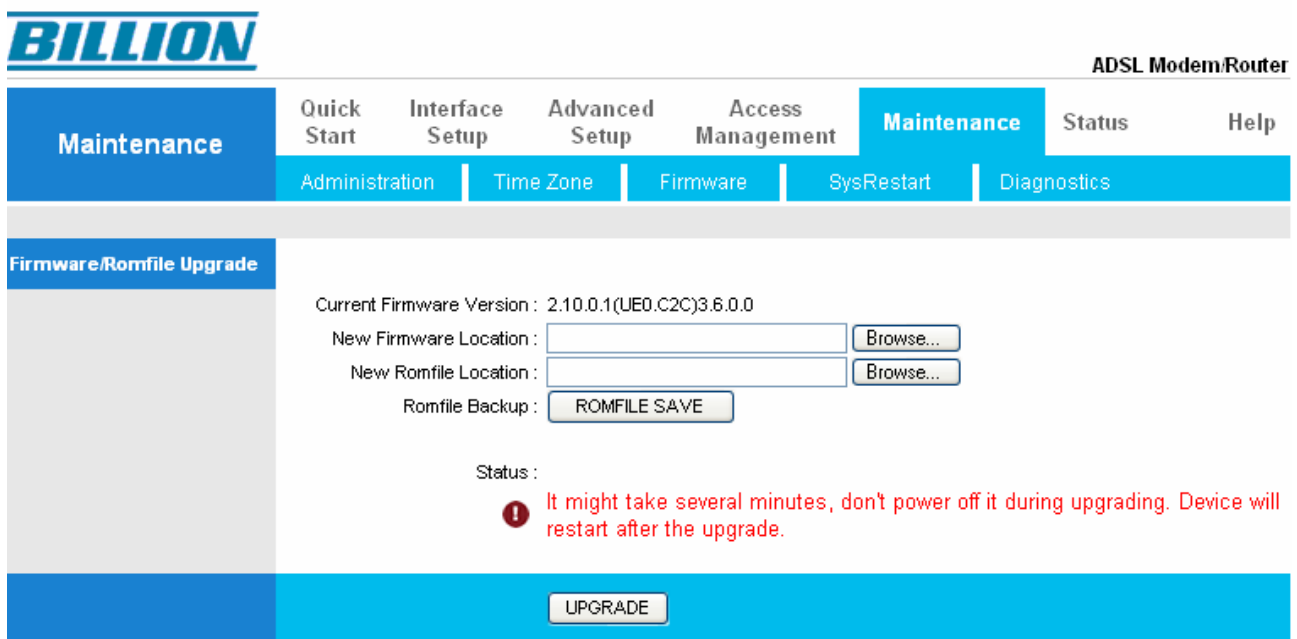

● **New Firmware Location:** Type in the location of the file you want to upload in this field or click **Browse** to find it.

● **New Romfile Location:** Romfile means the configuration file. Type in the location of the file you want to upload in this field or click **Browse** to find it.

● **Browse:** Click **Browse...** to find the .ras file you want to upload. Remember that you must decompress compressed (.zip) files before you can upload them.

● **Romfile Backup:** Click **ROMFILE SAVE** button to save current configuration file to your PC.

● **UPGRADE:** Click **UPGRADE** to begin the upload process. This process may take up to two minutes.

After two minutes, log in again and check your new firmware version in the System Status screen.

If the upload was not successful, the following screen will appear. Click Back to go back to the Firmware screen.



DO NOT power down the router or interrupt the firmware upgrading while it is still in process. Improper operation could damage the router.

Warning

4.5.4 SysRestart

Click **SysRestart** with option **Current Settings** to reboot your router (and restore your last saved configuration).

The screenshot shows the BILLION ADSL Modem/Router web interface. The top navigation bar includes 'Maintenance', 'Quick Start', 'Interface Setup', 'Advanced Setup', 'Access Management', 'Maintenance', 'Status', and 'Help'. The 'Maintenance' menu is expanded, showing 'Administration', 'Time Zone', 'Firmware', 'SysRestart', and 'Diagnostics'. The 'SysRestart' option is selected, leading to a 'System Restart' page. This page has a 'System Restart with:' section with two radio buttons: 'Current Settings' (selected) and 'Factory Default Settings'. A 'RESTART' button is located at the bottom of the page.

If you wish to restart the router using the factory default settings (for example, after a firmware upgrade or if you have saved an incorrect configuration), select **Factory Default Settings** to reset to factory default settings.

You may also reset your router to factory settings by holding the small Reset pinhole button on the back of your router in for 10-12 seconds whilst the router is turned on.

4.5.5 Diagnostics

The Diagnostic Test page shows the test results for the connectivity of the physical layer and protocol layer for both LAN and WAN sides

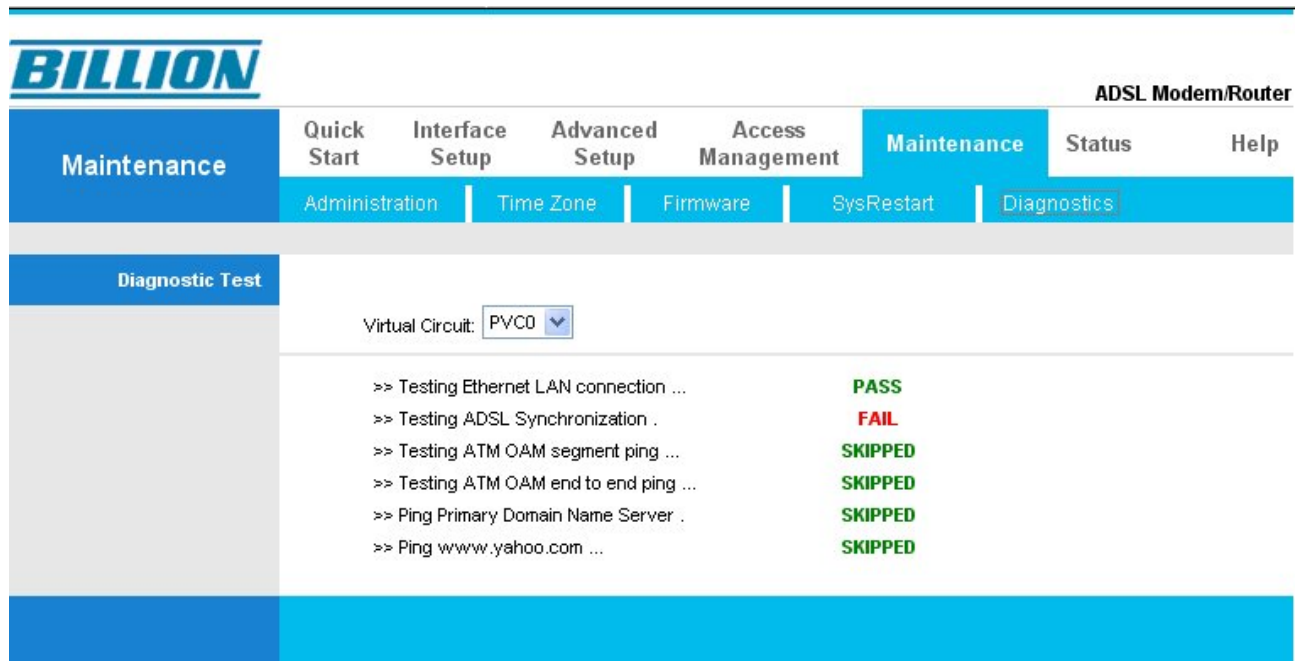

BILLION ADSL Modem/Router

Maintenance | Quick Start | Interface Setup | Advanced Setup | Access Management | **Maintenance** | Status | Help

Administration | Time Zone | Firmware | SysRestart | **Diagnostics**

Diagnostic Test

Virtual Circuit: PVC0

>> Testing Ethernet LAN connection ...	PASS
>> Testing ADSL Synchronization .	FAIL
>> Testing ATM OAM segment ping ...	SKIPPED
>> Testing ATM OAM end to end ping ...	SKIPPED
>> Ping Primary Domain Name Server .	SKIPPED
>> Ping www.yahoo.com ...	SKIPPED

4.6 Status

4.6.1 Device Info

This page displays the current information for the ADSL Router. It will display the Firmware version, LAN, WAN, and MAC address information.

BILLION ADSL Modem/Router

[Quick Start](#)
[Interface Setup](#)
[Advanced Setup](#)
[Access Management](#)
[Maintenance](#)
[Status](#)
[Help](#)

[Device Info](#)
[System Log](#)
[Statistics](#)

Device Information

Firmware Version : 2.11.24.1(NRE0.C29)3.9.9.1_NUWPS
 MAC Address : 00:aa:bb:01:23:45

LAN

IP Address : 192.168.1.254
 Subnet Mask : 255.255.255.0
 DHCP Server : Enabled

WAN

Virtual Circuit :
 Status : Not Connected
 Connection Type : PPPoE
 IP Address : 0.0.0.0
 Subnet Mask : 0.0.0.0
 Default Gateway : 0.0.0.0
 DNS Server : 0.0.0.0
 NAT : Enabled

ADSL

ADSL Firmware Version : FwVer:3.9.9.1_A_TC3085 HwVer:T14.F7_3.0
 Line State : Down
 Modulation : N/A
 Annex Mode : N/A

	Downstream	Upstream	
SNR Margin :	N/A	N/A	db
Line Attenuation :	N/A	N/A	db
Data Rate :	N/A	N/A	kbps

■ Device Information

● **Firmware Version:** This is the Firmware version

● **MAC Address:** This is the MAC Address

■ LAN

● **IP Address:** LAN port IP address.

- **Sub Net Mask:** LAN port IP subnet mask.
- **DHCP Server:** LAN port DHCP role - Enabled, Relay or disabled

■ WAN

- **Status:** “Not connected” or “Connected”
- **Virtual Circuit:** There are eight groups of PVC can be defined.
VPI: The valid range for the VPI is 0 to 255
VCI: The valid range for the VCI is 1 to 65535
- **Connection Type:** Name of the WAN connection.
- **IP Address:** WAN port IP address.
- **Subnet Mask:** WAN port IP subnet mask.
- **Default Gateway:** The IP address of the default gateway.
- **DNS Server:** WAN port DHCP role - Enabled, Relay or disabled
- **NAT:** Enabled or Disabled NAT function

■ ADSL

- **ADSL Firmware Version:** This is the DSL firmware version associated with your router
- **Line State:** This is the status of your ADSL link.
- **Modulation:** This field displays the ADSL modulation status for G.dmt or T1.413.
- **Annex Mode:** To show the router’s type, e.g. Annex A, Annex B
- **SNR Margin:** To show the router’s SNR margin for Downstream/Upstream
- **Line Attenuation :** To show the router’s for Downstream/Upstream
- **Data Rate:** To show the router’s data rate for Downstream/Upstream

4.6.2 System Log

Display system logs accumulated up to the present time. You can trace historical information with this function.

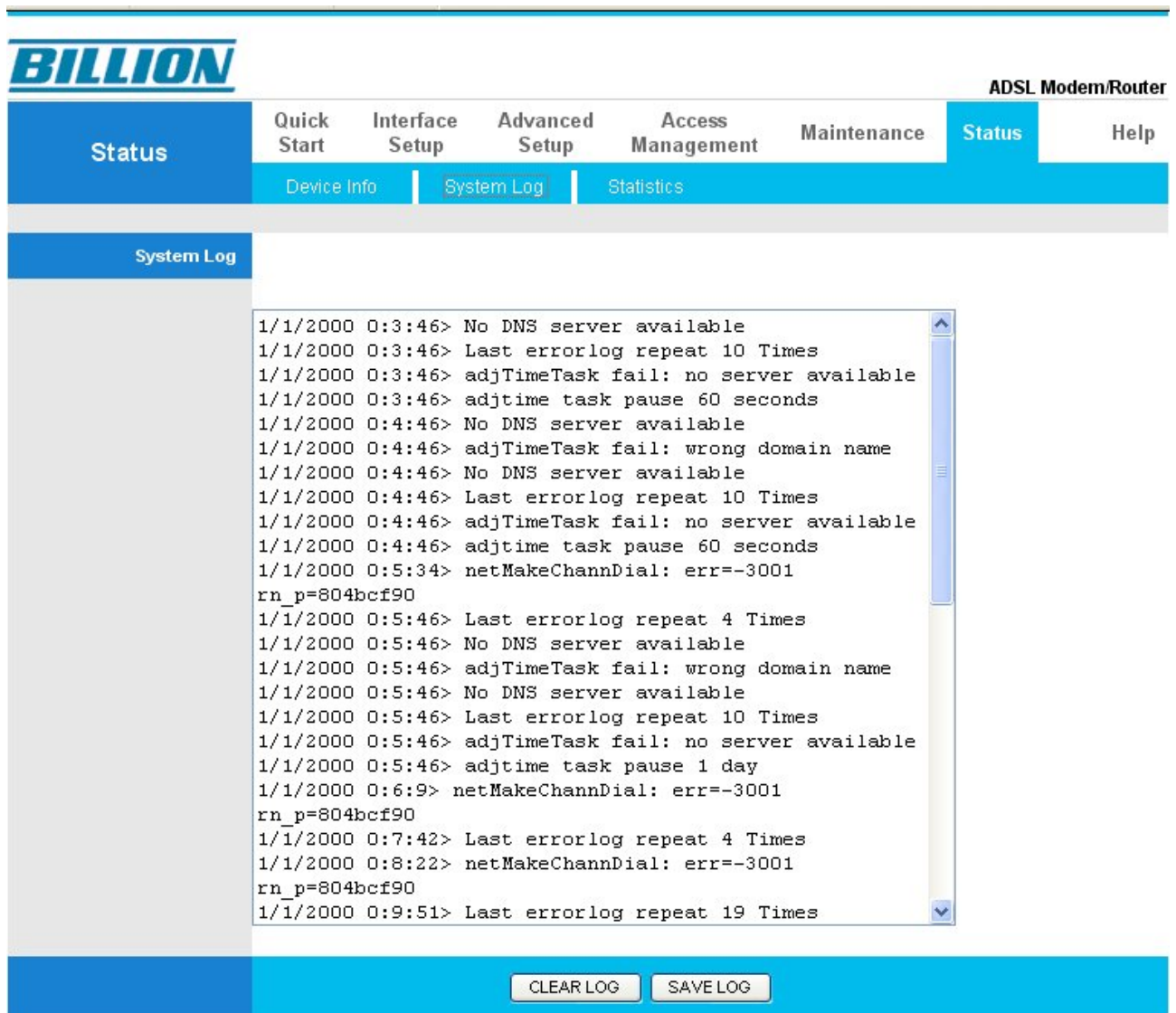

BILLION ADSL Modem/Router

Quick Start | Interface Setup | **Advanced Setup** | Access Management | Maintenance | **Status** | Help

Device Info | **System Log** | Statistics

System Log

```
1/1/2000 0:3:46> No DNS server available
1/1/2000 0:3:46> Last errorlog repeat 10 Times
1/1/2000 0:3:46> adjTimeTask fail: no server available
1/1/2000 0:3:46> adjtime task pause 60 seconds
1/1/2000 0:4:46> No DNS server available
1/1/2000 0:4:46> adjTimeTask fail: wrong domain name
1/1/2000 0:4:46> No DNS server available
1/1/2000 0:4:46> Last errorlog repeat 10 Times
1/1/2000 0:4:46> adjTimeTask fail: no server available
1/1/2000 0:4:46> adjtime task pause 60 seconds
1/1/2000 0:5:34> netMakeChannDial: err=-3001
rn_p=804bcf90
1/1/2000 0:5:46> Last errorlog repeat 4 Times
1/1/2000 0:5:46> No DNS server available
1/1/2000 0:5:46> adjTimeTask fail: wrong domain name
1/1/2000 0:5:46> No DNS server available
1/1/2000 0:5:46> Last errorlog repeat 10 Times
1/1/2000 0:5:46> adjTimeTask fail: no server available
1/1/2000 0:5:46> adjtime task pause 1 day
1/1/2000 0:6:9> netMakeChannDial: err=-3001
rn_p=804bcf90
1/1/2000 0:7:42> Last errorlog repeat 4 Times
1/1/2000 0:8:22> netMakeChannDial: err=-3001
rn_p=804bcf90
1/1/2000 0:9:51> Last errorlog repeat 19 Times
```

CLEAR LOG | SAVE LOG

4.6.3 Statistics

Read-only information here includes port status and packet specific statistics. Also provided are "Transmit Statistics" and "Receive Statistics".

Ethernet

The screenshot shows the BILLION ADSL Modem/Router web interface. The top navigation bar includes 'Quick Start', 'Interface Setup', 'Advanced Setup', 'Access Management', 'Maintenance', 'Status', and 'Help'. The 'Status' page has sub-tabs for 'Device Info', 'System Log', and 'Statistics'. The 'Traffic Statistics' section is active, showing the 'Interface' as 'Ethernet' (selected) and 'ADSL'. Below this is a table with 'Transmit Statistics' and 'Receive Statistics' data. A 'REFRESH' button is located at the bottom of the statistics section.

Transmit Statistics		Receive Statistics	
Transmit Frames	454	Receive Frames	69595
Transmit Multicast Frames	3779	Receive Multicast Frames	1133
Transmit total Bytes	2103645	Receive total Bytes	4854068
Transmit Collision	0	Receive CRC Errors	0
Transmit Error Frames	0	Receive Under-size Frames	0

- **Interface:** This field displays the type of port
- **Transmit Frames:** This field displays the number of frames transmitted in the last second.
- **Transmit Multicast Frames:** This field displays the number of multicast frames transmitted in the last second.
- **Transmit total Bytes:** This field displays the number of bytes transmitted in the last second.
- **Transmit Collision:** This is the number of collisions on this port.
- **Transmit Error Frames:** This field displays the number of error packets on this port.
- **Receive Frames:** This field displays the number of frames received in the last second.
- **Receive Multicast Frames:** This field displays the number of multicast frames received in the last second.
- **Receive total Bytes:** This field displays the number of bytes received in the last second.
- **Receive CRC Errors:** This field displays the number of error packets on this port.
- **Receive Under-size Frames:** This field displays the number of under-size frames received in the last second.

ADSL

The screenshot shows the BILLION ADSL Modem/Router web interface. The top navigation bar includes 'Quick Start', 'Interface Setup', 'Advanced Setup', 'Access Management', 'Maintenance', 'Status', and 'Help'. The 'Status' page is active, showing 'Device Info', 'System Log', and 'Statistics' sub-sections. The 'Traffic Statistics' section is selected, displaying 'Interface : Ethernet ADSL'. Below this is a table with the following data:

Transmit Statistics		Receive Statistics	
Transmit total PDUs	0	Receive total PDUs	0
Transmit total Error Counts	0	Receive total Error Counts	0

A 'REFRESH' button is located at the bottom of the statistics section.

● **Transmit total PDUs:** This field displays the number of total PDU transmitted in the last second.

● **Transmit total Error Counts:** This field displays the number of total error transmitted in the last second.

● **Receive total PDUs:** This field displays the number of total PDU received in the last second.

● **Receive total Error Counts:** This field displays the number of total error received in the last second.

WLAN (Future Release)

● **Tx Frames Count:** This field displays the number of frames transmitted in the last second.

● **Tx Errors Count:** This field displays the number of errors frames transmitted in the last second.

● **Tx Drops Count:** This field displays the number of drops frames transmitted in the last second.

● **Rx Frames Count:** This field displays the number of frames received in the last second.

● **Rx Errors Count:** This field displays the number of errors frames received in the last second.

● **Rx Drops Count:** This field displays the number of drops frames received in the last second.

4.7 Help

BILLION		ADSL Modem/Router					
Help	Quick Start	Interface Setup	Advanced Setup	Access Management	Maintenance	Status	Help
Quick Start			▶ Quick Start				
Interface Setup			▶ Internet Settings ▶ LAN Settings ▶ Wireless LAN Settings				
Advanced Setup			▶ Firewall ▶ Routing ▶ NAT ▶ QoS ▶ ADSL				
Access Management			▶ ACL ▶ IP Filter ▶ SNMP ▶ UPnP ▶ DDNS				
Maintenance			▶ Administration ▶ Time Zone ▶ Firmware ▶ SysRestart ▶ Diagnostics				
Status			▶ Device Info ▶ System Log ▶ Statistics				

Chapter 5

Troubleshooting

If the ADSL2+ Router is not functioning properly, you can refer first to this chapter for simple troubleshooting before contacting your service provider. This could save your time and effort but if the symptoms persist, then consult your service provider.

Problems starting up the router

Problem	Corrective Action
None of the LEDs are on when you turn on the router.	Check the connection between the adapter and the router. If the error persists, you may have a hardware problem. In this case you should contact technical support.
You have forgotten your router login and/or password.	Try the default login and password, please refers to Chapter 3. If this fails, you can restore your router to its factory settings by holding the Reset button on the back of your router for 6 seconds above.

Problems with the WAN Interface

Problem	Corrective Action
<p>Initialization of the PVC connection (“linesync”) failed.</p>	<p>Ensure that the telephone cable is connected properly from the ADSL port to the wall jack. The ADSL LED on the front panel of the router should be on. Check that your VPI, VCI, encapsulation type and type of multiplexing settings are the same as those provided by your ISP. Reboot the router GE. If you still have problems, you may need to verify these settings with your ISP.</p>
<p>Frequent loss of ADSL linesync (disconnections).</p>	<p>Ensure that all other devices connected to the same telephone line as your router (e.g. telephones, fax machines, analogue modems) have a line filter connected between them and the wall socket (unless you are using a Central Splitter or Central Filter installed by a qualified and licensed electrician), and ensure that all line filters are correctly installed and the right way around. Missing line filters or line filters installed the wrong way around can cause problems with your ADSL connection, including causing frequent disconnections.</p>

Problems with the LAN Interface

Problem	Corrective Action
<p>Can’t ping any PCs on the LAN.</p>	<p>Check the Ethernet LEDs on the front panel. The LED should be on for a port that has a PC connected. If it is off, check the cables between your router and the PC. Make sure you have uninstalled any software firewall for troubleshooting.</p>
	<p>Verify that the IP address and the subnet mask are consistent between the router and the workstations.</p>

APPENDIX

Product Support and Contact Information

Most problems can be solved by referring to the **Troubleshooting** section in the User's Manual. If you cannot resolve the problem with the **Troubleshooting** chapter, please contact the dealer where you purchased this product.

Contact Billion

WORLDWIDE

<http://www.billion.com>