

BESSEY® Clamping - and Cutting Technology

Specialty Clamping Systems

Effective July 1 2008.



Simply better.

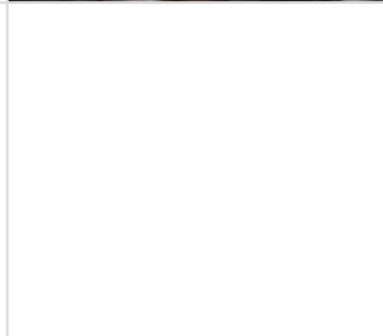
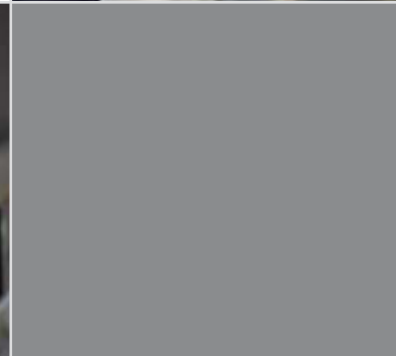
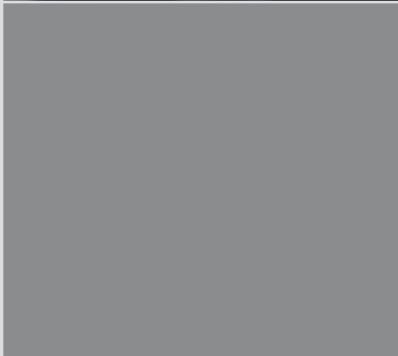

BESSEY®. Simply better.

Best clamping - and cutting technology since 1889.

“One, who stops improving himself, has already ceased to be good” - we behave and work as per this guiding principle of Max Bessey, the founder of our company. Again and again, over 110 years already. Simply go and see for yourself: An overview of our entire range of products - and services is given in the following pages. Be it clamping - or cutting technology, BESSEY® offers incomparably innovative solutions with the proven BESSEY® quality.

Make the most of our innovative edge and experience why the following still holds true in our industry:

“BESSEY®. Simply better.”

Innovative ideas

Our company has been setting new benchmarks in the field of clamping and cutting technology since its inception in the year 1889. Based on our expertise in development, we have been working on new and innovative ideas for continuous product improvement. We invent and perfect the patented brands in our plant in Bietigheim, these often become models for an entire generation of clamping and cutting tools.

Often copied, but never duplicated: This applies to the original BESSEY® malleable cast iron-screw clamps introduced in 1936, or even to the original BESSEY® all-steel-screw clamps that were patented in 1952.



Highest quality

Our fundamental principle: BESSEY® brands have been manufactured for constant loads, not for temporary ones against the comparable products of our competitors. We have distinguished ourselves and earned the respect of customers for decades owing to our unrivalled quality.

Our brands are manufactured using the highest quality materials. Moreover, all components are personally checked by our experienced technicians and developers who apply the most advanced inspection procedures and testing methods. We do this for you as a customer using our products in daily, practical use.

We always guarantee you maximum comfort, safety, user-friendliness and ergonomics. Numerous certificates as well as longstanding partners and customers in more than 100 countries all over the world are the best proof. Prove it to yourself and try one!



Why buy BESSEY®?

- Quality
- Innovation
- Great value
- End-user comfort
- Superior engineering



Customer Category	Discount (Multiplier) From List Price in Catalog			
	VB0001	VB0002	VB0003	VD0001 & VD0002



Experienced technicians and developers personally check every BESSEY® product.



Longstanding global partners and customers in more than 100 countries have faith in BESSEY® quality.

Wide range of products and services.

While browsing through this catalogue, you will observe that BESSEY® strives to offer you the best solution for your tasks and applications. In clamping, as well as cutting technology. From rigid to flexible clamping, from curved to straight cutting. From heavy duty clamps to light lever clamps, from delicate Jewellers' snips to robust titanium coated cutters.

Personal service

Reliability, confidence and a sense of responsibility are the backbone of our partnership with our customers. For many years, we have been working towards manufacturing exclusive and practical brands that will simplify your life considerably today - as well as tomorrow. Of late, we have started supporting our trading partners with comprehensive product training programs in a personal and informal atmosphere. Directly on-site in Bietigheim, in our in-house training centre and, in the field where our distributors and personnel work, live and play.



Pipe clamps

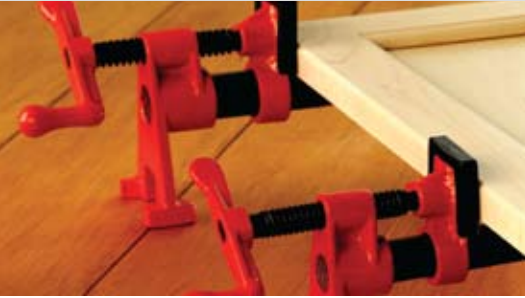

- “H” shape foot assembly stabilizes clamp in two dimensions giving dual-axis stability
- Extra high base provides industry leading clearance from the work surface
- Cast jaws for durability, smooth action spindle



“H” style pipe clamp fixtures

BESSEY® Product #	Black Pipe Diameter	Approx. Weight	Case
	Inches	Pounds	qty.
BPC-H34	3/4	3.05	4
BPC-H12	1/2	2.05	4

* BPC comes in retail ready full colour clamshell packaging

Standard pipe clamp fixtures

BESSEY® Product #	Black Pipe Diameter	Approx. Weight	Case
	Inches	Pounds	qty.
PC34	3/4	2.40	20
PC12	1/2	1.65	20
PC34-DR	3/4	2.15	12

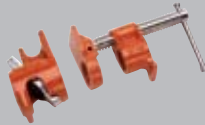

- Fast-easy adjusting moveable jaw – simply slide to work piece and place lock pin in perforated rail
- Rugged construction – cast iron jaw, steel rail



T-bar sash clamps

BESSEY® Product #	Throat Depth	Clamping Capacity	Clamping Force	Approx. Weight	Case
	Inches	Inches	Pounds	Pounds	qty.
BT-36	2	39	3990	18.00	1
BT-96	2	98	3330	32.00	1
BT-120	2	120	2660	40.00	1



- Twin vacuum cups for clamping non-porous, solid surface material such as granite, marble, corian, plastic or glass
- Levelling toggles ensure smooth surface joint, reduces grinding, sanding and finishing
- For laying parquet, plank and laminate flooring
- 13 ft. strap

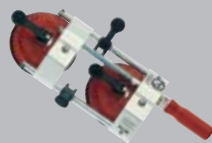

PS55 Seaming Tool

BESSEY® Product #	Clamping Capacity	Cup Diameter	Clamping Force	Approx. Weight	Case
	Inches	Inches	Pounds	Pounds	qty.
PS55	2 1/8	5	48 1/2	3.80	1

Flooring strap clamps

BESSEY® Product #	Strap Length	Clamp Plate Width	Clamping Force	Approx. Weight	Case
	Inches	Inches	Pounds	Pounds	qty.
SVH400XL	300	4 3/4	220	1.80	5
VSA	Suction adapter			1.10	1
SVHD	Angle adapter			0.85	1



BESSEY® PS55 Seaming Tool

Professional Solid Surface Installation Clamp



Simply better.

Eliminates the need for messy glue blocks & reduces the amount of joint clean up required ...a great time saver!

Vacuum Cups ... instantly secures the PS55 to any smooth, non-porous material such as solid surface, SSV laminate, polished marble and granite to eliminate the need for glue blocks. Cup made from rugged high-pressure aluminum alloy with the highest quality rubber diaphragm.

Vacuum Operating Lever ... activates and locks the vacuum seal on the work surface. Quick release. Completely portable.

Leveling Toggles ... this unique feature easily and accurately levels deck joints during seaming ... reducing the need for sanding.

Work Hardened Steel Spindle ... smoothly draws deck seams together with just the right pressure. Galvanized spindle will hold up to years of wear.

Oversized Wooden Handle ... comfortable for any hand.

Cold Drawn Guide Rods ... create a solid, rigid frame for supporting vacuum cups and leveling toggles... minimizing panel lifting.

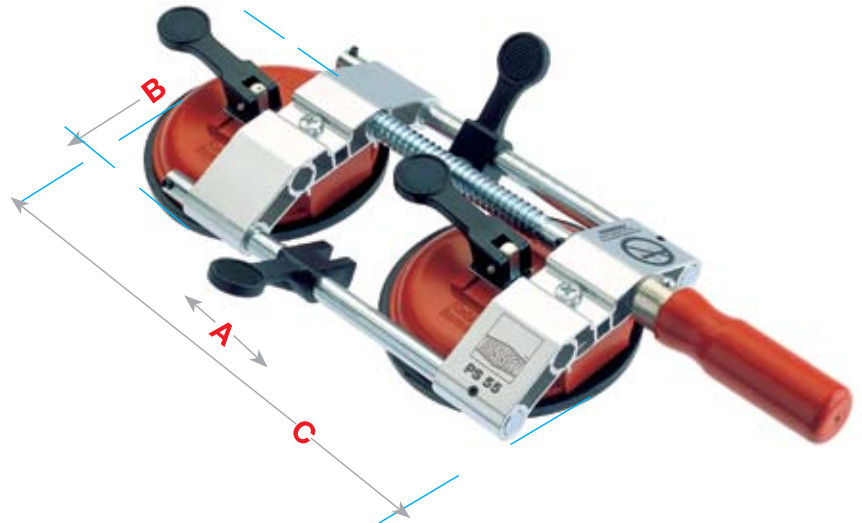

Cat. No.	Nominal Span	Nominal Width	Nominal Length	Nominal Pressure
	A	B	C	
PS55	2.1"	5.1"	9.4" - 11.6"	48.5 lb.

BESSEY® Tools North America reserves the right to alter technical specifications. Some product may vary from region to region to meet the requirements of the international marketplace. Errors and omissions excepted, BESSEY® believes that to the best of its knowledge the product illustrations and descriptions provided in this catalog are accurate. However, such descriptions and illustrations are for the sole purpose of identification, and do not express or imply any warranty or condition that the Products are merchantable, or fit for a particular purpose or that the products will necessarily conform to the illustrations or descriptions. Customer is solely responsible for reliance on or use of any information, and for use or application of any product. BESSEY® expressly disclaims any liability for direct, indirect, consequential or incidental damages in all events and for all damages, losses and causes of action beyond the purchase price paid for the products in question.

WARRANTY POLICY

BESSEY® brand clamping products are warranted under a Limited Lifetime program. We warranty that the products will be free from defects in material and workmanship for the life of the tool or we will replace, refund or repair it; provided that this warranty does not cover any damage caused by abuse, misuse, improper handling, negligence, alteration or normal wear and tear. Other tools including but not limited to snips, c-clamps, some specialty clamps, magnets, bearing heaters and pyrometers are guaranteed for 1 year. For all products, BESSEY® Tools North America reserves the right to refuse either a repair or a replacement.

BESSEY® Tools North America makes no other warranties, express or implied, with respect to the tools or their suitability for specific applications. BESSEY® Tools North America neither assumes, nor authorizes any person to assume for it, any other warranty, or obligation express or implied. For a more detailed listing of Terms, Conditions and Warranty please contact BESSEY® Tools North America direct and toll-free at 1.800.828.1004.

BESSEY® Tools North America will, at its sole discretion, define if a product submitted for warranty evaluation is eligible for a warranty return and then, if eligible, offer either to repair, refund or replace any defective product. To initiate such a claim, please call and request a return authorization number then, return all parts of the broken tool(s) plus a written warranty evaluation request (with contact information) in a freight prepaid format to BESSEY® Tools North America.

This warranty gives you specific legal rights. Please note: you may also have other rights, which could vary depending upon state, federal and provincial law.

CAUTION: Clamping Tools

Clamping tools are not suitable for lifting, pulling or transporting. Improper use may lead to personal injuries or material damages. They should only be clamped manually without using any auxiliary tools.

CAUTION: Cutting Technology

Always wear appropriate protection including goggles and gloves while working. Sheared parts may injure the workers and bystanders. Disconnect the power supply while working on electrical devices to avoid the risk of electric shock. Always ensure the cutting direction while using snips, knives and cutters is away from your body. Only use original replacement parts whenever required. Tools should only be used manually without using any auxiliary tools. Improper use may lead to personal injuries or material damages.

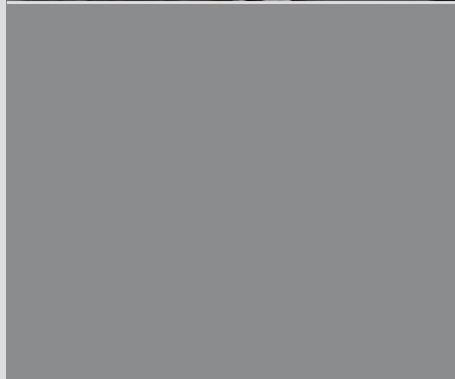
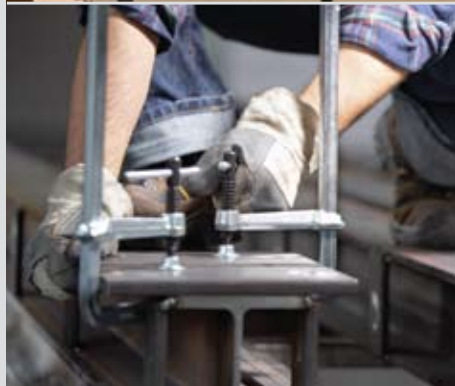
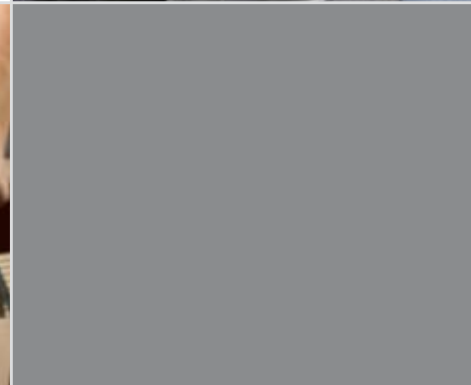

BESSEY® Tools North America

Cambridge, ON N1R 8E1

P.O.Box 399, Leroy, NY 14482

Toll Free: 800.828.1004

Fax: 519.621.3442

General Email: info@besseytools.com

www.besseytools.com



Simply better.



BESSEY® Tools North America
Telephone: 800.828.1004

www.besseystools.com