

**BODYGUARD**

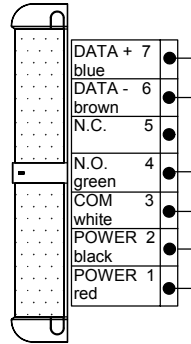

**24 V TRANSFORMER**

**EAGLE**

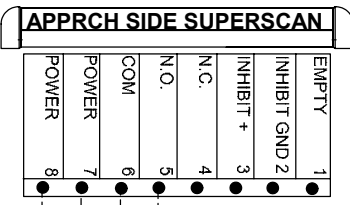
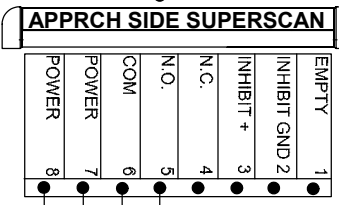
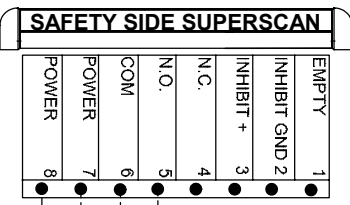
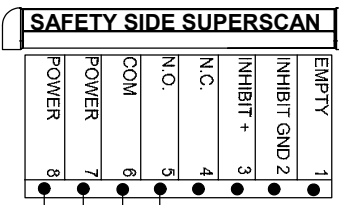
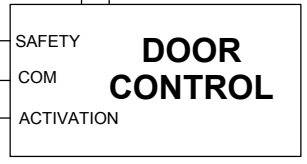
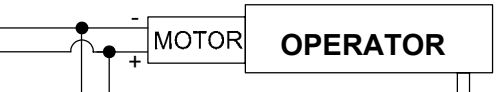
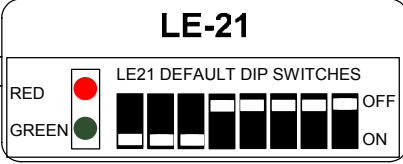
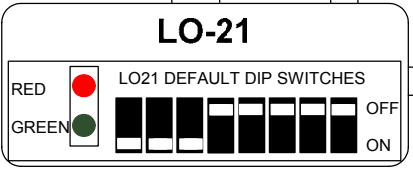
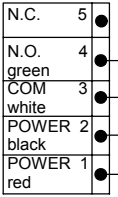
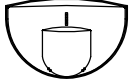

100 ENTERPRISE DRIVE  
 PITTSBURGH, PA 15275  
 PHONE: (412) 249-4100  
 FAX: (412) 249-4101  
 EMAIL: www.beasensors.com

**TITLE: LE-21 WITH LO-21, BODYGUARD & SUPERSCANS**

NOTE: SWITCH MUST OPEN 10 DEGREES FROM DOOR CLOSING

IF AFTER TROUBLESHOOTING A PROBLEM, A SATISFACTORY SOLUTION CANNOT BE ACHIEVED, PLEASE CALL B.E.A., INC. FOR FURTHER ASSISTANCE DURING EASTERN STANDARD TIME AT 1-800-523-2462 FROM 8AM - 5PM. FOR AFTER-HOURS, CALL EAST COAST: 1-866-836-1863 OR 1-800-407-4545 / MID-WEST: 1-888-308-8843 / WEST COAST: 1-888-419-2564. DO NOT LEAVE ANY PROBLEM UNRESOLVED. IF YOU MUST WAIT FOR THE FOLLOWING WORKDAY TO CALL B.E.A., LEAVE THE DOOR INOPERABLE UNTIL SATISFACTORY REPAIRS CAN BE MADE. NEVER SACRIFICE THE SAFE OPERATION OF THE AUTOMATIC DOOR OR GATE FOR AN INCOMPLETE SOLUTION. WEB: WWW.BEASENSORS.COM

|         |               |                   |                     |
|---------|---------------|-------------------|---------------------|
| SIZE: A | DRAWN BY: KJG | REV BY: KJG       | PART NO: 80.0025.02 |
|         | SCALE: NONE   | DATE: 22 MAY 2005 | SHEET 1 OF 1        |

**BODYGUARD**



**DK-12**

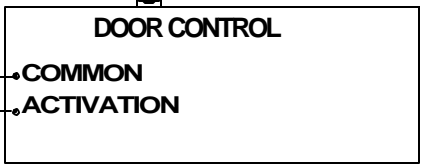
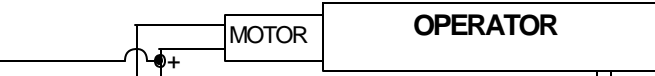
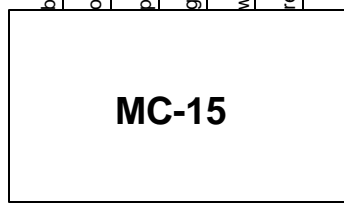
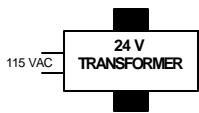
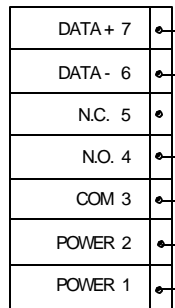

FOR PAIR OF DOORS

DOOR POSITION SWITCH

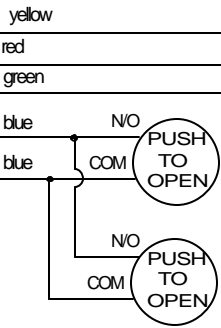
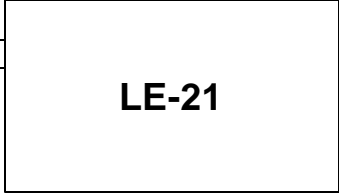
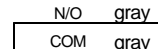

Closed contact when door is closed



**B.E.A., Inc.**  
 100 Enterprise Drive, Pittsburgh, PA 15275  
 PH: (412) 249-4100 FAX: (412) 249-4101

**TITLE: LE-21 WITH MC-15, BODYGUARD, APPROACH SIDE SUPERSkans**

|             |                 |                 |                |               |         |
|-------------|-----------------|-----------------|----------------|---------------|---------|
| SIZE: A     | CAGE CODE:      | DWG NO: 80.0031 | FILE OF: ENG'G | DRAWN BY: JED | REV: 01 |
| SCALE: NONE | DATE: 02 JAN 04 | SHEET: 1 OF 1   |                |               |         |

**BODYGUARD**



**DK-12**

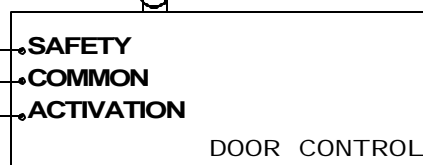
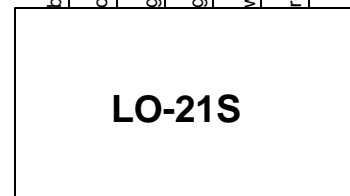
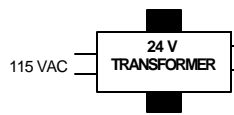
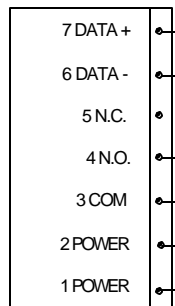

DOOR POSITION SWITCH

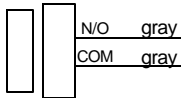

Closed contact when door is closed

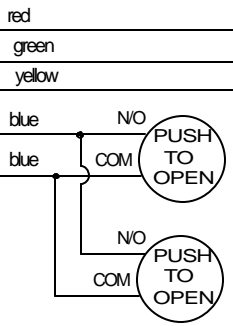
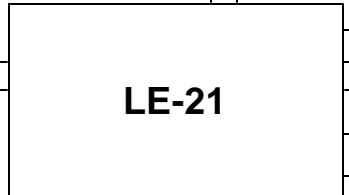

NOTE: 1) LO-21S IS WIRED INTO LE-21 TO ELIMINATE THE PUSH AND GO EFFECT.



**B.E.A., Inc.**  
100 Enterprise Drive, Pittsburgh, PA 15275  
PH: (412) 249-4100 FAX: (412) 249-4101

**TITLE: LO-21S ACTIVATION WIRED TO LE-21 TO ELIMINATE PUSH-N-GO EFFECT**

|             |                 |                 |                |               |         |
|-------------|-----------------|-----------------|----------------|---------------|---------|
| SIZE: A     | CAGE CODE:      | DWG NO: 80.0032 | FILE OF: ENG'G | DRAWN BY: JED | REV: 01 |
| SCALE: NONE | DATE: 02 JAN 04 | SHEET: 1 OF 1   |                |               |         |

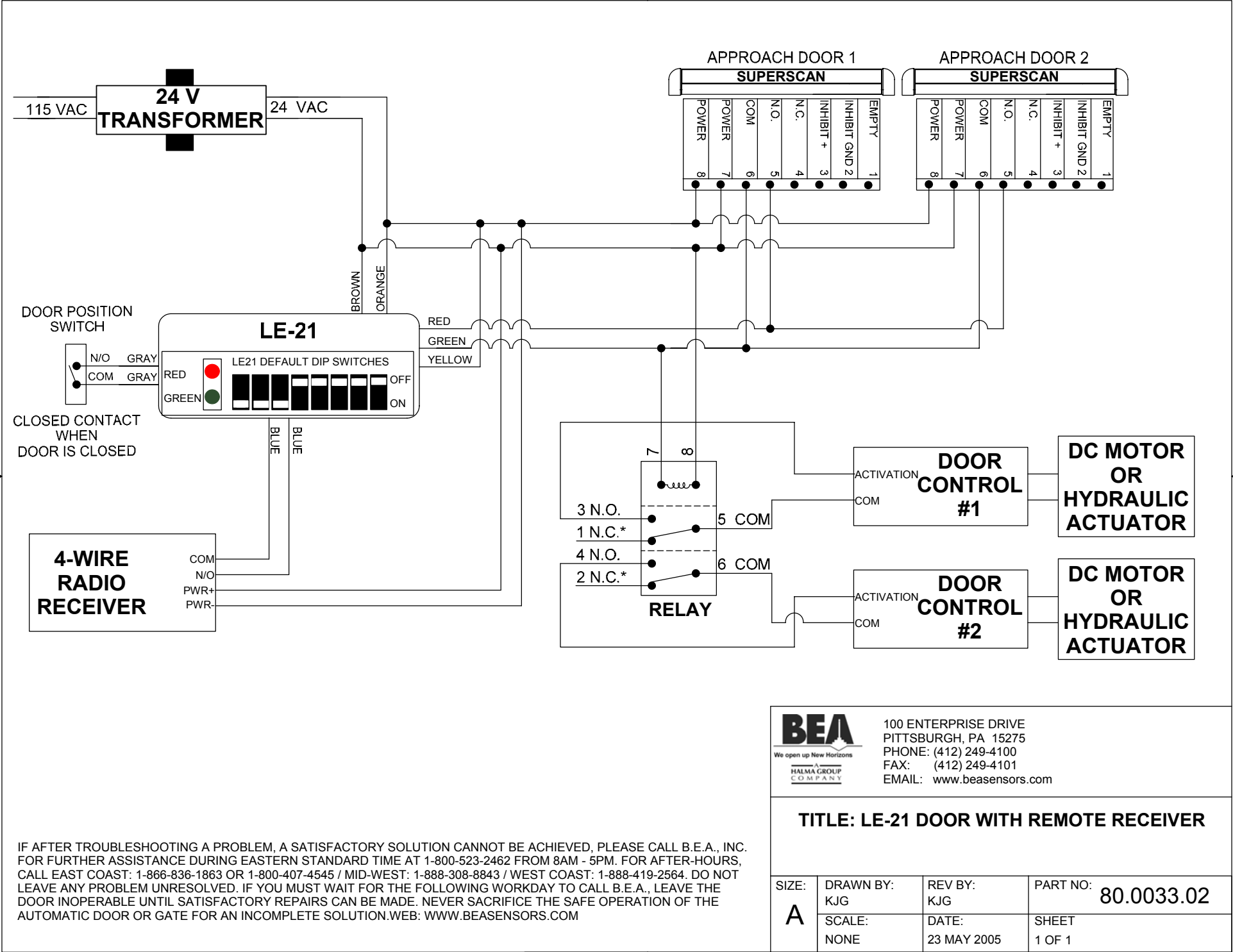

IF AFTER TROUBLESHOOTING A PROBLEM, A SATISFACTORY SOLUTION CANNOT BE ACHIEVED, PLEASE CALL B.E.A., INC. FOR FURTHER ASSISTANCE DURING EASTERN STANDARD TIME AT 1-800-523-2462 FROM 8AM - 5PM. FOR AFTER-HOURS, CALL EAST COAST: 1-866-836-1863 OR 1-800-407-4545 / MID-WEST: 1-888-308-8843 / WEST COAST: 1-888-419-2564. DO NOT LEAVE ANY PROBLEM UNRESOLVED. IF YOU MUST WAIT FOR THE FOLLOWING WORKDAY TO CALL B.E.A., LEAVE THE DOOR INOPERABLE UNTIL SATISFACTORY REPAIRS CAN BE MADE. NEVER SACRIFICE THE SAFE OPERATION OF THE AUTOMATIC DOOR OR GATE FOR AN INCOMPLETE SOLUTION. WEB: WWW.BEASENSORS.COM

**BEA**  
 We open up New Horizons  
 HALMA GROUP COMPANY  
 100 ENTERPRISE DRIVE  
 PITTSBURGH, PA 15275  
 PHONE: (412) 249-4100  
 FAX: (412) 249-4101  
 EMAIL: www.beasensors.com

**TITLE: LE-21 DOOR WITH REMOTE RECEIVER**

|                   |                  |                      |                               |
|-------------------|------------------|----------------------|-------------------------------|
| SIZE:<br><b>A</b> | DRAWN BY:<br>KJG | REV BY:<br>KJG       | PART NO:<br><b>80.0033.02</b> |
|                   | SCALE:<br>NONE   | DATE:<br>23 MAY 2005 | SHEET<br>1 OF 1               |

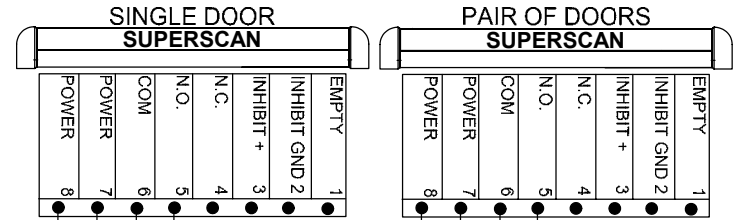

DOOR POSITION SWITCH

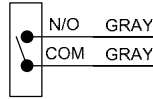

CLOSED CONTACT WHEN DOOR IS CLOSED

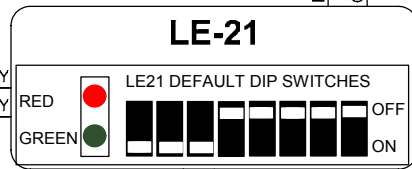

RED

GREEN

YELLOW

BLUE

BLUE

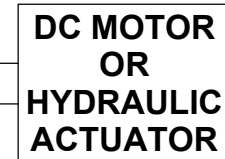

IF AFTER TROUBLESHOOTING A PROBLEM, A SATISFACTORY SOLUTION CANNOT BE ACHIEVED, PLEASE CALL B.E.A., INC. FOR FURTHER ASSISTANCE DURING EASTERN STANDARD TIME AT 1-800-523-2462 FROM 8AM - 5PM. FOR AFTER-HOURS, CALL EAST COAST: 1-866-836-1863 OR 1-800-407-4545 / MID-WEST: 1-888-308-8843 / WEST COAST: 1-888-419-2564. DO NOT LEAVE ANY PROBLEM UNRESOLVED. IF YOU MUST WAIT FOR THE FOLLOWING WORKDAY TO CALL B.E.A., LEAVE THE DOOR INOPERABLE UNTIL SATISFACTORY REPAIRS CAN BE MADE. NEVER SACRIFICE THE SAFE OPERATION OF THE AUTOMATIC DOOR OR GATE FOR AN INCOMPLETE SOLUTION.WEB: WWW.BEASENSORS.COM

100 ENTERPRISE DRIVE  
PITTSBURGH, PA 15275  
PHONE: (412) 249-4100  
FAX: (412) 249-4101  
EMAIL: www.beasensors.com

**TITLE: LE-21 DOOR WITH REMOTE**

|         |               |                   |                     |
|---------|---------------|-------------------|---------------------|
| SIZE: A | DRAWN BY: KJG | REV BY: KJG       | PART NO: 80.0034.02 |
|         | SCALE: NONE   | DATE: 23 MAY 2005 | SHEET 1 OF 1        |