



A-16II Personal Mixer

User Guide

Information in this document is subject to change. All rights reserved.
Copyright ©2004 Aviom, Inc. Printed in USA

Aviom, Inc.

1157 Phoenixville Pike Suite 201
West Chester, PA 19380 USA

+1 610-738-9005



+1 610-738-9950 (fax)

www.aviom.com

READ THIS FIRST

Important Safety Instructions



1. Read these instructions.
2. Keep these instructions
3. Heed all warnings.
4. Follow all instructions.
5. Do not use this apparatus near water.
6. Clean only with a dry cloth.
7. Do not block any ventilation openings. Install in accordance with the manufacturer's instructions.
8. Do not install near any heat sources such as radiators, heat registers, stoves, or other apparatus (including amplifiers) that produce heat.
9. Do not defeat the safety purpose of the polarized or grounding-type plug. A polarized plug has two blades with one wider than the other. A grounding type plug has two blades and a third grounding prong. The wide blade or third prong are provided for your safety. If the provided plug does not fit your outlet, consult an electrician for replacement of the obsolete outlet.
10. Protect the power cord from being walked on or pinched, particularly at plugs, convenience receptacles, and the point where they exit the apparatus.
11. Only use attachments/accessories specified by the manufacturer.
12. Use only with the cart, stand, tripod, bracket, or table specified by the manufacturer, or sold with the apparatus. When a cart is used, use caution when moving the cart/apparatus combination to avoid injury from tip-over.
13. Unplug this apparatus during lightning storms or when unused for long periods of time.
14. Refer all servicing to qualified personnel. Servicing is required when the apparatus has been damaged in any way, such as when the power-supply cord or plug is damaged, liquid has been spilled or objects have fallen into the apparatus, the apparatus has been exposed to rain or moisture, does not operate normally, or has been dropped.
15. No on/off power switches are included in the A-16 system. The external power supply should be used to control power to an Aviom A-16 device. This power supply should remain readily operable.
16. The solid line over dashed line symbol () indicates that the input voltage must be a DC voltage.
17. The box within a box symbol () indicates that the external power supply is double insulated.



Aviom, Inc. Limited Warranty

Aviom, Inc. warrants this product against defects in materials and workmanship for a period of **one year** from the date of the original retail purchase.

This warranty does not apply if the equipment has been damaged due to misuse, abuse, accident, or problems with electrical power. The warranty also does not apply if the product has been modified in any way, or if the product serial number has been damaged, modified, or removed.

If a defect is discovered, first write or call Aviom, Inc. to obtain a Return Authorization number. No service will be performed on any product returned without prior authorization. Aviom, Inc. will, at its option, repair or replace the product at no charge to you. The product must be returned during the warranty period, with transportation charges prepaid to Aviom, Inc., 1157 Phoenixville Pike, Suite 201, West Chester, PA 19380. You must use the product's original packing materials for shipment. Shipments should be insured for the value of the product. Include your name, address, phone number, description of the problem, and copy of the original bill of sale with the shipment. The Return Authorization number should be written on the outside of the box.

THIS LIMITED WARRANTY GIVES YOU SPECIFIC LEGAL RIGHTS. YOU MAY HAVE OTHER RIGHTS, WHICH VARY FROM STATE TO STATE (OR JURISDICTION TO JURISDICTION). AVIOM'S RESPONSIBILITY FOR MALFUNCTIONS AND DEFECTS IN HARDWARE IS LIMITED TO REPAIR AND REPLACEMENT AS SET FORTH IN THIS LIMITED WARRANTY STATEMENT. ALL EXPRESS AND IMPLIED WARRANTIES FOR THE PRODUCT, INCLUDING BUT NOT LIMITED TO ANY IMPLIED WARRANTIES OF MERCHANTABILITY AND FITNESS FOR A PARTICULAR PURPOSE, ARE LIMITED IN DURATION TO THE WARRANTY PERIOD SET FORTH ABOVE. NO WARRANTIES, WHETHER EXPRESS OR IMPLIED, WILL APPLY AFTER SUCH PERIOD.

AVIOM, INC. DOES NOT ACCEPT LIABILITY BEYOND THE REMEDIES SET FORTH IN THIS LIMITED WARRANTY DOCUMENT. AVIOM, INC.'S LIABILITY IS LIMITED TO THE REPAIR OR REPLACEMENT, AT OUR OPTION, OF ANY DEFECTIVE PRODUCT, AND SHALL IN NO EVENT INCLUDE INCIDENTAL OR CONSEQUENTIAL DAMAGES OF ANY KIND.

SOME STATES DO NOT ALLOW EXCLUSIONS OR LIMITATION OF IMPLIED WARRANTIES OR LIABILITY FOR INCIDENTAL OR CONSEQUENTIAL DAMAGES, SO THE ABOVE LIMITATIONS MAY NOT APPLY TO YOU.

Aviom and the Aviom logo are trademarks of Aviom, Inc.



WARNING!



TO REDUCE THE DANGER OF ELECTRICAL SHOCK DO NOT REMOVE COVERS. NO USER SERVICEABLE PARTS INSIDE

REFER SERVICING TO QUALIFIED SERVICE PERSONNEL ONLY

- To reduce the risk of fire or electrical shock, do not expose this product to rain or other types of moisture.
- To avoid the hazard of electrical shock, do not handle the power cord with wet hands.
- Operating Temperature: 10°C to 40°C (50°F to 105°F)

 CAUTION Risk of electric shock! Do Not Open AVIS: Risque de choc électrique! Ne pas ouvrir	 WARNING! To reduce the risk of fire or electric shock do not expose this product to rain or moisture.
--	--

CAUTION:

- Using any audio system at high volume levels can cause permanent damage to your hearing.
- Set your system volume as low as possible.
- Avoid prolonged exposure to excessive sound pressure levels.

IMPORTANT:

This equipment has been tested and found to comply with the limits for a Class B digital device, pursuant to part 15 of the FCC Rules. These limits are designed to provide reasonable protection against harmful interference in a residential installation. This equipment generates, uses and can radiate radio frequency energy and, if not installed and used in accordance with the instructions, may cause harmful interference to radio communications. However, there is no guarantee that interference will not occur in a particular installation. If this equipment does cause harmful interference to radio or television reception, which can be determined by turning the equipment off and on, the user is encouraged to try to correct the interference by one or more of the following measures:

- Reorient or relocate the receiving antenna.
- Increase the separation between the equipment and receiver.
- Connect the equipment into an outlet on a circuit different from that to which the receiver is connected.
- Consult the dealer or an experienced radio/TV technician for help.

Changes or modifications to the product not expressly approved by Aviom, Inc. could void the user's FCC authority to operate the equipment.

Table of Contents

Welcome	1
Features.....	1
Conventions Used in this Document	1
Warranty Information	2
Package Contents	3
AC Line Conditioning	3
Channel Labels	4
What is Category 5?	5
Cables Used in the Aviom System	5
Cable Lengths	7
About A-Net	7
Power Supplies	8
Cleaning and Maintenance Information	9
The A-16II Personal Mixer	10
Personal Mixer Components.....	11
System Setup	12
Power Connection	12
System Interconnections	12
Audio Connections — Outputs	12
Labeling the Channels	13
Operational Modes.....	14
Global Controls.....	15
Tone Controls	15
Master Volume.....	16
Button Behaviors	16
Basic Navigation	17
Personal Mixer Rear Panel.....	18
A-Net Connectors.....	18
DC Power Input	18
Audio Outputs	18
Automatic Mono/Stereo Plug Detection	19
Mixing	19
Preparing to Make a Mix	19
The Editing Interface	20
Volume and Pan Control.....	20
Pan LEDs	21
Mixing	21
Linking Channels	22
The Spread Control	23
The Effect of the Spread Control	23
The Mute and Solo Functions	23

Solo a Channel	23
Held Solo Mode	24
Mute a Channel.....	25
Unmute a Channel.....	25
Creating Groups	26
Creating Additional Groups.....	27
Making Changes to a Group	28
Changing Channel Settings Within a Group	28
Removing Channels From a Group	28
Muting Groups.....	29
Making Changes to a Mix	30
Save a Preset.....	30
Verify a Mix Memory Location.....	31
Applications.....	32
Create a Mix With Console Direct Outputs	32
Using Aux Sends to Create a Monitor Mix	32
Studio Cue System.....	33
Playback Monitoring	34
Using Console Inserts	35
Y Cable Insert	35
Adding Effects	35
Using a Patch Bay.....	36
In and Thru Patching.....	36
Adding Effects to a Monitor Mix	37
Adding Live Ambience to a Monitor Mix.....	37
Silent Jam Session	38
Other Uses for the Personal Mixer Outputs.....	38
Record a Mix	38
Troubleshooting.....	40
A-16II Personal Mixer Specifications	43

Welcome

Thank you for purchasing the **Aviom Personal Monitor Mixing System**. This User Guide is designed to familiarize you with your new product and to have you up and running in no time.

Features

Your Personal Monitor Mixing System provides a host of professional features designed to make the system flexible in a variety of music and audio situations.

A-16II Personal Mixer Features:

- Sixteen Channel select buttons with dual LEDs
- Dedicated Recall, Group, Solo, and Mute buttons
- Sixteen user Preset memory locations
- Pan/Spread control with LED readout
- Channel volume control with LED level readout
- Master Volume, Treble and Bass controls
- Tabletop or mic stand mountable (using optional MT-1 mic stand bracket)

Conventions Used in this Document

When indicating a button on the front panel of the A-16II Personal Mixer, a special typeface is used. For example, when selecting a Preset, press the **RECALL** button.

Warranty Information

Please record the following information for future reference:

Your Authorized Aviom Dealer:

Name: _____

Address: _____

Phone: _____

Serial Numbers of Your Aviom Products: _____

Date of Purchase: _____

Your Authorized Aviom Dealer is your primary source for service and support. The information recorded above will be helpful in communicating with your Authorized Aviom Dealer should you need to contact Aviom Customer Service. If you have any questions concerning the use of this unit, please contact your Authorized Aviom Dealer first. For additional technical support, or to find the name of the nearest Authorized Aviom Repair Station, check the Aviom web site at www.aviominc.com.

To fulfill warranty requirements, your Aviom product should be serviced only at an authorized Aviom service center. The Aviom serial number label must appear on the outside of the unit, or the Aviom warranty is void.

This manual and its contents are copyrighted by Aviom, Inc. All rights are reserved by Aviom, Inc. This document may not, in whole or in part, be copied, photocopied, reproduced, translated, or reduced to any electronic medium or machine-readable form without prior written consent from Aviom, Inc.

The software and/or firmware contained within Aviom products is copyrighted and all rights are reserved by Aviom, Inc.

Although every effort has been made to ensure the accuracy of the text and illustrations in this manual, no guarantee is made or implied as to the accuracy of the information contained within.

Personal Monitor Mixing System is a trademark of Aviom, Inc.

A-Net is a trademark of Aviom, Inc.

Copyright © 2004 Aviom, Inc.

Package Contents

Check the contents of the shipping box carefully before making connections and continuing with installation.

The A-16II Personal Mixer contains:

- One A-16II Personal Mixer
- DC Power supply for the A-16II Personal Mixer
- One Category 5 interconnect cable
- User Guide

Also included within this document is a **Warranty Card**. Be sure to fill out the form and return it to Aviom, Inc. via mail or fax as soon as possible.

AC Line Conditioning

The A-16II is a digital device and is sensitive to sudden spikes and drops in the AC line voltage. Changes in the line voltage from lightning, power outages, etc. can sometimes damage electronic equipment.

To minimize the chance of damage to your equipment from sudden changes in the AC line voltage, you may want to plug your equipment into a power source that has surge and spike protection. Power outlet strips are available with built-in surge protection circuits that may help protect your equipment.

Other options for protection of your equipment include the use of an AC line conditioner or a battery backup system (sometimes referred to as an *uninterruptible power supply*, or UPS).

Channel Labels

For writing channel information or names on the A-16II Personal Mixer label surface or “scribble strip”, we suggest the using a china marker or other easily removed marking device. A china marker is designed for marking on plastic, metal, glass, wood, and paper. These are available at most office supply outlets. Avoid the use of permanent markers.

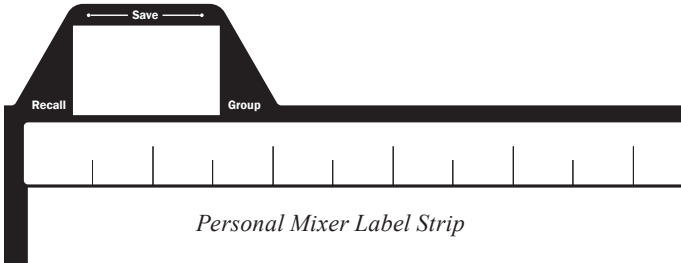

To clean the label writing area on the A-16II Mixer, use a soft clean cloth to remove most types of temporary marking material. For difficult-to-remove types of marking devices, a cotton swab moistened with a drop of rubbing alcohol can be used. Use the minimum amount possible to remove the writing. Be careful not to get rubbing alcohol on the surface of your Aviom products.

What is Category 5?

Category 5 (sometimes referred to as *Cat-5*) describes a commonly used type of high performance network cabling. It is used mainly for data transmission purposes to connect computers, modems and other devices. A standard Category 5 patch cable consists of four twisted pairs of copper wire terminated by RJ45 male connectors. The cable assembly is used to provide connectivity between any two Category 5 female outlet jacks. A variation, called Category 5e, uses additional twists in the cable to reduce interference in high-speed network applications.

The RJ45 connector looks similar to the connectors found on a telephone system, only larger. The twisting of the wire pairs helps to shield the cable from electrical fields or radio interference (sometimes referred to as “RF”). Cat-5 cabling supports frequencies up to 100 MHz and speeds up to 1000 Mbps.

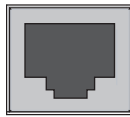

RJ45 Jack



Cat-5 Cable

Cables Used in the Aviom System

The Category 5 cables used with your Aviom system are interchangeable with any standard Category 5 (or Cat 5e) cables. If you need a longer cable for a particular application, any computer store should be able to supply you with an appropriate cable. A qualified technician should be able to build custom cables to any length up to the maximum of 500 feet (150 meters) between A-Net components.

For fixed or permanent installations, you have the option of running Category 5 cables inside walls and terminating them with readily available wall panels that include the RJ45 jack.

Note: When purchasing Category 5 cables, be sure to buy only standard Cat-5 cables, not those sold as *crossover* cables. A crossover cable is used for file transfer between two computers. It is not compatible with your Aviom equipment.

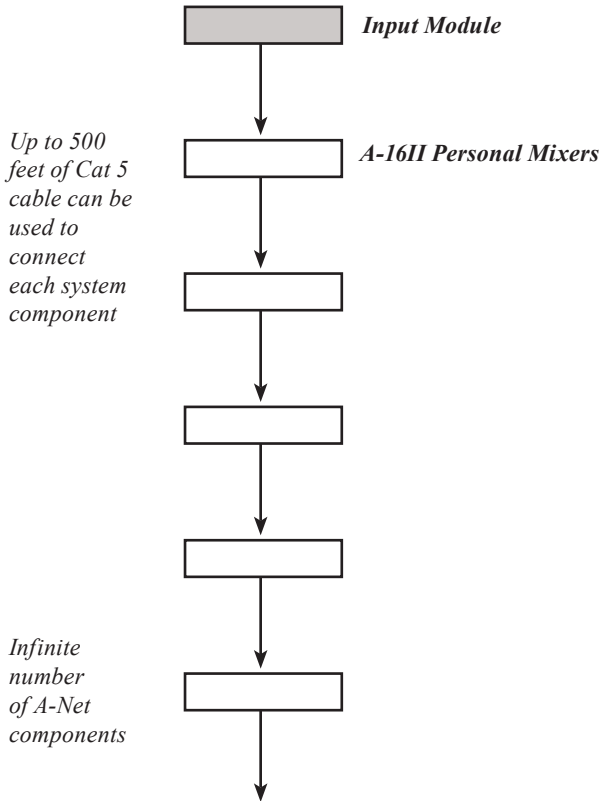

About A-Net

Aviom's A-Net is an ultra-fast data transmission protocol. It is capable of sending and receiving high-quality audio using readily available Category 5 cables. The A-Net technology is a proprietary system developed by Aviom.

A-Net is based on Ethernet, a Local Area Network (or LAN) technology. This provides A-Net with a mature and robust base on which to build.

As used in your Personal Monitor Mixing System, the A-Net signal carries sixteen channels of digital data from the A-Net input module to each and every Personal Mixer connected to the system.

Some of the benefits of using A-Net to transmit digital audio are:

- Sub-millisecond latency
- No ground loops
- Easy cabling using readily available components
- An unlimited number of Personal Mixers can be used in a system
- Ease in spanning long distances between system components

Note: While the Category 5 cables and connectors used on your Aviom products look like typical computer network connections, do not connect computers, routers, or other home and business networking equipment to your Aviom products.

Power Supplies

Your Aviom product uses a DC power supply that has a two-prong power cord. The prongs on the power supply are identical, meaning that there is no need to orient the plug in a specific direction in the power outlet. Some products with two-prong power cords have polarized plugs that can only be inserted into an electrical outlet one way.

The power supply that ships with your Aviom product is a universal switching type. It is capable of working with voltages from 100 to 240 volts AC. This means that a separate power supply is not needed to use the product with the power systems found in most countries throughout the world. You may need plug adapters to use the power supply with the AC outlet plug shape variations used throughout the world.

Should you need to replace the power supply that came with your product, we recommend using only a power supply that meets the following specifications.

Type:	Switching	
Input Voltage:	100-240 volts	50/60Hz 30VA
Output:	24Vdc	0.5A
Polarity	Outer = negative; Inner = positive	



Note that polarity of the plug found on the DC power supply needs to match that of the original power supply that came with your Aviom equipment. The outer contact is negative, the inner contact is positive. (*See the diagram above.*)

Cleaning and Maintenance Information

The exterior of your Aviom product should be cleaned with a dry, soft, lint-free cloth. For tougher dirt, you can use a cloth slightly dampened with water or with a mild detergent.

When cleaning your Aviom products, never spray cleaners directly onto the product surfaces. Instead, spray a small amount of the cleaning solution onto a clean cloth first. Then use the dampened cloth to clean the product.

Note: Never use abrasive cleaners. Never use solvents or abrasives on the finished surfaces of your Aviom product.

The A-16II Personal Mixer

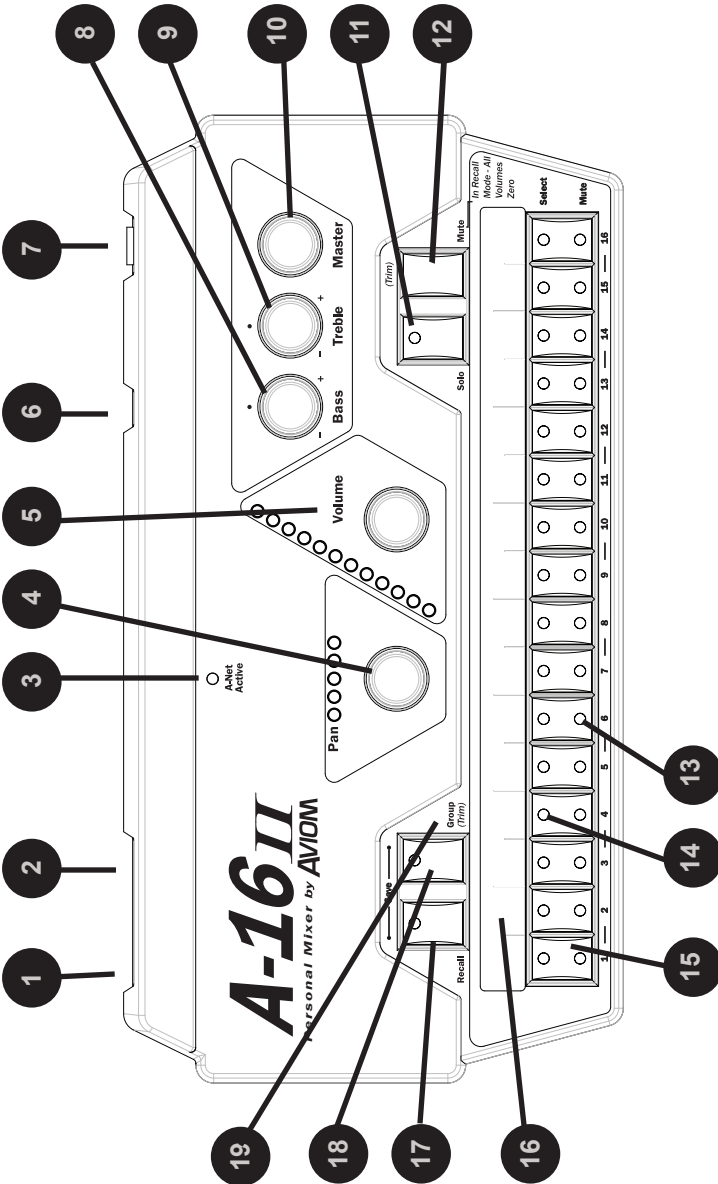

Personal Mixer Components

1	A-Net In jack (rear panel)
2	A-Net Out jack (rear panel)
3	A-Net Active LED
4	Channel Pan control and LEDs
5	Channel Volume control and LEDs
6	DC power jack (rear panel)
7	Headphones/Line output (rear panel)
8	Bass tone control
9	Treble tone control
10	Master volume control
11	Solo button
12	Mute button
13	Channel Mute LED
14	Channel select LED
15	Channel or Preset select button (depends on mode)
16	Label strip
17	Recall button (for Save, hold RECALL and GROUP)
18	Group button
19	Trim function: hold GROUP and press MUTE

System Setup

Start with all devices turned off. When all power and audio connections have been made, you can then power up all the components in your system.

Power Connection

The component parts of your Personal Monitor Mixing System use separate external power supplies.

- Connect the DC power supply to the A-16II Personal Mixer unit.
- Plug the power supply into an available AC power outlet.

The Personal Monitor System will be in its “on” state as long as it is plugged into a working electrical outlet.

No on/off power switches are included on the A-16II. If you would like to control the power state of your units, simply connect the power supplies to a power strip with an on/off switch. Use that as a system power switch.

DC power for the Personal Mixer can optionally be supplied from an A-Net compatible distributor, eliminating the need for the power supply at the mixer’s location. Refer to the documentation provided with the distributor for more system setup information.

System Interconnections

A single Category 5 cable is required to connect each A-Net compatible device in your system.

Connect a Category 5 cable from the A-Net Out jack on the input module to the A-Net In jack on the first Personal Mixer.

Connect additional A-16II Personal Mixers with a single Category 5 cable from the A-Net Out jack on the first Personal Mixer to the A-Net In jack on the next Personal Mixer. (Repeat this process for each additional Personal Mixer unit in your system.)

A-Net can also be distributed in parallel by using an A-Net Distributor. This can eliminate daisy chained A-Net connections.

Audio Connections — Outputs

Plug headphones, in-ear monitors, powered floor monitors, or spot monitors into the A-16II Personal Mixer’s Headphones/Line output jack on the rear panel of the Personal Mixer.

Before powering up the system, turn the Master volume control on the Personal Mixer to its minimum setting (full left) to ensure that unwanted high-volume audio is not accidentally sent into your monitors when the system is powered up. The Master volume control is the one in the upper right section of the Personal Mixer, next to the Bass and Treble controls.

Labeling the Channels

The A-16II Personal Mixer has a convenient label strip right on the front panel. Use a china marker (sometimes called a “grease pencil”) to write the name of the instrument or audio source appearing on each Channel’s in the label area.

Use only non-permanent marking devices on the label surface to avoid permanently marring the surface.

Powering Up

As when powering up any audio gear, it’s best to power up all system components in the safest possible order to minimize the risk of damage to system components and your hearing. Start by turning on devices such as mic preamps, mixers, keyboards, and effects processors. Follow this by turning on power amps, or anything that applies power to speakers, headphones, etc..

In the case of the Personal Monitor Mixing System, you should power up your main audio mixer, effects devices, and keyboards first. Follow this by powering up your A-Net input module and then all connected A-16II Personal Mixers.

Lastly, turn on any power amps, powered monitor speakers, in-ear monitors, etc. that are part of the monitor system.

A-16II Features

This section describes the controls, modes, and functions of the A-16II Personal Mixer. The basic components of the front panel include:

- Sixteen lighted Channel buttons (they are also the Preset select buttons)
- Channel label strip
- Recall button
- Group configuration and edit button
- Solo and Mute buttons
- Pan and Volume knobs
- Bass and Treble tone controls
- Master Volume control
- A-Net Active indicator

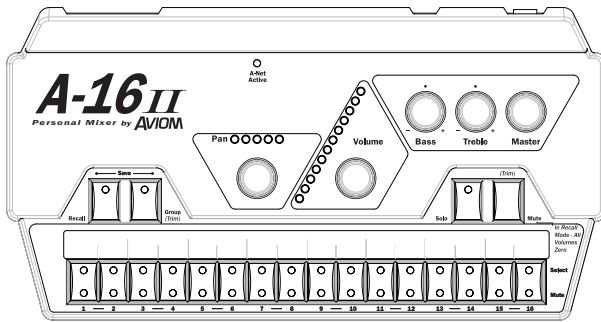

Operational Modes

When using the A-16II Personal Mixer, you will be in one of the following modes:

- **Mix Mode** — Here you can change Channel and mix settings such as volume, mute, and panning; you'll spend most of your time in this mode.
- **Recall Mode** — Activated by the **RECALL** button, the row of sixteen Channel buttons are used to select one of the sixteen available mixes saved as Presets.
- **Group Mode** — Used when creating Groups or editing existing Groups. This is activated by pressing the **GROUP** button. The Channel Select buttons are used to add or delete Channels from a Group.
- **Solo Mode** — When the **SOLO** button is pressed, the

selected Channel (or Group) is audible while the rest of the mix is muted.

Two Solo modes are available; the standard Solo Mode works with one channel at a time. Pressing any other interface button exits Solo Mode.

Held Solo mode remains in Solo as channels are selected. Pressing the **SOLO** button again cancels the Held Solo mode.

- **Save Mode** — This mode is activated by pressing and holding both the **RECALL** and **GROUP** buttons. When both buttons are held down, the Save Mode is active. Pressing any numbered button while still holding this button combination will save your current mix to that Preset location.

Note: A Preset is saved when the numbered button is released.

Global Controls

The three knobs in the upper right section of the A-16II Personal Mixer affect your mix volume and tone directly. The Bass, Treble, and Master volume controls are always active, regardless of the selected Preset.

Tone Controls

Use the Bass and Treble controls to change the overall balance of bass or treble frequencies in your mix. These controls affect the entire mix, not the individual Channels.

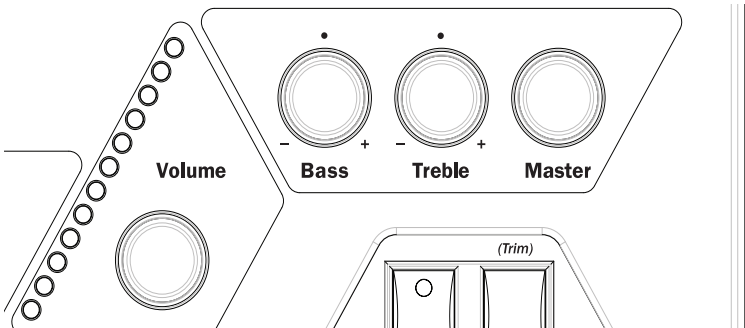

The default position for the **BASS** and **TREBLE** knobs is at 12 o'clock. To add more low frequencies to your monitor mix, turn the **BASS** knob to the right of the 12 o'clock position. To remove lows, turn the knob counterclockwise past the center. To change the high-frequency content, follow the same

procedure; turn the **TREBLE** knob right to add highs, left to diminish them.

The Bass and Treble EQs in the Personal Mixer are both shelving type. There is +/-12dB of cut or boost available for each.

Bass EQ 160Hz shelving

Treble EQ 9kHz shelving

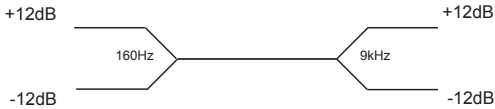

Master Volume

The overall system volume is controlled by the **MASTER** volume control. This is an analog-style control. Turn it counterclockwise for a full off setting. As a general suggestion, start with the Master volume knob at a low setting, about 9 or 10 o'clock to start. Raise the volume slowly from that point to a comfortable listening level.

Note: Always use caution when adjusting any audio system component to avoid potential hearing damage.

Button Behaviors

There are various combinations of lighted and unlighted buttons on the A-16II Personal Mixer. Here is an overview:

- Channel buttons have two LEDs, an upper and lower. The upper button is red and indicates that the Channel is selected. The lower button is yellow; it indicates that the Channel is muted. Channel buttons will light solid or flash.
- The **RECALL** button has one red LED. It flashes when the **RECALL** button is pressed, indicating that you can now select a Preset by touching any numbered button.
- There is one LED in the **GROUP** button. When the **GROUP** button is pressed, the LED flashes. This indicates that you can now build or edit a Group.
- The **RECALL** and **GROUP** buttons will both flash when held down simultaneously. This is the Save Mode, as indicated by the connecting graphic above the two buttons on the front panel.
- When a Preset is saved, all sixteen Channel buttons will flash briefly to confirm the Preset save operation.

- The **SOLO** button has one LED. It will light when pressed, indicating that the selected Channel or Group is now being auditioned with all other Channels being muted. Two Solo modes are available.
- The **MUTE** button has no LED in it. Pressing the **MUTE** button with a Channel selected will cause the Channel's lower (yellow) LED to light.

There is also one special button combination, the **RECALL** button followed by the **MUTE** button. When used together this combination serves a twofold function:

- If there is a sudden change in the audio volume coming through the monitor system, this button combination silences all audio channels instantly.
- When starting from scratch to create a mix, use this function to set all sixteen channels to zero volume and all pans to the center settings.

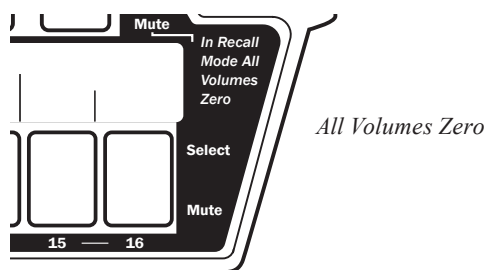

Note: The text on the right side of the Personal Mixer label reads “In Recall Mode All Volumes Zero” as a reminder that this function is always available.

Basic Navigation

When the system is powered up, Preset 1 is automatically selected. On the Personal Mixer, one Channel is always selected for editing. You can tell that a Channel is selected because the upper LED in its button is lit.

The sixteen Channel buttons have two LEDs in each, an upper and a lower. The red upper LED indicates that the Channel is selected; you can change its volume and panning. You can also solo or mute the channel using the dedicated **SOLO** and **MUTE** buttons on the Personal Mixer surface.

The upper LEDs will also light in combination if a track is linked or is part of one of the three available Groups. (More info on Groups appears later in this document.)

The lower yellow LED in each Channel button indicates the Channel's mute status. A lit LED indicates that the Channel is muted. Any number of Channels can be muted.

Personal Mixer Rear Panel

On the rear of the Personal Mixer you will find the A-Net connectors, the power supply input, and the audio output.

A-Net Connectors

There are two A-Net connectors on the rear of the Personal Mixer.

The A-Net **In** jack accepts

- the A-Net signal coming from the A-Net input module if the Personal Mixer is the *first* Personal Mixer in the system, or
- the A-Net signal coming from the Out jack of another Personal Mixer, or
- the A-Net output from an A-Net distributor product

The A-Net **Out** jack is used to connect another A-Net device. This will send the same sixteen audio channels being processed by the input module to the additional device so that another unique monitor mix can be created. An unlimited number of A-Net devices can be connected in series using this method.

DC Power Input

Connect the DC power supply to the jack on the rear of the Personal Mixer. Use only power supplies designed for your Aviom products.

Audio Outputs

The audio outputs on the rear of the A-16II Personal Mixer can be used with headphones, in-ear monitors, powered speakers, or any other device that can accept a line level audio output. Stereo, dual-mono, and mono outputs are available by using the appropriate cables

Stereo

The TRS outputs on the Personal Mixer are stereo. Any pair of stereo headphones can simply be plugged into the jack.

To connect a set of stereo speakers (studio monitors or stage speakers), use a stereo to dual-mono adapter to split the stereo signal into separate left and

right mono signals. Then connect a standard mono cable to the audio input of the left and the right amplifier for the speakers.

Mono

To use a mono amplifier, powered speaker, etc., connect a standard audio interconnect cable (tip and sleeve “guitar cord” type) from the audio output on the Personal Mixer to the audio input on your mono device.

To use a mono input on a device that has an XLR input connection, you need to use a cable that has a tip-sleeve ¼” jack on one end and an XLR on the other. Using a tip-ring-sleeve ¼” jack to XLR cable will cause the left and right channels to be summed, resulting in a loss of level.

Automatic Mono/Stereo Plug Detection

When a cable is plugged into the Line/Headphone output jack on the rear of the A-16II, the auto-detect circuit determines whether the device is mono or stereo.

If a mono device is recognized, the A-16II automatically pans all channels to the left output and adjusts the balance accordingly. This is done to avoid a situation where a mix has channels panned hard right that would not be heard if only the left audio channel was being monitored.

This test happens only once when the plug is initially inserted. Avoid using a Y-cord splitter to achieve mono. Note that saved mixes are not permanently altered. The panning changes are made seamlessly in software.

NOTE: You may notice a very brief delay in audio playback when a plug is initially inserted into the output jack on the rear of the A-16II. This delay is normal; the A-16II mutes audio while the plug is being analyzed.

It is suggested that all audio connections be made with audio volumes at their minimum setting to avoid sudden changes in level.

Mixing

Preparing to Make a Mix

Set the global tone controls—**BASS** and **TREBLE**—to about 12 o’clock. This is the default EQ setting; no boost or cut is applied to the audio mix.

Set the **MASTER** volume knob on the Personal Mixer to a low setting, about

9 or 10 o'clock should be safe. Send audio into the system; this could be a band playing live or audio from a tape deck or other multi-track audio device. Raise the levels to a comfortable level after you have audio playing through the system.

The process of creating a monitor mix using the Personal Monitor Mixing System is similar to the process used to create a front of house mix. The Personal Mixer interface makes it easy to jump right in and create your first mix within minutes of connecting the system for the first time.

Mixing involves setting pan, volume, and mute status for each Channel, and then saving this setup as a Preset so that you can recall your custom mix later.

The user interface is quite simple to understand. As with many digital mixers, the Personal Mixer has many Channels, but only one set of controls that are shared by all the Channels. A Channel is selected by pressing one of the numbered Channel buttons on the Mixer's front surface. When a Channel is selected, the red LED in the Channel's button will light to indicate that it has been selected and is ready to be edited.

The procedure to edit a Channel involves only two steps:

- Select the Channel you want to change.
- Edit the volume, panning, or mute status

That's it. Each Channel of the mixer can be edited by following the same simple steps.

The Editing Interface

When you turn the **VOLUME** knob clockwise to raise the volume of the selected Channel, the volume level is reflected in the Volume LED indicators. There are twenty-four visible volume steps available in the Volume LEDs. Each LED lights at two levels, first at half brightness, then at full brightness. More LEDs lit indicates higher volume.

The pan position for a Channel can be changed with the **PAN** knob. Turn it left or right to move the audio in the stereo field. Your changes will be reflected in the Pan LEDs. The Pan LEDs are used to indicate the left-center-right location of the selected Channel. The Pan LEDs have a green middle LED to indicate the center position in the stereo field with red LEDs on the sides to indicate left or right positions. Changes will be heard immediately in any speakers or headphones connected to your Personal Mixer.

Volume and Pan Control

When you change the volume of a Channel on the Personal Mixer, the

LEDs in the Volume section of the mixer surface will indicate the level in real time. There are twelve LEDs in the Volume indicator, each capable of displaying two levels, for a total of twenty-four visible lighted steps.

When a Channel is selected, the current volume is instantly indicated on the LEDs. When no LEDs are lit, Channel volume is at its minimum setting.

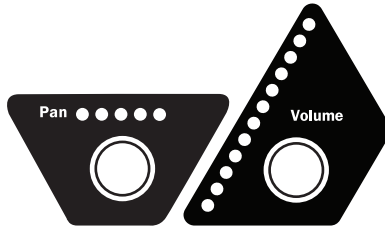

Pan and Volume Controls

To make changes to a Channel:

- Select a Channel by pressing its numbered button—the button's upper LED will light.
- Rotate the **VOLUME** knob to the right to increase the volume, to the left to lower the volume
- While the Channel is still selected, you can also change the Pan setting. Rotate the **PAN** knob left or right to change the position of the Channel in the stereo field.

Pan LEDs

The Pan indicator is made up of five LEDs. The center LED is green. The LEDs on either side of center are red. As you turn the **PAN** knob, the LEDs will light in various combinations to provide the maximum number of position indicators with the fewest number of lamps. At either end of the display only one LED will be lit to indicate that the Channel is panned full left or right.

When using linked channels (stereo inputs), the LEDs light in different patterns, using a pair of LEDs on either side of the display to indicate the width of the stereo field. When the stereo image has been collapsed to mono, only the center green LED will be lit. In this case the stereo input will be heard as mono.

Mixing

Start creating a monitor mix by selecting the first Channel you want to hear.

Follow these steps:

- Press the desired Channel button — its upper red LED will light.
- Turn the **VOLUME** knob clockwise to raise the volume of the selected Channel until you hear it in the monitors. You should see the volume changes you're making reflected in the Volume LED indicators. More LEDs lit indicates higher volume.

There are twenty-four visible volume steps available in the Volume LEDs. Each LED lights at two levels—one at half brightness, the other at full brightness.

The procedure for setting the pan position for a Channel is similar. Once a Channel is selected, you can turn the **PAN** knob left or right to move the Channel in the stereo field. Your changes will be reflected in the Pan LEDs. Changes will be heard immediately in any speakers or headphones connected to your Personal Mixer.

<p>Note: If you have connected the output of the Personal Mixer to a mono audio system or speaker, pan position is irrelevant.</p>

A Channel is playing in the center of the stereo field when only the center (green) LED is lit. As you turn the **PAN** knob, the Pan LEDs will light in various combinations to indicate the pan position.

Continue this process of setting volume and pan until all the Channels have been added to the mix.

At this point you should have a basic mix playing in your monitors. You can continue to make changes in real time as your needs require. Remember that changes to Channel volume and pan setting affect the selected Channel only. The selected Channel always has its red LED lit.

Linking Channels

For stereo input sources such as keyboards, drum machines, CD players, main mixer submixes, etc., the Aviom input modules provide a convenient method of controlling these two-channel sources. It's called a Link. A Link is simply two Channels working together as one to process a stereo input.

Linking two Channels is done from the front panel of the input module. Each pair of inputs has a corresponding Link switch. When the switch is positioned to the left, the two Channels are independent. When the switch is moved to the right, the Channels become linked. Only adjacent Channels can be linked (Channels 1 and 2, Channels 3 and 4, etc.).

When Channels are linked, they act as one source on the A-16II Personal Mixer. When you select either of the two linked Channels on the Mixer, both LEDs will light up, indicating that they are linked. Volume changes affect both Channels simultaneously.

Channels that are linked at the input module will appear linked on every Personal Mixer connected to the system. You can link or un-link Channels as needed, even while audio is running through the system. All connected Personal Mixers update immediately.

The Spread Control

When two Channels are linked, they no longer have separate pan controls. With the Channel link comes a new feature, called Spread. The Spread control varies the stereo image of the two linked Channels from full stereo to mono. This allows you to position stereo sources in your mix by controlling the width of the stereo image.

Spread changes the panning of the left and right Channels simultaneously. Instead of having two Channels panned 100% left and right, Spread allows the Channels to be panned to 60% left and right, for example.

The Effect of the Spread Control

Spread turns this:



into this, for example:



When you adjust the Pan control with a stereo-linked Channel selected, the Pan LEDs show the width of the stereo spread that is currently set. Multiple LEDs light to indicate the compression of the image from full stereo to mono.

The Mute and Solo Functions

Solo a Channel

While working with a mix, you may want to listen to a particular Channel by itself to check a part, locate or solve a problem, select a pan location, etc. To do this you can use the Solo mode. The Solo mode lets you listen to the

selected Channel alone without disturbing the rest of the mix. Two types of Solo mode are available; one functions on a channel by channel basis, the other (called Held Solo) remains in force until the user exits it.

Solo mode works on the currently selected Channel or Group. To use Solo mode, first select the Channel you want to hear alone. Its red button LED should be lit. Now press the **SOLO** button, found in the pair of buttons in the upper right corner of the Personal Mixer. The Channel is now heard solo.

You can make changes to volume and panning when a Channel is in Solo mode. All changes happen immediately. Consider Solo mode as a temporary state only. You cannot save a Preset with a Channel in Solo mode.

Only one Channel, linked pair (or Group) can be in solo at a time. To exit Solo mode, simply select another Channel or press the **SOLO** button again to exit.

To select a different Channel for auditioning in Solo mode, remember that you must first select a Channel and then press the **SOLO** button to enter Solo mode.

Held Solo Mode

This Solo mode allows Channels to be soloed in succession without exiting the Solo Mode. This is in addition to the regular Solo Mode behavior that allows the user to exit Solo Mode by pressing any other interface button after soloing a Channel. Held Solo Mode is indicated by the flashing of the Solo LED.

To use Held Solo Mode, you must start from Mix Mode (that is, no Channels are currently soloed). The Recall, Group, and Solo LED's should be off.

To use Held Solo Mode:

- Press and *hold* the **SOLO** button.
- While holding down the **SOLO** button, press and then release any Channel button.
- You can now release the **SOLO** button. (If you release the **SOLO** button before releasing the Channel button, Held Solo Mode will not be engaged.)
- The Channel that you pressed is now soloed, and the Solo LED is flashing.
- To solo another Channel, press any other Channel button.
- To exit Held Solo Mode, press the **SOLO** button again.

You can also exit Held Solo Mode by pressing the **RECALL**, **GROUP**, or **MUTE** buttons.

Remember that the system can only enter Held Solo Mode from the normal Mix Mode. If you currently have a Channel temporarily soloed (the Solo LED is lit *solid*), you must exit the temporary Solo Mode (by hitting another Channel button or the **SOLO** button) before you can enter Held Solo Mode.

Mute a Channel

The method used for muting Channels is similar to that used for the Solo function—first select the Channel, then perform an action. There are some differences, however.

- You can mute as many Channels as necessary for your application.
- Channels that are muted *can* be saved as part of a Preset.

To mute a Channel:

- Select the Channel first
- Press the **MUTE** button
- The yellow LED in the Channel button lights

To unmute a Channel:

- Select a muted Channel
- Press the **MUTE** button
- The yellow LED in the Channel button will go out

Additional Channels can be muted or unmuted by following the same procedure—first select the Channel, then press the **MUTE** button.

Unmute a Channel

Once a Channel is muted, you can follow this simple procedure to clear the mute:

- Select the muted Channel. (It should have the yellow LED in its button lit.)
- Press the **MUTE** button.
- The yellow LED will go out.
- To clear mutes on other Channels, continue selecting Channels, followed by pressing the **MUTE** button to clear the mutes.

Save the Preset with the mutes, if desired.

Note: Solo mode will temporarily override a mute. This guarantees that you will always hear the Channels you solo. When you exit Solo mode, the Channels are returned to their previous state.

Creating Groups

When you need control over more than just a stereo pair of Channels as described earlier using the Link function, you can use the Group function to control multiple Channels. Up to three Groups can be created per user Preset. This means that every Personal Mixer can have up to forty-eight different Groups saved by using all sixteen user Presets.

A Group can consist of any number of Channels, but Groups cannot overlap. That is, one Group cannot contain Channels that are part of another Group. Mono or linked stereo Channels can be part of a Group.

As you create a Group, the Channel volume and pan settings of each Channel added to a Group are retained. This helps to keep the overall blend of Channels that are part of a Group even while you adjust the Group's overall volume. The **VOLUME** control changes the overall level of the Group.

Some examples of Groups in use:

- A Group allows background vocal parts from six singers to be adjusted together.
- All the drums in a live drum kit can be combined to a single stereo mix for easy adjustment for the guitar player, while the drummer retains individual control over each drum in his mix.
- Horns and woodwinds can be controlled together.
- Rhythm section instruments can be combined into one source.

Creating and editing Groups is done in the Group Mode.

To create your first Group:

- Start by selecting a Channel that you want to be included in the Group.
- Press the dedicated **GROUP** button on the left side of the Personal Mixer.
- Its red Group LED will begin to flash indicating that you can now edit the Group.
- Double-click the Channel buttons to include a Channel in the Group.
- Channels that are added to the Group will flash their upper red LED to indicate that they are now part of the Group.

To Save your Group, simply press the **GROUP** button again. The Group LED goes out and you are returned to your current Preset and live mix.

In the current Preset, you will now see all Channel LEDs associated with a Group light whenever you press a Channel button that is included in your saved Group. The Channels now behave as one.

Note: Remember to save the edited Preset if you want to recall the Preset with the new Group settings later.

Creating Additional Groups

Three Groups can be created and saved in each Preset in a Personal Mixer. Each Group can be created and/or edited as needed while live audio is playing through the system.

The instructions in the previous section describe how to create and save the first Group in a mix. Creating additional Groups follows the same procedure. Use these steps to create a second and/or third Group.

- Select a Channel that is *not* currently part of an existing Group.
- Press the **GROUP** button to enter Group Mode. The Group LED will flash.
- Double-click any Channels that you want to add to the Group.
- To save the Group, press the **GROUP** button again. The flashing LED will go out.

Shortcut: While in the Group edit mode, you can start the process of creating a new Group while editing an existing Group. To do this,

- Press a Channel button that is *not* already part of the current Group being edited. Its red LED will light solid.
- Double-click Channels to add them to a new Group.
- Create a third Group by following the same procedure.
- Exit the Group edit mode to save the Groups.
- Save the Preset.

If you try to create more than three Groups, the interface will automatically select one of the existing Groups when you enter Group edit mode. You have the option at this point to edit an existing Group or clear Channels that are part of one of the other existing Groups.

Note: A Channel that is already part of one Group cannot be part of any other Group.

Making Changes to a Group

Once you have created a Group, you can edit it in a number of ways. You can add or delete Channels from the Group, and change individual Channel volume and pan settings.

To change a Group, start by selecting a Channel that is already part of a Group. All Channel LEDs that are part of the Group will light. Press the **GROUP** button to enter the editing mode. The Group LED flashes.

Changing Channel Settings Within a Group

While editing a Group, you'll notice that one LED in each Group is lit solid while the other LEDs are flashing. This solid LED indicates the Channel currently *selected* for editing. You can change its volume and panning without affecting the other components of the Group. The changes you make to volume and pan affect only the selected Channel, allowing you to change the relative balance of the individual components of your Group. Changes can be made in real time.

To select a different Channel in a Group for editing, press one of the flashing LEDs (don't double-click it). The new selection will light its LED solid, while the previously selected Channel will start to flash. Continue making changes as needed. Remember, volume and pan changes only affect the Channel whose LED is lit solid. Press the **GROUP** button again to exit Group Mode.

Removing Channels From a Group

When in the Group edit mode (the Group LED is flashing), changes can be made to the existing Groups. To remove a Channel from a Group, simply double-click the Channel that you want to remove. The flashing LED will go out. To add other Channels to a Group, double-click them. When you have double-clicked to remove all Channels that were previously part of the Group you're editing, the Group will no longer exist. You need at least two Channels to have a valid group.

Exit the Group edit mode by pressing the **GROUP** button again. The LED in the Group button will go out. This saves your changes to the Group.

Some points to note about Groups:

- Up to three Groups can be created per Preset.
- Groups are relative only to the Personal Mixer that they are created on.
- Groups you create on *your* Personal Mixer do not affect other Personal Mixers being used in your system.

Remember that although you have edited and saved changes to your Group, you must still save the Preset if you want to recall the Preset with the new Group configuration intact.

Muting Groups

Groups can be muted if necessary while creating a mix or editing. The procedure is the same as for muting a single Channel. To mute a Group:

- First select one of the Channels that is part of the Group.
- The upper (red) LED in each Channel button that is part of a Group will be lit solid.
- To mute the Group, simply press the **MUTE** button.
- The lower (yellow) LEDs in all Channel buttons contained in the Group will light, indicating that the Channels are now muted.
- Unmute the Group by pressing the **MUTE** button again while the Group is still selected.

Note: The mute status of your Groups is saved as part of a Preset.

Global Trim Function

The Global Trim function can be used to lower all sixteen audio levels in a mix simultaneously, which is useful when some of the channels are nearing maximum level and additional mix balance changes are required. This function operates in a similar manner to a studio mixing console with automation; invoking the command calculates a new volume level for all channels.

The Global Trim function drops the level of the mix by 6dB with each use, keeping the relative levels intact among the sixteen audio channels. Changes to volume levels are instantly updated and can be seen on the volume LED readout as each channel is selected. Note that as channels approach their minimum volume level that the mix balance will change since the A-16II has no way of re-balancing the mix once the minimum level for a channel has been reached.

The Trim function is labeled on the A-16II front panel, once near the **GROUP** button and once near the **MUTE** button to indicate the button combination used to perform the Global Trim.

To Use the Global Trim function:

- Hold the **GROUP** button down.

- While still holding the **GROUP** button, press the **MUTE** button once.
- The mix is trimmed by 6dB on all channels
- Perform additional trims as needed.
- Set the volumes on the current mix as needed.
- Save the mix as a Preset to preserve the changes.

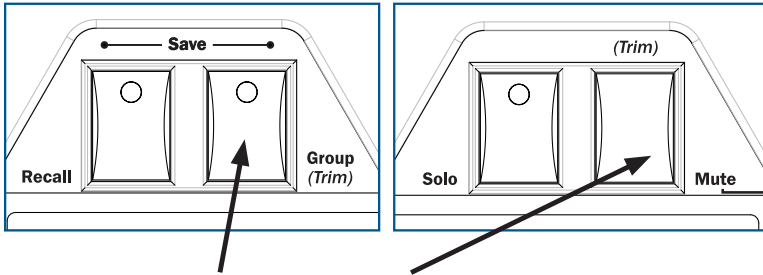

Hold **GROUP** and then press **MUTE** to use the Global Trim function

Making Changes to a Mix

Once you have a basic monitor mix, you may want to make changes to fine tune the settings for the individual Channels. This is as simple as selecting the Channel and then adjusting the **VOLUME** and **PAN** knobs as required.

When you select a Channel by pressing its corresponding numbered Channel button, the current settings for channel volume and panning are indicated instantly in the Volume and Pan LED readouts. When a Channel is selected, you can always make real-time changes to its settings.

Note: Remember to save your new mix to a memory location before turning the system off.

Save a Preset

Each Channel button on the A-16II front panel also serves as a memory location. Saving a mix as a Preset allows instant recall of up to sixteen mix scenes.

To save a mix as a Preset:

- Hold both the **RECALL** and **GROUP** buttons
- While holding down **RECALL** and **GROUP**, press one of the Channel buttons (1 to 16) where you want the mix to be saved.

-
- All sixteen Channel buttons will flash briefly to indicate that the Save operate was successful.
 - Release the **RECALL** and **GROUP** buttons.

Verify a Mix Memory Location

When editing mix Presets, it is useful to know which Preset was the last one to be recalled in order to avoid overwriting Presets accidentally. When preparing to save a mix in the A-16II, the software will display the last mix Preset that was recalled when the **RECALL** and **GROUP** buttons are held simultaneously. The red LED in the Channel button that corresponds to the last recalled Preset will light as long as these two buttons are held.

Applications

This section describes how to set up and use the Personal Monitor Mixing System in a variety of contexts.

Create a Mix With Console Direct Outputs

The direct output of a live or recording console allows you to take an exact copy of an input channel's audio and patch it into the Input module for processing. A typical console's direct output point is right after the input, meaning that changes made on the console as far as effects, EQ, etc., do not affect the sound of the direct output.

Aviom input modules can accept up to sixteen direct outputs. You can use balanced or unbalanced cables to connect audio, depending on the configuration of your mixer.

The most likely scenario involves using a multi-cable snake to connect the main mixing board's direct outs to the Input Module. It's not a requirement, but rather a convenient method of keeping cable mess to a minimum.

Follow these steps to create a monitor mix with direct outputs:

- Connect a balanced or unbalanced cable from the direct output jack on the main mixer to the first input on the input module rear panel.
- Repeat this procedure for the other console channels you want to add to the monitor mix.
- Select an appropriate Input Level setting on the input module front panel.
- Label the Personal Mixer with Channel names.
- Begin playing audio into the Personal Monitor Mixing System. Select a Channel and set the volume and panning for each.
- Save the mix as a Preset.

At this point you can use the mix as is, or fine tune it by adding Groups, linking Channels, etc.

Using Aux Sends to Create a Monitor Mix

An Aux Send (sometimes referred to as an Effects Send) can be used alone or in combination with other audio sources to create a monitor mix.

Using a fairly typical layout of a console with four Aux Sends, here is what you could do to send audio to the input module to create a monitor mix. Again, remember that you can use any of the different types of audio signals available on your particular audio mixer to create a monitor mix (direct outputs, bus outputs, etc.).

The example will use a band with a rhythm section (keyboards, bass, drums, and guitar) and a lead singer. Assume that all of the instrumentalists sing background vocals. The example assumes that you do not want to use any other type of output from the mixer. With four Aux Sends available on the mixing board, four independent sub-mixes can be sent to the input module and then on to the Personal Mixer units.

The first task is to separate the instrumental and vocal parts into four sub-mixes. Imagine that we want a separate controllable level for the lead singer, background singers, drums, and the rest of the instruments. So, Aux Send 1 is assigned to Lead Vocals, Aux Send 2 is assigned to Background Vocals, Aux Send 3 is assigned to the drums, Aux Send 4 is assigned to the instruments. All that's left to do is connect four cables from the mixing board's Aux Sends to the input module.

Turning up the Aux Send 1 level on the mixing console sends the lead vocal to the input module. Since there is only one singer, there's no sub-mixing or balance setting required.

The four musicians who sing background vocals will need to be blended at the main mixer. This will be done by sending audio from each of their microphones into Aux Send 2. By changing the aux send level, you control the blend of the four singers, without affecting the mix created by the faders on the main mixer.

The same concept used to create a mix of all the background singer's microphones is used for the drum kit and the instruments. The drums are sent to Aux Send 3, while the instruments are sent to Aux Send 4. At each musician's Personal Mixer, a custom mix can now be created. The singer can have more instruments, the drummer can have less background vocals and no drums in the mix, the instrumentalists can have their own background vocal level, etc.

Studio Cue System

In the studio, the flexibility of the Personal Monitor Mixing System will give performers more control of their headphone cue mix. At the same time it allows the engineer to spend less time fussing with the cue mix and more time making the tracks sound great.

Making a cue mix from a recording console is essentially the same as when using a live mixing board. If your board has direct outputs or unused

auxiliary sends, you can use the same techniques as described for live audio monitor mixes.

Playback Monitoring

In the studio, performers also need to listen back to tracks they have just recorded. If each performer is using a different mix while recording, playback of the track will be different in each set of headphones.

If you can dedicate two inputs on the input module for playback, you can easily provide the performers with a high-quality playback of the track they have just recorded. Here's how to set it up:

- Set aside the first fourteen Channels of the input module for audio tracks to be sent to the performers as a cue mix.
- The remaining two channels are reserved for the stereo mix that the engineer creates in the studio.
- Connect cables from the console for monitoring the fourteen performer Channels as described previously. Use direct outputs, aux sends, etc.
- Patch the stereo mix output that you want the performers to hear into the remaining two Input module inputs.

The idea is that you will create two Presets on the Personal Mixers for the performers. The first is their standard cue mix. It uses fourteen channels; the last two are muted. They can change it as needed while they work. The other Preset is the exact opposite. The performer's fourteen cue channels are muted and the two channels containing the engineer's playback mix are on.

For the example, let's assume that Channels 1 through 14 are used for performer cue playback. Channels 15 and 16 will be used to play back the recorded track.

To complete the setup:

- On the input module front panel, set the Link switch on Channels 15 and 16 to the linked position.
- On each Personal Mixer create a basic mix of the fourteen channels of audio.
- Mute Channels 15 and 16.
- Save the Preset (to location #1, for example).
- Create another Preset that has the first fourteen channels muted. (Shortcut: Start by recalling the All Channels Zero Preset by holding **RECALL** and then pressing **MUTE**.)
- Set a volume for the playback on Channels 15 and 16.
- Save the Preset (to location #16, for example).

When the musicians are cutting tracks, have them select Preset #1. Record tracks as usual, with each musician listening to their personal customized cue mix. When you want to listen back to a recorded take, have the performers switch to Preset #16. They now hear the engineer's mix. All players hear the same mix, that the engineer can control as needed.

Of course the players can create additional cue mixes and save them to the remaining empty Preset locations as needed.

Using Console Inserts

When you use your console's insert points to send audio signals to the Input module Transmitter for processing, you have some options. The patching on the rear panel of the input module is designed so that you can still use the insert point on your console for its traditional use—adding an effect to a channel.

There are some special ways that the input module can be used to allow this flexible processing. The exact layout of your existing main mixer will influence how many of these techniques you can use.

Y Cable Insert

The input module can be used with a console's insert send/return loop just as if it were an effects processor. If you have a console with a single TRS jack used for send and return of the effects loop, a “Y” cable is used to split the signal into two components. One is the Send, the other is the Return.

To use this type of insert with the input module, patch the Send cable into the In jack on the Input module. Then use the Return cable plugged into the Input module Thru jack to complete the loop back to the main mixer. The Input module is now patched into the channel with no change to the audio signal. The console sees the Input module as just another effects device.

Adding Effects

What if you need to add an effect such as a compressor to the same channel feeding the monitor system via the input module? There are a couple of options. For both examples, start with the cables set up as just described for the simple insert example. You'll need one more cable.

Monitor without the effect:

- Remove the cable from the Thru jack of the Input module.
- Plug it into the *output* of the effect.
- Connect a cable from the Input module Thru jack to the *input* of the effect. The send/return loop is complete and

now includes the effect. You do not hear the effect in the monitors.

Monitor with the effect:

- Remove the cable from the In jack of the Input module.
- Plug it into the *input* of the effect.
- Connect a cable from the *output* of the effect to the Input module In jack.
- Leave the cable already connected to the Input module Thru jack as it is. It completes the loop.

- To add the effect (such as a compressor) connect an insert Y cable's TRS plug to the Input module In jack
- Plug the Send cable on the other end of the Y cable to the input of the effect processor.
- Plug the Return cable on the Y cable into the effect's output. This completes the loop.

You can wire much of the same functionality described above into a patch bay for more permanent installations. Remember to use the same type of cables and patch bays—balanced cables with balanced patch bays, unbalanced cables with unbalanced patch bays.

Note: This technique does not work with the AN-16/i Input Module.

Using a Patch Bay

The input module's in and through connections can be wired into a patch bay for flexible and repeatable connections day after day. This concept can work for both studio applications and live performance.

You can use either balanced patch bays or unbalanced. One point worth mentioning— use matched systems. That is, if you have a balanced patch bay, use balanced audio cables for interconnections. If your patch bay is unbalanced, use unbalanced cables.

In and Thru Patching

Not to be confused with patching the input module into a mixer's insert send/return loop, this is a simple wiring idea for having access to the input module rear-panel In and Thru connections. It allows permanent installations to have access to the flexible patching options of the Input module as needed.

In the studio this allows you to patch direct outputs to the Input module one

day, and then use a combination of aux sends, direct outputs and console bus outputs another day without reaching behind an equipment rack.

This setup is designed for a patch bay that is not *normalled*. A normalled patch bay is one that automatically sends the signal from one jack of the patch bay (typically the top row) to another jack (typically the lower jack).

To connect a patch bay using this configuration:

- Use balanced or unbalanced cables (depending on your patch bay) to connect the Input module row of Input jacks to one row of the patch bay.
- Patch another set of cables from the Input module Thru jacks to another row of the patch bay.
- Patch an audio signal into the Input row of the patch bay.
- The signal is processed by the Transmitter. It will appear in the Personal Mixers.
- To send the signal elsewhere in the studio, patch a cable into the Thru row on the patch bay.
- Repeat these steps to add additional audio signals to the mix.

Adding Effects to a Monitor Mix

Sometimes you may want to have reverb, delays, etc. sent into the monitor system. This works for studio cue systems as well as for live applications. There are two ways of accomplishing this:

- Patch the effects returns from the mixer into the Input module via insert points if available.
- Connect the effects device outputs to the Input module *first* and then use the Thru jack on the Input module to complete the signal chain.

In either case the performers can now decide how much reverb is required in their personal mix. And, they can save up to sixteen mixes with various amounts of effects in each.

Adding Live Ambience to a Monitor Mix

For performers using in-ear monitors in a live-performance situation, it may be desirable to add some room tone into the monitor system to help add a sense of space. This technique can be used with most live consoles. All you need is a way to send the signal from a pair of stage or room mics into the Input module Transmitter.

If you are using direct outputs from channels to send instrument and mic

signals into the Input module, you need to dedicate two channels to the mics that are picking up the ambient sound. It is not necessary that the live mics be sent into the front of house mix.

Silent Jam Session

There is no requirement that a mixer be used with the Personal Monitor Mixing System. In fact it makes a great late-night jam session environment for keyboard players, guitarists, and electronic drummers, etc.

To set up a silent headphone system for jamming:

- Connect the outputs from stereo keyboards to inputs on the Input module.
- If the keyboard player uses a sub-mixer, you can optionally connect the stereo output of the keyboard mixer to two inputs on the Transmitter.
- Patch the output of a guitar amp simulator into a pair of inputs.
- Connect an electronic drum kit's outputs into the Input module.
- Set the Link switches on the Input module for any stereo Channel pairs.

Other Uses for the Personal Mixer Outputs

The stereo audio outputs on the A-16II Personal Mixer can be used with stereo headphones, in-ear monitors, or powered speakers. But, since the outputs are at line level, they are capable of sending the current monitor mix to any audio device capable of using a line level audio signal.

Record a Mix

The output of your Personal Mixer can be used for recording. To connect the stereo TRS line output to some devices you may need to use an adapter to split the signal into two separate mono outputs—one for the left side, the other for the right. To record the output of a Personal Mixer:

- Create a mix. Use panning, mutes, Groups etc. as required.
- Save the Preset to a memory location.
- Connect the line outputs of the Personal Mixer to the inputs of the recorder. (You may need a special cable to split the stereo signal into dual mono signals.)
- Play back the mix you created.
- Set an appropriate audio level for recording on the device.

Use the Master volume control to set a level that does not distort the inputs of the recorder.

Using this technique you can quickly create a variety of recorded tracks for rehearsals, etc. by recording the different Preset mixes saved on your Personal Mixer.

Troubleshooting

Before contacting Customer Service, check the following list of common problems and solutions for help.

Problem: *No audio from Personal Mixer outputs*

Possible Solutions:

- No input audio from the main mixing console. Check the levels of the main mixing board that the system is connected to.
- Check the cables and connections between the main mixer and the personal monitor system. The Signal LEDs on the front of the input module can be used to confirm that audio is being received.
- Bad cables; try a replacement.
- All Channels on the Personal Mixer are at zero.
- Master volume level on the Personal Mixer is at zero.
- A-Net cables are not connected properly.

Problem: *Can't change Presets*

Possible Solutions:

- Make sure that the **RECALL** button has been pressed. Its LED will flash, indicating that you should press a numbered button to recall a Preset.

Problem: *Can't hear a Channel that is part of a Group*

Possible Solutions:

- The Group might be muted. Check the lower (yellow) LED in the Channel buttons. A lit yellow LED indicates the Channel is muted. To unmute it, press the **MUTE** button while the Group is selected. The yellow LED must be unlit in order to hear the audio on that channel.
- The Channel volume is all the way down. In Group edit mode, select the Channel and check the level for that Channel by looking at the LEDs in the Volume indicator. If no LEDs are lit, then the Channel is turned all the way down. Raise the volume by turning the Channel **VOLUME** knob; re-save the Group and Preset if necessary.

Problem: *The A-Net LED is on, but there is no sound*

Possible Solutions:

- The A-Net Active LED indicates that the input to the receiving device is properly connected to another A-Net

device. It does not indicate that all devices in a system are properly connected, however. If you have two Personal Mixers connected together, the second Personal Mixer's A-Net LED will light because the first Personal Mixer is correctly connected to it. Check that each device in the chain has a Category 5 cable plugged into it.

- Check that the A-Net cables are connected in the correct order. The Cat 5 cable connected to the first Personal Mixer should be connected to the A-Net In jack. The next device is connected from the Out on the first device to the In on the next.

Problem: *A Preset was saved with a stereo link active but when the Preset is recalled the channels are mono. (Or, a Preset was saved with mono channels, but on recall the Channels are linked.)*

Possible Solutions:

- The status of the stereo link is set by the Link switches on the input module. If a Preset is recalled and the position of the Link switch is different from when the Preset was saved, the Preset will be adjusted to agree with the current hardware settings on the input module's front panel. If this happens, simply change the position of the Link switch on the input module. Your current mix will be updated immediately.

Problem: *A Channel was assigned to one Group and now it is suddenly part of a different Group.*

Possible Solutions:

- When you link a pair of channels with the Link switch on the input module after a Group has been created, it is possible that channel characteristics could change. This includes the volume, pan, mute status, and Group assignment. The rule to remember is that the even-numbered channel (the right side of the pair) will inherit the characteristics of the odd-numbered channel (left side of the pair).

Problem: *When editing a Group that contains a large number of Channels, it seems like all of the LEDs are pulsing.*

Possible Solutions

- This is a normal effect of the current-limiting circuit and is not an indication of a problem.

Problem: *I don't think my Preset was saved.*

Possible Solutions:

- When saving a Preset, make sure that the **RECALL** and **GROUP** buttons are both held down before pressing a memory location button. The Preset is saved when you release your finger from the memory location button. When a Preset has been saved correctly, you will see all sixteen Channel LEDs flash momentarily to confirm the save operation.

Problem: *In Group mode, I can't select a new Channel.*

Possible Solutions:

- If you already have three Groups defined and attempt to select a new Channel that is not part of an existing Group, the button press is ignored. This happens you are trying to create a new which would exceed the limit of three Groups per Preset. Edit or delete an existing Group to continue.

A-16II Personal Mixer Specifications

Digital to Analog Conversion:	
Bit Depth	24 bit
Sample Rates	44.1kHz to 48kHz +/-10%
Signal to Noise Ratio (Referenced to 0dB)	-103dB
EQ:	
Treble (shelving)	+/- 12dB at 9kHz
Bass (shelving)	+/- 12dB at 160Hz
Output:	
Headphone driver	Works with 30 - 600 ohm headphones
Maximum Levels Line/Headphone outputs	+20dBu
Impedance Line/Headphone outputs	140 ohms
Size	
Dimensions	10.75" w x 5.6" deep x 2.25" tall
Weight	3.4 lbs.
Options:	
MT-1	mic stand mount

Index

A

- A-Net 7
- A-Net Active LED 11
- A-Net Connectors 18
- A-Net In 11, 18
- A-Net LED 40
- A-Net Out 11, 18
- AC Line Conditioning 3
- Adding Effects 35, 37
- Adding Live Ambience 37
- All Volumes Zero 17
- Audio Connections, Outputs 12
- Audio Outputs 18
- Automatic Plug Detection 19
- Aux Send 32

B

- Basic Navigation 17
- Bass 15, 19
- Bass and Treble knobs 15
- Bass tone control 11
- Button Behaviors 16

C

- cable 3
- Cables 5
- Cable Lengths
- Category 5 5
- Channel
 - selecting 20
- Channel buttons 17
- Channel Labels 4
- Channel linking 17
- Cleaning and Maintenance 9
 - clean the label writing area 4
 - connecting stereo speakers 18
- Console Inserts 35
- Create a Mix 32
- creating a monitor mix 17, 21
- crossover cables 6

D

- daisy chain 12
- DC Power 12, 18
- DC Power supply 3
- default EQ setting 19
- default mix 17
- Direct Output 32

E

- Editing Groups 28
- Editing Interface 20
- Effects Sends 32
- EQ 16
 - tone control 11

F

- Front Panel 14

G

- Global Controls 15
- global tone controls 19
- Global Trim 29
- Group 26, 27, 28, 40
- Group - Making Changes 28
- Group button 16
- Group Mode 14

H

- headphones 18
- Headphones/Line output 12
- Held Solo Mode 15, 24

I

- inline coupler
- Insert 35

L

- label strip 13
- LEDs 17
- Line/Headphone output 19
- Link 26, 34

linked Channels 17, 21
Linking Channels 22
Live Ambience 37

M

Master Volume 14, 16, 19
Master volume control 11
memory location 30
Mix Memory Location 31
Mix Mode 14
modes 14
Monitor with effects 36
Mono 19, 21, 22
Mono/Stereo Plug Detection 19
Mono vs. Stereo output 18
Mute 11, 17, 19, 23
 mute all 17
Mute a Channel 25
Mute button 17
mute status 18
Muting Groups 29

O

Operational Modes 14
Out, A-Net 18
Outputs 12

P

Package Contents 3
Pan 20, 22
Pan LEDs 21, 22, 30
parallel 12
Patch Bay 36
Personal Mixer Components 11
Playback Monitoring 34
Plug Detection
 stereo/mono 19
Power Connection 12
Power Supplies 8
Power supply 3
power supply 8, 18
power supply polarity 8
Preset 17, 20
 Memory Location 30
 save 15, 30

R

- Recall button 16
- Recall Mode 14, 17
- Record a Mix 38
- red LED 16, 20, 26, 27
- Removing Channels From a Group 28
- replace the power supply 8
- RJ45 connector 5

S

- Save a Preset 30
- Save Mode 15, 16
- scribble strip 4
- Solo 11, 17, 23
 - Held Solo 24
- Solo a Channel 23
- Solo button 17, 24
- Solo Mode 14
- Spread Control 23
- stereo headphones 18
- stereo input 21
- stereo input sources 22
- stereo speakers 18
 - connecting 18
- Stereo vs. Mono output 18
- Studio Cue System 33
- System Interconnections 12

T

- Thru jack 35, 36, 37
- Thru Patching 36
- tone control
 - EQ 11
- Tone Controls 15
- Treble 11, 15, 16, 19
- Trim 11
- Troubleshooting 40
- TRS 18

U

- uninterruptible power supply 3
- Unmute a Channel 25
- UPS 3

V

Verify a Mix Location 31

Volume knob 20

Volume LEDs 20, 22, 30

X

XLR input 19

Y

Y-cord 19

yellow LED 18

Y Cable Insert 35

Aviom Warranty Registration

Please take a moment to fill in this warranty registration form. Return it to Aviom via mail or fax. All information will be kept confidential.

Model Number Product Serial Number

Model Number Product Serial Number

Model Number Product Serial Number

Model Number Product Serial Number

Date Purchased

Dealer Name

Dealer Location

.....

Your Name

Address

Address

City

State/Province

Zip/Postal Code

Country

Email Address

Fax this form to Aviom at +1 610-738-9950