



DSP8807



1601 Jack McKay Blvd. • Ennis, Texas 75119 U.S.A.
Telephone: 800.876.3333 • Fax: 800.765.3435



Table of Contents

Important Safety Instructions 2

Introduction 4

System Overview Flow Diagram 6

Panel Layout 8

Installation and Endpoint Termination 9

Software Installation and Setup 14

Specifications 31

Troubleshooting Guide 33

Warranty 36

Important Safety Instructions

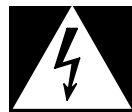

The lightning flash with arrowhead symbol within an equilateral triangle, is intended to alert the user to the presence of uninsulated "dangerous voltage " within the product's enclosure that may be of sufficient magnitude to constitute a risk of electric shock to persons.



The exclamation point within an equilateral triangle is intended to alert the user to the presence of important operating and maintenance (servicing) instructions in the literature accompanying the product.

1. Read these instructions.
2. Keep these instructions.
3. Heed all warnings.
4. Follow all instructions.
5. Do not use this device near water.
6. Clean only with dry cloth.
7. Do not block any ventilation openings. Install in accordance with the manufacturer's instructions.
8. Do not install near any heat sources such as radiators, heat registers, stoves, or other devices (including amplifiers) that produce heat.
9. Do not defeat the safety purpose of the polarized or grounding-type plug. A polarized plug has two blades with one wider than the other. A grounding type plug has two blades and a third grounding prong. The wide blade or the third prong are provided for your safety. If the provided plug does not fit into your outlet, consult an electrician for replacement of the obsolete outlet.
10. Protect the power cord from being walked on or pinched particularly at plugs, convenience receptacles, and the point where they exit from the device.
11. Only use attachments/accessories specified by the manufacturer.
12. Use only with the cart, stand, tripod, bracket, or table specified by the manufacturer, or sold with the device. When a cart is used use caution when moving the cart/device combination to avoid injury from tip-over.
13. Unplug this device during lightning storms or when unused for long periods of time.
14. Refer all servicing to qualified service personnel. Servicing is required when the device has been damaged in any way, such as power-supply cord or plug is damaged, liquid has been spilled, or objects have fallen into the device, the device has been exposed to rain or moisture, does not operate normally, or has been dropped.
15. **WARNING:** To reduce the risk of fire or electric shock, this device should not be exposed to rain or moisture and objects filled with liquids, such as a vase, should not be placed on this device.
16. To completely disconnect this equipment from the mains, disconnect the power supply cord plug from the receptacle.
17. The mains plug of the power supply cord shall remain readily operable.



**CAUTION – When Installing the Product**

- Plugging in or unplugging the power cord with wet hands may result in electric shock.
- Never move the device with the power cord plugged into the wall, as damage to the power cord may result.
- When unplugging the cord from the wall, grasp the plug, NOT the cord.
- Never install this device in humid or dusty locations, nor in direct sunlight, near sources of heat, or in areas where sooty smoke or steam are present. Fire and electric shock may result.
- Keep all sides of the device at least 3½" away from objects that may obstruct air flow to prevent the unit's internal temperature rise.

**WARNING – When the Device is in Use**

- To prevent electric shock, do not remove the device cover as there are high voltage components inside. Refer all servicing to Atlas Sound.
- Should any of the following irregularities occur during use, immediately switch off the power, disconnect the power cord from the AC outlet and contact Atlas Sound. Do not attempt to continue operation with the device as this may cause fire or electric shock:
 - Smoke or strange smell coming from the unit.
 - If the device falls or the case is damaged.
 - If water or any metallic objects falls into the device.
 - If the power supply cord is damaged in any way.
 - If the device is malfunctioning.
- Do not insert or drop metallic objects or flammable materials into the ventilation holes of the device's cover, as this may result in electric shock or fire.
- Do not place any containers with liquid or metallic objects on the top of the device. If any liquid spills into the unit, fire or electric shock may result.
- Never operate this device or touch the power supply cord during an electrical storm, electric shock may result.
- Never exceed the wattage on the product when connecting equipment. Fire and/or property damage may result.
- Operate the device only with the voltage specified on the unit. Fire and/or electric shock may result if a higher voltage is used.
- Do not modify, kink, or cut the power cord. Do not place the power cord in close proximity to heaters and do not place heavy objects on the power cord, including the device itself, doing so may result in fire or electrical shock.
- Ensure that the safety ground terminal is connected to a proper ground. Never connect the ground to a gas pipe as a catastrophic disaster may result.
- Be sure the installation of the product is stable, avoid slanted surfaces as the product may fall and cause injury or property damage.

**CAUTION – When the Device is in Use**

- Never place heavy objects on the product, causing it to fall and/or break, resulting in personal injury and property damage. In addition, the product itself may fall and cause injury and property damage.
- Contact Atlas Sound for instructions on cleaning the inside of the unit. Large accumulations of dust inside the unit may result in heat buildup and fire.
- Ensure that the power supply plug is securely plugged into the wall outlet. Never allow dust to accumulate on the power plug or inside the wall outlet.
- When cleaning the unit or the unit is not to be operated for an extended time period, unplug power cord from the wall.





Introduction

The Atlas Sound DSP8807 digital processor "Privacy" system is a self contained, compact multi-zone digital DSP-GUI controlled processor and digital amplifier capable of simultaneous distribution of masking, paging, and background music signals for use maybe in Industrial, Institutional, Commercial and Government facilities.

The Atlas Sound DSP8807 unit is capable of automatic mixing, set up and administration of all 8x8 inputs / outputs per zone (channel) via an intuitive 'simple to use' Graphic User Interface (GUI) managed via a local Windows® based laptop or desktop computer. The DSP8807 has 8 channels of independent on-board digital class-D amplifiers that are capable of delivering 50W RMS at 70V output. Additionally a simultaneous audio line level output rated at 1V/600Ω (nominal) per zone is available for driving higher power amplifiers. The DSP8807 also has two (2) independent uncorrelated pink noise generators which are random and non-repeating up to 215 hours with EQ adjustments programmable on a per zone basis. The DSP8807 provides dynamic control and management based on IEEE802.1 AVB standards (Audio-Video Bridging) with independent 1/3 Octave (28) band EQ *(Filter type is Butterworth @ 19dB and Linkwitz-Riley at 24dB) and Parametric EQ for calibration of all PA, ambient level sensing and automatic level control on a per zone basis. Paging (PA) presets can be assigned in 10dB increments (10, 20, 30dB) per zone with automatic gain control (AGC) for all Telco and microphone paging inputs.

The DSP8807 GUI is called the 'Sound Media Interface'. The software has the ability to expand up to (256) systems with over 2,000 zones (2,048) with primary and secondary assignment in a zone paging dialing plan. It also provides the ability to set up All zone page, Group zone page (up to 32 groups) and Single zone page with an architectural dialing plan (2-digit DTMF) set up in the GUI. Each DSP8807 is capable of managing remote ambient level sensing microphones (ALM-1) for each zone (x8) wired via a single CAT5e cable up to 1,000 feet from the DSP8807 for automatic adjustment of the masking level based on real-time noise levels with set up and control via the GUI.

The Atlas Sound DSP8807 system provides the following basic masking capabilities:

- Creates an acceptable level of speech privacy in open work areas
- Enhances speech privacy between modular offices
- Decreases intelligibility and noise distraction caused by stand-up, casual conversations and random room noises
- Reduces awareness of existing sounds
- Increases worker productivity and employee satisfaction
- Enhances clients revenue due to less employee distraction
- Lessens the need for unexpected and expensive acoustical upgrades
- Flexibility which insures specific masking spectrums for varying ceiling types including; t-bar, open, wood slats and clouds

Basic Function

- (8) Channels of Random Pink Noise Generator Non-Repeating Up to 215 Hours
- (8) Audio Outputs of 50W RMS Digital Class-D Amplification at 85% Efficiency
- (8) Audio Line Outputs at 1V/600Ω (Nominal) for Unlimited Power Per Zone
- (8) Independent Outputs of 1/3 Octave 28-Band EQ Defined and Shaped in GUI
- IEEE 802.1 AVB (Audio Video Bridging) Technology for Time Aligned Networking of Multiple Units
- AVB Operation Allows IP Based Paging Via Ethernet Connection
- (8) Ambient Sensing Microphone Inputs (RJ45) for Automatic Level Sensing (6dB) and Control
- Compatible with ALM-1 Ambient Sensing Microphones Operating Up to 1,000 Feet Away
- Multiple Audio Source Inputs for Background Music, Paging and Emergency Page Overrides
- Telco Paging Input (Loop Start) with 2 to 5 Digit DTMF (Touch Tone) Dial Plan Defined in GUI
- Multiple 'Form-C' Contact Closure Relay Inputs (x4) for Ancillary Devices
- Microphone Input with System Mute
- Emergency Override Inputs for Automatic Page Override
- On-Board MAC Address for IP Addressability and Remote Control Compatible With DHCP MS Server
- User Friendly GUI (Sound Media Interface) for Set Up





- Zone Expansion from 1 to 2,048 Via Standard CAT5e – CAT6 Cabling (Up to 256 Systems)
- All-Call Page, Group Zone Page, and Single Zone Page Defined in GUI
- Independent Parametric EQ for All Paging Sources
- Microphone Balanced Input with On-Board Phantom Power at 32VDC
- On Board Signal Generators for Paging Confirmation, Busy, and Pre-Announce Tones
- Non-Volatile DSP Memory Components for All System Controls with Ten (10) Year Memory
- DSP8807 Multiple Mounting Options; Rack, Cabinet, Shelf, or Wall at 2RU (3.5") Height x 15" Deep
- Visual Status Front Multicolor LEDs for All Major Inputs and Outputs
- Rear Access Network Connection (RJ45) with Front Manual DSP Reset Button
- Overload, Short, and Current Limit Protection with Automatic Reset for All Critical Components
- All Power Components Are UL Recognized, Boards Are UL94v0 and RoHS
- DSP8807 Is UL / CUL / FCC and CB (International) Listed

BASIC APPLICATIONS DIAGRAM

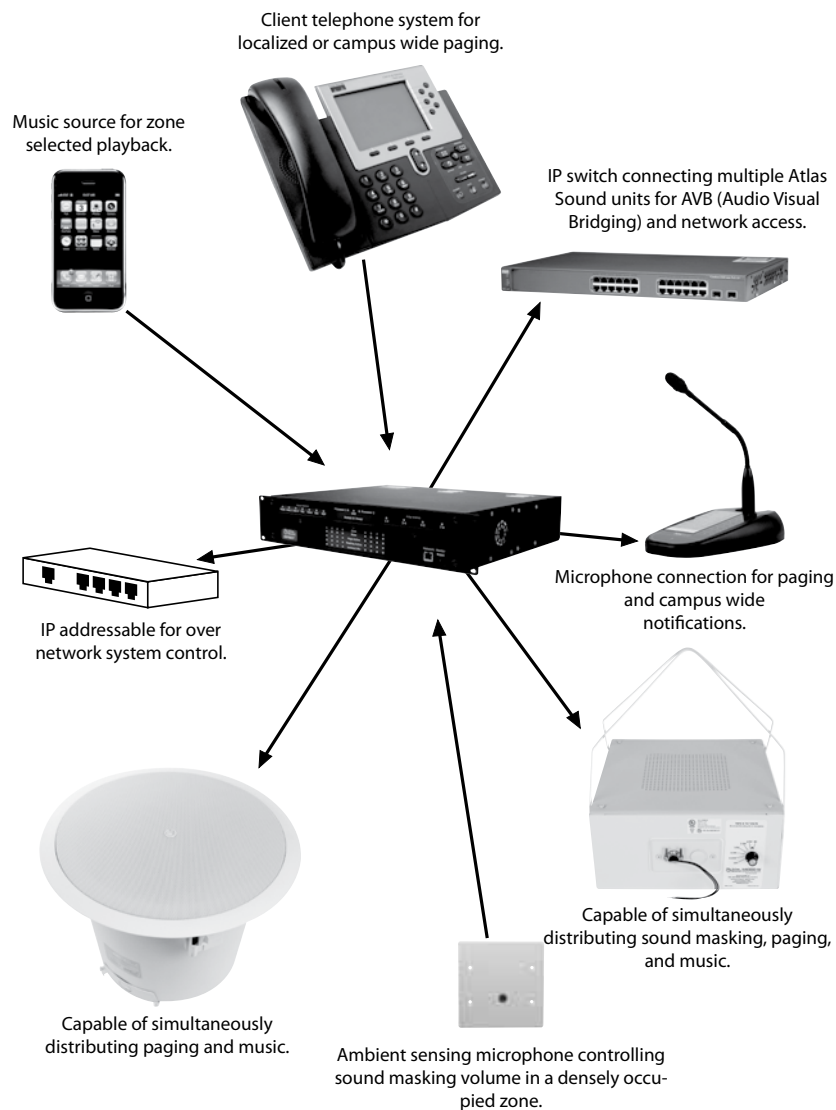

1601 Jack McKay Blvd. • Ennis, Texas 75119 U.S.A.
Telephone: 800.876.3333 • Fax: 800.765.3435



SYSTEM OVERVIEW – SIGNAL FLOW DIAGRAM

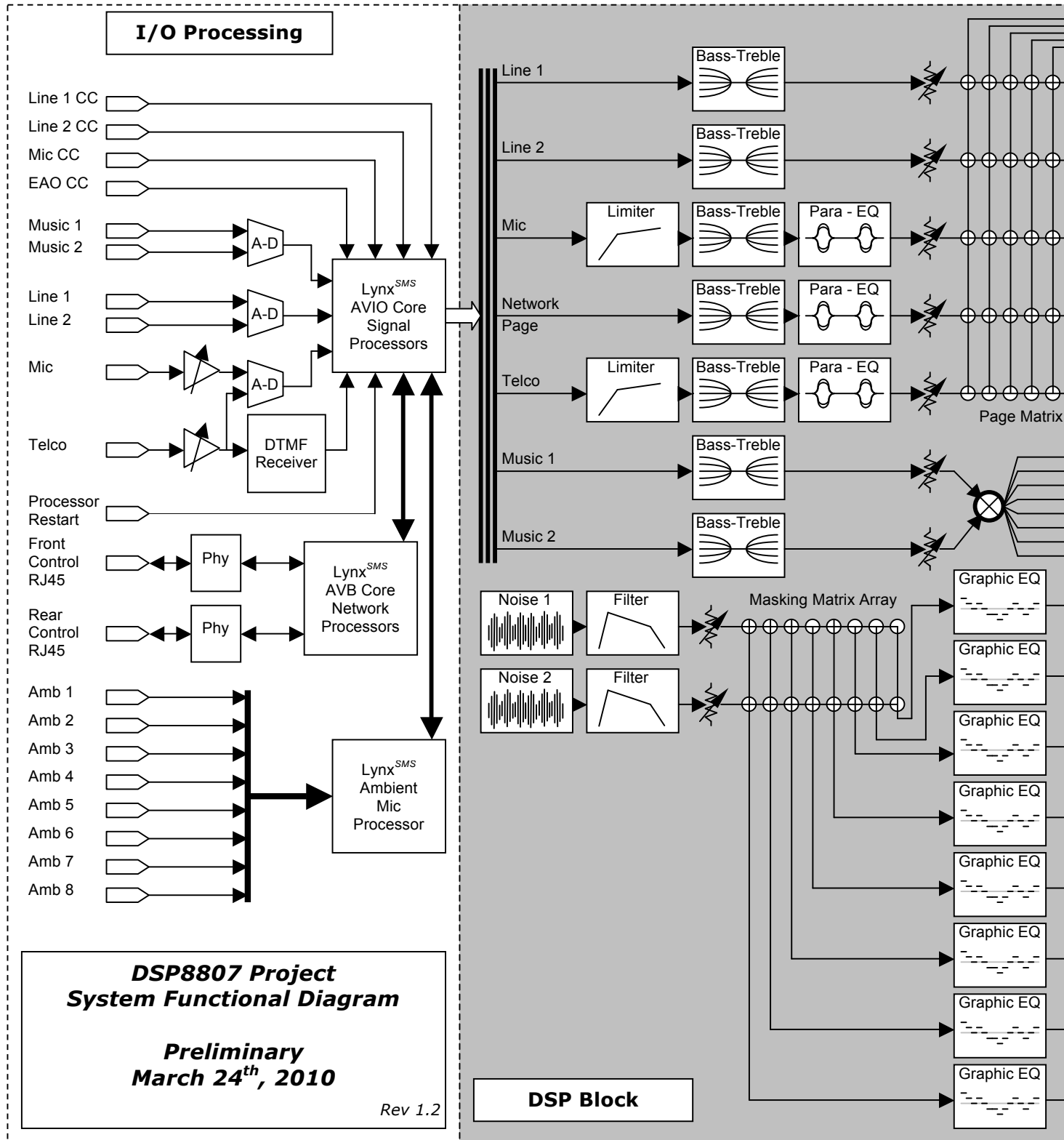

**DSP8807 Project
System Functional Diagram**

**Preliminary
March 24th, 2010**

Rev 1.2

DSP Block



1601 Jack McKay Blvd. • Ennis, Texas 75119 U.S.A.
Telephone: 800.876.3333 • Fax: 800.765.3435

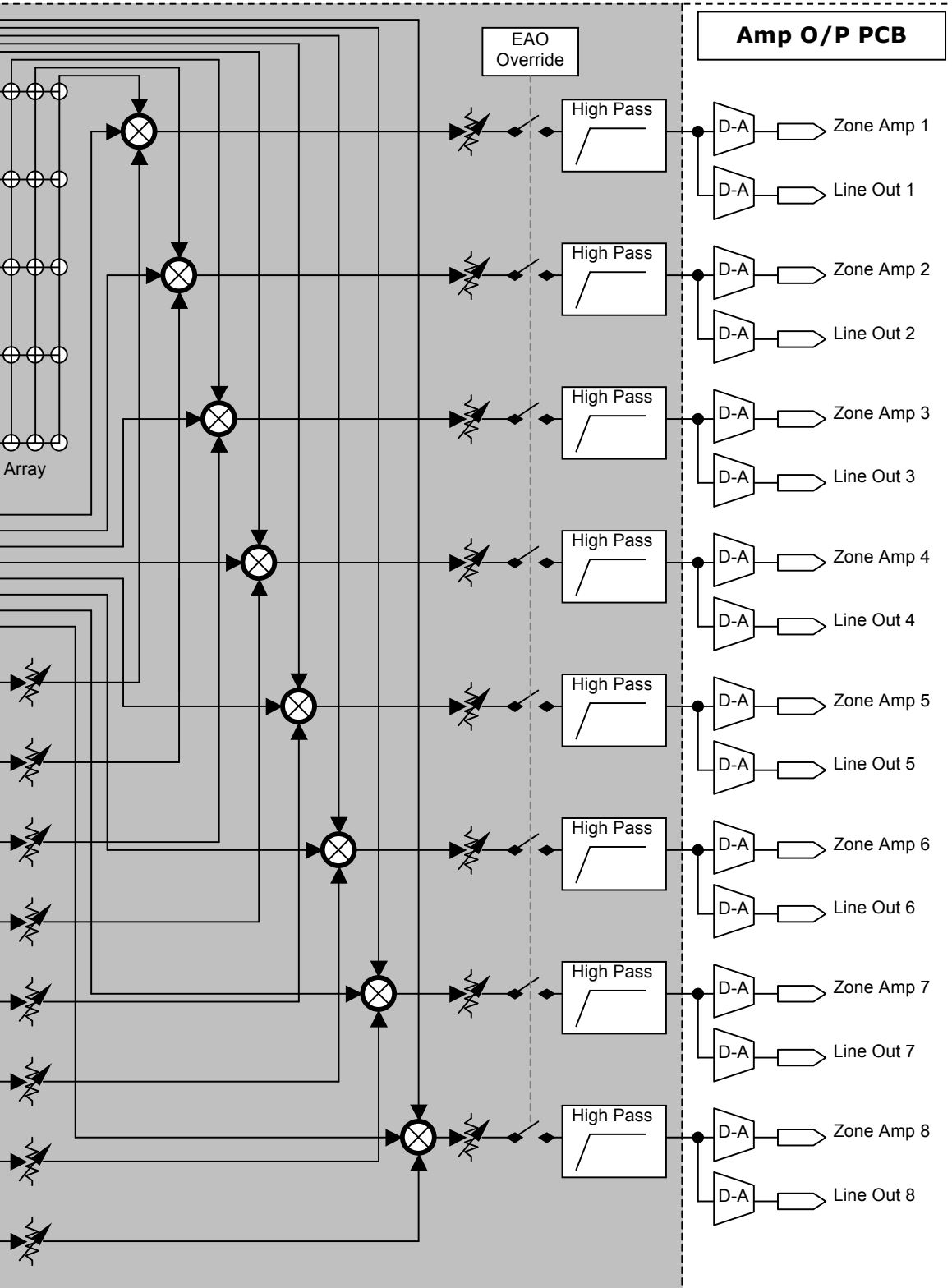

1601 Jack McKay Blvd. • Ennis, Texas 75119 U.S.A.
Telephone: 800.876.3333 • Fax: 800.765.3435



DSP8807 FRONT

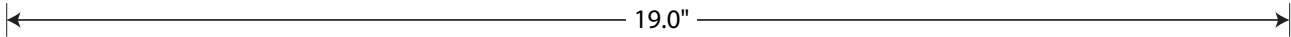
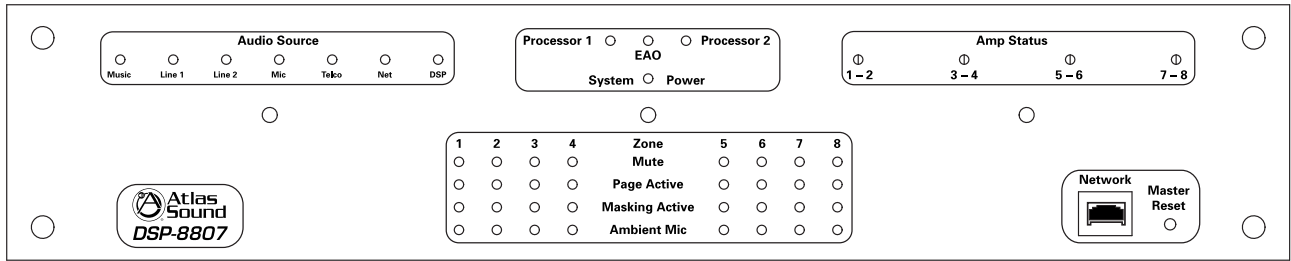

DSP8807 REAR

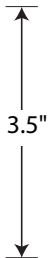
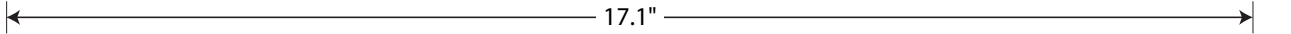
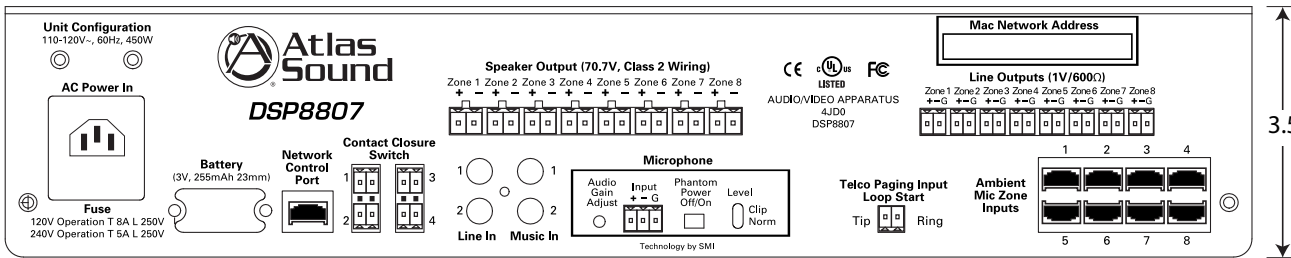

DSP8807 TOP PANEL

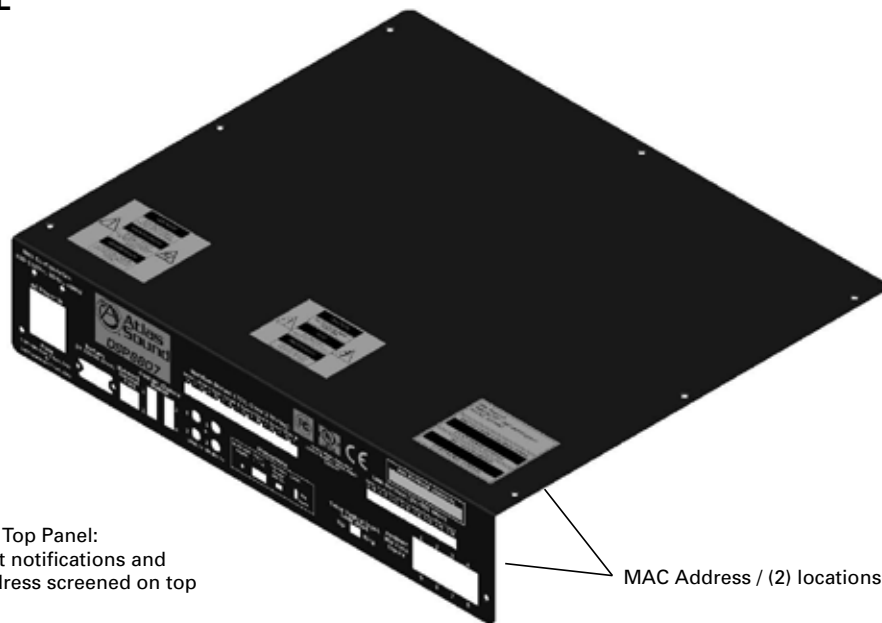

DSP8807 Top Panel:
Important notifications and
MAC Address screened on top

MAC Address / (2) locations



1601 Jack McKay Blvd. • Ennis, Texas 75119 U.S.A.
Telephone: 800.876.3333 • Fax: 800.765.3435



INSTALLATION

COMPUTER NETWORK TERMINATION

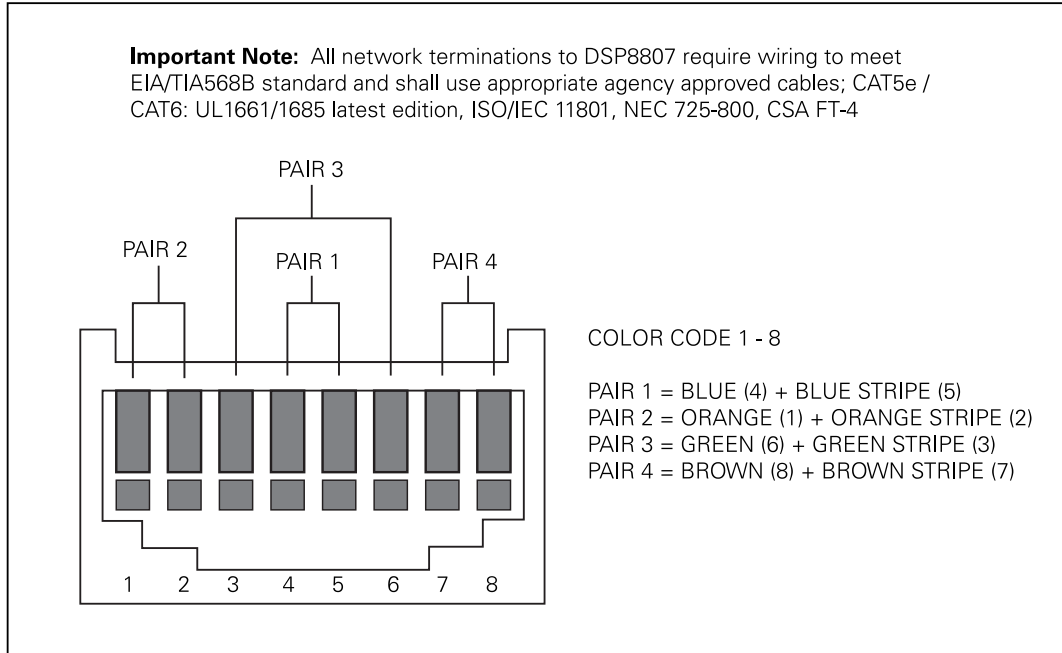

NOTE: All 'RJ45' Network connections must be wired to meet EIA/TIA 568B standard.

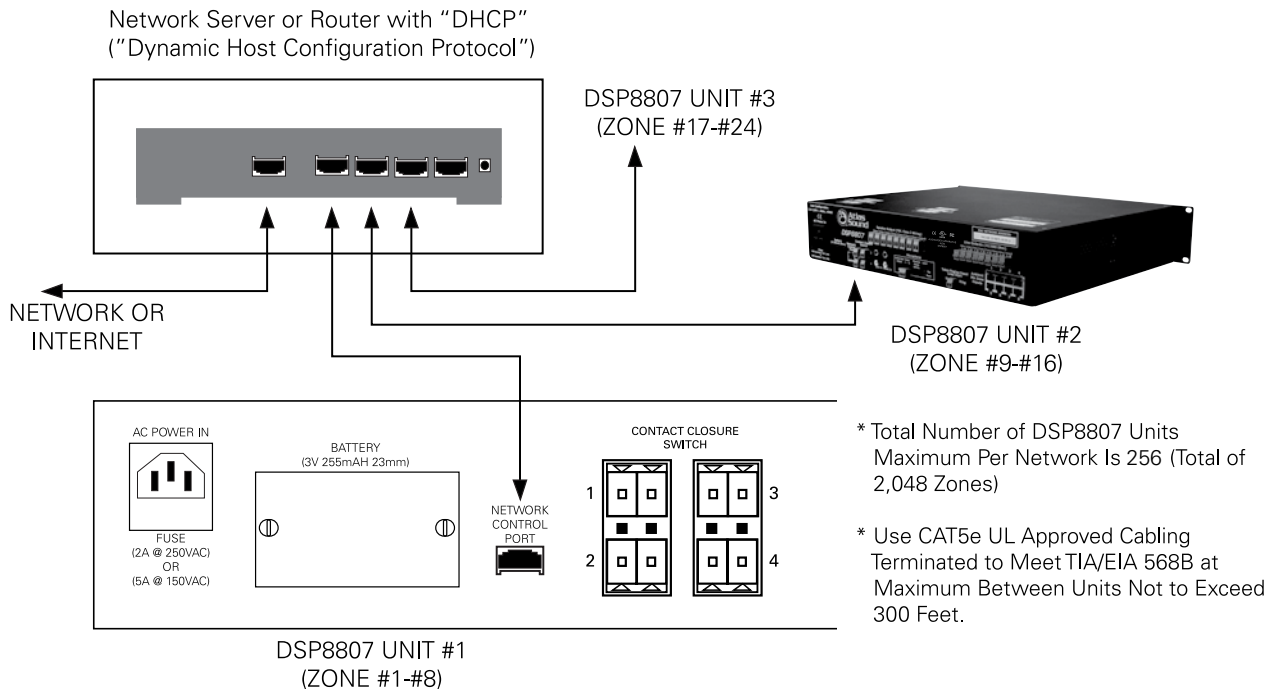

1601 Jack McKay Blvd. • Ennis, Texas 75119 U.S.A.
 Telephone: 800.876.3333 • Fax: 800.765.3435



70V SPEAKER TERMINATION

Dockable 2-pin/socket connectors (commonly referred to as 'Phoenix' type) are used which are keyed or polarized to fit one way – do not force fit these connectors and follow these basic instructions;

- Do NOT force fit the connectors – they are polarized to fit in one direction
- Follow the +/- wiring polarity to all speakers
- Use only 70V speakers
- Ensure that total speaker wattage taps per channel does NOT EXCEED 80% of the rated output of 50W RMS per zone.

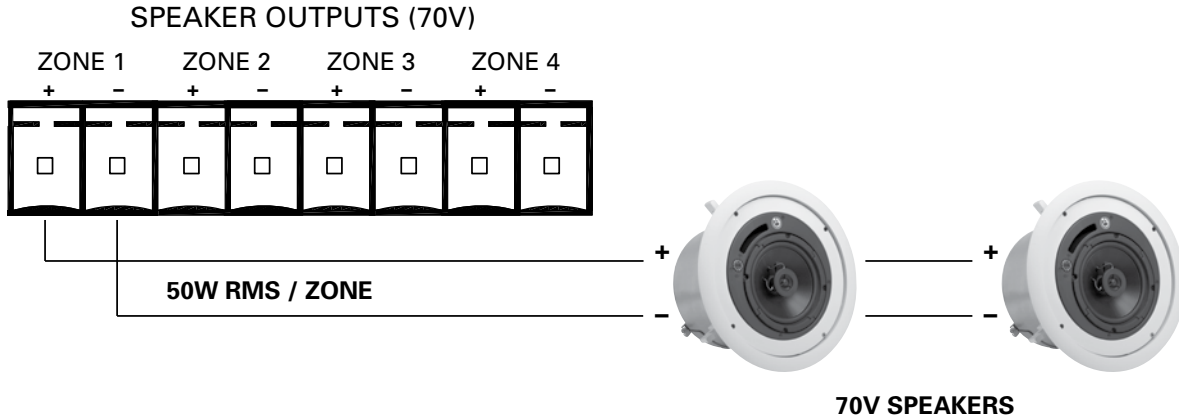

AUDIO LINE LEVEL TERMINATION (1V/600Ω)

Typical use of the Audio Line Output is to increase the power (Watts) via an auxiliary amplifier capable of powering speakers above the 50W RMS level provided by DSP8807. Ensure the wiring matches the (+ / - / G) for each zone output to each amplifier audio input.

LINE OUTPUTS (1V / 600 OHM)





AC POWER INPUT (120VAC @ 60Hz or 240VAC @ 50Hz)

As noted in the 'important notices' section the DSP8807 utilizes a UL recognized IEC AC power plug and cord (provided with the unit) which must not be changed or defeated. Please follow these important instructions. Failure to do so will void the product warranties.

The Mains Plug is the main disconnect device for the product, and shall be located so as to be readily accessible.

NOTE: Once the AC power is switched 'ON' it will take approximately '30' seconds to initialize and start up.

- Do not defeat the safety purpose of polarized, keyed or grounding type connectors. A polarized plug has two (or multiple) contacts with one wider or longer than the other. A grounding type plug has two blades and a third grounding plug. The wide blade or third prongs are provided for your safety. Do not defeat or change these. If the provided IEC power plug does not fit into your outlet, consult an electrician or your local authority having jurisdiction to replace the outlet to ensure meeting local building codes while assuring proper connection.
- Protect the power cord from being walked on or pinched particularly at the plug, receptacle outlet, and the exit point of the unit.

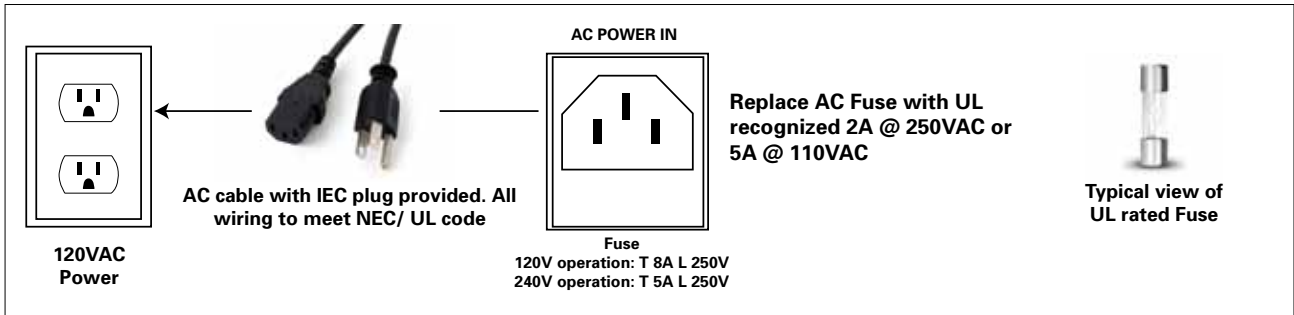

AMBIENT SENSING MICROPHONE (ALM-1) TERMINATION

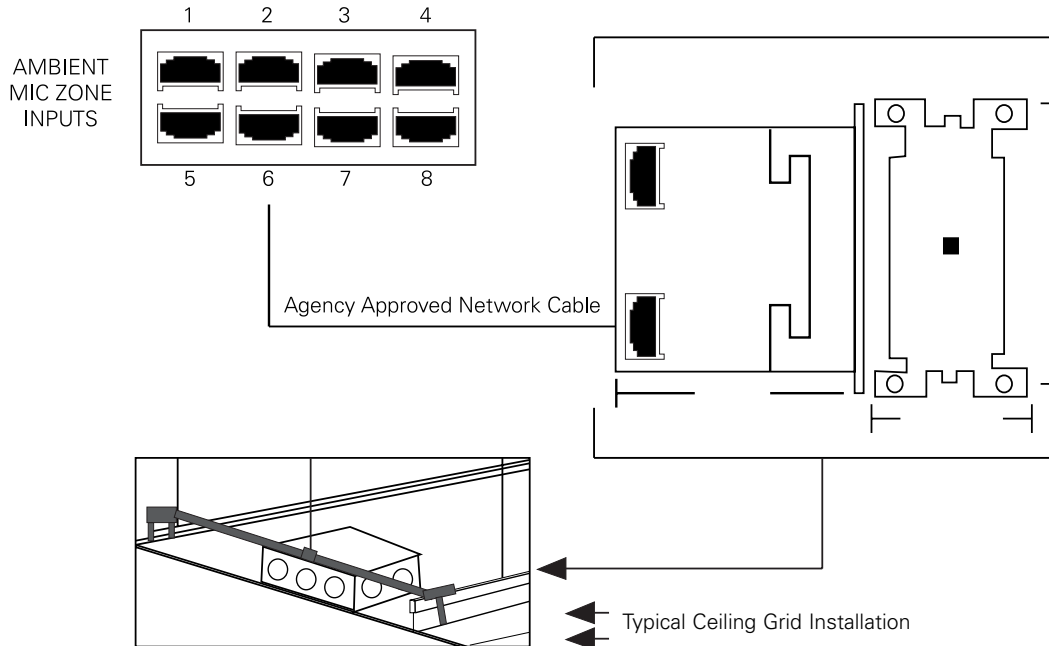

1601 Jack McKay Blvd. • Ennis, Texas 75119 U.S.A.
Telephone: 800.876.3333 • Fax: 800.765.3435



PAGING MICROPHONE INPUT TERMINATION

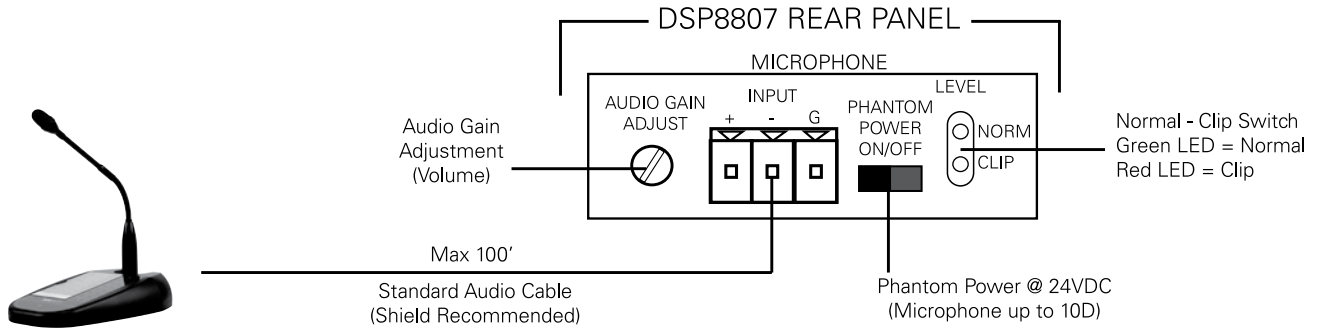

BACKGROUND MUSIC AND LINE INPUT TERMINATION

DSP8807 REAR PANEL

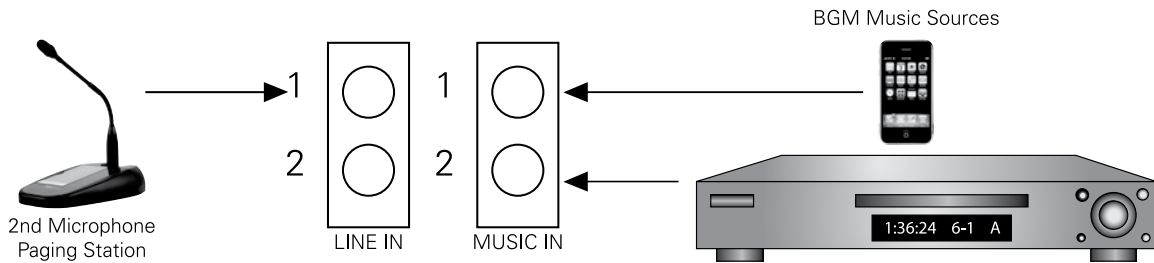

CONTACT CLOSURE SWITCH INPUT TERMINATION

DSP8807 REAR PANEL

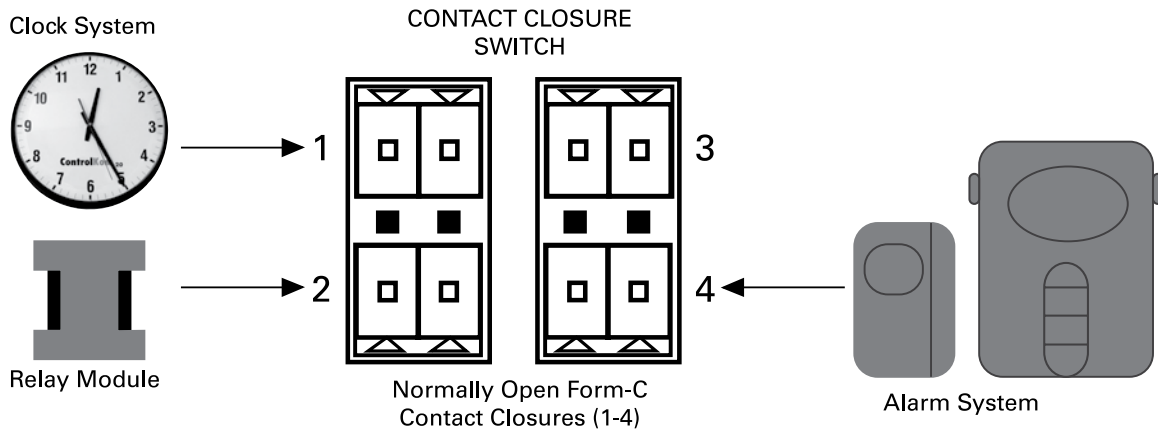



TELCO PAGING INPUT

CAUTION: Use only with Telephone Equipment that supplies voltages NO GREATER THAN -60VDC, and connects to the DSP8807 only within a building.



DSP8807 has built in tone generators for audible status for paging; connection to the system responds with 'single beep', entering a page plan number responds with 'two beeps'.

MEMORY BATTERY REPLACEMENT

CAUTION: If battery is incorrectly replaced explosion can occur. Replace only with the same or equivalent type.

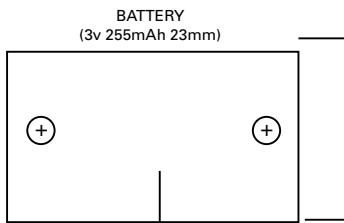

Remove metal cover (2 screws) and replace Battery as needed with 3V, 255 mAh, 23mm x 3mm size. Typical is Lithium cell coin battery, Panasonic model CR2330

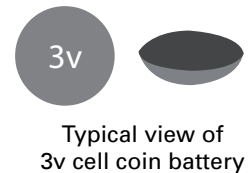

MOUNTING

The DSP8807 unit is designed to mount into standard EIA cabinets, free standing racks, or consoles using the (x4) front slots. NOTE: Allow a minimum one (1) rack space above and below (at 3.5") between the DSP8807 and any other electronic equipment to ensure proper thermal ventilation. This unit may also be mounted on a shelf using the pads provided (x4).

SYSTEM OVERVIEW – SYSTEM HARDWARE / SOFTWARE REQUIREMENTS

The DSP8807 unit has the following hardware and software computer requirements;

- Microsoft Windows Operating system shall be: XP Professional, Windows Vista, Windows 7 or better
- 50MB of available hard disk space
- 512MB of RAM of higher
- A network connection with a minimum data transfer rate of 10Mbps or higher (100Mbps is recommended).



1601 Jack McKay Blvd. • Ennis, Texas 75119 U.S.A.
Telephone: 800.876.3333 • Fax: 800.765.3435



Installation – GUI / “Sound Media Interface” Set Up

START UP – “SETTINGS”

1. The DSP8807 is based on Microsoft ethernet router with DHCP server. Each unit has a specific MAC address embedded in the system (shown on the rear panel and top plate of the unit).
2. The DSP8807 GUI – Sound Media Interface operating software requires a PC based computer running Microsoft® Windows® XP Professional or higher. The DSP8807 system will operate with: Windows® XP Pro, Windows® XP Media Center, Windows® XP Pro x64, Windows® Vista (Business, Enterprise, Ultimate), Windows® 7, Windows® Server 2003, Windows® Server 2008, and Windows® Server 2008 R2.
3. The unit being installed will show the main program window (below), select ‘Settings’ and then “Poll for Hardware” which applies the IP address. The IP address will appear in the window, select “Connect to this unit”.

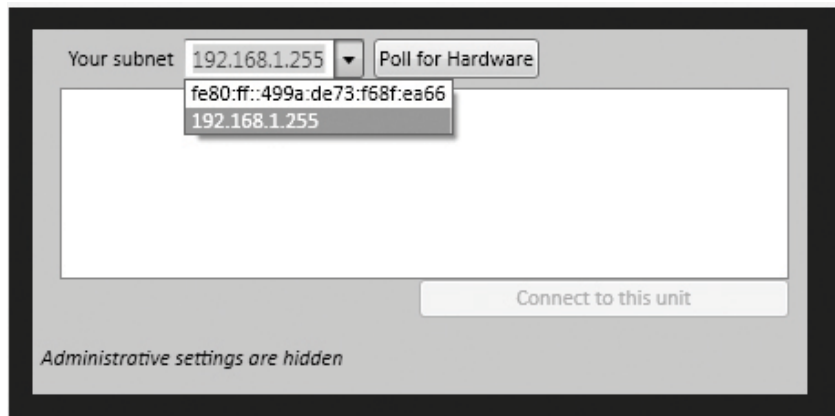
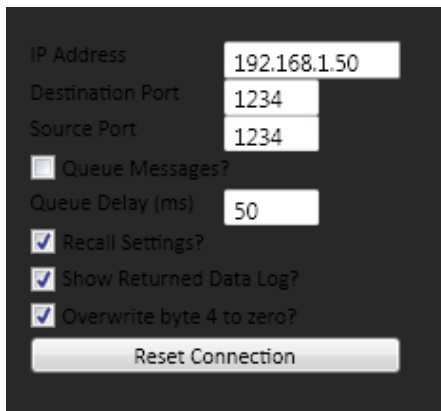



START UP – 'SYSTEM'

1. Select 'System' from the menu bar (upper left side of screen). All DSP8807 programmable options are then visible in the main 'System Diagram' dialog box (center of screen). All options, when selected, will display a second dialog box for specific settings that will appear in the lower section. As you work in this screen it will display 'Active View' at the top. On the right side of the screen there will be "scroll bars" that may be used (up/down) to reach all settings for zones 1 to 8.

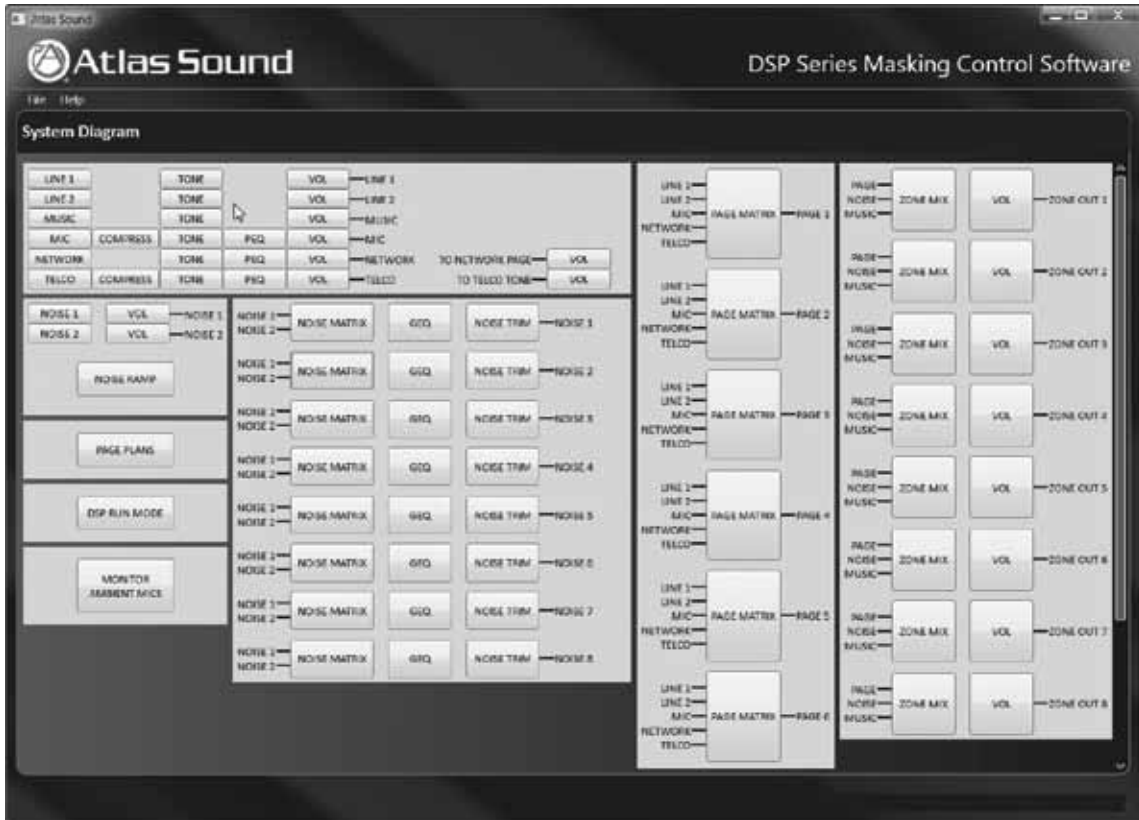

2. There are several methods of making adjustments to the system as shown below. When the cursor (mouse) is moved across the screen, the "active" item will light up.

Methods of adjustments include:

- Move slider up / down
- Click on up / down symbol
- Type in number



1601 Jack McKay Blvd. • Ennis, Texas 75119 U.S.A.
Telephone: 800.876.3333 • Fax: 800.765.3435



3. The 'Sound Media Interface' GUI will automatically prompt you to enter acceptable values within the operating system when these are being typed in.

NOTE: When entering an adjustment value and a value outside the operating range is entered, an "Out of Range" message will appear prompting for the a new value to be entered.

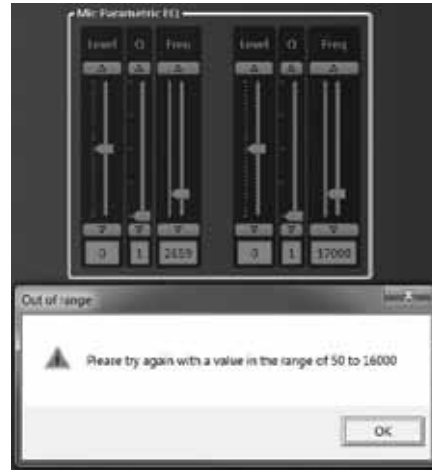

MASKING - NOISE SETTINGS



These are all settings relative to establishing appropriate masking levels for each Zone 1 to 8. Start adjustment with the LEFT selection buttons; Noise 1 and 2 and work in progression to the right to 'Noise Trim'. The DSP8807 has two (2) independent random masking generators on board that can be optioned in any given zone.

NOISE 1 AND 2:

- 1. This button selection turns the masking, On or Off.

NOISE 1 AND 2 VOLUME

- 1. Select the 'Noise 1 Volume / Noise 2 Volume' which presents a 'Noise 1 Volume' level adjustment which can be set by sliding the center knob or typing in the desired level from -65dB to +15dB.

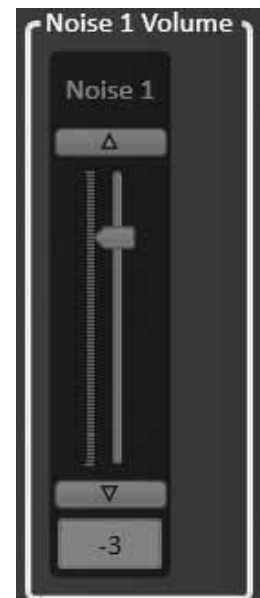
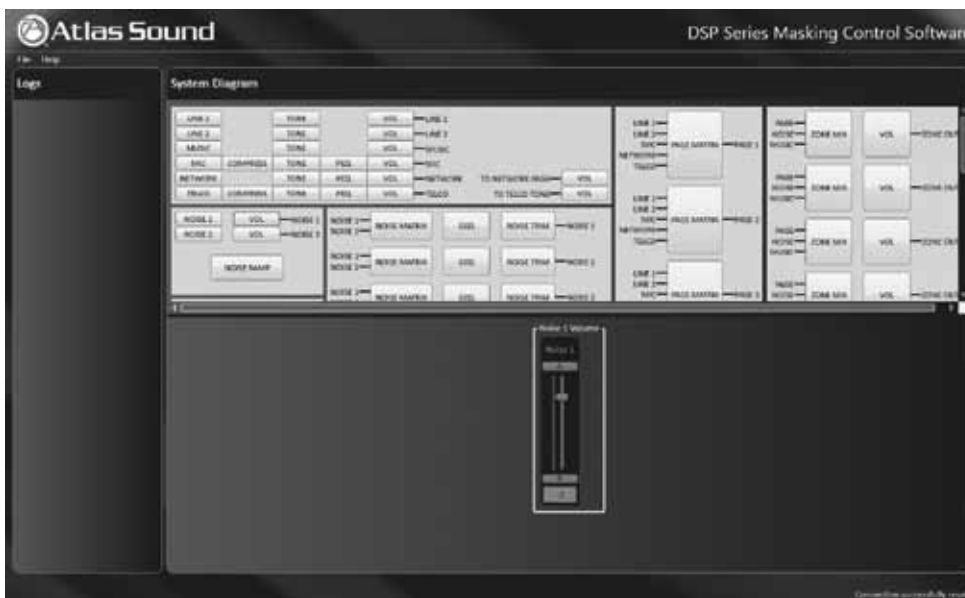



- 2. Select the 'Noise Matrix' for Noise 1 or 2 which drops down the 'Noise 1 Matrix' option box, select Noise 1 or Noise 2 for each zone 1 to 8.

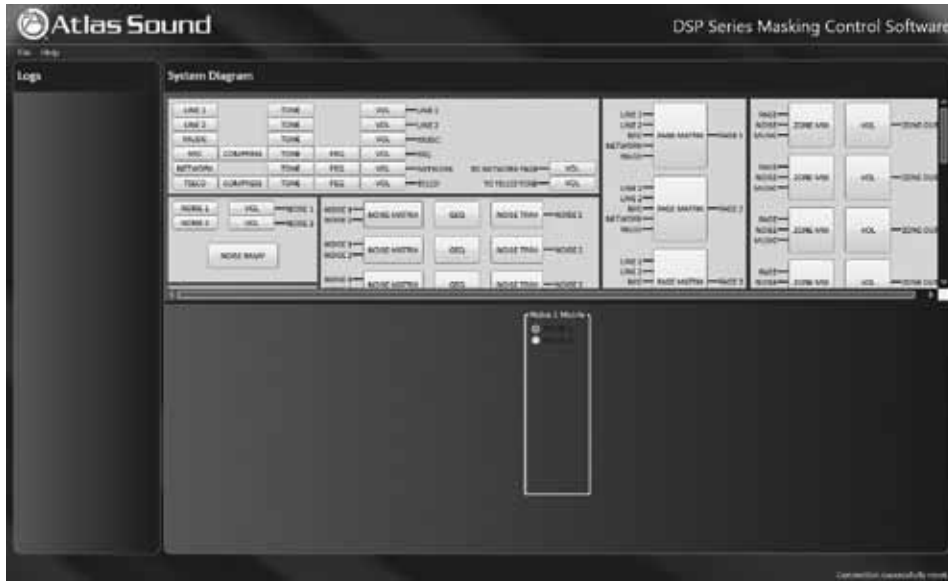

NOISE 'GEO' (GRAPHIC EQ)

- 3. Select the Noise 'GEO' (Graphic EQ) button for each zone which drops down the 1/3 Octave 28 band EQ with settings from 40Hz to 20kHz. Set the desired frequency by moving the slider or typing the number at the bottom with a frequency scale from -15dB to +15dB. NOTE: The specific band being set will light up as you scroll across.

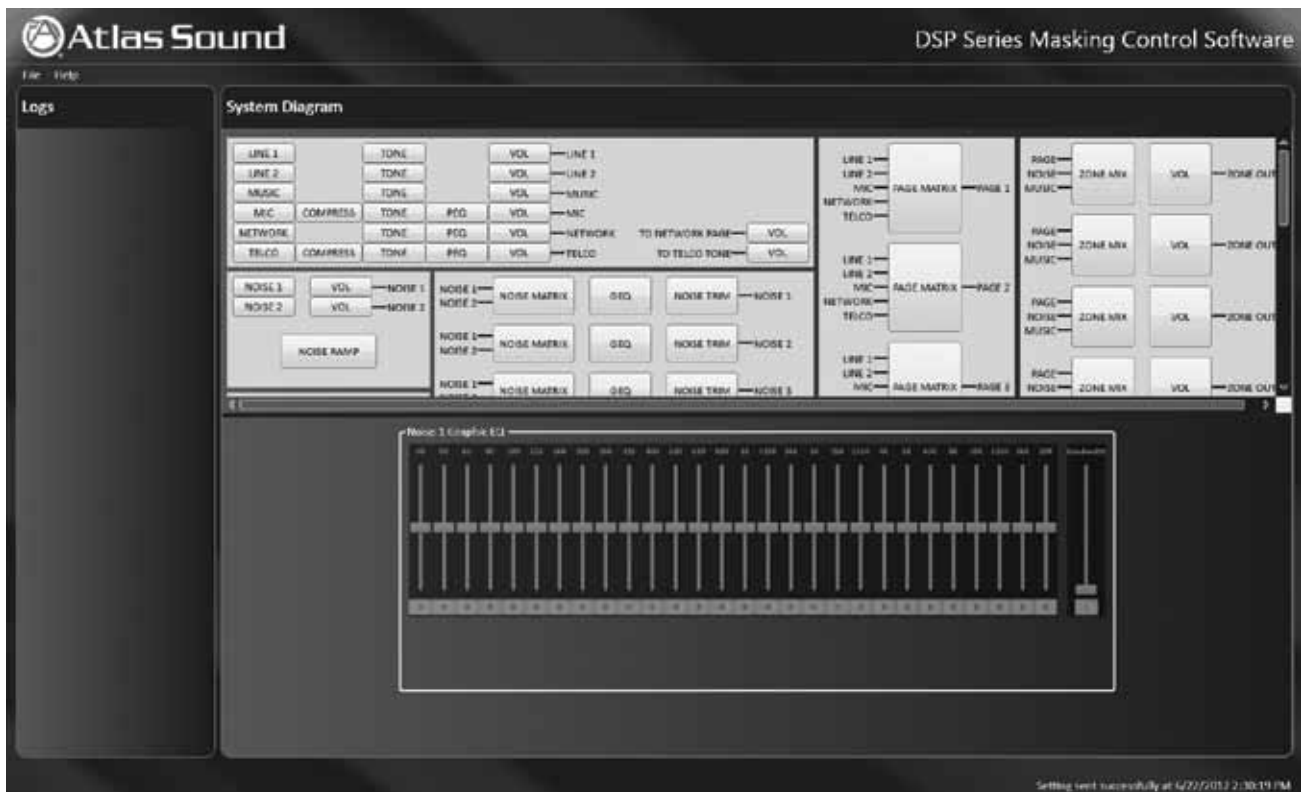

1601 Jack McKay Blvd. • Ennis, Texas 75119 U.S.A.
Telephone: 800.876.3333 • Fax: 800.765.3435



NOISE TRIM/ dB LEVEL

- In the 'System' select mode with 'Active View' open; select 'NOISE TRIM' button which presents an option for raising or lowering the level on a per-zone basis as shown below. Each increment (54dB to 72dB) represents a 1dB increase or decrease from the base setting. Select required level button(s) from 54dB to 72dB in the box which activates 1dB 'trip point' – repeat settings for zones 1 through 8.

Setting example: If you select 57dB, 63dB and 69dB the masking noise level will raise 1dB as each ambient level is reached this will occur as each level is passed for a total of 3dB masking noise increase as the ambient level passes 69dB. The reverse will occur as the ambient level decreases past the selected 'trip points' so that the masking noise level returns to the base level setting.

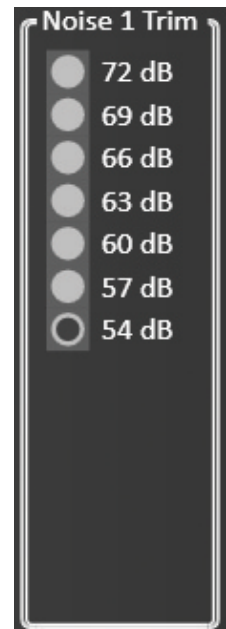
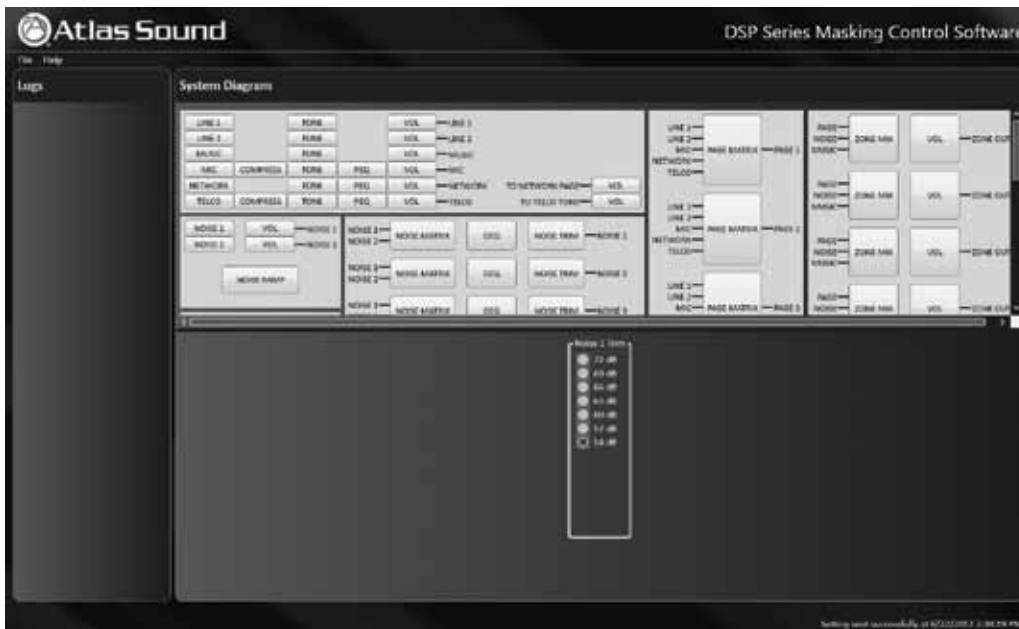

SOURCE INPUTS: LINE (1, 2), MUSIC, MIC, NETWORK, TELCO

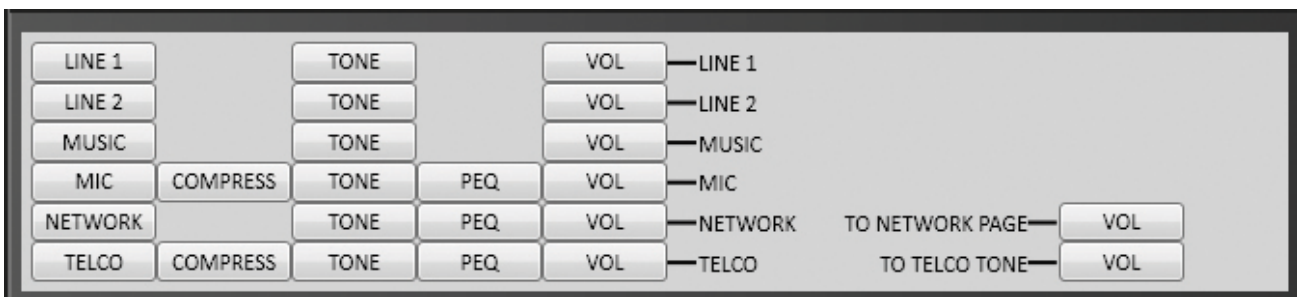



LINE 1 AND LINE 2 INPUTS: TONE

1. The DSP8807 allows multiple source inputs which have numerous adjustment options. Starting with the Line 1 and Line 2 input (top left side) you can adjust both 'Tone' and 'Volume'. Selecting 'Line 1' and 'Tone' will drop down a box 'Line 1 Tone' with Bass and Treble adjustments; Base: Frequency: 100Hz-1000Hz and Level: -15dB to +15dB. Move the slider or type in the required number.

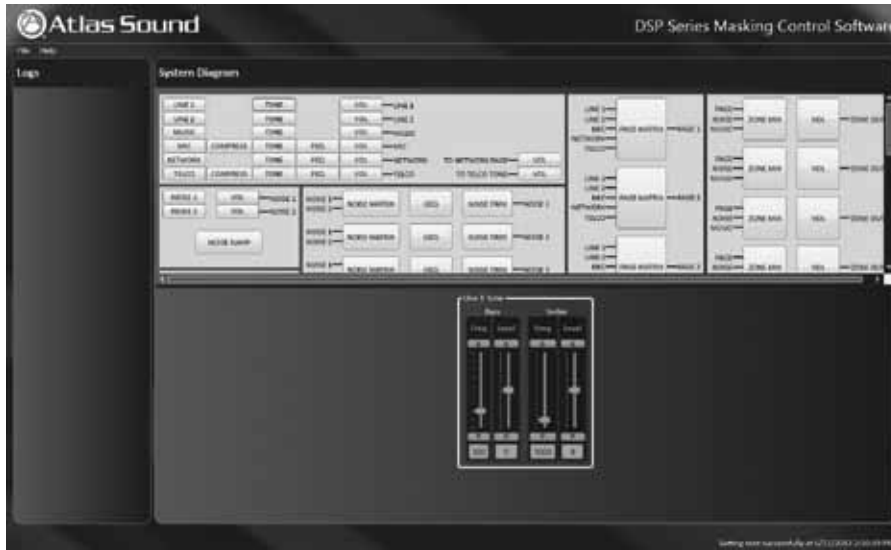

LINE 1 AND LINE 2 INPUTS: VOLUME

1. After selection Line 1 or Line 2, select the 'VOL' (Volume) button which drops down a 'Line 1 Volume' box with a slide adjustment from -65dB to +15dB. In order to test volume you can select 'Start Meter' which provides an active meter view of music 'signal present'. When the test is complete select 'Stop Meter'.

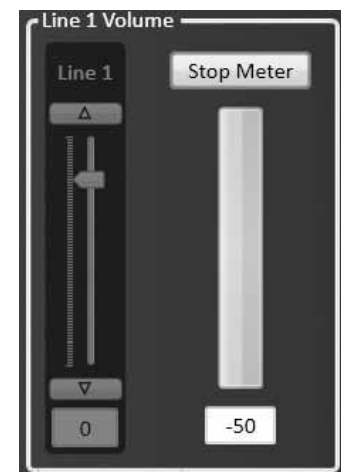

1601 Jack McKay Blvd. • Ennis, Texas 75119 U.S.A.
Telephone: 800.876.3333 • Fax: 800.765.3435



MUSIC INPUT: TONE

1. Music has both 'TONE' and 'VOL' (volume) adjustments. Select Music 'TONE' button which drops down a 'Music Tone' box with adjustment for Bass and Treble. The adjustable ranges for the bass include: frequency, 100Hz-1000Hz, and Level, -15dB to +15dB. Move the slider or type in the desired number.

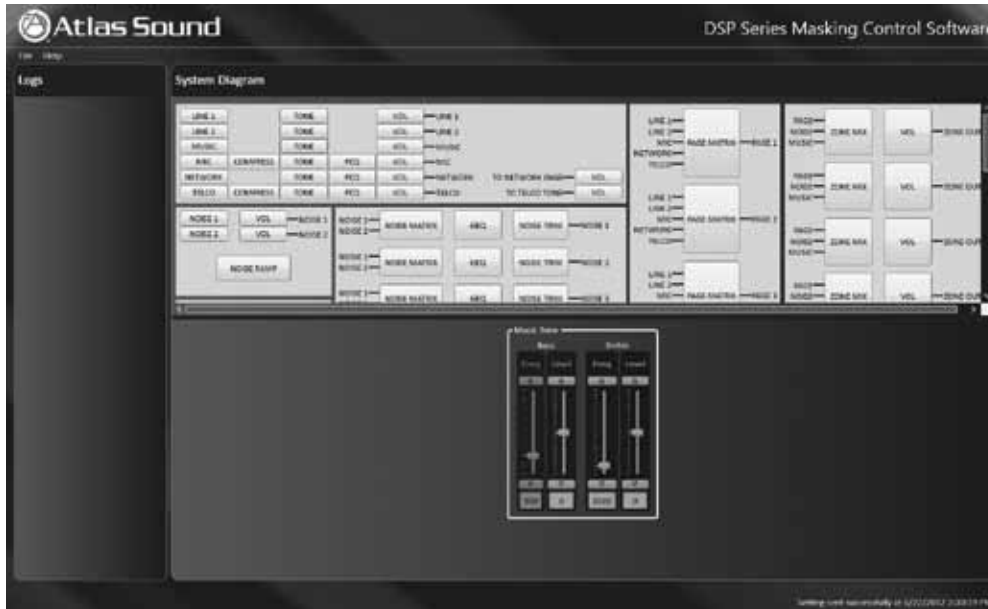

MUSIC INPUT: VOLUME

1. After selection Music, select 'VOL' (volume) button. This will drop down a 'Music Volume' box with a slide adjustment from -65dB to +15dB. In order to test volume you can select 'Start Meter' which provides an active meter view of music 'signal present'. When test is complete select 'Stop Meter'.

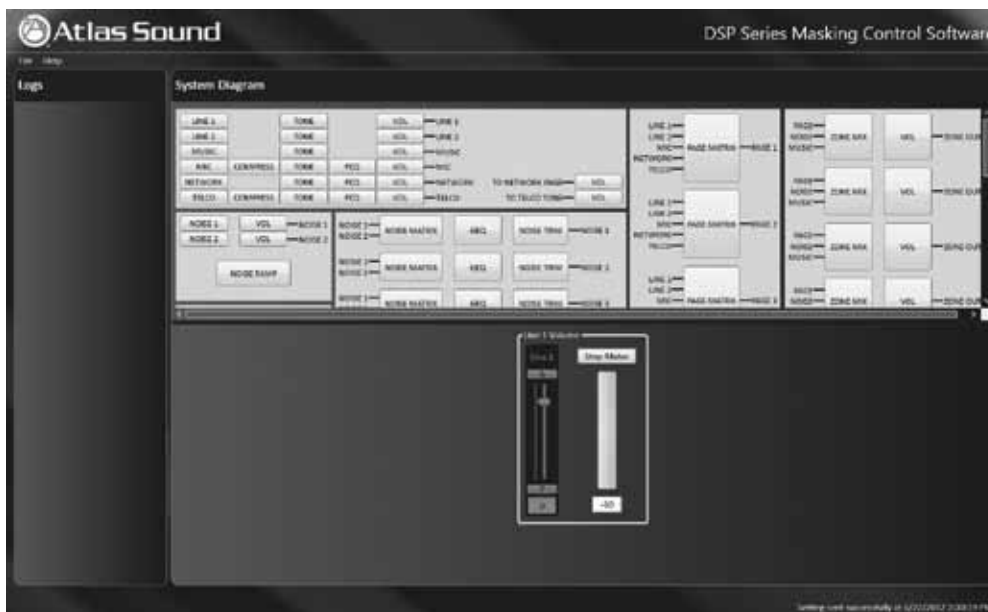

1601 Jack McKay Blvd. • Ennis, Texas 75119 U.S.A.
Telephone: 800.876.3333 • Fax: 800.765.3435



MICROPHONE INPUT: COMPRESSOR

1. Select 'MIC' (Microphone) and then 'COMPRESS' (Compressor) to activate compression of audio signal with adjustment to 'Threshold' and 'Ratio' as follows, threshold has a range from -54dB to +6dB and ratio is from 1-10. Move the slider or type in the required number.

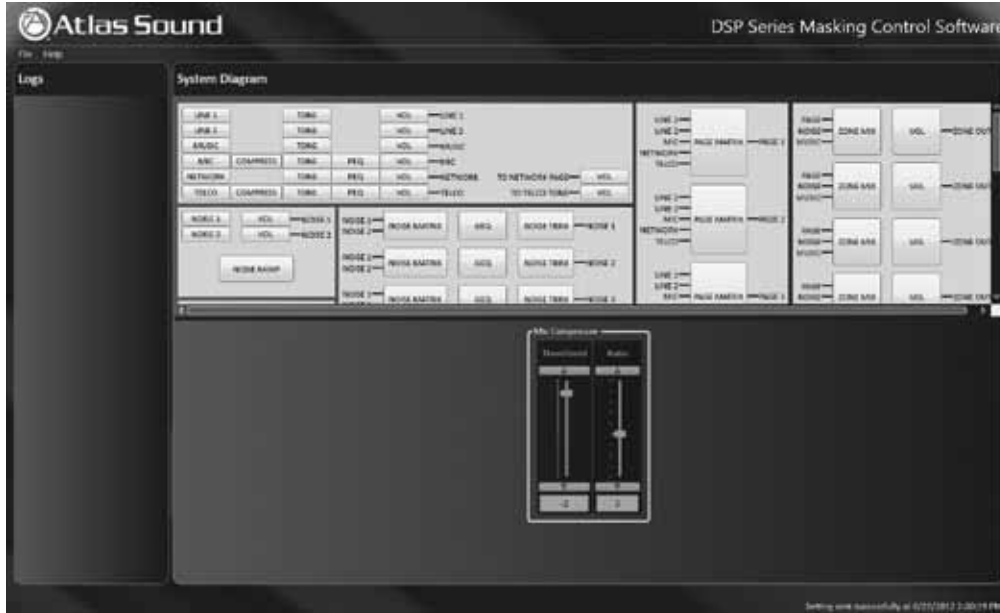

MICROPHONE INPUT: TONE

1. Select Microphone 'TONE' button. This will drop down a 'MIC Tone' box with adjustment for Bass and Treble. The adjustable ranges include: (Bass) frequency, 100Hz-1000Hz, and level, -15dB to +15dB, (Treble) frequency, 1000Hz to 20,000Hz, and level, -15dB to +15dB. Move the slider or type in the required number. NOTE: Each adjustment will light up when cursor is working in a specific area.

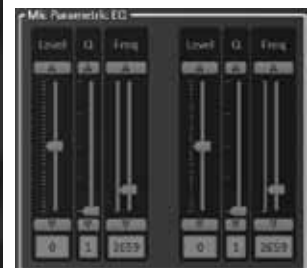
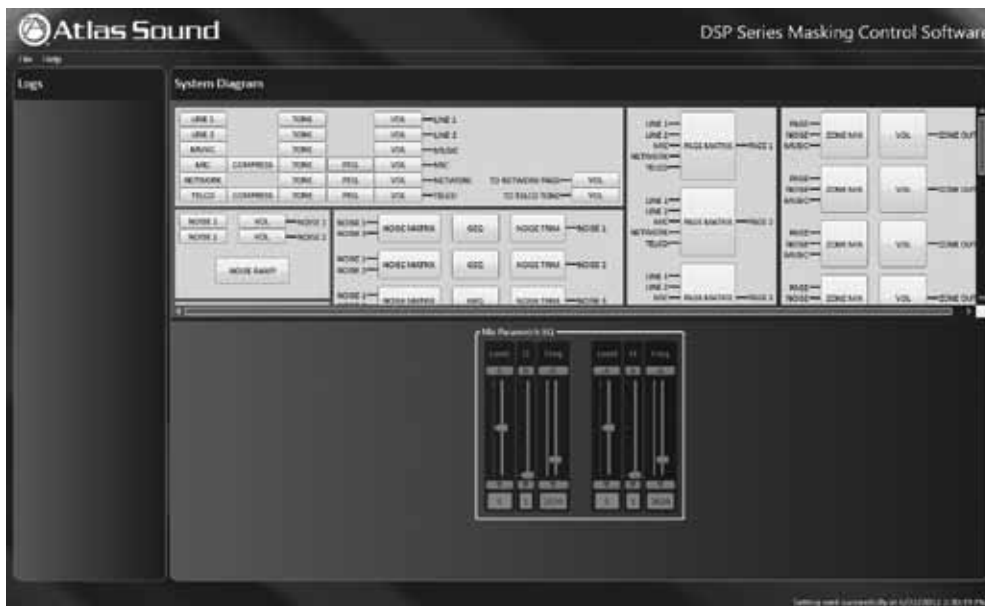

1601 Jack McKay Blvd. • Ennis, Texas 75119 U.S.A.
Telephone: 800.876.3333 • Fax: 800.765.3435



MICROPHONE INPUT: 'PEQ' / PARAMETRIC EQ

1. Select the MIC Parametric 'PEQ' to adjust Level, Q and frequency. Select each function and adjust to these ranges; level is -14dB to +14dB, 'Q' is 1 to 5 and frequency is 50Hz to 16kHz.

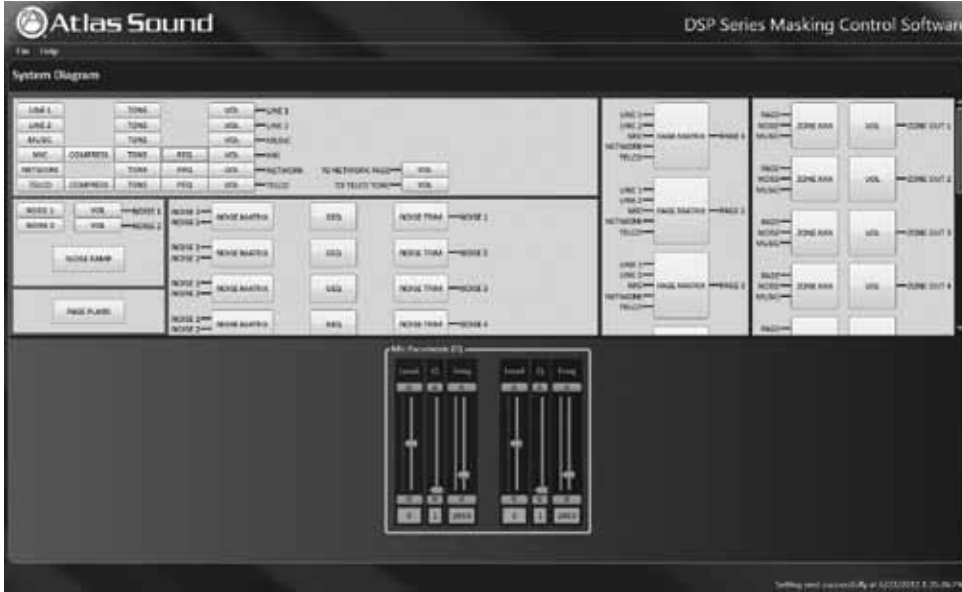

MICROPHONE INPUT: VOLUME

1. After selection MIC select 'VOL'- Music (volume) button. This will drop down a 'Mic Volume' box with a slide adjustment from -65dB to +15dB. In order to test volume you can select 'Start Meter' which provides an active meter view of music 'signal present'. When the test is complete select 'Stop Meter'.

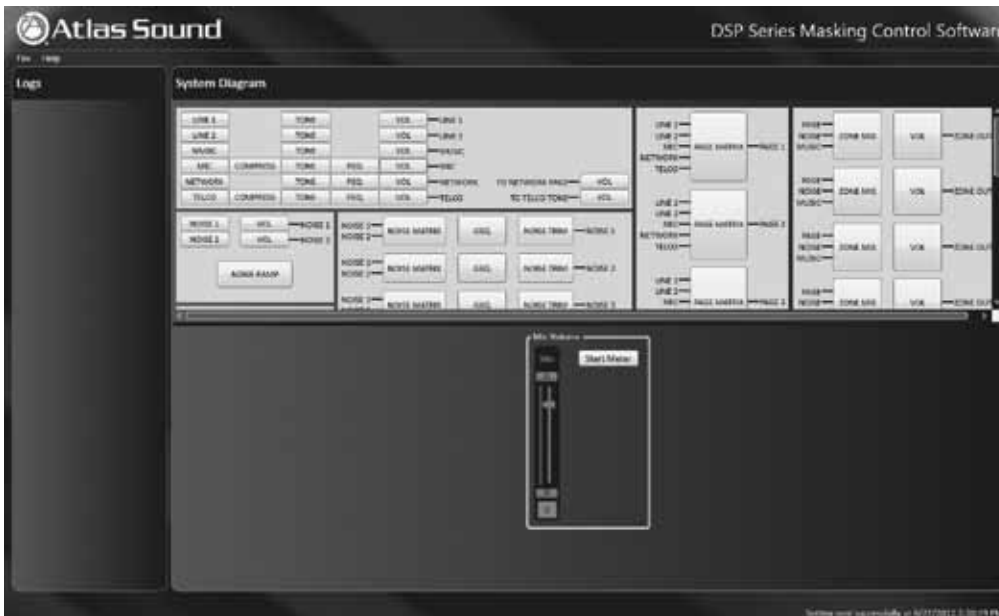



NETWORK INPUT: TONE

1. Select Network 'TONE' button. This will drop down a 'Network Tone' box with adjustment for Bass and Treble as follows: (Bass) frequency; 100Hz-1000Hz, level, -15dB to +15dB, (Treble) frequency, 1000Hz to 20,000Hz, and level, -15dB to +15dB. Move the slider, hit up/down symbol or type in the required number. NOTE: Each adjustment will light up when cursor is working in a specific area.

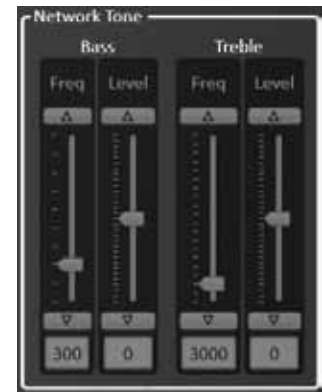
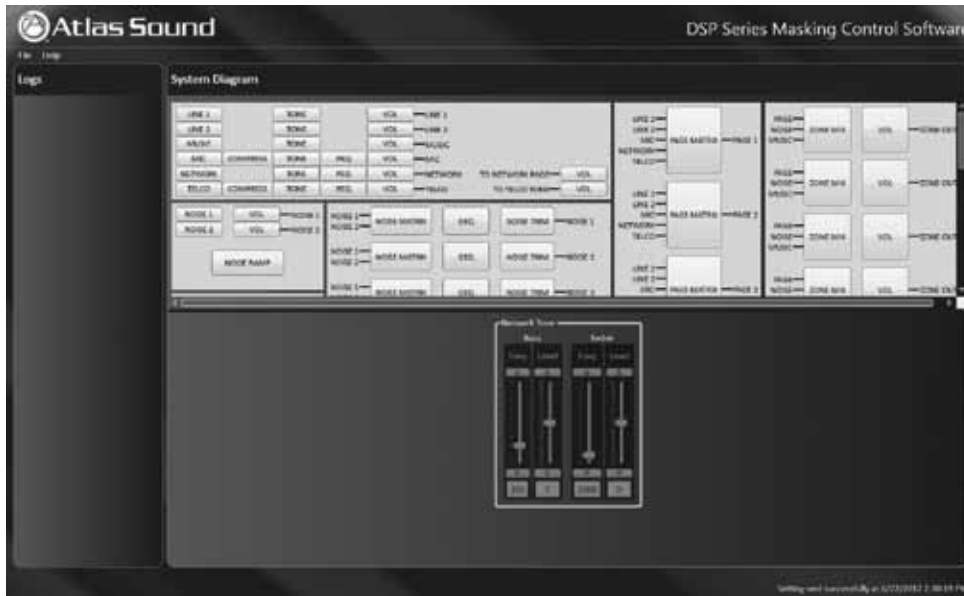

NETWORK INPUT: 'PEQ' / PARAMETRIC EQ

1. Select the MIC Parametric 'PEQ' button to adjust Level, Q and frequency. Select each function and adjust to these ranges; level is -14dB to +14dB, 'Q' is 1 to 5 and frequency is 50Hz to 16kHz.

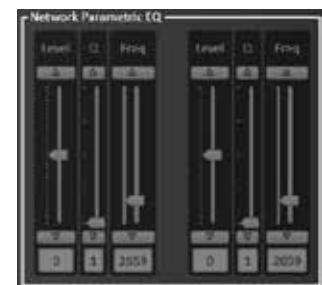
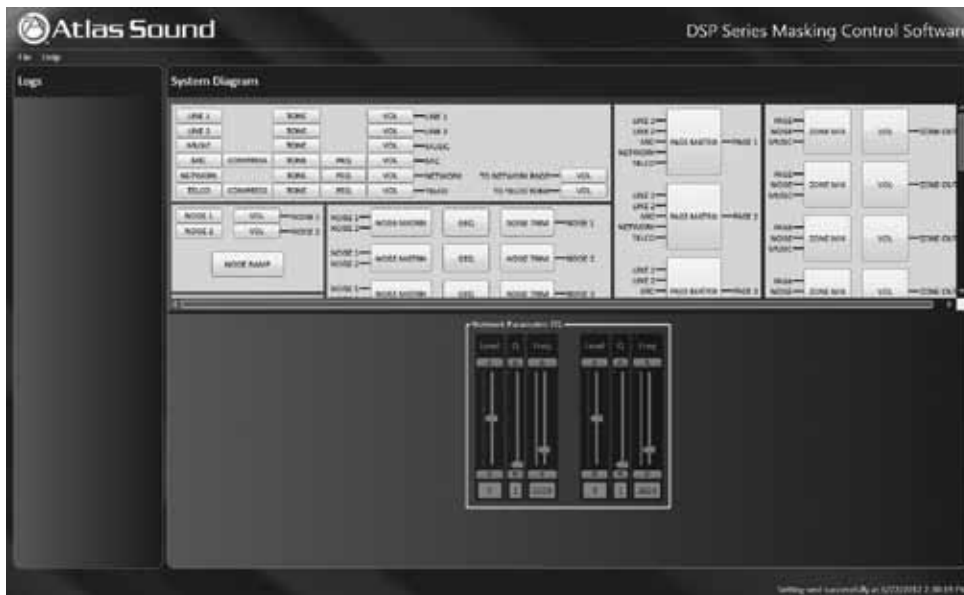

1601 Jack McKay Blvd. • Ennis, Texas 75119 U.S.A.
Telephone: 800.876.3333 • Fax: 800.765.3435



NETWORK INPUT: NETWORK VOLUME

1. After selecting NETWORK button, select 'VOL' (volume) button. This will drop down a 'Network Output Volume' box with a slide adjustment from -65dB to +15dB. In order to test volume you can select 'Start Meter' which provides a active meter view of music 'signal present'. When the test is complete select 'Stop Meter'.

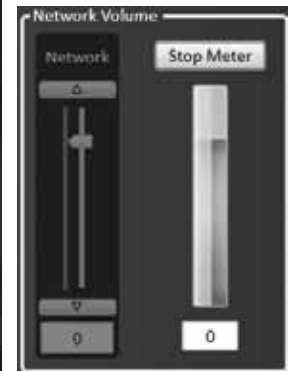
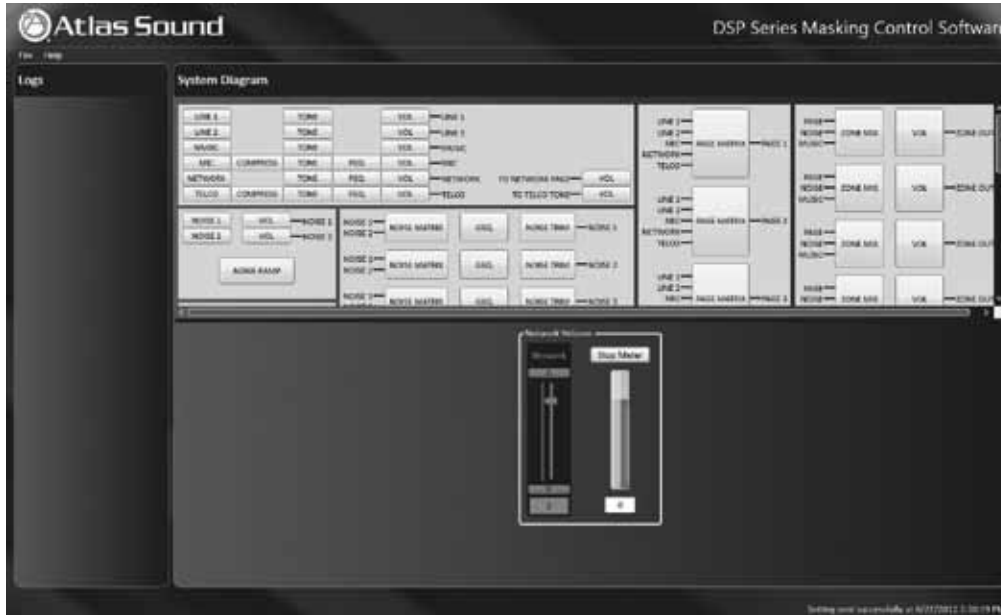

TELCO INPUT: COMPRESSOR

1. Select 'TELCO' input button (Telephone) and then 'COMPRESS' (Compressor) to activate compression of audio signal with adjustment to 'Threshold' and 'Ratio' as follows. Threshold has a range from -54dB to +6dB and Ratio is from 1-10. Move the slider, hit up / down symbol or type in the required number.

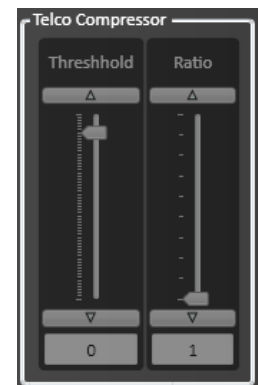
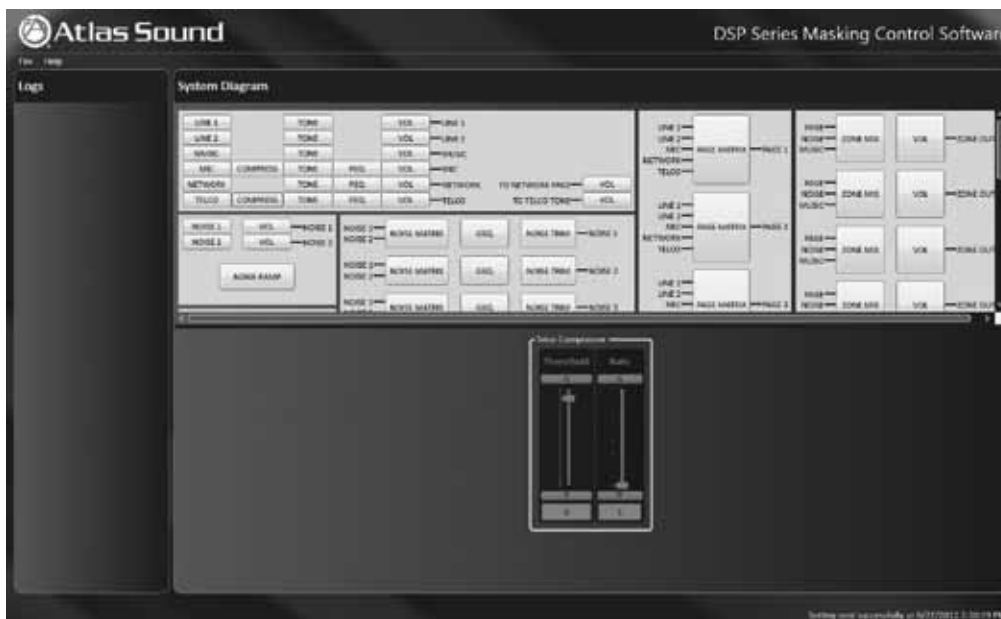

1601 Jack McKay Blvd. • Ennis, Texas 75119 U.S.A.
Telephone: 800.876.3333 • Fax: 800.765.3435



TELCO INPUT: TONE

1. Select Telco 'Tone' button. This will drop down a 'Telco Tone' box with adjustment for Bass and Treble as follows: (Base) frequency, 100Hz-1000Hz, level, -15dB to +15dB, (Treble) frequency, 1000Hz to 20,000Hz, and level, -15dB to +15dB. Move the slider, hit up/down symbol or type in the required number. NOTE: Each adjustment will light up when cursor is working in a specific area.

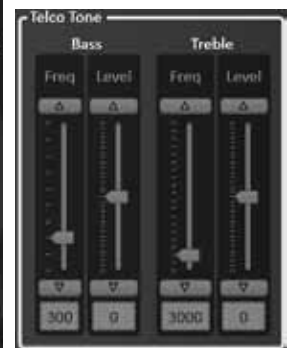
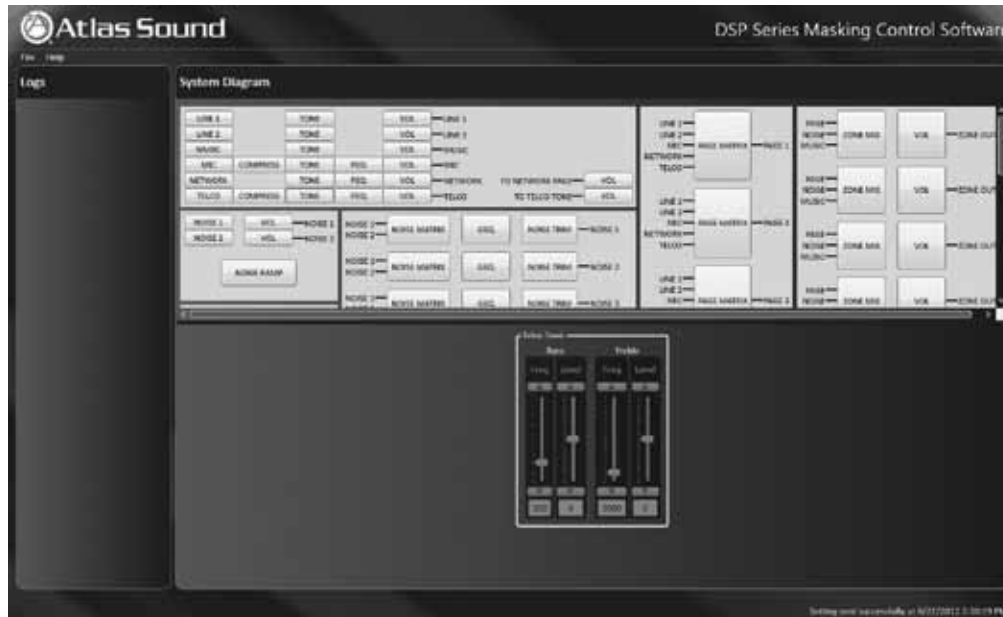

TELCO INPUT: TELCO 'PEQ' / PARAMETRIC EQ

1. Select the MIC Parametric EQ to adjust Level, Q and frequency. Select each function and adjust to these ranges, level is -14dB to +14dB, 'Q' is 1 to 5, and frequency is 50Hz to 16kHz.

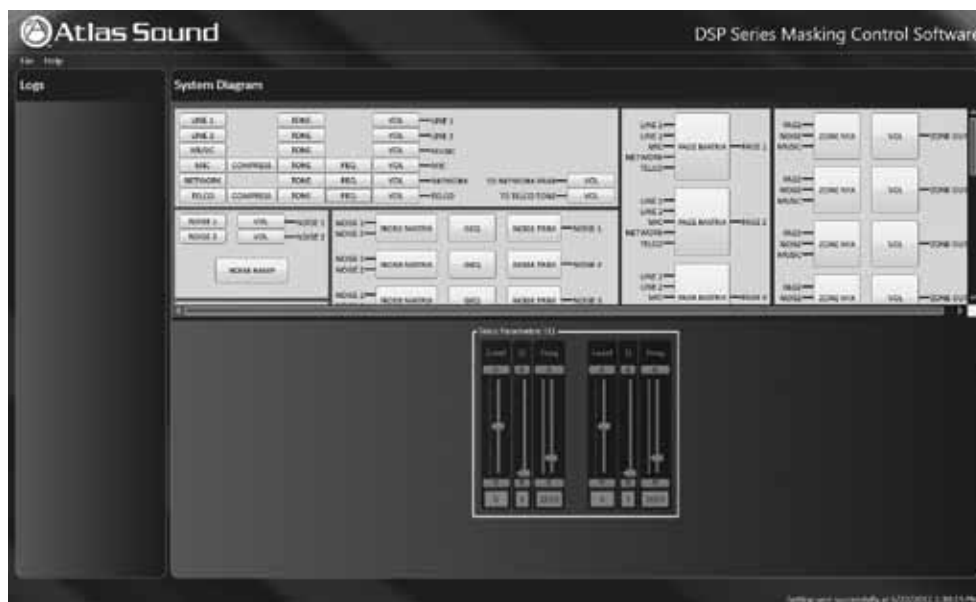

1601 Jack McKay Blvd. • Ennis, Texas 75119 U.S.A.
Telephone: 800.876.3333 • Fax: 800.765.3435



TELCO INPUT: VOLUME

1. Select TELCO 'VOL'- (volume) button. This will drop down a 'Telco Volume' box with a slide adjustment from -65dB to +15dB. Move the slider, hit up/down symbol or type in the required number. NOTE: Each adjustment will light up when cursor is working in a specific area. In order to test volume you can select 'Start Meter' which provides an active meter view of music 'signal present'. When the test is complete select 'Stop Meter'.

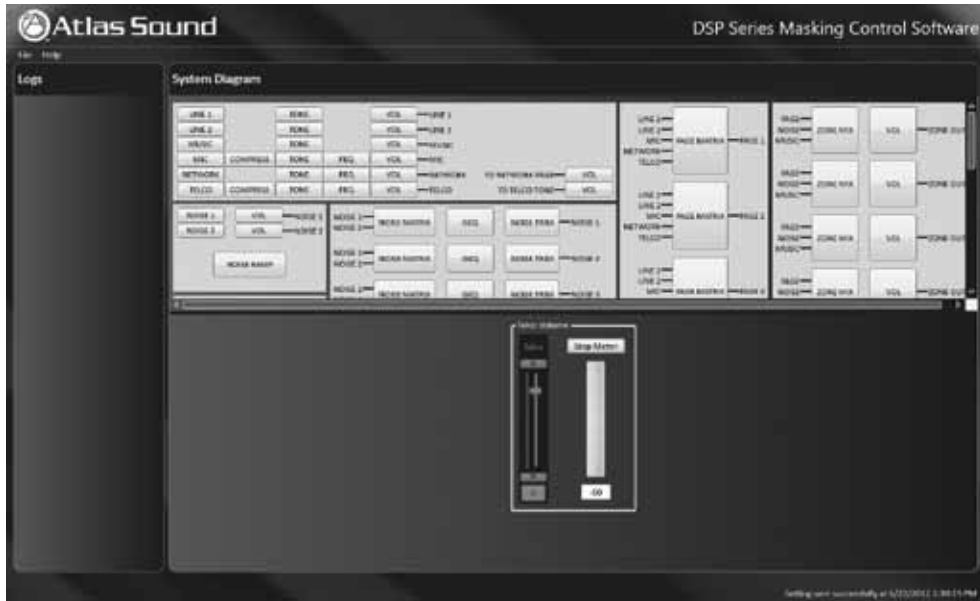

TELCO INPUT: TELCO TONE VOLUME

2. Select 'To Telco Tone'. This will drop down 'Telco Tones Volume' box which can be set from -15dB to +15dB. Move the slider, hit up/down symbol or type in the required number. In order to test the volume select 'Start Meter' this provides an active meter view of music 'signal present'. When the test is complete select 'Stop Meter'.

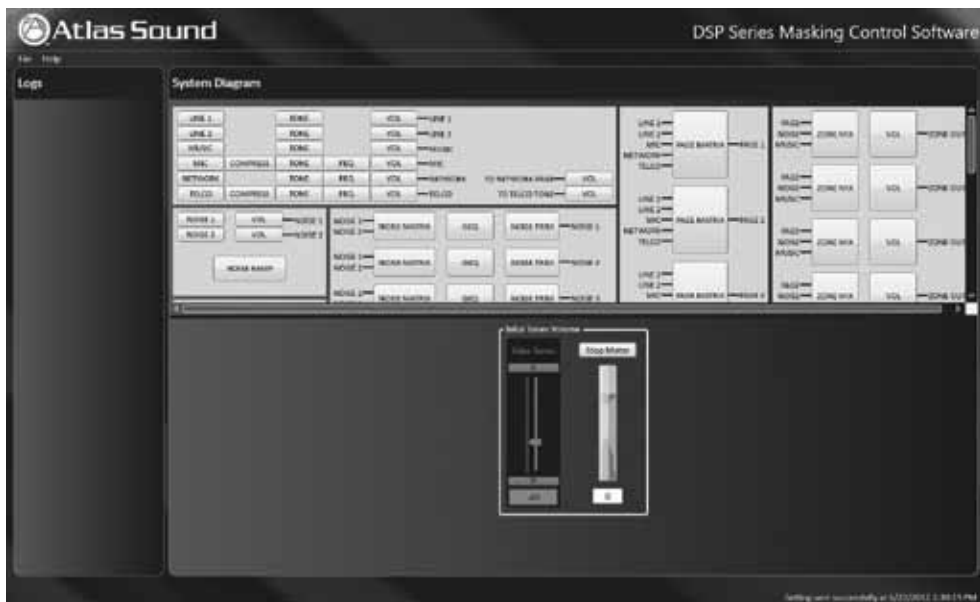

1601 Jack McKay Blvd. • Ennis, Texas 75119 U.S.A.
Telephone: 800.876.3333 • Fax: 800.765.3435



PAGE MATRIX

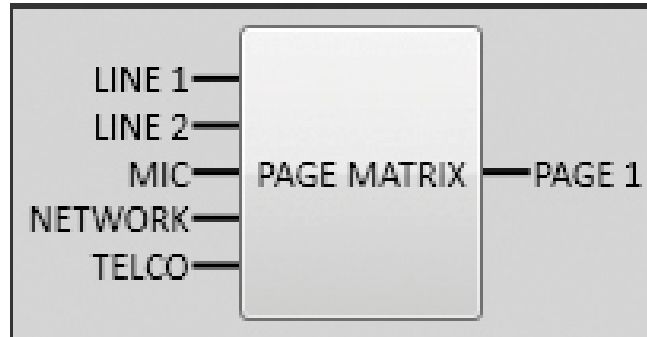

1. Select 'PAGE MATRIX' button to manually route an input page signal to its associated zone output (1-8). This can be used to check sound level and quality of the various page input sources (Telco, Mic, Line, Network) without having to create a page plan or execution of that plan. Select the 'Page Matrix' button and the desired page input source, then select the 'Zone Mix' button to set the input levels for each zone in the test. When desired levels are set, select the 'DSP Run Mode' button which enables system processors to automatically set levels when page is made.

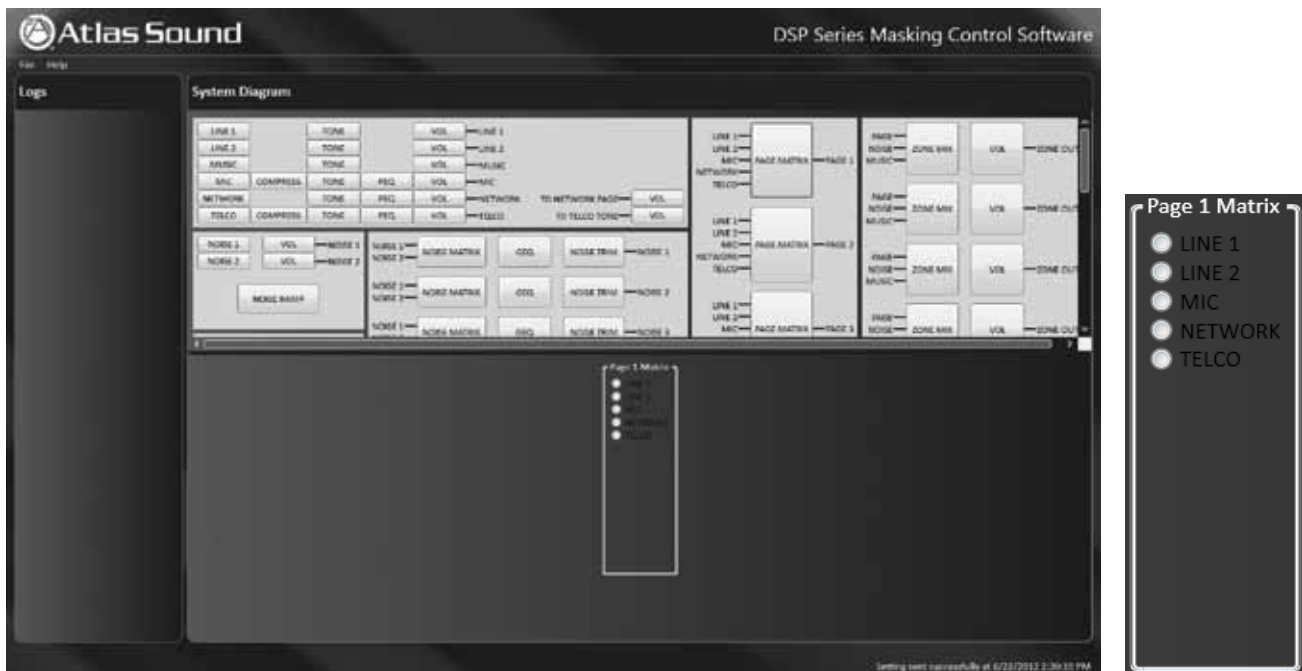

1601 Jack McKay Blvd. • Ennis, Texas 75119 U.S.A.
Telephone: 800.876.3333 • Fax: 800.765.3435



ZONE MIX AND VOLUME



ZONE MIX:

1. Select 'ZONE MIX' button to adjust relative levels for Page, Noise, Music from -65dB to +15dB. Repeat for all zone outputs Zone 1 to 8.

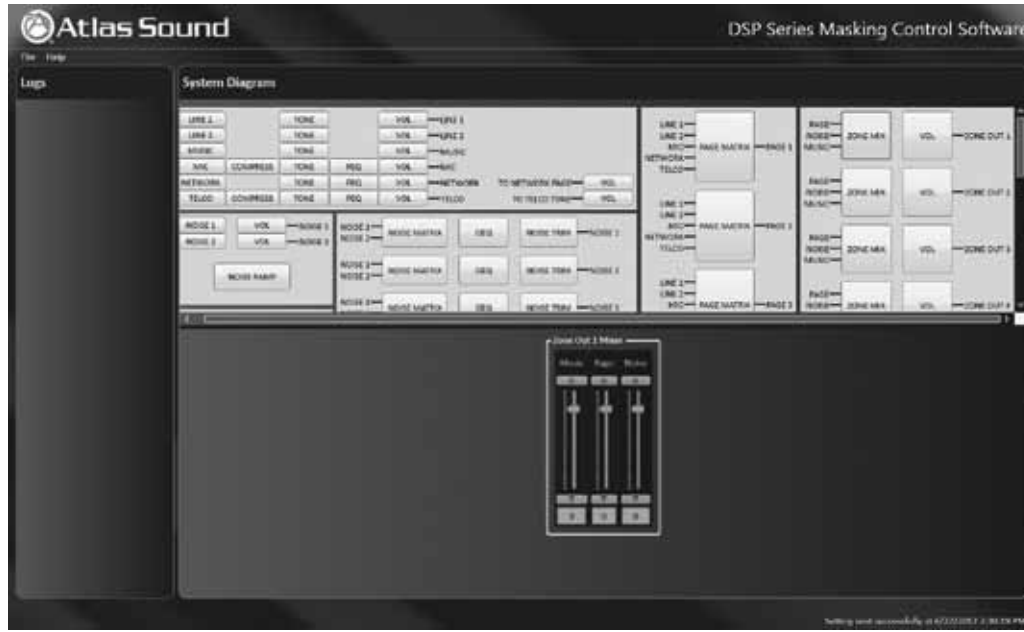

ZONE VOLUME:

1. Select 'VOL' (volume) button for 'Zone Out 1' (to Zone Out 8) which drops down a 'Zone Out 1 Volume' box with a slide adjustment from -65dB to +15dB.

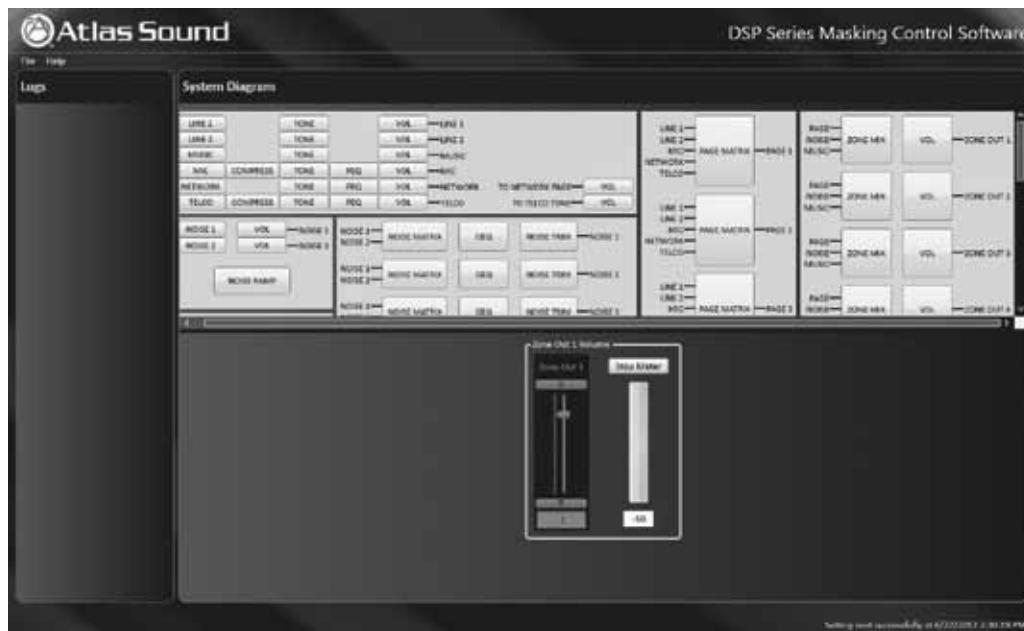

1601 Jack McKay Blvd. • Ennis, Texas 75119 U.S.A. Telephone: 800.876.3333 • Fax: 800.765.3435



PAGE PLANS

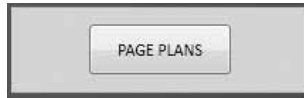

1. In setting up the DSP8807 'Page Plan' select the 'PAGE PLANS' button. This will drop down the 'Page Plans' box. Select which 'Local Zones' 1 through 8 (specific to each DSP8807 unit being programmed) are to receive Telco, Mic/Line 1, or Line 2 source inputs to be broadcast into these zones. Repeat this step relative to the 'Network Zones' to be sent these broadcast pages or sources. The Telco 'Page Plan' zones are 2-digit DTMF codes ranging from '00' to '99'. The 'Page Plan' consists of 100 Telco dial plans from 00 to 99 and one (1) for Line1 and Line2 and Microphone. NOTE: The switch 'dry' contact closures or the rear panel are used to select the Line 1, Line 2 and Mic page plans.

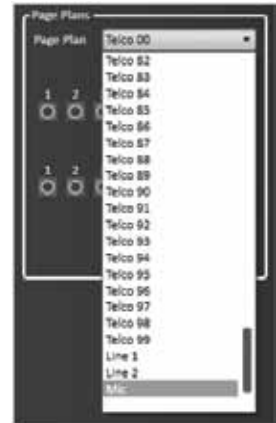
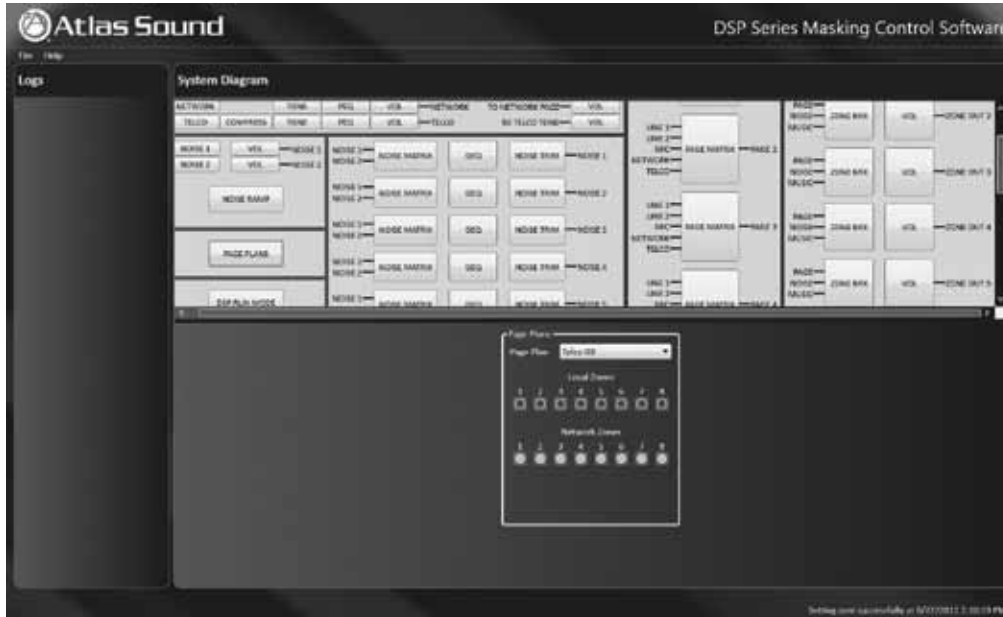

2. Each Page Plan has 'Local' and 'Network' zones. Page input sources will route to those which are selected.

For multiple DSP8807 units; when any unit, executes a page it will broadcast to all other units connected on the network. The 'Network Zone' button within the 'Page Plan' when selected will route the page output to the selected 'Network Zone' outputs

EXAMPLE: There are two units networked together, one on each floor of an office building with (8) zones per floor. There is a requirement for an 'All Page' to (16) zones from the 'Mic' input. To do this you set the 'Mic Page' plan to output to all local zones and all network zones.



1601 Jack McKay Blvd. • Ennis, Texas 75119 U.S.A.
Telephone: 800.876.3333 • Fax: 800.765.3435



DSP RUN MODE

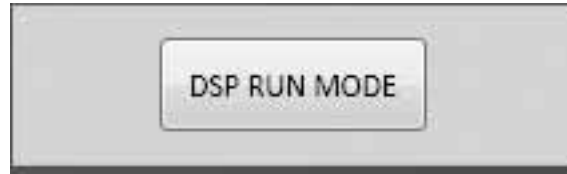

1. Select 'DSP RUN MODE' when you need to reset and test all DSP processors.

MONITOR AMBIENT MICS (MICROPHONES / ALM-1)



1. When ALM-1 remote ambient microphones are connected to the DSP8807, the 'MONITOR AMBIENT MICS' button can be selected to view status of microphone operation as a 'signal present' voltage (milliamps) to indicate DSP8807 is receiving input signal. There are two independent meters: Left meter reads every (2) seconds averaged over one (1) minute the Right meter is the real time dB level based on settings made in the 'Noise Trim' option.

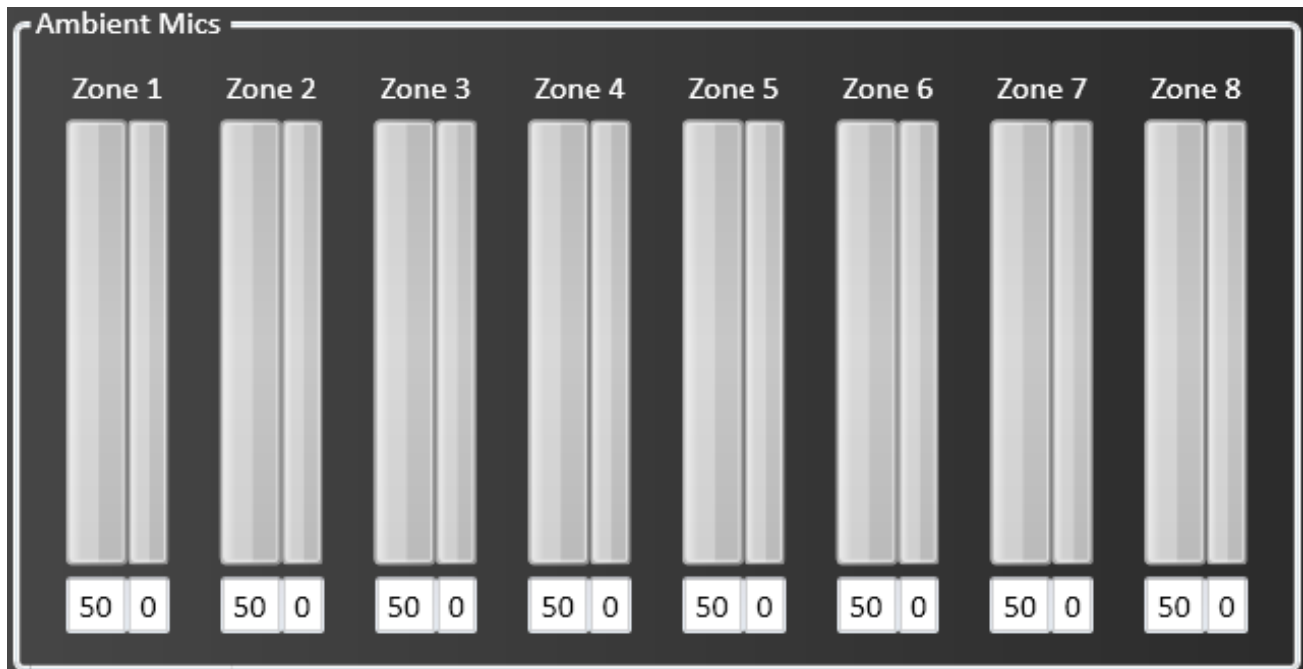



SPECIFICATIONS

SYSTEM PERFORMANCE / DSP PROCESSORS

Dynamic Range	>102dB A-Weighted
Frequency Response	80Hz – 20kHz ± 3dB at Rated Output
Distortion THD+N	.001% Typical at +4dBu, 1kHz, 0dB Gain
Input Sensitivity	≤ 1.0% at 1kHz at Rated Output
Interchannel Crosstalk	> 80dB Typical
Crosstalk Input to Output	> 80dB
Channel Separation	> 100dB at 1kHz (In Thru Out)
Common Mode Rejection Ration (CMRR)	> 50dB, 80Hz – 20kHz Typical > 55dB at 1kHz
Processor Capacity	264 MIPS, 528MFLOPS, Continuous Operation
Sample Rate Audio Conversion	48kHz
D/A Converter Type (Audio)	24-bit Sigma Delta
D/A Performance Dynamic Range (Converter)	> 100dB A-Weighted
A/D Performance Dynamic Range	> 110dB A-Weighted
Non-Volatile Memory	Memory Storage for All Programs and Set Up Protected for (24) Hours in Power Brown Out, Interruption or Computer Shut Down. Data Settings Good for (10) Years W/O Refresh
DSP Manual Restart	Front Restart Manual Button to Reload DSP's
CODEC – DSP Protection	All I/O Protected with Buffers from Spikes and Transients or Sneak Currents

SYSTEM INPUTS (unless noted located on rear panel)

Power AC Mains	IEC 3-pin with Ground, 100-240VAC, 50-60HZ with ON/OFF Manual Switch with Replaceable Fuse
Network – Data	RJ45 Module Jack (EIA 568B)
Telco Loop Start	2-pin Dockable Keyed Connector
Input Transformer	600Ω
Ring Voltage	105V – 14V (POTS – VoIP)
DTMF Dial Plan	Single, Group or All Page
Microphone	3-pin Dockable Keyed Connector
Background Music	RCA Connector 10K Ohm (Sum to Mono)
Master Override	2-pin Dockable Keyed Connector (1V – 70V nominal)
Emergency Audio Off (EAO)	2-pin Dockable Keyed Connector, 'NO' Normally Open Contact Closure
Ambient Sensing Microphones (x8)	RJ45 Modular Jack (EIA 568B) No Polarity



1601 Jack McKay Blvd. • Ennis, Texas 75119 U.S.A.
Telephone: 800.876.3333 • Fax: 800.765.3435



SYSTEM OUTPUTS (unless noted located on rear panel)

Speakers (x8)	2-pin Dockable Keyed Connector (70v at 50WRMS)
Audio Line Level (x8)	3-pin Dockable Keyed Connector (1v Nominal)
Microphone Frequency Level	80Hz – 18kHz
Music	80Hz – 20kHz
Line Out	80Hz – 18kHz
Telco	250Hz – 4kHz
Network System Link	RJ45 Modular Jack (EIA 568B)
Ancillary Line Out (x2)	2-pin Dockable Keyed Connector, Contact Closure

SYSTEM AMPLIFIERS (x8)

Frequency Response	80Hz – 20kHz, ± .25dB
Total Distortion	.001% typical at +4dB, 1kHz, 0dB Gain
Transformer Output	70,7V and IV Line Level
Efficiency	85% or Better
Gain Control	Adjustable to 34dB
Power Supply	UL / CUL /CE Recognized
Input Impedance	50kΩ
Output Impedance	8Ω
Carrier Frequency	400kHz
Peak Current	1.2A
MTBF (Mean Time Between Failure)	100,000 Hours
EMC / EMI Radiation	FCC Part 15 Class B, EN6100, CISPR 22

SYSTEM MECHANICAL DATA

Dimensions (L x W x H)	14.0" (358mm) x 19.0" (482.6mm) x 3.5" (88.9mm)
Material (Outer Housing)	CRS (Cold Roll Steel) 18AWG (.047" Nominal)
Finish	Flat Black Powder Coat with Zinc Undercoat Corrosion Resistant
Printed Circuit Boards	UL recognized UL94VO
Electronic Components	RoHS
Operating Temperature	0° to +50°C
Storage Temperature	-40° to + 85°C
Humidity	95% Non-Condensing (Max.)



**TROUBLESHOOTING GUIDE**

1. Read and review all sections and follow instructions in this manual.
2. Before terminating speakers to 'Speaker Output (70V)' Zone 1 to 8, verify that all wiring is free from shorts, opens, crosses, ground problems or loose or frayed wiring. Ensure wiring follows the correct polarity (+ / -).
3. Ensure AC power is correctly terminated with the IEC power cord provided. If after power is activated and system input and output terminations are verified and no audio is detected, ensure all volume and activation settings have been properly set and applied in the operating GUI/Sound Media Interface per instructions. Ensure that all speakers are connected to the DSP8807.
4. If you continue to experience difficulty please contact Atlas Sound Customer Service department by telephone at 1-800-876-333, online at www.AtlasSound.com, or by email at atascuster@atlassound.com.



1601 Jack McKay Blvd. • Ennis, Texas 75119 U.S.A.
Telephone: 800.876.3333 • Fax: 800.765.3435



DSP8807

**Digital Processor
and Amplifier**

Owner's Manual

Limited Warranty

All products manufactured by Atlas Sound are warranted to the original dealer/installer, industrial or commercial purchaser to be free from defects in material and workmanship and to be in compliance with our published specifications, if any. This warranty shall extend from the date of purchase for a period of three years on all Atlas Sound products, including SOUNDOLIER brand, and ATLAS SOUND brand products except as follows: one year on electronics and control systems; one year on replacement parts; and one year on Musician Series stands and related accessories. Additionally, fuses and lamps carry no warranty. Atlas Sound will solely at its discretion, replace at no charge or repair free of charge defective parts or products when the product has been applied and used in accordance with our published operation and installation instructions. We will not be responsible for defects caused by improper storage, misuse (including failure to provide reasonable and necessary maintenance), accident, abnormal atmospheres, water immersion, lightning discharge, or malfunctions when products have been modified or operated in excess of rated power, altered, serviced or installed in other than a workman like manner. The original sales invoice should be retained as evidence of purchase under the terms of this warranty. All warranty returns must comply with our returns policy set forth below. When products returned to Atlas Sound do not qualify for repair or replacement under our warranty, repairs may be performed at prevailing costs for material and labor unless there is included with the returned product(s) a written request for an estimate of repair costs before any nonwarranty work is performed. In the event of replacement or upon completion of repairs, return shipment will be made with the transportation charges collect.

EXCEPT TO THE EXTENT THAT APPLICABLE LAW PREVENTS THE LIMITATION OF CONSEQUENTIAL DAMAGES FOR PERSONAL INJURY, ATLAS SOUND SHALL NOT BE LIABLE IN TORT OR CONTRACT FOR ANY DIRECT, CONSEQUENTIAL OR INCIDENTAL LOSS OR DAMAGE ARISING OUT OF THE INSTALLATION, USE OR INABILITY TO USE THE PRODUCTS. THE ABOVE WARRANTY IS IN LIEU OF ALL OTHER WARRANTIES INCLUDING BUT NOT LIMITED TO WARRANTIES OF MERCHANTABILITY AND FITNESS FOR A PARTICULAR PURPOSE.

Atlas Sound does not assume, or does it authorize any other person to assume or extend on its behalf, any other warranty, obligation, or liability. This warranty gives you specific legal rights and you may have other rights which vary from state to state.



Should your DSP8807 require service, please contact the Atlas Sound warranty department at 1-608-325-8717, to obtain an RA number.

Atlas Sound Tech Support can be reached at 1-800-876-3333.

Visit our website at www.AtlasSound.com to see other Atlas products.

©2012 Atlas Sound L.P. All rights reserved. Atlas Sound and Atlas Learn are trademarks of Atlas Sound L.P.
All other trademarks are the property of their respective owners. ATS004274 RevA 3/12



1601 Jack McKay Blvd. • Ennis, Texas 75119 U.S.A.
Telephone: 800.876.3333 • Fax: 800.765.3435