

How to use your ASKO dishwasher with Sani Cycles

1653

Important!

Read all the operating instructions before starting to use your dishwasher, to get the best results.

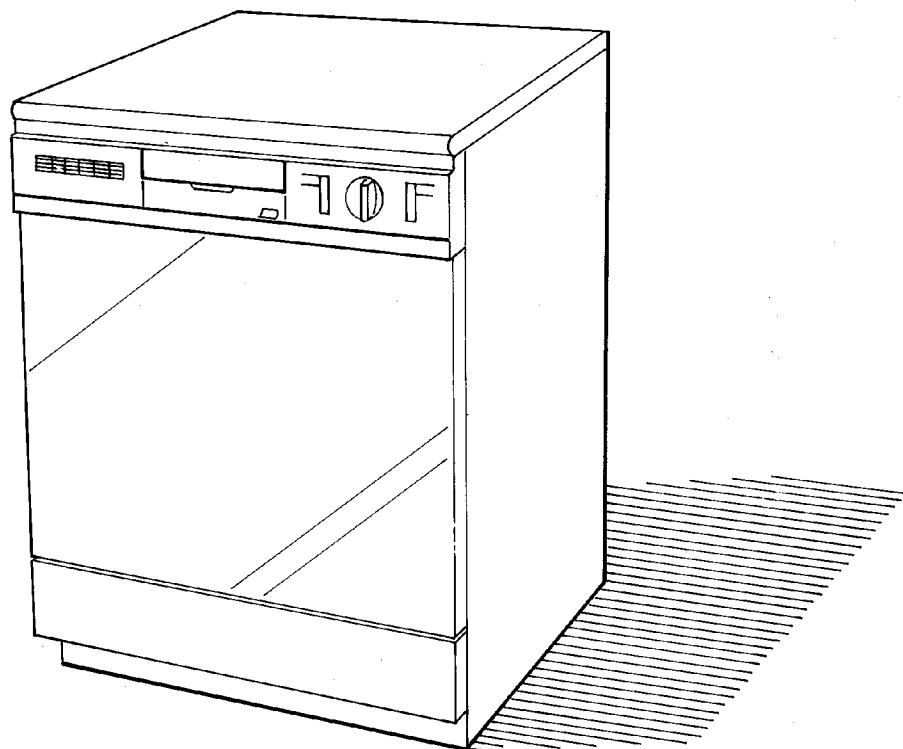

Contents

Important Safety Instructions	2
Parts and Features	3
What can be washed	5
Preparing Dishes	6
Loading Dishes and Flatware	6
Water Temperature	8
Dishwasher Detergents	8
Rinse Aids and Dispenser	9
How to Operate Model 1653	10
Energy Saving Tips	11
Safety	12
Front Panel Installation	12
Maintenance	13
Troubleshooting	14
Poor Results and Remedies	15
Warranty and Service Information	19
Review	20

Before using the machine for the first time:

Read this entire manual carefully. Keep it handy to answer any questions you have in the future. Not all dishes and flatware are "dishwasher safe", see chart on page 5 (What can be washed in the dishwasher?) Only special dishwasher detergents must be used in the dishwasher.

Important Safety Instructions

WARNING: When using your dishwasher, follow basic precautions, including the following:

1. Read all instructions before using the dishwasher.
2. This dishwasher must be properly grounded: see installation instructions for details.
3. Use the dishwasher only for its intended function.
4. Use only detergents or rinse aids recommended for use in a dishwasher, and keep them out of reach for children.
5. When loading items to be washed:
 - a. Locate sharp items, so that they are not likely to damage the door seal.
 - b. Load sharp knives with the sharp points down to reduce risk of cut-type injuries.
6. Do not wash plastic items unless marked "dishwasher safe": or the equivalent. For plastic items not so marked, check the manufacturer's recommendations.
7. Do not touch the heating element during or immediately after use.
8. Do not operate your dishwasher unless all enclosure panels are properly in place.
9. Do not tamper with controls.
10. Do not abuse, sit on or stand on the door or dish rack of the dishwasher.
11. To reduce the risk of injury, do not allow children to play in or on a dishwasher.
12. Under certain conditions, hydrogen gas may be produced in a hot water system that has not been used for two weeks or more. Hydrogen gas is explosive. If the hot water system has not been used for such a period, turn on all hot water faucets and let the water flow from each for several minutes. This will release any accumulated hydrogen gas. Since the gas is flammable, do not smoke or use an open flame during this process.
13. Remove the door to the washing compartment when removing an old dishwasher from service or discarding it.

More about SAFETY on page 12

Save These Instructions

Specifications

Height	32 1/4"–34 1/4" (850–870 mm)
Width	23 1/2" (595 mm)
Depth	22 7/16" (570 mm)
Weight	103.4 lbs (47 kg)
Capacity	12 international place settings
Water pressure	18–176 PSI
Power	120 Volts, 60 Hz, 20 Amps
Element power	1800 Watts
Max loading	2050 Watts

Water consumption:

Heavy wash	6.6 gal (25 liters)
Normal wash	5.3 gal (20 liters)
Light wash	3.9 gal (15 liters)

Cabinet opening:

Height	32 1/2"–35" (825–890 mm)
Width	23 5/8"–24" (600–608 mm)
Depth	22 7/16" (570 mm)

Parts and Features

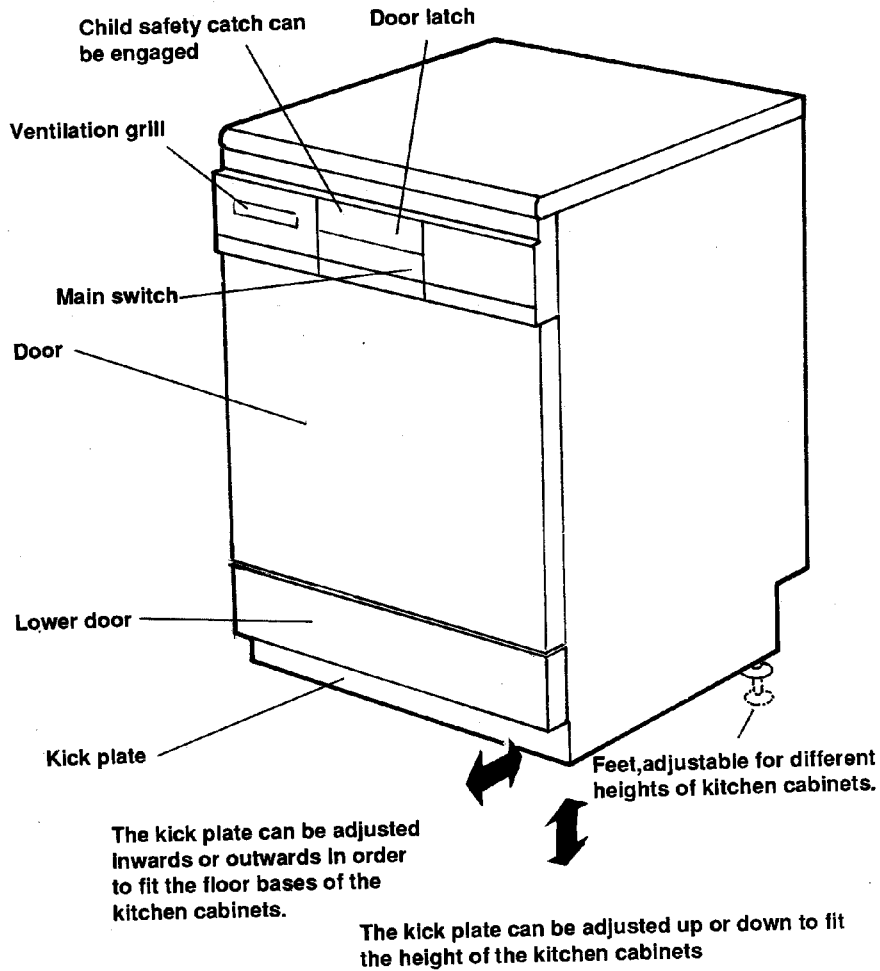

To open the door

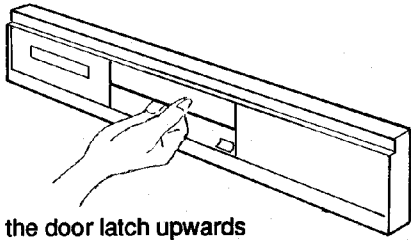

Push the door latch upwards

If the child catch has been engaged:

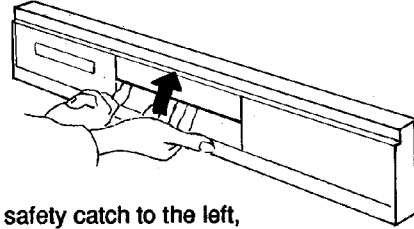

Move the safety catch to the left, and push the door latch upwards. For more information on the child safety catch, see "safety" page 12.

Program panel

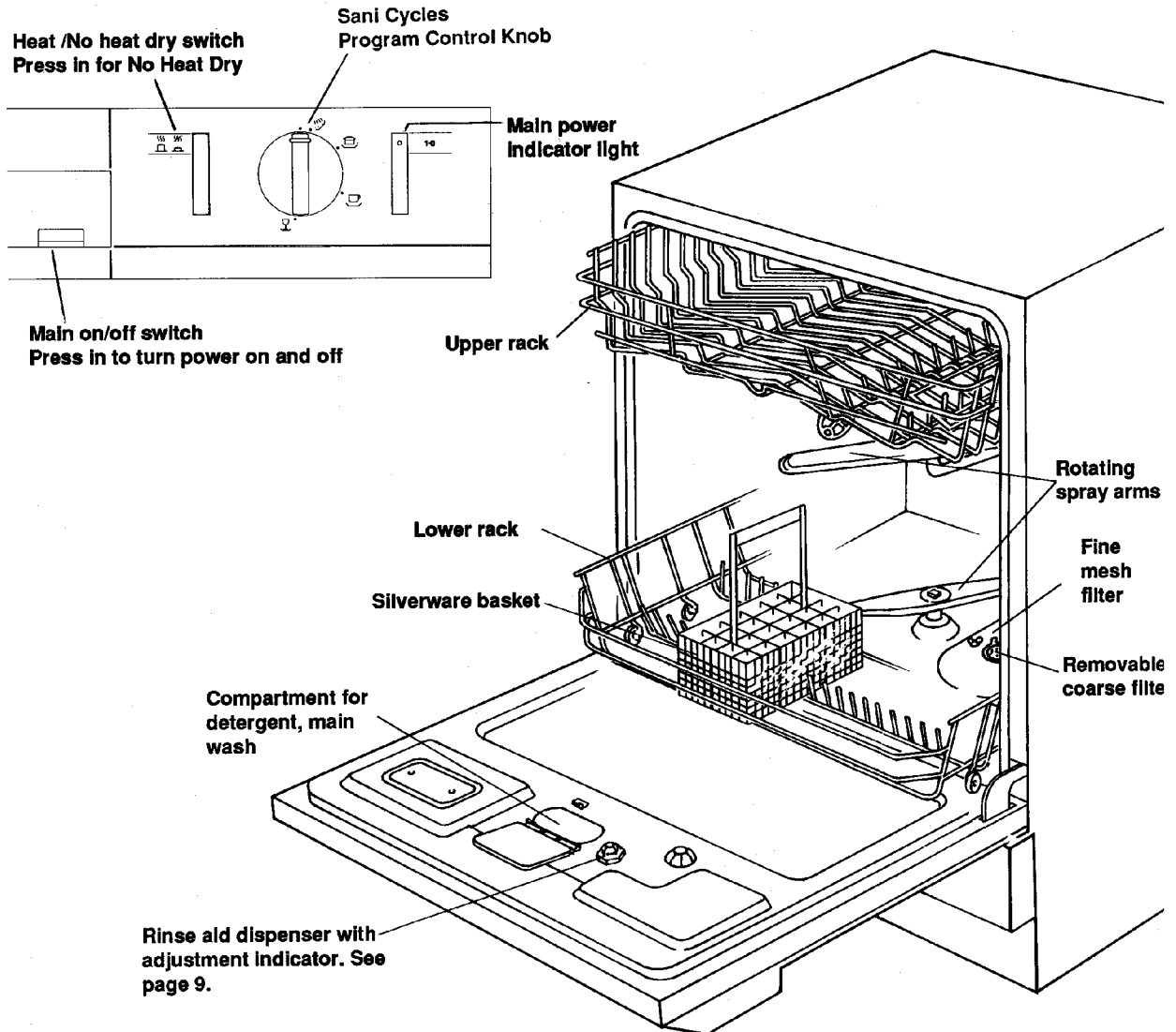

What can be washed in the dishwasher?

Most household goods such as plates, saucepans and flatware can be machine washed. If you are unsure, check with the manufacturer or, if this is not possible, wash one item of a set over an extended period and then compare it with the rest of the set.

The user is responsible for what he or she washes in the dishwasher.

Material	Dishwasher safe?	Information
Aluminum	Yes	Anodized aluminum may fade or darken. Patches and discoloration may appear but these can be removed with wire wool. Remember not to position aluminum utensils so that they can come in direct contact with the dishwasher detergent since this may result in black spots and small erosion holes.
Cast iron	No	The seasoning is lost and the iron rusts. Hand wash.
China Stoneware	Yes	China without decor or with decor protected by glaze is dishwasher safe. Remember however to place the objects so they are not in contact with each other, otherwise they can be damaged China with a pattern on top of the glaze, or with gold leaf decor may fade. Check with the manufacturer. If this is not possible, try with one of the items over an extended period. Then compare its colors and pattern with the rest of the set.
	No	Antiques and very delicate china should not be washed in the dishwasher.
Crystal	Yes	Place the items so that they cannot fall over or knock against each other while being washed. Certain types of lead crystal may etch if they are machine washed. Check with your supplier. Refer to china above for colored patterns or gold leaf decor. Antiques and very delicate items should not be machine washed. Use a low wash temperature.
Dirilyte	No	Gold-colored flatware can become discolored.
Glass	Yes	Milk glass may become yellowed.
Flatware with bonded handles	No	Certain types of adhesives cannot withstand machine washing and may loosen.
Pewter	No	Pewter tarnishes.
Disposable plastic item	No	Cannot withstand machine washing.
Plastic	Yes	If the item is not marked "Dishwasher safe", test one of the items before the whole set is washed. Place plastic items in the top basket. Use drying without heat.
Stainless steel	Yes	Rinse the items if they are not going to be washed immediately. Salty or acidic foods can stain if left on. Dry dishwasher detergent can also produce black marks which are difficult to remove. Do not let copper items come in contact with stainless steel. Do not mix different types of stainless steel.
Silver and silver plate	Yes	Rinse the items if they are not going to be washed immediately. Food which contains a lot of salt or acids produces marks. Dry dishwasher detergent can also produce black marks which are difficult to remove. Do not put in same silverware basket with stainless steel. Contact between the metals can damage silver. Do not wash copper utensils in the same load. Silver may get a brown film. Adhesive used to attach some hollow-handle knives can loosen.
Non-stick coatings	Yes	After washing, wipe the non-stick coating area with vegetable oil to keep it from losing its non-stick quality.
Tin	No	Can rust.
Wood	No	Check the manufacturer's recommendation before washing. Wood can warp, crack or lose its shape with any kind of washing.
Non-dishware items-such as electronic air cleaner filters, furnace filters, paint brush, etc.	No	Do not wash in dishwasher. Damage to dishwasher may result.
Sharp kitchen (carving) knives	No	May become dull if washed in very hot water or allowed to contact other items during the washing process. Wood handles may also warp, crack or loosen. Check manufacturer's washing instructions.

Preparing dishes for washing

It is not necessary to rinse normal food soils off the dishes before putting them in the dishwasher although larger solid particles, such as bones, seeds, skins, pits and toothpicks, should be removed.

If you are not going to run the dishwasher immediately after loading it, it is best to first rinse salty and highly acidic foods off stainless steel, silver and silver plate flatware. Prolonged contact of foods, including lemon juice, salt, vinegar, mustard, mayonnaise and salad dressings, with stainless steel can cause corrosion (pitting).

If dishes have baked-on or burned-on foods, they may need to be soaked in a solution of one tablespoon dishwasher detergent per quart of hot water. (Do not soak silver items. It will cause black spots on silver.)

Loading the dishwasher

The top rack*

The top rack is best for glasses, cups, bowls, small plates and saucers. To provide the best results, load all items so that the force of the water and detergent reaches soiled surfaces.

Arrange stemware between prongs so that it cannot move easily. Do not let china, crystal and other delicate items touch each other during dishwasher operation. The top rack is also best for dishwasher safe plastics. Make sure small plastic items are held firmly in place. Small bowls, pans and other utensils can also be placed in the top rack. Make sure the movement of the spray arm is not blocked by items hanging below the rack. Long utensils may also be placed in the upper rack. Make sure knives do not touch other items or they may become dull. Also, make sure the sharp edges do not damage the graphite nylon coating of the rack.

With the shelf in a fold down position cups can be placed on it as well as under it. There is space for full glasses with the shelf in the raised position.

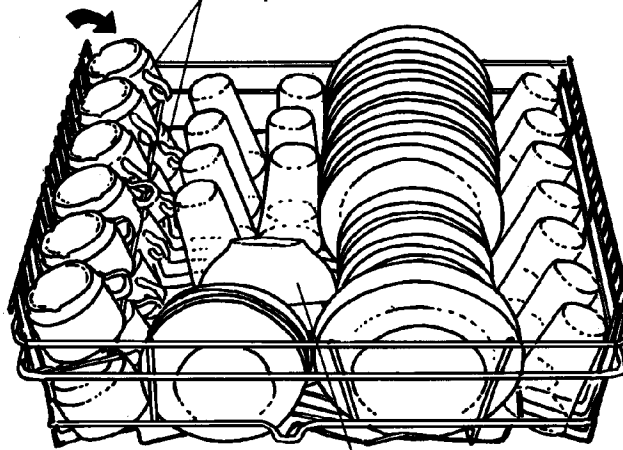

All soiled surfaces must be facing downwards and in towards the center.

The bottom rack*

Place dinner plates, smaller plates, serving plates, larger bowls and pans in the lower rack. The lower spray arm sprays up with a more powerful pressure to clean more heavily soiled items.

Make sure pot handles and other items do not stop rotation of either spray arm by hanging below the rack or by sticking up too far. Securely place heavily soiled cookware facedown in the rack.

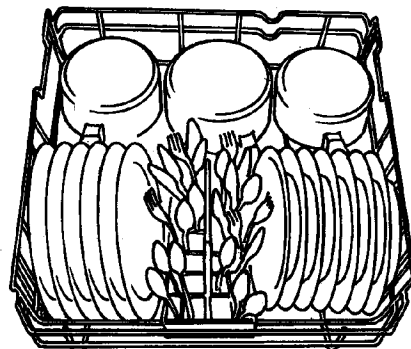

The silverware basket*

Arrange flatware in the silverware basket with handles down. Sharp or pointed items, such as knives, should be put in with the point down to protect your hands. Distribute items evenly and mix knives, forks and spoons so that items won't nest together. Take out anything, such as long meat knives or skewers that might fall or extend through the bottom of the basket. Do not put sterling silver or silver-plate flatware in the same compartment with stainless steel. Contact between the metals can damage silver. It is also not advisable to place stainless steel of different qualities close to each other. Load sharp knives so that they are not likely to damage the door seal.

* Also see pages 5, 15–18 ("What can be washed in the dishwasher?" and "Poor dishwashing results?")

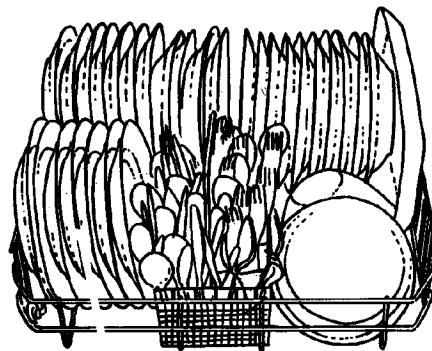

Extra quiet operation hints

Your dishwasher has been designed and engineered to not only give superior cleaning results, but also to operate extremely quietly. To avoid any extra clattering or thumping noises during operation:

- Keep sink drain plugs inserted during dishwasher operation to prevent noise transfer through drains.
- Load dishes so they do not touch another.
- Make sure light weight items are secured in the rack.
- Make sure pot lids and handles, pizza pans, cookie sheets, etc., do not touch interior walls or interfere with either of the spray arms' rotation.

The importance of hot water

Hot water dissolves and activates dishwashing detergent, dissolves grease on dishes and helps glasses dry spot-free. Your dishwasher has a 1400 watt heating element to heat the water to the designated settings of HI (150 degrees) and LO (130 degrees).

To obtain proper washing results, a varying temperature of the water is necessary. Extremely hot water is good for normal to heavily soiled dishes, pots and pans. Washing lightly soiled items, such as glasses and pre-rinsed dishes. It requires a lower water temperature to do an adequate job. Since extremely high temperatures can damage fine china or delicate crystal, use the lower temperature settings for these items.

If the incoming water is extremely cold, due to unusually cold temperatures outside, if you've recently done laundry or run hot water for showers, or if your water travels a long distance from the water heater to the dishwasher, the running time of the dishwasher may be longer to allow for a heating-up period for the water.

Checking the wash temperature

To get the best possible result, the water should be warm enough. It does not matter if the temperature of the incoming water is low since the machine has an element which heats the water to the required temperature.

You can, however, check that the temperature of the incoming water is not too high as follows:

1. Turn on the water faucet to the highest temperature possible and let the water run into the sink.
2. Place a dish or other object in the sink and let the water fill it and run over for at least a minute.
3. Measure the temperature with a meat thermometer or similar device. The temperature should not be higher than 140°F (60°C).
4. If the temperature is too high, adjust the setting on the hot water heater.

Dishwasher detergents

Use only dishwasher detergents

Use only a detergent designed for an automatic dishwasher. Never use soap, laundry detergent or hand washing detergent in your dishwasher, as they are too mild and will cause severe over sudsing and possible leaking. The foam produced prevents the machine from working properly.

How much Detergent to Use

The amount of detergent you use depends on the hardness of the water and on the cycle you select.

Hardness of water

Water has a different "hardness", or mineral content, in different locations. The hardness is measured in grains per gallon (gpg). Find out your waters' hardness by asking your local water department, county extension agent or water softening company. Ask how many "grains" of hardness are in your water.

The harder the water is, the more detergent you need. For the recommended detergent amounts to use with your water, follow the guidelines on the above chart. With hard water, you need more detergent to get dishes clean. With soft water, you need less detergent.

Too much detergent with soft water can cause "etching", a permanent cloudiness of glassware.

If you have "hard" water, the dishes as well as the machine itself may accumulate a grey deposit after some time. This deposit can be remedied by using a mild citric acid solution instead of detergent in the heavy wash program. (See also "Poor dishwashing results?" pages 19 to 22).

Warning!

**Dishwasher detergent is corrosive.
Keep out of the reach of children.**

If swallowed, drink plenty of milk or water.

Do not induce vomiting.

Seek medical advice without delay.

If dishwasher detergent gets into the eyes, rinse immediately with plenty of water.

Water hardness Grains per Gallon	Amount of detergent (Powder or Liquid)
Soft water 0-4 gpg	1 tablespoon
Med. hard water 4-8 gpg	1-2 1/2 tablespoons
Hard water 8-above gpg	2 1/2-4 tablespoons

Cycle selection

Rinse and hold

No detergent

Pots and Pans
(Heavy Wash)

Detergent on door for prewash plus detergent in compartment for main wash.

Normal Wash

Detergent on door for prewash plus detergent in compartment for main wash.

Delicate
(Light Wash)

Detergent in compartment for main wash only.

Adding the detergent

- Use no detergent for Rinse and Hold.
- Detergent should be poured loosely on the inside surface of the door for the Prewash in the Pots and Pans program and Normal Wash.
- For all other programs with a main wash, pour detergent into the detergent compartment. Close the cover when you have put in the correct amount of detergent.
- Put the detergent on the door (if necessary) and detergent compartment just before you start the dishwasher to make certain it is fresh.

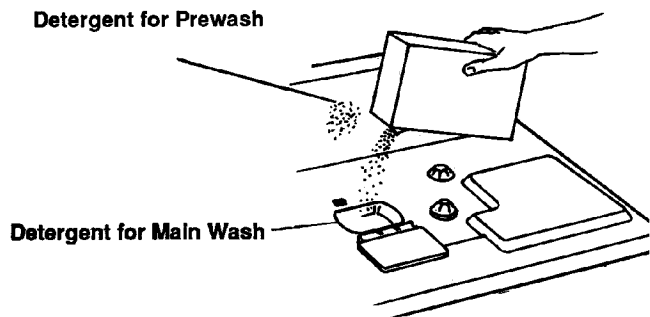

Note: Close cover after you have added the detergent

Storing the detergent

- For best results, keep your detergent container tightly closed after each use, out of reach of children, and stored in a cool, dry place. Storage under the sink is not advisable for powdered detergents, because this area is generally too warm and moist to keep detergent fresh.
- If your detergent gets old or lumpy, throw it away. Old detergent loses its strength and lumpy detergent may not dissolve.

Rinse aids

A rinse aid causes water to flow off the dishes quicker, preventing droplets that dry as spots and making the drying process faster. Rinse aids come in solid and liquid forms. Your dishwasher's rinse aid dispenser uses the liquid form. For the best results, use a liquid rinse aid only if you have moderately hard to hard water. Rinse aids used with soft water can cause a cloudy film on dishes.

Filling the rinse aid dispenser

The drying sequence is quicker if you use rinse aid. In the middle of the filler cap there is an inspection eye (see picture to the right). If the eye is completely black there is sufficient rinse aid in the container. If the eye is clear more rinse aid needs to be added. Use of rinse aid may not be necessary if you have a water softener.

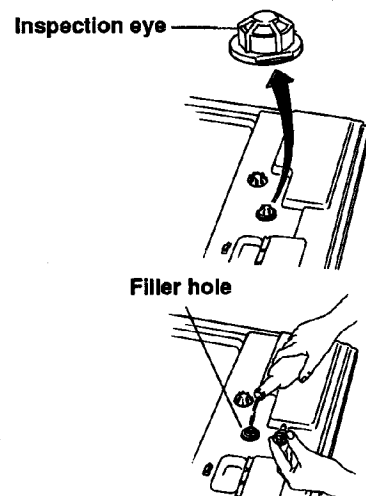

Adjusting the dosage of the rinse aid

The rinse aid dosage is set by the manufacturer and is dispensed automatically at the end of a wash program.

If necessary the rinse aid dosage can be adjusted by inserting a screwdriver inside the filler hole where the adjustment device is set on "1". However when using hard water (above 8 gpg) a rinse aid containing citric acid can be used. Under these circumstances the dosage can be increased by setting the dial to "3" or "4".

Note: Too much rinse aid is not advisable as this might result in the formation of foam, especially if the machine is connected to cold water supply.

How to use your 1653

Before Operation Review

1. Load the dishes properly.
2. Add proper amount of detergent. Close the detergent compartment cover.
3. Make sure that the rotating arms can move freely.
4. Make sure the water supply faucet is open.
5. Close the door tightly, otherwise the dishwasher will not start. Press firmly until you hear a click.

Which setting to use?

Rinse and Hold

This program provides a single, unheated rinse to be used when waiting to start a complete wash cycle. For example, it is useful in rinsing salty or highly acidic foods off stainless steel, silver and silver plate if you are not planning on running the dishwasher through a wash cycle immediately after loading such items.

Pots and Pans (Heavy Wash)

This Sani Cycle setting includes two prewashes for extra cleaning. Use it for cleaning heavily soiled items, such as pots, pans and baking dishes.

Normal Wash

Use this Sani Cycle setting, with its single prewash, for normally soiled dishes.

Delicate (Light Wash)

This Sani Cycle setting, with prewash, is used for washing lightly soiled and/or delicate items.

Heat / No Heat Dry

You may select heated or "No Heat" drying with any wash cycle. Dishes will dry more completely with heated drying, however nonheated drying is more economical. When using "No Heat Dry", the dishwasher will go through the same, entire timed drying cycle, but with no added heat.

- Turn on the power switch
- Select Heat Dry or Not Heat Dry

Heat Dry No Heat Dry

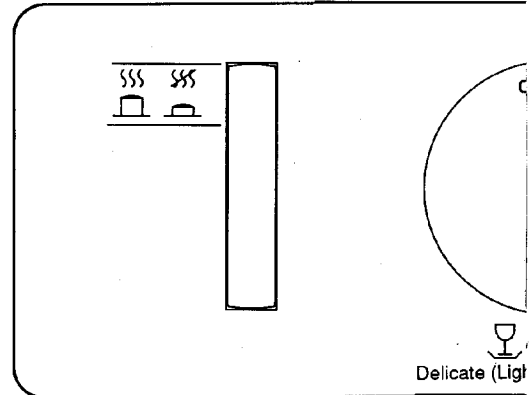

Heat / No Heat Dry Control

Sani Cycle

How the dishwasher works:

Program	Sani Cycle Symbol	Prewash
Rinse and Hold		<input type="checkbox"/>
Pots and Pans (Heavy Wash)		<input type="checkbox"/>
Normal Wash		<input type="checkbox"/>
Delicate (Light Wash)		<input type="checkbox"/>

= Working cycle without heat



Sanitizing effects of Asko Model 1653 with Sani Cycles

Model 1653 Asko dishwasher has been designed to maintain a minimum water temperature and time duration for single tank, stationary rack, single temperature, door type machines. Temperature and time of the 1653 is designed to meet sanitization requirements which specify a minimum of the following.

Water temperature

The 1800 Watt water heating element is controlled by a 170°F (74°C) thermostat in both the main wash and final rinse portions of the wash cycles. This insures that the wash and rinse temperatures exceed a minimum of 165°F.

- Turn the control knob to either **Rinse and Hold** or one of the wash settings. The dishwasher will start.

Main Power Indicator Light

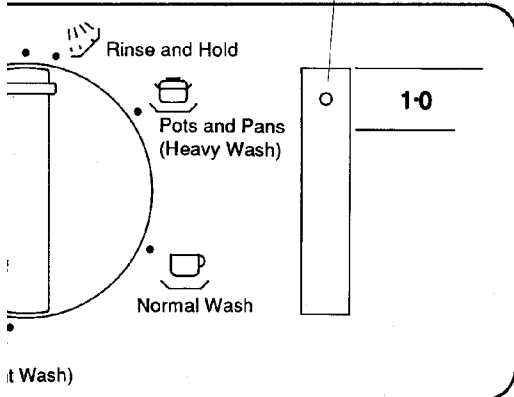

Program Control Knob

sh	Main Wash	Rinses	Drying
<input type="checkbox"/>	<input checked="" type="checkbox"/>	<input type="checkbox"/> <input checked="" type="checkbox"/>	<input checked="" type="checkbox"/>
<input type="checkbox"/>	<input checked="" type="checkbox"/>	<input type="checkbox"/> <input checked="" type="checkbox"/>	<input checked="" type="checkbox"/>
<input type="checkbox"/>	<input checked="" type="checkbox"/>	<input type="checkbox"/> <input checked="" type="checkbox"/>	<input checked="" type="checkbox"/>

Water is heated to 170°F (74°C) = You select Heat or No Heat Dry

Want to change your mind?

If you want to change a program after you have started the machine, select a new program by turning the program control.

If you want to stop the machine during a wash cycle for instance in order to add more dishes

Press the door latch upwards. Then wait until the sound of circulating water stops and the spray arms stop rotating. Then open the door and add the forgotten item. Press the door closed completely. The cycle will continue from the point where it was interrupted. Items should be added during the prewash or as early as possible during the main wash cycle for the best results.

If you turn off the machine at the main on/off switch

(or if there is a power failure) before the program has finished, the program will continue when power is restored.

When the wash is finished

- When the machine has stopped, it consumes only an extremely low current. To turn it off completely, turn off the main on/off switch.
- The indicator light remains on as long as the switch is in the On position. It is a good rule never to leave a switched-on machine unattended.
- Empty the coarse filter and occasionally check the fine mesh filter if necessary.

How to save energy

Only start a wash when the machine is completely full

In order to save energy, it is best to wait until you have a full load thus saving energy.

Select a program without drying heat

If you select a program without heated drying, the dishes will take somewhat longer to dry. However, if you open the door during the drying sequence to release the humid air the dishes will dry quicker. (Note: Do not open the door during a heated dry cycle or the cycle will be interrupted and the heating element will not come back on.)

State and local sanitization codes and rules

You will find sanitization codes and rules available from your State Health Department. They will usually be found in the Mechanical Cleaning and Sanitization section for the Food Service or Food Sanitization Rules. Some states have separate rules for Bed and Breakfast establishments. Be sure to check the rules for your particular application. The rule will appear somewhat like this:

Machines using hot water for sanitizing may be used providing wash water and pumped rinse water be kept clean and water shall be maintained at not less than the temperature stated in this section of the rules.

a. Single-tank, stationary-rack, single temperature machine:

- A. Wash temperature 165°F
- B. Final rinse temperature 165°F

The 1653 has been designed to meet or exceed rules which require the above sanitizing standards for commercial applications of dishwashers, these regulations may vary from state to state. Should you have any questions regarding this unit meeting the requirements of a specific application, please consult your area Public Health Department.

Safety

WARNING!
Wooden items and some types of plastic may cause a fire in the machine if they drop onto the heating element.

Door switch

The machine is equipped with a door switch, breaking the current and interrupting the wash cycle if the door is opened while the machine is in operation. The door is also equipped with a child safety catch (see text below).

Level control

Furthermore the machine is equipped with a level control (over flow), automatically starting the drain pump should the water level reach a level higher than normal. This level control functions only if the machine is in operation.

Child safety catch

The machine is fitted with a child safety catch to prevent children from opening the door and risking injury from hot water or steam. It also prevents children from getting at the corrosive detergent, or sharp knives which may be inside.

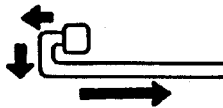
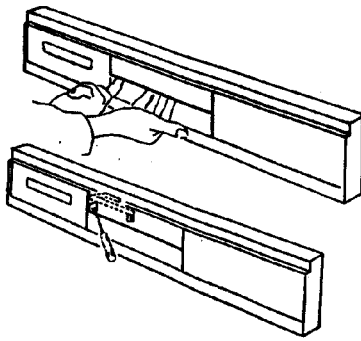

This is how you engage the child safety catch

Slide the catch to the left, then backwards and then to the right. To open the door, hold the catch with your left hand and pull the main catch with your right hand in the usual way.

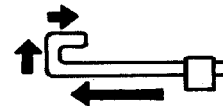

This is how you disengage the child safety catch

Slide the catch to the left, then forwards and then to the right.

How to fit a new Front Panel

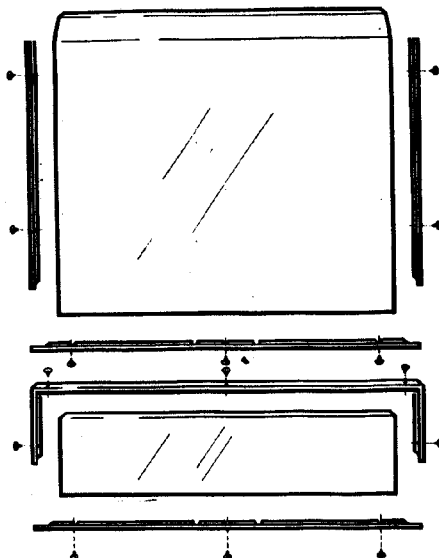

CAUTION! Turn the power supply to the machine off first.

Lower panel

1. Undo the lower panel by unscrewing the attachment screws at the bottom.
2. Remove the screws from the lower decor molding and loosen the other screws. Remove the panel and replace it with the new one.
3. Screw the molding in position and tighten the remaining screws.

Fit the upper panel before refitting the lower panel to the machine.

Upper panel

1. Remove the attachment screws and the molding on one side (left or right).
2. Loosen the other screws and pull out the panel carefully.
3. Push in the new one carefully. Screw the molding in position and tighten the other screws.
4. Refit the lower panel.

Maintenance

The inner casing of the machine is manufactured of stainless steel and kept clean in the course of normal use. From time to time the fine mesh filter should be removed for cleaning. The machine may be cleaned after a period of inactivity or wrong adjustment by adding a tablespoon of citric acid crystals to a wash.

The fine filter

Litter being collected in the fine filter is automatically flushed off at each run of the machine. If the net of the fine filter is clogged, e.g. by lime sediment or dirt, it must be cleaned. This cannot always be seen on top of the screen. Therefore remove the filter now and then and check the underside. Remove the 2 retaining screws and lift up the fine filter. Use a brush to clean it. When installing the fine filter again, make sure that the edges of the filter seal properly against the bottom. This will prevent food particles from getting into the circulation pump.

The lower strainer

If the lower strainer, too, is dirty, it can be removed and rinsed clean. It is clipped into position, and can be removed by squeezing the "ears" and pulling it straight upwards. Make sure that the clips are properly located when replacing the strainer.

Air gap

To prevent dirty water from being sucked back into the dishwasher, certain local plumbing codes demand that you install an Air Gap. This is not part of the dishwasher however, but is part of the plumbing.

It is very important to keep the Air Gap clean. You should check it at least once a week to make sure that it is working as it should. If this is not the case, lift up the chrome cover and plastic cap, and clean with something suitable like a toothpick.

The wash arm holes and bearings

can be clogged by dirt. Remove the plastic locks on top of the flushing arms and lift them off. Use a needle or similar device to push the dirt out of the holes.

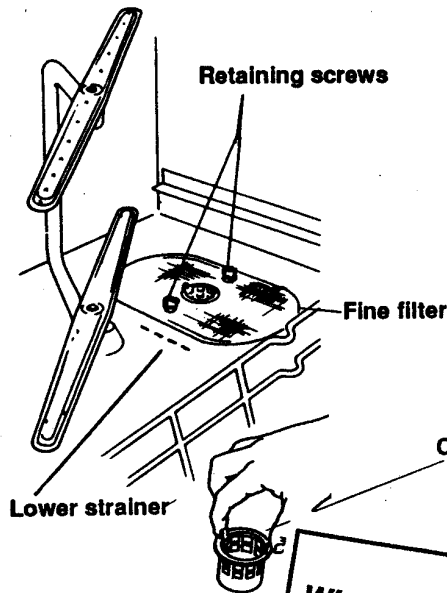

The coarse filter

Large food left-overs, which cannot pass through the drainage pump, are collected in the coarse filter. Lift out and empty the coarse filter when necessary. Don't forget to put it back again. It is normal for a small amount of water to remain in the coarse filter area.

Winter storing in unheated places

If the machine is kept in a place that is not heated, the draining and circulation as well as the inlet valve must be emptied of water. For further information contact your retail dealer. Freezing ruptures are not covered by the warranty.

Always check the Air Gap first if the drain becomes blocked and there is water left in the dishwasher.

Note that Air Gap is not part of the dishwasher and is not covered by this warranty!

How to clean the pump

- 1 Unscrew the bottom front plate and the kick-plate.
- 2 Unkink the drain pump line.
- 3 Remove the plug from the pump's draining hose. Water left in the pump will then drain out. Therefore hold a bowl under the hose.
- 4 Then loosen the pumphousing lid by moving the locking-bolt upwards (colored arrow). Move the lid sideways and clean the pump.
- 5 Replace the pump housing lid. Be sure drain house is in the downward position. Fold the drainline up so the plastic end does not rattle on the bottom base pan.

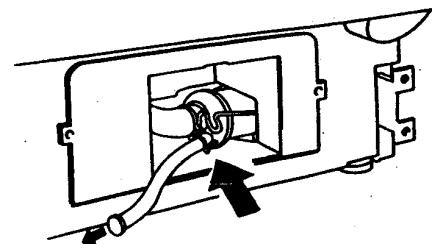
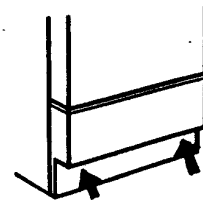

Trouble shooting

A simple fault may prevent the machine from working. You may be able to remedy this yourself. Trace the fault with the help of the points listed below. Also, be sure to read "Poor dishwashing results?", pages 15 to 18 for more problems, possible causes and suggested remedies.

There is water left in the machine

If the machine is taking in too much water, the drainage pump starts automatically. If the water, in spite of this, is not drained off, it might depend on any of the following reasons:

The filter system is clogged

Lift out the coarse filter and empty it. Place back in dishwasher before starting.

The pump is blocked

Pieces of bone or other foreign particles might be stuck in the drainage pump. The picture below shows you how to clean the pump.

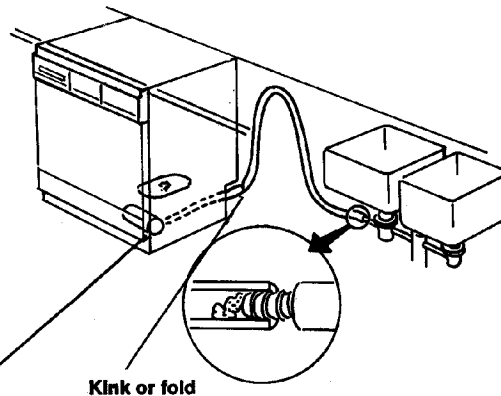

Air Gap

If the machine is equipped with an Air Gap, see Page 13. Be sure the air gap is not blocked or plugged.

The drain hose has a fold

Check to make sure that there are no folds or sharp bends on the drain hose.

The drain hose is clogged (blocked)

Check to make sure that there are no obstacles in the hose where it connects to the water lock. Foreign particles can get stuck in the entrance of the connection line, see the picture. Also check to make sure that the cone-shaped connection line has been cut to an inner diameter of at least 3/4" (15 mm). Check for a kink in the drain hose.

The machine does not start

If the machine does not start it might depend on any of the following reasons:

- ① Push in main on/off button. Main Power Indicator Light will come on.
- ② The door is not closed completely.
- ③ A fuse has blown. Check the circuit breaker.
- ④ The plug-in contact is not inserted in the wall socket or is wired incorrectly.

Poor dishwashing results

Try the following remedies:

Poor results may not always be caused by the machine. Read through the chart below before contacting your servicer.

Problem	Possible Cause	Suggested Remedy
Spotting and filming	Hard water	<p>Use the maximum recommended amount (3 tablespoons) of dishwasher detergent. You may need a home water softener.</p> <p>To remove hard water spots, try a vinegar rinse:</p> <ul style="list-style-type: none"> • Wash and rinse load as usual. • Remove all metal items from dishwasher. • Do not add detergent. • Pour two cups of vinegar into a bowl and set it on the bottom rack of the dishwasher. • Run the dishes through an entire wash program. <p>If the vinegar rinse doesn't work, repeat the above process substituting 1/4 cup citric acid crystals (available at most drug stores) for the vinegar.</p> <p>Wiping with a damp cloth should remove spots from metal items. For sterling and silver plated flatware, rub with a towel, or use a good cream silver polish.</p>
	Filter system	Check filter system to be sure it is clean and properly installed.
	No rinse aid	Does the rinse aid dispenser need to be filled? (Note: Used only in hard water areas.)
	Water not hot enough	Use the HI water temperature for best results when washing heavily soiled or greasy items, except for fine china and delicate crystal.
	Too little water	<p>Check that the water valve is fully open. Make sure that the water pressure is between 18 and 176 PSI.</p> <p>Check the filter in the inlet valve.</p>
	Dishwasher detergent	<p>Use only the correct amount of dishwasher detergent according to the hardness of the water and the wash program you have selected. Do not use old or caked detergent. Store the dishwasher detergent in a dry place and in a closed container.</p> <p>Change the dishwasher detergent, if the result is still unsatisfactory.</p>
	Items not loaded properly	<p>Check that you have loaded the items according to the instructions on pages 6 and 7.</p> <p>Do not overload. Make sure spray can reach all soiled surfaces.</p>
	Spray arms rotate poorly or stand still	<p>Check that both spray arms can rotate freely and that items do not obstruct the movement of the spray arms. Lift the arms and make sure that no grains of dirt etc. retard the rotation of the spray arms. If necessary, clear the obstruction, refit the arms and check that they rotate freely.</p> <p>Make sure that the holes in the spray arms are not blocked by dirt. If necessary, clear the holes with a pointed object.</p>
	Strainer blocked	Check the strainer. Clean if necessary. See the instructions on page 13.
	Excessive foam in the machine	Use only dishwasher detergent.
Flatware incorrectly loaded	Pay particular attention to spoons so that they do not nest in each other and prevent water penetration.	

Problem	Possible Cause	Suggested Remedy
Small particles deposited on items	<p>Spray arm or arms not rotating freely</p> <p>Detergent</p> <p>Low water pressure</p> <p>Improper loading of dishes</p>	<p>Be sure a utensil or handle has not prevented their turning.</p> <p>Use only fresh detergent, stored in a tightly closed container in a cool dry place. Fill dispenser only when ready to start the dishwasher. Use the recommended amount of detergent, especially with hard water.</p> <p>Check that the water valve is fully open. Make sure that the water pressure is between 18 and 176 PSI.</p> <p>Load dishes to prevent water and detergent from being trapped in or between items. Water should circulate freely.</p>
Marks and discoloration	Aluminum utensils rubbing against items during washing	<p>Be sure aluminum utensils, especially light weight foil-type pans, do not touch dishes.</p> <p>To remove spots, use a non-abrasive cleaner.</p>
Yellow or brown marks	<p>Iron or manganese in water</p> <p>Copper with sterling silver</p> <p>Tea or coffee (tannic acid)</p>	<p>Temporary solution: Pour 1 teaspoon to 1 tablespoon of citric acid crystals in instead of the prewash detergent directly on the inside of the door. Follow this prewash with a full detergent wash. Use the heavy wash program.</p> <p>Permanent solution: Install an iron removal system in the water supply.</p> <p>Yellow film on sterling silver results when you wash copper utensils in the same load. Silver polish will usually remove this stain.</p> <p>Tea or coffee can stain cups. Remove stains by hand, using a solution of 1/2 cup bleach and 3 cups warm water. (Do not use on sterling silver or silver plate.)</p>
Discoloration of stainless steel, silver plate or sterling silver	<p>Allowing salty or acidic foods to remain on flatware</p> <p>Stainless steel contacting silver</p>	<p>Rinse flatware that is to stand several hours before washing.</p> <p>Do not put stainless steel and silver flatware in the same silverware basket compartment. Direct contact between these metals can cause permanent damage to silver.</p> <p>Clean stained items with silver polish.</p> <p>Do not use abrasives on stainless steel or silver.</p>

Problem	Possible Cause	Suggested Remedy
Distortion of plastics	Plastic item has low heat tolerance	Plastics vary in their ability to tolerate heat. Check washing instructions for all plastic items to be sure they are dishwasher safe. If they are, place in top rack, away from the heating element.
Marks on melamine and plastics	Porous material	Use a special cleaner for plastic. DO NOT use bleach or scouring powder on these materials.
Cloudy film on glassware—etching of glass	Too much detergent, especially in soft water Rinse aid used with soft water	If vinegar or citric acid rinse doesn't remove film, the cloudiness is "etching". This is permanent. To prevent etching, use the least amount (one teaspoon) of recommended dishwasher detergent if you have soft water. Use a good quality dishwasher detergent and rinse aid. Do not overload the machine. Water should circulate freely to assure adequate rinsing and draining. Use drying without heat. Use rinse aid in hard water areas only.
Dishes not dry	Non-heated drying No rinse aid Plastic items Improper loading or unloading Water not hot enough Dry cycle interrupted (Door opened too soon)	Be sure to select heated drying for the driest results. Allow more drying time when using non-heated drying. Fill rinse aid dispenser. Rinse aids help dishes to dry faster. (Note: Used only in hard water areas). Certain plastic materials are difficult to dry. Plastics may need towel drying. Do not overload or nest items. Be sure all surfaces drain well. Load items with concave bases so as much water as possible can run off. Unload the bottom rack first. Water from dishes in the top rack may be spilling into the bottom rack. Dishes washed with the HI water temperature setting will dry the fastest. If the door is opened during the heated dry cycle, the heating element does come back on after the door is re-closed. If the dishwasher door is opened immediately after the dry cycle is completed and then shut again, the damper door is closed, trapping warm humid air. It is best then to leave door open slightly.

Problem	Possible Cause	Suggested Remedy
Detergent left in detergent compartment (Detergent compartment will not open)	Compartment cover blocked Old detergent	The cover may not be opening because of improperly loaded items. Move dishes that may be blocking it. If detergent is hard or caked in the box, throw it away. Use only fresh detergent. Add detergent to dishwasher right before starting it.
Chipping or breaking of glassware	Improper loading	Do not overload. Load between prongs, not over them. Glasses loaded over prongs will not be supported and may chip or break. Make sure glassware is secure and can't come loose. Always use the top rack for delicate items. Use the delicate program for fine china.
Unusual noise	Improper loading	Utensils may not be secure or something small may have dropped from the rack. Water may cause utensils to rattle. Make sure everything is securely placed in the dishwasher.
Water left in bottom of dishwasher near filters	Dishwashing cycle not complete Some is normal	Allow dishwasher to complete cycle. Water left in removable coarse filter is normal.
Dishwasher will not drain	Air Gap Drain hose Filter system Clogged drain pump	Be sure air gap is not blocked or plugged. Check for kink in drain hose. Be sure there is no blockage in filter system. Remove, clean and place back in dishwasher before starting dishwasher. Clean drain pump. See page 14.
Dishwasher will not start	Blown fuse or tripped circuit breaker Door not completely closed Plugged in incorrectly Control on "OFF"	Replace fuse or reset circuit breaker. Remove any other appliances from the circuit. Close tightly until you hear a click. Make sure plug-in contact is inserted in the wall socket or wired correctly. Turn the main on/off switch from "OFF". Be sure a cycle has been selected.
Dishwasher will not fill	Door open Controls Water feed line Water supply	Check that door is firmly closed. Check that dishwasher is on. (See "Dishwasher will not start" page 14.) Check to see that the water feed line to dishwasher is not crimped. Be sure water is available and turned on.
Water backs up in sink when dishwasher drains	Garbage disposer and trap	Check garbage disposer and trap at sink for blockage or food particles.



ASKO Product Warranty

MODEL 1353-1, 1374, 1474, 1504, 1653, 760, 770

For Residential Installations

Length of warranty	ASKO will pay for:
ONE YEAR FULL WARRANTY From date of purchase	ASKO replacement parts and/or repair labor to correct defect in materials or workmanship. Service must be provided by an authorized ASKO service outlet.
FIVE YEAR LIMITED WARRANTY One year full plus second through fifth year limited from date of purchase.	ASKO replacement parts (repair labor costs not included) for any defective solid state controls, timers, motors, pumps or dishwasher racks.
TWENTY-FIVE YEAR LIMITED WARRANTY One year full plus second through twenty-five year limited from date of purchase.	ASKO replacement parts (replacement labor cost not included) of the stainless steel tank or stainless steel inner door panel if it fails to hold water due to a manufacturing defect such as cracking or rusting.

For Non-Residential Installations

SIX MONTHS FULL WARRANTY From date of purchase	ASKO replacement parts and/or repair labor to correct defect in materials or workmanship. Service must be performed by an authorized ASKO service outlet.
--	---

ASKO will not pay for:

- A. Service calls to:
 1. Correct the installation of the dishwasher
 2. Instruct how to use the dishwasher
 3. Replace house fuses or correct housing wiring
 4. Correct house plumbing
 5. Clean or service air device in drain line
 6. Clean drain pump
- B. Repair and/or parts due to shipping and/or handling damage.
- C. Repair and/or parts for failure of product if dishwasher is used in other than normal use.
- D. Damage resulting from accident, fire, floods, acts of God, alteration, misuse, abuse, improper installation or installation not in accordance with local electrical or plumbing codes.
- D. Any labor or shipping costs for parts during the limited warranty.
- E. Replacement parts or repair labor costs for units operated outside the Continental United States.
- F. Pick-up and delivery. ASKO dishwashers are designed to be repaired in the home.

IN NO EVENT SHALL ASKO USA INC. BE RESPONSIBLE FOR ANY INCIDENTAL OR CONSEQUENTIAL DAMAGES.

Some states will not allow the exclusion or limitation of incidental or consequential damages, so this exclusion or limitation may not apply to you. This warranty gives you specific legal rights and you may also have other rights which vary from state to state.

For warranty service, contact the dealer from whom you purchased the unit or an authorized ASKO service outlet. Service will be provided during normal business hours. Should you have a service problem that is not resolved locally write:

ASKO USA INC.
903 N. Bowser, Suite 200
Richardson, Texas 75081

Operation review:

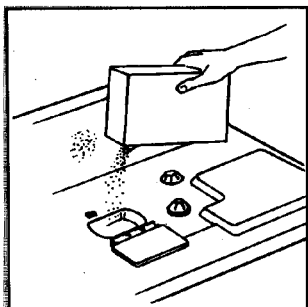

1. Load the items to be washed and add recommended amount of detergent.

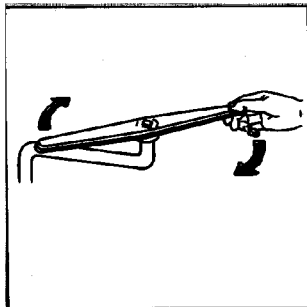

2. Check that the spray arms can move freely...

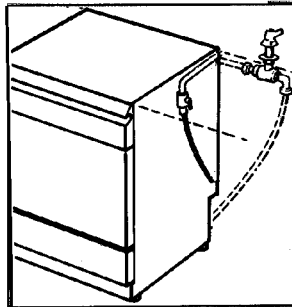



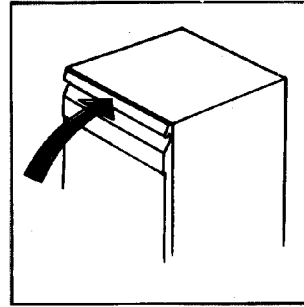

... and that the water supply faucet is open.



3. Close the door and choose program. Start the machine.

How to choose program:

<i>Program</i>	<i>Symbol</i>
Rinse and Hold	
Pots and Pans (Heavy Wash)	
Normal Wash	
Delicate (Light Wash)	

<i>Drying Selection</i>	<i>Symbol</i>
Heat Dry	
No Heat Dry	