



**TRANE®**

# Operation Maintenance

---

## Duplex CDHF, CDHG Water Cooled CenTraVac™ With CH530

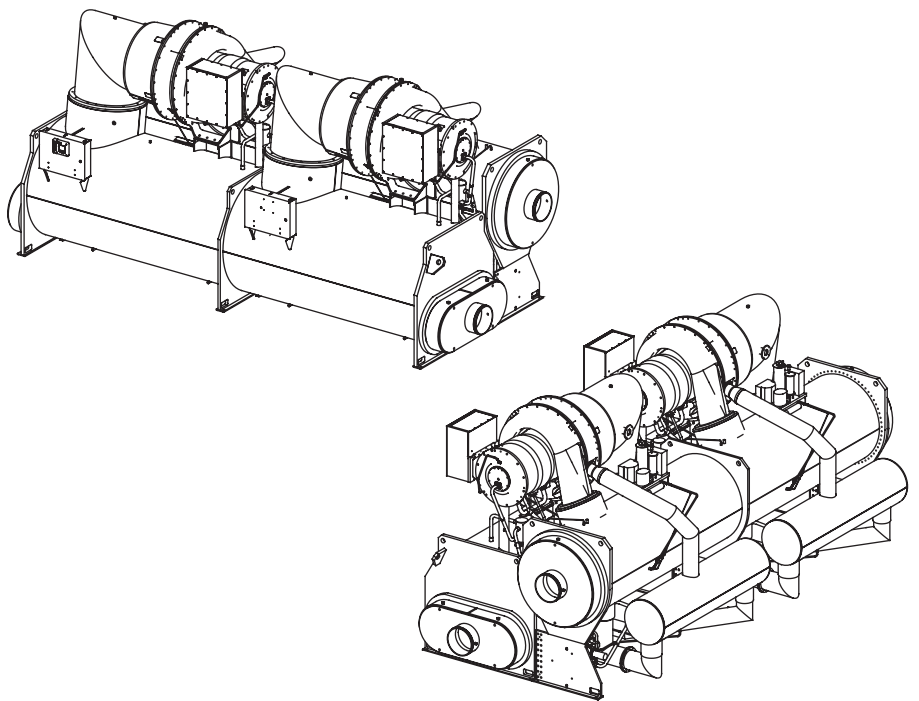

# Warnings and Cautions

---

## Warnings and Cautions

Notice that warnings and cautions appear at appropriate intervals throughout this manual. Warnings are provided to alert installing contractors to potential hazards that could result in personal injury or

death, while cautions are designed to alert personnel to conditions that could result in equipment damage.

Your personal safety and the proper operation of this machine depend upon the strict observance of these precautions.

## NOTICE:

Warnings and Cautions appear at appropriate sections throughout this manual. Read these carefully.

 **WARNING** – Indicates a potentially hazardous situation which, if not avoided, could result in death or serious injury.

 **CAUTION** – Indicates a potentially hazardous situation which, if not avoided, may result in minor or moderate injury. It may also be used to alert against unsafe practices.

**CAUTION** – Indicates a situation that may result in equipment or property-damage-only accidents.

# Contents

---

<b>Warnings and Cautions</b>	<b>2</b>
<b>General Information</b>	<b>4</b>
<b>Unit Control Panel (UCP)</b>	<b>28</b>
<b>Operator Interface</b>	<b>30</b>
<b>Chilled Water Setpoint</b>	<b>38</b>
<b>Inter Processor Communication (IPC)</b>	<b>51</b>
<b>Control System Components</b>	<b>52</b>
<b>Controls Sequence of Operation</b>	<b>67</b>
<b>Machine Protection and Adaptive Control</b>	<b>72</b>
<b>Unit Startup</b>	<b>89</b>
<b>Unit Shutdown</b>	<b>91</b>
<b>Periodic Maintenance</b>	<b>92</b>
<b>Oil Maintenance</b>	<b>95</b>
<b>Maintenance</b>	<b>97</b>
<b>Forms</b>	<b>104</b>



# General Information

## Literature change

Applicable to CDHF, CDHG

## About this manual

Operation and maintenance information for models CDHF, CDHG are covered in this manual. This includes both 50 and 60 Hz. CDHF and CDHG centrifugal chillers equipped with the Tracer CH530 Chiller Controller system. Please note that information pertains to all three chiller types unless differences exist in which case the sections are broken down by Chiller type as applicable and discussed separately.

By carefully reviewing this information and following the instructions given, the owner or operator can successfully operate and maintain a CDHF, or CDHG unit.

If mechanical problems do occur, however, contact a qualified service organization to ensure proper diagnosis and repair of the unit.

## Unit Nameplate

**The unit nameplate is located on the left side of the unit control panel.**

The following information is provided on the unit nameplate.

### 1. Serial Number

The unit serial number provides the specific chiller identity. Always provide this serial number when calling for service or during parts identification..

### 2. Service Model Number

The service model represents the unit as built for service purposes . It identifies the selections of variable unit features required when ordering replacements parts or requesting service.

**Note:** Unit-mounted starters are identified by a separate number found on the starter.

### 3. Product Coding Block

The CDHF and CDHG models are defined and built using the product definition and selection (PDS) system. This system describes the product offerings in terms of a product coding block which is made up of feature categories and feature codes. An example of a typical product code block is given on this page. The coding block precisely identifies all characteristics of a unit.

4. Identifies unit electrical requirements
5. Correct operating charges and type of refrigerant
6. Unit Test Pressures and Maximum Operating Pressures
7. Identifies unit Installation and Operation and Maintenance manuals
8. Drawing numbers for Unit Wiring Diagrams

### Typical Product Description Block

MODL CDHF	DSEQ 2R	NTON 2500	VOLT 575	REF 123
HRTZ 60	TYPE SNGL	CPKW 142	CPIM 222	TEST AIR
EVTM IECU	EVTH 28	EVSZ 032S	EVBS 280	
EVWC STD	EWWP 2	EVWT NMAR	EVPR 150	
EVCO VICT	EWVA LELE	CDTM IECU	CDTH 28	
CDSZ 032S	CDBS 250	CDWC STD	CDWP 2	
CDWT NMAR	CDPR 150	CDCO VICT	CDWA LELE	
CDTY STD	TSTY STD	ECTY WEOR	ORSZ 230	
PURG PURE	WCNM SNMP	SPKG DOM	OPTI CPDW	
HHOP NO	GENR NO	GNSL NO	SOPT SPSH	
ACCY ISLS	HGBP WO	LUBE SNGL	AGLT CUL	
CNIF UCP	SRTY USTR	SRRL 207	PNCO TERM	

# General Information

**Model Number** - An example of a typical duplex centrifugal chiller model number is:

**CDHF2100AA0BC2552613C0B203B0  
B20KJAC1GW40C111340A010**

**Digit: Description**

1<sup>st</sup>-2<sup>nd</sup> CD = CenTraVac® Duplex - 2 compressors

3<sup>rd</sup> H = Direct Drive

4<sup>th</sup> F = Development Sequence (F - 2 Stage) (G - 3 Stage)

5<sup>th</sup>-8<sup>th</sup> 2100 = Nominal total compressor tonnage

9<sup>th</sup> A = Unit Voltage

A = 380V-60Hz-3Ph

B = 440V-60Hz-3Ph

C = 460V-60Hz-3Ph

D = 480V-60Hz-3Ph

E = 575V-60Hz-3Ph

F = 600V-60Hz-3Ph

G = 2300V-60Hz-3Ph

H = 2400V-60Hz-3Ph

J = 3300V-60Hz-3Ph

K = 4160V-60Hz-3Ph

L = 6600V-60Hz-3Ph

M = 380V-50Hz-3Ph

N = 400V-50Hz-3Ph

P = 415V-50Hz-3Ph

R = 3300V-50Hz-3Ph

T = 6000V-50Hz-3Ph

U = 6600V-50Hz-3Ph

10<sup>th</sup>-11<sup>th</sup> A0 = Design Sequence

12<sup>th</sup> B = Compressor Motor Power, LH Circuit

13<sup>th</sup> C = Compressor Motor Power, RH Circuit.

Compressor Motor codes:

A = 588 KW

B = 653 KW

C = 745 KW

D = 856 KW

E = 957 KW

F = 1062 KW

G = 1228 KW

H = 433 KW

J = 489 KW

K = 548 KW

L = 621 KW

M = 716 KW

N = 799 KW

P = 892 KW

R = 403 KW

S = 453 KW

T = 512 KW

U = 301 KW

V = 337 KW

W = 379 KW

X = 1340 KW

14<sup>th</sup>-16<sup>th</sup> 255 = Compressor Impeller Diameter LH Circuit

17<sup>th</sup>-19<sup>th</sup> 261 = Compressor Impeller Diameter RH Circuit

20<sup>th</sup> 3 = Evaporator Tube Bundle Size

1 = 2100 nominal ton evaporator

2 = 2300 nominal ton evaporator

3 = 2500 nominal ton evaporator

4 = 1610 nominal ton evaporator

5 = 1850 nominal ton evaporator

21<sup>st</sup> C = Evaporator Tubes

A = I/E copper, 0.028" wall, 0.75" O.D.

B = I/E copper, 0.035" wall, 0.75" O.D.

C = S/B copper, 0.028" wall, 0.75" O.D.

D = S/B copper, 0.035" wall, 0.75" O.D.

E = I/E copper, 0.028" wall, 1.0" O.D.

F = I/E copper, 0.035" wall, 1.0" O.D.

22<sup>nd</sup> 0 = Not Assigned

23<sup>rd</sup> B - Evaporator Waterbox

A = 150 psig 1 pass marine

B = 300 psig 1 pass marine

C = 150 psig 1 pass non-marine

D = 300 psig 1 pass non-marine

24<sup>th</sup> 2 = Evaporator Waterbox Connection;

1 = Victaulic

2 = Flanged

25<sup>th</sup> 0 = Not Assigned

26<sup>th</sup> 3 = Condenser Tube Bundle Size

1 = 2100 nominal ton condenser

2 = 2300 nominal ton condenser

3 = 2500 nominal ton condenser

4 = 1610 nominal ton condenser

5 = 1760 nominal ton condenser

6 = 1900 nominal ton condenser

27<sup>th</sup> B = Condenser Tubes

A = I/E copper, 0.028" wall, 0.75" O.D.

B = I/E copper, 0.035" wall, 0.75" O.D.

C = S/B copper, 0.028" wall, 0.75" O.D.

D = S/B copper, 0.035" wall, 0.75" O.D.

E = I/E copper, 0.028" wall, 1.0" O.D.

F = I/E copper, 0.035" wall, 1.0" O.D.

G = I/E 90/10 CU/NI, 0.035" wall, 0.75" O.D.

28<sup>th</sup> 0 = Not Assigned

29<sup>th</sup> B = Condenser Waterboxes

A = 150 psig 1 pass marine

B = 300 psig 1 pass marine

C = 150 psig 1 pass non-marine

D = 300 psig 1 pass non-marine

30<sup>th</sup> 2 = Condenser Waterbox Connection;

1 = Victaulic

2 = Flanged

31<sup>st</sup> 0 = Not Assigned

32<sup>nd</sup> K = Orifice Size, LH Circuit,

33<sup>rd</sup> J = Orifice Size, RH Circuit, Orifice Nominal Tons:

A = 710

B = 790

C = 880

D = 990

E = 1100

F = 1265

G = 1400

H = 1540

K = 1810

J = 1660

L = 1970

M = 2150

N = 1045

P = 1185

R = 1335

T = 1605

U = 1735



# General Information

V = 1890	40 <sup>th</sup> C = Control: Condenser Refrigerant Pressure; 0 = None, C = with
W = 2060	
X = 1475	41 <sup>st</sup> 1 = Control: Extended Operation; 0 = None 1 = Extended operation
Z = 560 - 3 stage 935 - 2 stage	42 <sup>nd</sup> 1 = Chilled Water Reset - Outdoor Air Temperature Sensor 0 = None, 1 = Chilled water reset – with outdoor air temperature sensor, S = Special
Y = 500 - 3 stage 835 - 2 stage	
1 = 630 - 3 stage 2245 - 2 stage	43 <sup>rd</sup> 1 = Control: Operating Status, 0 = None, 1 = Operating Status
2 = 800 - 3 stage 2345 - 2 stage	44 <sup>th</sup> 1 = Gas Powered Chiller; 0 = No 1 = Yes
3 = 900 - 3 stage 2450 - 2 stage	45 <sup>th</sup> 3 = Compressor Motor Frame Size LH Circuit
4 = 1000 - 3 stage 2560 - 2 stage	46 <sup>th</sup> 4 = Compressor Motor Frame Size RH Circuit
5 = 1120 - 3 stage 2675 - 2 stage	FRAME SIZE CODES: 3 = 440E, 4 = 5000, 5 = 5800, 6 = 5800L, S = Special
6 = 1250	47 <sup>th</sup> 0 = Unit Insulation; 0 = None 1 = Insulation package
7 = 1600	48 <sup>th</sup> A = Spring Isolators 0 = No A = Yes
8 = 1800	49 <sup>th</sup> 0 = Not Assigned 0 = Not assigned
9 = 750	50 <sup>th</sup> 1 = Evaporator & Condenser Size 1 = 210D - 2100, 2 = 250D – 2500, 3 = 250X - 2500 , 4 = 250M - 2500
34 <sup>th</sup> A = Starter Type	51 <sup>st</sup> 0 = Special Options 0 = None S = Special Option
A = Star-Delta Unit Mounted	
C = Star Delta Remote Mounted	
E = X-Line Full Volt Remote Mounted	
F = Autotransformer Remote Mounted	
G = Primary Reactor Remote Mounted	
H = X-Line Full Volt Unit Mounted	
J = Autotransformer Unit Mounted	
K = Primary Reactor Unit Mounted	
L = Solid State Unit Mounted	
M = Solid State Floor Mounted	
N = Solid State Wall Mounted	
P = Adaptive Freq. Drive-Unit Mounted	
R = Customer Supplied	
35 <sup>th</sup> C = Control Enclosure; C = Standard S = Special	
36 <sup>th</sup> 1 = Control: Enhanced Protection; 0 = None 1 = Enhanced protection	
37 <sup>th</sup> G = Control: Generic BAS; 0 = None G = Generic BAS	
38 <sup>th</sup> W = Water Flow Control; 0 = None W = Water flow control	
39 <sup>th</sup> 4 = Tracer® Comm. Interface 0 = None, 4 = COMM 4, 5 = COMM 5, S = Special	

# General Information

---

## Commonly Used Acronyms

For convenience, a number of acronyms are used throughout this manual. These acronyms are listed alphabetically below, along with the “translation” of each:

AFD = Adaptive Frequency Drive  
ASME = American Society of Mechanical Engineers  
ASHRAE = American Society of Heating, Refrigerating and Air Conditioning Engineers  
BAS = Building Automation System  
CABS = Auxiliary Condenser Tube-Bundle S  
CDBS = Condenser Bundle Size  
CDSZ = Condenser Shell Size  
CH530 = Tracer CH530 Controller  
DV = DynaView™ Clear Language Display, also know as the Main Processor (MP)  
CWR = Chilled Water Reset  
CWR' = Chilled Water Reset Prime  
DTFL = Design Delta-T at Full Load (i.e., the difference between entering and leaving chilled water temperatures)  
ELWT = Evaporator Leaving Water Temperature  
ENT = Entering Chilled Water Temperature  
GPM = Gallons-per-minute  
HGBP = Hot Gas Bypass

HVAC = Heating, Ventilating, and Air Conditioning  
IE = Internally-Enhanced Tubes  
IPC = Interprocessor Communication  
LBU = La Crosse Business Unit  
LCD = Liquid Crystal Display  
LED = Light Emitting Diode  
MAR = Machine Shutdown Auto Restart (Non-Latching where chiller will restart when condition corrects itself.)  
MMR = Machine Shutdown Manual Restart (Latching where chiller must be manually reset.)  
MP = Main Processor  
PFCC = Power Factor Correction Capacitor  
PSID = Pounds-per-Square-Inch (differential pressure)  
PSIG = Pounds-per-Square-Inch (gauge pressure)  
UCP = Unit Control Panel  
LLID = Low Level Intelligent Device (Sensor, Pressure Transducer, or Input/output UCP module)  
RLA = Rated Load Amps  
RTD = Resistive Temperature Device  
Tracer CH530 = Tracer CH530 controller  
TOD = Temperature Outdoor

## Control Optional Packages

OPST Operating Status Control  
GBAS Generic Building Automation Interface  
EXOP Extended Operation  
CDRP Condenser Pressure Transducer  
TRMM Tracer Communications  
WPSR Water pressure sensing  
EPRO Enhanced Protection  
CWR Chiller Water reset outdoor

# General Information

## Overview

### CDHF - CDHG

See Figure 1 for General Unit components. Each Chiller unit is composed of the following components as viewed when facing the control panel front side:

- Common Evaporator and Common Condenser

- Compressors and Motor 1 (Left hand), and 2 (Right hand)
- Economizers 1(LH), and 2 (RH),
- Purge 1(LH), and 2 (RH),
- Oil Tank/ Refrig. Pump 1 (LH), and 2 (RH),
- Control Panel 1 (LH), and 2 (RH)
- And when specified Unit mounted Starters 1 (LH) and 2 (RH) (not shown).

**Figure 1. General Duplex unit components - front view**

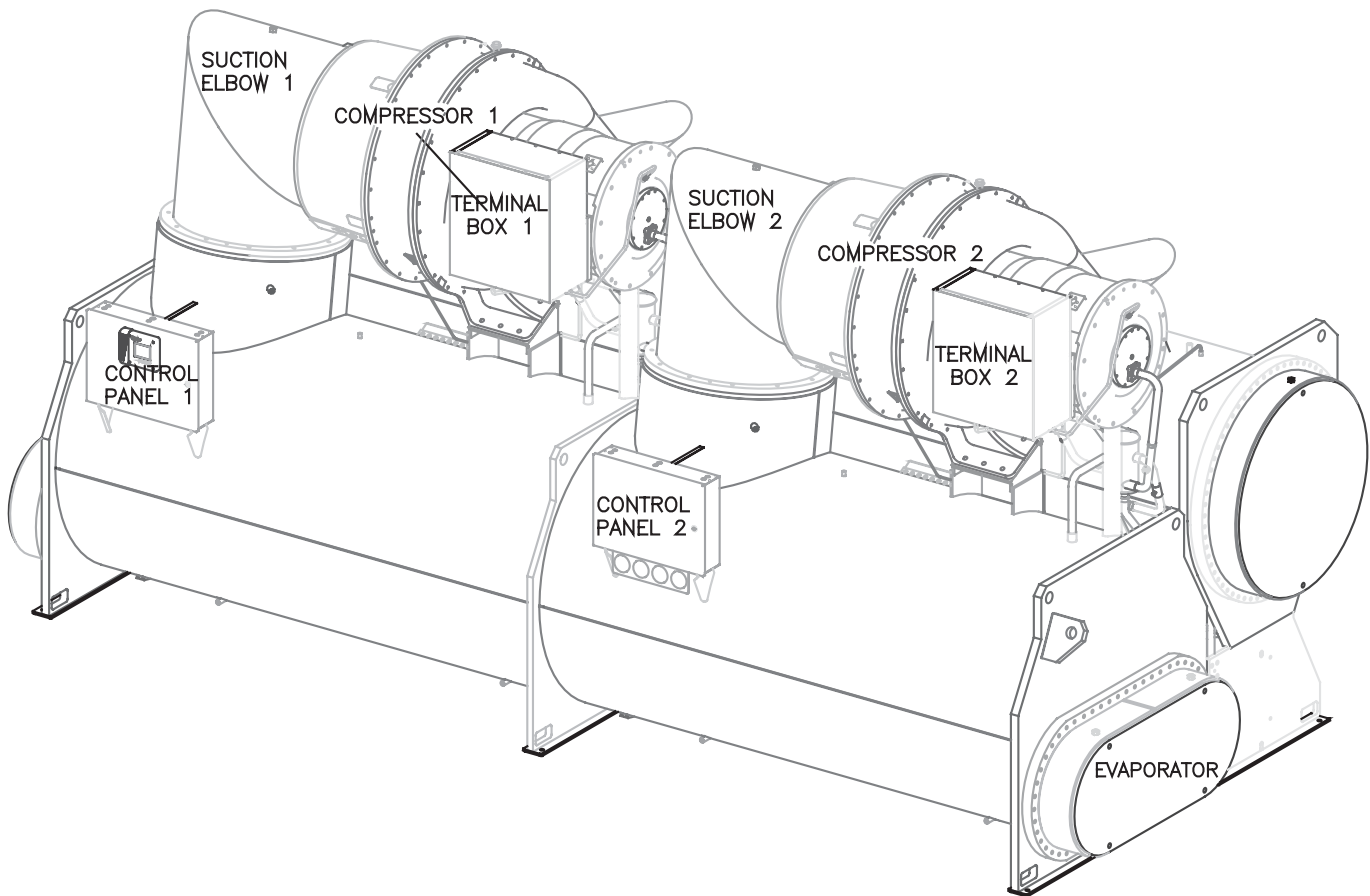



# General Information

Figure 2. General Duplex unit components (2 stage compressor)

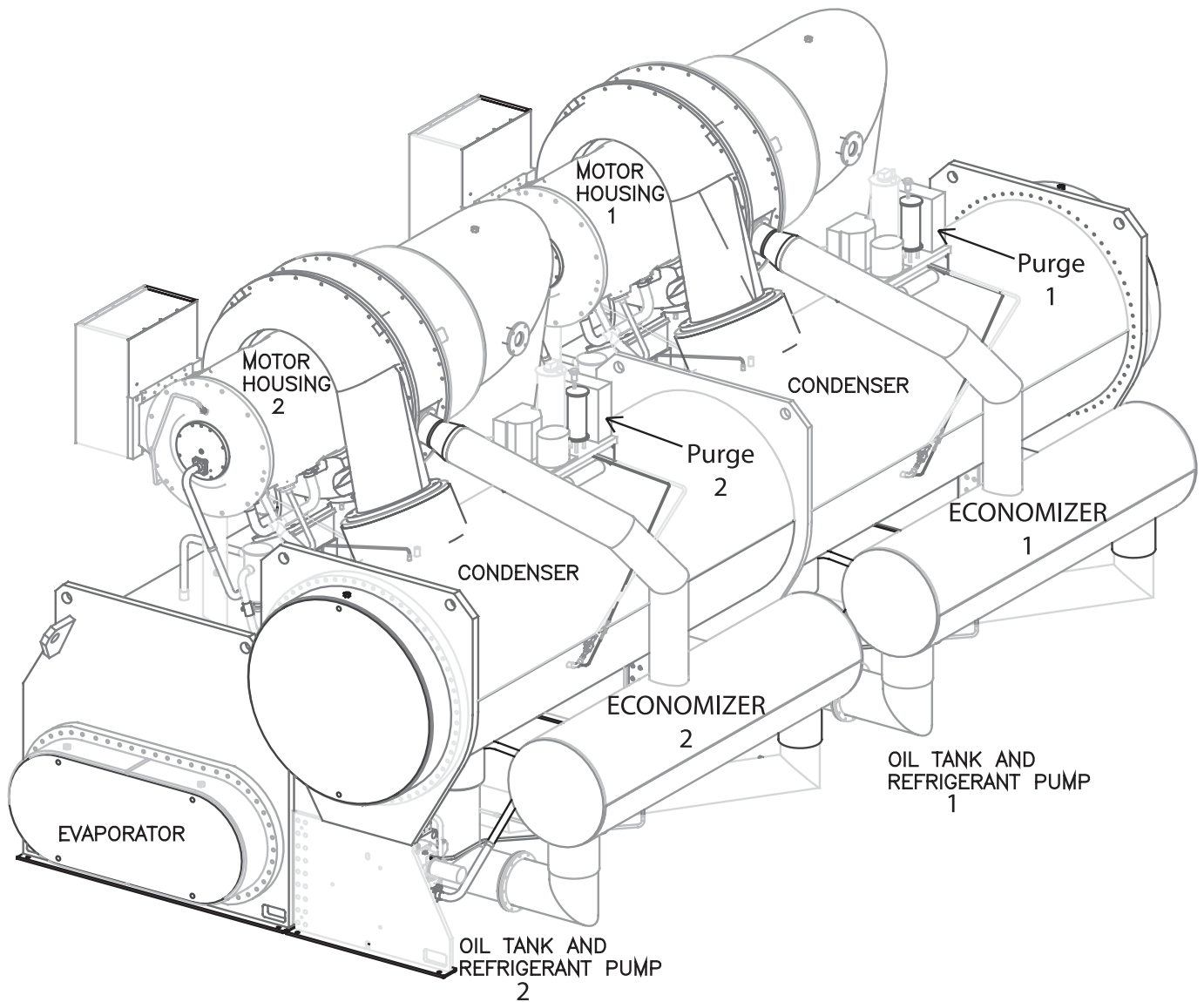

# General Information

---

## Cooling Cycle

Duplex Chillers have two refrigerant circuits that operate as their own independent circuits. These circuits are discussed as individual chiller refrigeration units in the following discussion. The sequence of operation of the two refrigeration circuits is discussed in a later section.

When in the cooling mode, liquid refrigerant is distributed along the length of the evaporator and sprayed through small holes in a distributor (i.e., running the entire length of the shell) to uniformly coat each evaporator tube. Here, the liquid refrigerant absorbs enough heat from the system water circulating through the evaporator tubes to vaporize.

The gaseous refrigerant is then drawn through the eliminators (which remove droplets of liquid refrigerant from the gas) and first-stage variable inlet guide vanes, and into the first stage impeller.

**Note:** Inlet guide vanes are designed to modulate the flow of gaseous refrigerant to meet system capacity requirements; they also prerotate the gas, allowing it to enter the impeller at an optimal angle that maximizes efficiency at all load conditions.

## Compressor 1 or 2 (3 Stage)

Compressed gas from the first-stage impeller flows through the fixed, second-stage inlet vanes and into the second-stage impeller.

Here, the refrigerant gas is again compressed, and then discharged through the third-stage variable guide vanes and into the third stage impeller.

Once the gas is compressed a third time, it is discharged into the condenser. Baffles within the condenser shell distribute the compressed refrigerant gas evenly across the condenser tube bundle. Cooling tower water circulated through the condenser tubes absorbs heat from the refrigerant, causing it to condense. The liquid refrigerant then passes through orifice plate "A" and into the economizer.

The economizer reduces the energy requirements of the refrigerant cycle by eliminating the need to pass all gaseous refrigerant through three stages of compression. See Figure 3. Notice that some of the liquid refrigerant flashes to a gas because of the pressure drop created by the orifice plates, thus further cooling the liquid refrigerant. This flash gas is then drawn directly from the first (Chamber A) and second (Chamber B) stages of the economizer into the third-and second-stage impellers of the compressor, respectively.

All remaining liquid refrigerant flows through another orifice plate "C" to the evaporator.

## Compressor 1 or 2 (2 Stage)

Compressed gas from the first-stage impeller is discharged through the second-stage variable guide vanes and into the second-stage impeller. Here, the refrigerant gas is again compressed, and then discharged into the condenser.

Baffles within the condenser shell distribute the compressed refrigerant gas evenly across the condenser tube bundle. Cooling tower water, circulated through the condenser tubes, absorbs heat from the refrigerant, causing it to condense. The liquid refrigerant then flows out of the bottom of the condenser, passing through an orifice plate and into the economizer.

The economizer reduces the energy requirements of the refrigerant cycle by eliminating the need to pass all gaseous refrigerant through both stages of compression. See Figure 6. Notice that some of the liquid refrigerant flashes to a gas because of the pressure drop created by the orifice plate, thus further cooling the liquid refrigerant. This flash gas is then drawn directly from the economizer into the second-stage impellers of the compressor.

All remaining liquid refrigerant flows out of the economizer, passes through another orifice plate and into the evaporator.

# General Information

Figure 3. Pressure enthalpy curve (3 stage compressor)

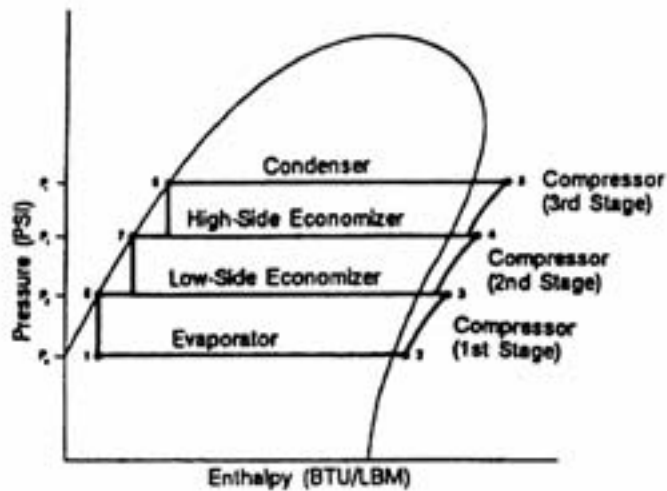
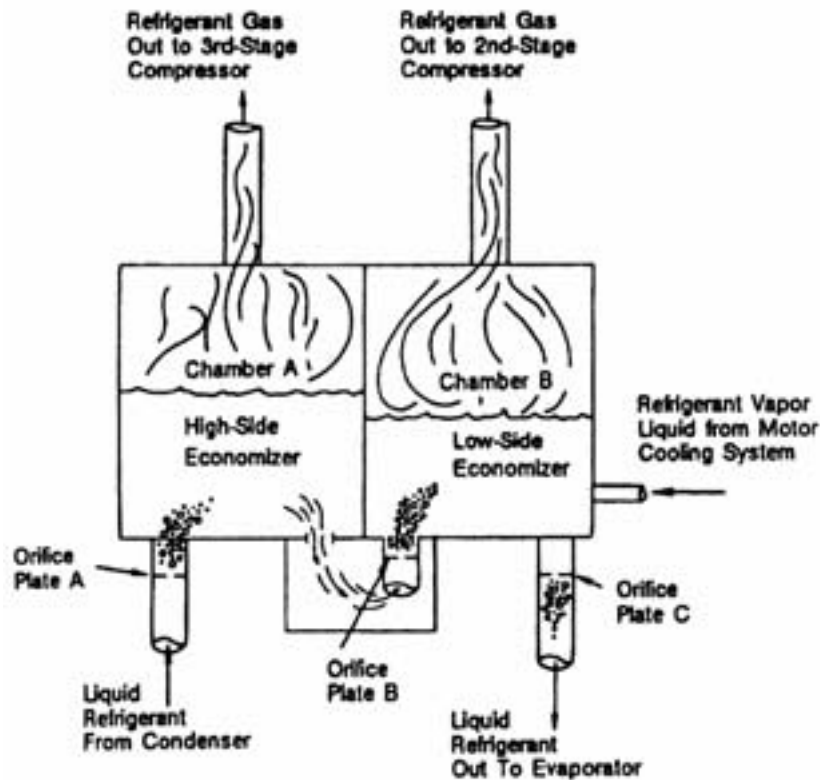

Figure 4. 2-stage economizer (3 stage compressor)



# General Information

Figure 5. Pressure enthalpy curve (2 stage compressor)

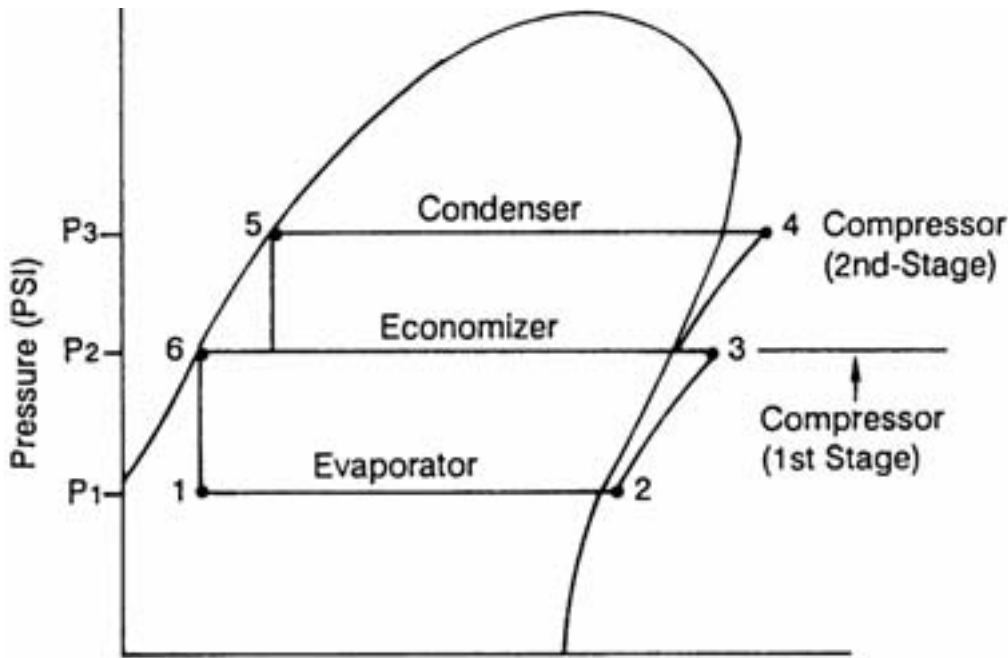
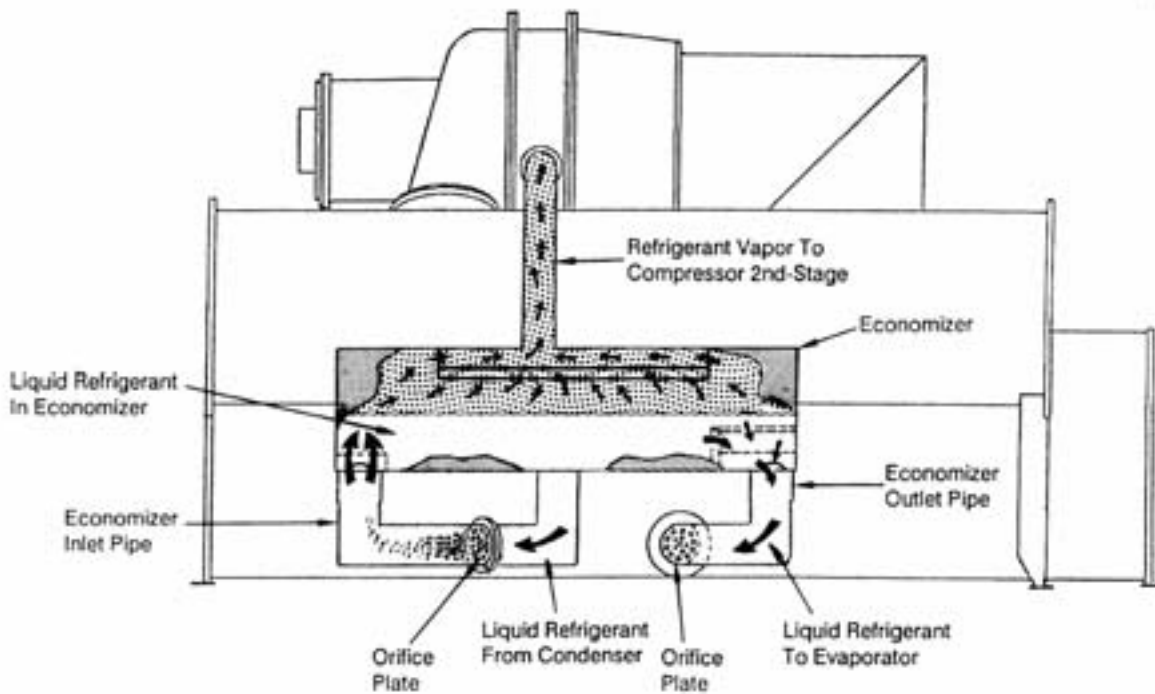

Figure 6. Single stage economizer (2 stage compressor)



# General Information

---

## Overview

### Controls Operator Interface

Information is tailored to operators, service technicians and owners.

When operating a chiller, there is specific information you need on a day-to-day basis — setpoints, limits, diagnostic information, and reports.

When servicing a chiller, you need different information and a lot more of it — historic and active diagnostics, configuration settings, and customizable control algorithms, as well as operation settings.

By providing two different tools — one for daily operation and one for periodic service — everyone has easy access to pertinent and appropriate information.

### DynaView™ Human Interface

— For the operator

Day-to-day operational information is presented at the panel. Up to seven lines of data (English or SI units) are simultaneously displayed on the ¼ VGA touch-sensitive screen.

Logically organized groups of information — chiller modes of operation, active diagnostics, settings and reports put information conveniently at your fingertips. See Operator Interface Section for details.

### TechView™ Chiller Service Tool

— For the service technician or advanced operator

All chiller status, machine configuration settings, customizable limits, and up to 60 active or historic diagnostics are displayed through the service tool interface. Without changing any hardware, we give you access to the latest and greatest version of Tracer CH530! A new level of serviceability using the innovative TechView™ chiller service tool. A technician can interact with an individual device or a group of devices for advanced troubleshooting. LED lights and their respective TechView™ indicators visually confirm the viability of each device. Any PC that meets the system requirements may download the service interface software and Tracer CH530 updates. For more information on TechView™ visit your local Trane Service company, or The Trane Company's website at [www.trane.com](http://www.trane.com).

# General Information

## CTV Duplex Sequence Of Operation

This section will provide basic information on chiller operation for common events. With microelectronic controls, ladder diagrams cannot show today's complex logic, as the control functions are much more involved than older pneumatic or solid state controls. Adaptive control algorithms can also complicate the exact sequence of operation. This section and its diagrams attempt to illustrate common control sequences.

The Sequence of Events diagrams use the following KEY:

### Software States: (Figure 7)

There are five generic states that the software can be in:

1. Power Up, Stopped, Starting, Running, Stopping

### Timeline Text: (Figures 8-11)

The large timeline cylinder indicates the upper level operating mode, as it would be viewed on DynaView. Text in Parentheses indicates sub-mode text as viewed on DynaView. Text above the timeline cylinder is used to illustrate inputs to the Main Processor. This may include User input to the DynaView Touch pad, Control inputs from sensors, or Control Inputs from a Generic BAS. Boxes indicate Control actions such as Turning on Relays, or moving the Inlet Guide Vanes. Smaller cylinders indicate diagnostic checks, Text indicates time based functions, Solid double arrows indicate fixed timers, Dashed double arrows indicate variable timers

### Power Up Diagram:

The Power up chart shows the respective DynaView screens during a power up of the main processor. This process takes from 30 to 50 seconds depending on the number of installed Options. On all power ups, the software model always will transition through the 'Stopped' Software state independent of the last mode. If the last mode before power down was 'Auto', the transition from 'Stopped' to 'Starting' occurs, but it is not apparent to the user.

### Software Operation Overview Diagram:

The Software Operation Overview is a diagram of the five possible software states. This diagram can be thought of as a State Chart, with the arrows, and arrow text, depicting the transitions between states.

The text in the circles are the internal software designations for each State. The first line of text in the Circles are the visible top level operating modes that can be displayed on Dyna View. The shading of each software state circle corresponds to the shading on the timelines that show the state that the chiller is in.

Figure 7. Sequence of operation overview.

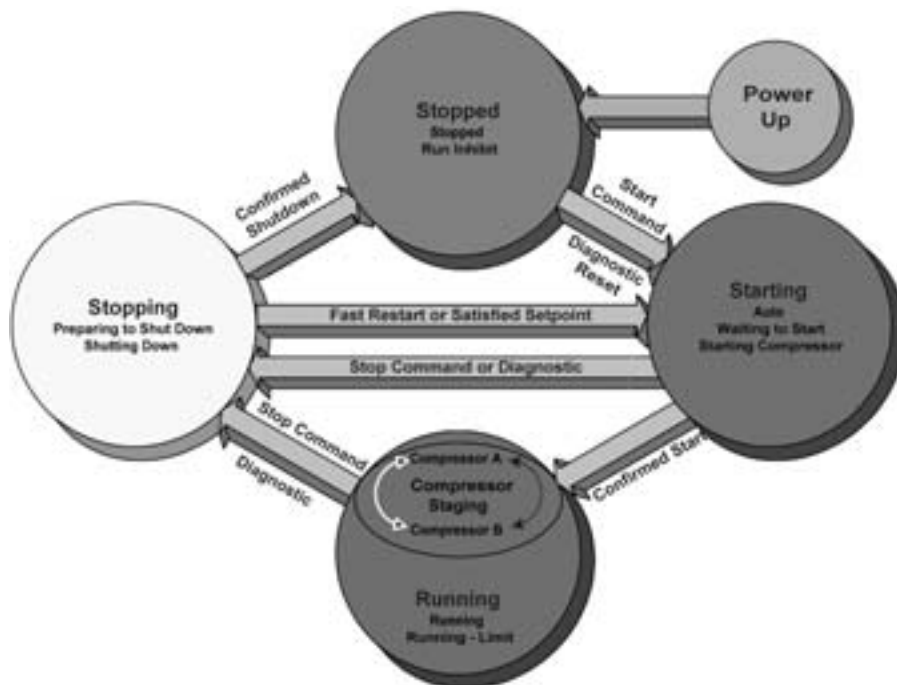

# General Information

Figure 8. CDHE/F/G sequence of operation: auto to running

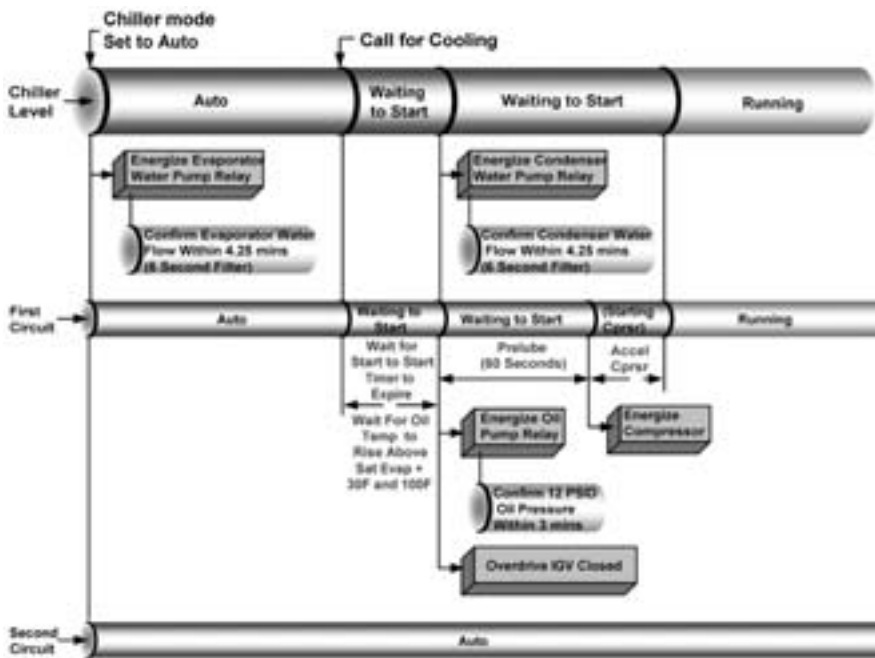

This diagram shows the sequence of operations for a start of the first compressor on a duplex chiller. The 'First' compressor will be determined by the type of duplex start selected.

### Staging Second Compressor On:

This diagram shows the sequence of operations where the 'First' compressor is all ready running, and the 'second' compressor is staged on. The 'First' and 'Second' compressor will be determined by the type of duplex start selected

Figure 9. CDHE, CDHF, and CDHG sequence of operation: running

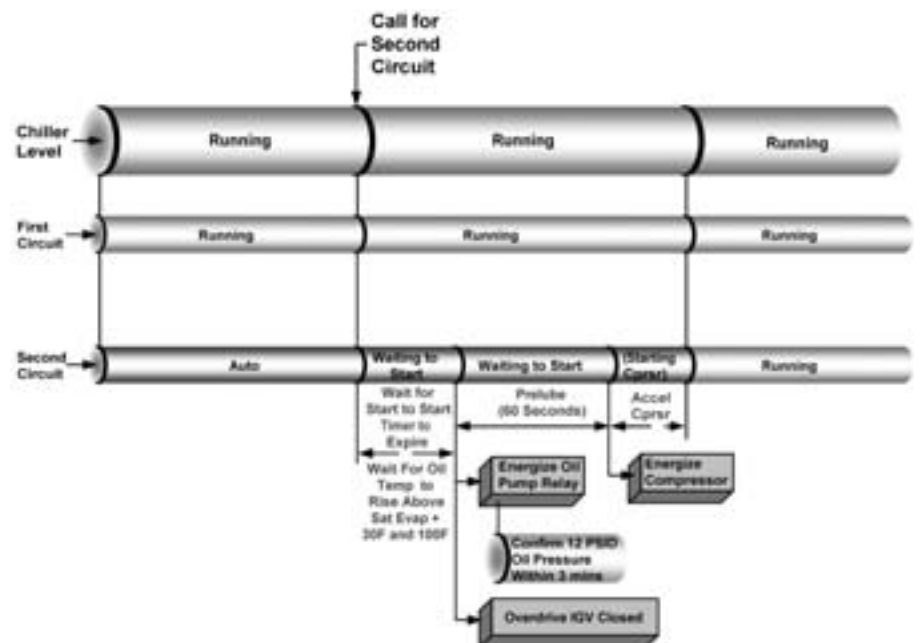

# General Information

## Staging Second Compressor Off:

This diagram shows the sequence of operations where there is no longer a need to run the 'Second' compressor, so it is staged off. The 'First' and 'Second' compressor will be determined by the type of duplex start selected

Figure 10. CDHE/F/G sequence of operation: staging second compressor off

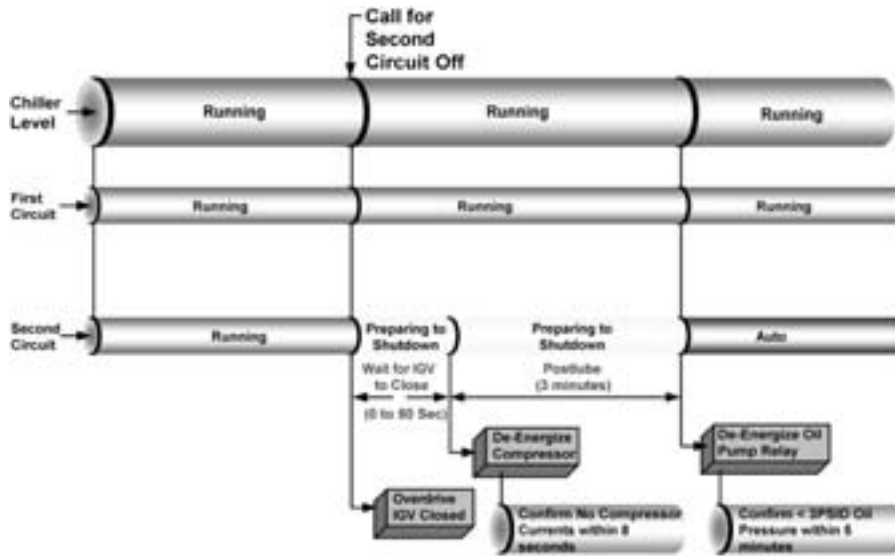

## Satisfied Setpoint:

This diagram shows the sequence of operations where the setpoint has been satisfied, and the last compressor is staged off.

Figure 11. CDHE, CDHF and CDHG sequence of operation: normal shutdown to stopped and run inhibit

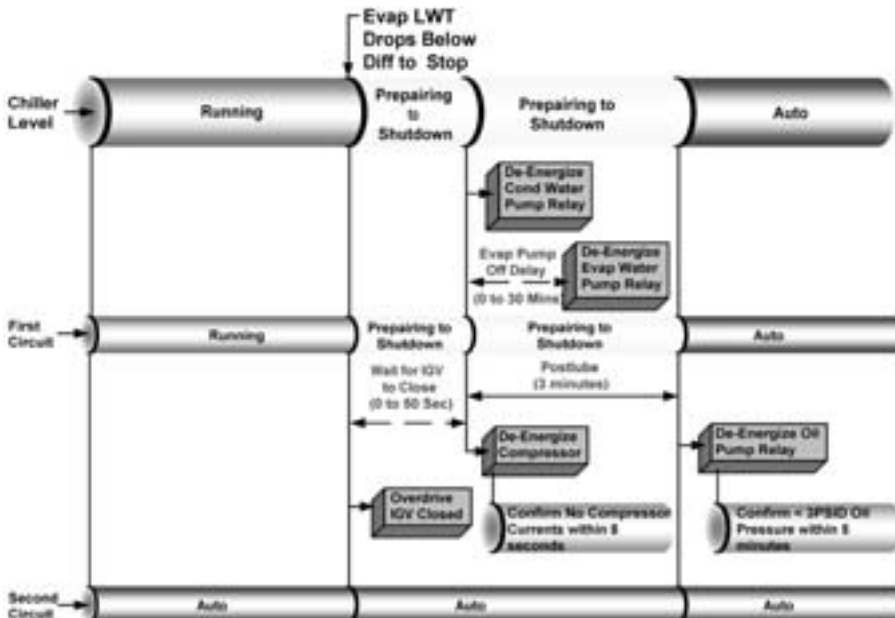



# General Information

## Duplex Compressor Sequencing

Four methods (Two fixed sequence methods, a balanced start and hour's method, and a no staging method) are provided for order of a compressor sequencing on CTV Duplex chillers. The desired method is selectable at startup via the service tool. The application can decide to either balance the wear burden among the unit's compressors, to start the most efficient compressor, or to simultaneously start and stop both compressors to minimize startup pull down time. Each method has specific applications where it can be used advantageously.

If one compressor is locked out, in restart inhibit, or generally not ready to start, the available compressor will be started.

**Note:** The following description assumes compressor 1 is the downstream compressor.

## Fixed Sequence – Compressor 1/ Compressor 2 (Default mode)

If the chiller is in the Auto mode and all interlocks have been satisfied, compressor 1 will be started based on the leaving water temperature rising above the "Differential to Start" setting. Compressor 2 will stage on when the overall chiller average capacity exceeds Stage ON Load point for 30 seconds. The stage on load point is adjustable (via service tool) up to 50%. The default is 40% which means that a single compressor would have to load to 80% (the average would be 40%) before the second compressor starts. Both compressors will run until chiller average capacity drops below Stage off Load point for 30 seconds. The Stage OFF load point is also

adjustable (via service tool) (default = 30%, range from 0 to 50%). Compressor 2 will be shut down and compressor 1 will run until water temperature drops below the differential to stop. Before shutting down, compressor 2 will be unloaded and compressor 1 will be loaded to maintain the same average capacity command.

When running chilled water temperature at selected conditions, the downstream compressor usually will be the most efficient compressor to operate at part load because compressors on Duplex chillers are not sized exactly the same.

**Figure 12. CDHF/G sequence of operation: lead 1/lag 2**

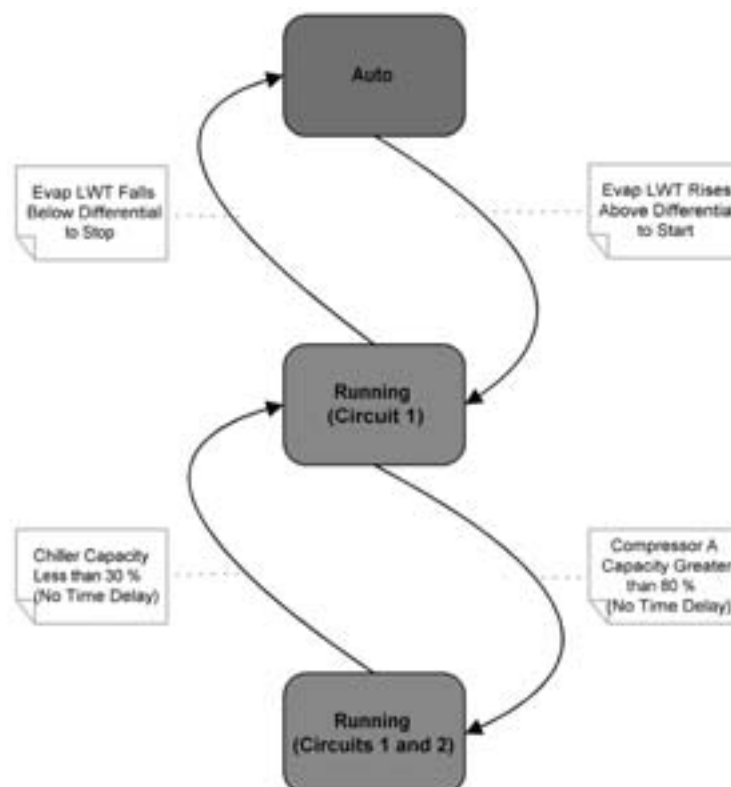

# General Information

## Fixed Sequence – Compressor 2 / Compressor 1

If the chiller is in the Auto mode and all interlocks have been satisfied, compressor 2 will be started based on the leaving water temperature rising above the “Differential to Start” setting. Compressor 1 will stage on when the overall chiller average capacity exceeds Stage on Load point for 30 seconds. The stage on load point is adjustable up to 50%. The default is 40% which means that a single compressor would have to load to 80% (the average would be 40%) before the second compressor

starts. Both compressors will run until chiller average capacity drops below Stage off Load point for 30 seconds. The stage off load point is also adjustable. Compressor 1 will be shut down and compressor 2 will run until water temperature drops below the differential to stop. Before shutting down, compressor 1 will be unloaded and compressor 2 will be loaded to maintain the same average capacity command.

If chilled water reset is used, the upstream compressor usually will be the most efficient compressor to operate at part load. If the leaving water temperature is reset and the chiller only needs one compressor, then the upstream compressor would be running closer to its selection point and will be the most efficient compressor to operate.

**Figure 13. CDHE/F/G sequence of operation: lead 2 lag 1**

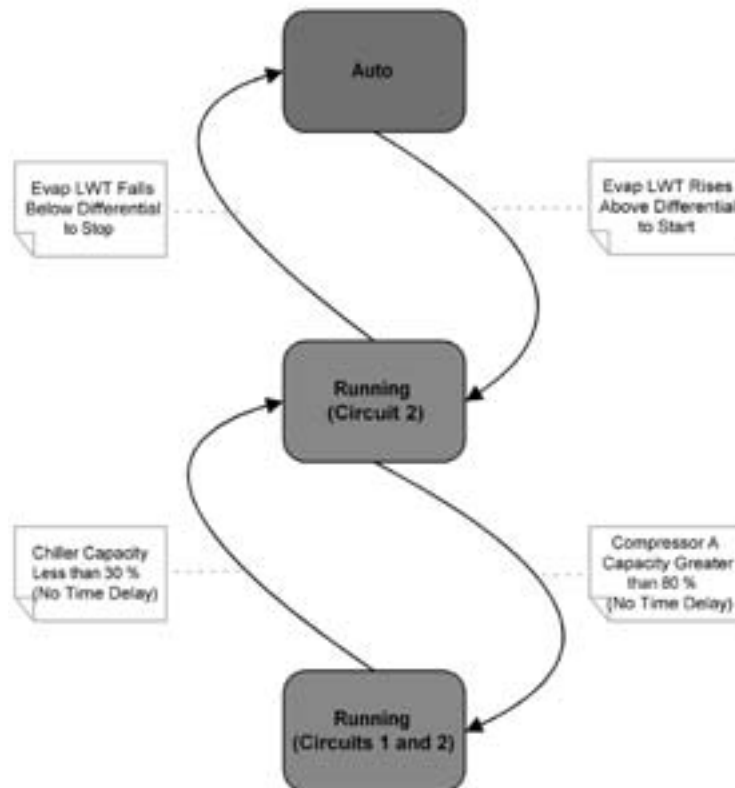

# General Information

## Sequencing - Balanced Starts and Hours

When desired to balance the wear between the compressors. This method will extend the time between maintenance on the lead compressor. When balanced starts and hours is selected, the compressor with the fewest starts will start. If that compressor is unavailable to start due to a circuit lockout (including

restart inhibit) or a circuit diagnostic, then the other compressor will be started. The second compressor will stage on when chiller capacity exceeds the Stage on Load point for 30 seconds. When chiller capacity falls below Stage off Load point for 30 seconds, the compressor with the most hours will be shut off.

**Figure 14. CDHF/G sequence of operation: equalize starts and hours**

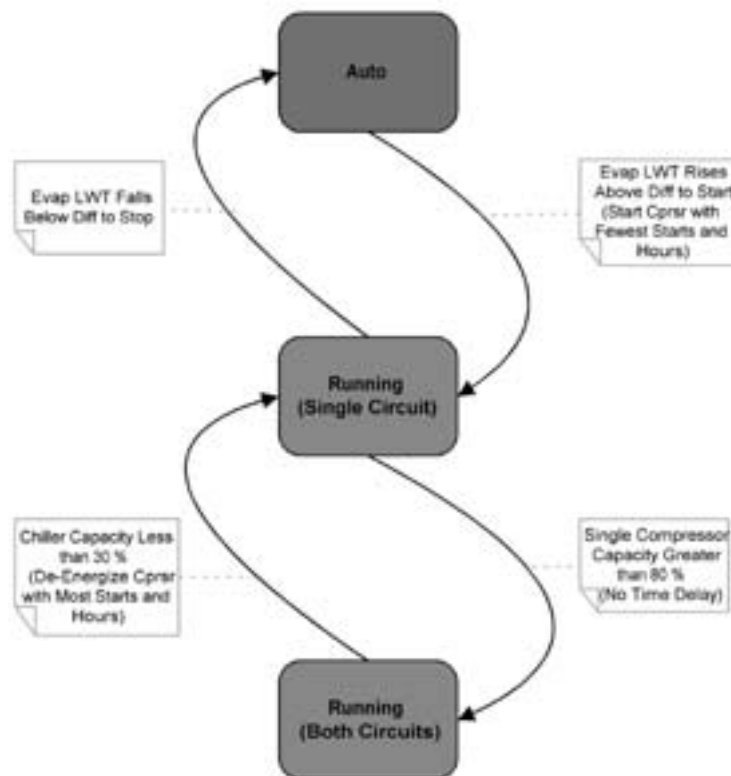

# General Information

## Simultaneous Compressor Start/ Stop

Both compressors will start in close succession to minimize the time it takes for the chiller to reach full load. Some process applications need the chiller to start and generate capacity as fast as possible. This method will start both compressors, slightly staggered to prevent doubling of the current inrush, but will generally control the chiller as if there were only one compressor.

If the chiller is in the Auto mode and all interlocks have been satisfied, compressor 1 will be started based on the leaving water temperature rising above the “Differential to Start” setting. When compressor 1 is at speed, compressor 2 will start. Both compressors will run until water temperature falls below the differential to stop, at that time both compressors will be shut down.

*Figure 15. CDHF/G sequence of operation: combined start*

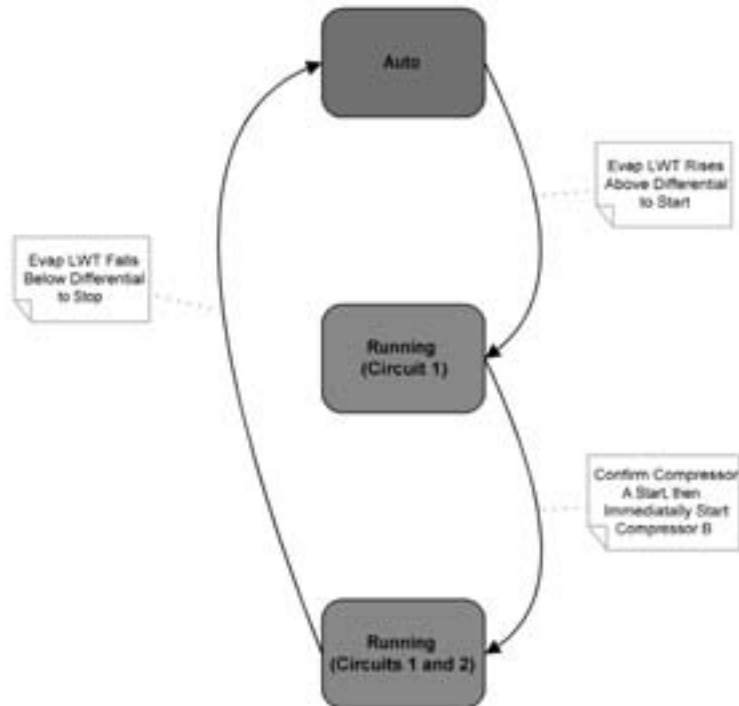

# General Information

---

## Compressor Load Balancing

Duplex chillers with CH530 control will balance the compressor load by giving each compressor the same load command. The load command will be converted to IGV position that will be the same on each compressor.

Balancing compressor load results in the best overall efficiency and with both circuits operating with nearly the same refrigerant pressures.

When both compressors are running the overall chiller load command will be split evenly between the two compressors unless limit control overrides balancing. When transitioning between one compressor operation and two-compressor operation, the load commands will be actively balanced at a rate slow enough to minimize capacity control disturbances

## Restart Inhibit

The purpose of restart inhibit feature is to provide short cycling protection for the motor and starter.

The operation of the restart inhibit function is dependent upon two setpoints. The Restart Inhibit Free Starts (1-5, 3 default), and the Restart Inhibit Start to Start Timer (10-30min, 20 default). These settings are adjustable via the service tool.

## Restart Inhibit Free Starts

This setting will allow a number of rapid restarts equal to its value. If the number of free starts is set to "1", this will allow only one start within the time period set by the Start to Start Time Setting. The next start will be allowed only after the start to start timer has expired. If the number of free starts is programmed to "3", the control will allow three starts in rapid succession, but thereafter, it would hold off on a compressor start until the Start to Start timer expired.

## Restart Inhibit Start to Start Time Setting

This setting defines the shortest chiller cycle period possible after the free starts have been used. If the number of free starts is programmed to "1", and the Start to Start Time Setting is programmed to 20 minutes, then the compressor will be allowed one start every 20 minutes. The start-to-start time is the time from when the motor was commanded to energize to when the next command to enter prestart is given.

## Clear Restart Inhibit

A Clear Restart Inhibit "button" is provided within Settings; Manual Override on the DynaView display. This provides a way for an operator to allow a compressor start when there is a currently active Restart Inhibit that is prohibiting such a start. The "button" press will have no other function than to remove the restart inhibit if there is one active. It does not change the count of any internal restart inhibit timers or accumulators.

The restart inhibit function, setpoints and clear features exist for each compressor and operate independently of other compressors on that chiller.

During the time the start is inhibited due to the start-to-start timer, the DynaView shall display the mode 'Restart Inhibit' and the also display the time remaining in the restart inhibit.

A "Restart Inhibit Invoked" warning diagnostic will exist when the attempted restart of a compressor is inhibited.

# General Information

---

## Oil and Refrigerant Pump

### Compressor Lubrication System -

A schematic diagram of the compressor lubrication system is illustrated in Figure 16. (This can be applied to circuit 1 or 2.)

Oil is pumped from the oil tank (by a pump and motor located within the tank) through an oil pressure-regulating valve designed to maintain a net oil pressure of 18 to 22 psid. It is then filtered and sent to the oil cooler located in the economizer and on to the bearings. From the bearings, the oil drains back to the manifold under the motor and then on to the oil tank.

### **WARNING**

## Surface Temperatures!

**MAY EXCEED 150°F. Use caution while working on certain areas of the unit, failure to do so may result in death or personal injury.**

To ensure proper lubrication and prevent refrigerant from condensing in the oil tank, a 750-watt heater is immersed in the oil tank and is used to warm the oil while the unit is off. When the unit starts, the oil heater is de-energized. This heater energizes as needed to maintain 140° to 145° F (60-63°C) when the chiller is not running.

When the chiller is operating, the temperature of the oil tank is typically 115° to 160°F (46-72°C). The oil return lines from the thrust and journal bearings, transport oil and some seal leakage refrigerant. The oil return lines are routed into a manifold under the motor. Gas flow exits the top of the manifold and is vented to the Evaporator.

**Note:** A vent line solenoid is not needed with the refrigerant pump. Oil exits the bottom of the manifold and returns to the tank. Separation of the seal leakage gas in the manifold keeps this gas out of the tank.

A dual eductor system is used to reclaim oil from the suction cover and the evaporator, and deposit it back into the oil tank. These eductors use high pressure condenser gas to draw the oil from the suction cover and evaporator to the eductors and then discharged into the oil tank. The evaporator eductor line has a shut off valve mounted by the evaporator and ships closed. Open two turns if necessary.

Liquid refrigerant is used to cool the oil supply to both the thrust bearing and journal bearings. On refrigerant pump units the oil cooler is located inside the economizer and uses refrigerant passing from the condenser to evaporator to cool the oil. Oil leaves the oil cooler and flows to both the thrust and journal bearings.

### Motor Cooling System

Compressor motors are cooled with liquid refrigerant, see Figure 16.

The refrigerant pump is located on the front of the oil tank (motor inside the oil tank). The refrigerant pump inlet is connected to the well at the bottom of the condenser. The connection is on the side where a weir assures a preferential supply of liquid. Refrigerant is delivered to the motor via the pump. Motor refrigerant drain lines are routed to the condenser.

# General Information

Figure 16. Oil refrigerant pump - circuit 1 or 2

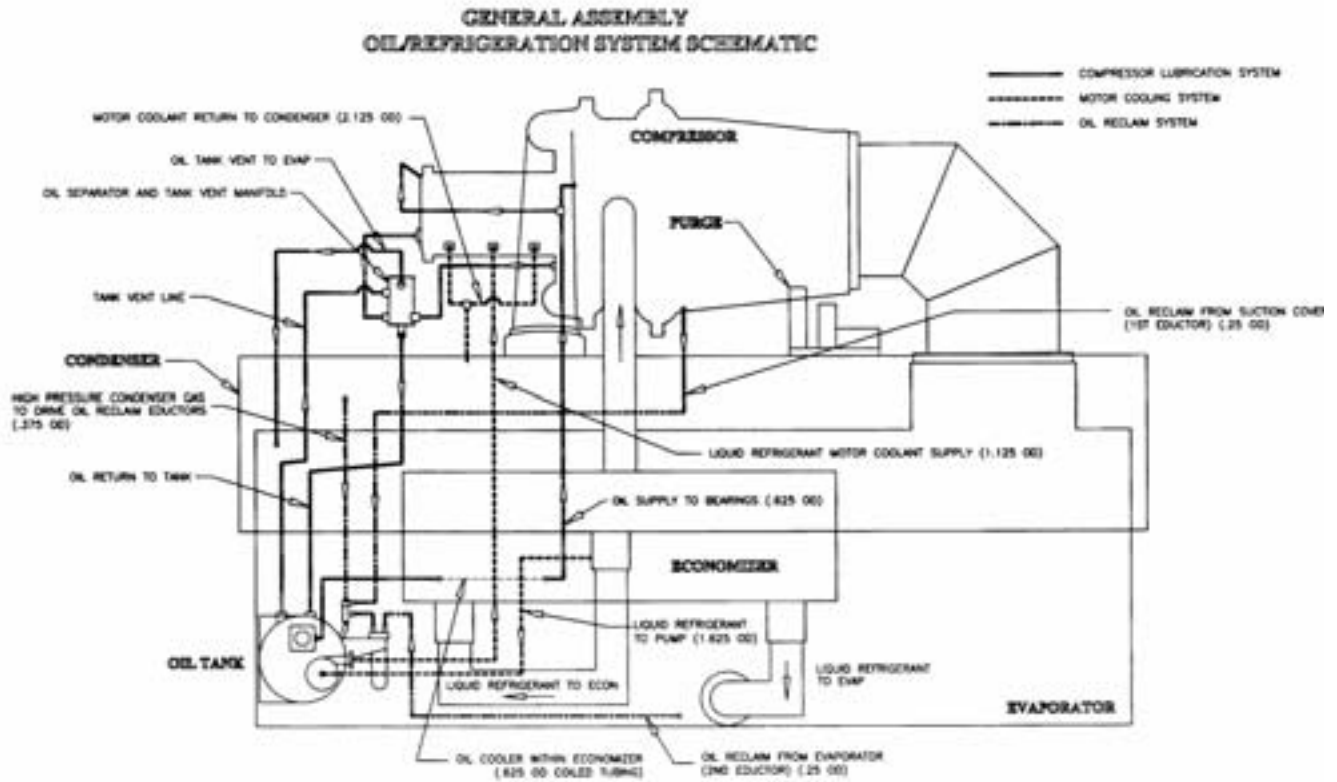

# General Information

---

## Base Loading Control Algorithm:

This feature allows an external controller to directly modulate the capacity of the chiller. It is typically used in applications where virtually infinite sources of evaporator load and condenser capacity are available and it is desirable to control the loading of the chiller. Two examples are industrial process applications and cogeneration plants. **Industrial process applications** might use this feature to impose a specific load on the facility's electrical system.

**Cogeneration plants** might use this feature to balance the system's heating, cooling and electrical generation.

All chiller safeties and adaptive control functions are in full effect when Base Loading control is enabled. If the chiller approaches full current, the evaporator temperature drops too low, or the condenser pressure rises too high, Tracer CH530 Adaptive Control logic limits the loading of the chiller to prevent the chiller from shutting down on a safety limit. These limits may prevent the chiller from reaching the load requested by the Base Loading signal.

Base Loading Control is basically a variation of the current limit algorithm. During base loading, the leaving water control algorithm provides a load command every 5 seconds. The current limit routine may limit the loading when the current is below setpoint. When the current is within the deadband of the setpoint the current limit algorithm holds against this loading command.

If the current exceeds the setpoint, the current limit algorithm unloads. The "Capacity Limited By High Current" message normally displayed while the current limit routine is active is suppressed while base loading.

Base loading can occur via Tracer, External signal, or front panel.

### Tracer Base Loading: Current Setpoint Range: (20 - 100) percent RLA Requires Tracer and Optional Tracer Communications Module (LLID)

The Tracer commands the chiller to enter the base load mode by sending the base load mode request. If the chiller is not running, it will start regardless of the differential to start (either chilled water or hot water). If the chiller is already running, it will continue to run regardless of the differential to stop (either chilled water or hot water), using the base load control algorithm. While the unit is running in base loading, it will report that status back to the Tracer by setting "Base Load Status = true" in the Tracer Status Byte. When the Tracer removes the base load mode request (sets the bit to 0). The unit will continue to run, using the normal chilled or hot water control algorithm, and will turn off, only when the differential to stop has been satisfied.

### External Base Loading: Current Setpoint Range: (20 - 100) percent RLA

The UCP accepts 2 inputs to work with external base loading. The binary input is at 1A18 Terminals J2-1 and J2-2 (Ground) which acts as a switch closure input to enter the base-loading mode. The second

input, an analog input, is at 1A17 terminals J2 - 1 and 3 (Ground) which sets the external base loading setpoint, and can be controlled by either a 2-10Vdc or 4-20ma Signal. At startup the input type is configured. The graphs in Figure 13 show the relationship between input and percent RLA. While in base loading the active current limit setpoint is set to the Tracer or external base load setpoint, providing that the base load setpoint is not equal to 0 (or out of range). If it is out of range, the front panel current limit setpoint is used. During base loading, all limits are enforced with the exception of current limit. The human interface displays the message "Unit is Running Base Loaded". Hot Gas Bypass is not run during base loading. If base loading and ice making are commanded simultaneously, ice making takes precedence.

An alternative and less radical approach to Base Loading indirectly controls chiller capacity. Artificially load the chiller by setting the chilled water setpoint lower than it is capable of achieving. Then, modify the chiller's load by adjusting the current limit setpoint. This method provides greater safety and control stability in the operation of the chiller because it has the advantage of leaving the chilled water temperature control logic in effect. The chilled water temperature control logic responds quicker to dramatic system changes, and can limit the chiller loading prior to reaching an Adaptive Control limit point.



# General Information

Figure 17. Base loading with external mA input and with external voltage input

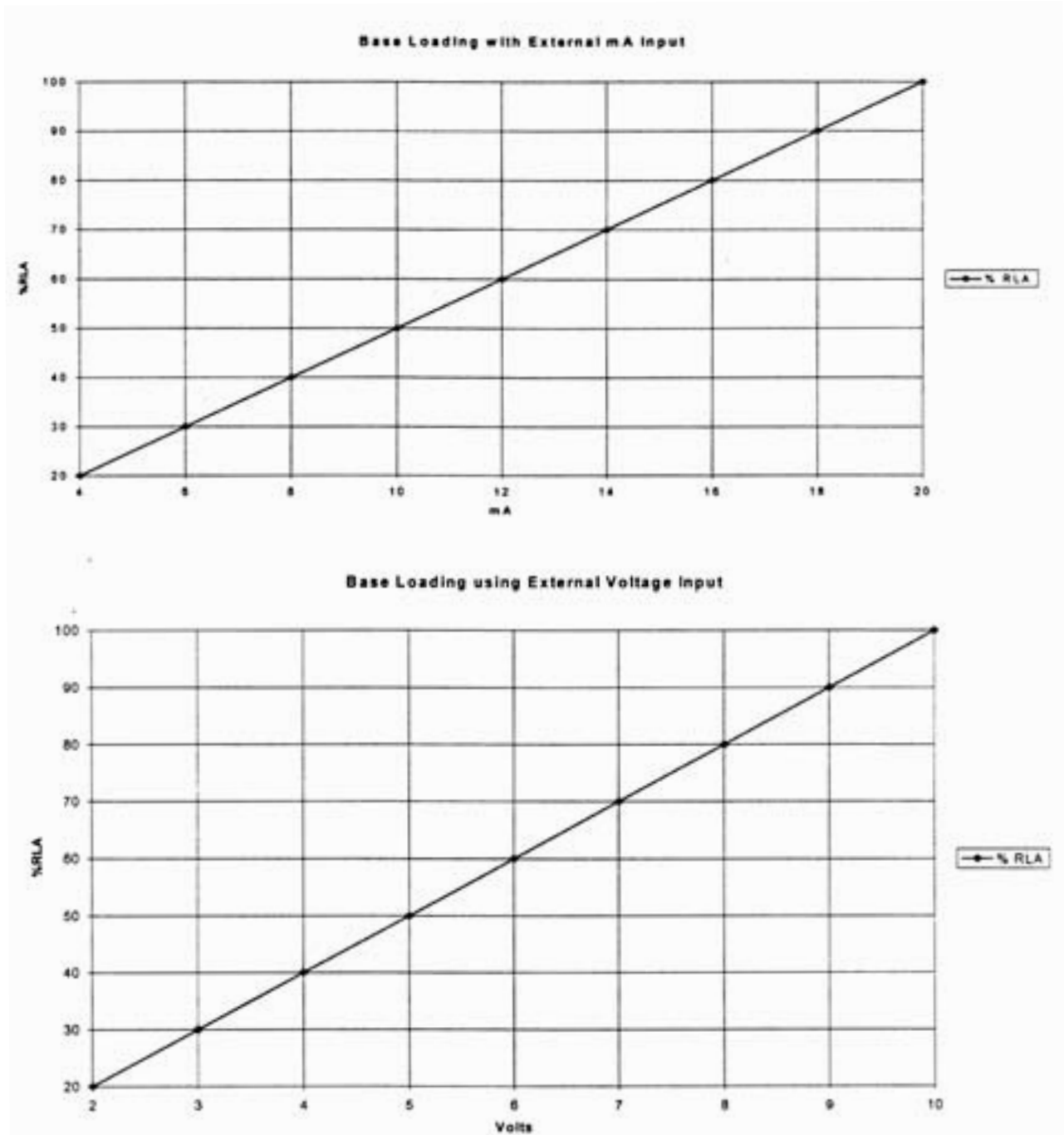

# General Information

## Ice Machine Control

UCP provides a service level "Enable or Disable" menu entry for the Ice Building feature when the Ice Building option is installed. Ice Building can be entered from "Front Panel", or if hardware is specified the UCP will accept either an isolated contact closure (1A19 Terminals J2-1 and J2-2 (Ground) ) or a remote communicated input (Tracer) to initiate the ice building mode where the unit runs fully loaded at all times. Ice building will be terminated either by opening the contact or based on entering evaporator fluid temperature. UCP will not permit the Ice Building mode to be entered again until the unit is switched to the Non-ice building mode and back into the ice building mode. It is not acceptable to reset the chilled water setpoint low to achieve a fully loaded compressor. When entering ice-building the compressor will be loaded at its maximum rate and when leaving ice building the compressor will be unloaded at its maximum rate. While loading and unloading the compressor, all surge detection will be ignored. While in the ice building mode, current limit setpoints less than the maximum will be ignored. Ice Building can be terminated by one of the following means:

1. Front panel disable.
2. Opening the external Ice. Contacts/ Remote communicated input (Tracer).
3. Satisfying an evaporator entering fluid temperature setpoint. (Default is 27°F)
4. Surging for 7 minutes at full open IGV.

Figure 18. Sequence of operation: ice making: running to ice making

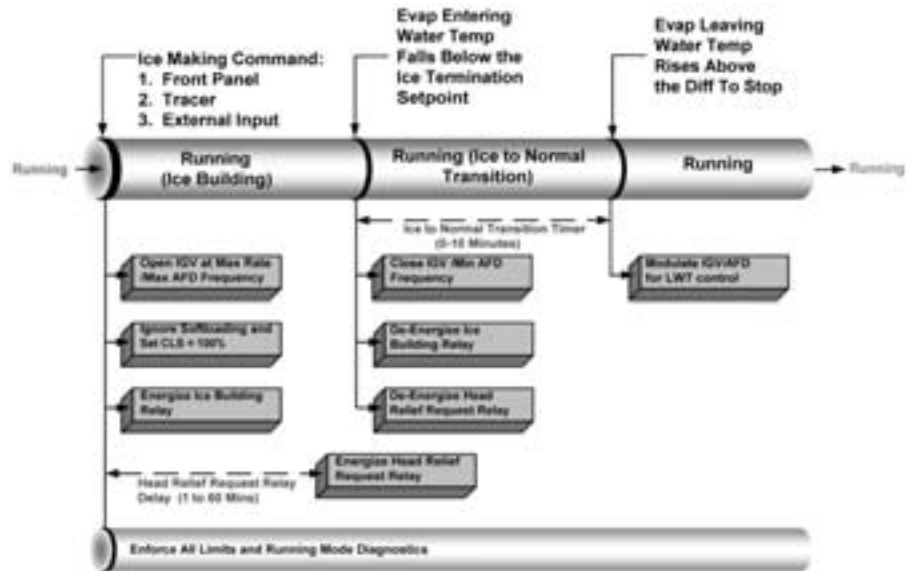
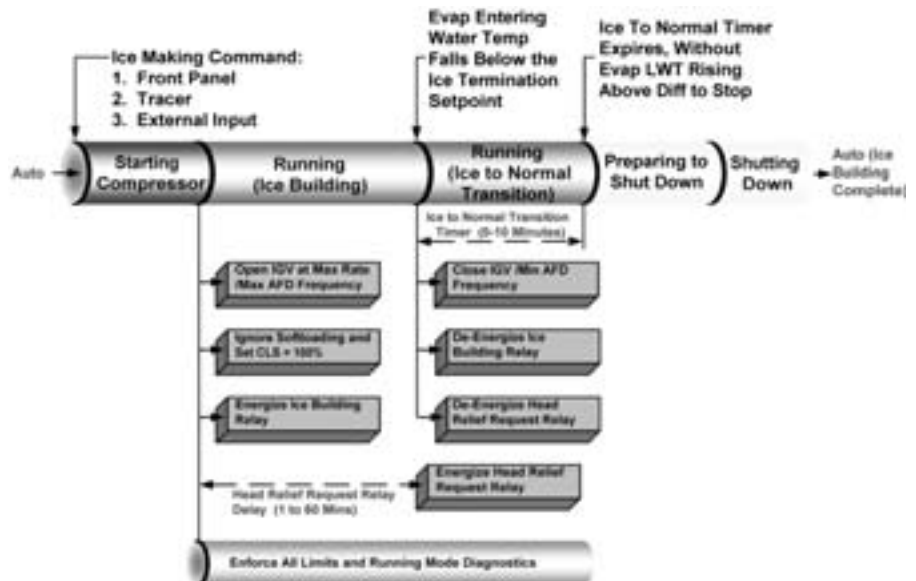

Figure 19. Sequence of operation: ice making: stopped to ice to ice building complete



# General Information

---

## Hot Water control

Occasionally CTV chillers are selected to provide heating as a primary mission. With hot water temperature control, the chiller can be used as a heating source or cooling source. This feature provides greater application flexibility. In this case the operator selects a hot water temperature and the chiller capacity is modulated to maintain the hot water setpoint. Heating is the primary mission and cooling is a waste product or is a secondary mission. This type of operation requires an endless source of evaporator load (heat), such as well or lake water. The chiller has only one condenser.

**Note:** Hot water temperature control mode does not convert the chiller to a heat pump. Heat pump refers to the capability to change from a cooling-driven application to a heating-driven application by changing the refrigerant path on the chiller. This is impractical for centrifugal chillers as it would be much easier to switch over the water side.

This is NOT heat recovery. Although this feature could be used to recover heat in some form, there's not a second heat exchanger on the condenser side.

The DynaView™ Main Processor provides the hot water temperature control mode as standard. The leaving condenser water temperature is controlled to a hot water setpoint between 80 and 140°F (26.7 to 60°C). The leaving evaporator water temperature is left to drift to satisfy the heating load of the condenser. In this application the evaporator is normally piped into a lake, well, or other source of constant temperature water for the purpose of extracting heat.

In hot water temperature control mode all the limit modes and diagnostics operate as in normal cooling with one exception; The leaving condenser water temperature sensor is an MMR diagnostic when in hot water temperature control mode. (It is an informational warning in the normal cooling mode.)

In the hot water temperature control mode the differential-to-start and differential-to-stop setpoints are used with respect to the hot water setpoint instead of with the chilled water setpoint.

UCP provides a separate entry at the DV to set the hot water setpoint. Tracer is also able to set the hot water setpoint. In the hot water mode

the external chilled water setpoint is the external hot water setpoint; that is, a single analog input is shared at the 1A16 –J2-1 to J2-3 (ground)

An external binary input to select external hot water control mode is on the EXOP OPTIONAL module 1A18 terminals J2-3 to J2-4 (ground). Tracer also has a binary input to select chilled water control or hot water temperature control.

There is no additional leaving hot water temperature cutout; the HPC and condenser limit provide for high temperature and pressure protection.

In hot water temperature control the softloading pulldown rate limit operates as a softloading pullup rate limit. The setpoint for setting the temperature rate limit is the same setpoint for normal cooling as it is for hot water temperature control.

The hot water temperature control feature is not designed to run with HGBP, AFD, or ice making.

The factory set PID tuning values for the leaving water temperature control are the same settings for both normal cooling and hot water temperature control.

# Unit Control Panel (UCP)

---

## Control Panel Devices and Unit Mounted Devices

### Unit Control Panel (UCP)

Safety and operating controls are housed in the unit control panel, the starter panel and the purge control panel. The UCP's operator interface and main processor is called the DynaView™ (DV) and is located on the UCP door. (See Operators interface section for detailed information)

The UCP houses several other controls modules called panel mounted LLID (Low Level Intelligent Device), power supply, terminal block, fuse, circuit breakers, and transformer. The IPC (Interprocessor communication) bus provides communication between LLID's and the main processor. Unit mounted devices are called frame mounted LLID's and can be temperature sensors or pressure transducers, vane actuator. These and other functional switches provide analog and binary inputs to the control system.

*Figure 20. Left control panel*

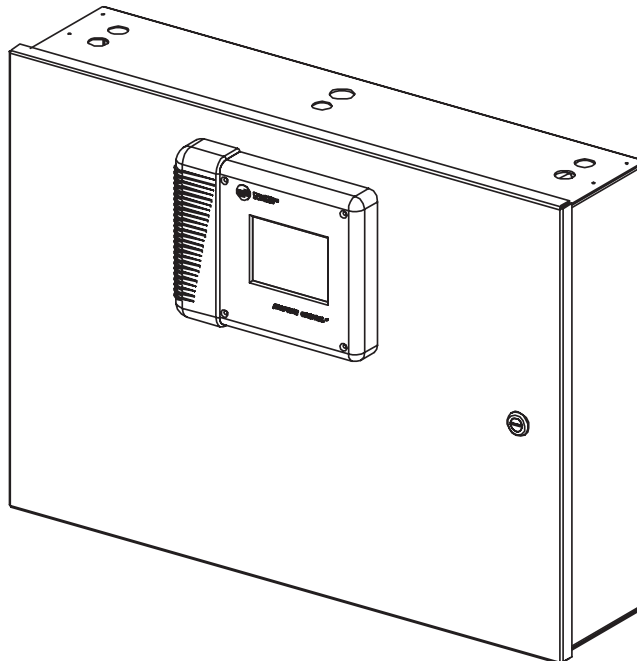

STANDARD ENCLOSURE

# Unit Control Panel (UCP)

---

## Tracer CH530 Chiller Controller

Revolutionary control of the chiller, chilled water system, and your entire building with unprecedented accuracy, reliability, efficiency, and support for maintenance using the chiller's PC-based service tool. Chiller reliability is all about producing chilled water and keeping it flowing, even when facing conditions that ordinarily would shut down the chiller — conditions that often happen when you need cooling the most.

Tracer CH530's Main Processor, DynaView™, is fast and keeps the chiller online whenever possible. Smart sensors collect three rounds of data per second, 55 times the data collection speed of its predecessor. Each device (a sensor) has its own microprocessor that simultaneously converts and accurately calibrates its own readings from analog to digital.

Because all devices are communicating digitally with the DynaView™ main processor, there is no need for the main processor to convert each analog signal one at a time. This distributed logic allows the main processor to focus on responding to changing conditions — in the load, the machine, its ancillary equipment, or its power supply. Tracer CH530 constantly receives information about key data parameters, temperatures and

current. Every five seconds then a multiple objective algorithm compares each parameter to its programmed limit. The chiller's Adaptive Control™ capabilities maintain overall system performance by keeping its peak efficiency. Whenever the controller senses a situation that might trigger a protective shutdown, it focuses on bringing the critical parameter back into control. When the parameter is no longer critical, the controller switches its objective back to controlling the chilled water temperature, or to another more critical parameter should it exist.

### Variable water flow through the evaporator

Chilled-water systems that vary water flow through chiller evaporators have caught the attention of engineers, contractors, building owners, and operators. Varying the water flow reduces the energy consumed by pumps, while requiring no extra energy for the chiller. This strategy can be a significant source of energy savings, depending on the application. With its faster and more intelligent response to changing

conditions, Tracer CH530 water flow sensing option accommodates variable evaporator water flow and its effect on the chilled water temperature. These improvements keep chilled water flowing at a temperature closer to its setpoint.

### User-defined language support

DynaView™ is capable of displaying English text or one of the two alternate languages that are stored in DynaView™ at one time. Switching languages is simply accomplished from a settings menu.

Similarly, TechView™ accommodates a primary and a secondary language from the same list of available languages.

# Operator Interface

Figure 21. DynaView™ main processor



DynaView™ presents three menu tabs across the top which are labeled “MAIN, REPORTS, and SETTINGS”.

The **Main screen** provides an overall high level chiller status so the operator can quickly understand the mode of operation of the chiller.

The Chiller Operating Mode will present a top level indication of the chiller mode (Auto, Running, Inhibit, Run Inhibit, etc.) The “additional information” icon (arrow) will present a subscreen that lists in further detail the subsystem modes. (See Machine Operating Modes.)

Main screen content can be viewed by selecting the up or down arrow icons. The Main screen is the default screen and after an idle time of 30 minutes.

The DynaView™ (DV) Operator Interface contains the “Main Processor (MP)” and is mounted on the unit control panel front door where it communicates commands to other modules, collecting data, status and diagnostic information from the other modules over the IPC (Inter Processor Communications) link. The Main Processor (MP) software controls water flows by starting pumps and sensing flow inputs, establishes a need to heat or cool, performs pre-lube, performing post-lube, starts the compressor(s), performs water temperature control, establishes limits, and pre-positions the inlet guide-vanes.

The MP contains non-volatile memory both checking for valid set points and retaining them on any power loss. System data from modules (LLID) can be viewed at the DynaView™ operator interface. Such as evaporator and condenser water temperatures, outdoor air temperature, evaporator and condenser water pump control, status and alarm relays, external auto-stop, emergency stop, evaporator and condenser water pressure drops and evaporator and condenser water flow switches.

# Operator Interface

---

DynaView™ (DV) is the **operator interface** of the Tracer CH530 control system utilized on the CTV machine. The DynaView™ enclosure is 9.75" wide, 8" high and 1.6" deep. The DynaView™ display is approximately 4" wide by 3" high. Features of the display include a touch screen and long life LED backlight. This device is capable of operating in 0 - 95 percent relative humidity (non-condensing), and is designed and tested with UV considerations consistent with an outdoor application in direct sunlight. The enclosure includes a weather tight connection means for the RS232 service tool connection.

**Touch screen key functions** are determined completely in the software and change depending upon the subject matter currently being displayed. The user operates the touch sensitive buttons by touching the button of choice. The selected button is darkened to indicate it is the selected choice. The advantage of touch sensitive buttons is that the full range of possible choices as well as the current choice is always in view.

**Spin values** (up or down) are a graphical user interface model used to allow a continuously variable setpoint, such as leaving water setpoint to be changed. The value changes by touching the increment or decrement arrows.

Action buttons are buttons that appear temporarily and provide the operator with a choice such as **Enter** or **Cancel**. The operator indicates his choice by touching the button of choice. The system then takes the appropriate action and the button typically disappears.

DynaView™ consists of various screens, each meant to serve a unique purpose of the machine being served. **Tabs** are shown across the top of the display. The user selects a screen of information by touching the appropriate tab. The folder that is selected will be brought to the front so it's contents are visible

The main body of the screen is used for description text, data, setpoints, or keys (touch sensitive areas) The **double up arrows** cause a page by page scroll either up or down. The **single arrow** causes a line by line scroll to occur. At the end of the screen, the appropriate scroll buttons will disappear. Wrap around will not occur.

The bottom of the screen is the persistent area. It is present in all screens and performs the following functions. The **left circular area** is used to reduce the contrast and viewing angle of the display. The **right circular area** is used to increase the contrast and viewing angle of the display. The contrast control will be limited to avoid complete "light" or complete "dark", which would potentially confuse an unfamiliar user to thinking the display was malfunctioning.



# Operator Interface

The **Auto** and **Stop** keys are used to put the unit into the auto or stop modes. Key selection is indicated by being darkened (reverse video).

The **Alarms** button is to the right of the **Stop** key. The **Alarms** button appears only when alarm information is present. The alarm blinks to draw attention to the shutdown diagnostic condition. Blinking is defined as normal versus reverse video. Pressing on the **Alarms** button takes you to the corresponding screen.

**Persistent keys**, horizontal at the bottom of the display, are those keys that must be available for operation regardless of the screen currently being displayed. These keys are critical for machine operation. The **Auto and Stop** keys will be presented as radio buttons within the persistent key display area. The

selected key will be dark. The chiller will stop when the **Stop** key is touched, entering the stop sequence. Pressing the "Immediate Stop" button will cause the chiller to stop immediately.

The AUTO and STOP, take precedence over the ENTER and CANCEL keys. (While a setting is being changed, AUTO and STOP keys are recognized even if ENTER or CANCEL has not been pressed. Selecting the Auto key will enable the chiller for active cooling ( if no diagnostic is present.)

### Chiller Stop Prevention/Inhibit Feature

A new chiller "Stop prevention/inhibit" feature allows a user to prevent an inadvertent chiller stop from the DynaView screen for those chillers which are solely controlled by the CH530.

### How It Works

This new feature will be activated after the service tech sets a variable shut down timer in TechView to be greater than 0 seconds and up to 20 seconds (i.e.  $0 < \text{Timer} \leq 20$ ). Then, when the user presses the 'STOP' button on the DynaView display and initiates a chiller shutdown, a window will now appear that displays the "Unit Stop Information Screen" as shown below.

TechView service tool is utilized to enable this feature.





# Operator Interface

Figure 22



The **machine-operating mode** indicates the operational status of the chiller. A subscreen with additional mode summary information will be provided. When the user scrolls down the screen the Machine Operation Mode will remain stationary

On DynaView™, the user will be presented with a single line of text that represents the ‘top-level’ operating state of the machine. These top-level modes are shown in the table below. Additional information (if it exists) regarding the machine operating state will be available to the user by selecting the “additional information” button (double right arrow) next to the top-level operating mode. These sub-level modes are shown in the table at left.

The TOP LEVEL MODE is the text seen on the single top level chiller system operating mode line. The SUB LEVEL MODE is the text seen on the operating mode sub-menu. The operating mode sub-menu may have up to six (6) lines of text displayed. The BAS CODE is the code that will be sent via COMM4 to the Tracer Summit system as the chiller system mode. Note that each top level mode may contain multiple sub level modes. In general, the BAS CODE will reflect the top level mode and not the sub level mode.

**A general description of the top level modes is show in the following table.**

Top Level Mode	Description
Stopped	Unit inhibited from running and will require user action to go to Auto.
Run Inhibit	Unit inhibited from running by Tracer, External BAS, or an Auto Reset diagnostic.
Auto	Unit determining if there is a need to run.
Waiting To Start	Unit waiting for tasks required prior to compressor start to be completed.
Starting Compressor	Unit is starting compressor.
Running	Compressor is running with no limits in effect.
Running – Limit	Compressor is running with limit in effect.
Preparing To Shutdown	Unit is closing inlet guide vanes prior to compressor shutdown.
Shutting Down	Compressor has been stopped and unit is performing shutdown tasks.



# Operator Interface

Figure 23

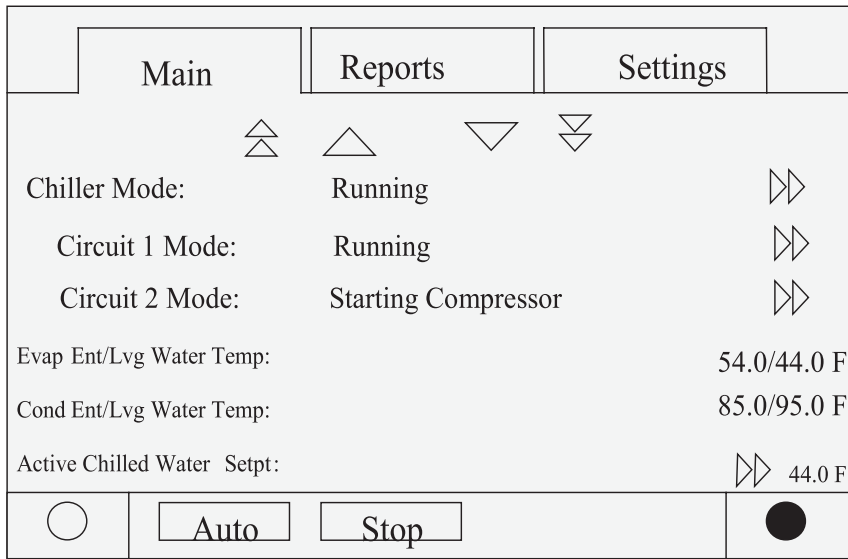

Main Screen – Duplex CTV

Top Level Mode	Sub Level Mode	Reference BAS Code
SYSTEM RESET	Boot & Application software part number, self-test, and configuration validity screens will be present.	NA
Stopped	Local Stop	00
Stopped	Panic Stop	00
Stopped	Diagnostic Shutdown – Manual Reset	00
Run Inhibit	Ice Building Is Complete	100
Run Inhibit	Tracer Inhibit	100
Run Inhibit	External Source Inhibit	100
Run Inhibit	Diagnostic Shutdown – Auto Reset	100
Auto	Waiting For Evaporator Water Flow	58
Auto	Waiting For A Need To Cool	58
Auto	Waiting For A Need To Heat	58
Auto	Power Up Delay Inhibit: MIN:SEC	58
Waiting To Start	Waiting For Condenser Water Flow	70
Waiting To Start	Establishing Oil Pressure	70
Waiting To Start	Pre-Lubrication Time: MIN:SEC	70

# Operator Interface

Top Level Mode	Sub Level Mode	Reference BAS Code
Waiting To Start	Motor Temperature Inhibit: Motor Temperature / Inhibit Temperature	70
Waiting To Start	Restart Time Inhibit: MIN:SEC	70
Waiting To Start	High Vacuum Inhibit: Oil Sump Press / Inhibit Press	70
Waiting To Start	Low Oil Temperature Inhibit: Oil Temperature / Inhibit Temperature	70
Waiting To Start	Waiting For Starter To Start: MIN:SEC	70
Starting Compressor	There is no sub mode displayed	72
Running	There is no sub mode displayed	74
Running	Hot Water Control	74
Running	Surge	74
Running	Base Loaded	74
Running	Ice Building	74
Running	Ice To Normal Transition	74
Running	Current Control Soft Loading	74
Running	Capacity Control Soft Loading	74
Running – Limit	Current Limit	75
Running – Limit	Phase Unbalance Limit	75
Running – Limit	Condenser Pressure Limit	75
Running – Limit	Evaporator Temperature Limit	75
Running – Limit	Minimum Capacity Limit	75
Running – Limit	Maximum Capacity Limit	75
Preparing To Shutdown	Closing IGV: IGV Position %	7E
Shutting Down	Post-Lubrication Time: MIN:SEC	7E
Shutting Down	Evaporator Pump Off Delay: MIN:SEC	7E
Shutting Down	Condenser Pump Off Delay: MIN:SEC	7E



# Operator Interface

## Main Screen

The main screen is provides “an overall view” of the chiller performance in addition to the main and sub operating modes. The table below indicates other items found , when specified by options, that can be scrolled to via the up or down arrows.

**Main Screen Data Fields Table**

Description	Units	Resolution	Dependencies
1. Chiller Mode (>> submodes)			
2. Circuit 1 Mode (>> submodes)			
3. Circuit 2 Mode (>> submodes)			
4. Evap Ent/Lvg Water Temp	F / C	0.1	
5. Cond Ent/Lvg Water Temp	F / C	0.1	
6. Active Chilled Water Setpoint (>>source)	F / C	0.1	
7. Active Hot Wtr Setpoint (>>source)	F / C	0.1	If in heat installed
8. Active Current Limit Setpoint (>>source)	% RLA	1	
9. Active Base Loading Setpoint (>>source)	%	1	If enabled
10. Circuit 1 Purge Mode (status, i.e. on, off, adaptive, auto))	See modes in purge manual	Enum	
11. Circuit 2 Purge Mode (status, i.e. on, off, adaptive, auto))	See modes in purge manual	Enum	
12. Approx Chiller Capacity	Tons / kW	XXX	If option installed
13. Active Ice Termination Setpoint (>>source)	F / C	0.1	If option installed
14. Software Version		0.XX	

## Chiller Operating Mode

The machine-operating mode indicates the operational status of the chiller. A subscreen with additional mode summary information will be provided by selection of an additional information icon (>>). The operating mode lines will remain stationary while the remaining status items scroll with the up/down arrow keys.

## Circuit Operating Mode

The circuit-operating modes indicate the operational status of the circuits. A subscreen with additional mode summary information will be provided by selection of an additional information icon (>>). The operating mode lines will remain stationary while the remaining status items scroll with the up/down arrow keys.

# Operator Interface

---

## Diagnostic Screen

The **diagnostic screen** is accessible by touching the **Alarms** enunciator.

When an alarm is present, the alarm enunciator is present next to the Stop key. A flashing “alarm” indicates a machine shutdown and a non flashing “alarm” indicates an informational message.

Machine shutdowns can be of two types:

Latching - Machine Shutdown  
Manual Reset Required (MMR)

or

Non-Latching - Machine Shutdown  
Auto Reset (MAR)

Latching (MMR) require corrective action and manual reset.

Non-Latching (MAR) will restart automatically when condition corrects itself.

There are over 200 potential messages, too numerous to incorporate in this manual.

Up to ten active diagnostics can be displayed if required.

The reason for all diagnostics must be determined and corrected. Do not reset and restart the chiller as this can cause a repeat failure. Contact local Trane Service for assistance as necessary.

After corrective action, the chiller can be reset and/or restarted. In the case of “Unit Shutdown - Reset Required” diagnostic types, the chiller will have to be manually reset through the Diagnostics alarm menu.

When reset they become historic and viewable via the service tool TechView.

Performing a **Reset All Active Diagnostics** will reset all active diagnostics regardless of type, machine or refrigerant circuit.

A **Manual Override** indicator (shares space with the Alarms key) alerts the operator to the presence of a manual override. An Alarm will take precedence over any manual override, until the reset of active alarms, at which point the Manual indicator would reappear if such an override exists.

**Temperature settings** can be expressed in F or C, depending on Display Units settings.

Dashes (“---”) appearing in a temperature or pressure report, indicates that the value is invalid or not applicable.

The **languages** for DynaView™ will reside in the main processor. The main processor will hold three languages, English, and two alternate languages. The service tool (TechView™) will load the main processor with user selected languages from a list of available translations. Whenever possible, complete words will be used on the persistent keys as described.

# Operator Interface

 Back		
Active Chilled Water Setpoint Arbitration		
Front Panel	44.0 F	Active / Blank
BAS	48.0 F / ----	Active / Blank
External	42.0 F / ----	Active / Blank
Chilled Water Reset	Return / Constant Return / Outdoor / None	
Active Chilled Water Setpoint		44.0 F
○	Auto	Stop
		●

The **active chilled water setpoint** is the setpoint that is currently in use. It will be displayed to 0.1 degrees Fahrenheit or Celsius. Touching the **double arrow** to the left of the Active Chilled Water Setpoint will take the user to the active chilled water setpoint arbitration sub-screen.

**The Active Chilled Water Setpoint** the result of arbitration between the front panel, BAS, and external setpoints,

The **chilled water reset status** area in the right most column will display one of the following messages: Return, Constant Return, Outdoor, None

The left column text "Front Panel", "BAS", "External", Chilled Water Reset, and "Active Chilled Water Setpoint" will always be present regardless of installation or enabling those optional items. In the second column "----" will be shown if that option is Not Installed, otherwise the current setpoint from that source will be shown.

The **"Back" button** provides navigation back to the chiller screen.

# Operator Interface

 Back		
Active Current Limit Setpoint Arbitration		
Front Panel	100 %	Active / Blank
BAS	80 % / ----	Active / Blank
External	70 % / ----	Active / Blank
<hr/>		
Active Current Limit Setpoint		100 %
<input type="radio"/>	<input type="button" value="Auto"/>	<input type="button" value="Stop"/>
		<input checked="" type="radio"/>

The **active current limit setpoint** is the current limit setpoint that is currently in use. It will be displayed in percent RLA. Touching the double arrow to the left of the Active Current Limit Setpoint will take the user to the active current limit setpoint sub-screen. The active current limit setpoint is that setpoint to which the unit is currently controlling. It is the result of arbitration between the front panel, BAS, and external setpoints.

The left column text "Front Panel", "BAS", "External", and "Active Current Limit Setpoint" will always be present regardless of installation or enabling those optional items. In the second column "----" will be shown if that option is Not Installed, otherwise the current setpoint from that source will be shown. The "Back" button provides navigation back to the chiller screen.

**Note:** This is the same for other setpoints in the "Main" menu.

# Operator Interface

## Reports

Main	Reports	Settings
Evaporator		⇨
Condenser		⇨
Compressor		⇨
Motor		⇨
Purge		⇨
Ashrae Guideline Log		⇨
○	Auto	Stop
		●

To aid in comparing the status of both circuits, the heading on the Reports list screen has buttons as indicated in the table above (i.e., System, Ckt1, and Ckt2). The selected button is darkened, presented in reverse video, or some how changed to indicate it is the selected choice.

When a report screen is selected, the appropriate circuit is displayed in the screen heading as shown in the sample evaporator screen below:

◀	Back	System	Ckt 1	Ckt 2
Evap Sat Rfgt Temp:			40.3	F
Evap Rfgt Pressure:			9.7	psia
Evap Approach:			6.6	F
○	Auto	Stop		●

### Report Menu

Description	Heading Buttons
1. Evaporator	System, Ckt 1, Ckt 2
2. Condenser	System, Ckt 1, Ckt 2
3. Compressor	Ckt 1, Ckt 2
4. Motor	Ckt 1, Ckt 2
5. Purge	Ckt 1, Ckt 2
6. ASHRAE Chiller Log	System, Ckt 1, Ckt 2



# Operator Interface

## Report name: System Evaporator

Description	Resolution	Units	Dependencies
1. Evap Entering Water Temp	+ or – XXX.X	Temperature	
2. Evap Leaving Water Temp	+ or – XXX.X	Temperature	
3. Evap Water Flow Switch Status	(Flow, No Flow)		
4. Evap Differential Wtr Press	XXX.X	Diff Pressure	If option installed
5. Approx Evap Water Flow	XXXX	Flow	If option installed
6. Approx Chiller Capacity	XXXX	Tons	If option installed

## Report name: Circuit Evaporator

Description	Resolution	Units	Dependencies
1. Evap Sat Rfgt Temp	+ or – XXX.X	Temperature	
2. Evap Rfgt Pressure	XXX.X	Pressure	
3. Evap Approach Temp	+ or – XXX.X	Temperature	

## Report name: System Condenser

Description	Resolution	Units	Dependencies
1. Cond Entering Water Temp	+ or – XXX.X	Temperature	
2. Cond Leaving Water Temp	+ or – XXX.X	Temperature	
3. Cond Water Flow Switch Status	(Flow, No Flow)		
4. Cond Differential Wtr Press	XXX.X	Diff Pressure	If option installed
5. Approx Cond Water Flow	XXXX	Flow	If option installed
6. Outdoor Air Temperature	+ or – XXX.X	Temperature	If option installed

## Report name: Circuit Condenser

Description	Resolution	Units	Dependencies
1. Cond Sat Rfgt Temp	+ or – XXX.X	Temperature	
2. Cond Rfgt Pressure	XXX.X	Pressure	
3. Cond Approach Temp	+ or – XXX.X	Temperature	

**Note:** Approach temperatures shown are the mathematical difference between the chiller leaving water temperature and the corresponding saturated refrigerant temperature of same circuit. When one compressor is operational the approach value will be similar to those values found on single compressor models. However when both compressors are operating, the upstream compressor circuits approach will be the mathematical difference of the upstream chillers refrigerant temperature and the leaving water temperature after the down stream chillers circuit. Therefore the approach of the upstream circuit will be a negative number in many instances, when both compressors are operating.



# Operator Interface

## Report name: System ASHRAE Chiller Log

Description	Resolution	Units	Dependencies
1. Current Time/Date	XX:XX mmm dd, yyyy	Date / Time	
2. Chiller Mode:		Enum	
3. Active Chilled Water Setpoint:	XXX.X	Temperature	
4. Active Current Limit Setpoint:	XXX	% RLA	
5. Refrigerant Type:		Enum	
6. Refrigerant Monitor:	XXX.X	PPM	If option installed
7. Evap Entering Water Temp:	XXX.X	Temperature	
8. Evap Leaving Water Temp:	XXX.X	Temperature	
9. Evap Water Flow Switch Status:		Enum	If option not installed
10. Evap Differential Wtr Press:	XXX.X	Diff Pressure	If option installed
11. Approx Evap Water Flow:	XXX.X	GPM/LPM	If option installed
12. Approx Chiller Capacity:	XXXX	Capacity	If option installed
13. Cond Entering Water Temp:	XXX.X	Temperature	
14. Cond Leaving Water Temp:	XXX.X	Temperature	
15. Cond Water Flow Switch Status:		Enum	If option not installed
16. Cond Differential Wtr Press:	XXX.X	Pressure	
17. Approx. Cond Water Flow:	XXXX	Flow	If option installed

## Report name: Circuit ASHRAE Chiller Log

Description	Resolution	Units	Dependencies
1. Circuit Operating Mode:		Enum	
2. Amps L1 L2 L3	XXXX	Amps	XXX.X if less than 1000 Amps
3. Volts AB BC CA	XXXX	Volts	
4. Purge Daily Pumpout -24 Hrs:	XXX.X	Min	
5. Purge Daily Pumpout Limit/Alarm	XXX.X	Min	
6. Purge Pumpout - Life	XXXXXXXX.X	Min	
7. Purge Operating Mode:		Enum	
8. Purge Status:		Enum	
9. Compressor Starts:	XXXX	Integer	
10. Compressor Running Time:	XX:XX	Hours:Minute	
11. Compressor Rfqt Discharge Temp:	XXX.X	Temperature	If option installed
12. Oil Pump Discharge Pressure:	XXX.X	Pressure	
13. Oil Tank Pressure:	XXX.X	Pressure	
14. Differential Oil Pressure:	XXX.X	Diff Pressure	
15. Oil Tank Temp:	XXX.X	Temperature	
16. Inboard Bearing Temp:	XXX.X	Temperature	If option installed
17. Outboard Bearing Temp:	XXX.X	Temperature	If option installed
18. Evap Sat Refrigerant Temp:	XXX.X	Temperature	
19. Evap Rfqt Pressure:	XXX.X	Pressure	
20. Evap Approach Temp:	XXX.X	Temperature	
21. Cond Sat Rfqt Temp:	XXX.X	Temperature	
22. Cond Rfqt Pressure:	XXX.X	Pressure	
23. Condenser Approach Temp:	XXX.X	Temperature	

## Historic Diagnostics Log

1 to 20 Historic Diagnostics (main processor 2.0 and later)

# Operator Interface

**Setting Tab screens** provides a user the ability to adjust settings justified to support daily tasks. The layout provides a list of sub-menus, organized by typical subsystem.

To change chilled water setpoint, first select the settings tab screen. Chilled water setpoint to within the chiller sub-menu. (See next page for setpoint listing.)

Settings screen for standard CTV :

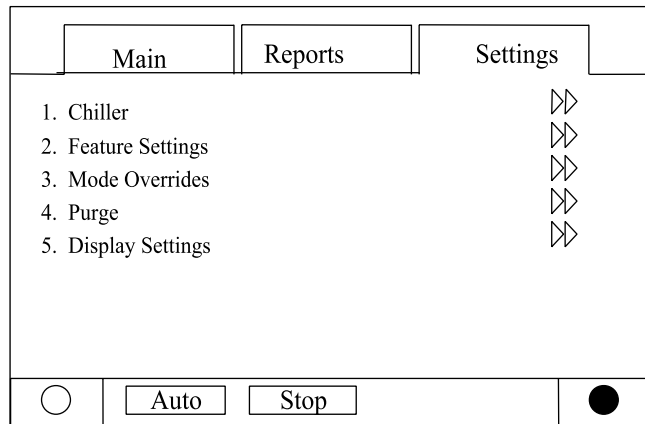

Setpoint Menu – standard CTV

Upon selecting a Settings list (i.e. Chiller, Circuit 1 Purge, System Mode Override, etc.) a listing of all setpoints available to change along with their current value will appear. The operator selects a setpoint to change by touching either the verbal description or setpoint value. Doing this causes the screen to switch to either the Analog Settings Subscreen or the Enumerated Settings Subscreen.

### Header Screen

To aid in comparing circuit level setpoints, the heading on the Settings list have buttons as indicated in the table above (i.e., Ckt1 and Ckt2). The selected button is darkened, presented in reverse video, to indicate it is the selected choice.

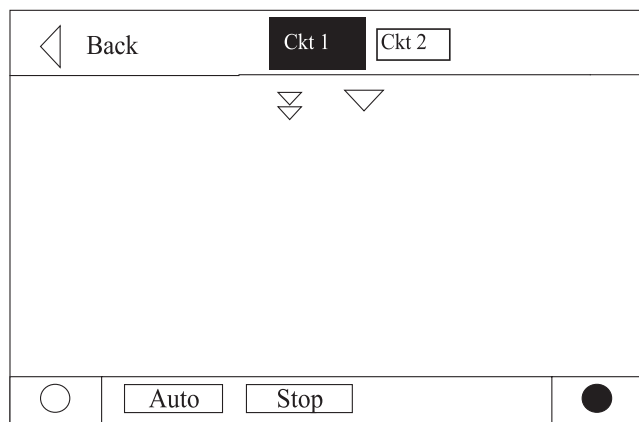

Settings Screen A



# Operator Interface

## Chiller

Description	Resolution or (Enumerations), Default	Units
1. Front Panel Control Type	(Chilled Water, Hot Water), Chilled Water	Enum
2. Front Panel Chilled Water Setpt	(3) + or – XXX.X	Temperature
3. Front Panel Hot Water Setpt	(3) + or – XXX.X	Temperature
4. Front Panel Current Limit Setpt	XXX (4)	Percent RLA
5. Front Panel Base Load Cmd	On/Auto	enum
6. Front Panel Base Load Setpt	XXX	Percent
7. Front Panel Ice Build Cmd	On/Auto	Enum
8. Front Panel Ice Termn Setpt	XXX.X	Temperature
9. Ice to Normal Cool Timer Setpt	(0-10), 5 min	Minutes
10. Differential to Start	XXX.X	Temperature
11. Differential to Stop	XXX.X	Temperature
12. Setpoint Source	*(BAS/Ext/FP, Ext/ Front Panel, Front Panel), BAS/Ext/FP Default	Enum

\*Follows hierarchy of selection from left to right (except for ice building which is “OR” logic).

## Feature Settings

Description	Resolution or (Enumerations), Default	Units
1. Chilled Water Reset	(Constant, Outdoor, Return, Disable), Disable	Enum
2. Return Reset Ratio	XXX	Percent
3. Return Start Reset	XXX.X	Temperature
4. Return Maximum Reset	XXX.X	Temperature
5. Outdoor Reset Ratio	XXX	Percent
6. Outdoor Start Reset	XXX.X	Temperature
7. Outdoor Maximum Reset	XXX.X	Temperature
8. Ext Chilled Water Setpoint	(Enable, Disable), Disable	Enum
9. Ext Current Limit Setpoint	(Enable, Disable), Disable	Enum
10. Ice Building Feature Enable	(Enable, Disable), Disable	Enum
11. Ext Base Loading Setpoint	(Enable, Disable), Disable	Enum

# Operator Interface

## System Mode Overrides

Description	Resolution or (Enumerations), Default	Units	Monitor Value
1. Compressor Control Signal	XXX / (Auto,Manual [0-100] ), Auto	Enum	IGV % Open Evap. LWT AFD Freq.
2. Evap Water Pump	(Auto, On), Auto	Enum	1) Evap Flow status 2) Override Time Remaining
3. Cond Water Pump	(Auto, On), Auto	Enum	1) Cond Flow status 2) Override Time Remaining

## Circuit Mode Overrides

Description	Resolution or (Enumerations), Default	Units	Monitor Value
1. Oil Pump	(Auto, On), Auto	Enum	1) Diff press 2) Override Time Remaining
2. Clear Restart Inhibit Timer			
3. Purge Exhaust Circuit Test	(Off, On), Off	Enum	none
4. Purge Regen Cycle	(Off, On), Off	Enum	Carbon Temp
5. Front Panel Ckt Lockout	(Not Locked Out, Locked Out), Not Locked Out	Enum	Enum

## Purge

Description	Resolution or (Enumerations), Default	Units
1. Purge Operating Mode	(Auto, On, Adaptive, Stop), Adaptive	Enum
2. Daily Pumpout Limit	XXX	Minutes
3. Disable Daily Pumpout Limit (0 to disable)	0, XX	Hours
4. Purge Liquid Temp Inhibit	(Enable, Disable), Enable	Enum
5. Purge Liquid Temp Limit	XXX.X	Temperature

## Display Settings

Description	Resolution or (Enumerations), Default	Units
1. Date Format	("mmm dd, yyy", "dd-mmm-yyyy"), "mmm dd, yyy"	Enum
2. Date		
3. Time Format	(12-hour, 24-hour), 12-hour	Enum
4. Time of Day		
5. Keypad/Display Lockout	(Enable, Disable), Disable	Enum
6. Display Units	(SI, English), English	Enum
7. Pressure Units	(Gauge, Absolute), Absolute	Enum
8. Language	(English, Selection 2, Selection 3), English (2)	Enum

(1) Temperatures will be adjustable to 0.1 degree F or C. The Main Processor provides the minimum and maximum allowable value.

(2) Adjustable to the nearest whole number percent. The Main Processor provides the minimum and maximum allowable value.

(3) Terminates with 10 minutes if inactivity

(4) The Date and Time setup screen formats deviate slightly from the standard screens defined above. See the time and date section for further details.

(5) Enables a DynaView™ Lockout screen. All other screens timeout in 30 minutes to this screen when enabled. The DynaView™ Lockout Screen displays a 0-9 keypad to permit the user to exit the lockout with a fixed password (1-5-9 + Enter). See lockout section for further details.

(6) Language choices are dependent on what has been setup in the Main Processor. Language selections will include English and qty 2 alternate as loaded by TechView™.

Language shall always be the last setting listed on the Display Settings menu. This will allow a user to find language selection if looking at an unrecognizable language.

(7) Manual Compressor Control allows an operator to override the Auto Control and manually control the compressor while in operation. This is not active during Stop mode.

# Operator Interface

---

Each Settings Sub screen consists of a setpoints list and the current value. The operator selects a setpoint to change by touching either the description or setpoint value. Doing this causes the screen to switch to the Analog Settings Subscreen shown below.

Analog Settings Subscreen displays the current value of the chosen setpoint in the upper ½ of the display. It is displayed in a changeable format consistent with its type. Binary setpoints are considered to be simple two state enumeration and will use buttons. Analog setpoints are displayed as spin buttons. The lower half of the screen is reserved for help screens. To change the setpoint the ENTER key must be touched, otherwise the new setting is cancelled.

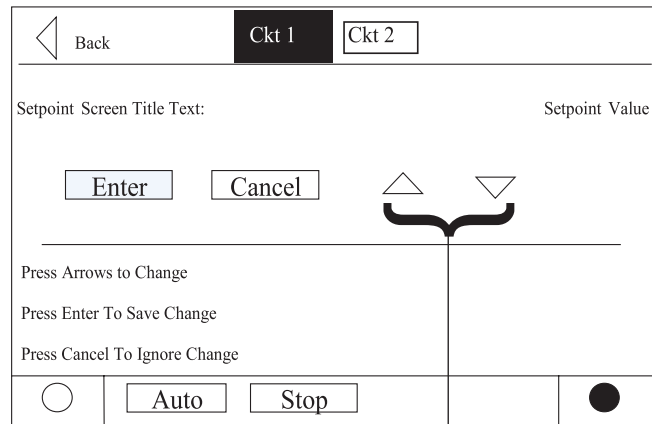

**Note:** Spin buttons used to change setpoint value.

# Operator Interface

Settings with buttons only [screen has no cancel or enter key] do accept the new selection immediately.

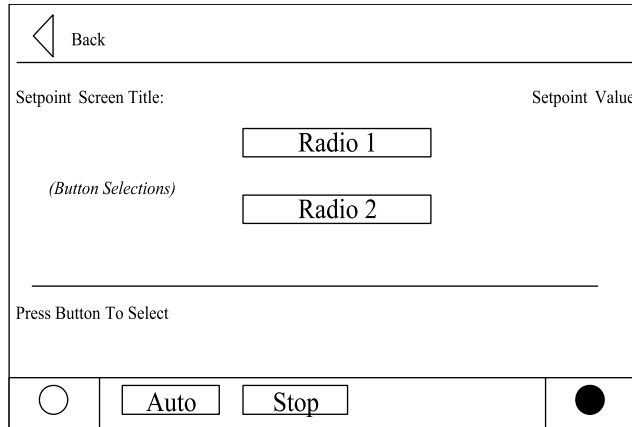

**Note:** Radio 1 and Radio 2 refer to “touch sensitive buttons.” The labels depend upon the setting being controlled.

The analog setting subscreen is similar but offers an Auto/Manual radio button and value setting. An Auto/Manual selection is necessary to set the mode to override. Subsequently, when an arrow key is depressed that new value is assumed.

Mode Override for Enumerated Settings is shown below:

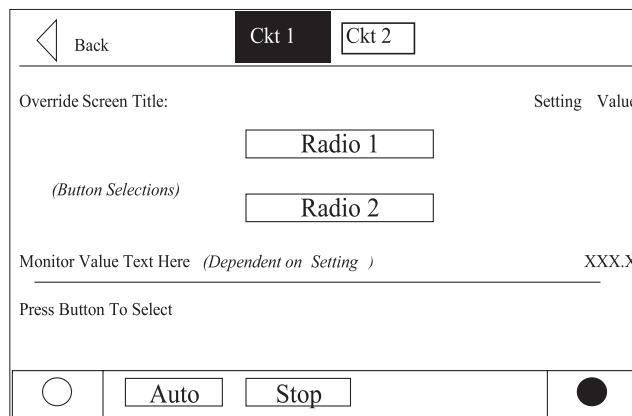

# Operator Interface

The mode override analog setting subscreen is similar but offers an Auto or Manual radio button and value setting. An Auto or Manual selection is necessary set to the mode to override. An Enter and Cancel Key will allow the user to Enter or Cancel the entry.

Mode Override for Analog Settings is shown below:

◀ Back	<b>Ckt 1</b>	Ckt 2
Override Screen Title Text:		Setting Value
Auto	▲	▼
Manual	Enter	Cancel
Monitor Value (actual name text here)		XX.X (units)
<input type="radio"/>	Auto	Stop <input type="radio"/>

The **date setpoint screen** for setting up the is shown below: The user must select **Day, Month, or Year** and then use the up or down arrows to adjust.

◀ Back		
Date:		dd-mmm-yyyy
Day	Month	Year
Enter	Cancel	▲ ▼
Press Arrows to Change		
Press Enter To Save Change		
Press Cancel To Ignore Change		
<input type="radio"/>	Auto	Stop <input type="radio"/>



# Operator Interface

---

The **time setpoint screen** with a 12-hour format is shown below: The user must select **Hour**, or **Minute** and then use the up or down arrows to adjust. Adjusting hours will also adjust am and pm.

◀ Back	
Time:	hh:mm am/pm
<input type="button" value="Hour"/>	<input type="button" value="Minute"/>
<input type="button" value="Enter"/>	<input type="button" value="Cancel"/> ▲ ▼
Press Arrows to Change	
Press Enter To Save Change	
Press Cancel To Ignore Change	
<input type="radio"/>	<input type="button" value="Auto"/> <input type="button" value="Stop"/> <input checked="" type="radio"/>

**Note:** The 24-hour format setpoint screen is similar with the am and pm not shown.

# Operator Interface

---

The DynaView™ Display **Touch Screen Lock** screen is shown below. This screen is used if the Display and Touch Screen Lock feature is Enabled. 30 minutes after the last key stroke this screen will be displayed and the Display and Touch Screen will be locked out until "159enter" is entered. Until the proper password is entered there will be no access to the DynaView™ screens including all reports, all setpoints, and Auto and Stop and Alarms and Interlocks. The password "159" is not programmable from either DynaView™ or TechView™.

DISPLAY AND TOUCH SCREEN ARE LOCKED		
ENTER PASSWORD TO UNLOCK		
<input type="text" value="1"/>	<input type="text" value="2"/>	<input type="text" value="3"/>
<input type="text" value="3"/>	<input type="text" value="5"/>	<input type="text" value="6"/>
<input type="text" value="7"/>	<input type="text" value="8"/>	<input type="text" value="9"/>
<input type="text" value="Enter"/>	<input type="text" value="0"/>	<input type="text" value="Cancel"/>
<input type="radio"/>		<input checked="" type="radio"/>

If the Display and Touch Screen Lock feature is Disabled, the following screen will be automatically shown if the MP temperature is below 32°F (0°C) and it has been 30 minutes after the last key stroke. *Note: the main processor is equipped with an on-board temperature sensor which enables the ice protection feature.*

# Interprocessor Communication

---

## Inter Processor Communications IPC3

When using Tracer CH530, you will not be required to know all the details about the structure of the IPC3 bus. However this page gives detailed information about the system for those of you that are really interested in how it works. The IPC3 protocol is based on RS485 signal technology. IPC3 was designed to be very efficient. It communicates at 19.2 Kbaud.

### IPC3 Definitions:

#### Bus Management:

The DynaView™ provides the bus management having the task of restarting the link, or filling in for missing nodes when the normal communication has been degraded. This involves reassigning node addresses and filling in for nodes that are off-line. The DynaView™ always has a node number of 01.

#### Node Assignment:

When a unit is factory commissioned, the Low Level Intelligent Device (LLID), or module, must have their node addresses assigned to them for storage in non-volatile memory. The node addresses are normally assigned sequentially during factory commissioning.

#### Node Zero:

Node number zero is a special node assignment that is reserved for devices that are service selected. A LLID communicating on node address zero will also communicate on an assigned node address. A LLID will only communicate on node address zero if it is service selected.

#### Binding:

Binding is the process of assigning a node number and functional IDs to a LLID. Binding is a simple process:

1. Service selecting the LLID with a magnet.
2. Assigning functional IDs to that LLID with TechView™.

#### Functional Identification:

When each LLID on the bus is bound, its inputs and outputs are given a functional ID. The Frame LLIDS have only one functional ID, but most Panel LLIDs have more than one functional ID. A dual high voltage binary input will have two functional IDs, a quad relay output has four functional IDs.

The DynaView™ Main Processor with its IPC3 Bus communicates to the control panel devices, unit mounted devices, and any remote devices on the IPC3 bus network. The various devices are discussed in the upcoming sections.

## Control Panel Internally mounted devices

For visual identification Internal Control Panel mounted devices are identified by their respective schematic designation number. Control panel items are marked on the inner back panel in the control panel. Figure 24 illustrated below, identifies these devices. The Control Panel Devices table corresponds to the same device designators (see right hand column). Optional controls are present when a specific optional controls package is specified, as listed in the second column. Optional controls packages are; OPST Operating Status, GBAS Generic Building Systems, EXOP Extended operation, CDRP Condenser Pressure, TRMM Tracer communications, WPSR Water Flow Pressure sensing, FRCL Free Cooling, HGBP Hot Gas Bypass, and EPRO Enhanced Protection

Figure 24 illustrates the Control Panel Components Layout.

LLID Modules 1A1, 1A3, 1A4, 1A5, 1A6, 1A7, and 1A13 are standard and present in all configurations. Other Modules vary depending on machine optional devices.

# Control System Components

Figure 24. Control panel components layout

## CH530 LH CONTROL PANEL ASSY DEVICE DESIGNATIONS AND CIRCUIT DESCRIPTIONS CDHF-CDHG DUPLEX UNITS

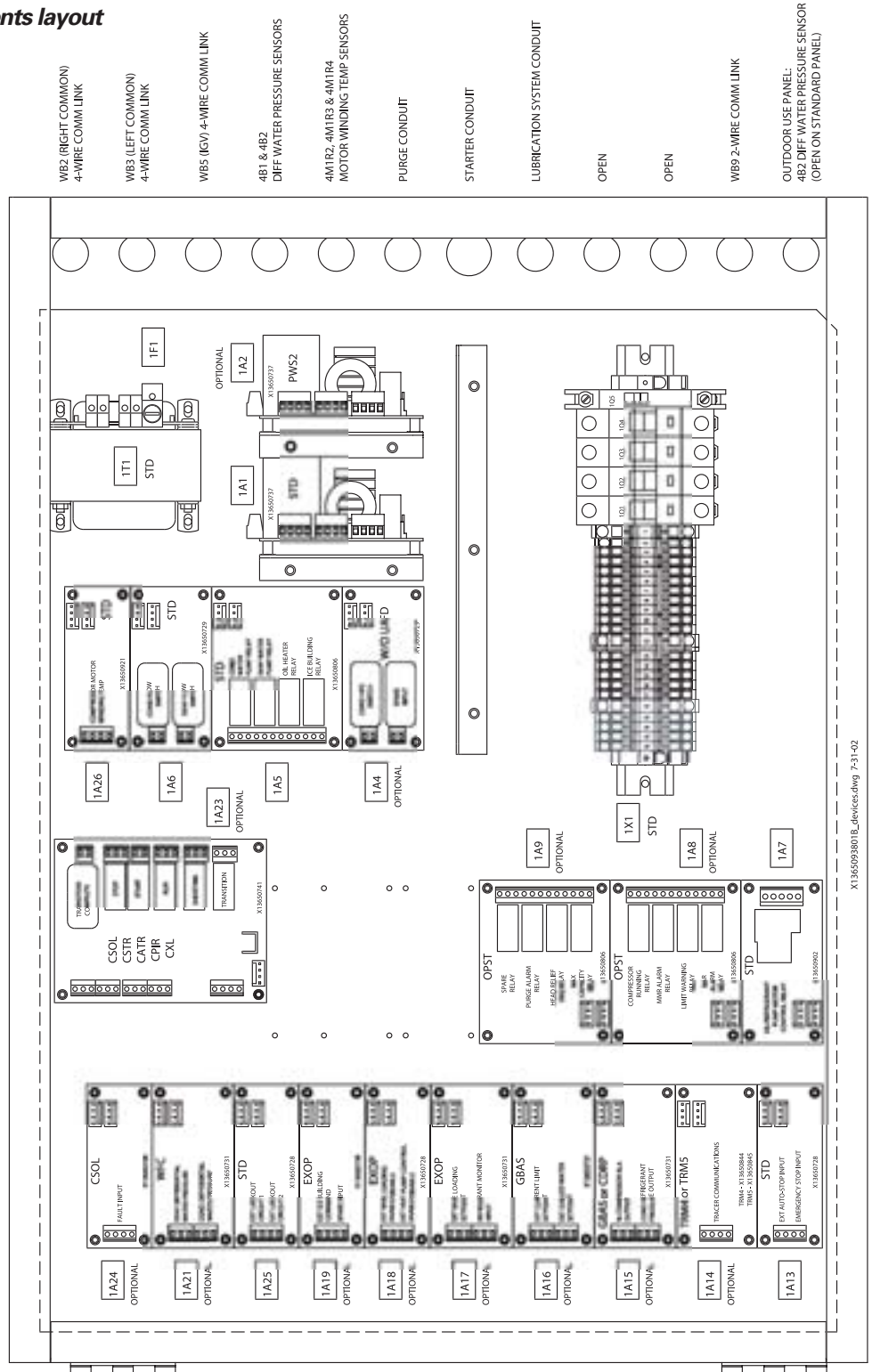

X1345993801B\_devices.dwg 7-31-02

# Control System Components

## CH530 RH CONTROL PANEL ASSY DEVICE DESIGNATIONS AND CIRCUIT DESCRIPTIONS CDHF-CDHG DUPLEX UNITS

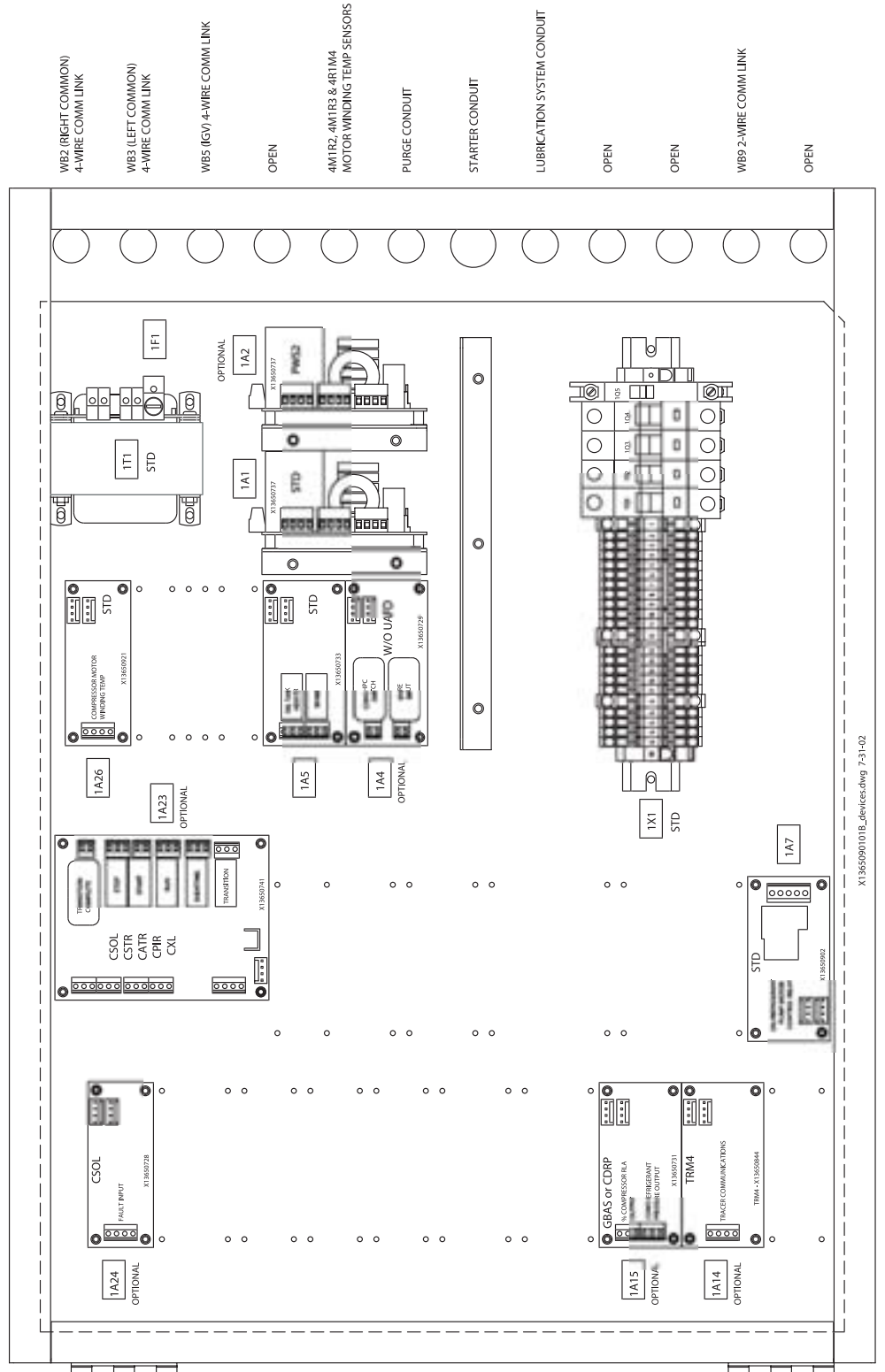

X13650001018\_device.dwg 7-31-02



# Control System Components

## Control Panel Devices

### Standard Devices

Description	Controls Package		Purpose	Field Connection Point Terminals
1A1 Power Supply	Standard	#1	Converts 24 vac to 24 vdc	not for field use
1A2 Power Supply	(as required)	#2	Converts 24 vac to 24 vdc	not for field use
1A3 Dual Relay Output modules	Standard	Relay #1	Oil Heater Relay	not for field use
1A4 Dual High Voltage Input	Standard		High Pressure Cutout	not for field use
1A5 Quad Relay Output modules	Standard	Relay #1	Chilled water pump (Relay #1)	J2-4 NO, J2-5 NC, J2-6 common
1A5 Quad Relay Output modules	Standard	Relay #2	Condenser water pump control (relay #2)	J2-1 NO, J2-2 NC, J2-3 common
1A6 Dual High Voltage Input	Standard	Input 1	Condenser Flow Input	J2-2 Condenser water flow switch
1A6 Dual High Voltage Input	Standard	Input 2	Evaporator Flow Input	J3-2 Chilled water flow switch
1A7 High Power Output Relay	Standard		Oil Pump and Refrigerant Pump	not for field use
1A13 Dual LV Binary input module	Standard	Signal #1	External Auto Stop,	J2-1 Binary Input Signal #1, J2-2 Ground
1A13 Dual LV Binary input module	Standard	Signal #2	Emergency stop	J2-3 Binary Input Signal #2, J2-4 Ground
1A26 Temp Sensor Input	Standard		Compressor Motor	not for field use
1F1	Standard		LLID Power Supply Transformer Primary Circuit protection	not for field use
1T1	Standard		Control Panel Power Transformer ; 120:24Vac	not for field use
1Q1	Standard		Circuit Breaker Compressor Motor Controller Control Power Branch Circuit	not for field use
1Q2	Standard		Circuit Breaker - Purge System Branch Circuit	not for field use
1Q3	Standard		Circuit Breaker – Module [- LLID] Power Supply Branch Circuit	not for field use
1Q4	Standard		Circuit Breaker - Oil System Control Branch Circuit	not for field use
1Q5	Standard		Oil Pump Motor Branch Circuit protection	not for field use
1X1 Terminal Block	Standard		Control Panel Terminal Block, Flow switch connections	1X1-5 Chilled water flow flow switch input 1X1-6 Condenser water flow switch input

# Control System Components

## Chilled and Condenser Water Flow Interlock Circuits

Proof of chilled water flow for the evaporator is made by the closure of flow switch 5S1 and the closure of

auxiliary contacts 5K1 on terminals 1X1-5 and 1A6-J3-2. Proof of condenser water flow for the condenser is made by the closure of flow switch 5S2 and the closure of

auxiliary contacts 5K2 on terminals 1X1-6 and 1A6-J2-2.

### OPST Operation Status Option

**Relay output modules 1A8 and 1A9 provide relay defaults shown (For other selections, see Installation Manual):**

1A8 Optional Quad Relay Output Status	OPST	Relay #1	Chiller Non-Latching Alarm	J2-1 NO, J2-2 NC, J2-3 common
1A8 Optional Quad Relay Output Status	OPST	Relay #2	Chiller Limit Mode Indicator	J2-4 NO, J2-5 NC, J2-6 common
1A8 Optional Quad Relay Output Status	OPST	Relay #3	Chiller Latching Alarm Indicator	J2-7 NO, J2-8 NC, J2-9 common
1A8 Optional Quad Relay Output Status	OPST	Relay #4	Chiller Running Indicator	J2-10 NO, J2-11 NC, J2-12 common
1A9 Optional Quad Relay Output Status	OPST	Relay #1	Chiller Maximum Capacity	J2-1 NO, J2-2 NC, J2-3 common
1A9 Optional Quad Relay Output Status	OPST	Relay #2	Chiller Head Relief Request	J2-4 NO, J2-5 NC, J2-6 common
1A9 Optional Quad Relay Output Status	OPST	Relay #3	Circuit 2 Purge Alarm	J2-4 NO, J2-5 NC to J2-6 common
1A9 Optional Quad Relay Output Status	OPST	Relay #4	Circuit 1 Purge Alarm	J2-1 NO, J2-2 NC, to J2-3 common

## Head Relief Request Output

When the chiller is running in Condenser Limit Mode or in Surge Mode, the head relief request relay on the 1A9–J2-6 to J2-4 will be energized (1 minute default) and can be used to control or signal for a reduction in the entering condenser water temperature. Designed to prevent high refrigerant pressure trip-outs during critical periods of chiller operation.

If the unit is not equipped with the CDPR Enhanced Condenser Limit Option the unit will use the condenser refrigerant temperature sensor (input converted to saturated refrigerant pressure) to perform the Standard Condenser Limit function,

without the head relief request relay, by limiting inlet guide vane stroke and chiller capacity.

Keep in mind that Condenser Limit Control supplements the protection provided by the condenser pressure high pressure cutout switch 3S1.

### Motor Temperature sensor module

The motor temperature module 1A26 connects via unit wiring to the three motor winding temperature sensors. This module is located in the control panel where the module is connected to the IPC bus.

Default status relay selections are shown. Selections can be altered using service tool. Other choices are: Circuit 1 Running, Circuit 2 Running, Chiller Alarm, Circuit 1 Alarm, Circuit 2 Alarm, and Purge Alarm.

## Maximum Capacity Relay

When the chiller has been operating at maximum capacity for 10 minutes (TechView adjustable) this relay will activate. Also upon being less than maximum capacity for 10 minutes this relay will deactivate.

## Compressor Running Relay

Relay activates while compressor is running.

## Machine Shutdown Manual Reset (MMR)

Limit warning machine shutdown auto reset relays will activate with such conditions for remote status indication.



# Control System Components

## **EXOP Extended Operation Option**

*The following modules (1A17, 1A18, and 1A19) are provide when this control package is specified.*

1A5 Quad Relay Output module	EXOP	Relay #4	Ice Building Relay	J2-10 NO, J2-11 NC, J2-12 common
1A17 Optional Dual Analog Input/Output Module	EXOP	Signal #1	External Base Loading Setpoint input	J2-1 Output #1, J2-3 Ground
1A17 Optional Dual Analog Input/Output Module	EXOP	Signal #2	Refrigerant monitor inputs	J2-4 Output #2, J2-6 Ground
1A18 Optional Dual LV Binary input module	EXOP	Signal #1	External Base Loading Enable or Disable input, points	J2-1 Binary Input Signal #1, J2-2 Ground
1A18 Optional Dual LV Binary input module	EXOP	Signal #2	External Hot Water Control Enable or Disable input	J2-3 Binary Input Signal #2, J2-4 Ground
1A19 Optional Dual LV Binary input module	EXOP	Signal #1	Ice Building Control Enable or Disable input point	J2-1 Binary Input Signal #1, J2-2 Ground

## **Refrigerant Monitor Input 1A17**

Analog type input 4-20ma input signal to the 1A17 J2-4 to J2-6 (ground). This represents 0-100 ppm.



# Control System Components

---

## ***TRMM TRM4 (Tracer Comm 4 interface)***

1A14 Optional Communication Interface Module	TRM4 or LCI-C	Tracer Communications	J2-1 COMM+, J2-2 COMM -J2-3, COMM +J2-4, COMM -,
--	---------------	-----------------------	--

## ***CDRP (Condenser Refrigerant Pressure Output)***

1A15 Optional Dual Analog Input/output Module	CDRP	Signal #2	Condenser Refrigerant Pressure output	J2-4 Output #2, J2-6 Ground
---	------	-----------	---------------------------------------	-----------------------------

## ***EPRO (Enhanced Protection)***

4R22	EPRO	Condenser Refrigerant Pressure Transducer
4R16	EPRO	Compressor Discharge Refrigerant Temperature Sensor. (This is also included with HGBP).
4R1	EPRO	Inboard Bearing Temperature Sensor
4R2	EPRO	Outboard Bearing Temperature Sensor

# Control System Components

## CDRP Refrigerant Pressure Output Option 1A15:

Refrigerant Pressure Output can be configured at commissioning to correspond to either A) the absolute condenser pressure, or B) the differential pressure of the evaporator to condenser pressures.

This vdc output is located at 1A15 – J2 – 4 (+) to J2-6 (Ground)

The Voltage DC Output can source a maximum of 22 mA of current.

This output is Voltage DC only, 4-20 mA is not supported.

### A) Condenser Pressure Output.

2 to 10 Vdc corresponds to 0 Psia to the HPC (in Psia) setting.

**Note:** CH530 control allows for Delta Pressure, or, condenser pressure but not both on one circuit.

### Temperature based

On standard machines the Percent Condenser Pressure Indication Output is based on the Saturated Condenser Refrigerant and a temperature to pressure conversion is made.

If the Condenser Saturated Temperature goes out of range due to an open or short, a pressure sensor diagnostic will be called and the output will also go to the respective out of range value. That is, for an out of range low on the sensor, the output will be limited to 2.0 VDC. For an out of range high on the sensor, the output will be limited to 10.0 VDC.

### Pressure based

With the Enhanced Protection EPRO option, a condenser pressure transducer is installed and the pressure is measured.

If the Condenser Pressure sensor goes out of range due to either an open or short, a pressure sensor diagnostic will be called and the output will go to end of range low. That is, for an out of range low on the sensor, the output will be limited to 2.0 VDC. For an out of range high on the sensor, the output will be limited to 2.0 VDC.

**Figure 25. Condenser pressure based output**

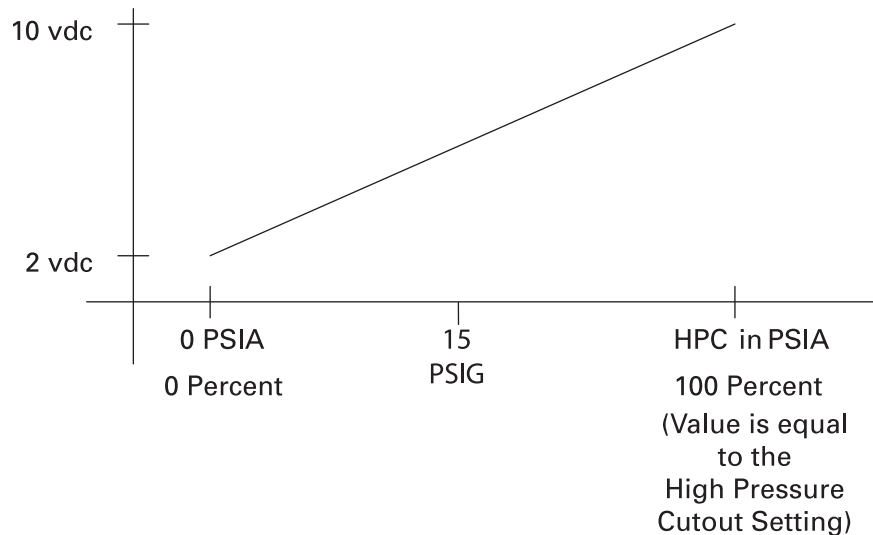

# Control System Components

## B) Refrigerant Differential Pressure Indication Output:

A 2 to 10 VDC analog output is provided instead of the previous condenser pressure output signal. This signal corresponds to a predetermined minimum and maximum pressure settings setup at commissioning of this feature. This relationship can be altered using the service tool if required.

The "Minimum Delta Pressure " is typically set to 0 psi and will then correspond to 2 vdc. The "Maximum Delta Pressure " is typically set to 30 psi and corresponds to 10 vdc.

The Minimum Delta Pressure Calibration setting has a range of 0-400 psid (0-2758 kPa) in increments of 1 psid (1kPa). The Maximum Delta Pressure Calibration setting has a range of 1-400 psid (7-2758 kPa) in

increments of 1 psid (1kPa). The condenser refrigerant pressure is based on the Condenser Refrigerant Temperature sensor if the Condenser Pressure Option is selected as "Not Installed" at the display.

The evaporator refrigerant pressure is based on the Saturated Evaporator Refrigerant Temperature Sensor.

See CTV-PRB006-EN for additional information about condenser water temperature control.

**Figure 26. Delta pressure setting - differential pressure based output (Defaults shown)**

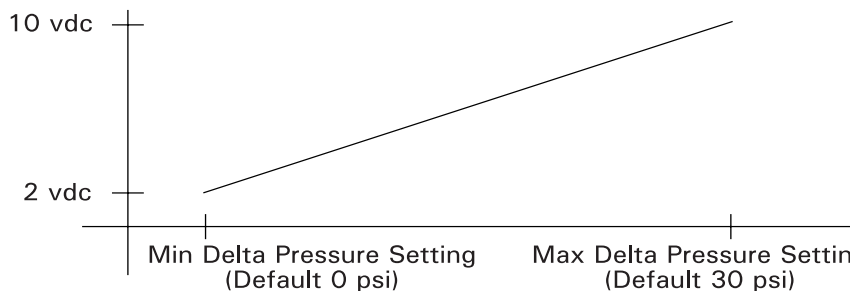

**Note:** In this example, 2 vdc corresponds to OPSI differential and 10 vdc corresponds to 30 psi differential. The minimum value of 0 psi, and maximum value of 30 psi are individually adjustable via the service tool.



# Control System Components

## GBAS (Generic Building Automation System)

1A15 Optional Dual Analog Input/output Module	GBAS	Signal #1	Percent RLA Compressor Output	J2-1 Output #1, J2-3 Ground
1A16 Optional Dual Analog Input/output Module	GBAS	Signal #1	External Current limit Setpoint	J2-2 Input #1, J2-3 Ground
1A16 Optional Dual Analog Input/output Module	GBAS	Signal #2	Chilled Water Reset input, or External Chiller Water Setpoint	J2-5 Input #2, J2-6 Ground

### Percent RLA Output

2 to 10 Vdc corresponding to 0 to 120% RLA. With a resolution of 0.146%. The Percent RLA Output connections are on the terminals 1A15–J2-1 (+) to J2-3 (Ground). The Percent RLA Output is polarity sensitive.

The following graph illustrates the output:

**Figure 27. Voltage versus percent RLA**

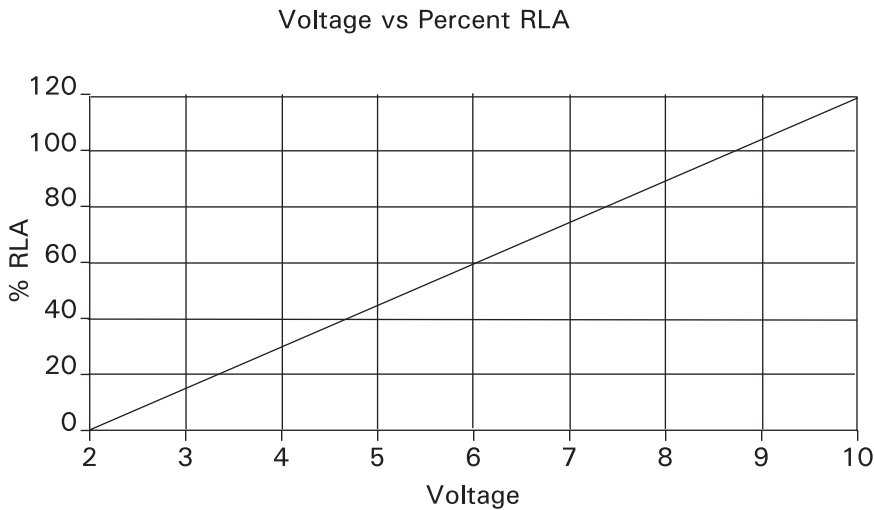

# Control System Components

## External Chilled Water Setpoint (ECWS)

The External Chilled Water Setpoint allows the chilled water setpoint to be changed from a remote location. The External Chilled Water Setpoint is found on 1A16 J2-5 to J2-6 (Ground). 2-10 vdc and 4-20 ma corresponds to a default 34°F to 65°F (-17.8 to 18.3°C) adjustable via service tool.

## External Current Limit Setpoint

The External Current Limit is an option that allows the current limit setpoint to be changed from a remote location. The External Limit Setpoint is found on 1A16 J2-2 to J2-3 (ground), 2-10 vdc and 4-20 ma each correspond to a 40 to 100 percent RLA range. UCP limits the maximum ECLS to 100 percent.

Default 40 to 100%, adjustable via service tool.

### WPSR (WFC Water Pressure Sensing Option)

1A21 Optional Dual Analog Input or output Module	WPSR = WFC	Signal #1	Evaporator Differential Water Pressure	Not for field use
1A21 Optional Dual Analog Input or output Module	WPSR = WFC	Signal #2	Condenser Differential Water Pressure	Not for field use

## Module Characteristics

### 1A1, 1A2 Power Supply :

Unit Control Power Supply Module  
Converts 27 vac to 24 vdc.

Power Input Voltage: 23VRMS minimum, 27VRMS Nominal, 30VRMS maximum

Frequency: 50-60 Hz

Current: Full load 27 VAC – 4.30 A (RMS)

Inrush 27 VAC (RMS) ~ 30A (RMS)

Power Output: Class II Voltage 24 VDC, Rated Current 2.44 Amps.

Fused at 3 amps (FUS01513)

### 1A3, 1A5, 1A10 Dual Relay Output modules :

Relay #1 J2-1 NO, J2-2 NC, J2-3 common

Relay #2 J2 4 NO, J2-5 NC, J2-6 common

Relay Outputs at 120 VAC: 7.2 Amps resistive, 2.88 Amps pilot duty, 1/3 HP, 7.2 FLA at 240 VAC: 5 Amps general purpose, 14 - 26 AWG with a maximum of two 14 AWG.

Power, 24 +/- 10 percent VDC, 60 mA maximum, Trane IPC3 protocol. J1-1 +24VDC, J1-2 Ground, J1-3 COMM + J1-4 COMM -

### 1A4, 1A6 Dual High Voltage Binary input module:

Binary Input Signal #1 J2-1 to 2

Binary Input Signal #2 J3-1 to 2

High Voltage Binary Input: Off Voltage: 0 to 40 VAC RMS , On Voltage: 70 to 276 VAC RMS

Input is not polarity sensitive (Hot and neutral can be switched), Input impedance 130K to 280K ohms

14 - 26 AWG with a maximum of two 14 AWG

Power, 24 +/- 10 percent VDC, 20 mA maximum. Trane IPC3 protocol. J1-1 +24VDC, J1-2 Ground, J1-3 COMM +, J1-4 COMM -

### 1A7 High Power Output Module

Relay contacts at 120 VAC:

16 amps resistive, 6.4 amps,pilot duty, 1 HP

J2-14-26 awg witha maximum of two 14 awg

J2-1 J2-2 no, J2-3 NC, J2-4 com



# Control System Components

## 1A8, 1A9, 1A11, 1A12 Quad Relay Output Status:

Relay #1 J2-1 NO, J2-2 NC, J2-common

Relay #2 J2-4 NO, J2-5 NC, J2-6 common

Relay #3 J2-7 NO, J2-8 NC, J2-9 common

Relay #4 J2-10 NO, J2-11 NC, J2-12 common

Relay Outputs: at 120 VAC: 7.2 Amps resistive, 2.88 Amps pilot duty, 1/3 HP, 7.2 FLA, at 240 VAC: 5 Amps general purpose 14-26 AWG, two 14 AWG Maximum Power, 24 +/-10 percent VDC, 100 ma maximum. Trane IPC3 protocol.

## 1A13, 1A18, 1A19, 1A20 Dual Binary input module:

J2-1 Binary Input Signal #1, J2-2 Ground, J2-3 Binary Input Signal #2, J2-4 Ground

Binary Input: Looks for a dry contact closure. Low Voltage 24V 12 mA.

14 - 26 AWG with a maximum of two 14 AWG

Power, 24 +/- 10 percent VDC, 40 mA maximum Trane IPC3 protocol.

## 1A14 Communication interface Module

Power, 24 +/- 10 percent VDC, 50 mA maximum. Trane IPC3 protocol.

J1-1 +24 VDC	J2-1 COMM +.	J11-1+24 VDC
J1-2 Ground	J2-2 COMM -	J11-2 Ground
J1-3 COMM +	J2-3 COMM +	J11-3 COMM +
J1-4 COMM -	J2-4 COMM -	J11-4 COMM -

# Control System Components

**1A15, 1A16, 1A17, 1A21 Dual Analog Input/output Module;**

**Analog Output:** The Analog Output is a voltage only signal. 2-10 Vdc at 22mA

J2: 14 - 26 AWG with a maximum of two 14 AWG

J2-1 Output #1 to J2-3 (Ground), J2-4 Output #2 to J2-6 (Ground).

UCP provides a 2-10 Vdc analog signals as Outputs. The Output's maximum source capability is 22mA. The maximum recommended length to run this signal is included in the table below.

***Recommended Length to Run external Output signals***

Gauge	Ohms per Feet	Length (Feet)	Maximum Length (Meters)
14	0.00 2823	1062.7	324
16	0.004489	668.3	203.8
18	0.007138	420.3	128.1
20	0.01135	264.3	80.6
22	0.01805	166.3	50.7
24	0.0287	104.5	31.9
26	0.04563	65.7	20
28	0.07255	41.4	12.6

Note: the above table is for copper conductors only.

**Analog Input:**

The analog input can be software switched between a voltage input or a current input. When used as a current input a 200 Ohm load resistor is switched in.

**2-10 Vdc or 4-24 mA Analog Inputs**

UCP accepts either a 2-10 Vdc or 4-20 analog input suitable for customer external control. The type is determined at unit commissioning during feature installation.

J2: 14 - 26 AWG with a maximum of two 14 AWG

J2-2 Input #1 to J2-3 (Ground).

J2-5 Input #2 to J2-6 (Ground).

Power, 24 +/- 10 percent VDC, 60 mA maximum, Trane IPC3 protocol.



# Control System Components

---

## Unit mounted devices

### Vane Actuator Control

The Stepper Module within the stepper vane actuator (4M2) (and 4M4 extended capacity) pulses a DC voltage to the windings of the Stepper Motor Actuator(s) to control inlet guide vane position. While operation of this stepper motor is automatic, manual control is possible by going to the Mode Overrides settings menu within the DynaView™. Compressor Control Signal allow the operator to manually increase or decrease the compressor load by adjusting the compressor control signal.

**Note:** If the chiller is operating in a limit mode (current limit, condenser limit, evaporator limit, etcetera.) The limit operation has priority over all DynaView™ manual modes of operation.

On each UCP power-up, the inlet guide vanes are driven full closed to recalibrate the zero position (Steps) of the Stepper motor vane actuator.

### Temperature sensors,

Evaporator sensors 4R6 and 4R7, and condenser sensors 4R8, 4R9 entering and leaving, bearing temperature sensors 4R1, 4R2, oil temperature sensor 4R5, outdoor air temperature 4R13, and evaporator 4R10 and condenser 4R11 saturated refrigerant temperature sensors.

Probe Operating Temperature Range - 40 to 250°F (-40 to 121°C)

Accuracy +/- 0.25°C over the range -4 to 122°F (-20 to 50°C), +/- 0.50°C over the range -40 to 250°F (-40 to 121°C)

Power and Communications and Terminations Power 24 +/- 10% VDC, 20 mA maximum.

Trane IPC3 protocol Communications.

### Pressure sensors

Oil tank sump 4R4 and oil pump discharge 4R3, evaporator and condenser refrigerant pressure 4R22, Working Pressure Range: 0 to 50 Psia Accuracy: ± 0.3% of full scale output at 68°F (20°C)

Power and Communications and Terminations

Power 24 +/- 10% VDC, 20 mA maximum.

Communications, RS485 Physical Layer, 19.2 Kbaud, Trane IPC3 protocol.

### Starter Module

In the hierarchy of modules the Starter module 2A1 (1A23 when customer supplied starter specified) is second only to the DynaView™. The starter module is present in all starter selections (except AFD) .This includes Wye Delta, Across the Line, Solid State whether remote unit mounted or supplied by others. The starter module provides the logic to provide the motor protection for Current overload, phase reversal, phase loss, phase imbalance, and momentary power loss. These functions are discussed in the motor protection section of this manual.

### EarthWise™ Purge

Trane has also revolutionized its controller-integrated purge, which features an automatic regeneration system for high-efficiency, maintenance-free refrigerant containment. Air and noncondensables are pumped out faster, and the lower temperature refrigeration system enhances the base purge efficiency. See EarthWise purge operation and maintenance manual for details.

### Unit-mounted medium - voltage starter

Take advantage of Tracer CH530's new starter and save space in your equipment room. There is no need for a remote or floor-mounted starter with our new, exclusive unit-mounted medium - voltage starter from Cutler-Hammer.

The following two figures illustrate the typical location of various standard and optional unit mounted control and sensor devices.



# Control System Components

DEVICE DESIGNATION	DESCRIPTION
3A1	PURGE MODULE
3X1	PURGE TERMINAL BLOCK
4C1	CAPACITOR - OIL PUMP
4HR1	OIL TANK HEATER
4K8	OIL PUMP STARTER RELAY
4M2	STEPPER MOTOR VANE ACTUATOR
4M3	OIL PUMP MOTOR
4M4	STEPPER MOTOR 2ND STAGE VANE ACTUATOR
4M1R2, 3 & 4	MOTOR WINDING TEMPERATURE
4R1	BEARING OIL NO. 1 TEMPERATURE
4R2	BEARING OIL NO. 2 TEMPERATURE
4R3	OIL PUMP DISCHARGE PRESSURE
4R4	OIL SUMP PRESSURE
4R5	OIL TEMPERATURE
4R6	EVAP ENTERING WATER TEMPERATURE
4R7	EVAP LEAVING WATER TEMPERATURE
4R8	COND ENTERING WATER TEMPERATURE
4R9	COND LEAVING WATER TEMPERATURE
4R10	EVAP SATURATED REFRIGERANT TEMPERATURE
4R11	COND SATURATED REFRIGERANT TEMPERATURE
4R14 & 15	ENT & LVG WTR TEMP COND HTRG & AUX
4R16	DISCHARGE REFRIGERANT TEMPERATURE
4R22	CONDENSER REFRIGERANT PRESSURE

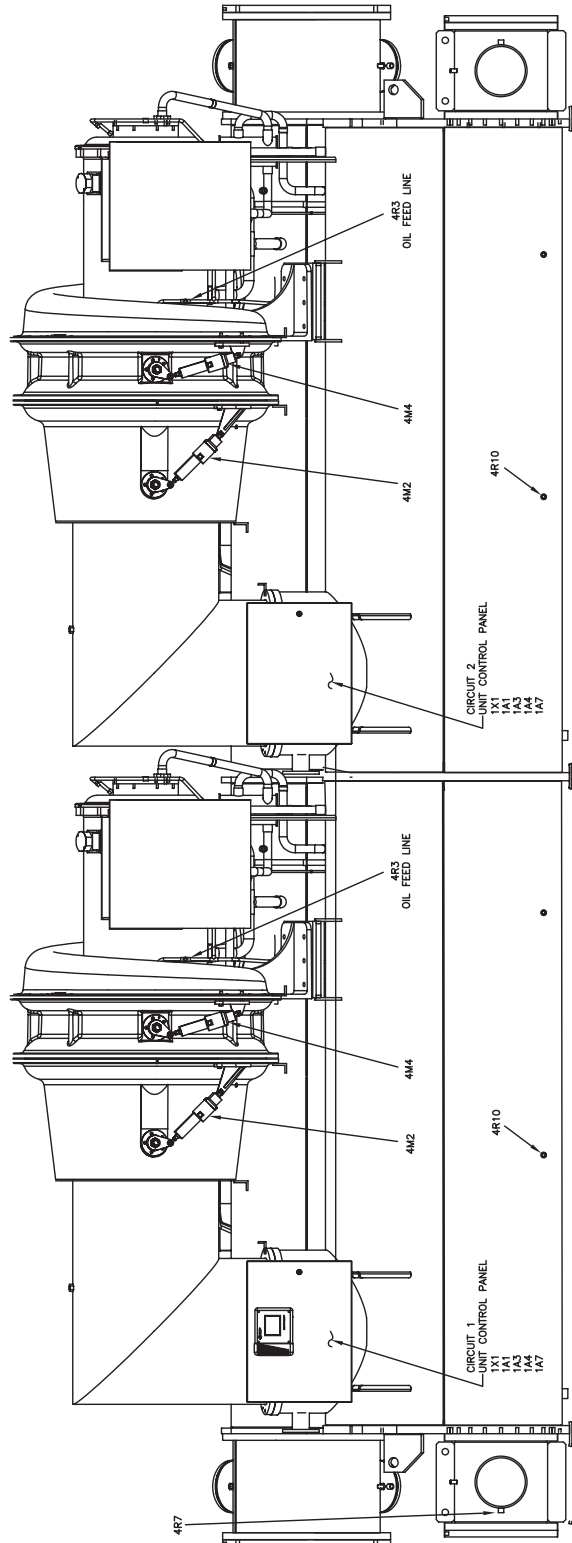
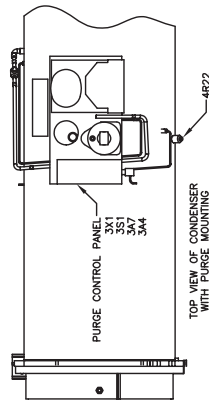
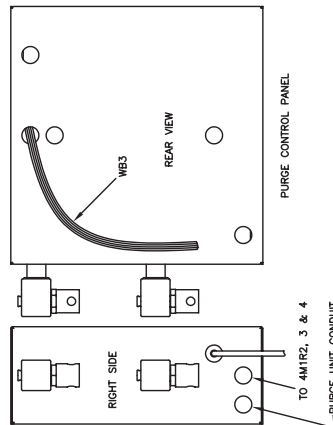
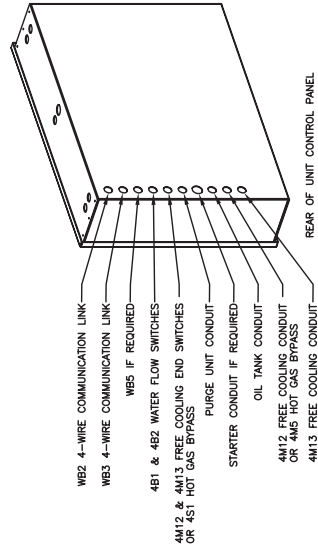
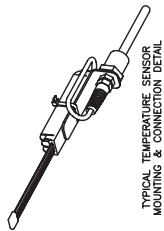

# Control System Components

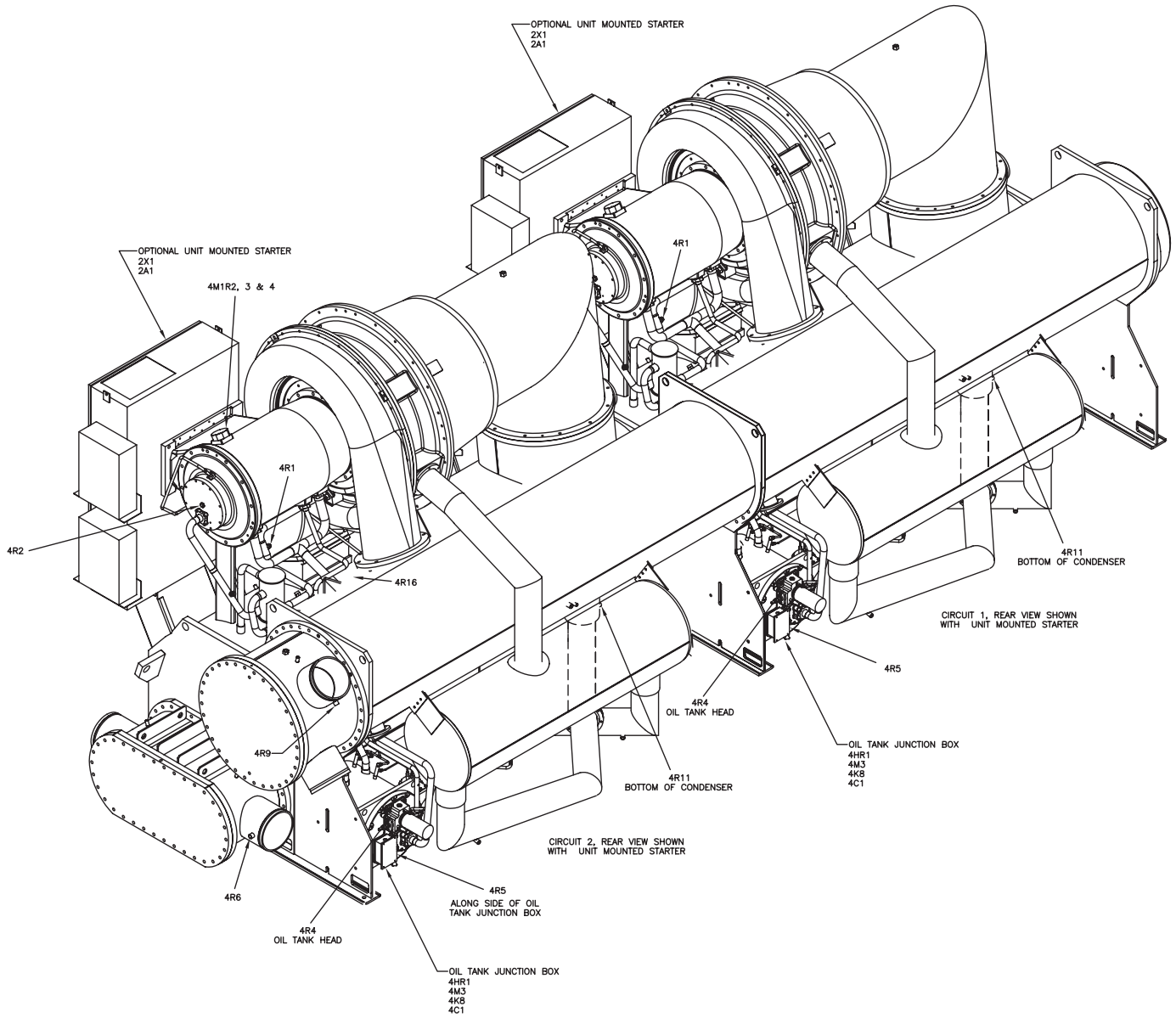

# Control Sequence of Operation

---

## Electrical Sequence

This section will acquaint the operator with the control logic governing CDHF/CDHG chillers equipped with Tracer CH530 UCP based control systems. When reviewing the step-by-step electrical sequences of operation, refer to the typical wiring schematics for Unit mounted Wye Delta starter shown in the installation manual shipped with the chiller.

**Note:** The typical wiring diagrams are representative of standard units and are provided only for general reference. They may not reflect the actual wiring of your unit. For specific electrical schematic and connection information, always refer to the wiring diagrams that shipped with the chiller.

With the supply power disconnect switch or circuit breaker (2Q1 or 2K3) closed, 115-volt control power transformer 2T5 and a 40-amp starter panel fuse (2F4 ) to terminal (2X1-1) starter panel to terminal 1X1-1 in the control panel. From this point, control voltage flows to:

1. Circuit Breaker 1Q1 which provides power to the starter module (2A1) relay outputs and the High Pressure Cutout switch (3S1).
2. Circuit Breaker 1Q2 which provides power to the Purge circuitry.
3. Circuit Breaker 1Q3 which provides power to Transformer (1T1) which steps down the 115 Vac to 24 Vac. This 24 Vac then powers the 24 Vdc power supply 1A1, and 1A2 if present. The 24 vdc is then connected to all modules via the Interprocessor communications Bus providing module power.  
  
1Q3 also provides power to the external chiller water proof of flow device connected between terminal block 1X1-5 to 1A6-J3-2, and condenser water proof of flow device connected at 1X1-6 to 1A6-J2-2.
4. Circuit Breaker 1Q4 which provides power to the Oil Heater 4HR1 circuit and to circuit breaker 1Q5 oil and refrigerant pump circuits.
5. The DynaView™ display module 1A22, receives 24 vdc power from the IPC bus.

## UCP and Wye-Delta Starter Control Circuits

Logic Circuits within the various modules will determine the starting, running, and stopping operation of the chiller. When operation of the chiller is required the chiller mode is set at "Auto". Using customer supplied power, the chilled water pump relay (5K1) is energized by the 1A5 Module output at 1A5-J2-4, and chilled water flow must be verified within 4 minutes 15 seconds by the 1A6 Module. The main processors logic decides to start the chiller based on the differential to start setpoint. With the differential to start criteria met module 1A5 then energizes condenser water pump relay (5K2) via customer supplied power at 1A5 J2-1.

Based on the restart inhibit function and the differential to start setpoint, oil and refrigerant pump (4M3) will be energized by 1A7 Module (1A7-J1). The oil pressure must be at least 9 Psid for 30 continuous seconds and condenser water flow verified within 4 minutes 15 seconds minutes for the compressor start sequence to be initiated.



## Control Sequence of Operation

---

When less than 5 seconds remain before compressor start, a starter test is conducted to verify contactor states prior to starting the compressor. The following test or start sequence is conducted for "Wye-Delta" starters: Also refer to Figure 24.

A. Test for transition complete contact open (2A1-J12-2) –160 to 240 msec. An MMR diagnostic will be generated if the contact is closed.

B. Delay time - 20 msec.

C. Close start contactor (2K1) and check for no current - 500 msec. If currents are detected, the MMR diagnostic "Starter Fault Type I" is generated.

D. Stop relay (2A1-J10-3 to 1) closes for one second for test "C" above.

E. Delay time - 200 msec. (Opens 2K1).

F. Close shorting contactor, (2K3) and check for no current - one second. If currents are detected the MMR diagnostic "Starter Fault Type II" is generated. (Starter Integrity test)

G. If no diagnostics are generated in the above tests, the Stop Relay (2A1-J10) is closed for 2 seconds and the Start Relay (2A1-J8) is closed to energize the start contactor (2K1). The shorting contactor (2K3) has already been energized from (F) above. The compressor motor (4M1) starts in the "Wye" configuration, an auxiliary contact (2K1-AUX) locks in the start contactor (2K1) coil. Additionally, 2K11 pulls in to hold the oil pump on. This is parallel to 1A7 contacts.

H. After the compressor motor has accelerated and the maximum phase current has dropped below 85 percent of the chiller nameplate RLA for 1.5 seconds, the starter transition to the "Delta" configuration is initiated.

J. The transition contactor (2K4) is closed through relay 2A1-J2, placing the transition resistors (2R1, 2R2, and 2R3) in parallel with the compressor motor windings.

K. The shorting contactor (2K3) is opened through the opening of relay 2A1-J4 100 msec after the closure of the transition relay 2A1-J2.

L. The run contactor (2K2) is closed through relay 2A1-J6, shorting out the transition resistors 260 milliseconds after the opening of the shorting relay 2A1-J4. This places the compressor motor in the "Delta" configuration and the starter module waits to look for this transition for 2.35 seconds through the closure of the transition complete contacts 2K2-Aux at module 2A1-J12 input)

M. The starter module must now confirm closure of the transition complete contact (2K2-AUX) within 2.32 to 2.38 seconds after the run relay (2A1-J6) is closed. Finally, the transition relay (2A1-J2) is opened de-energizing the transition contactor (2K4) and the compressor motor starting sequence is complete. An MMR diagnostic will be generated if the transition complete contacts (2K2-AUX) do not close. A diagram of this test or start sequence is shown in Figure 24.

# Control Sequence of Operation

---

Now that the compressor motor (4M1) is running in the "Delta" configuration, the inlet guide vanes will modulate, opening and closing to the chiller load variation by operation of the stepper vane motor actuator (4M2) 4M4 (extended capacity) to satisfy chilled water setpoint. The chiller continues to run in its appropriate mode of operation: Normal, Softload, Limit Mode, etcetera. As explained in the General Information section.

If the chilled water temperature drops below the chilled water set point by an amount set as the "differential to stop" setpoint, a normal chiller stop sequence is initiated as follows: (Refer to Figure 10.)

1. The inlet guide vanes are driven closed for 50 seconds.

2. After the 50 seconds has elapsed, the stop relay (2A1-J10) and the condenser water pump relays (1A5-J2) open to turn off. The oil and refrigerant pump motor (4B3) will continue to run for 3 minutes post lube while the compressor coasts to a stop. The chilled water pump will continue to run while the Main processor module (1A22) monitors leaving chilled water temperature preparing for the next compressor motor start based on the "differential to start" setpoint.

If the STOP key is pressed on the operator interface, the chiller will

follow the same stop sequence as above except the chilled water pump relay (1A5-J2) will also open and stop the chilled water pump after the chilled water pump delay timer has timed out after compressor shut down.

If the "Immediate Stop" is initiated, a panic stop occurs which follows the same stop sequence as pressing the STOP key once except the inlet guide vanes are not sequence closed and the compressor motor is immediately turned off.

# Control Sequence of Operation

Figure 24. Test and start timing sequence

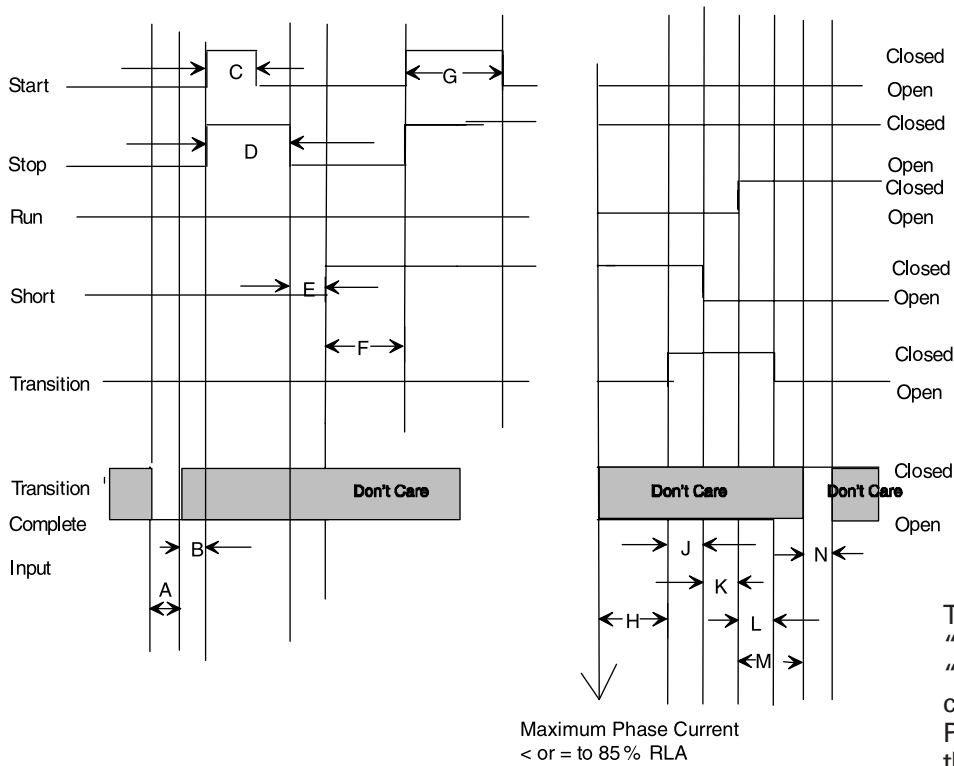

Timing requirements to operate the "Stop", "Start", "Short", "Transition", and "Run" contact closure outputs are shown below. Prior to closing the "Short" contact, the transition complete input shall be verified to be open, otherwise an MMR diagnostic shall be generated.

Steps A to F: Starter Integrity Test  
Steps G to N: Starter Timing

Interval	Minimum	Maximum	Units	Actual Design
A. (Test for transition complete input open)				160 to 240 milliseconds
B. (Just delay time)				20 milliseconds
C. (Close 1M (2K1) Contactor and test for no current.) (Starter integrity test)				500 milliseconds
D. (Hold 1M (2K1) Contactor and test for no current.) (Starter integrity test)				1 second
E. (Open 1M (2K1) Delay time)				200 milliseconds
F. (Close Shorting Contactor (2K3) and test for no current, then wait for Start command.) (Starter integrity test)	100		milliseconds	1 second (Minimum)
G. (Close 1M (2K1 and 2K11))	2.0		second	2 second
H. (Wait 1.5 seconds after phase currents drop to 85 percent)	1	2	second	1.5 second
J. (Begin Transition sequence)	85	100	milliseconds	100 milliseconds
K. (Open S (Shorting) Contactor)	250	300	milliseconds	260 milliseconds
L. (Close 2M (2K2) Contactor)				140 milliseconds
M. (Wait to look for Transition complete)			milliseconds	2.32 to 2.38 second
N. (Filtering time on Transition complete input)			milliseconds	160 to 240 milliseconds

# Control Sequence of Operation

Current passing through circuit breaker 1Q5 reaches 2 normally open parallel sets of contacts: those of refrigerant and oil pump relay (1A7-J2-5 to 1), and the 2K11 interlocking relay. Connected at module 1A7-J2-2 to 4.

**Note:** While the (1A7-J2-5 to 1) relay automatically is closed by the main processor 1A22 as a part of the start sequence. It can also be closed manually by changing the oil pump status to "ON" in the manual override mode menu of DynaView™.

Closure of the (1A7-J2-5 to 1), or 2K11 contacts also allows current to pass through the coil of the refrigerant

pump starter relay (4K8), to the start windings of the refrigerant pump. When motor 4M3 first starts, current draw is high: This causes current sensing relay 4K8 to close its normally open contacts and pull in of pump Capacitor 4C1. Increasing motor speed and related decreasing current through the main winding and relay coil reduce the magnetic force and the armature "Drops out" to open the start contacts and disconnect the start windings and capacitor. Current now flows only to the Run windings of the oil pump motor or refrigerant and oil pump motor.

Maximum Acceleration Timer Setting by Starter Type	
Wye-Delta	27 Seconds
Auto-Transformer	16
Primary Reactor	16
Across the Line	6
Solid State	15
AFD	30

# Machine Protection and Adaptive Control

## Momentary Power Loss (MPL) Protection.

Improved power measurement and protection algorithms allow the unit to accommodate more power anomalies than ever. If the chiller must shut down, faster restarts get the machine up and running as soon as possible.

Momentary power loss (MPL) detects the existence of a power loss to the compressor motor and responds by initiating the disconnection of the compressor motor from the power source. Power interruptions of less than 30 line-cycles are defined as momentary power losses. Tests have shown that these short-term power

interruptions can be damaging to the motor and compressor if the chiller is reconnected to the line while the motor and line phases do not match. The chiller will be shut down when a MPL is detected and will display a non-latching diagnostic indicating the failure. The oil pump will be run for the post-lube time period when power returns. The compressor and compressor motor are protected from damage from large torques and inrush currents resulting from reconnecting the compressor motor to the power source following a momentary loss of power.

MPL's greater than 2 or 3 cycles are detected resulting in unit shut down. Disconnection from the line is initiated within 6 line cycles of the power loss. MPL protection is active anytime the compressor is in the running mode. (The transition complete input has been satisfied).

MPL is enabled however can be disabled, if required via the service tool.

Figure 29. Sequence of operation: momentary power loss, (DynaView™ and starter module remain powered)

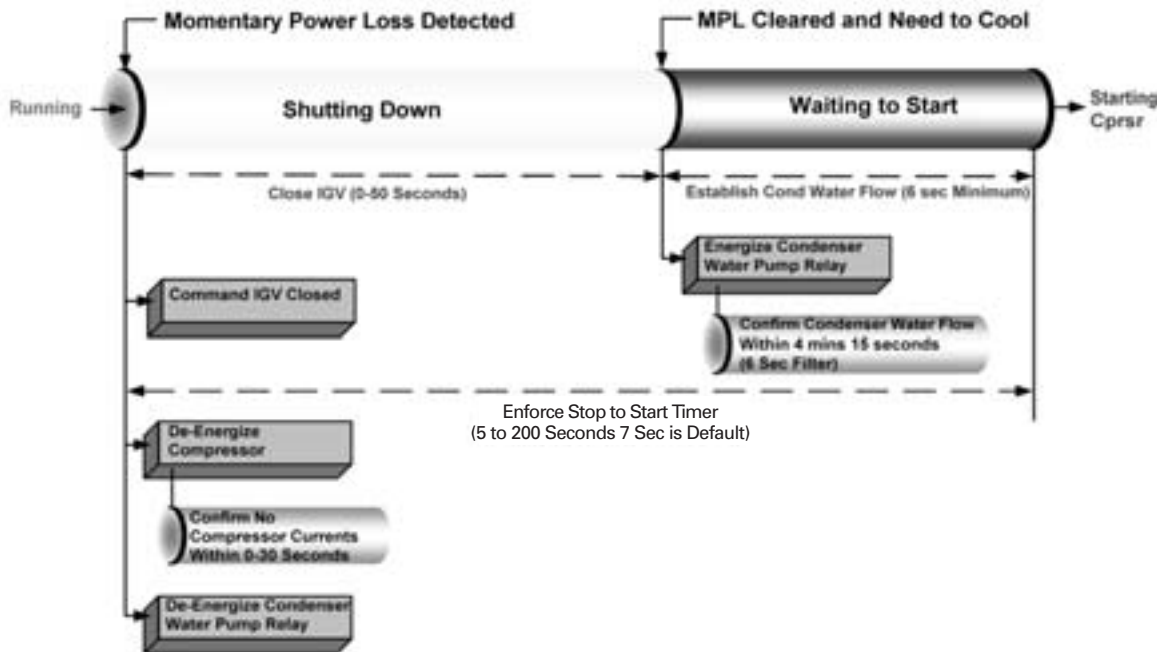



# Machine Protection and Adaptive Control

## Current Overload Protection

Motor currents are continuously monitored for over current protection and locked rotor protection. This protects the Chiller itself from damage due to current overload during starting and running modes but is allowed to reach full load amps. This overload protection logic is independent of the current limit. The overload protection will ultimately shut the unit down anytime the highest of the three phase currents exceeds the time-trip curve. A manual reset diagnostic describing the failure will be displayed.

Overload protection for the motor starts based on the Maximum Time to Transition permitted for a particular motor .

### Running Over Current Protection

In the run mode, a "time-to-trip" curve is looked at to determine if a diagnostic should be called. The UCP continuously monitors compressor line currents to provide running over current and locked rotor protection. Over current protection is based on the line with the highest current. It triggers a manually resettable diagnostic shutting down

the compressor when the current exceeds the specified time-trip curve. The compressor overload time trip curve is expressed as a percent of the Rated Load Amps of the compressor and is not adjustable:

Overload Must Hold = 102 Percent RLA.

Overload Must Trip in 20 (+0 -3) seconds = 112 Percent RLA  
(Note the above gives a nominal 20 second must trip point of 107 Percent RLA.)

Overload Must Trip in 1.5 seconds = 140 Percent RLA (Nominal)

The linear time-trip curve is as follows:

**Figure 30. Overload trip time versus percent RLA**

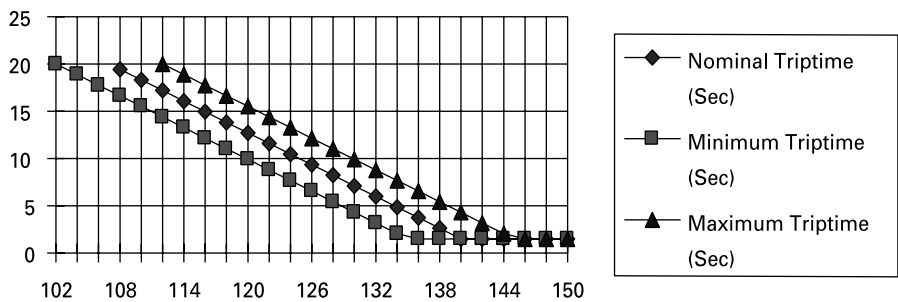

The Maximum Acceleration Time Setting and Current Transformer Setting are factory set however can be set with the service tool;



# Machine Protection and Adaptive Control

---

## Current Limit Protection

Current Limit Protections exist to avoid motor current overload and damage to the compressor motor during starting and running. Compressor motor current is continuously monitored and current is controlled via a limit function that to prevent running into over current diagnostic trips.

The current limit control logic attempts to prevent the motor from shutting down on a diagnostic trip by limiting compressor current draw relative to an adjustable current limit DynaView™ Current Limit Setpoint. This setpoint can also be lowered to provide electrical demand limiting on the unit as required. This could also be set to allow the Chiller to continue to run at a lower load to avoid tripping off via a diagnostic.

The Current Limit function uses a PID algorithm (Similar to the Leaving Water Temperature control) that allows the chiller to run at the Current Limit Setpoint. At machine startup, or with any setpoint change the new current limit setpoint reached after the is filtered setpoint time elapses. The minimum current limit setpoint is default set to 40 percent RLA (20-100 percent). The filtering time is default set to 10 minutes (0-120 minutes), however these can be altered via the service tool. This filtered setpoint allows for stable control if the Current Limit setpoint is adjusted during a run.

The Current Limit Setpoint (CLS) can be changed from: Front Panel, External Analog input (with GBAS (external) option), or Tracer (Tracer option). However, If present Tracer current setpoint has the highest priority, unless disabled in the DynaView™ Setpoint source override menu. The External CLS has second priority, and will be used if Tracer is disabled or not installed. The Front Panel Setpoint has the lowest priority, and will be used if Tracer and the External CLS are both disabled.

## Phase Loss Protection

Loss of phase detection protects the chiller motor from damage due to a single-phasing condition. The controls will shut down the chiller if any of the three phase currents feeding the motor are lost. The shutdown will result in a latching diagnostic indicating the failure. The motor is protected from over-current during a single-phase condition by the Current Overload Protection feature. Phase Loss Protection provides redundant protection and a diagnostic that more accurately describes the fault.

## Reverse Rotation Protection

This function protects the compressor from being driven in the reverse direction. Incorrect phase rotation detection results in a manually resettable diagnostic. Phase Reversal protection is default to Enable, however can be disabled via the service tool.

# Machine Protection and Adaptive Control

---

## Differential to Start or Stop

The Differential to Start setpoint is adjustable from 1 to 10°F (0.55 to 5.55°C) and the Differential to Stop setpoint adjustable from 1 to 10°F (0.55 to 5.55°C). Both setpoints are with respect to the Active Chilled Water Setpoint. When the chiller is running and the LWT (Leaving Water Temperature) reaches the Differential to Stop setpoint the chiller will go through its shutdown sequence to AUTO. (Refer to Figure 10.)

## SoftLoading

Softloading stabilizes the startup control during the initial chiller pulldown. Soft loading is used to bring the building loop temperature from its start value to the Chilled Water or Hot Water Setpoint in a controlled manner. Without soft loading, the chiller controls will load the chiller rapidly and use the full chiller capacity to bring the loop temperature to setpoint. Although the start temperature of loop may have been high, the actual system load may be low. Thus, when the setpoint is met the chiller must unload quickly to the system load value. If it is not able to unload quickly enough, the supply water temperature will

drop below setpoint and may even cause the chiller to cycle off. Soft loading prevents the chiller from going to full capacity during the pulldown period. After the compressor has been started, the starting point of the filtered setpoint is initialized to the value of the Evaporator Leaving Water temperature and the percent RLA.

There are three independent Softload setpoints:

- Capacity Control Softload Time (default to 10 minutes, 0-120 minutes) This setting controls the time constant of the Filtered Chilled Water Setpoint.
- Current Limit Control Softload Time (default 10 minutes; 0-120 minutes) This Setting controls the time constant of the Filtered Current Limit Setpoint.
- Current Limit Softload Starting Percent (default is 40 percent RLA; 20-100 percent): This setting controls the Starting point of the Filtered Current Limit Setpoint

Service tool provides access to these three setpoints, if it is determined necessary to change from the defaults.

Softloading is not active during Ice Making or during the Ice To normal Transition. Softloading will be enabled after the Ice to normal Transition timer has expired.

## Minimum and Maximum Capacity Limit

A Minimum Capacity can be set to limit the unloading ability of the compressor thus forcing differential to stop to be reached cycling the chillers. Minimum capacity limit will be displayed when in this limit mode. This indicates when the chiller is running fully unloaded.

Similarly a maximum capacity can be set to limit normal chilled water temperature control, the maximum capacity relay is energized which is a signal used by generic BAS systems to start another chiller.

The minimum (default at 0 percent) and maximum (default at 100 percent) capacity are adjustable via the service tool.



# Machine Protection and Adaptive Control

---

## Evaporator Limit

Evaporator refrigerant temperature is continuously monitored to provide a limit function that prevents low refrigerant temperature trips which allows the chiller to continue to run at a reduced load instead of tripping off at the Low Evaporator Refrigerant Temperature Cutout Setpoint (LRTC).

Evaporator limit could occur with an initial pull down of a loop where the Condenser is colder than the Evaporator (Inverted Start), the Evaporator refrigerant temperature may drop below the Low Refrigerant Temperature Cutout (LRTC). This limit prevents the unit from shutting down on a diagnostic during this type of pulldown. Another example is a Chiller that is low on refrigerant charge will run with low Evaporator refrigerant temperatures. This limit allows the chiller to continue to run at a reduced load.

Evaporator Limit uses the Evaporator Refrigerant Temperature sensor in a PID algorithm (Similar to the Leaving Water Temperature control) that allows the chiller to run at the LRTC + 2 degree F.

When actively limiting machine control "Evaporator Temperature Limit" will be displayed as a sub-operating mode.

## Leaving Water Temperature Cutout

Leaving water temperature cutout is a safety control that protects the chiller from damage caused by water freezing in the evaporator. The cutout setpoint is factory set however is adjustable with the Service tool.

The "Leaving Water Temperature Cutout Setpoint" is independently adjustable from the chilled water setpoint and factory set. Shutdown of the compressor due to violation of the Leaving Water Temperature

Cutout results in an automatically resettable diagnostic (MAR). The DynaView™ Operating Mode indicates when the "Leaving Water Temperature Cutout Setpoint" conflicts with the chilled water temperature setpoint by a message on the display. The "Leaving Water Temperature Cutout Setpoint" and chilled water setpoint, both active and front panel, are separated by a minimum of 1.7°F. See Cutout Strategy, Figure 27. When either difference is violated, the UCP does not permit the above differences to be violated and the display exhibits a message to that effect and remains at the last valid setpoint. After violation of the "Leaving Water Temperature Cutout Setpoint" for 30°F seconds the chiller will shutdown and indicate a diagnostic.

# Machine Protection and Adaptive Control

---

## Low Refrigerant Temperature Cutout

The purpose of the low evaporator refrigerant temperature protection is to prevent water in the evaporator from freezing. When the Low Evaporator Refrigerant Temperature Cutout (LRTC) trip point is violated, a latching diagnostic indicating the condition is displayed. The Low Evaporator Refrigerant Temperature Diagnostic is active in both the Running and Stopped modes.

The Low Evaporator Refrigerant Cutout Setpoint is factory set to 36°F. This can be altered via the service tool. A Service Tool adjustable setpoint that should be based on the percentage of antifreeze used in the customer's water loop. The Service

tool will display a warning message such as "Warning: Adequate Antifreeze required" for any Evaporator Refrigerant Temperature Cutout below 28°F and any Leaving Water Temperature Cutout below 35°F.

The percent of antifreeze required is a function of the leaving water temperature setpoint and the worse case (lowest permitted water flow) approach temperatures of the chiller's evaporator design.

## Head Relief Relay

Surge, condenser limit, and certain conditions in ice mode can energize the head relief relay. **Note:** There is a TechView programmable head relief relay filter time setpoint. The default is 1 minute.

# Machine Protection and Adaptive Control

Figure 31. Cutout strategy

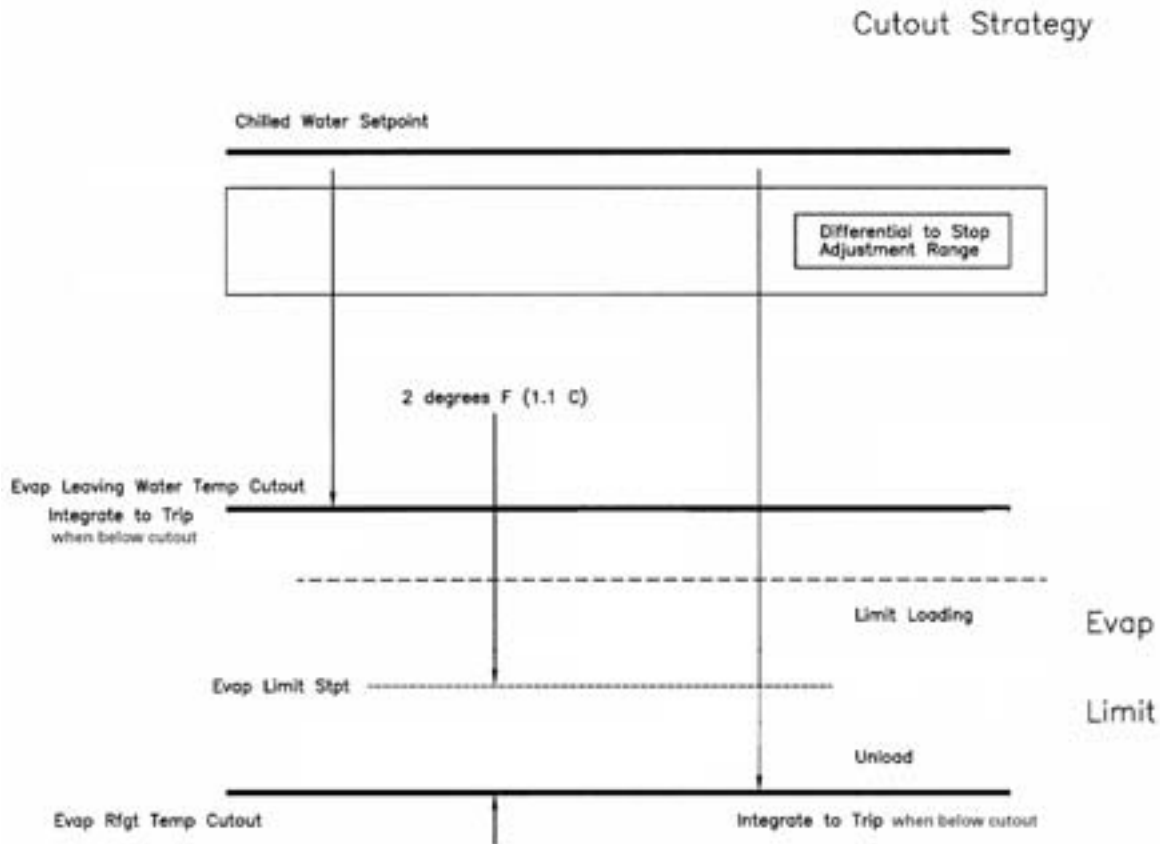

Limit Loading: The potential to limit loading increases as the saturated evaporator temperature approaches the evaporator limit setpoint.

Unload: The potential to unload increases as the saturated evaporator temperature falls further below the evaporator limit setpoint.

- Figure 31 illustrates these functions as follows:
- chilled water setpoint (top bold line)
  - evap leaving water temp cutout (center bold line)
  - evap rfgt temp cutout (bottom bold line)

# Machine Protection and Adaptive Control

---

## Condenser Limit

Condenser pressure is continuously monitored to provide a limit function that prevents High Pressure Cutout (HPC) trips. This protection is called Condenser Refrigerant Pressure Limit, or High Pressure Limit. A fully loaded compressor, operating at high Evaporator Leaving Water Temperature (ELWT) and high condenser temperatures causes high condenser pressures. The purpose of this limit is to avoid High Pressure Cutout (HPC) trips by allowing the Chiller to continue to run at a lower load instead of tripping off via HPC.

The Condenser Limit will be based from a pressure conversion from the Condenser Refrigerant Temperature sensor, unless there is a Condenser Refrigerant Pressure sensor installed (CDRP option). If the Condenser Refrigerant Pressure Sensor is installed, then the limit will be based from the Pressure sensor.

When limited by this action, "Condenser Pressure Limit" will be displayed as a sub-operating mode. The Condenser Limit Setpoint is factory set (93 percent of HPC), however can be altered via the service tool.

# Machine Protection and Adaptive Control

---

## Restart Inhibit

This function provides short cycle protection for the motor, and indirectly also short cycling protection for the starter since the starter is designed to operate the motor under all the conditions of motor performance.

The operation of the restart inhibit function is dependent upon two setpoints. The Restart Inhibit Free Starts (1-5, 3 default), and the Restart Inhibit Start to Start Timer (10-30min, 20 default). These settings are adjustable via the service tool.

## Restart Inhibit Free Starts

This setting will allow a number of rapid restarts equal to its value. If the number of free starts is set to "1", this will allow only one start within the time period set by the Start to Start Time Setting. The next start will be allowed only after the start to start timer has expired. If the number of free starts is programmed to "3", the control will allow three starts in rapid succession, but thereafter, it would hold off on a compressor start until the Start to Start timer expired.

## Restart Inhibit Start to Start Time Setting

This setting defines the shortest chiller cycle period possible after the free starts have been used. If the number of free starts is programmed to "1", and the Start to Start Time Setting is programmed to 10 minutes, then the compressor will be allowed one start every 10 minutes. The start-to-start time is the time from when the motor was commanded to energize to when the next command to enter prestart is given.

## Clear Restart Inhibit

A Clear Restart Inhibit "button" is provided within Settings; Manual Override on the DynaView display. This provides a way for an operator to allow a compressor start when there is a currently active Restart Inhibit that is prohibiting such a start. The "button" press will have no other function than to remove the restart inhibit if there is one active. It does not change the count of any internal restart inhibit timers or accumulators.

The restart inhibit function, setpoints and clear features exist for each compressor and operate independently of other compressors on that chiller.

During the time the start is inhibited due to the start-to-start timer, the DynaView shall display the mode 'Restart Inhibit' and the also display the time remaining in the restart inhibit.

A "Restart Inhibit Invoked" warning diagnostic will exist when the attempted restart of a compressor is inhibited

If all three motor winding temperatures are less than the "Restart Inhibit Temperature" Setpoint (default 165°F/74°C) then restart is allowed.

Restart inhibit mode exist when at least one of the three motor winding temperatures is greater than or equal to the "Restart Inhibit Temperature" Setpoint but less than 265°F/129.4°C. Restart inhibit mode is entered until all three motor winding temperatures are less than the 'Restart Inhibit Temperature' Setpoint

**Note:** When one of the three motor winding temperatures is 265°F/129.4°C or greater, a High Motor Winding Temperature diagnostic will occur.

**Note:** When the start is inhibited by the restart inhibit function, the time remaining will be displayed along with the restart inhibit mode.



# Machine Protection and Adaptive Control

---

## **High Vacuum Lockout**

The oil sump pressure is below the lockout setpoint. Starting of compressor is inhibited as a result.

## **Low Oil Temperature Start Inhibit**

The oil temperature is at or below the low oil temperature start inhibit setpoint (143°F/61.7°C). The heater is energized to raise the oil temperature.

Low oil temperature is indicative of refrigerant dilution in the oil. Oil temperature is used to estimate this dilution since the oil temperature directly corresponds to amount of refrigeration dilution in the oil. It is required that oil contains minimal refrigerant in it. This is accomplished by boiling the refrigerant out of the oil by maintaining a high enough oil temperature.

If the oil temperature is at or below a given Low Oil Temperature Inhibit setting (default 95°F/35°C) the compressor cannot be started. This is an inhibit mode and will be reported to the operator interface. The oil heater is energized in an attempt to raise the oil temperature over this inhibit temperature setpoint. The compressor is inhibited from starting until the oil temperature is raised 5 or more degrees above this setpoint.

The Low Oil Temperature Start Inhibit is tested on every start unless a quick restart is being performed during post lube.

If the Enhanced Oil Temperature Protection setting is enabled, the Low Oil Temperature Start Inhibit value is the greater of 100°F/37.8°C or the Saturated Evaporator Refrigerant Temperature + 30°F/16.7°C.

If the Enhanced Oil Temperature Protection setting is not enabled, the Low Oil Temperature Start Inhibit value is settable with the Low Oil Temperature Start Inhibit Setpoint via the service tool.



# Machine Protection and Adaptive Control

---

## **Oil Temperature Control**

The oil heater is used to maintain the oil temperature within +/- 2.5°F (1.4°C) of the oil temperature control setpoint. The oil heater is commanded off when the oil pump is commanded on.

If the oil temperature is at or below the Low Oil Temperature Cutout setpoint, this diagnostic will be issued and stops the compressor.

This diagnostic is ignored for the first 10 minutes of compressor run. After that, if the oil temperature falls below this cutout temperature for more than 60 consecutive seconds this diagnostic is issued.

## **High Oil Temperature Cutout**

Name: High Oil Temperature Cutout  
Type of Diagnostic: Latching, results in Immediate Shutdown.  
Default Setpoint value: 180°F (82.2°C)

Implemented to avoid overheating of the oil and the bearings.

If the oil temperature is at or above the High Oil Temperature Cutout setpoint this diagnostic will be issued - which will stop the compressor.

If Oil Temperature violates this temperature cutout for more than 120 seconds this diagnostic is issued.

## **Manual Oil Pump Control**

The oil pump control accepts commands to turn on the oil pump. The manual oil pump choices will be "Auto" or "On". When the oil pump is commanded "On", it will revert to "Auto" in 15 minutes.

# Machine Protection and Adaptive Control

---

## Controls Chilled Water Reset (CWR)

Chilled water reset is designed for those applications where the design chilled water temperature is not required at partload. In these cases, the leaving chilled water temperature setpoint can be reset upward using the CWR features.

When the CWR function is based on return water temperature, the CWR feature is standard.

When the CWR function is based on outdoor air temperature, the CWR feature is an option requiring an outdoor temperature sensor module installed in the UCP panel, and sensor installed outdoors.

The type of CWR is selected in the Operator Interface settings Menu along with the Reset Ratio, Start Reset Setpoint, and the Maximum Reset Setpoint.

The following equations and parameters apply for CWR.

### Return Water

$CWS' = CWS + \text{RATIO} (\text{START RESET} - \text{TWE} - \text{TWL})$  and  $CWS' > \text{or} = CWS$  and  $CWS' - CWS < \text{or} = \text{Maximum Reset}$ .

### Outdoor Air Temperature

$CWS = CWS + \text{RATIO} (\text{START RESET} - \text{TOD})$  and  $CWS' > \text{or} = CWS$  and  $CWS - CWS < \text{or} = \text{Maximum Reset}$ .

### Where

$CWS'$  is the new chilled water setpoint.

$CWS$  is the active chilled water setpoint before any reset has occurred.

RESET RATIO is a user adjustable gain.

START RESET is a user adjustable reference.

TOD is the Temperature Outdoor Sensor.

TWE is entering evaporator water temperature.

TWL is the Leaving Evaporator Temperature.

MAXIMUM RESET is a user adjustable limit providing the maximum amount of reset. For all types of reset,  $CWS - CWS < \text{or} = \text{Maximum Reset}$ .

Both Return and Outdoor Reset do not apply to Heating Mode where the UCP is controlling the Leaving Condensing Hot Water Temperature.

Constant Return Reset will reset the leaving water temperature setpoint so as to provide a constant entering water temperature. The Constant Return Reset equation is the same as the Return Reset equation except on selection of Constant Return Reset, the UCP shall automatically set RATIO, START RESET, and MAXIMUM RESET to the following:

The RATIO = 100 percent

The START RESET = Design Delta Temperature

The MAXIMUM RESET = Design Delta Temperature

The equation for Constant Return is as follows:



# Machine Protection and Adaptive Control

**Table 3. Values for start reset types**

The values for "RESET TYPE" are:

Reset Type:	Disable	Outdoor Air Reset	Return Reset	Const Return Reset
-------------	---------	-------------------	--------------	--------------------

The values for "RESET RATIO" for each of the reset types are:

Reset Type	Reset Ratio Range	Increment English Units	Increment SI Units	Factory Default Value
Return	10 to 120 percent	1 percent	1 percent	50 percent
Outdoor	-80 to 80 percent	1 percent	1 percent	10 percent

The values for "START RESET" for each of the reset types are:

Reset Type	Start Reset Range	Increment English Units	Increment SI Units	Factory Default Value
Return	4 to 30°F (2.2 to 16.7°C)	0.1°F	0.1°C	10°F (5.6°C)
Outdoor	50 to 130°F (10 to 54.44°C)	0.1°F	0.1°C	90°F (32.22°C)

The values for "MAXIMUM RESET" for each of the reset types are:

Reset Type	Maximum Reset Range	Increment English Units	Increment SI Units	Factory Default Value
Return	0 to 20°F (0.0 to 11.11°C)	0.1°F	0.1°C	5°F (2.78°C)
Outdoor	0 to 20°F (0.2 to 11.11°C)	0.1°F	0.1°C	5°F (2.78°C)

## Constant Return

$CWS' = CWS + 100$  percent (Design Delta Temperature) - (TWE-TWL) and  $CWS' > \text{or} = CWS$  and  $CWS' - CWS < \text{or} = \text{Maximum Reset}$

Notice that Constant Return is nothing more than a specific case of Return Reset offered for operator convenience.

When any type of CWR is enabled, the UCP will step the CWS toward the desired CWS (based on the above equations and setup parameters) at a rate of 1°F every 5 minutes until the Active CWS equals the desired CWS'. This applies when the chiller is running only.

## Using the Equation for calculating CWR for Outdoor Air Temperature

### Equation:

Degrees of Reset = Reset Ratio\*(Start Reset - TOD)

The chiller will start at the Differential to Start value above a fully reset CWS or CWS for both Return and Outdoor Reset.

The graph on the next page, shows the reset function for Outdoor Air Temperature: **Note:** This graph assumes that Maximum Reset is set to 20 degrees.

### Degrees of Reset:

Degrees of Reset = Active CWS - Front Panel CWS

or

Degrees of Reset =  $CWS' - CWS$

To obtain Active CWS from Degrees of Reset:  $\text{Active CWS} = \text{Degrees of Reset} + \text{Front Panel CWS}$

(\* = multiply)

# Machine Protection and Adaptive Control

## Reset Ratio:

The Reset Ratio is displayed as a percentage. To use it in the above equation it must be converted to its decimal form.

Reset Ratio percent /100 = Reset Ratio decimal

Example of converting Reset Ratio:

If the Reset Ratio displayed on the CLD is 50 percent then use (50/100)=.5 in the equation

**TOD** = Outdoor Air Temperature

**Start Reset** = Outdoor Air Start Reset

Example of Calculating Reset for Outdoor Air Temperature:

If:

Reset Ratio = 35 percent

Start Reset = 80

TOD = 65

Maximum Reset = 10.5

How many Degrees of Reset will there be?

Degrees of Reset = Reset Ratio\*(Start Reset - TOD)

Degrees of Reset = .35\*(80-65)

Degrees of Reset = 5.25

If:

Reset Ratio = -70 percent

Start Reset = 90

TOD = 100

Maximum Reset = 17

How many Degrees of Reset will there be?

Degrees of Reset = Reset Ratio\* (Start Reset - TOD)

Degrees of Reset = -7\* (90-100)

Degrees of Reset = 7

(\* = multiply)

**Figure 32. Outdoor air temperature versus degrees of reset**

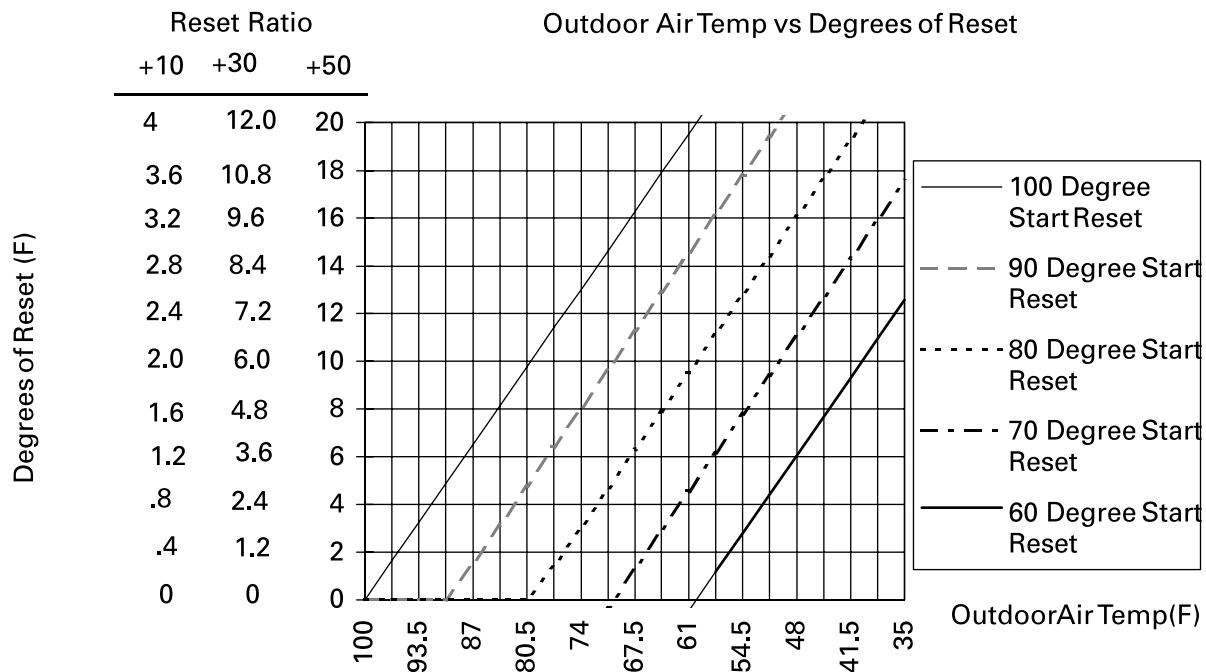

# Machine Protection and Adaptive Control

Figure 33. Reset function for return CWR

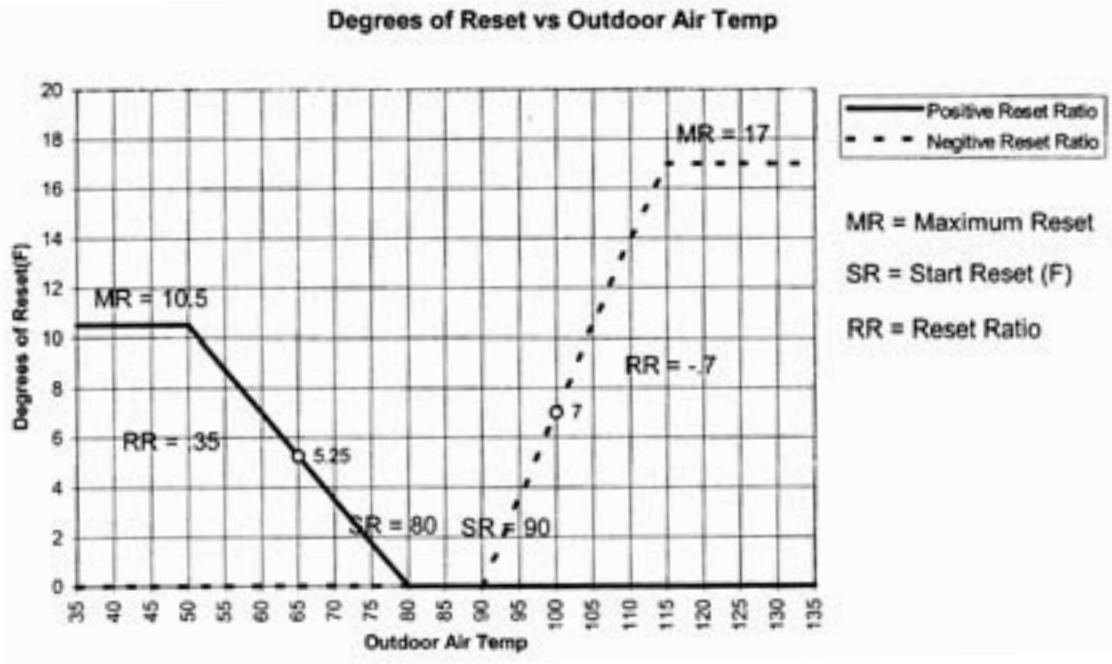
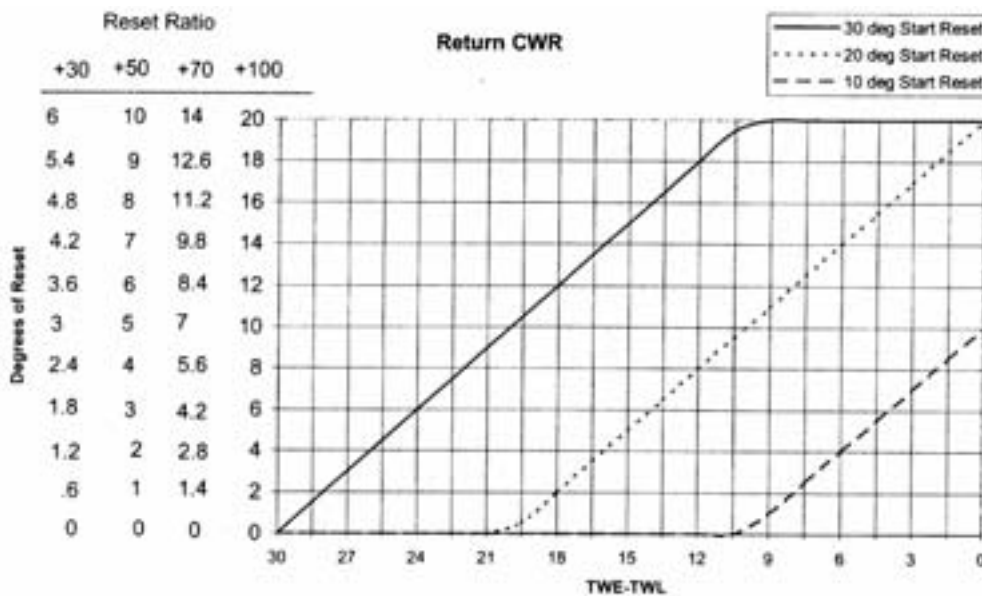

Figure 34. Reset function for return CWR



Note: This graph assumes Maximum Reset is set to 20 degrees.

# Machine Protection and Adaptive Control

---

Example of Calculating Return Reset:

If:

Reset Ratio = 50%

Start Reset = 25

TWE = 65

TWL = 45

Maximum Reset = 8

How many Degrees of Reset will there be?

Degrees of Reset = Reset Ratio\*(Start Reset - (TWE-TWL))

Degrees of Reset = .5\*(25-(65-45))

Degrees of Reset = 2.5

If:

Reset Ratio = 70%

Start Reset = 20

TWE = 60

TWL = 53

Maximum Reset = 14

How many Degrees of Reset will there be?

Degrees of Reset = Reset Ratio\*(Start Reset - (TWE-TWL))

Degrees of Reset = .7\*(20-(60-53))

Degrees of Reset = 9.1

# Machine Protection and Adaptive Control

Figure 35. Return CWR

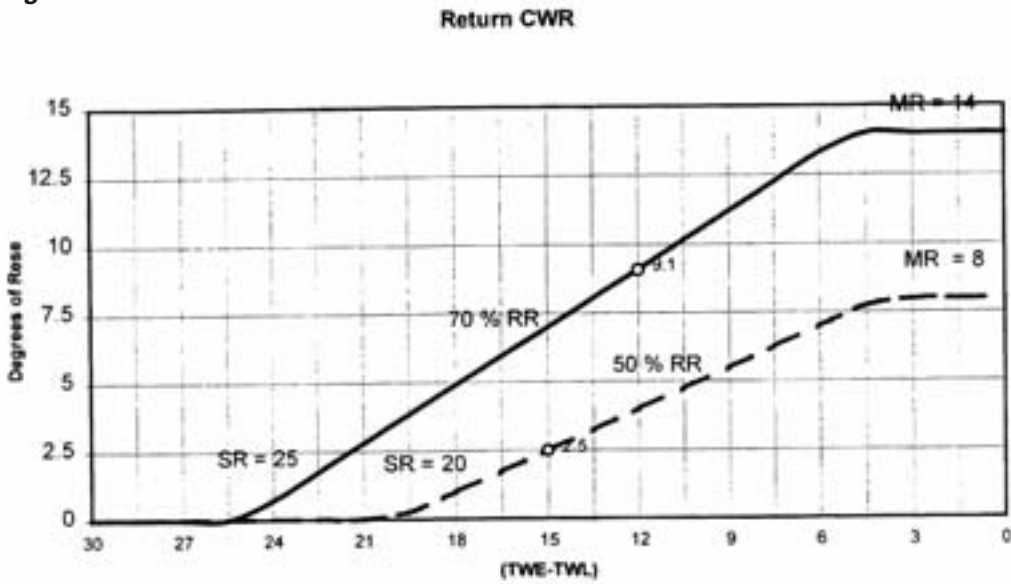
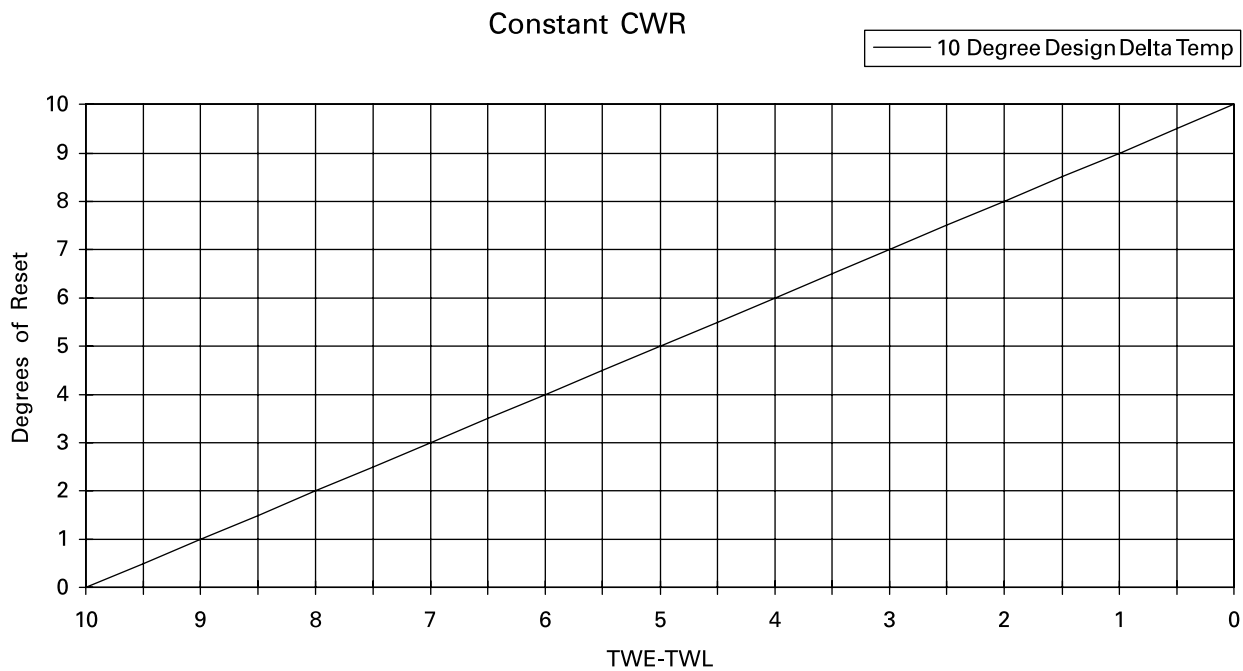

Figure 36. Constant CWR





# Unit Startup

---

## Unit Start-Up Procedures

### Daily Unit Start-Up

1. Verify the chilled water pump and condenser water pump starter are in "ON" or "AUTO".
2. Verify the cooling tower is in "ON" or "AUTO".
3. Check both oil tank oil level(s); the level must be visible in or above the lower sight glass. Also, be sure to check the oil tank temperature; normal oil tank temperature before start-up is 140°F to 145°F (60 to 63°C).
4. **Note:** Each oil heater is energized during the compressor off cycle. During unit operation, the oil tank heater is de-energized.
5. Check the chilled water setpoint and readjust it, if necessary, in the Chiller Settings menu.
6. If necessary, readjust the current limit setpoint in the Chiller Setpoints menu.
7. Press "AUTO".

The UCP also checks compressor motor winding temperature, and a minimum restart time is initiated if the winding temperature is less than 265°F. The chilled water pump relay is energized and evaporator water flow is proven.

Next, the UCP checks the leaving evaporator water temperature and compares it to the chilled water setpoint. If the difference between these values is less than the start differential setpoint, cooling is not needed.

If the UCP determines that the difference between the evaporator leaving water temperature and chilled water setpoint exceeds the start differential setpoint, the unit enters the initiate Start Mode and the oil pump and Refrigerant pump and the condenser water pump are started. If condenser water flow is not proven (flow switch 5S3 does not close) within 4-minutes 15 seconds, the unit is locked out on a MMR Diagnostic.

Oil pressure must be verified within 3 minutes or a MMR diagnostic is generated.

When less than 5 seconds remain on the restart inhibit, the pre-start starter test is conducted on Y-Delta starters. If faults are detected, the unit's compressor will not start, and a MMR Diagnostic will be generated.

If the compressor motor starts and accelerates successfully, "Unit is Running" appears on the display. At this time the purge unit will start operating on "Automatic" and will continue to operate as long as chiller compressor is running.

**Note:** Whenever the UCP detects a MMR diagnostic condition during start-up, unit operation is locked out, and manual reset is required before the start-up sequence can begin again. If the fault condition has not cleared, the UCP will not permit restart.

## Unit Startup

---

When the cooling requirement is satisfied, the UCP originates a “Shutting down” signal. The inlet guide vanes are driven closed for 50 seconds, and the unit enters a 3-minute post-lube period. The compressor motor and condenser water pump starter are de-energized immediately, but the oil pump continues to run during this 3-minute interval; the evaporator pump will continue to run.

Once the post-lube cycle is done, the unit returns to auto mode.

### Seasonal Unit Start-Up

1. Close all drain valves, and re-install the drain plugs in the evaporator and condenser headers.
2. Service the auxiliary equipment according to the start-up and maintenance instructions provided by the respective equipment manufacturers.
3. Vent and fill the cooling tower, if used, as well as the condenser and piping. At this point, all air must be removed from the system (including each pass). Then close the vents in the condenser water boxes.
4. Open all of the valves in the evaporator chilled water circuit.
5. If the evaporator was previously drained, vent and fill the evaporator and chilled water circuit. When all air is removed from the system (including each pass), close the vent valves in the evaporator water boxes.
6. Lubricate the external vane control linkage as needed.
7. Check the adjustment and operation of each safety and operating control.
8. Close all disconnect switches.
9. Perform instructions listed in “Daily Unit Start-up” section.

### WARNING

#### Live Electrical Components!

**During installation, testing, servicing and troubleshooting of this product, it may be necessary to work with live electrical components. Have a qualified licensed electrician or other individual who has been properly trained in handling live electrical components perform these tasks. Failure to follow all electrical safety precautions when exposed to live electrical components could result in death or serious injury.**

### WARNING

#### Toxic Hazards!

- Do not run evaporator water pump longer than 30 minutes after the chiller is shutdown.
- Ensure that the evaporator is isolated from the hot water loop before changeover to heating mode.

**Do not allow the chiller to increase above 110°F in temperature while unit is off. Failure to prevent high chiller temperature will cause the inside pressure to rise. The rupture disk is designed to relieve and discharge the refrigerant from the unit if the pressure in the evaporator exceeds 15 PSIG (103.4 Kpa). A significant release of refrigerant into a confined space due to a rupture disk failure could displace available oxygen to breathe and cause possible asphyxiation. Should a rupture disk fail, evacuate the area immediately and contact the appropriate rescue or response authority. Failure to take appropriate precautions or react properly to a potential hazard could result in death or serious injury.**

# Unit Shutdown

---

## Unit Shutdown Procedures

### Daily Unit Shutdown

**Note:** Refer to Start-Run Shutdown sequence in General Information Overview Sequence of Operation.

1. Press STOP.
2. After compressor and water pumps shutdown turn Pump Contactors to OFF or open pump disconnects.

### Seasonal Unit Shutdown

## CAUTION

### Oil Pump Heater Operation!

**CONTROL POWER DISCONNECT SWITCH MUST REMAIN CLOSED TO ALLOW OIL SUMP HEATER OPERATION. Failure to do this will allow refrigerant to condense in the oil pump.**

3. Open all disconnect switches except the control power disconnect switch.
4. Drain the condenser piping and cooling tower, if used. Rinse with clean water.

5. Remove the drain and vent plugs from the condenser headers to drain the condenser. Air dry bundle of residual water.

6. Once the unit is secured for winter, the maintenance procedures described under "Annual Maintenance" in the Periodic Maintenance section of this manual should be performed by qualified Trane service technicians.

**Note:** During extended shutdown, be sure to operate the purge unit for a 2-hour period every two weeks. This will prevent the accumulation of air and noncompensable in the machine. To start the purge, change the purge mode to ON in the DynaView™ Settings Purge Menu. Remember to turn the purge mode to AUTO after the 2-hour run time.

### Trouble Analysis

If the ALARM indicator on the control panel is flashing, an MMR diagnostic has occurred. Refer to Diagnostic section for trouble shooting information.



# Periodic Maintenance

---

## Overview

This section describes the basic chiller preventive maintenance procedures, and recommends the intervals at which these procedures should be performed. Use of a periodic maintenance program is important to ensure the best possible performance and efficiency from a CenTraVac® chiller.

Recommended purge maintenance procedures for the EarthWise Purge unit are covered by PRGD-SVU01A-EN or the latest revision which can be obtained at the nearest Trane office.

## Record Keeping Forms

An important aspect of the chiller maintenance program is the regular completion of records. Provided at the end of this manual are copies of the "Annual Inspection Check List and Report", "CenTraVac Commissioning Checklist and a "Start-Up Report" with a TechView settings record. When filled out

accurately by the machine operator, the completed logs can be reviewed to identify any developing trends in the chiller's operating conditions.

For example, if the machine operator notices a gradual increase in condensing pressure during a month's time, he can systematically check, then correct the possible cause(s) of this condition (fouled condenser tubes, noncondensable in the system, etcetera)

## Daily Maintenance and Checks

[ ] Check the chiller's evaporator and condenser pressures, oil tank pressure, differential oil pressure and discharge oil pressure. Compare the readings with the values provided in the Normal Chiller Operating Characteristics table.

**IMPORTANT:** IT IS HIGHLY RECOMMENDED THAT THE OPERATING LOG BE COMPLETED ON A DAILY BASIS.

## CAUTION

### Moisture Contamination!

**IF FREQUENT PURGING IS REQUIRED, MONITOR PURGE PUMPOUT RATE, IDENTIFY AND CORRECT SOURCE OF AIR OR WATER LEAK AS SOON AS POSSIBLE. Failure to do so can shorten chiller life expectancy, due to moisture contamination caused by leakage.**

[ ] Check the oil level in the chiller oil sump using the two sight glasses provided in the oil sump head. When the unit is operating, the oil level should be visible in the lower sight glass.

# Periodic Maintenance

## WARNING

### Hazardous Voltage w/Capacitors!

Disconnect all electric power, including remote disconnects before servicing. Follow proper lockout/tagout procedures to ensure the power cannot be inadvertently energized. For variable frequency drives or other energy storing components provided by Trane or others, refer to the appropriate manufacturer's literature for allowable waiting periods for discharge of capacitors. Verify with an appropriate voltmeter that all capacitors have discharged. Failure to disconnect power and discharge capacitors before servicing could result in death or serious injury. Note: For additional information regarding the safe discharge of capacitors, see PROD-SVB06A-EN or PROD-SVB06A-FR

### Weekly Maintenance

[ ] Complete all recommended daily maintenance procedures and checks. Complete logs on a daily basis.

### Every 3 Months

[ ] Complete all recommended weekly maintenance procedures. Refer to the previous sections for details.

[ ] Clean all water strainers in the CenTraVac water piping system.

### Every 6 Months

### *Normal Chiller Operating Characteristics*

Operating Characteristic	Normal Reading
Approx. Evaporator Pressure	6 to 9 PSIA (-9 to -6 PSIG)
Approx. Condenser Pressure (See Notes 1 and 2)	17 TO 27 PSIA (2 to 12 PSIG) (Standard Condensers)
Oil Sump Temperature:	
Unit Not Running	140°F to 145°F (60°C to 63°C)
Unit Running	80°F to 162°F (26.6°C to 72°C)
Differential Oil Pressure	18 to 22 psid

# Periodic Maintenance

---

[ ] Complete all recommended quarterly maintenance procedures.

[ ] Lubricate the vane control linkage bearings, ball joints, and pivot points; as needed a few drops of light machine oil (SAE-20) is sufficient.

[ ] Lubricate vane operator tang o-rings as described in the maintenance section.

[ ] Lubricate the oil filter shutoff valve o-rings by removing the pipe plug and adding several drops of Trane OIL00022. Replace plug.

[ ] Drain the contents of the rupture disc and purge discharge ventline drip-leg, into an evacuated waste

container minimally and more often if the purge is operated excessively.

Also, apply one or two drops of oil on the vane operator shaft and spread it into a very light film; this will protect the shaft from moisture and rust.

## Off-Season Maintenance

During those periods of time when the chiller is not operated, be sure the control panel is energized. This is to keep the purge operational, the oil heater warm and will also keep air out of the machine.

## Annual Maintenance

Shut down the chiller once each year to check the items listed ; a more detailed inspection checklist is

provided on the “Annual Inspection Checklist and Report” illustrated in this manual.

[ ] Perform the annual maintenance procedures referred to in the Maintenance Section of the purge manual.

[ ] Use an ice water bath to verify that the accuracy of the evaporator refrigerant temperature sensor (4R10) is still within tolerance (+ or - 2.0° at 32°F (1° at 0°C)). If the evaporator refrigerant temperature displayed on the UCP's read-out is outside this 4-degree tolerance range, replace the sensor.

**Note:** If the sensor is exposed to temperature extremes outside its normal operating range (0°F to 90°F) (-18°C to 32°C), check its accuracy at six-month intervals.

# Oil Maintenance

---

## Compressor Oil Change

It is recommended to change the oil and oil filter:

- After the first 1000 hours of chiller operation. For a chiller operated continuously this oil and oil filter change may be performed as soon as 1.5 months after first start-up, for a chiller operated intermittently it may be 4 or 6 months after first start-up.
- Again at the first scheduled annual maintenance, preferably within 6 to 12 months of the first oil change.

**Note:** Use only Trane OIL00022. A full oil change is 9 gallons of OIL00022.

Beyond the first year, recommendations are to subscribe to an annual oil analysis program rather than automatically change the oil as part of scheduled maintenance. Change the oil only if indicated by the oil analysis. Use of an oil analysis program will reduce the chillers overall lifetime waste oil

generation and minimize refrigerant emissions. The oil analysis should be performed by a qualified laboratory that is experienced in refrigerant and oil chemistry and in the servicing of Trane centrifugal chillers.

In conjunction with other diagnostics performed by a qualified service technician, oil analyses can provide valuable information on the performance of the chiller to help minimize operating and maintenance costs and maximize it's operating life. A drain fitting is installed in the oil filter top, after the oil filter, for obtaining oil samples.

## Oil Change Procedure

When oil analysis indicates the need to change compressor oil, use the following procedure for removing oil.

## CAUTION

### Heater Damage!

**The oil sump heater must be deenergized before draining the sump. Failure to do so could possibly burn out the oil sump heater.**

[ ] Draw the oil from the chiller through the oil charging valve on the chiller oil sump into an approved, evacuated tank; or,

[ ] Pump the oil from the chiller through the oil charging valve into an airtight resealable container, using a magnetically-driven auxiliary pump.

Forcing the oil from the oil sump by pressurizing the chiller (by raising chiller temperature or adding nitrogen) is not recommended.

Refrigerant dissolved in the oil can be removed and returned to the chiller by using an appropriate deep-vacuum recovery unit and heating and agitating the oil container. Follow all Federal, State and Local regulations with regard to disposal of waste oil.

## Oil Maintenance

---

### Replacing Oil Filter

Replace oil filter: (1) annually, (2) at each oil change, (3) or if erratic oil pressure is experienced during chiller operation.

### Oil Filter Replacement

Use the following procedure to service the oil filter. Refer to Figure 34.

1. Run the oil pump for two to three minutes to insure that the oil filter is warmed up to the oil sump temperature.
2. Turn the oil pump motor off.
3. Pull the "D" handle on the rotary valve locking pin out of its detent and rotate the valve to the "DRAIN" position. An offset pointer is located on top of the valve with wrench flats to allow turning. The spring force on the locking pin should allow the pin to drop into a detent at this position.
4. Allow at least 15 minutes for the oil to drain from the filter back into the oil sump.
5. Pull the "D" handle to unlock the pin and rotate the valve to the "Change Filter" position. This isolates the filter from the unit. The locking pin should drop into a detent in this position.
6. Remove and replace the filter as quickly as possible. Tighten filter 2/3 to 3/4 turn per instructions written on the filter. Place the used filter in a reusable container. Follow all local, state and federal regulations to dispose of the filter. Pull the "D" handle to unlock the pin and rotate the valve to the "RUN" position. The locking pin should drop into a detent in this position. The chiller is now ready for operation.
7. Purge unit.
8. Check oil pressure 18-22 psi.



# Maintenance

## Other Maintenance Requirements

Compressors using new seal technology will not use O-rings. The O-ring has been replaced by Loctite 515 applied at a minimum film thickness of .010 applied across the width of the flange. The current jack bolt holes remain for disassembly.

## CAUTION

### Oil Supply System Problems!

**Plugging of oil supply system could lead to bearing failure. Failure to use care could result in Loctite getting into the chiller which may cause problems with the Oil supply system and eductor system.**

[ ] Inspect the condenser tubes for fouling; clean if necessary.

## WARNING

### Hazardous Voltage w/ Capacitors!

**Disconnect all electric power, including remote disconnects before servicing. Follow proper lockout/tagout procedures to ensure the power cannot be inadvertently energized. For variable frequency drives or other energy storing components provided by Trane or others, refer to the appropriate manufacturer's literature for allowable waiting periods for discharge of capacitors. Verify with an appropriate voltmeter that all capacitors have discharged. Failure to disconnect power and discharge capacitors before servicing could result in death or serious injury. Note: For additional information regarding the safe discharge of capacitors, see PROD-SVB06A-EN or PROD-SVB06A-FR**

[ ] Measure the compressor motor winding resistance to ground; a qualified service technician should conduct this check to ensure that the findings are properly interpreted.

Contact a qualified service organization to leak-test the chiller; this procedure is especially important if the system requires frequent purging.

[ ] Use a nondestructive tube test to inspect the condenser and evaporator tubes at 3-year intervals.

**Note:** It may be desirable to perform tube tests on these components at more frequent intervals, depending upon chiller application. This is especially true of critical process equipment.

[ ] Depending on chiller duty, contact a qualified service organization to determine when to conduct a complete examination of the unit to discern the condition of the compressor and internal components.

**Note:** (a) Chronic air leaks, which can cause acidic conditions in the compressor oil and result in premature bearing wear; and, (b) Evaporator or condenser water tube leaks. Water mixed with the compressor oil can result in bearing pitting, corrosion, or excessive wear.

[ ] Submit a sample of the compressor oil to a Trane qualified laboratory for comprehensive analysis on an annual basis; this analysis determines system moisture content, acid level and wear metal content of the oil, and can be used as a diagnostic tool.

#### Lubrication

The only chiller component that requires periodic lubrication is the external vane linkage assembly and Rotary oil valve.

Lubricate the vane linkage shaft bearings and rod end bearings as needed with a few drops of light-weight machine oil.

The CenTraVac inlet guide vane tang operators should be serviced annually with R123 compatible grease. Use only Rheolube 734A, available from Trane as LUB00033 (16oz. standard grease gun cartridge) or LUB00063 (3oz. mini grease gun cartridge)

**To service the 1st stage tang operator of all units except CDHF extended capacity chillers with 1470 or 1720 compressors.**

1. The chiller must be off.
2. Carefully remove any insulation that may have been placed over the two lubrication ports of the tang operator base. This insulation will need to be replaced after the service is complete.
3. Note the position of the tang operator arm, note the placement of spacing washers etc., then disconnect the linkage rod from the tang operator arm. Manually move the tang operator arm and note the amount of effort required to operate the assembly.
4. Loosen but DO NOT REMOVE the 1/16" NPT lubrication port plug that is highest on the assembly.
5. Loosen and remove the remaining lower 1/16" NPT plug.
6. Using a grease gun with an appropriate fitting, insert ONLY Rheolube grease into the open port until clean grease is seen to appear around the threads of the plug in the opposite port.
7. Tighten the plug that was loosened in step 4. Tighten the plug to hand tight plus 1/4 to 1/2 turn.
8. Remove the grease fitting, if used.

# Maintenance

## DO NOT LEAVE GREASE FITTINGS INSTALLED.

If grease fittings have been used for this procedure then they **MUST BE REMOVED** before returning the unit to service. Grease fittings are not vacuum-tight and will become a leak path.

9. Using a clean wooden dowel or other similar tool, remove excess grease from the remaining open lubrication port.
10. Clean and then lightly coat the threads of the plug with Rheolube grease and re-install it into the lubrication port. Tighten the plug to hand tight plus 1/4 to 1/2 turn.
11. Before reconnecting the vane linkage, grasp the tang operator arm and manually operate the vane assembly. If it is now difficult to move, then the tang operator may have become "hydraulically locked" because of excess grease in the assembly. This situation could cause damage to the o-rings of the assembly. If this occurs then remove one of the lubrication plugs, remove some of the grease, then re-install the plug.
12. Reconnect the linkage to the tang operator arm. Ensure the spacer washers between the linkage and the arm are properly placed and that the assembly does not bind. Re-install any insulation that was cut or removed. The unit may be restarted.

### To service the 1st and 2nd stage tang operators on CDHF extended capacity chillers with 1470 or 1720 compressors.

The 1st and 2nd stage rotary inlet guide vane tang operators of the extended capacity chillers also require periodic lubrication, at least annually, with R123 compatible Rheolube grease. These actuators have two 1/8" NPT plugs located 180 degrees apart, with one on the top

and the other on the bottom of the operator base. Use the same procedure as described above, except that it will be necessary to temporarily disconnect the vane actuators from the tang operator arms in order to test for a "hydraulically locked" condition.

The oil valve block rotary valve uses dual O-Rings to seal to atmosphere. These should be manually lubricated by removing the pipe plug at the valve lubrication port and placing a few drops of Trane OIL00022 in the cavity. Be sure to reinstall the pipe plug when lubrication is completed.

**Figure 37. Rotary valve in drain position**

**NOTE: ROTARY VALVE SHOWN IN DRAIN POSITION.**

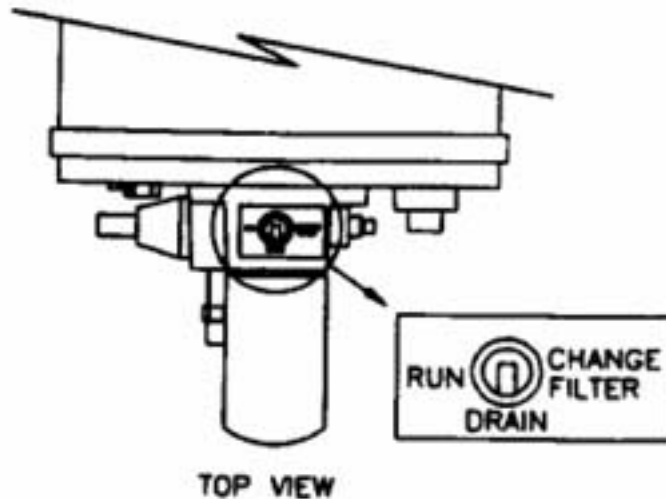

**Front View with Refrigerant Pump**

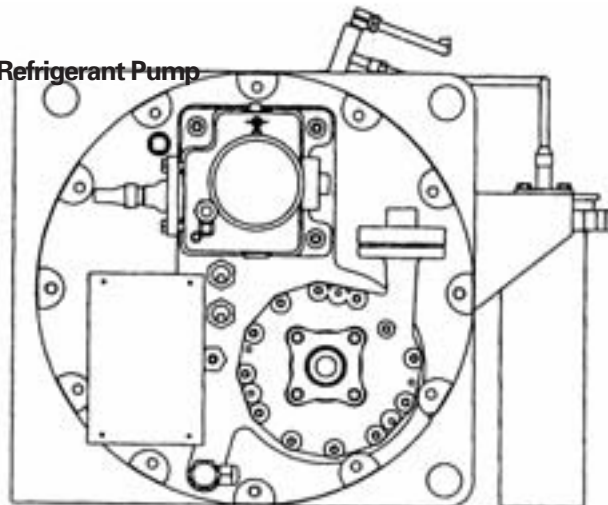

# Maintenance

---

## Refrigerant Charge

### **WARNING**

### **Contains Refrigerant!**

**System contains oil and refrigerant and may be under positive pressure. Recover refrigerant to relieve pressure before opening the system. See unit nameplate for refrigerant type. Do not use non-approved refrigerants, refrigerant substitutes, or refrigerant additives.**

**Failure to follow proper procedures or the use of non-approved refrigerants, refrigerant substitutes, or refrigerant additives could result in death or serious injury or equipment damage.**

The refrigerant charging procedure for Trane centrifugal chillers is:

1. If water is present in the tubes, break machine vacuum with refrigerant vapor, or circulate water, to avoid tube damage.
2. Always use refrigerant compatible hoses or copper-tubing with self-sealing connections or shut-off valves.

3. Transfer the refrigerant using one of the following (listed in order of preference):
  - a. An approved Trane low-pressure refrigerant recovery and recycle unit.
  - b. The available pressure differential.
  - c. Gravity. (Use a return vent line to refrigerant drums to equalize pressure.)
5. Do not use dry nitrogen to push refrigerant into the chiller as was common practice in the past. This will contaminate the charge and require excessive purging, which will result in unnecessary release of refrigerant.
6. Weigh in the proper charge.
7. Use recovery and recycle unit or vacuum pump to evacuate hoses; discharge outdoors.
8. If refrigerant is supplied in new returnable cylinders, be sure and refer to General Service Bulletin CVHE-SB-48B for information on returning cylinders. This service bulletin is available at the nearest Trane office.

Depending on the chiller duty, contact a qualified service organization to determine when to conduct a complete examination of the unit to discern the condition of the compressor and internal components.

**Note:** If your chiller is covered by a Trane extended warranty, the terms of that warranty may require that the procedures listed in the Periodic Maintenance section of this manual be followed for your extended warranty to remain in force. The terms may also require that the chiller be inspected by a Trane authorized warranty agent every 4-years or 40,000 operating hours, whichever occurs first. This inspection will include, at a minimum, a review of the annual inspection checklists and the daily operating logs, as well as performance of a leak test and a general inspection of the chiller. The owner is then required to follow the recommendations made as a result of this inspection at the owners expense.

# Maintenance

## Recovery and Recycle Connections

To facilitate refrigerant removal and replacement, newer-design CDHF, CDHG units are provided with a 3/4-inch vapor fitting with shutoff valve on the chiller suction and with a 3/4-inch liquid connection with shutoff valve at the bottom of the evaporator shell. (Refer to Refrigerant Handling Guidelines)

## Leak Testing

To leak-test a chiller containing full refrigerant charge, raise chiller pressure using a controlled hot water or electric-resistance system to a maximum of 8 psig. Do not use nitrogen, which will cause excessive refrigerant discharge by the purge system.

## Cleaning the Condenser

### CAUTION

### Proper Water Treatment!

The use of untreated or improperly treated water in a CenTraVac may result in scaling, erosion, corrosion, algae or slime. It is recommended that the services of a qualified water treatment specialist be engaged to determine what water treatment, if any, is required. Trane assumes no responsibility for equipment failures which result from untreated or improperly treated water, or saline or brackish water.

See Figure 38 which shows a Typical Chemical Cleaning Setup.

*Figure 38. Typical chemical cleaning setup*

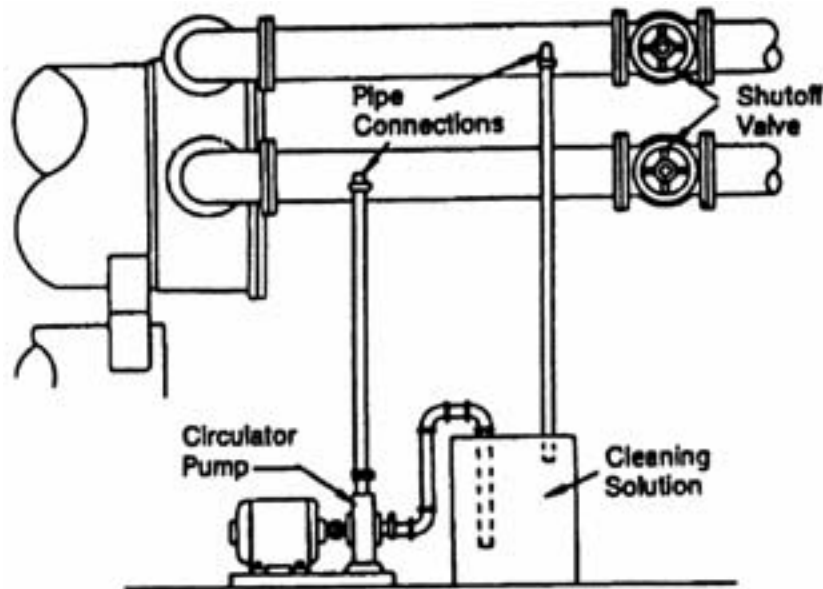

# Maintenance

---

Condenser tube fouling is indicated when the approach temperature (the difference between the condensing refrigerant temperature and the leaving condenser water temperature) is higher than predicted.

If the annual condenser tube inspection indicates that the tubes are fouled, two cleaning methods, mechanical and chemical, can be used to rid the tubes of contaminants.

Use the mechanical cleaning method to remove sludge and loose material from smooth-bore tubes.

To clean other types of tubes including internally-enhanced types, consult a qualified service organization for recommendations.

1. Remove the retaining nuts and bolts from the water box covers at each end of the condenser. Use a hoist to lift the covers off the water box. (A threaded connection is provided on each water box cover to allow insertion of an eyebolt).
2. Work a round nylon or brass bristled brush (attached to a rod) in and out of each of the condenser water tubes to loosen the sludge.
3. Thoroughly flush the condenser water tubes with clean water.

Scale deposits are best removed by chemical means. Be sure to consult any qualified chemical house in the area (one familiar with the local water supply's chemical mineral content) for a recommended cleaning solution suitable for the job.

Remember, a standard condenser water circuit is composed solely of copper, cast iron and steel.

## CAUTION

### Unit Corrosion Damage!

**Proper procedures must be followed when using corrosive chemicals to clean water side of unit. It is recommended that the services of a qualified chemical cleaning firm be used. Proper personal protective equipment as recommended by the chemical manufacturer should be used. Refer to the chemicals MSDS sheet for proper safety procedures. Failure to follow proper procedures could result in corrosion damage to the unit and tubes.**

**IMPORTANT: ALL OF THE MATERIALS USED IN THE EXTERNAL CIRCULATION SYSTEM, THE QUANTITY OF THE SOLUTION, THE DURATION OF THE CLEANING PERIOD, AND ANY REQUIRED SAFETY PRECAUTIONS SHOULD BE APPROVED BY THE COMPANY FURNISHING THE MATERIALS OR PERFORMING THE CLEANING.**

**REMEMBER, HOWEVER, THAT WHENEVER THE CHEMICAL TUBE CLEANING METHOD IS USED, IT MUST BE FOLLOWED UP WITH MECHANICAL TUBE CLEANING, FLUSHING AND INSPECTION.**

### Cleaning the Evaporator

Since the evaporator is typically part of a closed circuit, it does not accumulate appreciable amounts of scale or sludge. Normally, cleaning every 3 years is sufficient. However, on open evaporator systems, such as air washers, periodic inspection and cleaning is recommended.

### Control Settings and Adjustments

Time delays and safety control cutout settings need to be checked annually. For control calibration and check-out, contact a Trane qualified service organization.

# Maintenance

---

## Purge System

Because some sections of the chiller's refrigeration system operate at less-than-atmospheric pressure, the possibility exists that air and moisture may leak into the system. If allowed to accumulate, these noncondensables become trapped in the condenser; this increases condensing pressure and compressor power requirements, and reduces the chiller's efficiency and cooling capacity.

The Trane EarthWise Purge is the only purge system available for the chiller. The purge is designed to remove noncondensable gases and water from the refrigeration system. EarthWise Purge unit operation, maintenance and trouble shooting is covered by a separate operation and maintenance manual, which may be obtained from the nearest Trane office.

## Overview

This section describes extended storage requirements for installed chillers to be removed from service for an undetermined length of time.

## Unit Preparation

The following steps are necessary in order to properly prepare a unit for storage.

1. Remove all liquid refrigerant if the unit is charged.

### **WARNING**

## Contains Refrigerant!

**System contains oil and refrigerant and may be under positive pressure. Recover refrigerant to relieve pressure before opening the system. See unit nameplate for refrigerant type. Do not use non-approved refrigerants, refrigerant substitutes, or refrigerant additives. Failure to follow proper procedures or the use of non-approved refrigerants, refrigerant substitutes, or refrigerant additives could result in death or serious injury or equipment damage.**

2. After the liquid refrigerant is removed, using a recovery or recycle unit or vacuum pump, pull a vacuum to remove remaining refrigerant vapor from the unit.

3. After all traces of refrigerant are out of the unit, a positive nitrogen charge should be put into the unit (6 to 8 psig). This positive pressure must be checked monthly to insure no noncondensables get into the unit. Use a pressure gage on the evaporator shell to verify that the 6 to 8 psig dry nitrogen holding charge is still in the chiller. If this charge has escaped, contact a qualified service organization and the Trane sales engineer that handled the order.
4. The refrigerant charge should be stored in proper refrigerant containers. Due to possible leakage, do not store in used drums.
5. Maintain control power to the control panel. This will maintain oil temperature in the oil sump and the capability of the control panel to present report information. The Chiller Reports should be viewed once a week for normal readings. Any abnormal observation must be reported to the Trane Sales Engineer that handled the order.

## Maintenance

---

### **WARNING**

#### **Live Electrical Components!**

**During installation, testing, servicing and troubleshooting of this product, it may be necessary to work with live electrical components. Have a qualified licensed electrician or other individual who has been properly trained in handling live electrical components perform these tasks. Failure to follow all electrical safety precautions when exposed to live electrical components could result in death or serious injury.**

6. Remove the factory installed jumper or the field installed wiring on terminals in the unit control panel. This will prevent unwanted chiller operation.
7. Set the purge operating mode to OFF on UCP chillers.
8. The oil can be left in the unit.
9. The water side should not cause a problem if shut down and drained. There may be slight scaling inside the tubes, but not enough to cause a problem. The customer should inspect and clean tubes before the unit is returned to service.

**IMPORTANT: DO NOT USE UNTREATED OR IMPROPERLY TREATED WATER, OR EQUIPMENT DAMAGE MAY OCCUR.**

**IMPORTANT: SCALE DEPOSITS ARE BEST REMOVED BY CHEMICAL MEANS. BE SURE TO CONSULT ANY QUALIFIED CHEMICAL HOUSE IN THE AREA (ONE FAMILIAR WITH THE LOCAL WATER SUPPLY'S CHEMICAL MINERAL CONTENT) FOR A RECOMMENDED CLEANING SOLUTION SUITABLE FOR THE JOB.**

10. Motor bearings: If the motor sits for a long time the bearings could take a set and cause bearing problems or replacement later. Once every six months the chiller oil pump must be started and the compressor motor bump started to rotate the shaft. Contact a qualified service organization to perform this task. If the compressor motor cannot be bump started, then the shaft must be rotated manually by a qualified service organization.

11. Obtain an oil analysis initially after six months of storage, and once each succeeding year. If no oil breakdown is evident do not change the oil. If breakdown is evident, the oil must be replaced.
12. If the unit is stored for more than five years, and the storage is expected to be indefinite, the unit should be examined for leaks every five years from the initial storage date.
13. When the unit is to be returned to service, the services of a qualified service organization should be obtained to conduct all activities associated with the startup of a new chiller.



**CenTraVac®**  
**Annual Inspection Check List and Report:**

**Compressor Motor**

- Motor Continuity check  
     Good     Open
- Check and tighten motor terminals
- Meg Motor  
     Phase 1  Phase 2  Phase 3
- Check nameplate rating  
     Amps

**Starter**

- Check condition of starter contacts  
     Good     Fair     Replace
- Check, tighten if necessary all connections  
     per manufactures specs

**Oil Sump**

- Change oil  
     If oil analysis, refer to program procedure
- Gallons (9) required
- Refrigerant/Oil pump motor ground check  
     Good     Open
- Check motor terminal
- Change oil filter

**Condenser**

- Visually inspect for scaling in tubes;  
     not findings and make recommendations

**Control Circuits**

- Low refrigerant temperature sensor check  
     \_\_\_°F set point \_\_\_°F trip point (ice water)
- Leaving Evaporator water temperature  
     sensor check-out  
     \_\_\_°F set point \_\_\_°F trip point (ice water)
- Condenser High Pressure Switch check-out  
     \_\_\_psig set point  
     \_\_\_psig trip point
- Check Net Oil Pressure
- Check adjustment and operation of inlet  
     guide vane actuator stepper motor  
     (Note: each machine is unique and must have  
     the full open position number of steps input.)

**Leak Test Chiller**

- Refrigerant and oil analysis for acid content
- Sample refrigerant and oil for laboratory  
     analysis (attach a copy of analysis to next  
     monthly inspection report)

**Purge Unit**

- Review the purge operation maintenance  
     manual and follow maintenance and/or  
     inspection items identified.

Comments:

---



---



---



---

Recommendations:

---



---



---



---





CenTraVac®
Checksheets and Request for Serviceman

To: \_\_\_\_\_ Trane Service Company
S.O. No.: \_\_\_\_\_ Serial #: \_\_\_\_\_
Job/Project Name: \_\_\_\_\_
Address: \_\_\_\_\_

The following items are being installed and will be completed by: \_\_\_\_\_
Check boxes if the task is complete or if the answer is "yes".

1. CenTraVac

In place and piped. Do not insulate CenTraVac or adjacent piping. The contractor is responsible for any foreign material left in the unit. \_\_\_\_\_

2. Piping

Chilled water piping connected to:
CenTraVac \_\_\_\_\_
Air handling units \_\_\_\_\_
Pumps \_\_\_\_\_

Condenser and heat recovery condenser (as applicable) piping connected to:

CenTraVac \_\_\_\_\_
Pumps \_\_\_\_\_
Cooling tower \_\_\_\_\_
Heating loop (as applicable) \_\_\_\_\_

Make-up water connected to cooling tower \_\_\_\_\_
Water supply connected to filling system \_\_\_\_\_
Systems filled \_\_\_\_\_
Pumps run, air bled from system \_\_\_\_\_
Strainers cleaned \_\_\_\_\_

3. Flow Balancing Valves Installed

Leaving chilled water \_\_\_\_\_
Leaving condenser water \_\_\_\_\_
Heat recovery condenser leaving water \_\_\_\_\_

4. Gauges, Thermometers and Air Vents

Installed on both sides of evaporator \_\_\_\_\_
Installed on both sides of condenser and heat recover condenser (as applicable) \_\_\_\_\_

5. Wiring

Compressor motor starter has been furnished by or approved by Trane La Crosse, WI \_\_\_\_\_
Full Power available \_\_\_\_\_
Interconnecting wiring, starter to panel (as req'd) \_\_\_\_\_
External interlocks (flow switch, pumps aux, etc) \_\_\_\_\_

Chiller motor connection (remote starters)\* \_\_\_\_\_
Chilled water pump (connected and tested) \_\_\_\_\_
Condenser water pump (connected and tested) \_\_\_\_\_
Cooling tower fan rotation checked \_\_\_\_\_
Heat recovery condenser water pump (as applicable) \_\_\_\_\_
Power available for Service tools 115 VAC \_\_\_\_\_
All controls installed and connected \_\_\_\_\_
All magnetic starters installed and connected \_\_\_\_\_

\*Note: Do not make final remote starter to compressor motor connections until requested to do so by the Trane Service representative.

6. Testing

Dry nitrogen available for pressure testing \_\_\_\_\_
Trace gas amounts of Refrigerant-22 or R-134a available for leak testing, if necessary \_\_\_\_\_

7. Refrigerant On Job Site

8. Systems Can Be Operated Under Load Conditions

9. Electrical, Control Man and Contractor's Representative Are Available to Evacuate, Charge and Test the CenTraVac under Serviceman's Supervision

10. Equipment Room

Does the equipment room have a refrigerant monitor/sensor capable of monitoring and alarming within the allowable exposure level of the refrigerant? \_\_\_\_\_
Does the installation have properly placed and operating audible and visual refrigerant alarms? \_\_\_\_\_

Continued on next page.....



**10. Equipment Room (continued)**

- Does the equipment room have proper mechanical ventilation? .....
- If it is required by local code, is a self-contained breathing apparatus available?

**11. Owner Awareness**

- Has the owner been fully instructed on the proper use of refrigerant HCFC-123? .....
- Does the owner have a copy of the MSDS for refrigerant HCFC-123? .....
- Was the owner given a copy of the Refrigerant Handling Guidelines? .....

Note: Additional time required to properly complete the start-up and commissioning, due to any incompleteness of the of the installation, will be invoiced at prevailing rates.

***This is to certify that the CenTraVac chiller(s) has/have been properly and completely installed, and that the applicable items listed above have been satisfactorily completed.***

**Checklist Completed By** \_\_\_\_\_

**Signed:** \_\_\_\_\_ **Date:** \_\_\_\_\_

In accordance with your quotation and our purchase order number \_\_\_\_\_, we will therefore require the presence of Trane service on the site, for the purpose of start-up and commissioning, by: Date: \_\_\_\_\_

**Note: Advance notification is required to allow scheduling of the start-up as close as possible to the requested date.**

Additional Comments/Instructions \_\_\_\_\_  
\_\_\_\_\_  
\_\_\_\_\_  
\_\_\_\_\_  
\_\_\_\_\_  
\_\_\_\_\_  
\_\_\_\_\_

**A copy of this completed form must be submitted to the Trane Service Agency that will be responsible for the start-up of the chiller.**



### CenTraVac Commissioning Checklist

Job Name \_\_\_\_\_ Location \_\_\_\_\_  
 Model # \_\_\_\_\_ Serial # \_\_\_\_\_  
 Sales Order # \_\_\_\_\_ Start-up Date \_\_\_\_\_

**Note: The Unit Installation, Operation and Maintenance Manuals including Warning and Cautions, Applicable Service Alerts and Bulletins, Submittals, and Design Specifications must be used in conjunction with this checklist.**

#### I. PRECOMMISSIONING PROCEDURES

##### A. Obtain Installation Check Sheet

This must be prepared by installer for a particular unit, verifying the unit is ready for commissioning.

##### B. Obtain Design (order) Specification Data

This indicates the design criteria of the particular unit. A unit cannot be properly commissioned unless this data is known. It is the responsibility of the selling office to furnish this data.

##### C. Obtain Wiring Diagrams

The "as-wired" electrical diagram should be compatible with the recommended Trane submittals and diagrams. Are customer added external/remote control circuits compatible?

Yes  No

##### D. General Installation Observations

1. Is there any apparent shipping or rigging damage?  Yes  No

2. Record the unit pressure upon receipt: \_\_\_\_\_ psig. If there is no pressure, a leak test will have to be done before the unit can be evacuated and charged.

3. Is the water piping correctly installed?

Flow Switches	<input type="checkbox"/> Yes	<input type="checkbox"/> No	Pressure Gauges	<input type="checkbox"/> Yes	<input type="checkbox"/> No
Isolations Valves	<input type="checkbox"/> Yes	<input type="checkbox"/> No	Flow Balancing Valves	<input type="checkbox"/> Yes	<input type="checkbox"/> No
Thermometer Wells	<input type="checkbox"/> Yes	<input type="checkbox"/> No	Vent Cocks and Drains	<input type="checkbox"/> Yes	<input type="checkbox"/> No

4. Have proper clearances around the unit been maintained per submittal and/or Installation?

Are there Manual guidelines available  
 Yes  No

5. Is power wiring of adequate ampacity and correct voltage?

Yes  No

6. Is the unit base acceptable, level, and is the unit on isolators (rubber as supplied by Trane or spring type)?

Yes  No

7. Have the low voltage circuits been properly isolated from the higher voltage control and power circuits?

Yes  No

**E. Comments** \_\_\_\_\_  
 \_\_\_\_\_  
 \_\_\_\_\_



## II. COMMISSIONING PROCEDURES

### A. Pre-start Operations

#### 1. Holding Charge

- \_\_\_\_\_psig. Must be positive pressure or leak test must be done.

#### 2. Before relieving the holding charge, calibrate the H.P.C. high-pressure control

This is a check of pressure to the H.P.C. as well as calibration of the control.

Disconnect and cap the flare. Calibrate H.P.C. and reconnect flare.

- Relieve the holding charge.  
 Check and if necessary, tighten all connections per proper specs.

#### 3. Megohm the Motor (500 volt Meggar)

- Compressor motor Megohms - refer to temp/resistance chart for acceptable values. Remove surge suppressors before Megging. Never Meg test with the unit in a vacuum.

T1 to Earth\_\_\_\_ T4 to Earth\_\_\_\_ T1 to T2 T1 to T4\_\_\_\_  
T2 to Earth\_\_\_\_ T5 to Earth\_\_\_\_ T1 to T3 T2 to T5\_\_\_\_  
T3 to Earth\_\_\_\_ T6 to Earth\_\_\_\_ T2 to T3 T3 to T6\_\_\_\_

#### 4. Evacuation

Connect the vacuum pump to start evacuation. Use a 2-stage pump with at least 5 CFM capacity.

Connect to the evaporator-charging valve with a hose no smaller than 3/4 inch ID.

a. For the IT Cutler-Hammer Solid State Starter it is necessary to shut off all power to the unit prior to evacuating the chiller. The IT starter has terminals 4, 5, & 6 hot when the unit is off. Failure to shut off power to the chiller, with the vacuum pump hook up, will cause a motor failure.

#### 5. Condenser

- Isolation and flow valves installed  
 Calibrated thermometers and pressure gauges installed in/out condenser on machine side of any valve or elbow.  
 If condenser pump controlled by UCP, is field wiring correct and complete?  
 Condenser pump(s) run, system and strainers properly cleaned and/or flushed.  
 Condenser water strainer in close proximity to entering connection of condenser.  
 Previsions installed to properly maintain water treatment additives.  
 Initial water treatment added to system  
 Flow or differential pressure switch installed and where possible, wired in series with auxiliary of pump motor starter. Verify correct operation of flow proving circuit.  
 Condenser water flow balance.

PSID design\_\_\_\_ PSID actual\_\_\_\_  
GPM design\_\_\_\_ GPM actual\_\_\_\_

#### 6. Evaporator

- \_\_\_\_\_psig. Must be positive pressure or leak test must be done.  
 Calibrated thermometers and pressure gauges installed in/out of evaporator on machine side of any valve or elbow.  
 If evaporator pump controlled by UCP, is field wiring correct and complete?

- Evaporator pump(s) run 24 hrs. System and strainers properly cleaned and/or flushed.
- Evaporator water strainer in close proximity to entering connection of evaporator.
- Provisions installed to properly maintain water treatment additives.
- Initial water treatment added to system.
- Flow or differential pressure switch installed and where possible, wired in series with auxiliary of pump motor starter. Verify correct operation of flow proving circuit.
- Evaporator water flow balanced.
  - PSID design \_\_\_\_\_ PSID actual \_\_\_\_\_
  - GPM design \_\_\_\_\_ GPM actual \_\_\_\_\_

## 7. Electrical and Controls

### a. Motor Starter Panel

- All terminals tightened.
- Wiring free from abrasion, kinks, and sharp corners.
- Contactors and relays have freedom of movement.
- All contacts are free of corrosion or dirt. Panel is free of dust, debris etc.
- Check the ratio of the current transformers. Record the part numbers on the start-up log.
- Use only twisted shielded pair for the IPC circuit between the starter and the UCP on remote starters. Recommended wire is Belden 8760, 18 AWG. Polarity is critical.
- The low voltage IPC link (\_\_\_30 volts) must be in separate conduit from the 115-volt wiring.
- IPC link routing within the starter panel must stay a minimum of 6 inches from higher voltages.
- Remote starter to UCP connections are complete and comply with Trane requirements. Verify oil pump interlock circuit to 1A7J2-4 and J2-2.
- Check the correctness of the power connections from the starter to the motor.
- Check the wiring to the starter for size, voltage and correct phase rotation (A-L1, B-L2, & C-L3)
- Check the equal phase representation in each power-wiring conduit.

### b. Control Panel

- All terminals tightened.
- Wiring free from abrasion, kinks, and sharp corners.
- Low voltage wires are isolated from high voltage wires.
- Panel is free of dust, debris etc.
- "Power Up" the control panel. (Non-AFD Starters)
  1. Starter disconnect locked open.
  2. Fuse 2F4 must be removed from the starter.
  3. Connect auxiliary 115VAC-power cord to Terminals 1X1-5(L1) and 1X1-17(L2) in the control panel. MAKE SURE OF THE POLARITY. THE 'HOT' SIDE MUST BE CONNECTED TO TERMINAL 1X1-5(L1) AND THE 'NEUTRAL' SIDE DO 1X1-17(L2).
  4. Plug in cord to 115VAC-power source. Control panel is now energized.
- Record the configuration and setpoints of the CH530 control system, using Service Tool.
- Using the unit nameplate data and the order specification, double check and reset, if required, the settings of RLA & STMS, using Service Tool.

If Evaporator and condenser water pumps are controlled by the UCP, use the DynaView (or Service Tool) manual override menu to manually start and test the control of the pumps.



- Check the setting of the oil pressure-regulating valve.
  1. Use the DynaView manual override of the UCP to manually start the oil pump.
  2. Proceed to the Compressor Report menu and observe the Differential Oil Pressure
  3. Adjust the oil pressure-regulating valve to maintain 18 to 22 psid. The oil pressure-regulating valve may require adjustment as the unit is started.
  4. This procedure also checks to ensure correct sensing of oil pressure. The Oil Pressure Cutout setting is adjustable within via the CH530 Service Tool.
  5. Return Oil Pump control to 'Auto' from within the DynaView.
- Check vane operator and vanes (Service Tool).
  1. Use the Service Tool manual override menu to manually override the vane control.
  2. Enter targets from 0% to 100% and observe vane operation. At minimum and maximum travel the operator should not exert any force on the vane assembly, adjust as required.
  3. Vane movement is smooth to open/close.
  4. Vane movement is reported back to the UCP.
  5. Return Vane control to 'Auto'.
- Dry run the starter (Service Tool).
  1. Make sure the starter disconnect is safety locked open.
  2. Use the Service Tool menu of the UCP to initiate the Starter Dry Run.
  3. Observe correct operation of starter contactors.
  4. Observe correct operation of transition complete signal (if required).
  5. Disable Starter Dry Run when complete.
- Remove Power
- Disconnect and remove temporary power cord.

## B. Preparation for Start-up.

### 1. Evacuation and charging

- Evacuation leak test. When vacuum has been drawn down to 500 microns to 1000 microns, secure the vacuum pump. Wait for 12 hours for a valid vacuum leak test. If the rise in vacuum is less than 500 microns per 12 hours start-up may proceed.
- Charge refrigerant. MAKE SURE THE CHILLED WATER IS FLOWING THROUGH THE EVAPORATOR. Charge the prescribed amount of refrigerant through the liquid charging valve at the liquid inlet to the evaporator. Check that all drums contain a full amount of refrigerant. Amount charged \_\_\_\_\_ lbs and kg.

### 2. Electrical

- Disconnect all temporary power cords, replace all fuses, connect motor leads, make final electrical inspection.
- Power up the motor starter. Check for control voltage at control panel terminals 1X1-1 and 1X1-17.  
\_\_\_\_\_ Volts
- Check current to the oil sump heater.  
\_\_\_\_\_ Amperes
- As the oil heats up, finish any operations not yet completed in preparation for starting the unit.



**C. Chiller Start-up**

**1. Make all preliminary checks.**

- Oil temp, oil level, chilled water flow, chilled water load available (cooling units on) etc.

**2. Start the unit**

- If the phase rotation of the electrical power has not been positively confirmed, the actual rotation of the motor must be checked. Observe the rotation of the motor shaft through the sight glass on the end of the motor at the moment of start-up. Rotation must be CLOCKWISE. If the phase sequence is incorrect, confirmed by observation of the Phase Reversal diagnostic on the UCP, then the incoming power leads to the stator must be adjusted by authorized personnel.
- As the unit starts and runs, observe closely all operating conditions.
- Adjust the oil pressure regulator if necessary to 18 to 22 psi net.
- In the DynaView Purge Settings menu of the UCP, place the Purge Operating Mode to 'on' to allow the removal of non-condensables. It may also be necessary to disable the Purge Pumpout Limit timer found in the Purge Settings menu.
- After the unit has the system down to design leaving chilled water temp and is under control, and the purge is no longer relieving non-condensables, begin taking the start-up test log. Log the unit a minimum of 3 times at 15-minute intervals.
- In the DynaView Purge Settings menu of the UCP, return the purge-operating mode to 'Adaptive'.
- Restart the chiller and carefully observed the starting and loading sequence.

**3. Instructions to the Chiller Operator.**

- Instructions for starting, operating, and shutting down.
- Instructions for logging the unit.
- Instrucitons for periodic maintenance.

**D. After 2 weeks of operation (International Units Only)**

- 1. Replace the oil filter with the spare oil filter included in the control panel at time of shipment.

**E. Comments and/or Recommendations:**

---



---



---



---



---



---



---



---



---

Service Technician                      Signature                      Date



## STARTUP Chiller Report - Water Cooled CenTraVac With CH530 Controller

<b>Job Name</b> _____	<b>Serial #</b> _____
<b>Job Location</b> _____	<b>Model #</b> _____
<b>Sales Order #</b> _____	<b>Ship Date</b> _____
<b>Elevation</b> _____	<b>Start Date</b> _____

DATE: \_\_\_\_\_

**Starter Data:**

Manufacturer	_____
Type	_____
Vendor ID#	_____
Model #	_____
Volts 7 Hz	_____
Amps	_____

**Current**

**Transformers**

Primary	X _____ -
Primary	X _____ -
Primary	X _____ -
Secondary (if present)	X _____ -
Secondary (if present)	X _____ -
Secondary (if present)	X _____ -

**Motor Data:**

Manufacturer	_____
Type & Frame	_____
Drawing#	_____
Serial#	_____

**Nameplate Data**

RLA	_____
KW	_____
Volts & Hz	_____

**Machine Press**

At Arrival	_____ PSIG
At Startup	_____ PSIG
Leak Test Vacuum	_____ Microns
Vac Rise Test	_____ Microns after _____ hours
Unit Refrigerant Charge	_____ lbs of R- _____
High Pressure Cutout	HPC (3S1) _____ Open  HPC (3S1) _____ Close

**Design Data**

RLA	_____
KW	_____
Volts & Hz	_____
Evap Flow	_____ Actual _____
Evap PD	_____
Cond Flow	_____
Cond PD	_____

**Dyna View Display**

**Settings:**

Date Format	_____
Date	_____
Time Format	_____
Time of Day	_____
Keypad/Display Lockout	_____
Display units	_____
Pressure Units	_____
Language	_____

**Dyna View Purge Settings**

Purge Operating Mode	_____
Daily Pumpout Limit	_____
Pumpout Limit Disable	_____
Purge Liquid Temp Inhibit	_____
Purge Liquid Temp Limit	_____
Purge Run Time	_____
	_____
	_____

**Notes**

\_\_\_\_\_

\_\_\_\_\_

\_\_\_\_\_

\_\_\_\_\_





**STARTUP Chiller Report - Water Cooled CenTraVac  
With CH530 Controller**

Dyna View Reports	Log 1	Log 2	Log 3
Evaporator			
Entering			
Leaving			
Saturated			
Refrig Press			
Approach			
Flow Sw status			
<b>Condenser</b>			
Entering			
Leaving			
Saturated			
Refrig Press			
Approach			
Flow Sw status			
<b>Compressor</b>			
Starts			
Running Time			
Oil Tank Press			
Oil Dischrg. Press			
Oil Diff Press			
Oil Tank Temp			
IGV Position %			
IGV Steps			
<b>Motor</b>			
% RLA L1, L2, L3			
Amps L1, L2, L3			
Volts AB, BC, CA			
Power KW			
Load PF			
Winding #1 temp			
Winding #2 temp			
Winding #3 temp			
<b>w/AFD only:</b>			
AFD Freq			
AFD Speed			
AFD Transistor temp			
<b>Purge</b>			
Time Until Next Purge Run			
Daily Pumpout - 24 hrs.			
Avg. Daily Pumpout - 7 days			
Daily Pumpout Limit/Alarm			
Chiller On 7 days			
Pumpout Chiller On 7 days			
Pumpout Chiller Off 7 days			
Pumpout- Life			
Purge Rfgt Cprsr Suction Temp.			
Purge Liquid Temp.			
Carbon Tank Temp.			
<b>Date:</b>			
<b>Technician:</b>			
<b>Owner:</b>			



**STARTUP Chiller Report - Water Cooled CenTraVac  
With CH530 Controller**

**TECHVIEW SETTINGS RECORDS**

	TechView: Configuration View	Record Setting		TechView: Configuration View	Record Setting
	<b>UNIT TYPE</b>		33	Comm 4 Tracer Interface	
1	Unit Type		34	Comm 5 Tracer Interface	
	<b>CH530 Tab</b>		35	ICS Address Comm 4	
2	Control Sequence		36	ICS Address Comm 5	
3	Unit Capacity		37	Purge Control	
4	Starter Type		38	Compressor Power Source	
5	Refrigerant Type		39	% RLA and Rfgr Press Analog Output	
6	Line Voltage Sensing		40	Rfgr Pressure Analog Output (TYPE)	
7	Free Cooling		41	Min Delta Rfgr Press Output Cal	
8	Hot Gas Bypass		42	Max Delta Rfgr Press Output Cal	
9	Second Condenser		43	Max Capacity Relay Filter Time	
10	Hot Water Control		44	Head Relief Relay Filter Time	
11	Outdoor Air Temp Sensor		45	Base Loading	
12	External Chilled Water Setpoint			<b>TechView: Starter (non AFD)</b>	
13	ECWS Minimum Temperature		46	Stop Delay Time (Contactor Interrupt Failure)	
14	ECWS Maximum Temperature		47	Unit Line Voltage	
15	External Current Limit Setpoint		48	Voltage Transformer Ratio	
16	ECLS Minimum %RLA		49	Rated Load Amps	
17	ECLS Maximum %RLA		50	CT Meter Scale	
18	Ice Building		51	Current Unbalance Trip Point	
19	EHWS Minimum Temperature		52	Current Unbalance Grace Period	
20	EHWS Maximum Temperature		53	Maximum Acceleration Setting	
21	Refrigerant Monitor Type		54	Acceleration Time Out Action	
22	Condenser Pressure Sensor		55	Overload Type	
23	Evap. Diff. Wtr Press Sensing		56	Phase Reversed Protection Enable	
24	Cond. Diff. Wtr Press Sensing		57	Contactor Integrity Test	
25	Enhanced Oil Temp Protection		58	Phase Reversed Grace Period	
26	Discharge Temp Sensors		59	Surge Protection Enable	
27	Bearing Temp Sensors		60	Momentary Power Loss Protection	
28	High Pressure Cutout		61	Restart Inhibit Stop to Start Time	
29	Impeller Diameter		62	Surge Sensitivity	
30	IGV Actuators		63	Power Loss Reset Time	
31	Alarm, Limit Warning, Cprsr Run Relays				
32	Max Cap, Head Relief Request Purge Relays				

**STARTUP Chiller Report - Water Cooled CenTraVac  
With CH530 Controller**

<b>SETPOINT VIEW: Chiller</b>			
64	Front Panel Chilled Water Setpoint	101	Check Oil Filter Diagnostic
65	Front Panel Current Limit Setpoint	102	Check Oil Filter Setpoint
66	Front Panel Heating or Cooling Mode	103	Restart Inhibit Free Starts
67	Front Panel Hot Water Setpoint	104	Restart Inhibit Start to Start
68	Front Panel Base Loading Command	105	Restart Inhibit Diagnostic
69	Front Panel Base Load Setpoint	106	Time Permitted at Minimum Capacity
70	Front Panel Free Cooling Command	107	HGBP Mode, Vane Target Compressor
71	Front Panel Ice Building Command	108	Maximum HGBP Time
72	Front Panel Ice Termination Setpoint	109	High Discharge Temp Cutout
73	Ice To Normal Cooling Timer	110	Local Atmosphere Pressure
74	Differential to Start Setpoint	111	Minimum Capacity Limit
75	Differential to Stop Setpoint	112	Maximum Capacity Limit
76	Setpoint Source	113	Start Sequence Type
77	Power Up Start Delay		
78	Evaporator Pump Off Delay		<b>SETPOINT VIEW: Feature Settings</b>
79	Condenser Pump Off Delay	114	Evap Pump Control Type
80	Evaporator Design Delta Temp	115	Chilled Water Reset
81	Condenser Design Delta Temp	116	Return Reset Ratio
82	Evaporator Leaving Water Temp Cutout	117	Return Start Reset
83	Inlet Guide Vane Max Steps First Stage	118	Return Max Reset
84	Inlet Guide Vane Max Steps Second Stage	119	Outdoor Reset Ration
85	Low Refrigerant Temp Cutout	120	Outdoor Start Reset
86	Condenser Limit Setpoint	121	Outdoor Max Reset
87	Evaporator Water Flow 1	122	External Current Limit Setpoint Enable
88	Evaporator Pressure Drop 1	123	Ice Building Feature Enable
89	Evaporator Water Flow 2	124	Hot Gas Bypass Feature
90	Evaporator Pressure Drop 2	125	Hot Gas Bypass Maximum Timer Enable
91	Evaporator Fluid Specific Gravity	126	Hot Gas Bypass Maximum Timer Setpoint
92	Evaporator Fluid Specific Heat	127	Hot Gas Bypass Compressor Control Command
93	Evaporator Low Water Flow Warning Setpoint	128	Hot Gas Bypass Valve Travel Time
94	Condenser Water Flow 1	129	External Base Loading Enable
95	Condenser Pressure Drop 1	130	Capacity Control Softload Time
96	Condenser Water Flow 2	131	Current Limit Control Softload Time
97	Condenser Pressure Drop 2	132	Current Limit Softload Start Point
98	Oil Temp Control Setpoint	133	Phase Unbalance Protection
99	Low Oil Temp Inhibit (Enhanced disabled)	134	Over/Under Voltage
100	Low Differential Oil Pressure Cutout	135	Protection
		136	Control Algorithm Flow Compensation



**Trane**  
**A business of American Standard Companies**  
**[www.trane.com](http://www.trane.com)**

For more information contact your local district office  
or e-mail us at [comfort@trane.com](mailto:comfort@trane.com)

---

Literature Order Number	CDHF-SVU01C-EN
File Number	SV-RF-CTV-CDHF-SVU01C-EN-405
Supersedes	CDHF-SVU01B-EN 604
Stocking Location	La Crosse

---

*Trane has a policy of continuous product and product data improvement and reserves the right to change design and specifications without notice.*

*Only qualified technicians should perform the installation and servicing of equipment referred to in this publication.*