

ALTO SHAAM®

Drawer Warmers

Electric



**MANUAL or
ELECTRONIC CONTROL**



Models:

500-1D, 1DN

500-2D, 2DN

500-3D, 3DN



- **INSTALLATION**
- **OPERATION**
- **MAINTENANCE**

HALO HEAT®

24/7
Your Service Hotline
1-800-888-8744

W164 N9221 Water Street • P.O. Box 450 • Menomonee Falls, Wisconsin 53052-0450 USA

PHONE: 262.251.3800 • 800.558.8744 USA/CANADA

FAX: 262.251.7067 • 800.329.8744 U.S.A. ONLY

www.alto-shaam.com

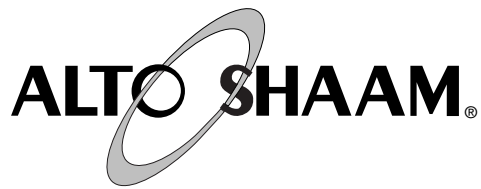

DELIVERY

This Alto-Shaam appliance has been thoroughly tested and inspected to insure only the highest quality unit is provided. Upon receipt, check for any possible shipping damage and report it at once to the delivering carrier. *See Transportation Damage and Claims section located in this manual.*

This appliance, complete with unattached items and accessories, may have been delivered in one or more packages. Check to ensure that all standard items and options have been received with each model as ordered.

Save all the information and instructions packed with the appliance. Complete and return the warranty card to the factory as soon as possible to assure prompt service in the event of a warranty parts and labor claim.

This manual must be read and understood by all people using or installing the equipment model. Contact the Alto-Shaam service department if you have any questions concerning installation, operation, or maintenance.

NOTE: All claims for warranty must include the full model number and serial number of the unit.

UNPACKING

1. Carefully remove the appliance from the carton or crate.

NOTE: Do not discard the carton and other packaging material until you have inspected the unit for hidden damage and tested it for proper operation.

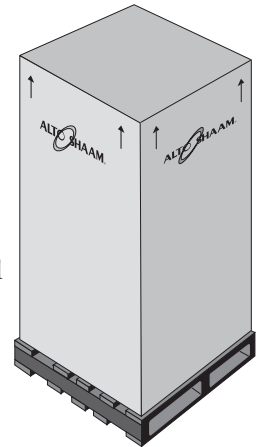

2. Read all instructions in this manual carefully before initiating the installation of this appliance.

DO NOT DISCARD THIS MANUAL.

This manual is considered to be part of the appliance and is to be provided to the owner or manager of the business or to the person responsible for training operators. *Additional manuals are available from the Alto-Shaam service department.*

3. Remove all protective plastic film, packaging materials, and accessories from the appliance before connecting electrical power. Store any accessories in a convenient place for future use.

SAFETY PROCEDURES AND PRECAUTIONS

Knowledge of proper procedures is essential to the safe operation of electrically and/or gas energized equipment. In accordance with generally accepted product safety labeling guidelines for potential hazards, the following signal words and symbols may be used throughout this manual.

DANGER



Used to indicate the presence of a hazard that **WILL** cause severe personal injury, death, or substantial property damage if the warning included with this symbol is ignored.

WARNING



Used to indicate the presence of a hazard that **CAN** cause personal injury, possible death, or major property damage if the warning included with this symbol is ignored.

CAUTION



Used to indicate the presence of a hazard that can or will cause minor or moderate personal injury or property damage if the warning included with this symbol is ignored.

CAUTION

Used to indicate the presence of a hazard that can or will cause minor personal injury, property damage, or a potential unsafe practice if the warning included with this symbol is ignored.

NOTE: Used to notify personnel of installation, operation, or maintenance information that is important but not hazard related.

1. This appliance is intended to cook, hold or process foods for the purpose of human consumption. No other use for this appliance is authorized or recommended.
2. This appliance is intended for use in commercial establishments where all operators are familiar with the purpose, limitations, and associated hazards of this appliance. Operating instructions and warnings must be read and understood by all operators and users.
3. Any troubleshooting guides, component views, and parts lists included in this manual are for general reference only and are intended for use by qualified technical personnel.
4. This manual should be considered a permanent part of this appliance. This manual and all supplied instructions, diagrams, schematics, parts lists, notices, and labels must remain with the appliance if the item is sold or moved to another location.

NOTE



For equipment delivered for use in any location regulated by the following directive:
DO NOT DISPOSE OF ELECTRICAL OR ELECTRONIC EQUIPMENT WITH OTHER MUNICIPAL WASTE.

INSTALLATION

Site Installation

1. The cabinet, complete with unattached items and accessories, may be delivered in one or more packages. Check to ensure all accessories ordered have been received.
2. This appliance is designed for the purpose of maintaining hot food at a temperature for safe consumption. The unit must be installed on a level surface in a location that will permit the equipment to function for its intended purpose and allow adequate access for proper cleaning and maintenance.
3. The appliance must not be installed in any area where it will be affected by steam, grease, dripping water, high temperatures, or any other severely adverse conditions.
5. In order to maintain standards established by the National Sanitation Foundation, all equipment must be equipped with casters or 4" (102mm) legs to provide minimum unobstructed space beneath the unit; or secured flush at the bottom and the entire base sealed with NSF approved sealant. Warranty will become null and void if these directions are not followed.

CLEARANCE REQUIREMENTS

3-inches (76mm) at the back
 2-inches (51mm) at the top
 1-inch (25mm) at both sides

On site venting for proper airflow must also be provided for built-in counter installations.

4. Level the appliance from side-to-side and front-to-back with the use of a spirit level.

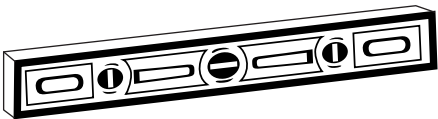

WEIGHT			
	500-1D	500-2D	500-3D
NET	80 lb (36 kg)	115 lb (52 kg)	150 lb (68 kg)
SHIP	90 lb (41 kg)	125 lb (57 kg)	165 lb (75 kg)

WEIGHT			
	500-1DN	500-2DN	500-3DN
NET	67 lb (30 kg)	100 lb (45 kg)	EST. 130 lb (59 kg) EST.
SHIP	75 lb (34 kg)	112 lb (51 kg)	145 lb (66 kg)

CAUTION



TO PREVENT PERSONAL INJURY,
 USE CAUTION WHEN MOVING OR
 LEVELING THIS APPLIANCE.

DANGER



IMPROPER INSTALLATION,
 ALTERATION, ADJUSTMENT,
 SERVICE, OR MAINTENANCE COULD
 RESULT IN SEVERE INJURY, DEATH
 OR CAUSE PROPERTY DAMAGE.
 READ THE INSTALLATION,
 OPERATING AND MAINTENANCE
 INSTRUCTIONS THOROUGHLY
 BEFORE INSTALLING OR SERVICING
 THIS EQUIPMENT.

INSTALLATION

Exterior Dimensions - 500-1D, 500-2D, 500-3D

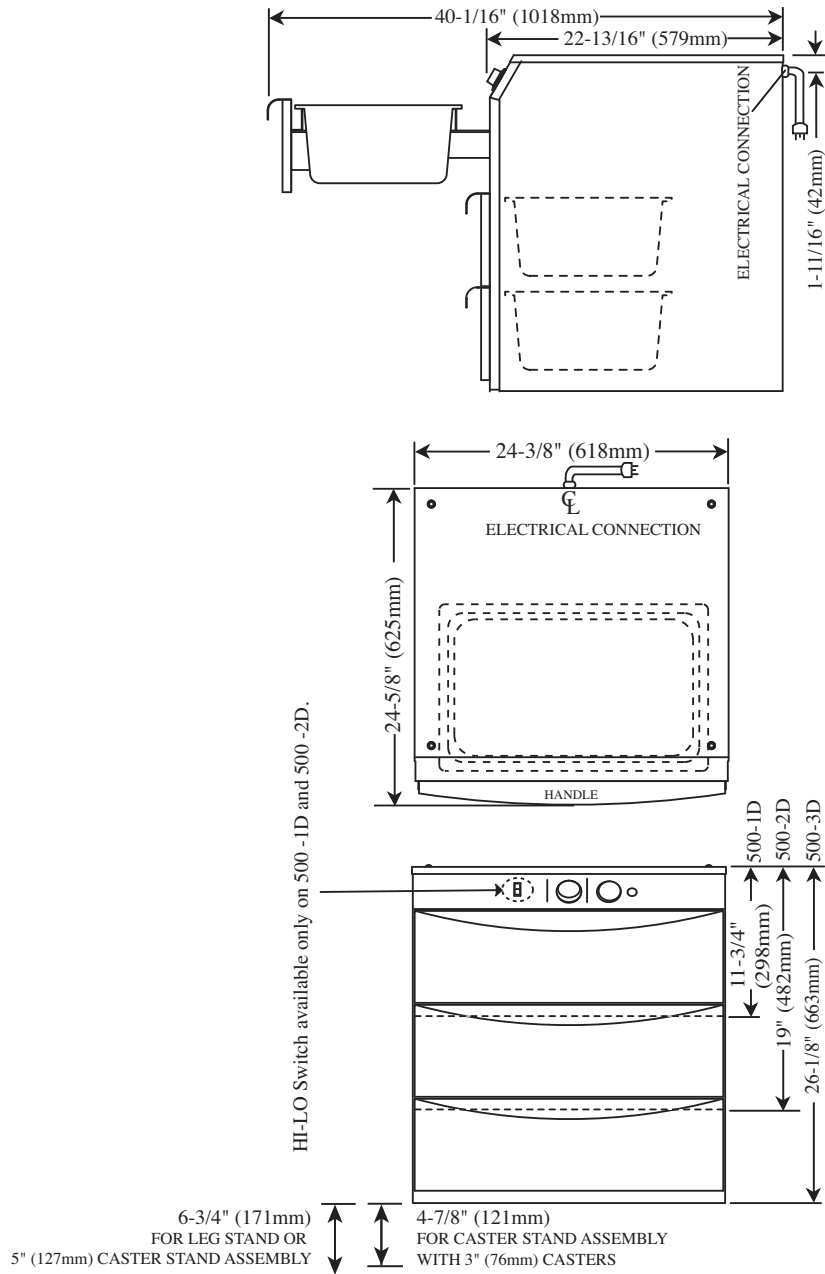

OPTIONS & ACCESSORIES

Built-in Trim Kit		Caster Stand Assembly with 5" (127mm) casters	15379
500-1D	44224	Caster Package, 3" (76mm) casters (must order 15379)	14227
500-2D	44226	Drawer Assembly with vents	55536
500-2D FOR BU2-48, BU2-72	55532	Leg Stand Assembly	15380
500-2D FOR BU2-96	44231	Pan, oversize, 15" x 20" x 5" (381 x 508 x 127 mm)	PN-2123
500-3D	44228	Perforated pan grid, 15" x 20" (381 x 508 mm)	1231
		Perforated pan grid, 12" x 20" (305 x 508 mm)	16642

INSTALLATION

Exterior Dimensions - 500-1DN, 500-2DN, 500-3DN

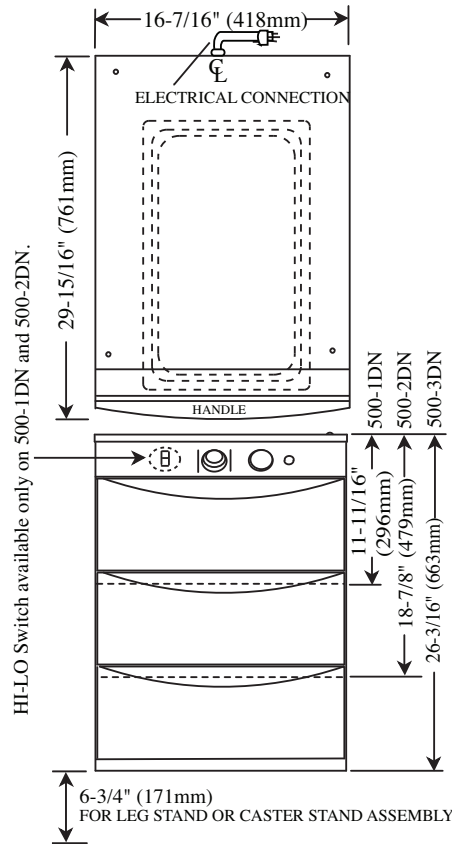
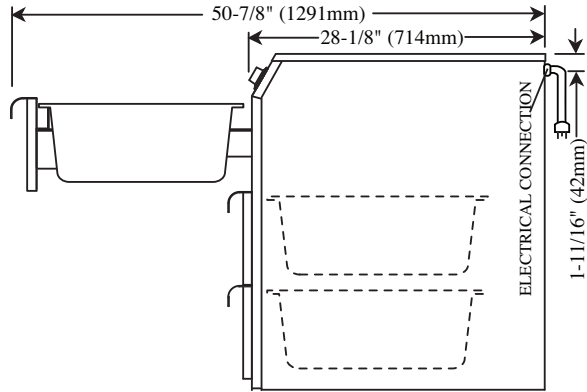

OPTIONS & ACCESSORIES

Built-in Trim Kit		Caster Stand Assembly	55534
500-1DN	44225	Drawer Assembly with vents	55537
500-2DN	44227	Leg Stand Assembly	55535
500-3DN	44229	Perforated pan grid, 12" x 20" (305mm x 508mm)	16642

INSTALLATION

Manual Control, 120V Unit

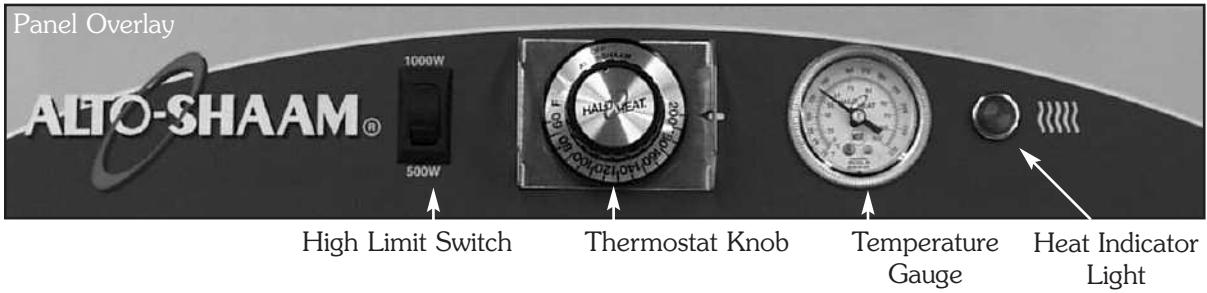

Manual Control, 208-240V, 230V Units



Drawer Assembly

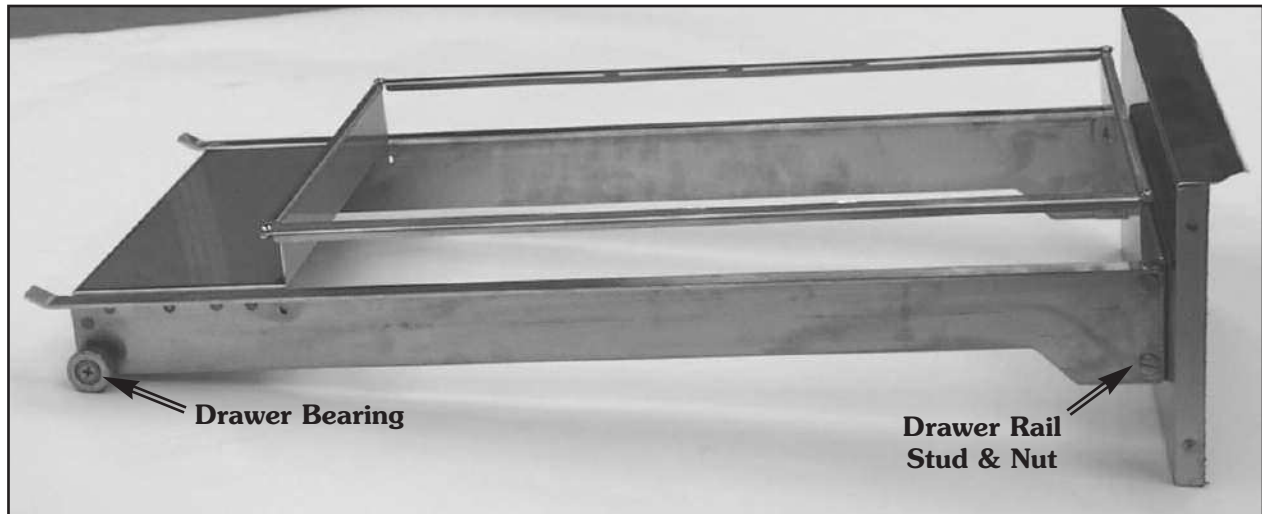

Electronic Control

Panel Overlay



INSTALLATION

ELECTRICAL



DANGER



ELECTRICAL CONNECTIONS MUST BE MADE BY A QUALIFIED SERVICE TECHNICIAN IN ACCORDANCE WITH APPLICABLE ELECTRICAL CODES.



DANGER



ENSURE POWER SOURCE MATCHES VOLTAGE STAMPED ON APPLIANCE NAMEPLATE.

DANGER



To avoid electrical shock, this appliance MUST be adequately grounded in accordance with local electrical codes or, in the absence of local codes, with the current edition of the National Electrical Code ANSI/NFPA No. 70. In Canada, all electrical connections are to be made in accordance with CSA C22.1, Canadian Electrical Code Part 1 or local codes.



1. An identification tag is permanently mounted on the cabinet.
2. Plug cabinet into a properly grounded receptacle ONLY, positioning the unit so the power supply cord is easily accessible in case of an emergency. Arcing will occur when connecting or disconnecting the unit unless all controls are in the "OFF" position.
3. If necessary, a proper receptacle or outlet configuration as required for this unit, must be installed by a licensed electrician in accordance with applicable, local electrical codes.

230V:

To prevent an electrical shock hazard between the appliance and other appliances or metal parts in close vicinity, an equalization-bonding stud is provided. An equalization bonding lead must be connected to this stud and the other appliances / metal parts to provide sufficient protection against potential difference. The terminal is marked with the following symbol. 



NOTE: The appliance must be connected to an electrical circuit that is protected by an external GFCI outlet.



DANGER



IMPROPER INSTALLATION, ALTERATION, ADJUSTMENT, SERVICE, OR MAINTENANCE COULD RESULT IN SEVERE INJURY, DEATH OR CAUSE PROPERTY DAMAGE.

READ THE INSTALLATION, OPERATING AND MAINTENANCE INSTRUCTIONS THOROUGHLY BEFORE INSTALLING OR SERVICING THIS EQUIPMENT.

ELECTRICAL - 500-1D; 500-2D; 500-3D					
VOLTAGE	PHASE	CYCLE/HZ	AMPS	kW	
120	1	60	LOW 4.0	0.5	 NEMA 5-15P 15A, 125V PLUG
			HIGH 8.5	1.05	
at 208	1	50/60	3.8	0.8	 NEMA 6-15P 15A, 250V PLUG FOR USA ONLY
at 240	1	50/60	4.4	1.05	
230	1	50/60	4.2	0.97	 CEE 7/7, 220-230V PLUG

ELECTRICAL - 500-1DN; 500-2DN; 500-3DN					
VOLTAGE	PHASE	CYCLE/HZ	AMPS	kW	
120	1	60	LOW 4.0	0.5	 NEMA 5-15P 15A, 125V PLUG
			HIGH 8.5	1.05	
at 208	1	50/60	3.8	0.8	 NEMA 6-15P 15A, 250V PLUG FOR USA ONLY
at 240	1	50/60	4.4	1.05	
230	1	50/60	4.2	0.97	 CEE 7/7, 220-230V PLUG

INSTALLATION

USER SAFETY INFORMATION

This appliance is intended for use in commercial establishments where all operators are familiar with the purpose, limitations, and associated hazards of this appliance. Operating instructions and warnings must be read and understood by all operators and users.

- 1. Make sure the unit is connected to the appropriate power source.**
- 2. Use hand protection when handling hot items.**
- 3. Preheat the unit for 30 minutes before use.**
- 4. Be certain only hot foods are placed into the unit.**

BEFORE INITIAL USE:

Before operating the unit, clean both the interior and exterior of the unit with a clean, damp cloth and mild soap solution. Rinse carefully. Clean and install the drawer warmer pan(s). The drawer assembly is completely removable. Clean as a sanitation measure.

HEATING CHARACTERISTICS

The drawer warmer is equipped with a special heating cable. Through this Halo Heat concept, the heating cable is mounted against the walls of the unit to provide an evenly applied heat source controlled by a thermostat. The design and operational characteristics of the unit eliminate the need for a moisture pan or a heat circulating fan. Through even heat application, the quality of food products is maintained up to several hours or more.

FOOD PRODUCT TIPS

Bread and Rolls

Breads and rolls are traditionally difficult to hold for prolonged periods due to the very low moisture content of these products. For best results and longest possible holding life, it is recommended these products be placed in a plastic bag while in the warming drawer. Breads and rolls should be held at a temperature no higher than 120° to 140°F (49° to 60°C).

Potatoes

— for the best results when holding potatoes:

1. Do not overcook.

Regardless of the temperature at which potatoes are cooked or what type of oven is used, it is important that this product does not achieve a final internal product temperature in excess of 195°F (91°C). Over-cooking will further reduce the moisture content and consequently, reduce the holding life. Potatoes should be removed from the oven when they reach an internal temperature of approximately 190°F (88°C). After they are removed from the oven, the internal temperature will continue to increase.

2. Allow potatoes to stabilize before placing in drawer warmer.

When potatoes are removed from a conventional high-temperature oven, they have an extremely high surface temperature. If they are placed in the drawer warmer while they are this hot on the outside, moisture will be pulled from the inside of the potato and condensation will form on the outside. Holding results under these conditions will not be totally satisfactory. Remove potatoes from the oven and allow the surface temperature to stabilize before placing them in the controlled holding atmosphere of the drawer warmer.

PRODUCT CAPACITY
36 lbs (16 kg) MAXIMUM • EACH DRAWER (34 BAKED POTATOES, 50 DINNER ROLLS)

OPERATION

MANUAL CONTROL

1. Dual wattage control.

The one and two drawer, 120V warmers are provided with a HIGH/LOW power switch. Use the HIGH position at 1000 watts for meats, potatoes, and vegetables — use the LOW position at 500 watts for breads and rolls.

2. Preheat at 200°F (93°C) for 30 minutes.

When the thermostat is turned clockwise to an “ON” position, the indicator light will illuminate and will remain lit as long as the unit is calling for heat. Allow a minimum of 30 minutes of preheating before loading the warmer with food. The indicator light will go “OUT” after approximately 30 minutes, or when the air temperature inside the unit reaches the temperature set by the operator.

3. Load the drawer warmer with pans of hot food only.

The purpose of the unit is to maintain hot food at proper serving temperatures. Only hot food should be placed into the warmer. Before loading the unit with food, use a food

thermometer to make certain all food products are at an internal temperature range of 140° to 160°F (60° to 71°C). All food not within the proper temperature range should be heated before putting into the drawer warmer.

4. Reset the thermostat to 160°F (71°C).

Check to make certain the drawer is securely closed, and reset the thermostat to 160°F (71°C).

THIS WILL NOT NECESSARILY BE THE FINAL SETTING.

The proper temperature range for the food being held will depend on the type and quantity of product. When holding food for prolonged periods, it is advisable to periodically check the internal temperature of each item to assure maintenance of the proper temperature range.

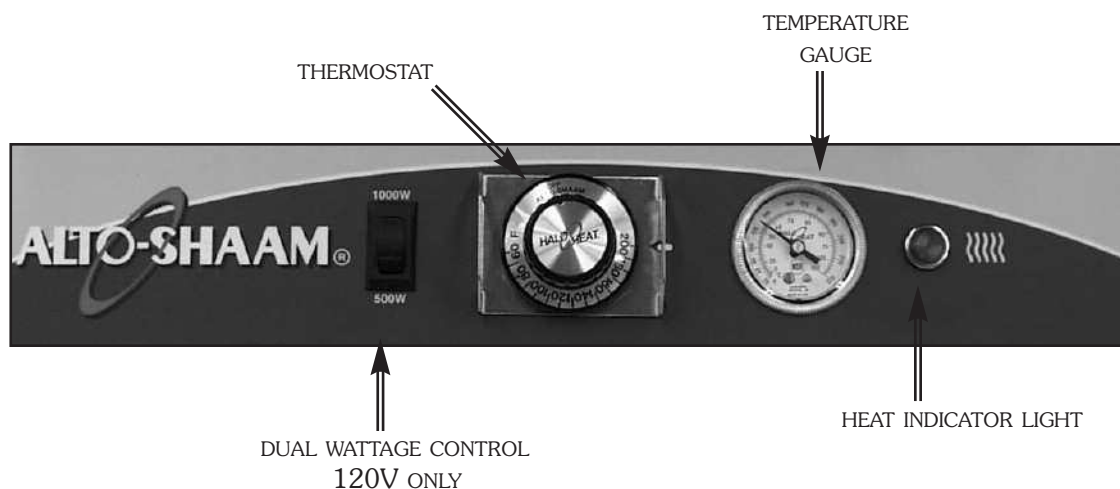

OPERATION - ELECTRONIC CONTROL

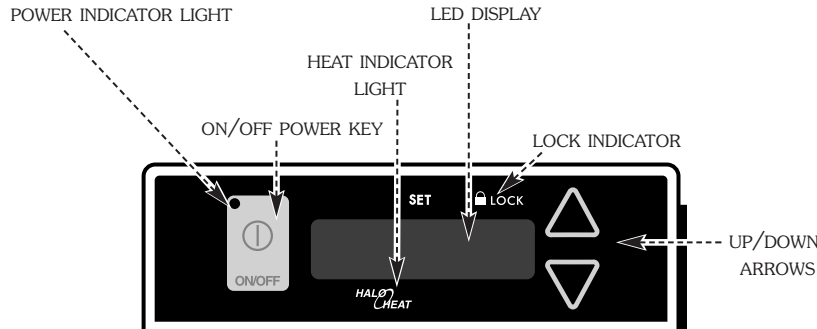

ON/OFF KEY

Press the on/off key once and the power indicator light will illuminate. Press and hold the on/off key until the LED display turns off (at least three seconds) and on/off indicator goes out.

UP/DOWN ARROW KEY

The up and down arrow keys are used for a variety of settings when selecting the holding temperature. If an arrow key is pressed and released the display will show the current set temperature for two seconds. If an arrow key is held (at least eight seconds), the value will change at a rapid rate. If the arrow key is pressed and released in rapid succession, the set temperature will change by increments of one degree.

ENABLE/DISABLE BEEPER

A beeper sounds when an error code is displayed. To choose between beeper on and beeper off mode, the control must be OFF, then press and hold the down arrow key until either "ON" or "OFF" is shown in the LED display. Release arrow key when desired mode is displayed.

FAHRENHEIT / CELSIUS

With the control OFF, to choose between Fahrenheit and Celsius, press and hold the up arrow key until either °F or °C is shown in the LED display. Release key when desired setting is displayed.

The control has a four-digit LED display. When the display is ON, it will show current holding temperature, as well as diagnostic information.

CONTROL LOCK

The warmer controls can be locked so that no changes can be made to the set temperature.

To **lock the display**, press and hold the ON/OFF key and the Up Arrow key at the same time. The lock indicator will illuminate. When the lock indicator is illuminated, additional programming will not be functional other than the key sequence required to unlock the panel.

To **unlock the display**, press and hold the ON/OFF key and the Down Arrow key at the same time. The lock indicator will extinguish. The panel keys will resume normal function.

1. Preheat at 200°F (93°C) for 30 minutes.

Press the ON key, and set the temperature to 200°F (93°C) by using the UP/DOWN arrow keys. Allow a minimum of 30 minutes preheating time before loading the drawer warmer with food. The LED heat indicator light will go "OUT" after approximately 30 minutes preheat time, or when the air temperature inside the unit reaches the temperature set by the operator.

2. Load with pans of hot food only.

The purpose of the warmer is to maintain hot food at proper serving temperature. Only hot food should be placed into the unit. Before loading with food, use a food thermometer to make certain all products are at an internal temperature range of 140° to 160°F (60° to 71°C). Any food product not within the proper temperature range should be heated before loading into the unit.

3. Reset the control to 160°F (71°C).

Check to make certain the drawer is securely closed, and reset to 160°F (71°C) by using the UP/DOWN keys.

THIS WILL NOT NECESSARILY BE THE FINAL SETTING.

The proper temperature range will depend on the type and quantity of product. When holding food for prolonged periods, it is advisable to periodically check the internal temperature of each item with a food thermometer to assure maintenance of the proper temperature range of 140° to 160°F (60° to 71°C).

OPERATION

GENERAL HOLDING GUIDELINES

Chefs, cooks and other specialized food service personnel employ varied methods of cooking. Proper holding temperatures for a specific food product must be based on the moisture content of the product, product density, volume, and proper serving temperatures. Safe holding temperatures must also be correlated with palatability in determining the length of holding time for a specific product.

Halo Heat maintains the maximum amount of product moisture content without the addition of water, water vapor, or steam. Maintaining maximum natural product moisture preserves the natural flavor of the product and provides a more genuine taste. In addition to product moisture retention, the gentle properties of Halo Heat maintain a consistent temperature throughout the cabinet without the necessity of a heat distribution fan, thereby preventing further moisture loss due to evaporation or dehydration.

When product is removed from a high temperature cooking environment for immediate transfer into equipment with the lower temperature required for hot food holding, condensation can form on the outside of the product and on the inside of plastic containers used in self-service applications. Allowing the product to release the initial steam and heat produced by high temperature cooking can alleviate this condition. To preserve the safety and quality of freshly cooked foods however, a maximum of 1 to 2 minutes must be the only time period allowed for the initial heat to be released from the product.

Most Halo Heat holding equipment is provided with a thermostat control between 60° and 200°F (16° to 93°C). If the unit is equipped with vents, close the vents for moist holding and open the vents for crisp holding.

If the unit is equipped with a thermostat indicating a range of between 1 and 10, use a metal-stemmed indicating thermometer to measure the internal temperature of the product(s) being held. Adjust the thermostat setting to achieve the best overall setting based on internal product temperature.

HOLDING TEMPERATURE RANGE		
MEAT	FAHRENHEIT	CELSIUS
BEEF ROAST — Rare	130°F	54°C
BEEF ROAST — Med/Well Done	155°F	68°C
BEEF BRISKET	160° — 175°F	71° — 79°C
CORN BEEF	160° — 175°F	71° — 79°C
PASTRAMI	160° — 175°F	71° — 79°C
PRIME RIB — Rare	130°F	54°C
STEAKS — Broiled/Fried	140° — 160°F	60° — 71°C
RIBS — Beef or Pork	160°F	71°C
VEAL	160° — 175°F	71° — 79°C
HAM	160° — 175°F	71° — 79°C
PORK	160° — 175°F	71° — 79°C
LAMB	160° — 175°F	71° — 79°C
POULTRY		
CHICKEN — Fried/Baked	160° — 175°F	71° — 79°C
DUCK	160° — 175°F	71° — 79°C
TURKEY	160° — 175°F	71° — 79°C
GENERAL	160° — 175°F	71° — 79°C
FISH/SEAFOOD		
FISH — Baked/Fried	160° — 175°F	71° — 79°C
LOBSTER	160° — 175°F	71° — 79°C
SHRIMP — Fried	160° — 175°F	71° — 79°C
BAKED GOODS		
BREADS/ROLLS	120° — 140°F	49° — 60°C
MISCELLANEOUS		
CASSEROLES	160° — 175°F	71° — 79°C
DOUGH — Proofing	80° — 100°F	27° — 38°C
EGGS — Fried	150° — 160°F	66° — 71°C
FROZEN ENTREES	160° — 175°F	71° — 79°C
HORS D'OEUVRES	160° — 180°F	71° — 82°C
PASTA	160° — 180°F	71° — 82°C
PIZZA	160° — 180°F	71° — 82°C
POTATOES	180°F	82°C
PLATED MEALS	140° — 165°F	60° — 74°C
SAUCES	140° — 200°F	60° — 93°C
SOUP	140° — 200°F	60° — 93°C
VEGETABLES	160° — 175°F	71° — 79°C
THE HOLDING TEMPERATURES LISTED ARE SUGGESTED GUIDELINES ONLY. ALL FOOD HOLDING SHOULD BE BASED ON INTERNAL PRODUCT TEMPERATURES. ALWAYS FOLLOW LOCAL HEALTH (HYGIENE) REGULATIONS FOR ALL INTERNAL TEMPERATURE REQUIREMENTS.		

CLEANING AND PREVENTIVE MAINTENANCE

PROTECTING STAINLESS STEEL SURFACES



It is important to guard against corrosion in the care of stainless steel surfaces. Harsh, corrosive, or inappropriate chemicals can completely destroy the

protective surface layer of stainless steel. Abrasive pads, steel wool, or metal implements will abrade surfaces causing damage to this protective coating and will eventually result in areas of corrosion. Even water, particularly hard water that contains high to moderate concentrations of chloride, will cause oxidation and pitting that result in rust and corrosion. In addition, many acidic foods spilled and left to remain on metal surfaces are contributing factors that will corrode surfaces.

Proper cleaning agents, materials, and methods are vital to maintaining the appearance and life of this appliance. Spilled foods should be removed and the area wiped as soon as possible but at the very least, a minimum of once a day. Always thoroughly rinse surfaces after using a cleaning agent and wipe standing water as quickly as possible after rinsing.

CLEANING AGENTS

Use non-abrasive cleaning products designed for use on stainless steel surfaces. Cleaning agents must be chloride-free compounds and must not contain quaternary salts. Never use hydrochloric acid (muriatic acid) on stainless steel surfaces. Always use the proper cleaning agent at the manufacturer's recommended strength. Contact your local cleaning supplier for product recommendations.

CLEANING MATERIALS

The cleaning function can usually be accomplished with the proper cleaning agent and a soft, clean cloth. When more aggressive methods must be employed, use a non-abrasive scouring pad on difficult areas and make certain to scrub with the visible grain of surface metal to avoid surface scratches. Never use wire brushes, metal scouring pads, or scrapers to remove food residue.

 CAUTION	
 NO SCRAPERS	TO PROTECT STAINLESS STEEL SURFACES, COMPLETELY AVOID THE USE OF ABRASIVE CLEANING COMPOUNDS, CHLORIDE BASED CLEANERS, OR CLEANERS CONTAINING QUATERNARY SALTS. NEVER USE HYDROCHLORIC ACID (MURIATIC ACID) ON STAINLESS STEEL. NEVER USE WIRE BRUSHES, METAL SCOURING PADS OR SCRAPERS.
 NO WIRE BRUSHES	
 NO STEEL PADS	

CARE and CLEANING



The cleanliness and appearance of this unit will contribute considerably to operating efficiency and savory, appetizing food. Good equipment kept clean works better and lasts longer.

THOROUGHLY CLEAN DAILY

1. Disconnect unit from power source, and let cool.
2. Remove, cover or wrap, and refrigerate food.
3. Remove drawer pans and clean separately. The drawer assembly is completely removable. Remove from the cabinet and clean to prevent a build-up of food residue from interfering with the function of the drawer assembly. Regular cleaning will help prolong the life of these parts.
4. Clean interior metal surfaces of the unit with a damp, clean cloth and any good commercial detergent or grease solvent at the recommended strength. Use a plastic scouring pad or oven cleaner for difficult areas. Rinse carefully to remove all residue and wipe dry.



- NOTE:** Avoid the use of abrasive cleaning, compounds, chloride based cleaners, or cleaners containing quaternary salts. Never use hydrochloric acid (muriatic acid) on stainless steel.
5. Wipe control panel, vents, handles, and gaskets thoroughly since these areas harbor food debris.
 6. Interior can be wiped with a sanitizing solution after cleaning and rinsing. This solution must be approved for use on stainless steel food contact surfaces.
 7. To help maintain the protective film coating on polished stainless steel, clean the exterior of the unit with a cleaner recommended for stainless steel surfaces. Spray the cleaning agent on a cloth and wipe with the grain of the stainless steel.

Always follow appropriate state or local health (hygiene) regulations regarding all applicable cleaning and sanitation requirements for foodservice equipment.

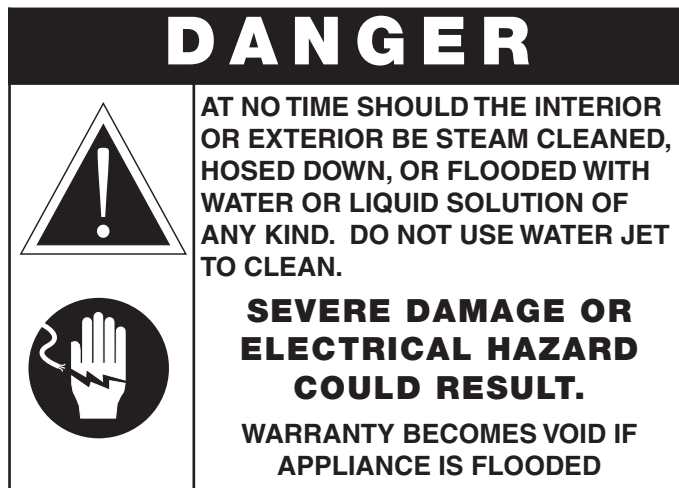
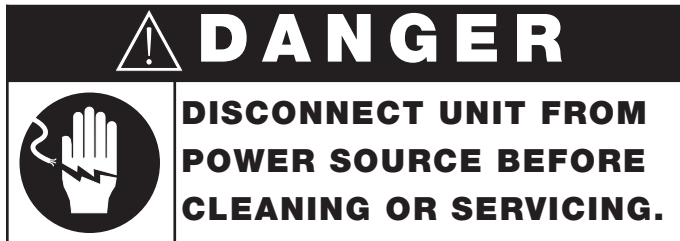

SANITATION

Food flavor and aroma are usually so closely related that it is difficult, if not impossible, to separate them. There is also an important, inseparable relationship between cleanliness and food flavor. Cleanliness, top operating efficiency, and appearance of equipment contribute considerably to savory, appetizing foods. Good equipment that is kept clean, works better and lasts longer.

Most food imparts its own particular aroma and many foods also absorb existing odors. Unfortunately, during this absorption, there is no distinction between GOOD and BAD odors. The majority of objectionable flavors and odors troubling food service operations are caused by bacteria growth. Sourness, rancidity, mustiness, stale or other OFF flavors are usually the result of germ activity.

The easiest way to insure full, natural food flavor is through comprehensive cleanliness. This means good control of both visible soil (dirt) and invisible soil (germs). A thorough approach to sanitation will provide essential cleanliness. It will assure an attractive appearance of equipment, along with maximum efficiency and utility. More importantly, a good sanitation program provides one of the key elements in the prevention of food-borne illnesses.

A controlled holding environment for prepared foods is just one of the important factors involved in the prevention of food-borne illnesses. Temperature monitoring and control during receiving, storage, preparation, and the service of foods are of equal importance.

The most accurate method of measuring safe temperatures of both hot and cold foods is by internal product temperature. A quality thermometer is an effective tool for this purpose, and should be routinely used on all products that require holding at a specific temperature.

A comprehensive sanitation program should focus on the training of staff in basic sanitation procedures. This includes personal hygiene, proper handling of raw foods, cooking to a safe internal product temperature, and the routine monitoring of internal temperatures from receiving through service.

Most food-borne illnesses can be prevented through proper temperature control and a comprehensive program of sanitation. Both these factors are important to build quality service as the foundation of customer satisfaction. Safe food handling practices to prevent food-borne illness is of critical importance to the health and safety of your customers.

HACCP, an acronym for Hazard Analysis (at) Critical Control Points, is a quality control program of operating procedures to assure food integrity, quality, and safety. Taking steps necessary to augment food safety practices are both cost effective and relatively simple. While HACCP guidelines go far beyond the scope of this manual, additional information is available by contacting:

**CENTER FOR FOOD SAFETY AND APPLIED
NUTRITION FOOD AND DRUG ADMINISTRATION
1-888-SAFEFOOD**

INTERNAL FOOD PRODUCT TEMPERATURES		
HOT FOODS		
DANGER ZONE	40° TO 140°F	(4° TO 60°C)
CRITICAL ZONE	70° TO 120°F	(21° TO 49°C)
SAFE ZONE	140° TO 165°F	(60° TO 74°C)
COLD FOODS		
DANGER ZONE	ABOVE 40°F	(ABOVE 4°C)
SAFE ZONE	36°F TO 40°F	(2°C TO 4°C)
FROZEN FOODS		
DANGER ZONE	ABOVE 32°F	(ABOVE 0°C)
CRITICAL ZONE	0° TO 32°F	(-18° TO 0°C)
SAFE ZONE	0°F or below	(-18°C or below)

SERVICE

MANUAL CONTROL

THERMOSTAT and HEAT LIGHT SEQUENCE

Whenever the thermostat is turned "ON," the heat indicator light will indicate the power ON/OFF condition of the heating cable, and consequently, the cycling of the cabinet as it maintains the dialed cavity temperature. If the light does not illuminate after normal start-up, the main power source, thermostat, and/or light must be checked. If the warming cabinet does not hold the temperature as dialed, the calibration of the thermostat must be checked. If the warmer fails to heat or heats continuously with the thermostat "OFF," the thermostat must be initially checked for proper operation. If these items are checked and found to be in order, a continuity and resistance check of the heating cable should be made. *SEE CIRCUIT DIAGRAM.*

THERMOSTAT CALIBRATION

The thermostat is precision calibrated at the factory. Normally, no adjustment or recalibration is necessary unless the thermostat has been mishandled in transit, changed or abused while in service. A thermostat with a sensing bulb operates on hydraulic pressure, consequently, any bending of the bulb results in a change in its volume, and alters the accuracy of the thermostat calibration.

A thermostat should be checked or recalibrated by placing a quality, thermal indicator at the center of an empty holding cavity. *DO NOT CALIBRATE WITH ANY FOOD PRODUCT IN THE CABINET.* The thermostat should be set at 140°F (60°C), and should be allowed to stabilize at that setting for a minimum of one hour. Following temperature stabilization, the center of the thermal swing of the air temperature within the cabinet should approximately coincide with the thermostat dial setting.

If calibration is necessary, the calibration screw should be adjusted with great care. The calibration screw of the thermostat is located in the thermostat dial shaft. With the shaft held stationary, a minute, clockwise motion of the calibration screw appreciably lowers the thermostat setting. A reverse, or counter-clockwise motion appreciably raises the thermostat setting. After achieving the desired cycling of the thermostat, the calibration screw must be sealed. Place a few drops of enamel sealant directly on the calibration screw. *(RED NAIL POLISH OR EQUIVALENT IS ACCEPTABLE.)*

TROUBLE SHOOTING CHECKLIST • ELECTRONIC CONTROL

Repairs should be made by authorized service agents only.

TROUBLE	POSSIBLE CAUSE	REMEDY
Unit does not operate.	Insufficient power supply.	Check power source.
	Defective power cord or plug.	Check and replace if necessary.
No display in electronic control.	Faulty power supply board.	Check line voltage for 24V across pins 7 and 8 on the power supply board and across terminals J9 and J10 on the electronic control.
	Faulty electronic control.	Replace control.
Cannot control temperature but sensor and electronic control checks O.K.	Faulty relay	Replace relay.
	Heating element grounded.	Replace element.
Temperature readout incorrect.	Dirty or faulty sensor.	Check sensor at 32°F (0°C). If Ohm reading is 100, replace display.
	Faulty control.	If Ohm reading is not 100, replace sensor.

SERVICE

TROUBLE SHOOTING • ELECTRONIC CONTROL

Error Code	Description/Results	Possible Cause Service Required
E-10	Air Sensor Fault (shorted) <i>Inoperative Oven</i>	Air sensor is shorted. Air sensor is defective.
E-11	Air Sensor Fault (open) <i>Inoperative Oven</i>	Air sensor is open or has connection failure. Need air sensor test. See below.
E-30	Under temperature <i>Oven will not reach set temperature</i>	Oven door closed? Door gasket need replacement? Preheat skipped? Oven overloaded or has frozen product? Defective air sensor or probe? Defective solid state relay? Bad wire connections or open heating cable? Is the high limit switch tripped? If none of the above, call service.
E-31	Over temperature <i>Oven will shut down</i>	Shorted cable? Defective solid state relay? Defective air sensor? If none of the above, call service.
E-60	Real time clock error <i>Inoperative Oven</i>	Appliance has probably been unplugged for more than 30 days. If this is the case, it should be plugged in with the circuit breaker ON, and the appliance displaying the E-60 on the front panel for more than 30 minutes. Once this has been accomplished, the circuit breaker should be turned OFF, or the appliance unplugged for approximately 10 seconds after which the appliance should be turned ON again.
E-70	Configuration connector error <i>Inoperative Oven</i>	Check control connections for loose wires. If none, control must be replaced.
E-78	Voltage low <i>Inoperative Oven</i>	If 125 VAC unit, voltage is below 90 VAC. Correct. If 208-240 VAC voltage is below 190 VAC. Correct.
E-79	Voltage high <i>Inoperative Oven</i>	If 125 VAC unit, voltage is over 130 VAC. Correct. If 208-240 VAC, voltage is over 250 VAC. Correct.
E-80	EEPROM - Function data error <i>Inoperative Oven</i>	Replace control.
E-82	EEPROM - Calibration data error <i>Inoperative Oven</i>	Replace control.
E-84	EEPROM - Unit ID error <i>Inoperative Oven</i>	Replace control.
E-86	EEPROM - Preset data error <i>Inoperative Oven</i>	Replace control.

To test air sensor:

Test air sensor by placing sensor in ice water bath and using an ohmmeter set on the ohm scale. The reading should be 100 ohms resistance. If it is more than 2 ohms higher or lower, sensor needs to be replaced.

CAUTION

THIS SECTION IS PROVIDED FOR THE ASSISTANCE OF QUALIFIED SERVICE TECHNICIANS ONLY AND IS NOT INTENDED FOR USE BY UNTRAINED OR UNAUTHORIZED SERVICE PERSONNEL.



DANGER



DISCONNECT UNIT FROM POWER SOURCE BEFORE CLEANING OR SERVICING.

Wide Drawer Warmers – Service Parts

Illustrations on following pages.

<u>Part Description</u>	<u>Qty</u>	<u>500-1D</u>	<u>Qty</u>	<u>500-2D</u>	<u>Qty</u>	<u>500-3D</u>
Manual or Electronic Control • Wide Drawer Warmers						
Air Tunnel	1	1002672	1	1002672	1	1002672
Cable Replacement Kit (CB-3044)	1	4874	1	4874	1	4874
Casing Bottom	1	1002400	1	1002400	1	1002400
Casing Top	1	1002403	1	1002403	1	1002403
Casing	1	1002558	1	1002396	1	1002564
Cordset (120V)	1	CD-3232	1	CD-3232	1	CD-3232
Cordset (208/240)	1	CD-33840	1	CD-33840	1	CD-33840
Cordset (230V)	1	CD-3922	1	CD-3922	1	CD-3922
Drawer Assembly	1	55502	2	55502	3	55502
Drawer front Mounting Stud	4	ST-25019	8	ST-25019	12	ST-25019
Drawer front Mounting Nut	4	NU-2187	8	NU-2187	12	NU-2187
Drawer Bearing	6	BG-24890	12	BG-24890	18	BG-24890
Drawer Pan (NOT SHOWN)	1	PN-25088	2	PN-25088	3	PN-25088
Drawer with vents	1	55536	2	55536	3	55536
Fan, Box (120V)	1	FA-3973	1	FA-3973	1	FA-3973
Fan, Box (208/240V, 230V)	1	FA-3974	1	FA-3974	1	FA-3974
Insulation, Board	3	IN-2003	3	IN-2003	3	IN-2003
Switch (230V), circuit breaker	1	SW-33487	1	SW-33487	1	SW-33487
Switch (120V), wattage	1	SW-3409	1	SW-3409		N/A
Terminal Block	1	BK-3019	1	BK-3019	1	BK-3019
Manual Control Wide • Drawer Warmers						
Heat Indicator Light (120V)	1	LI-3027	1	LI-3027	1	LI-3027
Heat Indicator Light (208/240V)	1	LI-3025	1	LI-3025	1	LI-3025
Heat Indicator Light (230V)	1	LI-3951	1	LI-3951	1	LI-3951
Knob, Thermostat (120V, 208/240V)	1	KN-3469	1	KN-3469	1	KN-3469
Knob, Thermostat (230V ONLY)	1	KN-3474	1	KN-3474	1	KN-3474
Panel Overlay (120V)	1	PE-25068	1	PE-25068	1	PE-25067
Panel Overlay (208/240V, 230V)	1	PE-25067	1	PE-25067	1	PE-25067
Thermostat	1	TT-3057	1	TT-3057	1	TT-3057
Temperature Gauge	1	TH-33713	1	TH-33713	1	TH-33713
Temperature Gauge Lens Cover replacement	1	TH-33956	1	TH-33956	1	TH-33956
Electronic Control • Wide Drawer Warmers						
Beeper	1	BP-3567	1	BP-3567	1	BP-3567
Block, Sensor	1	BK-33546	1	BK-33546	1	BK-33546
Board, Power Supply	1	BA-33554	1	BA-33554	1	BA-33554
Control, Electronic	1	5000876	1	5000876	1	5000876
Panel Overlay	1	PE-25327	1	PE-25327	1	PE-25327
Relay	1	RL-33558	1	RL-33558	1	RL-33558
Sensor	1	SN-33541	1	SN-33541	1	SN-33541
Thermostat, Electronic, 230V ONLY	1	TT-33789	1	TT-33789	1	TT-33789

Narrow Drawer Warmers – Service Parts

Illustrations on following pages.

<u>Part Description</u>	<u>Qty</u>	<u>500-1DN</u>	<u>Qty</u>	<u>500-2DN</u>	<u>Qty</u>	<u>500-3DN</u>
<u>Manual or Electronic Control • Narrow Drawer Warmers</u>						
Air Tunnel	1	1002672	1	1002672	1	1002672
Cable Replacement Kit (CB-3044)	1	4874	1	4874	1	4874
Casing Bottom	1	1002794	1	1002794	1	1002794
Casing Top	1	1002798	1	1002798	1	1002798
Casing	1	1002884	1	1002837	1	1002799
Cordset (120V)	1	CD-3232	1	CD-3232	1	CD-3232
Cordset (208/240)	1	CD-33840	1	CD-33840	1	CD-33840
Cordset (230V)	1	CD-3922	1	CD-3922	1	CD-3922
Drawer Assembly	1	55509	2	55509	3	55509
Drawer front Mounting Stud	4	ST-25019	8	ST-25019	12	ST-25019
Drawer front Mounting Nut	4	NU-2187	8	NU-2187	12	NU-2187
Drawer Bearing	6	BG-24890	12	BG-24890	18	BG-24890
Drawer Pan (NOT SHOWN)	1	PN-25088	2	PN-25088	3	PN-25088
Drawer with vents	1	55537	2	55537	3	55537
Fan, Box (120V)	1	FA-3973	1	FA-3973	1	FA-3973
Fan, Box (208/240V, 230V)	1	FA-3974	1	FA-3974	1	FA-3974
Insulation, Board	3	IN-2003	3	IN-2003	3	IN-2003
Switch (230V), circuit breaker	1	SW-33487	1	SW-33487	1	SW-33487
Switch (120V) wattage	1	SW-3409	1	SW-3409		N/A
Terminal Block	1	BK-3019	1	BK-3019	1	BK-3019
<u>Manual Control • Narrow Drawer Warmers</u>						
Heat Indicator Light (120V)	1	LI-3027	1	LI-3027	1	LI-3027
Heat Indicator Light (208/240V)	1	LI-3025	1	LI-3025	1	LI-3025
Heat Indicator Light (230V)	1	LI-3951	1	LI-3951	1	LI-3951
Knob, Thermostat (120V, 208/240V)	1	KN-3469	1	KN-3469	1	KN-3469
Knob, Thermostat (230V ONLY)	1	KN-3474	1	KN-3474	1	KN-3474
Panel Overlay (120V)	1	PE-25014	1	PE-25014	1	PE-25013
Panel Overlay (208/240V, 230V)	1	PE-25013	1	PE-25013	1	PE-25013
Thermostat	1	TT-33626	1	TT-33626	1	TT-33626
Temperature Gauge	1	TH-33713	1	TH-33713	1	TH-33713
Temperature Gauge Lens Cover replacement	1	TH-33956	1	TH-33956	1	TH-33956
<u>Electronic Control • Narrow Drawer Warmers</u>						
Beeper	1	BP-3567	1	BP-3567	1	BP-3567
Block, Sensor	1	BK-24427	1	BK-24427	1	BK-24427
Board, Power Supply	1	BA-33554	1	BA-33554	1	BA-33554
Control, Electronic	1	5000876	1	5000876	1	5000876
Panel Overlay	1	PE-25326	1	PE-25326	1	PE-25326
Relay	1	RL-33558	1	RL-33558	1	RL-33558
Sensor	1	SN-33541	1	SN-33541	1	SN-33541
Thermostat, Electronic, 230V only	1	TT-33789	1	TT-33789	1	TT-33789

SERVICE

500-3D • Manual control • top removed



INDICATOR LIGHT
LI-3027
LI-3025
LI-3951

THERMOMETER
TH-33713

THERMOSTAT
TT-3057
TT-33626

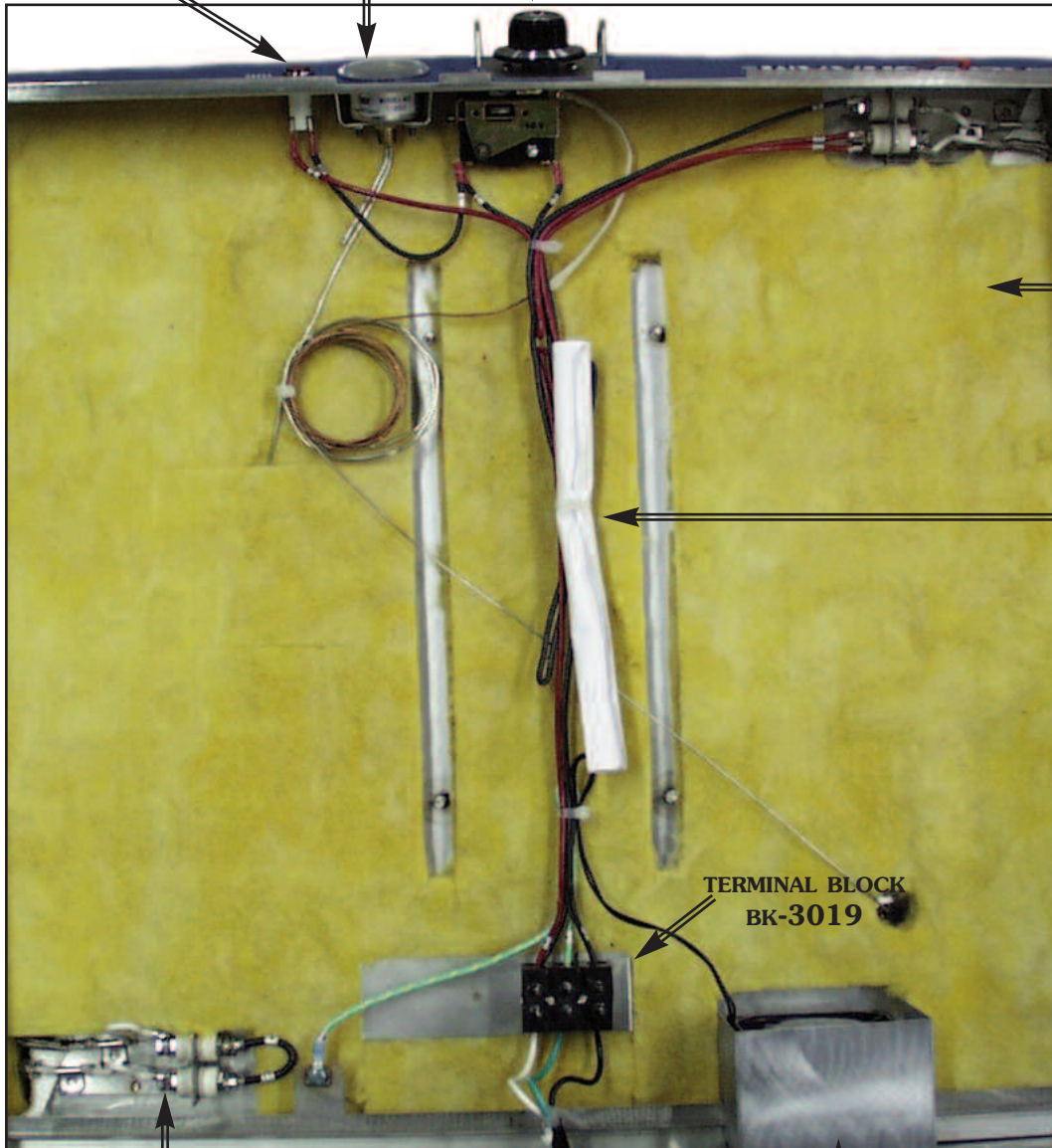

INSULATION
IN-2003

WIRING
DIAGRAM

TERMINAL BLOCK
BK-3019

HEATING ELEMENT
CONNECTIONS

ELECTRIC CORD
CD-3232
CD-33840
CD-3922

AIR TUNNEL 1002672
(EXHAUST FAN INSIDE)
FA-3973
FA-3974

SERVICE

500-3D • Electronic control • top removed • 230V

CONTROL #5000876 WITHOUT SCI • CONTROL #5000877 WITH SCI

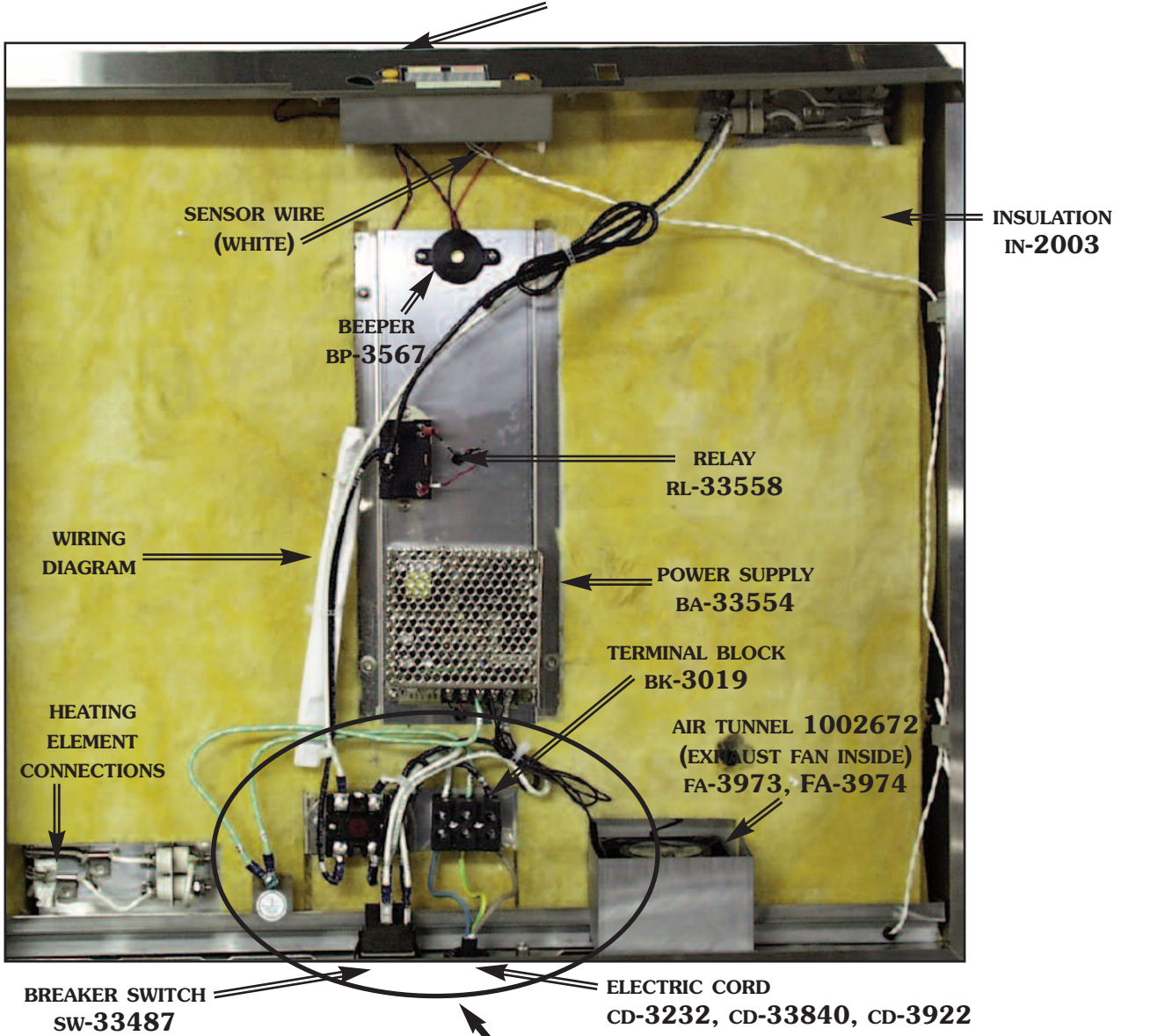

THIS PHOTOGRAPH IS AN ENLARGEMENT OF THE CIRCLED AREA ABOVE.

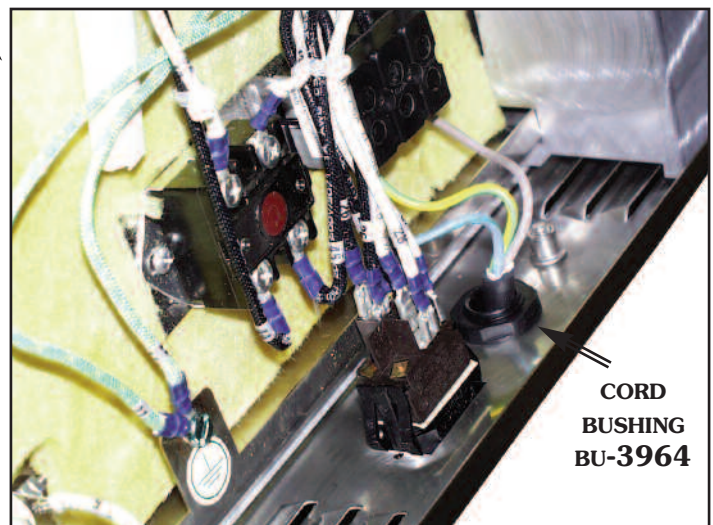

SERVICE

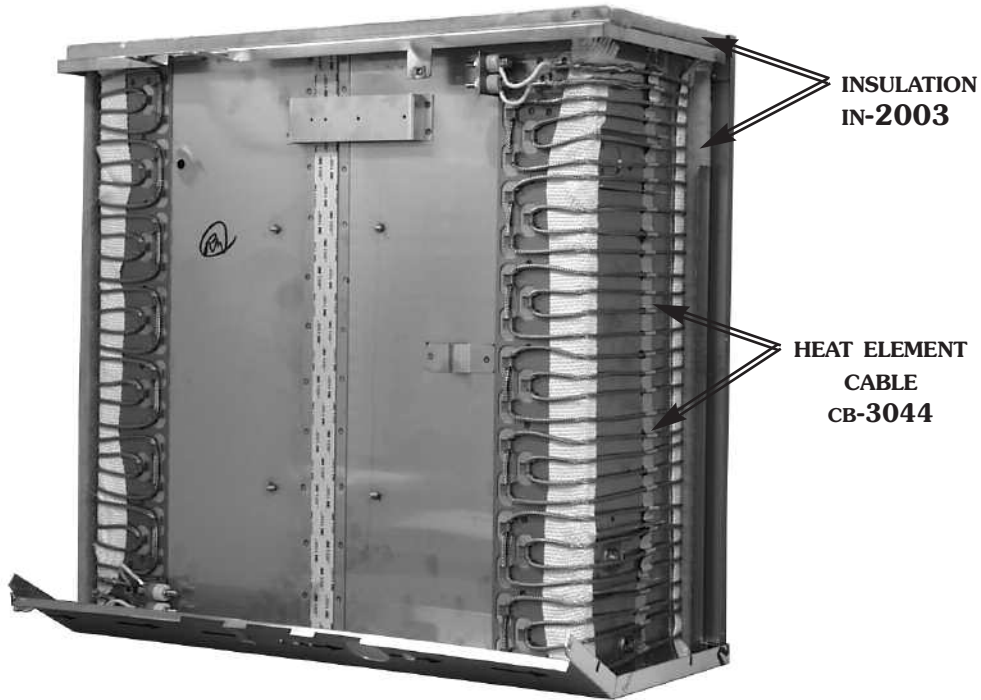

500-3D
Interior

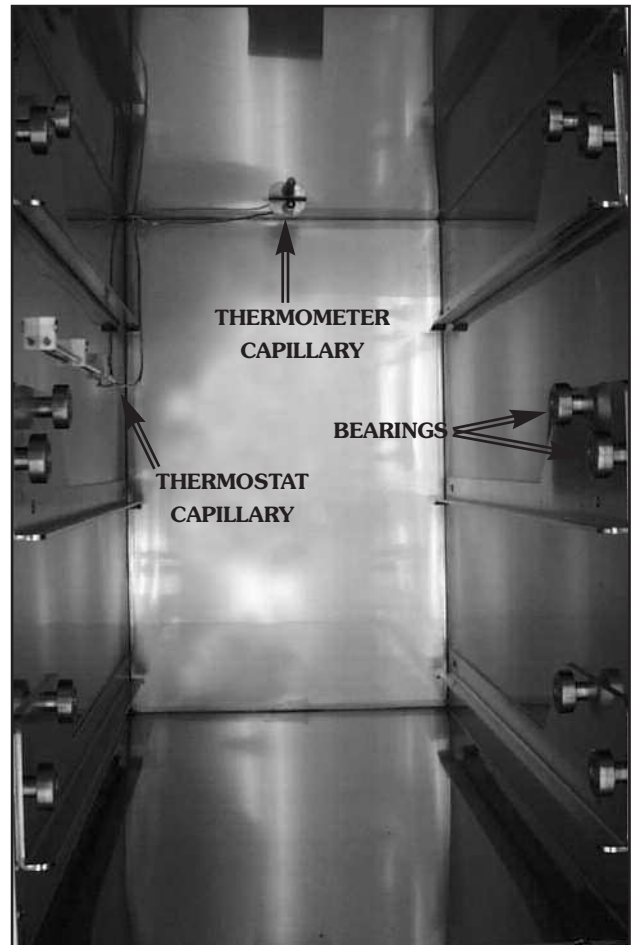

⚠ DANGER

**DISCONNECT UNIT FROM
POWER SOURCE BEFORE
CLEANING OR SERVICING.**

Detailed description: A safety warning box with a black background and white text. It features a warning symbol (a triangle with an exclamation mark) and a hand symbol with a lightning bolt. The text is in bold, uppercase letters.



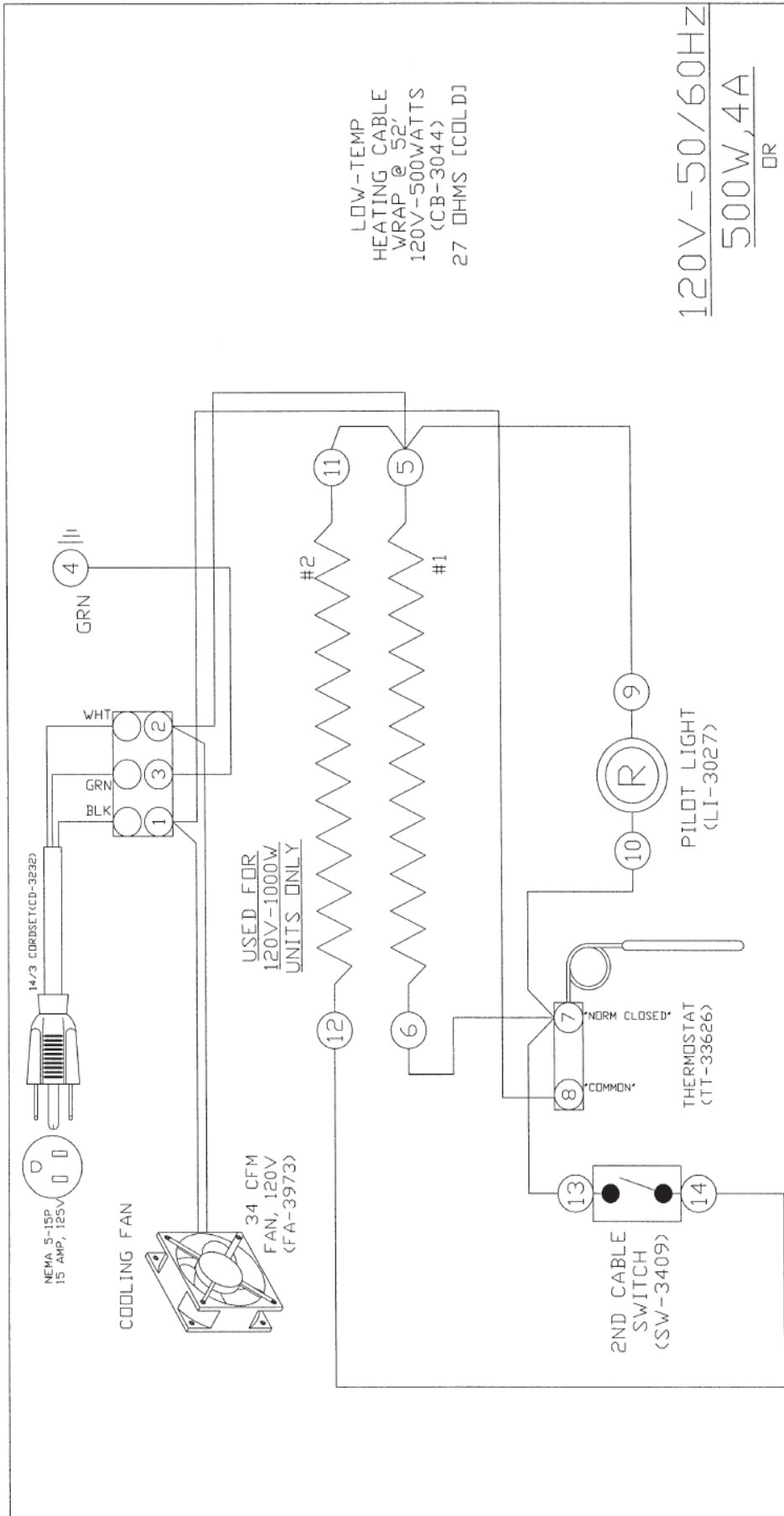

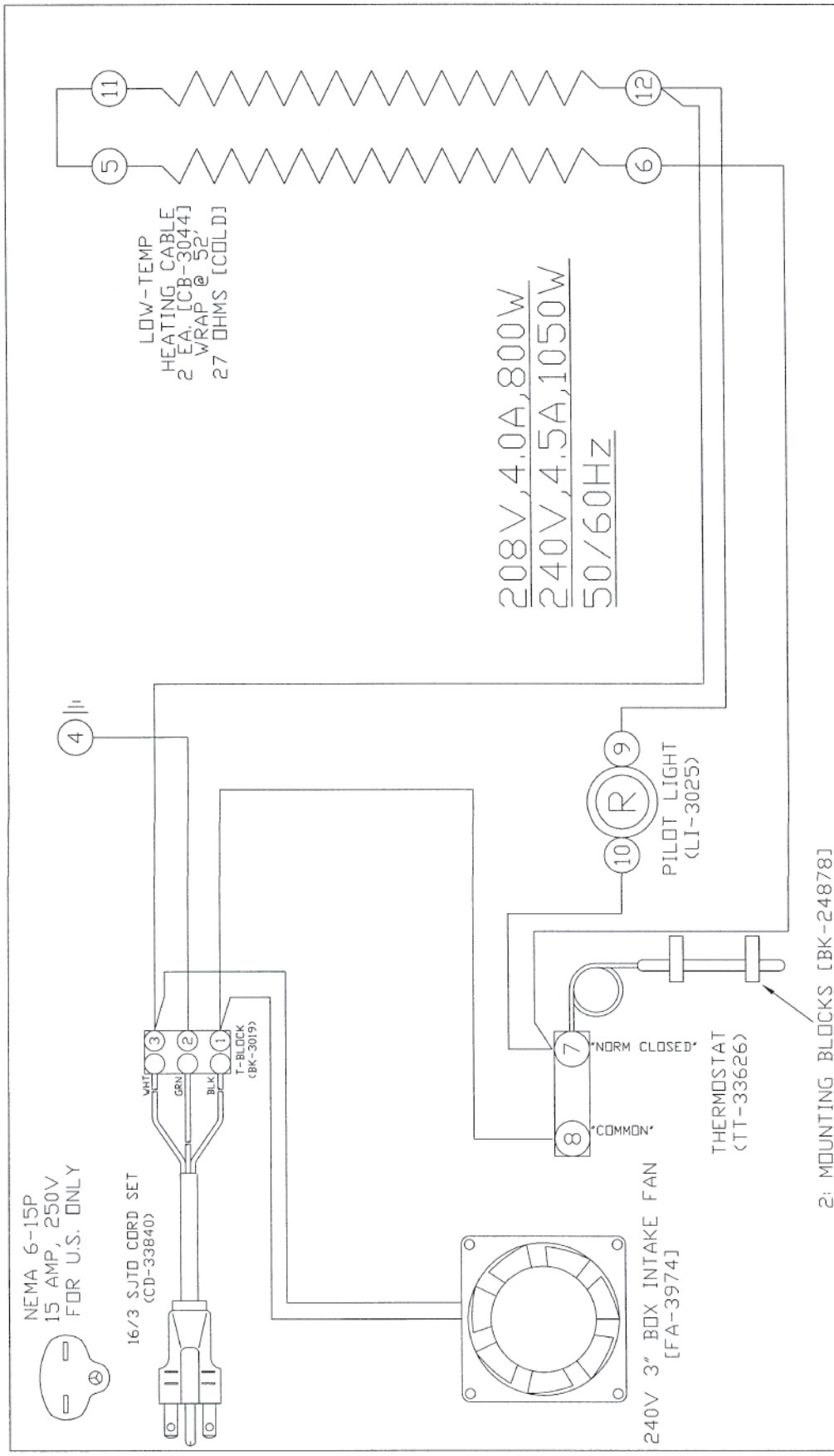

WIRING DIAGRAM

MODELS: 500-1DN,2DN,3DN 208/240V MAN		
ALTO-SHAAM MENDONNEE FALLS, WISC. 53052-450		
BY: MS	SCALE: NONE	DWG: A-7715
APP'D: PED/BES	DATE: 10/05/04	
NO.	REVISION	BY
1	3/13/07	BES

NOTE #1: ALL NUMBERS IN () =
ALTO-SHAAM PART NUMBERS

NOTE #2: SEE DRW. #B-8228 FOR
WIRE ASSEMBLIES

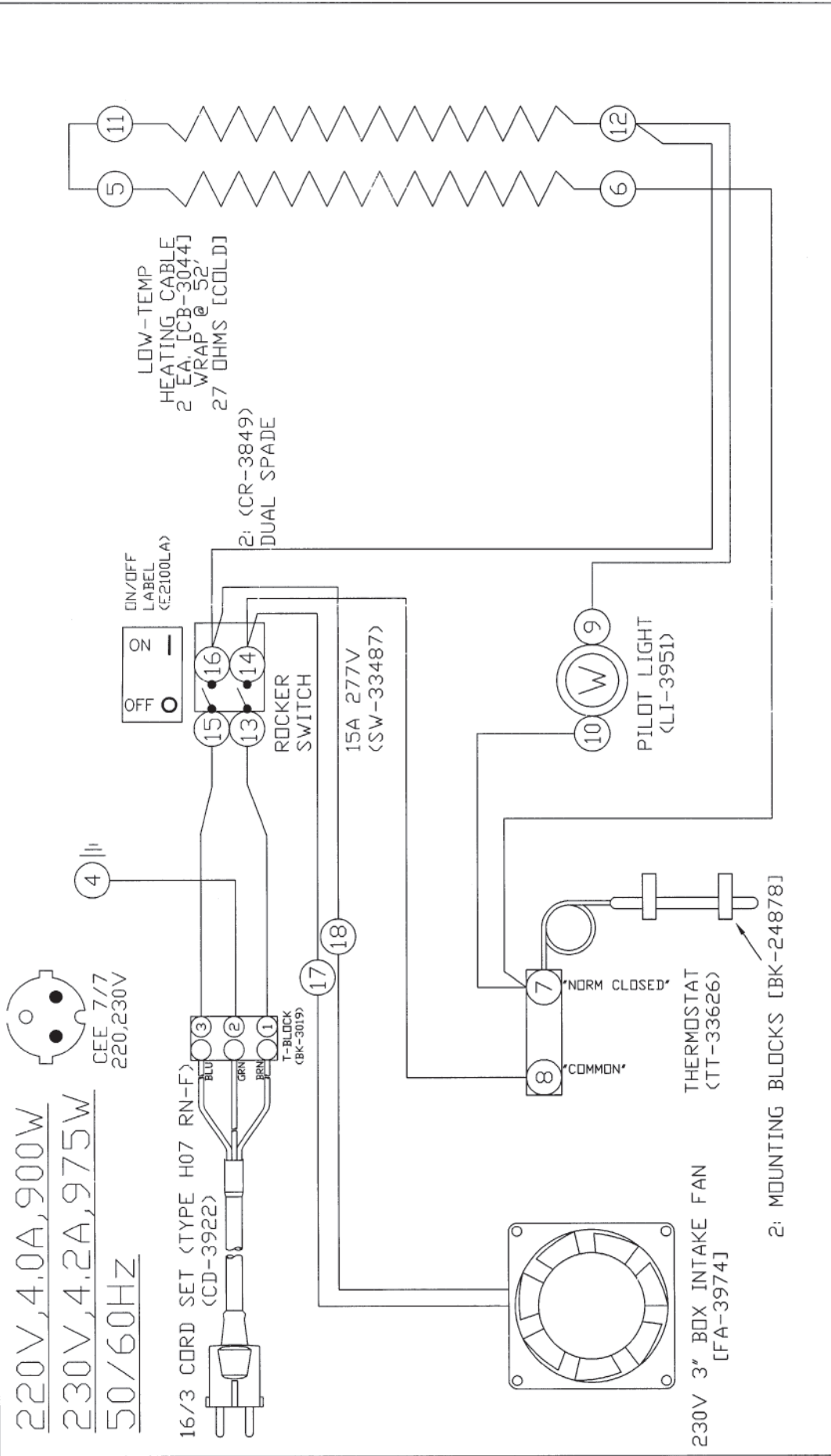

WIRING DIAGRAM

MODELS: 500-1D,2D,3D,1DN,2DN,3DN MAN. 230V [*04]

ALTO-SHAAM®
 MENOMONEE FALLS, WISC. 53052-450

BY: MS SCALE: NONE DWG: 7714
 APP'D: P.E.D DATE: 10/05/04 A-

NO.	REVISION	BY
1	01/12/05	PED

NOTE #1: ALL NUMBERS IN () =
 ALTO-SHAAM PART NUMBERS

NOTE #2: SEE DRW. #B-8227 FOR
 WIRE ASSEMBLIES

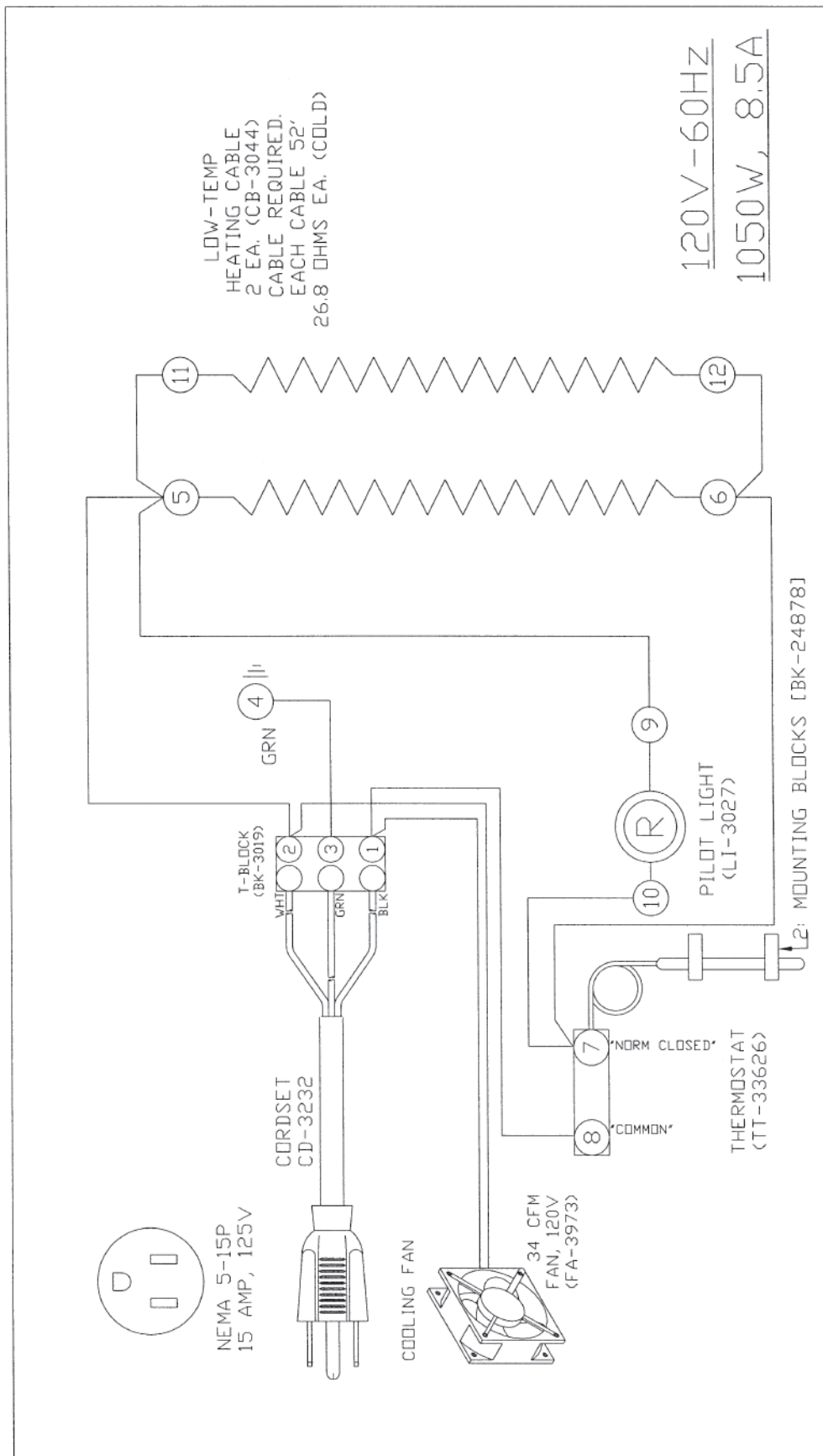

WIRE DIAGRAM

MODELS: 500-3DN 120V MAN.'04

ALTO-SHAAM
MENDONNEE FALLS, WISC. 53052-450

BY: DDF SCALE: NONE DWG: 7718
APP'D: PED DATE: 10/05/04 A-7718

NO.	REVISION	BY
1	3/14/07	BES

NOTE #1: SEE DRW # 8231 FOR WIRE ASSEMBLY.

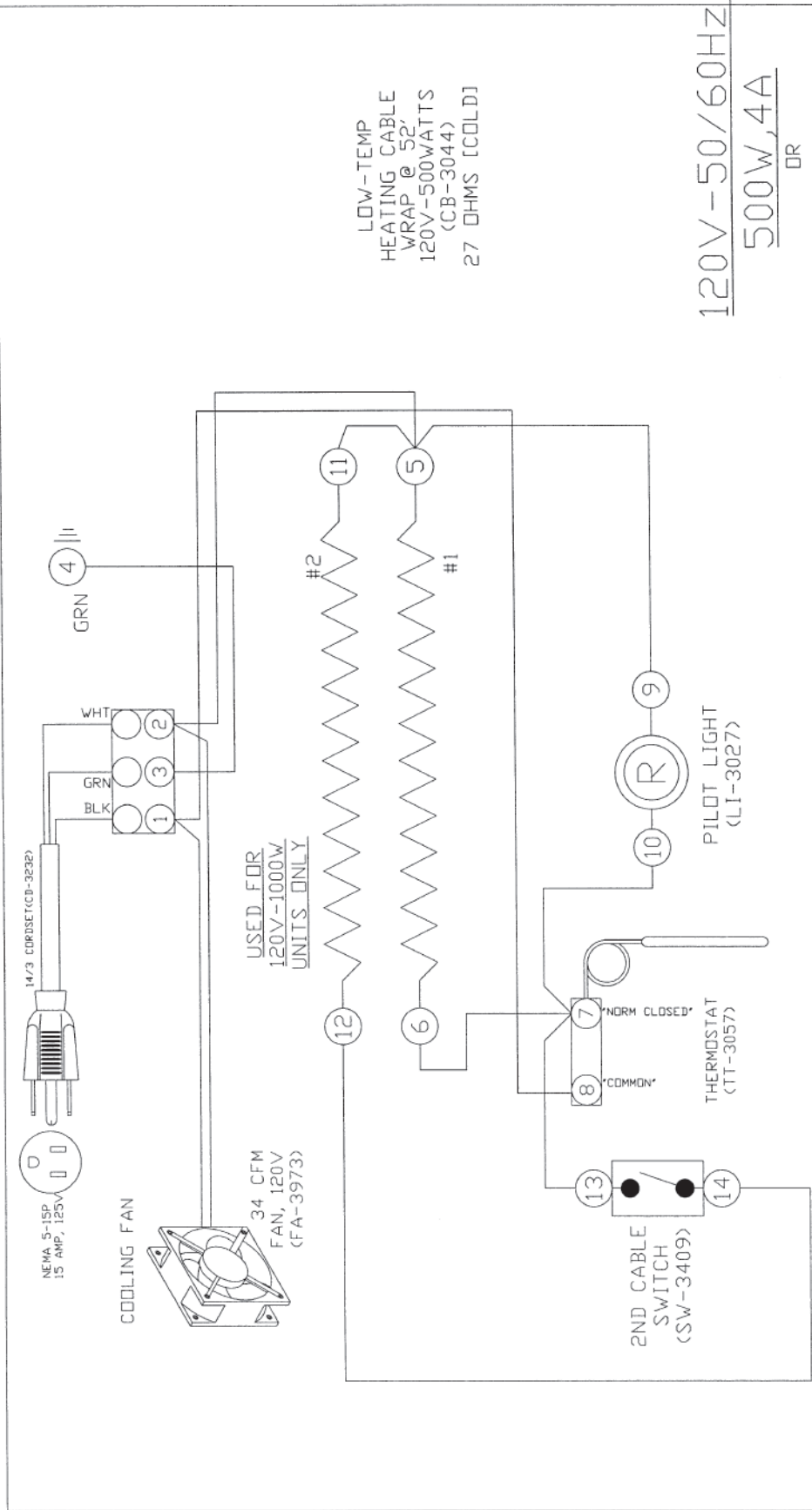

LOW-TEMP
HEATING CABLE
WRAP @ 52"
120V-500WATTS
(CB-3044)
27 OHMS [COLD]

120V-50/60HZ
500W, 4A
OR
1050W, 8.5A

WIRE DIAGRAM

MODELS: 500-1D, 2D MANUAL ('04) 120V

ALTO-SHAAM®

MENOMONEE FALLS, WISC. 53052-450

BY: MS SCALE: NONE DWG: A-7859

APP'D: BCS/PED DATE: 3/14/07

NOTE #1: ALL NUMBERS IN () =
ALTO-SHAAM PART NUMBERS
NOTE #2: SEE DRW. #8226 FOR
WIRE ASSEMBLIES

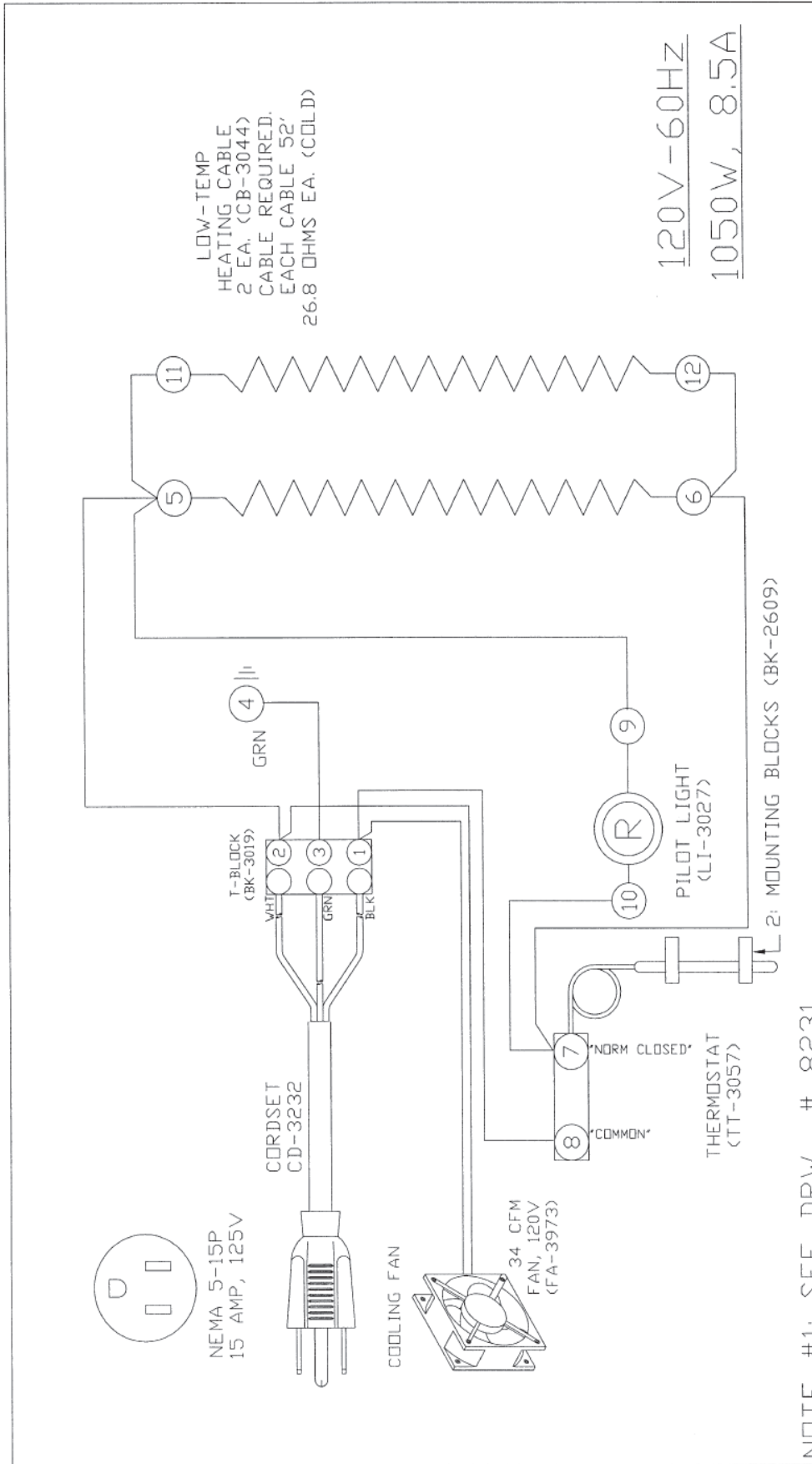

WIRE DIAGRAM

MODELS: 500-3D 120V MAN.'04)

ALTO-SHAAM
MEMPHIS FALLS, WISC. 53052-450

BY: DDF SCALE: NONE DWG: 7860
APP'D: P.E.D DATE: 3/14/07 A-7860

NO.	REVISION	BY
1	3/29/07	BES

NOTE #1: SEE DRW # 8231 FOR WIRE ASSEMBLY.

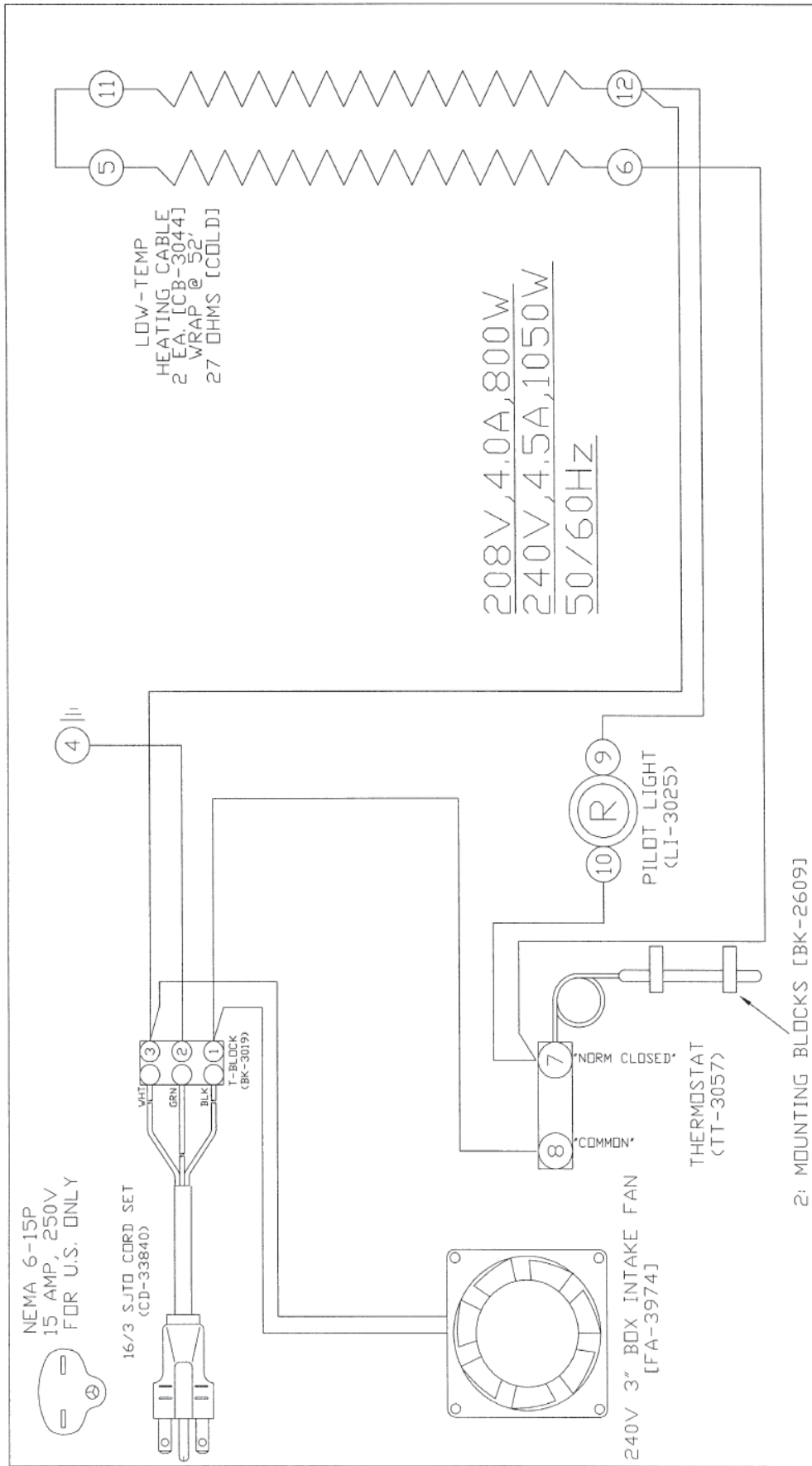

WIRING DIAGRAM

MODELS: 500-1D, 2D, 3D 208/240V MAN

ALTO-SHAAM

MENDOTA FALLS, WISC. 53052-450

BY: MS	SCALE: NONE	DWG: 7861	
APP'D: PED/BES	DATE: 3/14/07	A-	

NO.	REVISION	BY
1	3/29/07	BES

NOTE #1: ALL NUMBERS IN () =
ALTO-SHAAM PART NUMBERS

NOTE #2: SEE DRW. #B-8228 FOR
WIRE ASSEMBLIES

SERIAL COMMUNICATIONS CABLE
(CB-33874)

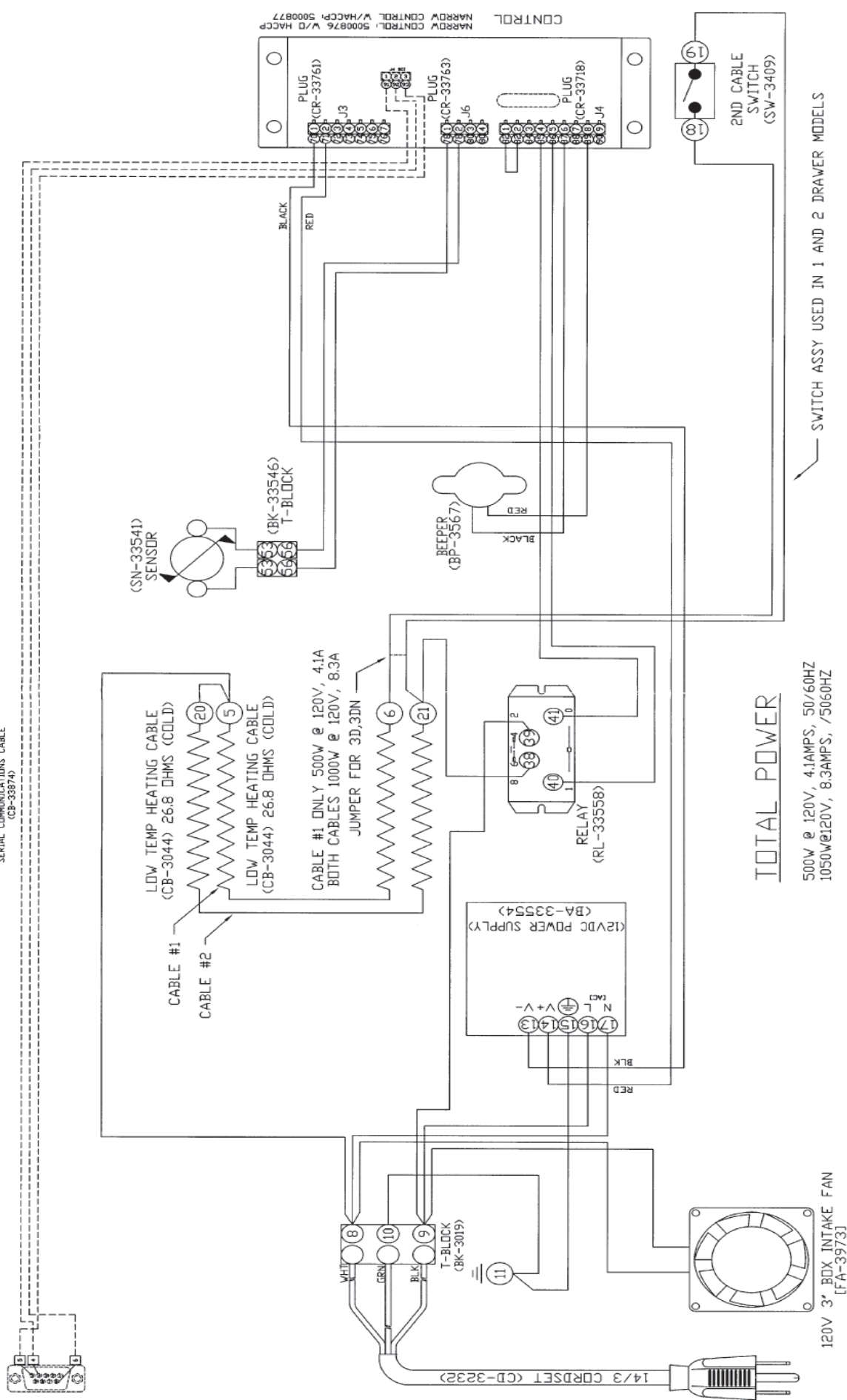

WIRING DIAGRAM		MODELS: 500-1D,2D,3D,1DN,2DN,3DN	ELEC. (120V)
		ALTO-SHAAM® MENOMONEE FALLS, WISC. 53052-450	
BY: M/S	SCALE: NONE	DWG: B-7717	
APP'D: P.E.D	DATE: 10/05/04		

NOTE #1:
ALL NUMBERS IN () =
ALTO-SHAAM PART NUMBERS

NOTE #2:
SEE DRW #A-8230
FOR WIRE ASSEMBLIES

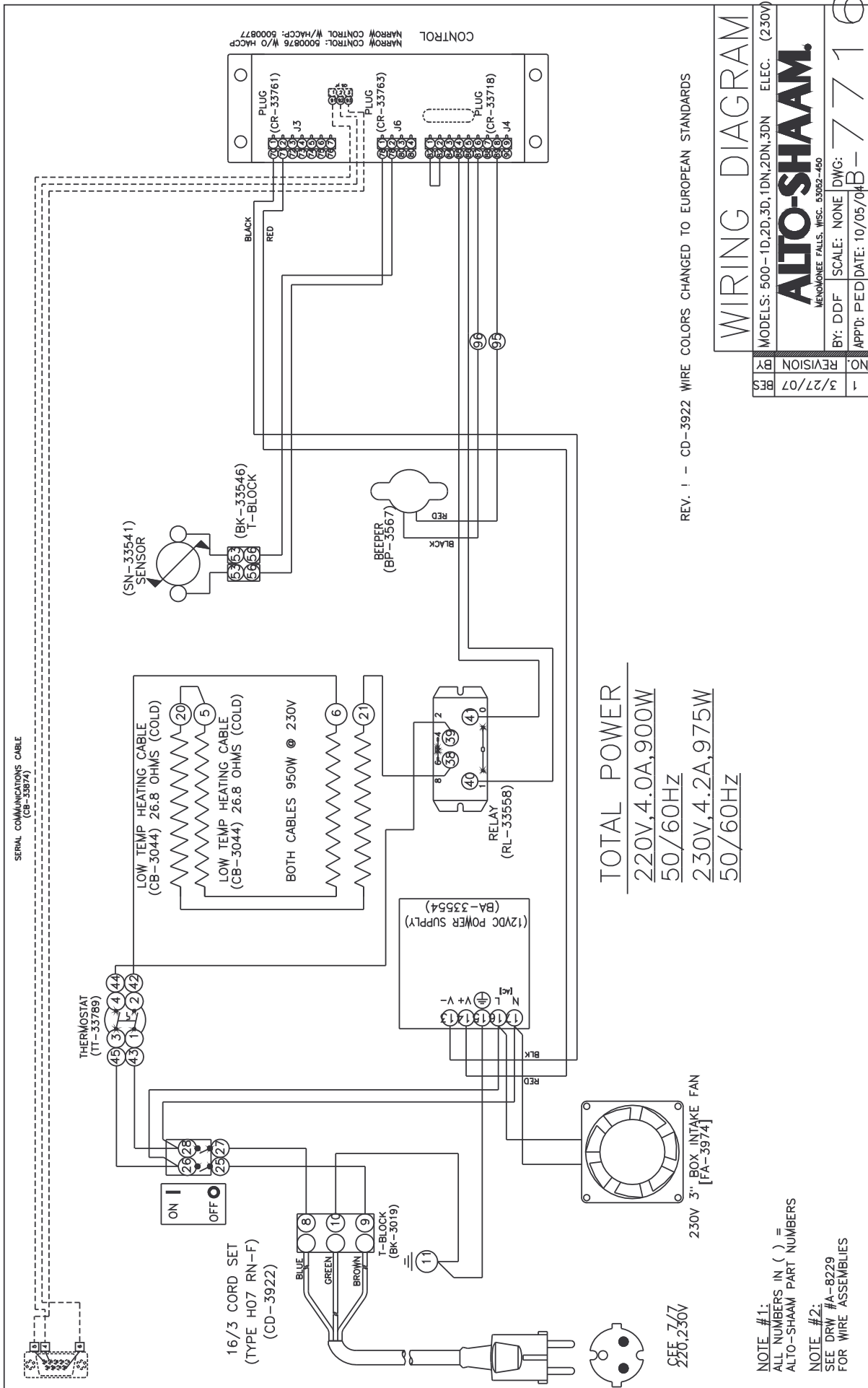

SERIAL COMMUNICATIONS CABLE
(CB-33874)

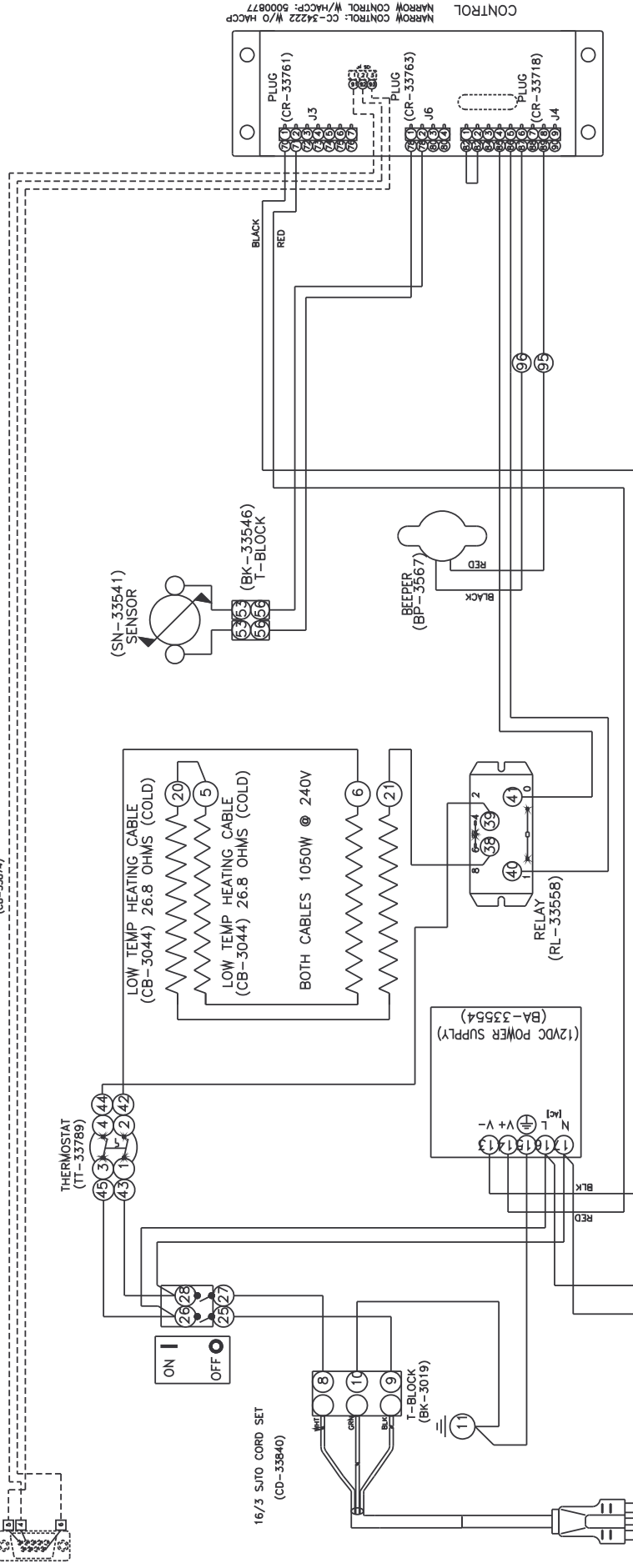

TOTAL POWER
 $\frac{780W @ 208V, 3.75A}{1050W @ 240V, 4.4A}$
50/60HZ

NEMA 6-15P
 15 AMP, 250V
 FOR U.S. ONLY



230V 3" BOX INTAKE FAN
 [FA-3974]

NOTE #1:
 ALL NUMBERS IN () =
 ALTO-SHAAM PART NUMBERS

NOTE #2:
 SEE DRW #A-8229
 FOR WIRE ASSEMBLIES

WIRING DIAGRAM

MODELS: 500-1D, 2D, 3D, 1DN, 2DN, 3DN ELEC.

ALTO-SHAAM

MENOMONEE FALLS, WISC. 53092-460

BY: M B SCALE: NONE DWG: 7866

APP'D: P E D DATE: 5/14/07 B-

CONTROL
 NARROW CONTROL W/HACCP: 5000877
 CC-34222 W/O HACCP

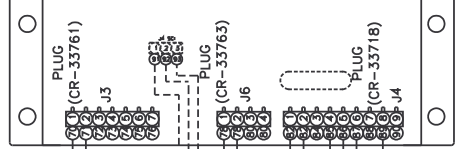

16/3 SJT0 CORD SET
 (CD-33840)

ON OFF

T-BLOCK
 (BK-3019)

(12VDC POWER SUPPLY)
 (BA-3354)

RELAY
 (RL-33558)

BEEPER
 (BP-3567)

T-BLOCK
 (BK-33546)

SENSOR
 (SN-33541)

LOW TEMP HEATING CABLE
 (CB-3044) 26.8 OHMS (COLD)

LOW TEMP HEATING CABLE
 (CB-3044) 26.8 OHMS (COLD)

BOTH CABLES 1050W @ 240V

THERMOSTAT
 (TT-33789)

PLUG (CR-33761)

PLUG (CR-33763)

PLUG (CR-33718)

TRANSPORTATION DAMAGE and CLAIMS

ALTO SHAAM LIMITED WARRANTY



All Alto-Shaam equipment is sold F.O.B. shipping point, and when accepted by the carrier, such shipments become the property of the consignee.

Should damage occur in shipment, it is a matter between the carrier and the consignee. In such cases, the carrier is assumed to be responsible for the safe delivery of the merchandise, unless negligence can be established on the part of the shipper.

1. Make an immediate inspection while the equipment is still in the truck or immediately after it is moved to the receiving area. Do not wait until after the material is moved to a storage area.
2. Do not sign a delivery receipt or a freight bill until you have made a proper count and inspection of all merchandise received.
3. Note all damage to packages directly on the carrier's delivery receipt.
4. Make certain the driver signs this receipt. If he refuses to sign, make a notation of this refusal on the receipt.
5. If the driver refuses to allow inspection, write the following on the delivery receipt:
Driver refuses to allow inspection of containers for visible damage.
6. Telephone the carrier's office immediately upon finding damage, and request an inspection. Mail a written confirmation of the time, date, and the person called.
7. Save any packages and packing material for further inspection by the carrier.
8. Promptly file a written claim with the carrier and attach copies of all supporting paperwork.

We will continue our policy of assisting our customers in collecting claims which have been properly filed and actively pursued. We cannot, however, file any damage claims for you, assume the responsibility of any claims, or accept deductions in payment for such claims.

Alto-Shaam, Inc. warrants to the original purchaser that any original part that is found to be defective in material or workmanship will, at Alto-Shaam's option, subject to provisions hereinafter stated, be replaced with a new or rebuilt part.

The labor warranty remains in effect one (1) year from installation or fifteen (15) months from the shipping date, whichever occurs first. Alto-Shaam will bear normal labor charges performed during standard business hours, and excluding overtime, holiday rates or any additional fees.

The parts warranty remains in effect for one (1) year from installation or fifteen (15) months from the shipping date, whichever occurs first.

However, the heating element on Halo Heat® cook/hold ovens and the refrigeration compressor on Alto-Shaam Quickchillers™ are warranted for a period of five (5) years from installation. The labor warranty is the same as stated above; namely, for one (1) year from installation or fifteen (15) months from the shipping date, whichever occurs first.

THIS WARRANTY DOES NOT APPLY TO:

1. Calibration.
2. Replacement of light bulbs and/or the replacement of display case glass due to damage of any kind.
3. Equipment damage caused by accident, shipping, improper installation or alteration.
4. Equipment used under conditions of abuse, misuse, carelessness or abnormal conditions including, but not limited to, equipment subjected to harsh or inappropriate chemicals including, but not limited to, compounds containing chloride or quaternary salts, poor water quality, or equipment with missing or altered serial numbers.
5. Damage incurred as a direct result of poor water quality, inadequate maintenance of steam generators and/or surfaces affected by water quality. Water quality and required maintenance of steam generating equipment is the responsibility of the owner/operator.
6. Damage caused by use of any cleaning agent other than Alto-Shaam's Combitherm® Cleaner including, but not limited to, damage due to chlorine or other harmful chemicals. Use of Alto-Shaam's Combitherm® Cleaner on Combitherm® ovens is highly recommended.
7. Any losses or damage resulting from malfunction, including loss of product or consequential or incidental damages of any kind.
8. Equipment modified in any manner from original model, substitution of parts other than factory authorized parts, removal of any parts including legs, or addition of any parts.

This warranty is exclusive and is in lieu of all other warranties, expressed or implied, including the implied warranties of merchantability and fitness for a particular purpose. In no event shall Alto-Shaam be liable for loss of use, loss of revenue or profit, or loss of product, or for any indirect or consequential damages. No person except an officer of Alto-Shaam, Inc. is authorized to modify this warranty or to incur on behalf of Alto-Shaam any other obligation or liability in connection with Alto-Shaam equipment.

ALTO-SHAAM, INC.

RECORD THE MODEL AND SERIAL NUMBER OF THE APPLIANCE FOR EASY REFERENCE.
ALWAYS REFER TO BOTH MODEL AND SERIAL NUMBER IN ANY CONTACT WITH ALTO-SHAAM REGARDING THIS APPLIANCE.

Model: _____ Date Installed: _____
Voltage: _____ Purchased From: _____
Serial Number: _____

W164 N9221 Water Street • P.O. Box 450 • Menomonee Falls, Wisconsin 53052-0450 • U.S.A.

PHONE: 262.251.3800 • 800.558-8744 USA/CANADA

FAX: 262.251.7067 • 800.329.8744 U.S.A. ONLY

WEBSITE: www.alto-shaam.com

PRINTED IN U.S.A.