



FLEXNET Power



Technical Manual MPS48-7M

Effective: August 2007

Alpha Technologies

Power

Alpha Technologies



MPS48-7M

Technical Manual

021-511-B4-002, Rev. B

Effective Date: August 2007

Copyright© 2007

Alpha Technologies, Inc.

member of The  Group™

 **NOTE:**

Photographs contained in this manual are for illustrative purposes only. These photographs may not match your installation.

 **NOTE:**

Operator is cautioned to review the drawings and illustrations contained in this manual before proceeding. If there are questions regarding the safe operation of this product, please contact Alpha Technologies or your nearest Alpha representative.

 **NOTE:**

Alpha shall not be held liable for any damage or injury involving its enclosures, power supplies, generators, batteries, or other hardware if used or operated in any manner or subject to any condition not consistent with its intended purpose, or is installed or operated in an unapproved manner, or improperly maintained.

Notice of FCC Compliance

Per FCC 47 CFR 15.21:

Changes or modifications not expressly approved by the party responsible for compliance could void the user's authority to operate the equipment.

Per FCC 47 CFR 15.105:

This equipment has been tested and found to comply with the limits for a Class A digital device, pursuant to part 15 of the FCC Rules. These limits are designed to provide reasonable protection against harmful interference when the equipment is operated in a commercial environment. This equipment generates, uses, and can radiate radio frequency energy and, if not installed and used in accordance with the instruction manual, may cause harmful interference to radio communications.

Contacting Alpha Technologies: www.alpha.com

or

For general product information and customer service (7 AM to 5 PM, Pacific Time), call

1-800-863-3930

For complete technical support, call

1-800-863-3364

*7 AM to 5 PM, Pacific Time or 24/7 emergency support
To report errors in this manual, send email to Techpubs@alpha.com*

Contents

Safety Notes.....	6
1.0 Introduction.....	10
2.0 Theory of Operation.....	11
3.0 Specifications.....	12
4.0 Installation.....	14
4.1 Unpacking the MPS48-7M.....	14
4.2 Enclosure Installation, Wall-mount or Wooden Pole-mount.....	14
4.3 Enclosure Installation, Steel or Concrete Pole.....	16
4.4 AC Input (120/240Vac) Connection Procedure.....	17
4.5 AC Connection with High Voltage Transformer.....	18
4.5.1 Installing the Transformer.....	18
4.5.2 Installing the Streetlight AC Power Tap Cable.....	19
4.6 Network Cable Connection Procedure.....	20
4.7 Battery Connection Procedure.....	21
4.8 Network Connections.....	21
5.0 Operation.....	22
5.1 Start-up.....	22
5.2 Normal Operation.....	22
5.3 Battery Backup Mode.....	23
5.4 Charging Mode.....	23
6.0 Troubleshooting.....	24
6.1 Troubleshooting Table.....	24
6.2 Connecting to the Local Craft Port.....	24
7.0 Maintenance.....	25
7.1 Battery Replacement.....	25
7.2 Replacing the Power Module.....	25
7.3 Battery Management.....	26

List of Figures and Tables

Fig. 1-1, MPS48-7M Overview	10
Fig. 3-1, MPS48-7M Enclosure Dimensions.....	13
Fig. 4-1, AC Connections.....	17
Fig. 4-2, Input Voltage Select Switch.....	17
Fig. 4-3, Streetlight AC Power Tap Cable Stripped.....	19
Fig. 4-4, Streetlight AC Power Tap Cable Installed.....	19
Fig. 4-5, Strain Relief Fitting	20
Fig. 4-6, Customer Connections.....	20
Fig. 5-1, Status LEDs	22
Fig. 5-2, Battery Capacity Versus Temperature.....	23
Fig. 7-1, Battery Capacity Characteristics	26
Table 2-1, Network Connections.....	11
Table 5-1, Status LED Indications	22
Table 5-2, Battery Runtime and Recharge Times.....	23

Safety Notes

Review the drawings and illustrations in this manual before proceeding. If there are any questions regarding the safe installation or operation of this product, contact Alpha Technologies or the nearest Alpha representative. Save this document for future reference.

To reduce the risk of injury or death, and to ensure the continued safe operation of this product, the following symbols have been placed throughout this manual. Where these symbols appear, use extra care and attention.

ATTENTION:

The use of ATTENTION indicates specific regulatory/code requirements that may affect the placement of equipment and /or installation procedures.



NOTE:

A NOTE provide additional information to help complete a specific task or procedure.



CAUTION!

The use of CAUTION indicates safety information intended to PREVENT DAMAGE to material or equipment.



WARNING!

WARNING presents safety information to PREVENT INJURY OR DEATH to the technician or user.

General Safety Precautions

To avoid injury:

- This enclosure and its hardware must only be serviced by authorized personnel.
- The enclosure must remain locked at all times, except when authorized service personnel are present.
- Remove all conductive jewelry or personal equipment prior to servicing equipment, parts, connectors, wiring, or batteries.
- Read and follow all installation, equipment grounding, usage, and service instructions included in this manual.
- Use proper lifting techniques whenever handling enclosure, equipment, parts, or batteries.
- Batteries contain dangerous voltages, currents and corrosive material. Battery installation, maintenance, service and replacement must only be performed by authorized personnel.
- Never use uninsulated tools or other conductive materials when installing, maintaining, servicing or replacing batteries.
- Use special caution when connecting or adjusting battery cabling. An improperly connected battery cable or an unconnected battery cable can result in arcing, fire, or possible explosion.
- Avoid any contact with gelled or liquid emissions from valve-regulated lead-acid (VRLA) batteries. Emissions contain dilute sulfuric acid that is harmful to the skin and eyes. Emissions are electrolytic, and are electrically conductive and are corrosive. Follow the Chemical Hazards notes if contact occurs.
- Do not smoke or introduce sparks in the vicinity of a battery.
- Under certain overcharging conditions, lead-acid batteries can vent a mixture of hydrogen gas that is explosive. Proper venting of the enclosure is required.
- Follow the battery manufacturer's approved transportation and storage instructions.

To avoid damage:

- Prior to installation, verify the AC input voltage and frequency matches the rating of the enclosure and its equipment.
- Prior to installation, verify that the output voltage from the enclosure or its equipment match the voltage requirements of the connected equipment (load).
- Prior to installation, verify that the enclosure's utility service panel is equipped with a properly rated circuit breaker for use with the equipment inside. Refer to manufacturer's recommendations.
- Review and upgrade utility service panel circuit breaker requirements whenever equipment is changed.
- Prior to installation, contact local utilities, building maintenance departments, and cable/piping locator services to ensure that installation does not interfere with existing utility cables or piping.
- Do not exceed the output rating of equipment. Verify load requirements prior and during connection process.
- Prior to handling the batteries, touch a grounded metal object to dissipate any static charge that may have developed in your body.

Battery Safety Notes



WARNING!

Lead-acid batteries contain dangerous voltages, currents, and corrosive material. Battery installation, maintenance, service, and replacement must be performed only by authorized personnel.

Chemical Hazards

Any gelled or liquid emissions from a valve-regulated lead-acid (VRLA) battery contain dilute sulfuric acid, which is harmful to the skin and eyes. Emissions are electrolytic, and are electrically conductive and corrosive.

To avoid injury:

- Servicing and connection of batteries shall be performed by, or under the direct supervision of, personnel knowledgeable of batteries and the required safety precautions.
- Always wear eye protection, rubber gloves, and a protective vest when working near batteries. Remove all metallic objects from hands and neck.
- Batteries can produce explosive gases. Keep all open flames and sparks away from batteries.
- Use tools with insulated handles. Do not rest tools on top of batteries.
- Batteries contain or emit chemicals known to the State of California to cause cancer and birth defects or other reproductive harm. Battery post terminals and related accessories contain lead and lead compounds. Wash hands after handling (California Proposition 65).
- Wear protective clothing (insulated gloves, eye protection, etc.) whenever installing, maintaining, servicing, or replacing batteries.
- If any battery emission contacts the skin, wash immediately and thoroughly with water. Follow your company's approved chemical exposure procedures.
- Neutralize any spilled battery emission with the solution contained in an approved spill kit, or with a solution of one pound Bicarbonate of soda to one gallon of water. Report chemical spill using your company's spill reporting structure and seek medical attention if necessary.
- All battery compartments must have adequate ventilation to prevent an accumulation of potentially dangerous gas.
- Prior to handling the batteries, touch a grounded metal object to dissipate any static charge that may have developed on your body.
- Never use uninsulated tools or other conductive materials when installing, maintaining, servicing or replacing batteries.
- Use special caution when connecting or adjusting battery cabling. An improperly connected battery cable or an unconnected battery cable can make contact with an unintended surface that can result in arcing, fire, or possible explosion.
- A battery showing signs of cracking, leaking, or swelling should be replaced immediately by authorized personnel using a battery of identical type and rating.

Battery Maintenance Guidelines

The battery maintenance instructions listed below are for reference only. Battery manufacturer's instructions for transportation, installation, storage or maintenance take precedence over these instructions.

- Inspect batteries every 6 months for:
Signs of battery cracking, leaking or swelling. The battery should be replaced immediately by authorized personnel using a battery of the identical type and rating.
- Apply battery manufacturer's specified antioxidant compound on all exposed connections.
- Clean up any electrolyte (battery emission) in accordance with all federal, state, and local regulations or codes.
- Always replace batteries with those of an identical type and rating. Never install old or untested batteries.
- All battery compartments must have adequate ventilation to prevent an accumulation of potentially dangerous gas.

Recycling and Disposal Instructions

Spent or damaged batteries are considered environmentally unsafe. Always recycle used batteries or dispose of the batteries in accordance with all federal, state and local regulations.

Electrical Safety

- Lethal voltages are present within the power supply and electrical boxes. Never assume that an electrical connection or conductor is not energized. Check the circuit with a voltmeter with respect to the grounded portion of the enclosure (both AC and DC) prior to any installation or removal procedure.
- Always use the buddy system when working under hazardous conditions.
- A licensed electrician is required to install permanently wired equipment.
- Input voltages can range up to 347Vac. Ensure that utility power is disabled before beginning installation or removal.
- Ensure no liquids or wet clothes contact internal components.
- Hazardous electrically live parts inside this unit are energized from batteries even when the AC input power is disconnected.

Mechanical Safety

- Power supplies can reach extreme temperatures under load.
- Use caution around sheet metal components and sharp edges.

1.0 Introduction

Alpha's FlexNet MPS48-7M multipurpose power supply provides primary and standby power to Wi-Fi radios in wall-mount and pole-mount applications. The MPS48-7M interface module includes connections for radio, Ethernet backhaul, local Craft port, and 48Vdc auxiliary connection.

The MPS48-7M is supported by a full complement of options including batteries, 120Vac or 240Vac battery heater mat, 120Vac line cord, and a step-down transformer for high voltage streetlight applications.

Key Features:

- Rugged 48Vdc indoor or outdoor UPS
- Multi-use mounting bracket for wall-mount and pole-mount applications
- Temperature compensated battery charging for optimum battery life
- Local and remote status monitoring and reporting
- Battery heater provides extended runtimes in cold conditions
- Preconnectorized cables minimize installation time and eliminate errors

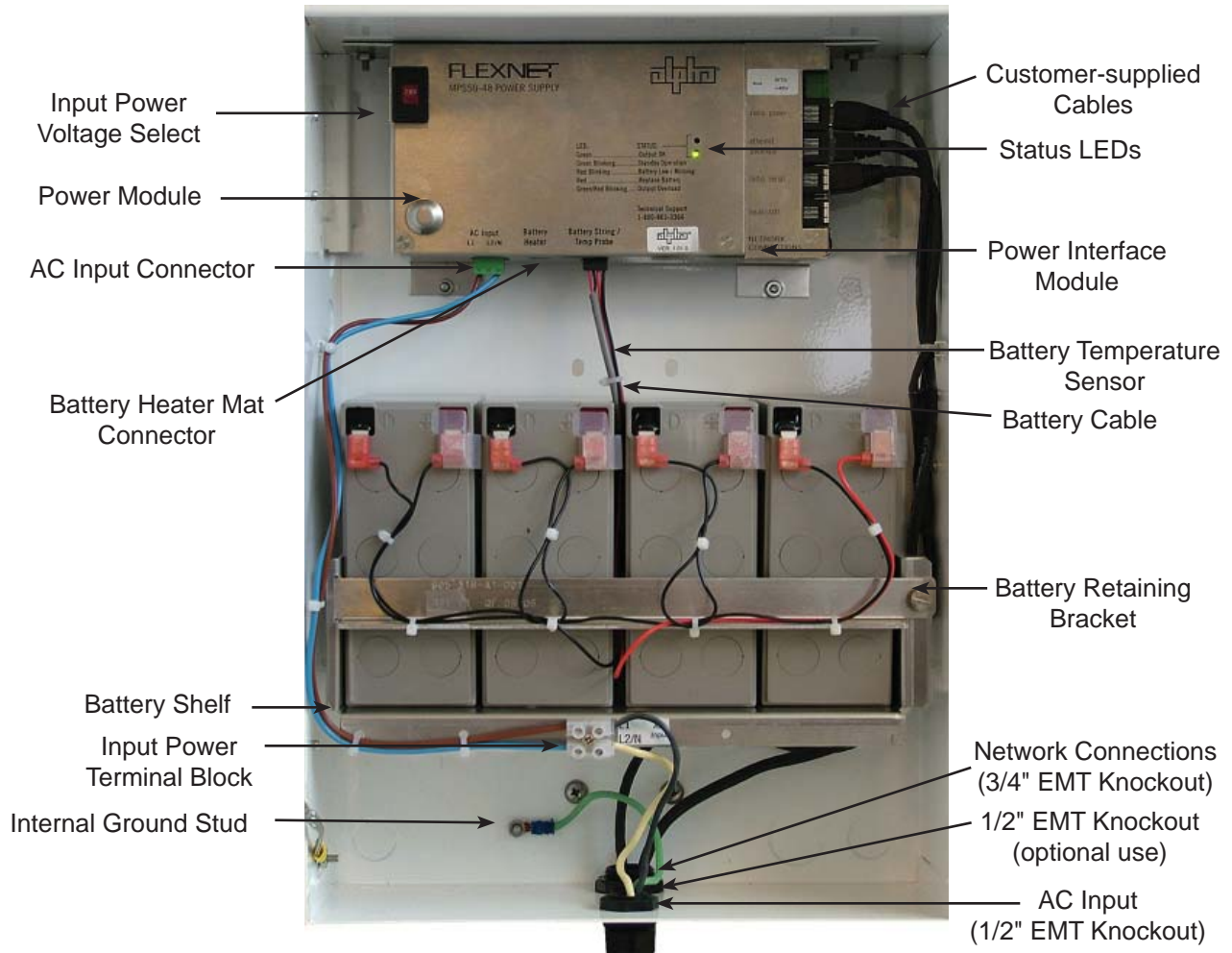

Fig. 1-1, MPS48-7M Overview

2.0 Theory of Operation

The FlexNet MPS48-7M multipurpose power supply provides filtered 50W output power for a typical 48V telecom bus during normal line operation. During line disruptions, the MPS48-7M supplies uninterrupted output power of 50W directly from a string of four 12V batteries.

Metal oxide varistor (MOV) technology provides line voltage surge suppression in the event of line cross or power spikes. An electromagnetic filter conditions line voltage, enabling the power supply to operate in compliance with FCC Class A standards. The AC-to-DC converter feeds power to the primary winding of a high-frequency isolation transformer. The resulting DC output, at the secondary of the transformer, provides power to the load and charges the 48V string batteries, keeping them fully charged in preparation for a line disruption. MPS48-7M battery temperature compensation range is from -0°C to 40°C. A battery heater mat option extends battery life in cold environments. Maximum output voltage of 56Vdc.

The power module provides over-current, over-voltage, and short-circuit protection. After the fault is cleared, the power module automatically resumes power to the load. The control logic circuitry provides a LVD (low battery voltage disconnect), detects the presence (or absence) of batteries, performs periodic battery testing, and communicates status locally with LED status indicators.

Preconnectorized cables of varying lengths provide reliable and efficient field installation. Ethernet, 48Vdc power (with return), and RS232 interface are supported on the preconnectorized cables.

The MPS housing is constructed of weather resistant powder coated aluminum. The enclosure can be pole or wall-mounted.

AC service is routed into the bottom of the enclosure through a 1/2" Electrical Metallic Tubing (EMT) knockout located in the bottom center of the enclosure. The data and power cables are routed through a provided 3-hole strain relief fitting. Additional 1/2" and 3/4" knockouts are provided at the back, bottom, and sides of the enclosure.

The MPS48-7M interface module includes:

- An RJ11/RJ45 pair of connections support a mesh router. The RJ11 includes the RS232 connection to the router. The RJ45 provides an Ethernet connection between the router and 48VDC power (and return).
- An RJ45 for connection to a remote router or modem (Ethernet backhaul).
- An RJ11 Craft Port connection providing an RS232 connection to the mesh router for network management information.
- A 48Vdc terminal block for an auxiliary piece of equipment (e.g. a camera).

Aux	Radio, Power	Ethernet Backhaul	Radio, Serial	Local Craft
Terminal Block	RJ45	RJ45	RJ11	RJ11
Pin	Pin	Pin	Pin	Pin
1 +48Vdc	1 Data Pair 1	1 Data Pair 1	1 NC	1 NC
2 Return	2 Data Pair 1	2 Data Pair 1	2 Radio TX	2 Local RX
	3 Data Pair 2	3 Data Pair 2	3 Return	3 Return
	4 +Vdc	4 NC	4 Radio RX	4 Local TX
	5 +Vdc	5 NC	5 NC	5 NC
	6 Data Pair 2	6 Data Pair 2	6 NC	6 NC
	7 - Vdc	7 NC		
	8 - Vdc	8 NC		



Table 2-1, Network Connections

3.0 Specifications

Input	
Voltage Range (switch selectable)	90-132Vac (low range) or 180-264Vac (high range), 250 to 347Vac with optional step-down transformer
Frequency	47Hz or 63Hz
Surge Protection	ANSI/IEEE Std. C62.41 to Category A, B, or C requirements, using a "Ring Wave" or "Combination" waveform, at a level of 6kV
Output	
Operating Output Power	50W continuous, 70W max (10 seconds)
Output Voltage	42 to 56Vdc
Ripple	<250mVrms
Noise	<2Vp-p
Transfer Characteristics	Uninterrupted output
Battery	
Type	Four sealed 12Vdc valve-regulated lead-acid, maintenance free, immobilized electrolyte (sold separately)
Temperature	Storage: -4°F to 104°F (-20°C to 40°C), Charge: -10°F to 140°F (-23°C to 60°C)*
Capacity	7.2Ah @ 20 hour rate to 1.75Vdc (per cell)**
Weight (lb/kg)	5.95 / 2.7
Dimensions (in/mm)	5.94H x 2.56W x 3.86D / 151H x 65W x 98D
Runtime:	See Table 5-2
LED Indicators	
Output Okay	Green, Solid
Standby Operation	Green, Blinking
Low/Missing Battery	Red, Blinking
Replace Battery	Red, Solid
Overload	Red and Green, Blinking
Mechanical	
Dimensions (in/mm)	17.5H x 12.75W x 5.25D / 445H x 324W x 133D
Weight, without batteries (lb/kg)	11 / 4.9
Environmental	
Operating Temperature (with heater)	-40°F to 131°F (-40°C to 55°C)
Operating Temperature (without heater)	-4°F to 131°F (-20°C to 55°C)
Storage Temperature	-58°F to 158°F (-50°C to 70°C)
Humidity	0 to 95% non condensing
* Length of storage will determine the need for supplemental charge, especially if stored at higher temperatures.	
** Extended exposure to temperatures > 104°F (40°C) may shorten battery life.	
Mounting Configuration	
Wall-mount or pole-mount	
Agency Compliance	
FCC part 15 Class A	
CSA-NRTL\C (UL/CSA 60950-1:2007)	
CE (IEC 60950-1:2001, EN 61204-3:2000-11)	
RoHS compliant, per European Union's Directive 2002/95/EC, Restrictions of Hazardous Substances	
Zone 4, per GR-63 (requires suitable mounting surface)	
NEMA 3R, designed to meet IPX5 Water Intrusion Criteria, per IEC 60529	
Standard Features	
No audible noise	
Reverse battery polarity protection	

3.0 Specifications, continued

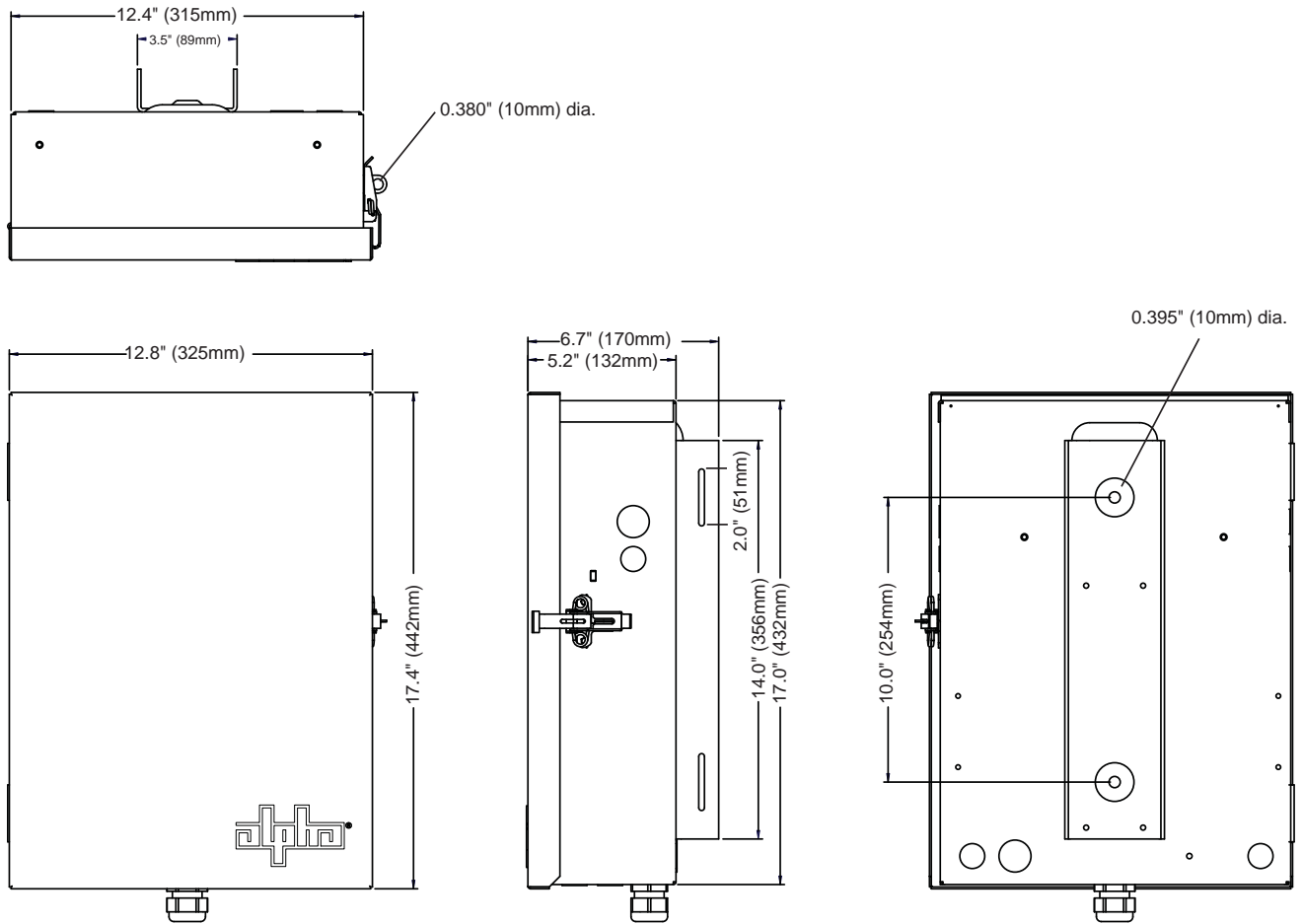

Fig. 3-1, MPS48-7M Enclosure Dimensions

Spare Parts and Options	
Part Number	Product Name
189-078-20	Battery Heater for the MPS48-7M, 240Vac
189-078-21	Battery Heater for the MPS48-7M, 120Vac
745-866-20	Mounting Bracket with Hardware (included)
745-863-20	AC Line Cord, 5-15P, 8'
745-850-22	Transformer Kit, 277Vac Step-Down to 240Vac
243-119-19	Transformer Kit, 347Vac Step-down to 240Vac
875-580-10	Cable, UPS, Streetlight AC PWR Tap Cable, 2-Con w/GND Lug and Wire, 25'
650-264-10	3/4" 3-hole Strain Relief Fitting
650-225-10	1/2" Strain Relief Fitting
181-036-10	7.2Ah AGM Battery with 1-year warranty
181-063-10	7.2Ah AGM Battery with 3-year warranty

4.0 Installation

4.1 Unpacking the MPS48-7M

Remove the mounting bracket and enclosure from the shipping carton. Inspect the MPS48-7M for shipping damage.

Verify each carton contains:

- MPS48-7M enclosure
- Mounting bracket and hardware
- 3/4" 3-hole strain relief fitting
- 1/2" strain relief fitting
- Cable ties
- Quick Start Guide



4.2 Enclosure Installation, Wall-mount or Wooden Pole-mount

Most codes require the base of the enclosure to be located a minimum height from the ground. Always verify height restrictions before installation.

ATTENTION:

Before installing an enclosure, the location and method of mounting must be approved by the property owner.

Recommended Tools and Materials:

- Ratchet with 7/16" socket
- Level
- Phillips screwdriver
- Two user-supplied 1/4" x 2-1/2" (7mm x 60mm) lag bolts with flat washers
- Stud finder (optional)

Installation Procedure:

1. Remove the mounting hardware from the inside of the bracket and position the bracket on a wall or wooden pole capable of supporting 35 lb. (16kg). Use a backing plate if necessary.
2. Level the bracket vertically with the tab facing up.
3. Secure the bracket to the wall or pole using two user-supplied 1/4" x 2-1/2" lag bolts. The hardware must sit flush inside the bracket dimples for proper installation.

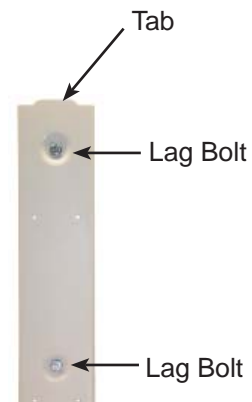

4.0 Installation, continued

4.2 Enclosure Installation, Wall-mount or Wooden Pole Mount, continued

4. Hang the enclosure on the bracket.

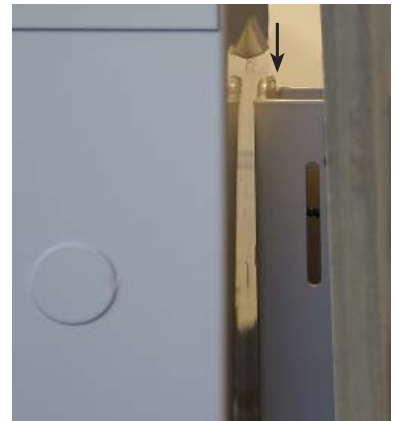

5. Secure the enclosure to the bracket using the four self-tapping screws with washers (supplied). Proceed to Section 4.4.



4.0 Installation, continued

4.3 Enclosure Installation, Steel or Concrete Pole

To mount the MPS48-7M on concrete or steel poles, two user-supplied mounting straps are required (straps must be stainless, galvanized, or equivalent). Most codes require the base of the enclosure to be located a minimum height from the ground. Always verify height restrictions before installation.

ATTENTION:

Before installing an enclosure, the location and method of mounting must be approved by the property owner.

Required Tools and Materials:

- #2 Phillips screwdriver
- Two user-supplied pole straps to fit pole (straps must be stainless, galvanized or equivalent)

Installation Procedure:

1. Position the bracket at the appropriate height with the tab facing up. Secure it to the pole using the pole straps.

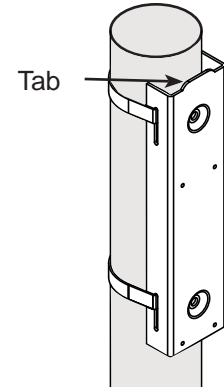

2. Hang the enclosure on the bracket.



3. Secure the enclosure to the bracket using the four self-tapping screws with washers (supplied).

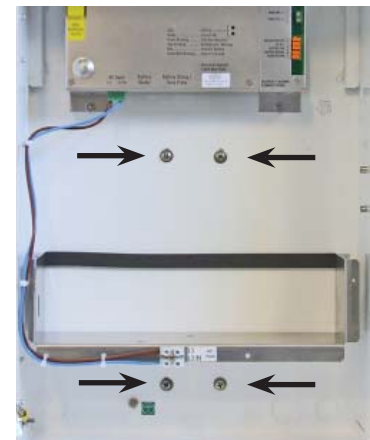

4.0 Installation, continued

4.4 AC Input (120/240Vac) Connection Procedure

Required Tools and Materials:

- Hammer with punch or screwdriver
- 1" Open-end wrench
- Channellock pliers
- 11/32" (9mm) torque wrench or nut driver
- #1 flathead torque screwdriver

ATTENTION:

The user or installer must provide an accessible system disconnect device located near the power supply enclosure as required by local electrical codes, and an over-current protection device with a maximum rating of 20A, or as required by local electrical codes.

1. Verify utility power is OFF. Tag and lock utility power switch.
2. Remove the 1/2" EMT knockout (7/8" dia.) and the 3/4" EMT knockout (1 1/8" dia.), located in the center bottom of the enclosure. For alternate installation, remove knockouts from the right side, left side, or back left of the enclosure as needed.
3. Install the provided 1/2" strain relief fitting, or user-supplied 1/2" Electrical Metallic Tubing (EMT), in the front 1/2" knockout. Route the line cord, or #18AWG wire for line, neutral, and ground, between the enclosure and utility power connection. When installing the strain relief fitting, run the line cord or AC wiring through the outer nut before installing the rest of the fitting. See Fig. 4-1.
4. **For 120V applications:** connect the line and neutral wires to the AC input block. Torque to 4.5 in-lbs (.5 N m).
For 240V applications: connect L1 and L2 wires to the AC input block. Torque to 4.5 in-lbs (.5 N m).
5. Connect the ground wire (green) to the #10 ground stud. Torque to 36 in-lbs (4.1 N m).
6. Tighten the strain relief fitting using Channellock pliers and a 1" wrench.
7. For 120V applications, remove the protective label on the input voltage select switch, and move the switch to the 120V position. See Fig. 4-2.

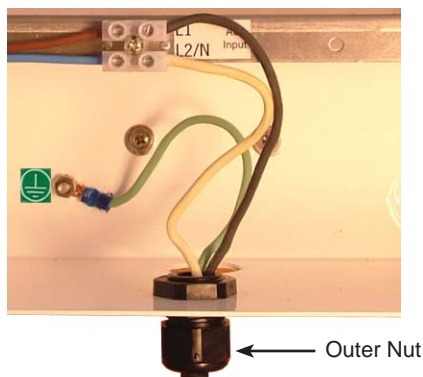
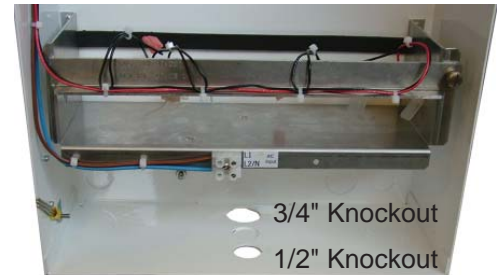

Fig. 4-1, AC Connections



Fig. 4-2, Input Voltage Select Switch

4.0 Installation, continued

4.5 AC Connection with High Voltage Transformer

The transformer converts high voltage to 240Vac. The transformer is required for powering the MPS48-7M from high voltage light pole applications. Use the following connection procedures for installing the transformer kit.

Required Tools and Materials:

- #2 Phillips screwdriver
- #1 flathead screwdriver (torque drive)
- Diagonal cutters



Never apply high voltage to a unit without using a step-down transformer. Applying high voltage to the unit without the transformer will damage the unit and void the warranty.

4.5.1 Installing the Transformer

1. Verify power is OFF at utility. Tag and lock utility power switch.
2. Cut the plastic ties securing standard AC input wire kit that connects the AC input block to the AC input connector on the power module. Remove the standard wire kit.
3. Locate the two countersunk holes located on the battery shelf. Mount the transformer onto the shelf using the supplied flathead screws (2) and Keps nuts (2).
4. Connect the short red wire from the transformer to the L1 terminal on the AC input block. Torque to 4.5 in-lbs (.5 N m).
5. Connect the short white wire from the transformer to the L2 terminal on the AC input block. Torque to 4.5 in-lbs (.5 N m).
6. Connect the green 3-pin connector from the transformer to the AC input connector on the power module.
7. Secure the new wiring with cable ties.

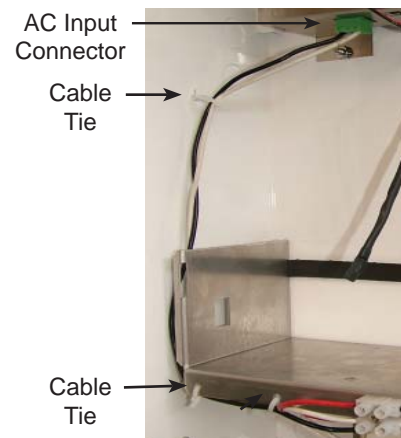
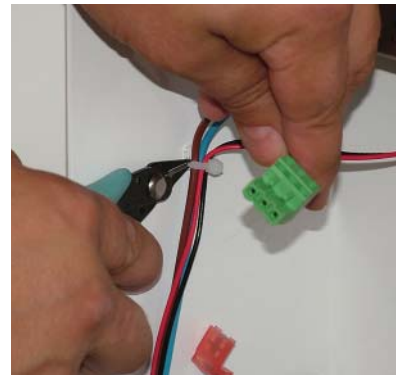

4.0 Installation, continued

4.5 AC Connection with High Voltage Transformer, continued

4.5.2 Installing the Streetlight AC Power Tap Cable

1. Remove the 1/2" EMT knockout (7/8" dia.) and the 3/4" EMT knockout (1 1/8" dia.), located in the center bottom of the enclosure. For alternate installation, remove knockouts from the right side, left side or back left of the enclosure as needed.
2. Install the provided 1/2" strain relief fitting in the 1/2" knockout. Route the Streetlight AC Power Tap Cable and separate 12AWG safety ground wire between the enclosure and utility power connection. Connect the terminal end of the safety ground.
3. Remove two inches of the outer insulation from the Streetlight AC Power Tap Cable, and strip the white and black wires 1/4". See Fig. 4-3.
4. Connect the black wire to the L1 terminal on the AC input block. See Fig. 4-4.
5. Connect the white wire to the L2/N terminal on the AC input block.
6. Connect a safety ground using a #10 ring lug (for #18AWG wire) to the #10 ground stud located on the back wall of the enclosure. Torque to 36 in-lbs (4.1 N m).

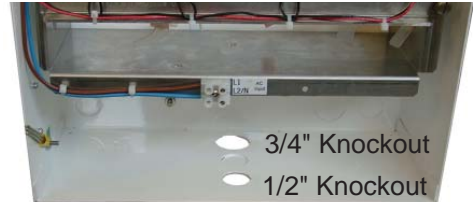

Do not connect AC power at this time; continue to Section 4.6.

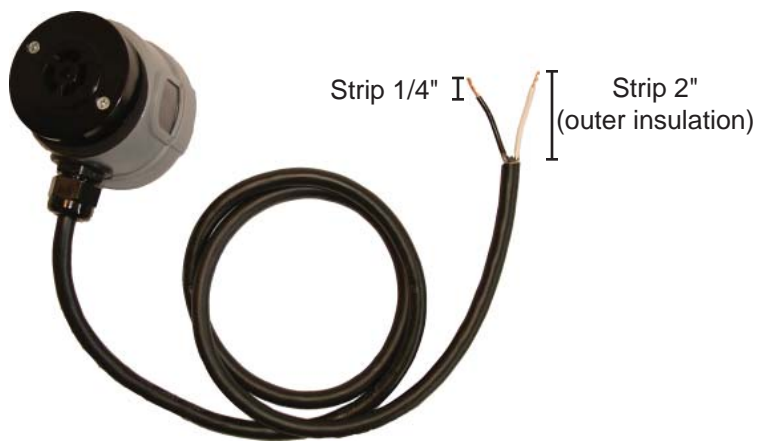

Fig. 4-3, Streetlight AC Power Tap Cable Stripped



Fig. 4-4, Streetlight AC Power Tap Cable Installed

4.0 Installation, continued

4.6 Network Cable Connection Procedure

Required Tools and Materials:

Channellock pliers



Network Cable
(optional)

1. Remove the white seal from the 3-hole strain relief fitting, and install the base of the fitting into the 3/4" knockout. Secure the top inside nut.
2. Route the customer-supplied connection cables into the enclosure through the outer nut and base.
3. Route the Ethernet cable and auxiliary wiring (if applicable) from inside the enclosure, down through the 3-hole strain relief fitting.
4. Insert the cables into the splits in the seal, leaving about 20" for routing into the enclosure. The seal is split in three places to accommodate the cabling. See Fig. 4-5.
5. Replace the seal into the base.
6. Secure the outer nut.
7. Make connections to the RADIO, POWER and RADIO, SERIAL connectors. Connect Ethernet cable to the ETHERNET BACKHAUL connector. Connect auxiliary equipment to AUX connector (if applicable). See Fig. 4-6.
8. Plug any unused ports in the seal (use a short section of wire, or other available material).
9. Proceed to battery connection procedure. Do Not connect AC power at this time.

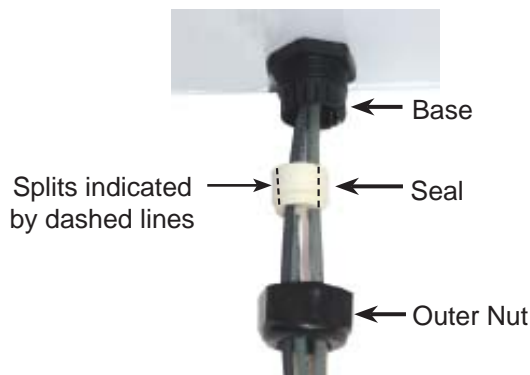

Fig. 4-5, 3-hole Strain Relief Fitting



Fig. 4-6, Network Connections

4.0 Installation, continued

4.7 Battery Connection Procedure

Required Tools and Materials:

- #2 flathead screwdriver
- Electrical tape

1. Loosen the retaining screw on the battery retaining bracket and move the bracket clear of the battery shelf.
2. If using the battery heater mat option, verify the input voltage printed on the battery heater mat label corresponds to the selected input voltage (default 240V). Place the battery heater mat on the shelf. Connect the 3-pin connector to the Battery Heater connection on the power module.



CAUTION!

Connecting 240Vac to a battery heater mat rated 120Vac will damage the heater mat.

3. Place two 7.2Ah batteries on the battery shelf and tape the battery temperature sensor to the side of the second battery. Place the remaining two batteries on the battery shelf.
4. Replace the battery retaining bracket and secure.
5. Connect the batteries, leaving the far left negative terminal unconnected. The positive battery connections are fitted with a safety tab to prevent misconnection.



Tape Sensor to Battery

Leave Disconnected

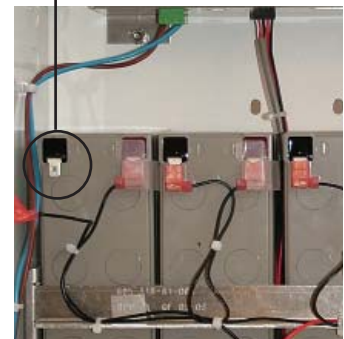

4.8 Network Connections

Make network connections and complete any other connections on the customer and service AC side at this time. When all connections are verified proceed to Section 5.0, Operation.

5.0 Operation

5.1 Start-up

1. Verify the input voltage select switch on the power module is set for the correct input voltage. The factory default setting is 240Vac.



CAUTION!

Incorrect voltage selection can damage the unit and void the warranty. Verify the input voltage select switch matches applied AC input power. Never apply 240Vac to a unit with the input voltage select switch in the 120Vac position.

2. Verify customer-end connections and apply AC power to the unit.
3. Connect the battery terminal left unplugged in Section 4.7.

5.2 Normal Operation

The green status LED will be ON solid after the battery connection is made. If any other indication is present, see Section 6.0 for troubleshooting. Operating status of the MPS48-7M is indicated by two status LEDs located on the power module. Refer to Table 5-1 to determine operational status and possible faults.

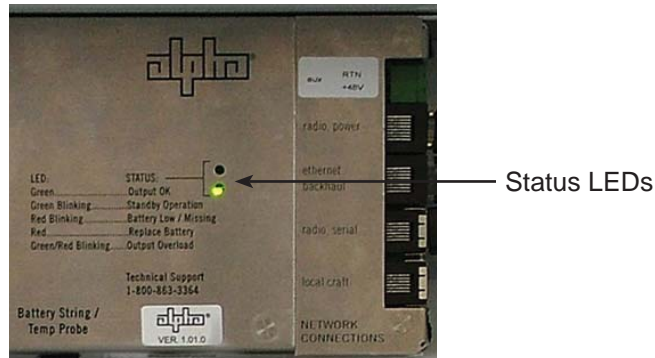

Fig. 5-1, Status LEDs

LED Color	State	Indication
Green	Solid	Output OK
Green	Blinking	Standby Operation
Red	Blinking	Battery Low/Missing
Red	Solid	Replace Battery
Red & Green	Blinking	Overload

Table 5-1, Status LED Indications



NOTE:

When an Overload alarm and Battery Low/Missing alarm are present simultaneously, the Overload alarm will take precedence.

5.0 Operation

5.3 Battery Backup Mode

In the event of an AC power outage, the MPS48-7M switches to battery backup mode to power the load. The green status LED begins to blink, indicating the load is being powered from the battery string. The MPS48-7M runs in battery backup mode until AC power is restored, or until the battery string reach a low-voltage shutdown level of 42V. On resumption of AC power, the MPS48-7M recharges the batteries at a maximum current of 1.8A.

5.4 Charging Mode

Under normal conditions, a float charge maintains the batteries at 100% capacity. In the event of line failure, battery charging resumes automatically when primary power is restored. Charging continues until one of the following occurs:

- Battery has reached 100% of capacity.
- Another power failure occurs requiring battery support. Charging ceases until primary power is restored.
- Additional power is required by the load, in which case power is diverted from the battery charger and sent to the load. When demand for additional power ceases, normal battery charging resumes.

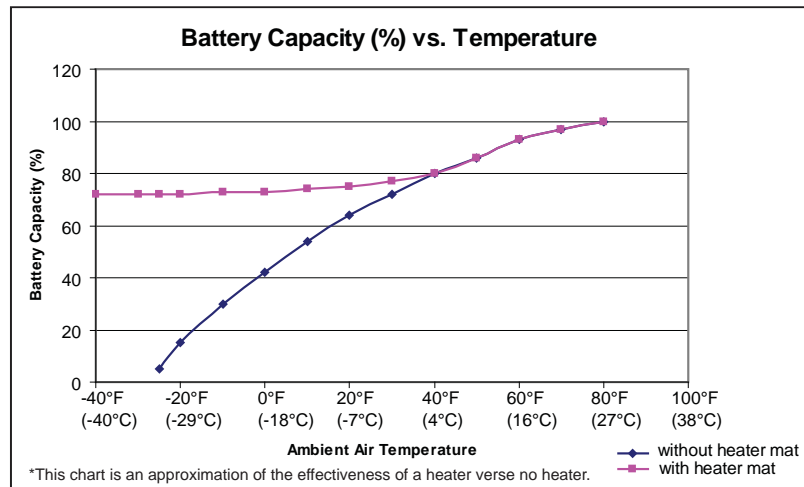

Fig. 5-2, Battery Capacity Versus Temperature

Runtime (hours) vs Temperature					Typical Recharge time vs Load
Load	-40°C	0°C	25°C	40°C	
20Watts	12.5	13.4	16.0	20	13 hr
40Watts	6.0	6.3	7.6	10	25 hr
50Watts	3.3	4.1	5.7	7.2	50 hr

Table 5-2, Battery Runtime and Recharge Times

6.0 Troubleshooting

6.1 Troubleshooting Table

Troubleshooting Table	
Fault	Corrective Action
Green LED is blinking after initial startup	Verify AC power is ON. Check voltage at AC input block. Check AC input connector on power module.
Red LED is ON solid	Replace batteries.
Red LED is blinking	If no batteries are missing, check battery connections. Check battery string connector on power module.
Both red and green LEDs are blinking	Possible overload condition. Verify load does not exceed rated capacity of power supply.
Low battery runtime in cold weather	Verify the battery heater mat is warming. Use compressed air to lower temperature. Heater should come on at 32°F (0°C). Check battery heater mat connection. If battery heater mat fails to come on, replace it.
Battery heater mat does not heat	Verify the ambient temperature is below 32°F. Verify the voltage input rating on the battery heater mat matches the input voltage select switch. Units set to 120V will not heat battery heater mats rated for 240V. Units set to 240V will damage battery heater mats rated for 120V input.
Power module fails to come on after applying 240V with the voltage select switch set for 120V	Check the input voltage select switch. The power module can be damaged by applying 240Vac to the unit when the input voltage select switch is set to 120Vac. If the power module fails to function after this fault, it must be replaced.
No power to the customer connections (radio)	Verify the Radio and Power connector are properly connected.

6.2 Connecting to the Local Craft Port

Connect to the local Craft port using a laptop computer to view alarms sent to the radio from the MPS48-7M. The MPS48-7M sends data to the radio once every three minutes under normal conditions, and once every 30 seconds under alarm conditions. The table below lists the reported alarms. Refer to the radio manufacturer's documentation for interface protocols and necessary equipment. The serial communications protocol is available from Alpha Technologies.

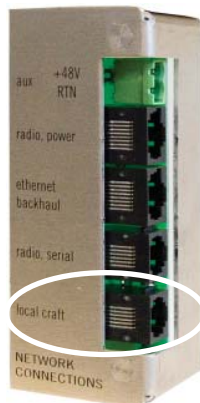

Alarms
Input Voltage
Output Voltage
Output Power
Battery Voltage
Battery Temperature
Battery Current
Remaining Battery Capacity

7.0 Maintenance

7.1 Battery Replacement

The MPS48-7M batteries are hot-swappable. There is no need to power down the unit when replacing the batteries.

Required Tools and Materials:

#2 flathead screwdriver

1. Unplug the battery connections.
2. Loosen the retaining screw on the battery retaining bracket and move the bracket clear of the battery shelf.
3. Remove the batteries in need of replacement.
4. Replace with 7.2Ah batteries. Re-tape the battery temperature sensor to the side of the second battery if necessary.
5. Secure the battery retaining bracket.
6. Connect the batteries; the positive battery connections are fitted with a safety tab to prevent misconnection.

7.2 Replacing the Power Module

Required Tools and Materials:

11/32" (9mm) wrench or socket

1. Verify utility power is OFF. Tag and lock utility power switch.
2. Disconnect all connections to the power module.
3. Loosen the four Keps nuts securing the power module to the enclosure. There is no need to remove them completely.
4. Slide the top of the power module forward and remove the power module.
5. Install a new power module and secure the four Keps nuts.
6. Reconnect all connections.
7. Restore AC power and verify the status LEDs do not indicate a fault. If any other indication is present see to Section 6.0 for troubleshooting tips.



Keps Nuts

Keps Nuts

7.0 Maintenance, continued

7.3 Battery Management

Batteries have limited shelf life and must be put into service in a timely manner. The chart below provides general storage guidelines and illustrates the relationship between capacity retention and storage temperature over time. Consult battery documentation for product specific information.

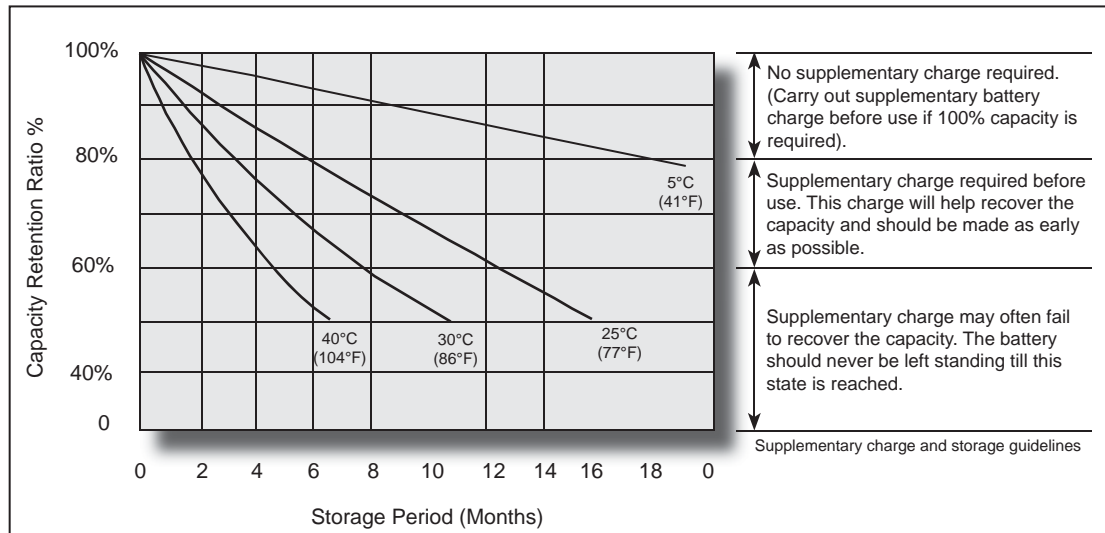
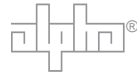

Fig. 7-1, Battery Capacity Characteristics

Power

Alpha Technologies



Alpha Technologies
3767 Alpha Way
Bellingham, WA 98226
USA
Tel: +1 360 647 2360
Fax: +1 360 671 4936
Web: www.alpha.com

Alpha Technologies Ltd.
4084 McConnell Court
Burnaby, BC, V5A 3N7
CANADA
Tel: +1 604 430 1476
Fax: +1 604 430 8908

Alpha Technologies
Europe Ltd.
Twyford House
Thorley
Bishop's Stortford
Hertfordshire
CM22 7PA
UNITED KINGDOM
Tel: +44 0 1279 501110
Fax: +44 0 1279 659870

Alpha Technologies GmbH
Hansastrasse 8
D 91126 Schwabach
GERMANY
Tel: +49 9122 79889 0
Fax: +49 9122 79889 21

Alphatec, Ltd
P.O. Box 56468
Limassol, Cyprus
CYPRUS
Tel: +357 25 375675
Fax: +357 25 359595

AlphaTEK ooo
Khokhlovskiy Pereulok 16
Stroenie 1, Office 403
109028 Moscow
RUSSIA
Tel: +7 495 916 1854
Fax: +7 495 916 1349

Alphatec Baltics
S. Konarskio G. 48
2009 Vilnius
LITHUANIA
Tel: +370 5 213 8822
Fax: +370 5 213 7799

Alpha Technologies
9, Impasse Sans Souci
92140 Clamart France
FRANCE
Tel: +33 141 900 707
Fax: +33 141 909 312