

bedi GDB

JTAG interface for GNU Debugger

ARM11 / Cortex-A8



User Manual

Manual Version 1.04 for BDI2000



©1997-2007 by Abatron AG

1 Introduction	4
1.1 BDI2000.....	4
1.2 BDI Configuration	5
2 Installation	6
2.1 Connecting the BDI2000 to Target.....	6
2.1.1 Changing Target Processor Type	8
2.1.2 Adaptive Clocking.....	9
2.2 Connecting the BDI2000 to Power Supply.....	11
2.2.1 External Power Supply	11
2.2.2 Power Supply from Target System	12
2.3 Status LED «MODE»	13
2.4 Connecting the BDI2000 to Host.....	14
2.4.1 Serial line communication	14
2.4.2 Ethernet communication	15
2.5 Installation of the Configuration Software	16
2.5.1 Configuration with a Linux / Unix host.....	17
2.5.2 Configuration with a Windows host	19
2.5.3 Recover procedure.....	20
2.6 Testing the BDI2000 to host connection	21
2.7 TFTP server for Windows NT.....	21
3 Using bdiGDB.....	22
3.1 Principle of operation	22
3.2 Configuration File	23
3.2.1 Part [INIT].....	24
3.2.2 Part [TARGET]	27
3.2.3 Part [HOST].....	32
3.2.4 Part [FLASH]	34
3.2.5 Part [REGS]	38
3.3 Debugging with GDB	40
3.3.1 Target setup.....	40
3.3.2 Connecting to the target.....	40
3.3.3 Breakpoint Handling.....	41
3.3.4 GDB monitor command.....	41
3.3.5 Target serial I/O via BDI	42
3.3.6 Target DCC I/O via BDI	43
3.4 Telnet Interface	44
3.4.1 Command list	45
3.4.2 CPxx Registers	46
3.5 Multi-Core Support	47
4 Specifications	48
5 Environmental notice	49
6 Declaration of Conformity (CE).....	49
7 Warranty	50

7 Appendices

A Troubleshooting	51
B Maintenance	52
C Trademarks	54

1 Introduction

bdiGDB enhances the GNU debugger (GDB), with JTAG debugging for ARM11 and Cortex-A8 based targets. With the builtin Ethernet interface you get a very fast download speed of up to 200 Kbytes/sec. No target communication channel (e.g. serial line) is wasted for debugging purposes. Even better, you can use fast Ethernet debugging with target systems without network capability. The host to BDI communication uses the standard GDB remote protocol.

An additional Telnet interface is available for special debug tasks (e.g. force a hardware reset, program flash memory).

The following figure shows how the BDI2000 interface is connected between the host and the target:

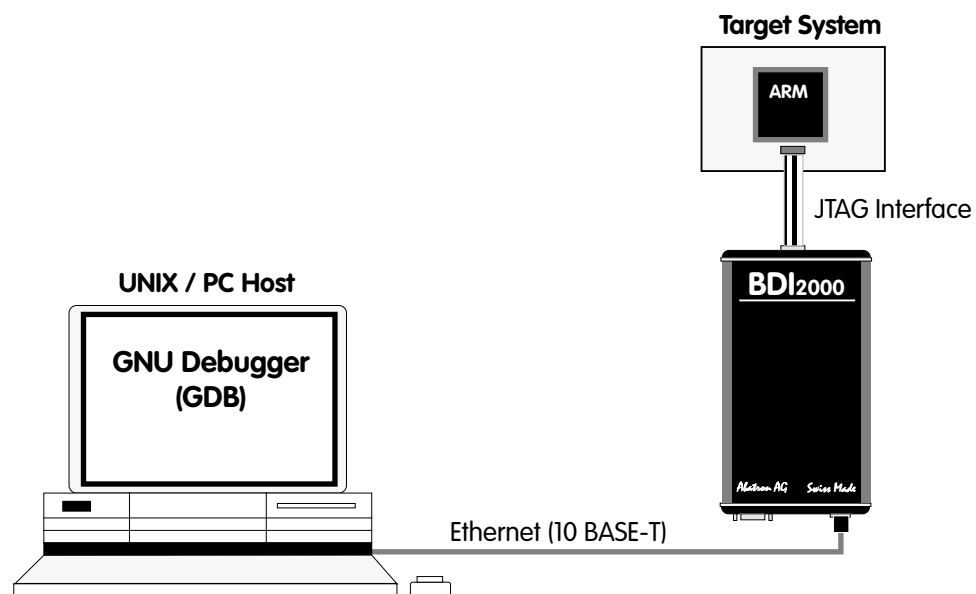

1.1 BDI2000

The BDI2000 is the main part of the bdiGDB system. This small box implements the interface between the JTAG pins of the target CPU and a 10Base-T ethernet connector. The firmware and the programmable logic of the BDI2000 can be updated by the user with a simple Windows / Linux configuration program. The BDI2000 supports 1.8 – 5.0 Volts target systems (3.0 – 5.0 Volts target systems with Rev. A/B).

1.2 BDI Configuration

As an initial setup, the IP address of the BDI2000, the IP address of the host with the configuration file and the name of the configuration file is stored within the flash of the BDI2000.

Every time the BDI2000 is powered on, it reads the configuration file via TFTP.

Following an example of a typical configuration file:

```
; bdiGDB configuration for ARM Integrator CM1136JF-S
; -----
;
[INIT]
WM32      0x1000000C  0x00000005  ;REMAP=1, MISC LED ON
;

[TARGET]
CPUTYPE    ARM1136
CLOCK      1                ;JTAG clock (0=Adaptive,1=16MHz,2=8MHz,3=4MHz, ...)
POWERUP    3000            ;start delay after power-up detected in ms
ENDIAN     LITTLE          ;memory model (LITTLE | BIG)
VECTOR     CATCH 0x1f      ;catch D_Abort, P_Abort, SWI, Undef and Reset
BREAKMODE  HARD           ;SOFT or HARD
;
SCANPRED   0 0             ;no JTAG devices before the ARM1136
SCANSUCC   1 4            ;the ETMBUF after the ARM1136 core
;

[HOST]
IP          151.120.25.119
FILE        E:\cygwin\home\demo\pid7t\fibox
FORMAT      ELF
LOAD        MANUAL        ;load file MANUAL or AUTO after reset

[FLASH]
WORKSPACE  0x00001000     ;workspace in target RAM for fast programming algorithm
CHIPTYPE   AM29BX8        ;Flash type (AM29F | AM29BX8 | AM29BX16 | I28BX8 | I28BX16)
CHIPSIZE   0x100000       ;The size of one flash chip in bytes
BUSWIDTH   32            ;The width of the flash memory bus in bits (8 | 16 | 32)
FILE        $arm1136.cfg
FORMAT     BIN 0x00010000

[REGS]
FILE       $reg1136.def
```

Based on the information in the configuration file, the target is automatically initialized after every reset.

2 Installation

2.1 Connecting the BDI2000 to Target

The enclosed cables to the target system are designed for the ARM Development Boards. In case where the target system has the same connector layout, the cable (14 pin or 20 pin) can be directly connected.



In order to ensure reliable operation of the BDI (EMC, runtimes, etc.) the target cable length must not exceed 20 cm (8").

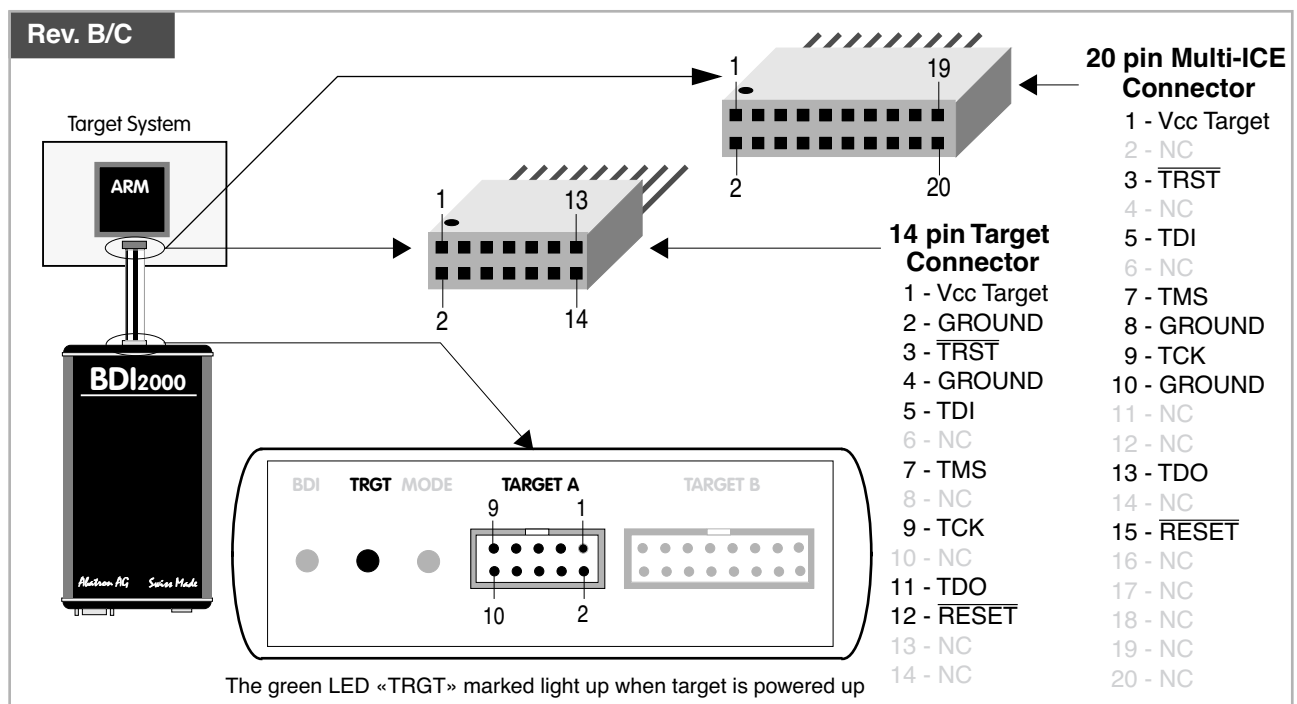
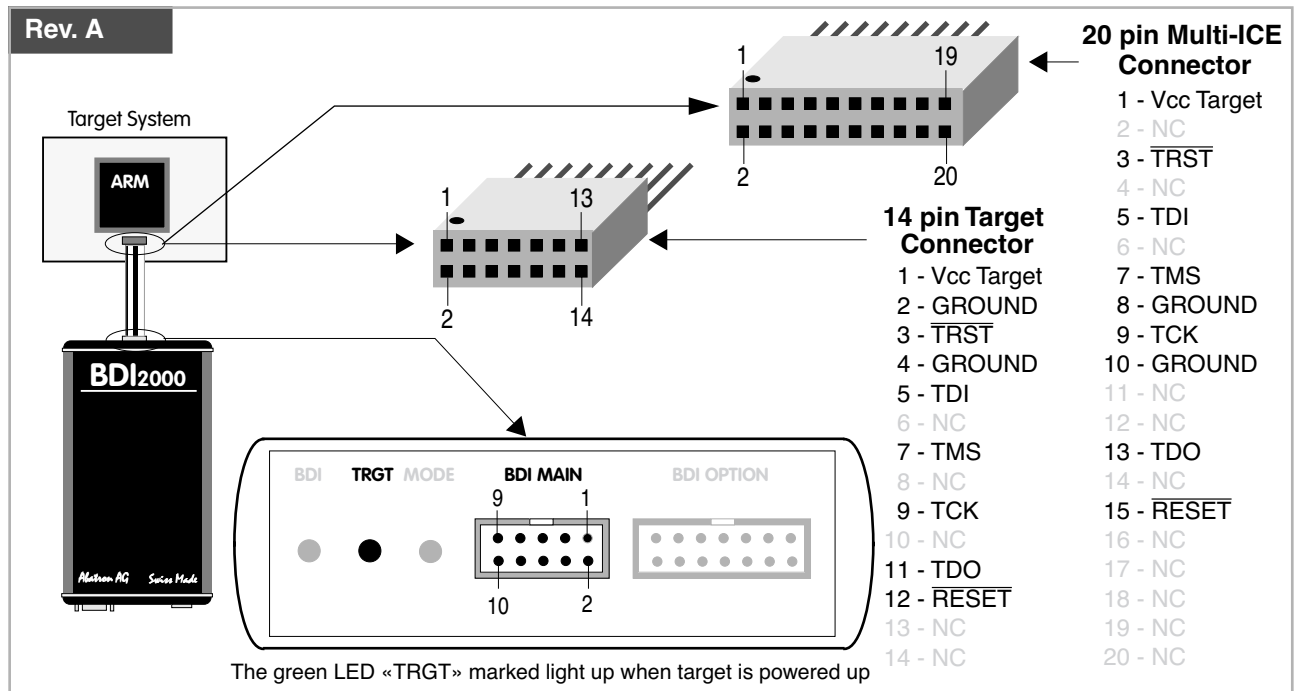

For BDI MAIN / TARGET A connector signals see table on next page.

BDI MAIN / TARGET A Connector Signals

Pin	Name	Description
1	reserved	This pin is currently not used.
2	$\overline{\text{TRST}}$	JTAG Test Reset This open-drain / push-pull output of the BDI2000 resets the JTAG TAP controller on the target. Default driver type is open-drain.
3+5	GND	System Ground
4	TCK	JTAG Test Clock This output of the BDI2000 connects to the target TCK line.
6	TMS	JTAG Test Mode Select This output of the BDI2000 connects to the target TMS line.
7	$\overline{\text{RESET}}$	This open collector output of the BDI2000 is used to reset the target system.
8	TDI	JTAG Test Data In This output of the BDI2000 connects to the target TDI line.
9	Vcc Target	1.8 – 5.0V: This is the target reference voltage. It indicates that the target has power and it is also used to create the logic-level reference for the input comparators. It also controls the output logic levels to the target. It is normally fed from Vdd I/O on the target board. 3.0 – 5.0V with Rev. A/B : This input to the BDI2000 is used to detect if the target is powered up. If there is a current limiting resistor between this pin and the target Vdd, it should be 100 Ohm or less.
10	TDO	JTAG Test Data Out This input to the BDI2000 connects to the target TDO line.

The BDI2000 works also with targets which have no dedicated $\overline{\text{TRST}}$ pin. For this kind of targets, the BDI cannot force the target to debug mode immediately after reset. The target always begins execution of application code until the BDI has finished programming the Debug Control Register.

2.1.1 Changing Target Processor Type

Before you can use the BDI2000 with an other target processor type (e.g. ARM <--> PPC), a new setup has to be done (see chapter 2.5). During this process the target cable must be disconnected from the target system. The BDI2000 needs to be supplied with 5 Volts via the BDI OPTION connector (Rev. A) or via the POWER connector (Rev. B/C). For more information see chapter 2.2.1 «External Power Supply»).



To avoid data line conflicts, the BDI2000 must be disconnected from the target system while programming the logic for an other target CPU.

2.1.2 Adaptive Clocking

Adaptive clocking is a feature which ensures that the BDI2000 never loses synchronization with the target device, whatever the target clock speed is. To achieve this, BDI2000 uses two signals TCK and RTCK. When adaptive clocking is selected, BDI2000 issues a TCK signal and waits for the Returned TCK (RTCK) to come back. BDI2000 does not progress to the next TCK until RTCK is received. For more information about adaptive clocking see ARM documentation.

Note:

Adaptive clocking is only supported with BDI2000 Rev.B/C and a special target cable. This special cable can be ordered separately from Abatron.

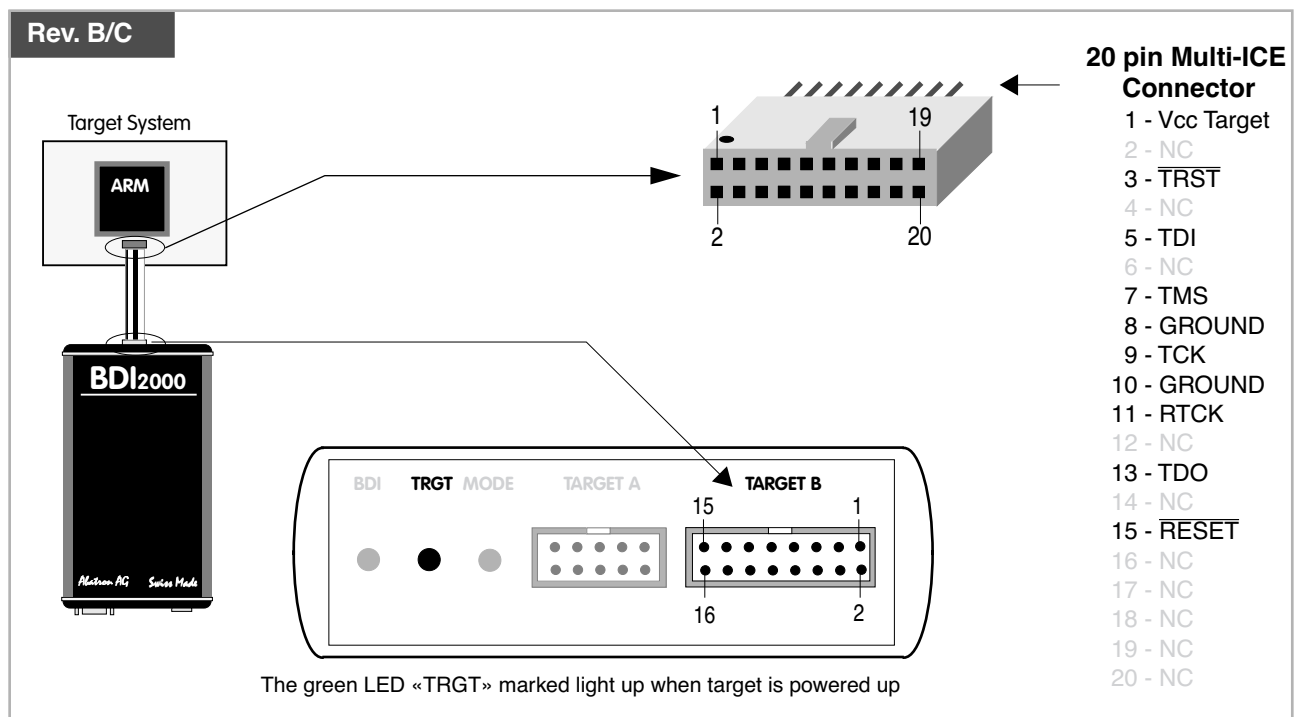

For TARGET B connector signals see table on next page.

BDI TARGET B Connector Signals:

Pin	Name	Description
1	TDO	JTAG Test Data Out This input to the BDI2000 connects to the target TDO line.
2	reserved	
3	TDI	JTAG Test Data In This output of the BDI2000 connects to the target TDI line.
4	reserved	
5	RTCK	Returned JTAG Test Clock This input to the BDI2000 connects to the target RTCK line.
6	Vcc Target	1.8 – 5.0V: This is the target reference voltage. It indicates that the target has power and it is also used to create the logic-level reference for the input comparators. It also controls the output logic levels to the target. It is normally fed from Vdd I/O on the target board. 3.0 – 5.0V with Rev. A/B : This input to the BDI2000 is used to detect if the target is powered up. If there is a current limiting resistor between this pin and the target Vdd, it should be 100 Ohm or less.
7	TCK	JTAG Test Clock This output of the BDI2000 connects to the target TCK line.
8	$\overline{\text{TRST}}$	JTAG Test Reset This open-drain / push-pull output of the BDI2000 resets the JTAG TAP controller on the target. Default driver type is open-drain.
9	TMS	JTAG Test Mode Select This output of the BDI2000 connects to the target TMS line.
10	reserved	
11	reserved	
12	GROUND	System Ground
13	$\overline{\text{RESET}}$	System Reset This open-drain output of the BDI2000 is used to reset the target system.
14	reseved	
15	reseved	
16	GROUND	System Ground

2.2 Connecting the BDI2000 to Power Supply

2.2.1 External Power Supply

The BDI2000 needs to be supplied with 5 Volts (max. 1A) via the BDI OPTION connector (Rev. A) or via POWER connector (Rev. B/C). The available power supply from Abatron (option) or the enclosed power cable can be directly connected. In order to ensure reliable operation of the BDI2000, keep the power supply cable as short as possible.



For error-free operation, the power supply to the BDI2000 must be between 4.75V and 5.25V DC. **The maximal tolerable supply voltage is 5.25 VDC. Any higher voltage or a wrong polarity might destroy the electronics.**

Rev. A

The green LED «BDI» marked light up when 5V power is connected to the BDI2000

BDI OPTION Connector

- 1 - NOT USED
- 2 - GROUND
- 3 - NOT USED
- 4 - GROUND
- 5 - NOT USED
- 6 - GROUND
- 7 - NOT USED
- 8 - GROUND
- 9 - NOT USED
- 10 - GROUND
- 11 - NOT USED
- 12 - Vcc (+5V)
- 13 - Vcc Target (+5V)
- 14 - Vcc (+5V)

Rev. B/C

The green LED «BDI» marked light up when 5V power is connected to the BDI2000

POWER Connector

- 1 - Vcc (+5V)
- 2 - VccTGT
- 3 - GROUND
- 4 - NOT USED

Please switch on the system in the following sequence:

- 1 --> external power supply
- 2 --> target system

2.2.2 Power Supply from Target System

The BDI2000 needs to be supplied with 5 Volts (max. 1A) via BDI MAIN target connector (Rev. A) or via TARGET A connector (Rev. B/C). This mode can only be used when the target system runs with 5V and the pin «Vcc Target» is able to deliver a current up to 1A@5V. For pin description and layout see chapter 2.1 «Connecting the BDI2000 to Target». Insert the enclosed Jumper as shown in figure below. **Please ensure that the jumper is inserted correctly.**



For error-free operation, the power supply to the BDI2000 must be between 4.75V and 5.25V DC. **The maximal tolerable supply voltage is 5.25 VDC. Any higher voltage or a wrong polarity might destroy the electronics.**

Rev. A

BDI OPTION Connector

- 1 - NOT USED
- 2 - GROUND
- 3 - NOT USED
- 4 - GROUND
- 5 - NOT USED
- 6 - GROUND
- 7 - NOT USED
- 8 - GROUND
- 9 - NOT USED
- 10 - GROUND
- 11 - NOT USED
- 12 - Vcc (+5V)
- 13 - Vcc Target (+5V)
- 14 - Vcc BDI2000 (+5V)

The green LEDs «BDI» and «TRGT» marked light up when target is powered up and the jumper is inserted correctly

Rev. B/C

POWER Connector

- 1 - Vcc BDI2000 (+5V)
- 2 - Vcc Target (+5V)
- 3 - GROUND
- 4 - NOT USED

The green LEDs «BDI» and «TRGT» marked light up when target is powered up and the jumper is inserted correctly

2.3 Status LED «MODE»

The built in LED indicates the following BDI states:

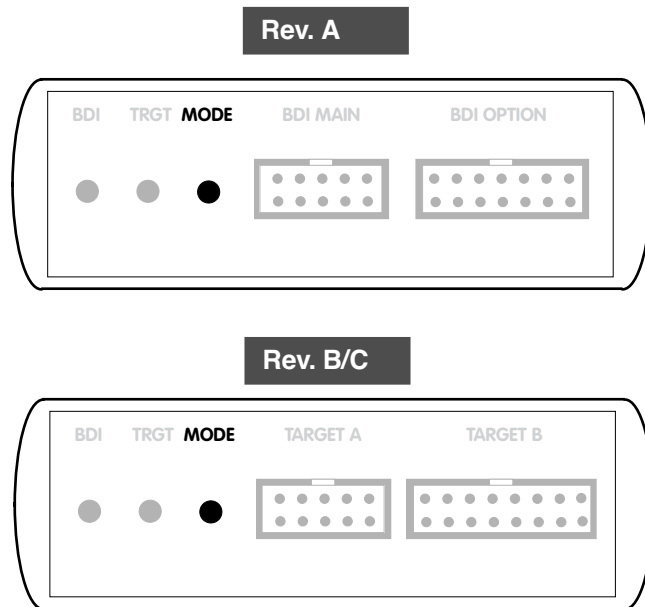

MODE LED	BDI STATES
OFF	The BDI is ready for use, the firmware is already loaded.
ON	The power supply for the BDI2000 is < 4.75VDC.
BLINK	The BDI «loader mode» is active (an invalid firmware is loaded or loading firmware is active).

2.4 Connecting the BDI2000 to Host

2.4.1 Serial line communication

Serial line communication is only used for the initial configuration of the bdiGDB system.

The host is connected to the BDI through the serial interface (COM1...COM4). The communication cable (included) between BDI and Host is a serial cable. There is the same connector pinout for the BDI and for the Host side (Refer to Figure below).

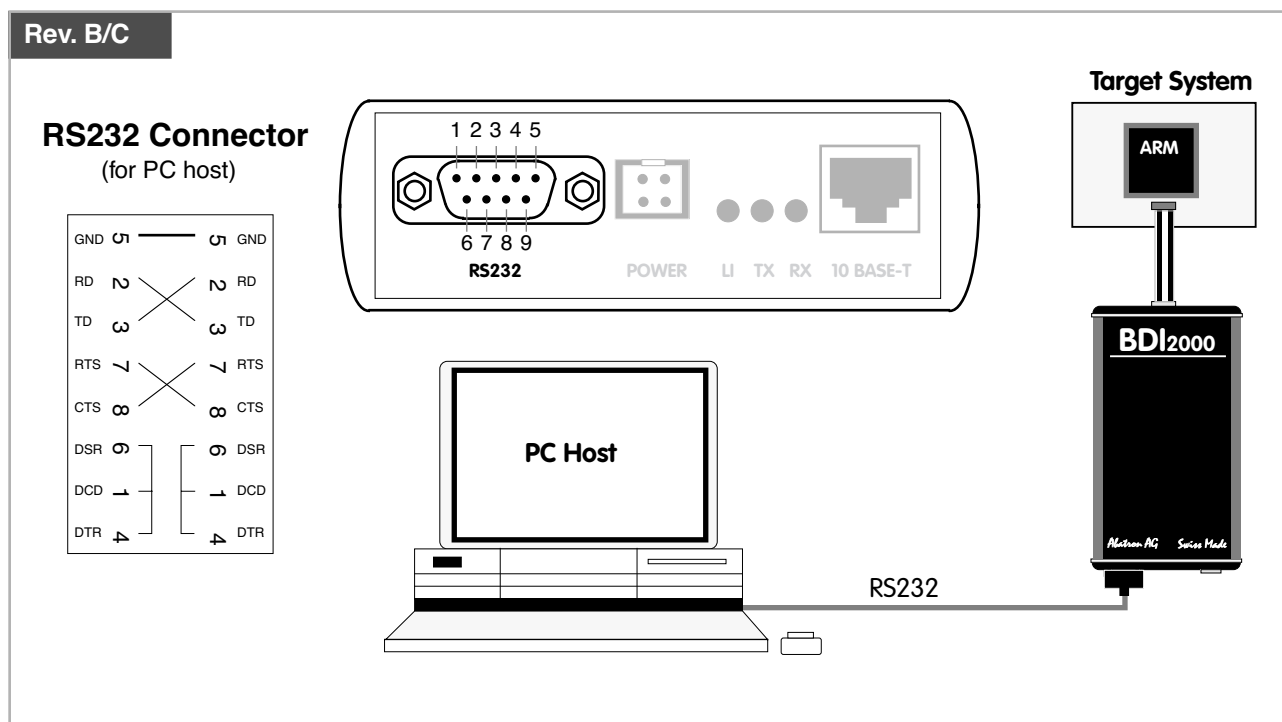
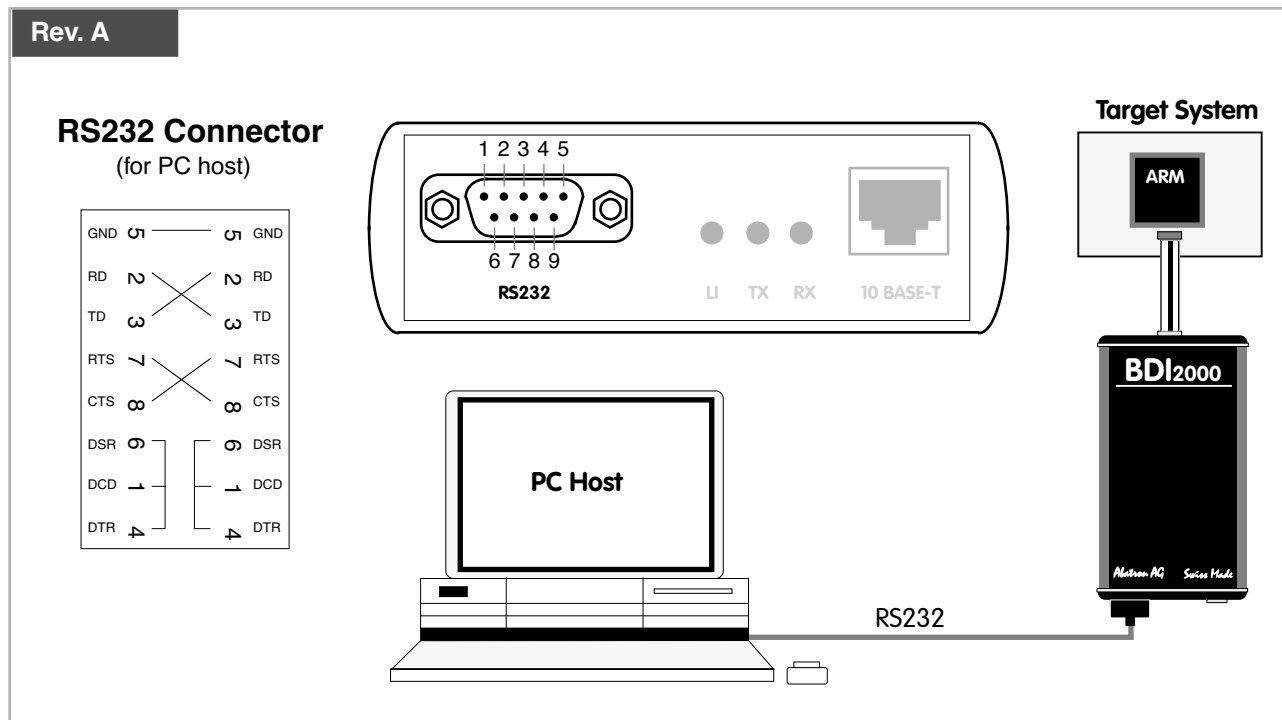

2.4.2 Ethernet communication

The BDI2000 has a built-in 10 BASE-T Ethernet interface (see figure below). Connect an UTP (Unshielded Twisted Pair) cable to the BD2000. For thin Ethernet coaxial networks you can connect a commercially available media converter (BNC-->10 BASE-T) between your network and the BDI2000. Contact your network administrator if you have questions about the network.

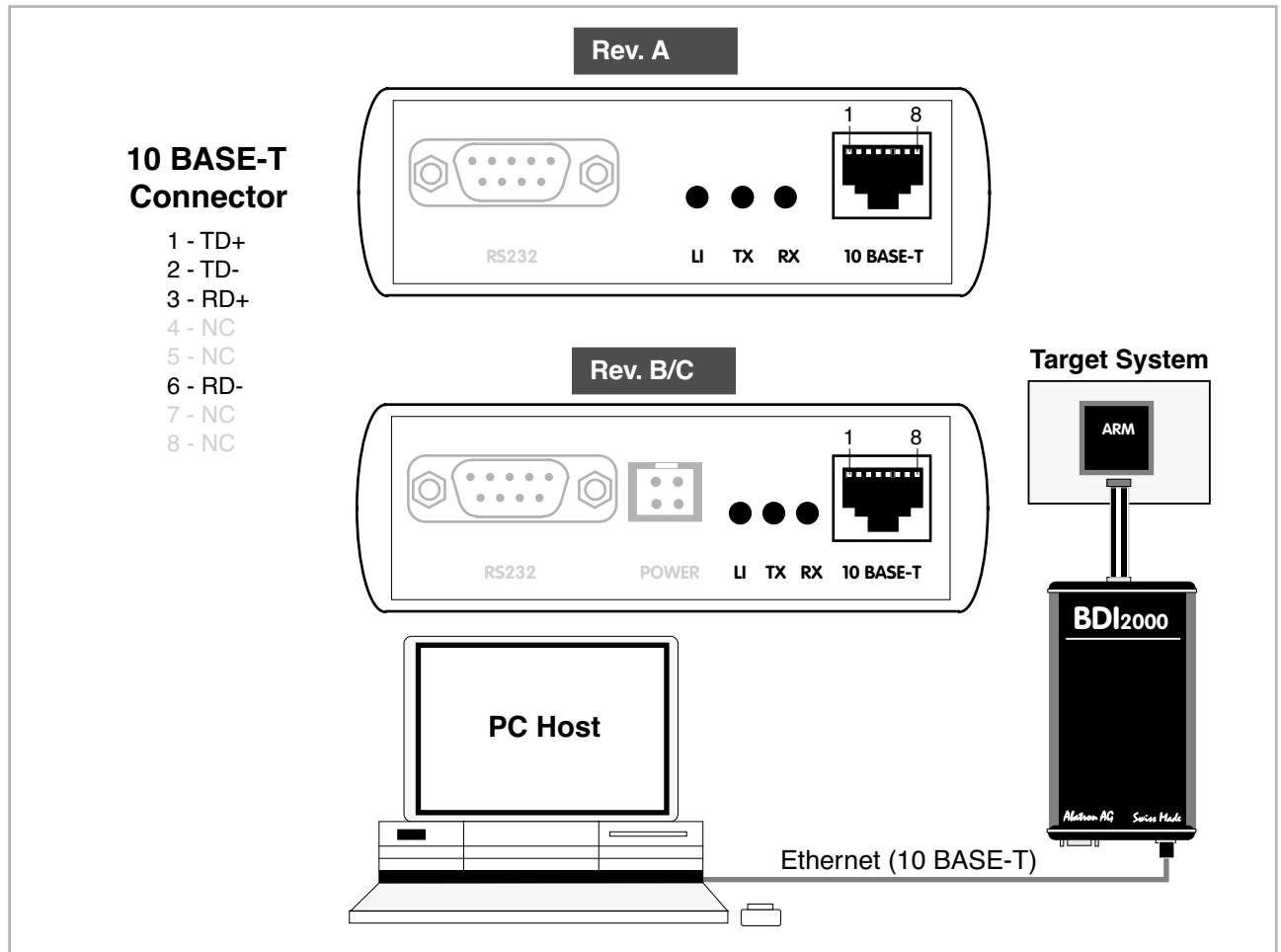

The following explains the meanings of the built-in LED lights:

LED	Name	Description
LI	Link	When this LED light is ON, data link is successful between the UTP port of the BDI2000 and the hub to which it is connected.
TX	Transmit	When this LED light BLINKS, data is being transmitted through the UTP port of the BDI2000
RX	Receive	When this LED light BLINKS, data is being received through the UTP port of the BDI2000

2.5 Installation of the Configuration Software

On the enclosed diskette you will find the BDI configuration software and the firmware required for the BDI2000. For Windows NT users there is also a TFTP server included.

The following files are on the diskette.

b20a11gd.exe	Windows configuration program
b20a11gd.hlp	Windows help file for the configuration program
b20a11gd.xxx	Firmware for the BDI2000
armjed20.xxx	JEDEC file for the BDI2000 (Rev. A/B) logic device
armjed21.xxx	JEDEC file for the BDI2000 (Rev. C) logic device
tftpsrv.exe	TFTP server for WindowsNT/ Windows95 (WIN32 console application)
*.cfg	Configuration files
*.def	Register definition files
bdisetup.zip	ZIP Archive with the Setup Tool sources for Linux / UNIX hosts.

Overview of an installation / configuration process:

- Create a new directory on your hard disk
- Copy the entire contents of the enclosed diskette into this directory
- Linux only: extract the setup tool sources and build the setup tool
- Use the setup tool to load/update the BDI firmware/logic
Note: A new BDI has no firmware/logic loaded.
- Use the setup tool to transmit the initial configuration parameters
 - IP address of the BDI.
 - IP address of the host with the configuration file.
 - Name of the configuration file. This file is accessed via TFTP.
 - Optional network parameters (subnet mask, default gateway).

Activating BOOTP:

The BDI can get the network configuration and the name of the configuration file also via BOOTP. For this simply enter 0.0.0.0 as the BDI's IP address (see following chapters). If present, the subnet mask and the default gateway (router) is taken from the BOOTP vendor-specific field as defined in RFC 1533.

With the Linux setup tool, simply use the default parameters for the -c option:

```
[root@LINUX_1 bdisetup]# ./bdisetup -c -p/dev/ttyS0 -b57
```

The MAC address is derived from the serial number as follows:

MAC: 00-0C-01-xx-xx-xx , repase the xx-xx-xx with the 6 left digits of the serial number

Example: SN# 93123457 ==>> 00-0C-01-93-12-34

2.5.1 Configuration with a Linux / Unix host

The firmware / logic update and the initial configuration of the BDI2000 is done with a command line utility. In the ZIP Archive `bdisetup.zip` are all sources to build this utility. More information about this utility can be found at the top in the `bdisetup.c` source file. There is also a make file included. Starting the tool without any parameter displays information about the syntax and parameters.



To avoid data line conflicts, the BDI2000 must be disconnected from the target system while programming the logic for an other target CPU (see Chapter 2.1.1).

Following the steps to bring-up a new BDI2000:

1. Build the setup tool:

The setup tool is delivered only as source files. This allows to build the tool on any Linux / Unix host. To build the tool, simply start the make utility.

```
[root@LINUX_1 bdisetup]# make
cc -O2 -c -o bdisetup.o bdisetup.c
cc -O2 -c -o bdisetup.o bdisetup.c
cc -O2 -c -o bdisetup.o bdisetup.c
cc -s bdisetup.o bdisetup.o bdisetup.o -o bdisetup
```

2. Check the serial connection to the BDI:

With "`bdisetup -v`" you may check the serial connection to the BDI. The BDI will respond with information about the current loaded firmware and network configuration.

Note: Login as root, otherwise you probably have no access to the serial port.

```
[root@LINUX_1 bdisetup]# ./bdisetup -v -p/dev/ttyS0 -b57
BDI Type : BDI2000 Rev.C (SN: 92152150)
Loader   : V1.05
Firmware : unknown
Logic    : unknown
MAC      : 00-0c-01-92-15-21
IP Addr  : 255.255.255.255
Subnet   : 255.255.255.255
Gateway  : 255.255.255.255
Host IP  : 255.255.255.255
Config   : ??????????????????
```

3. Load/Update the BDI firmware/logic:

With "`bdisetup -u`" the firmware is loaded and the CPLD within the BDI2000 is programmed. This configures the BDI for the target you are using. Based on the parameters `-a` and `-t`, the tool selects the correct firmware / logic files. If the firmware / logic files are in the same directory as the setup tool, there is no need to enter a `-d` parameter.

```
[root@LINUX_1 bdisetup]# ./bdisetup -u -p/dev/ttyS0 -b57 -aGDB -tARM11
Connecting to BDI loader
Erasing CPLD
Programming firmware with ./b20armgd.103
Programming CPLD with ./armjed21.102
```

4. Transmit the initial configuration parameters:

With "bdisetup -c" the configuration parameters are written to the flash memory within the BDI. The following parameters are used to configure the BDI:

BDI IP Address	The IP address for the BDI2000. Ask your network administrator for assigning an IP address to this BDI2000. Every BDI2000 in your network needs a different IP address.
Subnet Mask	The subnet mask of the network where the BDI is connected to. A subnet mask of 255.255.255.255 disables the gateway feature. Ask your network administrator for the correct subnet mask. If the BDI and the host are in the same subnet, it is not necessary to enter a subnet mask.
Default Gateway	Enter the IP address of the default gateway. Ask your network administrator for the correct gateway IP address. If the gateway feature is disabled, you may enter 255.255.255.255 or any other value.
Config - Host IP Address	Enter the IP address of the host with the configuration file. The configuration file is automatically read by the BDI2000 after every start-up.
Configuration file	Enter the full path and name of the configuration file. This file is read via TFTP. Keep in mind that TFTP has it's own root directory (usual /tftpboot). You can simply copy the configuration file to this directory and the use the file name without any path. For more information about TFTP use "man tftpd".

```
[root@LINUX_1 bdi2000]# ./bdisetup -c -p/dev/ttyS0 -b57 \  
> -i151.120.25.101 \  
> -h151.120.25.118 \  
> -feval7t.cnf  
Connecting to BDI loader  
Writing network configuration  
Writing init list and mode  
Configuration passed
```

5. Check configuration and exit loader mode:

The BDI is in loader mode when there is no valid firmware loaded or you connect to it with the setup tool. While in loader mode, the Mode LED is flashing. The BDI will not respond to network requests while in loader mode. To exit loader mode, the "bdisetup -v -s" can be used. You may also power-off the BDI, wait some time (1min.) and power-on it again to exit loader mode.

```
[root@LINUX_1 bdi2000]# ./bdisetup -v -p/dev/ttyS0 -b57 -s  
BDI Type : BDI2000 Rev.C (SN: 92152150)  
Loader : V1.05  
Firmware : V1.03 bdiGDB for ARM11  
Logic : V1.02 ARM  
MAC : 00-0c-01-92-15-21  
IP Addr : 151.120.25.101  
Subnet : 255.255.255.255  
Gateway : 255.255.255.255  
Host IP : 151.120.25.118  
Config : eval7t.cnf
```

The Mode LED should go off, and you can try to connect to the BDI via Telnet.

```
[root@LINUX_1 bdi2000]# telnet 151.120.25.101
```

2.5.2 Configuration with a Windows host

First make sure that the BDI is properly connected (see Chapter 2.1 to 2.4).



To avoid data line conflicts, the BDI2000 must be disconnected from the target system while programming the logic for an other target CPU (see Chapter 2.1.1).

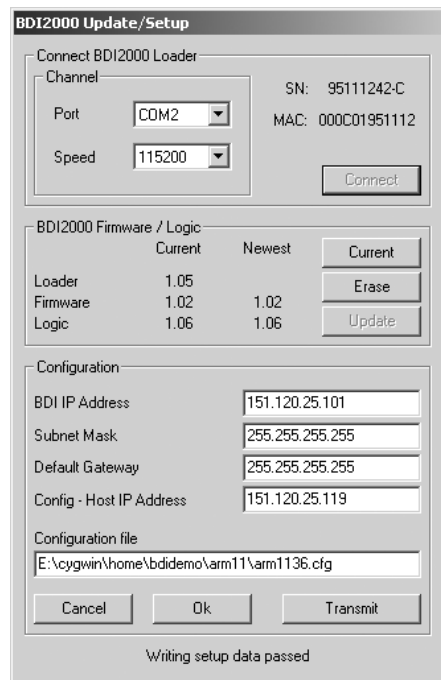

dialog box «BDI2000 Update/Setup»

Before you can use the BDI2000 together with the GNU debugger, you must store the initial configuration parameters in the BDI2000 flash memory. The following options allow you to do this:

- Channel Select the communication port where the BDI2000 is connected during this setup session.
- Baudrate Select the baudrate used to communicate with the BDI2000 loader during this setup session.
- Connect Click on this button to establish a connection with the BDI2000 loader. Once connected, the BDI2000 remains in loader mode until it is restarted or this dialog box is closed.
- Current Press this button to read back the current loaded BDI2000 software and logic versions. The current loader, firmware and logic version will be displayed.
- Update This button is only active if there is a newer firmware or logic version present in the execution directory of the bdiGDB setup software. Press this button to write the new firmware and/or logic into the BDI2000 flash memory / programmable logic.

BDI IP Address	Enter the IP address for the BDI2000. Use the following format: xxx.xxx.xxx.xxx e.g.151.120.25.101 Ask your network administrator for assigning an IP address to this BDI2000. Every BDI2000 in your network needs a different IP address.
Subnet Mask	Enter the subnet mask of the network where the BDI is connected to. Use the following format: xxx.xxx.xxx.xx.e.g.255.255.255.0 A subnet mask of 255.255.255.255 disables the gateway feature. Ask your network administrator for the correct subnet mask.
Default Gateway	Enter the IP address of the default gateway. Ask your network administrator for the correct gateway IP address. If the gateway feature is disabled, you may enter 255.255.255.255 or any other value..
Config - Host IP Address	Enter the IP address of the host with the configuration file. The configuration file is automatically read by the BDI2000 after every start-up.
Configuration file	Enter the full path and name of the configuration file. e.g. D:\ada\target\config\bdi\evs332.cnf For information about the syntax of the configuration file see the bdiGDB User manual. This name is transmitted to the TFTP server when reading the configuration file.
Transmit	Click on this button to store the configuration in the BDI2000 flash memory.

2.5.3 Recover procedure

In rare instances you may not be able to load the firmware in spite of a correctly connected BDI (error of the previous firmware in the flash memory). **Before carrying out the following procedure, check the possibilities in Appendix «Troubleshooting».** In case you do not have any success with the tips there, do the following:

- Switch OFF the power supply for the BDI and open the unit as described in Appendix «Maintenance»
- Place the jumper in the «**INIT MODE**» position
- Connect the power cable or target cable if the BDI is powered from target system
- Switch ON the power supply for the BDI again and wait until the LED «MODE» blinks fast
- Turn the power supply OFF again
- Return the jumper to the «**DEFAULT**» position
- Reassemble the unit as described in Appendix «Maintenance»

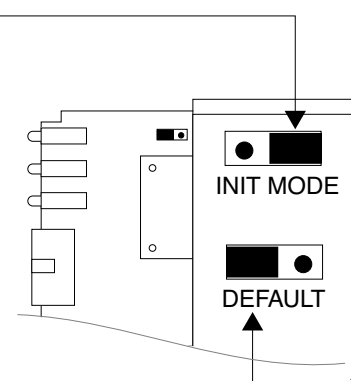

2.6 Testing the BDI2000 to host connection

After the initial setup is done, you can test the communication between the host and the BDI2000. There is no need for a target configuration file and no TFTP server is needed on the host.

- If not already done, connect the bdiGDB system to the network.
- Power-up the BDI2000.
- Start a Telnet client on the host and connect to the BDI2000 (the IP address you entered during initial configuration).
- If everything is okay, a sign on message like «BDI Debugger for ARM» should be displayed in the Telnet window.

2.7 TFTP server for Windows NT

The bdiGDB system uses TFTP to access the configuration file and to load the application program. Because there is no TFTP server bundled with Windows NT, Abatron provides a TFTP server application **tftpsrv.exe**. This WIN32 console application runs as normal user application (not as a system service).

Command line syntax: `tftpsrv [p] [w] [dRootDirectory]`

Without any parameter, the server starts in read-only mode. This means, only read access request from the client are granted. This is the normal working mode. The bdiGDB system needs only read access to the configuration and program files.

The parameter [p] enables protocol output to the console window. Try it.

The parameter [w] enables write accesses to the host file system.

The parameter [d] allows to define a root directory.

<code>tftpsrv p</code>	Starts the TFTP server and enables protocol output
<code>tftpsrv p w</code>	Starts the TFTP server, enables protocol output and write accesses are allowed.
<code>tftpsrv dC:\tftp\</code>	Starts the TFTP server and allows only access to files in C:\tftp and its subdirectories. As file name, use relative names. For example "bd\mpc750.cfg" accesses "C:\tftp\bd\mpc750.cfg"

You may enter the TFTP server into the Startup group so the server is started every time you logon.

3 Using bdiGDB

3.1 Principle of operation

The firmware within the BDI handles the GDB request and accesses the target memory or registers via the JTAG interface. There is no need for any debug software on the target system. After loading the code via TFTP debugging can begin at the very first assembler statement.

Whenever the BDI system is powered-up the following sequence starts:

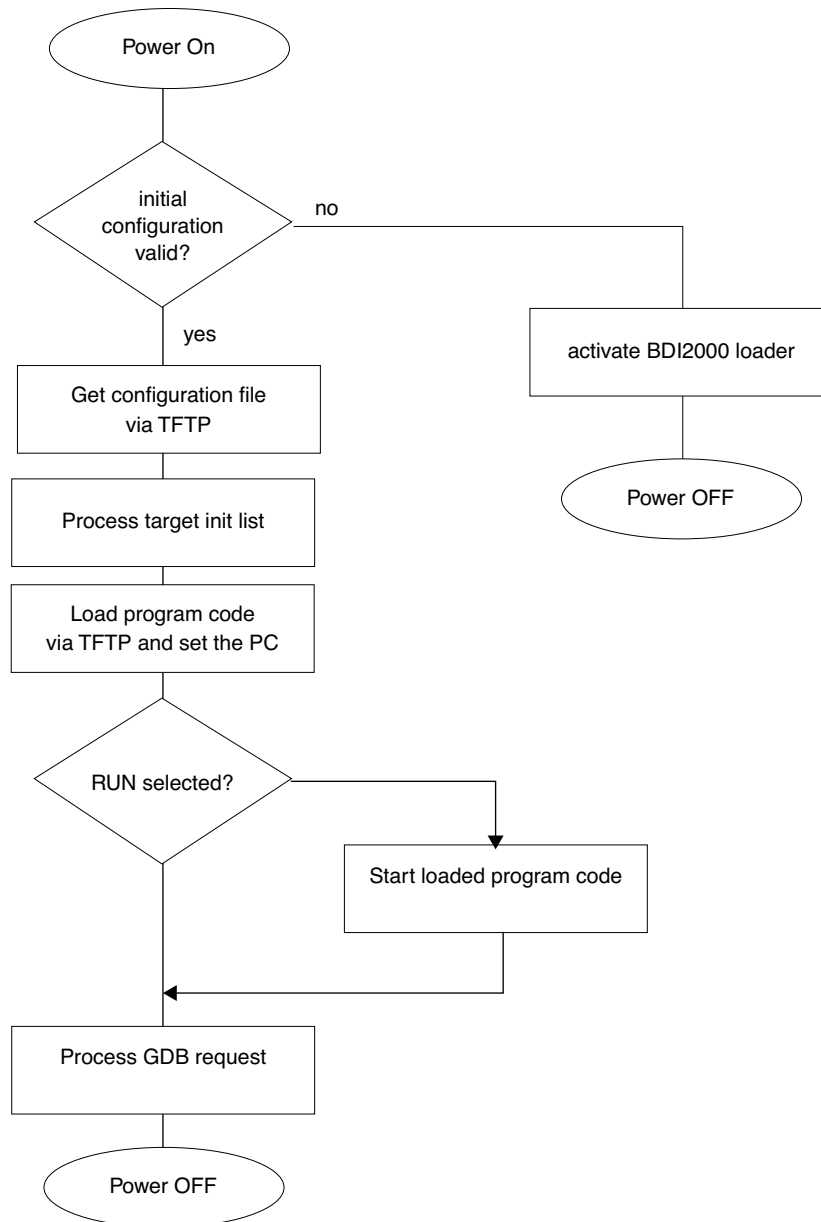

3.2 Configuration File

The configuration file is automatically read by the BDI2000 after every power on. The syntax of this file is as follows:

```

; comment
[part name]
core# identifier parameter1 parameter2 ..... parameterN ; comment
core# identifier parameter1 parameter2 ..... parameterN
.....
[part name]
core# identifier parameter1 parameter2 ..... parameterN
core# identifier parameter1 parameter2 ..... parameterN
.....
                etc.

```

Numeric parameters can be entered as decimal (e.g. 700) or as hexadecimal (0x80000).

The core# is optional. If not present the BDI assume core #0. See also chapter "Multi-Core Support".

3.2.1 Part [INIT]

The part [INIT] defines a list of commands which are be executed every time the target comes out of reset (except in STARTUP RUN mode). The commands are used to get the target ready for loading the program file.

WGPR register value	Write value to the selected general purpose register. register the register number 0 .. 15 value the value to write into the register Example: WGPR 0 5
WREG name value	Write value to the selected CPU register by name name the register name (CPSR) value the value to write into the register Example: WREG CPSR 0x600000D3
WCPn register value	Write value to the selected Coprocessor register. n the CP number (0 .. 15) register the register number (see chapter CPx registers) value the value to write into the register Example: WCP15 2 0x00004000 ; set Translation Base 0
WM8 address value	Write a byte (8bit) to the selected memory place. address the memory address value the value to write to the target memory Example: WM8 0xFFFFFA21 0x04 ; SYPCR: watchdog disable ...
WM16 address value	Write a half word (16bit) to the selected memory place. address the memory address value the value to write to the target memory Example: WM16 0x02200200 0x0002 ; TBSCR
WM32 address value	Write a word (32bit) to the selected memory place. address the memory address value the value to write to the target memory Example: WM32 0x02200000 0x01632440 ; SIUMCR
WAPB address value	Cortex-A8: Write a word (32bit) to the Debug APB memory. address the APB memory address value the value to write to the APB memory Example: WAPB 0xd4012014 0x08000014 ; RCSR

WBIN address filename	<p>Write a binary image to the selected memory place. The binary image is read via TFTP from the host. Up to 4 such entries are supported.</p> <p>address the memory address</p> <p>filename the filename including the full path</p> <p>Example: WBIN 0x4000 pagetable.bin</p>
RM8 address value	<p>Read a byte (8bit) from the selected memory place.</p> <p>address the memory address</p> <p>Example: RM8 0x00000000</p>
RM16 address value	<p>Read a half word (16bit) from the selected memory place.</p> <p>address the memory address</p> <p>Example: RM16 0x00000000</p>
RM32 address value	<p>Read a word (32bit) from the selected memory place.</p> <p>address the memory address</p> <p>Example: RM32 0x00000000</p>
MMAP start end	<p>Because a memory access to an invalid memory space via JTAG leads to a deadlock, this entry can be used to define up to 32 valid memory ranges. If at least one memory range is defined, the BDI checks against this range(s) and avoids accessing of not mapped memory ranges.</p> <p>start the start address of a valid memory range</p> <p>end the end address of this memory range</p> <p>Example: MMAP 0xFFE00000 0xFFFFFFFF ;Boot ROM</p>
DELAY value	<p>Delay for the selected time.</p> <p>value the delay time in milliseconds (1...30000)</p> <p>Example: DELAY 500 ; delay for 0.5 seconds</p>
CLOCK value	<p>This entry allows to change the JTAG clock frequency during processing of the init list. But the final JTAG clock after processing the init list is taken from the CLOCK entry in the [TARGET] section. This entry maybe of interest to speed-up JTAG clock as soon as possible (after PLL setup).</p> <p>value see CLOCK parameter in [TARGET] section</p> <p>Example: CLOCK 2 ; switch to 8 MHz JTAG clock</p>

Using a startup program to initialize the target system:

For targets where initialization can not be done with a simple initialization list, there is the possibility to download and execute a special startup code. The startup code must be present in a file on the host. The last instruction in this startup code should be a BKPT. After processing the initlist, the BDI downloads this startup code to RAM, starts it and waits until it completes. If there is no BKPT instruction in the startup code, the BDI terminates it after a timeout of 5 seconds.

FILE filename The name of the file with the startup code. This name is used to access the startup code via TFTP.

filename the filename including the full path
 Example: FILE F:\gdb\target\config\pid7\tstartup.hex

FORMAT format The format of the startup file. Currently COFF, S-Record, a.out, Binary and ELF file formats are supported. If the startup code is already stored in ROM on the target, select ROM as the format.

format COFF, SREC, AOUT, BIN, ELF or ROM
 Example: FORMAT COFF

START address The address where to start the startup code. If this value is not defined and the core is not in ROM, the address is taken from the code file. If this value is not defined and the core is already in ROM, the PC will not be set before starting the code.

address the address where to start the startup code
 Example: START 0x10000

Note:

If an init list and a startup code file are present, the init list is processed first and then the startup code is loaded and executed. Therefore it is possible first to enable some RAM with the init list before the startup code is loaded and executed.

```
[INIT]
WM32      0x0B000020 0x00000000 ;Clear Reset Map

FILE      d:\gdb\bdi\startup.hex
FORMAT    SREC
START     0x100
```

3.2.2 Part [TARGET]

The part [TARGET] defines some target specific values.

CPUTYPE type This value gives the BDI information about the connected CPU.
 type The CPU type from the following list:
 ARM1136, CORTEX-A8, OMAP3430
 Example: CPUTYPE ARM1136

CLOCK main [init] [SLOW] With this value(s) you can select the JTAG clock rate the BDI2000 uses when communication with the target CPU. The "main" entry is used after processing the initialization list. The "init" value is used after target reset until the initialization list is processed. If there is no "init" value defined, the "main" value is used all the times.

Adaptive clocking is only supported with BDI2000 Rev.B/C and needs a special target connector cable. Add also SLOW if the CPU clock frequency may fall below 6 MHz during adaptive clocking.

 main,init: 0 = Adaptive
 1 = 16 MHz 6 = 200 kHz
 2 = 8 MHz 7 = 100 kHz
 3 = 4 MHz 8 = 50 kHz
 4 = 1 MHz 9 = 20 kHz
 5 = 500 kHz 10 = 10 kHz
 Example: CLOCK 1 ; JTAG clock is 16 MHz

RESET type [time] Normally the BDI drives the reset line during startup. If reset type is NONE or SOFT, the BDI does not assert a hardware reset during startup. If reset type SOFT is supported depends on the connected target.

 type NONE
 SOFT (soft reset via a debug register)
 HARD (default)
 time The time in milliseconds the BDI assert the reset signal.
 Example: RESET NONE ; no reset during startup
 RESET SOFT ; reset ARM core via RCSR
 RESET HARD 1000 ; assert RESET for 1 second

TRST type Normally the BDI uses an open drain driver for the TRST signal. This is in accordance with the ARM recommendation. For boards where TRST is simply pulled low with a weak resistor, TRST will always be asserted and JTAG debugging is impossible. In that case, the TRST driver type can be changed to push-pull. Then the BDI actively drives also high level.

 type OPENDRAIN (default)
 PUSHPULL
 Example: TRST PUSHPULL ; Drive TRST also high

- STARTUP mode [runtime]** This parameter selects the target startup mode. The following modes are supported:
- HALT** This default mode tries to forces the target to debug mode immediately out of reset. If successful, no code is executed after reset.
 - STOP** In this mode, the BDI lets the target execute code for "runtime" milliseconds after reset. This mode is useful when monitor code should initialize the target system.
 - RUN** After reset, the target executes code until stopped by the Telnet "halt" command. The init list is not processed in this mode.
- Example: `STARTUP STOP 3000 ; let the CPU run for 3 seconds`
- WAKEUP time** This entry in the init list allows to define a delay time (in ms) the BDI inserts between releasing the reset line and starting communicating with the target. This delay is necessary when a target needs some wake-up time after a reset.
- time** the delay time in milliseconds
- Example: `WAKEUP 3000 ; insert 3sec wake-up time`
- BDIMODE mode param** This parameter selects the BDI debugging mode. The following modes are supported:
- LOADONLY** Loads and starts the application code. No debugging via JTAG interface.
 - AGENT** The debug agent runs within the BDI. There is no need for any debug software on the target. This mode accepts a second parameter. If RUN is entered as a second parameter, the loaded application will be started immediately, otherwise only the PC is set and BDI waits for GDB requests.
- Example: `BDIMODE AGENT RUN`
- ENDIAN format** This entry defines the endiannes of the memory system.
- format** The endiannes of the target memory:
LITTLE (default)
BIG
- Example: `ENDIAN LITTLE`
- VECTOR CATCH mask** When this line is present, the BDI catches exceptions. The mask is used to setup the ARM Vector catch register.
- mask** selects the exceptions to catch
- Example: `VECTOR CATCH 0x1B ;catch Abort, Undef, Reset`

- BREAKMODE mode** This parameter defines how breakpoints are implemented.
- SOFT** This is the normal mode. Breakpoints are implemented by replacing code with a BKPT instruction.
 - HARD** In this mode, the breakpoint hardware is used. Only 6 breakpoints at a time are supported.
 - Example:** BREAKMODE HARD
- MEMACCES mode [wait]** For Cortex-A8, this parameter defines how memory is accessed. Either via the ARM core by executing ld and st instructions or via the AHB access port. The current mode can also be changed via the Telnet interface. The optional wait parameter allows to define a time the BDI waits before it expects that a value is ready or written. This allows to optimize download performance. The wait time is (8 x wait) TCK's in Run-Test/Idle state. The following modes are supported:
- CORE** The CORE (default) mode requires that the core is halted and makes use of the memory management unit (MMU) and cache.
 - AHB** The AHB access mode can access memory even when the core is running but bypasses the MMU and cache.
 - Example:** MEMACCES CORE 5 ; 40 TCK's access delay
- SIO port [baudrate]** When this line is present, a TCP/IP channel is routed to the BDI's RS232 connector. The port parameter defines the TCP port used for this BDI to host communication. You may choose any port except 0 and the default Telnet port (23). On the host, open a Telnet session using this port. Now you should see the UART output in this Telnet session. You can use the normal Telnet connection to the BDI in parallel, they work completely independent. Also input to the UART is implemented.
- port** The TCP/IP port used for the host communication.
 - baudrate** The BDI supports 2400 ... 115200 baud
 - Example:** SIO 7 9600 ;TCP port for virtual IO
- DCC port** When this line is present, a TCP/IP channel is routed to the ARM debug communication channel (DCC). The port parameter defines the TCP port used for this BDI to host communication. You may choose any port except 0 and the default Telnet port (23). On the host, open a Telnet session using this port. Now you should see the DCC output in this Telnet session. You can use the normal Telnet connection to the BDI in parallel, they work completely independent. Also input to DCC is implemented.
- port** The TCP/IP port used for the host communication.
 - Example:** DCC 7 ;TCP port for DCC I/O

Daisy chained JTAG devices:

For ARM targets, the BDI can also handle systems with multiple devices connected to the JTAG scan chain. In order to put the other devices into BYPASS mode and to count for the additional bypass registers, the BDI needs some information about the scan chain layout. Enter the number (count) and total instruction register (irlen) length of the devices present before the ARM chip (Predecessor). Enter the appropriate information also for the devices following the ARM chip (Successor):

SCANPRED count irlen This value gives the BDI information about JTAG devices present before the ARM chip in the JTAG scan chain.

count The number of preceding devices

irlen The sum of the length of all preceding instruction registers (IR).

Example: SCANPRED 1 8 ; one device with an IR length of 8

SCANSUCC count irlen This value gives the BDI information about JTAG devices present after the ARM chip in the JTAG scan chain.

count The number of succeeding devices

irlen The sum of the length of all succeeding instruction registers (IR).

Example: SCANSUCC 2 12 ; two device with an IR length of 8+4

Low level JTAG scan chain configuration:

Sometimes it is necessary to configure the test access port (TAP) of the target before the ARM debug interface is visible and accessible in the usual way. The BDI supports this configuration in a very generic way via the SCANINIT and SCANPOST configuration commands. Both accept a string that defines the JTAG sequences to execute. The following example shows how to use these commands:

```

; Configure ICEPick module to make ARM926 TAP visible
SCANINIT  t1:w1000:t0:w1000:      ;toggle TRST
SCANINIT  i6=07:d8=89:i6=02:      ;connect and select router
SCANINIT  d32=81000082:           ;set IP control
SCANINIT  d32=a018206f:           ;configure TAP0
SCANINIT  d32=a018216f:c15:       ;enable TAP0, clock 5 times in RTI
SCANINIT  i10=ffff                ;scan bypass
;
; Between SCANINIT and SCANPOST the ARM ICEBreaker is configured
; and the DBGCRQ bit in the ARM debug control register is set.
;
SCANPOST  i10=002f:               ;IP(router) - ARM(bypass)
SCANPOST  d33=0102000106:        ;IP control = SysReset
SCANPOST  i10=ffff                ;scan bypass

```

The following low level JTAG commands are supported in the string. Use ":" between commands.

```

I<n>=<...b2b1b0>  write IR, b0 is first scanned
D<n>=<...b2b1b0>  write DR, b0 is first scanned
                  n : the number of bits 1..256
                  bx : a data byte, two hex digits
W<n>             wait for n (decimal) micro seconds
T1              assert TRST
T0              release TRST
R1              assert RESET
R0              release RESET
CH<n>           clock TCK n (decimal) times with TMS high
CL<n>           clock TCK n (decimal) times with TMS low

```

The following diagram shows the parts of the standard reset sequence that are replaced with the SCAN string. Only the appropriate part of the reset sequence is replaced. If only a SCANINIT string is defined, then the standard "post" sequence is still executed.

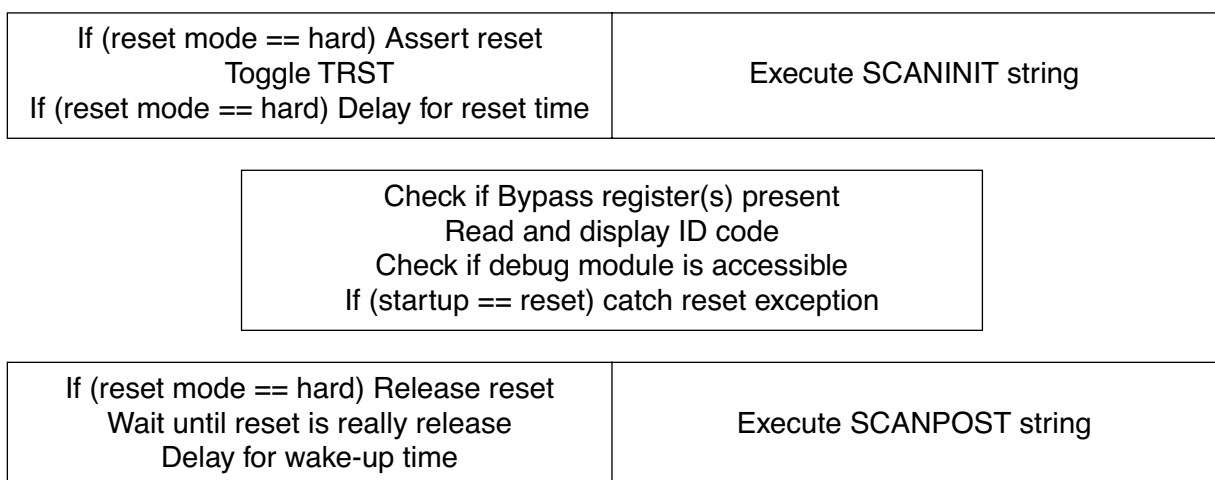

3.2.3 Part [HOST]

The part [HOST] defines some host specific values.

IP ipaddress	<p>The IP address of the host.</p> <p>ipaddress the IP address in the form xxx.xxx.xxx.xxx</p> <p>Example: IP 151.120.25.100</p>
FILE filename	<p>The default name of the file that is loaded into RAM using the Telnet 'load' command. This name is used to access the file via TFTP. If the filename starts with a \$, this \$ is replace with the path of the configuration file name.</p> <p>filename the filename including the full path or \$ for relative path.</p> <p>Example: FILE F:\gnu\demo\arm\test.elf FILE \$test.elf</p>
FORMAT format [offset]	<p>The format of the image file and an optional load address offset. If the image is already stored in ROM on the target, select ROM as the format. The optional parameter "offset" is added to any load address read from the image file.</p> <p>format SREC, BIN, AOUT, ELF, COFF or ROM</p> <p>Example: FORMAT ELF FORMAT ELF 0x10000</p>
LOAD mode	<p>In Agent mode, this parameters defines if the code is loaded automatically after every reset.</p> <p>mode AUTO, MANUAL</p> <p>Example: LOAD MANUAL</p>
START address	<p>The address where to start the program file. If this value is not defined and the core is not in ROM, the address is taken from the code file. If this value is not defined and the core is already in ROM, the PC will not be set before starting the target. This means, the program starts at the normal reset address (0x00000000).</p> <p>address the address where to start the program file</p> <p>Example: START 0x10000</p>
DEBUGPORT port [RECONNECT]	<p>The TCP port GDB uses to access the target. If the RECONNECT parameter is present, an open TCP/IP connection (Telnet/GDB) will be closed if there is a connect request from the same host (same IP address).</p> <p>port the TCP port number (default = 2001)</p> <p>Example: DEBUGPORT 2001</p>

PROMPT string	<p>This entry defines a new Telnet prompt. The current prompt can also be changed via the Telnet interface.</p> <p>Example: PROMPT ARM11></p>
DUMP filename	<p>The default file name used for the DUMP command from a Telnet session.</p> <p>filename the filename including the full path</p> <p>Example: DUMP dump.bin</p>
TELNET mode	<p>By default the BDI sends echoes for the received characters and supports command history and line editing. If it should not send echoes and let the Telnet client in "line mode", add this entry to the configuration file.</p> <p>mode ECHO (default), NOECHO or LINE</p> <p>Example: TELNET NOECHO ; use old line mode</p>

3.2.4 Part [FLASH]

The Telnet interface supports programming and erasing of flash memories. The bdiGDB system has to know which type of flash is used, how the chip(s) are connected to the CPU and which sectors to erase in case the ERASE command is entered without any parameter.

CHIPTYPE type	<p>This parameter defines the type of flash used. It is used to select the correct programming algorithm.</p> <p>format AM29F, AM29BX8, AM29BX16, I28BX8, I28BX16, AT49, AT49X8, AT49X16, STRATAX8, STRATAX16, MIRROR, MIRRORX8, MIRRORX16, M58X32, AM29DX16, AM29DX32</p> <p>Example: CHIPTYPE AM29F</p>
CHIPSIZE size	<p>The size of one flash chip in bytes (e.g. AM29F010 = 0x20000). This value is used to calculate the starting address of the current flash memory bank.</p> <p>size the size of one flash chip in bytes</p> <p>Example: CHIPSIZE 0x80000</p>
BUSWIDTH width	<p>Enter the width of the memory bus that leads to the flash chips. Do not enter the width of the flash chip itself. The parameter CHIPTYPE carries the information about the number of data lines connected to one flash chip. For example, enter 16 if you are using two AM29F010 to build a 16bit flash memory bank.</p> <p>with the width of the flash memory bus in bits (8 16 32)</p> <p>Example: BUSWIDTH 16</p>
FILE filename	<p>The default name of the file that is programmed into flash using the Telnet 'prog' command. This name is used to access the file via TFTP. If the filename starts with a \$, this \$ is replace with the path of the configuration file name. This name may be overridden interactively at the Telnet interface.</p> <p>filename the filename including the full path or \$ for relative path.</p> <p>Example: FILE F:\gnu\arm\bootrom.hex FILE \$bootrom.hex</p>
FORMAT format [offset]	<p>The format of the file and an optional address offset. The optional parameter "offset" is added to any load address read from the program file.</p> <p>format SREC, BIN, AOUT, ELF or COFF</p> <p>Example: FORMAT SREC FORMAT ELF 0x10000</p>
WORKSPACE address	<p>If a workspace is defined, the BDI uses a faster programming algorithm that runs out of RAM on the target system. Otherwise, the algorithm is processed within the BDI. The workspace is used for a 1kByte data buffer and to store the algorithm code. There must be at least 2kBytes of RAM available for this purpose.</p> <p>address the address of the RAM area</p> <p>Example: WORKSPACE 0x00000000</p>

ERASE addr [increment count] [mode [wait]]

The flash memory may be individually erased or unlocked via the Telnet interface. In order to make erasing of multiple flash sectors easier, you can enter an erase list. All entries in the erase list will be processed if you enter ERASE at the Telnet prompt without any parameter. This list is also used if you enter UNLOCK at the Telnet without any parameters. With the "increment" and "count" option you can erase multiple equal sized sectors with one entry in the erase list.

address	Address of the flash sector, block or chip to erase
increment	If present, the address offset to the next flash sector
count	If present, the number of equal sized sectors to erase
mode	BLOCK, CHIP, UNLOCK Without this optional parameter, the BDI executes a sector erase. If supported by the chip, you can also specify a block or chip erase. If UNLOCK is defined, this entry is also part of the unlock list. This unlock list is processed if the Telnet UNLOCK command is entered without any parameters.
wait	The wait time in ms is only used for the unlock mode. After starting the flash unlock, the BDI waits until it processes the next entry.

Example: ERASE 0xff040000 ;erase sector 4 of flash
 ERASE 0xff060000 ;erase sector 6 of flash
 ERASE 0xff000000 CHIP ;erase whole chip(s)
 ERASE 0xff010000 UNLOCK 100 ;unlock, wait 100ms
 ERASE 0xff000000 0x10000 7 ; erase 7 sectors

Example for the ARM PID7T board (AM29F010 in U12):

```
[FLASH]
WORKSPACE 0x00000000 ;Workspace in target RAM for faster programming algorithm
CHIPTYPE AM29F ;Flash type
CHIPSIZE 0x20000 ;The size of one flash chip in bytes
BUSWIDTH 8 ;The width of the flash memory bus in bits (8 | 16 | 32)
FILE C:\gdb\pid7t\bootrom.hex ;The file to program
ERASE 0x04000000 ;erase sector 0 of flash SIMM
ERASE 0x04004000 ;erase sector 1 of flash SIMM
ERASE 0x04008000 ;erase sector 2 of flash SIMM
ERASE 0x0400C000 ;erase sector 3 of flash SIMM
ERASE 0x04010000 ;erase sector 4 of flash SIMM
ERASE 0x04014000 ;erase sector 5 of flash SIMM
ERASE 0x04018000 ;erase sector 6 of flash SIMM
ERASE 0x0401C000 ;erase sector 7 of flash SIMM
```

the above erase list maybe replaced with:

```
ERASE 0x04000000 0x4000 8 ;erase 8 sectors
```

Supported Flash Memories:

There are currently 3 standard flash algorithm supported. The AMD, Intel and Atmel AT49 algorithm. Almost all currently available flash memories can be programmed with one of this algorithm. The flash type selects the appropriate algorithm and gives additional information about the used flash.

- For 8bit only flash: AM29F (MIRROR), I28BX8, AT49
- For 8/16 bit flash in 8bit mode: AM29BX8 (MIRRORX8), I28BX8 (STRATAX8), AT49X8
- For 8/16 bit flash in 16bit mode: AM29BX16 (MIRRORX16), I28BX16 (STRATAX16), AT49X16
- For 16bit only flash: AM29BX16, I28BX16, AT49X16
- For 16/32 bit flash in 16bit mode: AM29DX16
- For 16/32 bit flash in 32bit mode: AM29DX32
- For 32bit only flash: M58X32

Some newer Spansion MirrorBit flashes cannot be programmed with the MIRRORX16 algorithm because of the used unlock address offset. Use S29M32X16 for these flashes.

The AMD and AT49 algorithm are almost the same. The only difference is, that the AT49 algorithm does not check for the AMD status bit 5 (Exceeded Timing Limits).

Only the AMD and AT49 algorithm support chip erase. Block erase is only supported with the AT49 algorithm. If the algorithm does not support the selected mode, sector erase is performed. If the chip does not support the selected mode, erasing will fail. The erase command sequence is different only in the 6th write cycle. Depending on the selected mode, the following data is written in this cycle (see also flash data sheets): 0x10 for chip erase, 0x30 for sector erase, 0x50 for block erase.

To speed up programming of Intel Strata Flash and AMD MirrorBit Flash, an additional algorithm is implemented that makes use of the write buffer. This algorithm needs a workspace, otherwise the standard Intel/AMD algorithm is used.

The following table shows some examples:

Flash	x 8	x 16	x 32	Chipsize
Am29F010	AM29F	-	-	0x020000
Am29F800B	AM29BX8	AM29BX16	-	0x100000
Am29DL323C	AM29BX8	AM29BX16	-	0x400000
Am29PDL128G	-	AM29DX16	AM29DX32	0x01000000
Intel 28F032B3	I28BX8	-	-	0x400000
Intel 28F640J3A	STRATAX8	STRATAX16	-	0x800000
Intel 28F320C3	-	I28BX16	-	0x400000
AT49BV040	AT49	-	-	0x080000
AT49BV1614	AT49X8	AT49X16	-	0x200000
M58BW016BT	-	-	M58X32	0x200000
SST39VF160	-	AT49X16	-	0x200000
Am29LV320M	MIRRORX8	MIRRORX16	-	0x400000

Note:

Some Intel flash chips (e.g. 28F800C3, 28F160C3, 28F320C3) power-up with all blocks in locked state. In order to erase/program those flash chips, use the init list to unlock the appropriate blocks:

```
WM16  0xFFF00000  0x0060  unlock block 0
WM16  0xFFF00000  0x00D0
WM16  0xFFF10000  0x0060  unlock block 1
WM16  0xFFF10000  0x00D0
      . . . .
WM16  0xFFF00000  0xFFFF  select read mode
```

or use the Telnet "unlock" command:

```
UNLOCK [<addr> [<delay>]]
```

addr This is the address of the sector (block) to unlock

delay A delay time in milliseconds the BDI waits after sending the unlock command to the flash. For example, clearing all lock-bits of an Intel J3 Strata flash takes up to 0.7 seconds.

If "unlock" is used without any parameter, all sectors in the erase list with the UNLOCK option are processed.

To clear all lock-bits of an Intel J3 Strata flash use for example:

```
BDI> unlock 0xFF000000 1000
```

To erase or unlock multiple, continuous flash sectors (blocks) of the same size, the following Telnet commands can be used:

```
ERASE <addr> <step> <count>
UNLOCK <addr> <step> <count>
```

addr This is the address of the first sector to erase or unlock.

step This value is added to the last used address in order to get to the next sector. In other words, this is the size of one sector in bytes.

count The number of sectors to erase or unlock.

The following example unlocks all 256 sectors of an Intel Strata flash (28F256K3) that is mapped to 0x00000000. In case there are two flash chips to get a 32bit system, double the "step" parameter.

```
BDI> unlock 0x00000000 0x20000 256
```

3.2.5 Part [REGS]

In order to make it easier to access target registers via the Telnet interface, the BDI can read in a register definition file. In this file, the user defines a name for the register and how the BDI should access it (e.g. as memory mapped, memory mapped with offset, ...). The name of the register definition file and information for different registers type has to be defined in the configuration file.

The register name, type, address/offset/number and size are defined in a separate register definition file. This way, you can create one register definition file for a specific target processor that can be used for all possible positions of the internal memory map. You only have to change one entry in the configuration file.

An entry in the register definition file has the following syntax:

```
name    type    addr    size
```

name	The name of the register (max. 12 characters)		
type	The register type		
	GPR	General purpose register	
	CP15	Coprocessor 15 register	
	CP14	Coprocessor 14register	
		
	CP0	Coprocessor 0 register	
	MM	Absolute direct memory mapped register	
	DMM1...DMM4	Relative direct memory mapped register	
	IMM1...IMM4	Indirect memory mapped register	
	APB	APB memory mapped register	
addr	The address, offset or number of the register		
size	The size (8, 16, 32) of the register, default is 32		

The following entries are supported in the [REGS] part of the configuration file:

FILE filename	The name of the register definition file. This name is used to access the file via TFTP. The file is loaded once during BDI startup.		
	filename	the filename including the full path	
	Example:	FILE C:\bdi\regs\reg40400.def	
DMMn base	This defines the base address of direct memory mapped registers. This base address is added to the individual offset of the register.		
	base	the base address	
	Example:	DMM1 0x01000	
IMMn addr data	This defines the addresses of the memory mapped address and data registers of indirect memory mapped registers. The address of a IMMn register is first written to "addr" and then the register value is access using "data" as address.		
	addr	the address of the Address register	
	data	the address of the Data register	
	Example:	IMM1 0x04700000 0x04700004	

Example for a register definition:

Entry in the configuration file:

```
[REGS]
FILE          E:\cygwin\home\bdidemo\arm\reg1136.def
```

The register definition file:

```
;
;Coprocessor Register Numbers:
;
;      +-----+-----+-----+-----+
;      |opc_2|0| CRm |opc_1|0|  nbr |
;      +-----+-----+-----+-----+
;
;The 16bit register number is used to build the appropriate MCR/MRC instruction.
;
;
;name          type          addr          size
;-----
;
id             CP15          0x0000          32      ;ID code
cache         CP15          0x2000          32      ;Cache type
tcmstatus     CP15          0x4000          32      ;TCM status
tcmtype       CP15          0x6000          32      ;TCM type
;
ctr           CP15          0x0001          32      ;Control
aux           CP15          0x2001          32      ;Auxiliary Control
cpacc        CP15          0x4001          32      ;Coprocessor Access
;
ttb0          CP15          0x0002          32      ;Translation Table Base 0
ttb1          CP15          0x2002          32      ;Translation Table Base 1
ttbc         CP15          0x4002          32      ;Translation Table Base Control
;
pid           CP15          0x000d          32      ;Process ID
context       CP15          0x200d          32      ;Context ID
;
;
; CM1136JF-S core module control registers
;
cm_id         MM             0x10000000
cm_proc       MM             0x10000004
cm_osc        MM             0x10000008
cm_ctrl       MM             0x1000000c
cm_stat       MM             0x10000010
;
;
;
; Cortex-A8 debug registers
dscr          APB           0xd4011088          ;Debug Status and Control
prcr          APB           0xd4011310          ;Device Power Down and Reset Control
prsr          APB           0xd4011314          ;Device Power Down and Reset Status
authstatus    APB           0xd4011fb8          ;Authentication Status
devid         APB           0xd4011fc8          ;Device Identifier
devtype       APB           0xd4011fcc          ;Device type
;
```

3.3 Debugging with GDB

Because the target agent runs within BDI, no debug support has to be linked to your application. There is also no need for any BDI specific changes in the application sources. Your application must be fully linked because no dynamic loading is supported.

3.3.1 Target setup

Target initialization may be done at two places. First with the BDI configuration file, second within the application. The setup in the configuration file must at least enable access to the target memory where the application will be loaded. Disable the watchdog and setting the CPU clock rate should also be done with the BDI configuration file. Application specific initializations like setting the timer rate are best located in the application startup sequence.

3.3.2 Connecting to the target

As soon as the target comes out of reset, BDI initializes it and loads your application code. If RUN is selected, the application is immediately started, otherwise only the target PC is set. BDI now waits for GDB request from the debugger running on the host.

After starting the debugger, it must be connected to the remote target. This can be done with the following command at the GDB prompt:

```
(gdb)target remote bdi2000:2001
```

bdi2000 This stands for an IP address. The HOST file must have an appropriate entry. You may also use an IP address in the form xxx.xxx.xxx.xxx

2001 This is the TCP port used to communicate with the BDI

If not already suspended, this stops the execution of application code and the target CPU changes to background debug mode.

Remember, every time the application is suspended, the target CPU is freezed. During this time no hardware interrupts will be processed.

Note: For convenience, the GDB detach command triggers a target reset sequence in the BDI.

```
(gdb)...
```

```
(gdb)detach
```

```
... Wait until BDI has resetet the target and reloaded the image
```

```
(gdb)target remote bdi2000:2001
```

Note:

GDB sometimes fails to connect to the target after a reset because it tries to read an invalid stack frame. With the following init list entries you can work around this GDB startup problem:

```
WGPR    11           0x00000020 ;set frame pointer to free RAM
WM32    0x00000020  0x00000028 ;dummy stack frame
```

3.3.3 Breakpoint Handling

There are two breakpoint modes supported. One of them (SOFT) is implemented by replacing application code with a BKPT instruction. The other (HARD) uses the built in breakpoint logic. If HARD is selected, only up to 6 breakpoints can be active at the same time.

The following example selects SOFT as the breakpoint mode:

```
BREAKMODE SOFT ;SOFT or HARD, HARD uses hardware breakpoints
```

The BDI supports only a GDB version that uses a Z-Packet to set breakpoints (GDB Version 5.0 or newer). GDB tells the BDI to set / clear breakpoints with this special protocol unit. The BDI will respond to this request by replacing code in memory with the BKPT instruction or by setting the appropriate hardware breakpoint.

3.3.4 GDB monitor command

The BDI supports the GDB V5.x "monitor" command. Telnet commands are executed and the Telnet output is returned to GDB.

```
(gdb) target remote bdi2000:2001
Remote debugging using bdi2000:2001
0x10b2 in start ()
(gdb) monitor md 0 1
00000000 : 0xe59ff018 - 442503144 ...
```

3.3.5 Target serial I/O via BDI

A RS232 port of the target can be connected to the RS232 port of the BDI2000. This way it is possible to access the target's serial I/O via a TCP/IP channel. For example, you can connect a Telnet session to the appropriate BDI2000 port. Connecting GDB to a GDB server (stub) running on the target should also be possible.

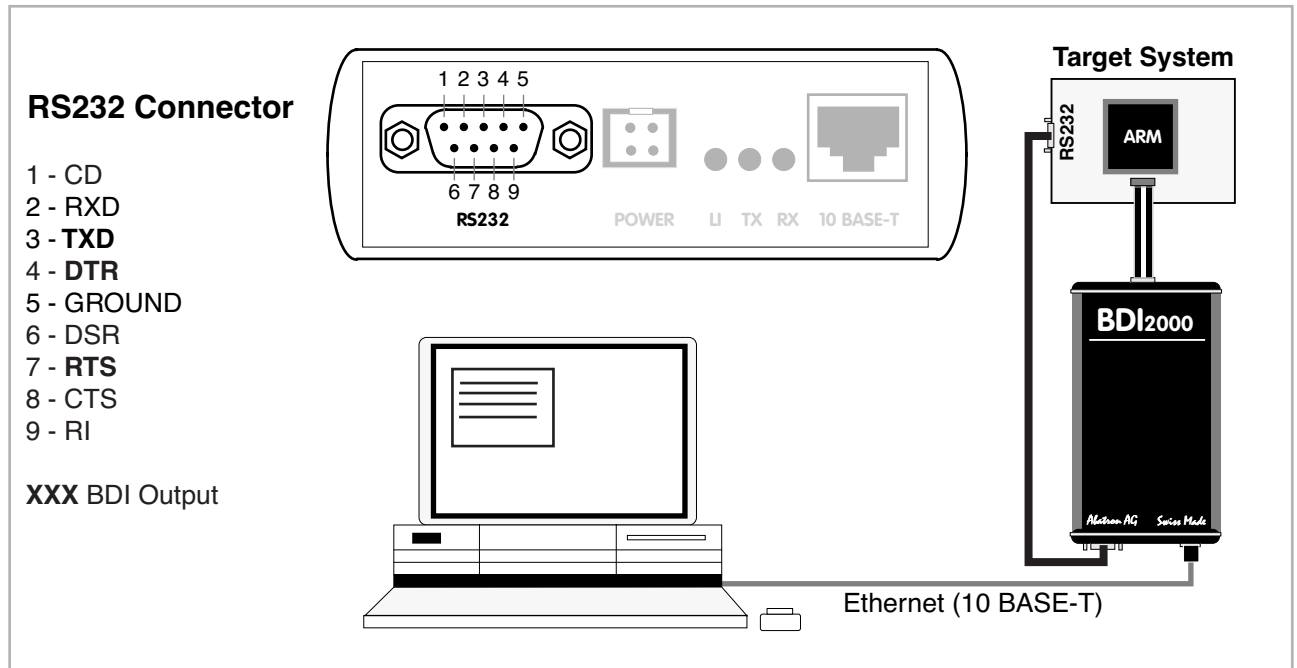

The configuration parameter "SIO" is used to enable this serial I/O routing. The BDI asserts RTS and DTR when a TCP connection is established.

```
[TARGET]
....
SIO 7 9600 ;Enable SIO via TCP port 7 at 9600 baud
```

Warning!!!

Once SIO is enabled, connecting with the setup tool to update the firmware will fail. In this case either disable SIO first or disconnect the BDI from the LAN while updating the firmware.

3.3.6 Target DCC I/O via BDI

It is possible to route a TCP/IP port to the ARM's debug communication channel (DCC). This way, the application running on the target can output messages via DCC that are displayed for example in a Telnet window. The BDI routes every byte received via DCC to the connected TCP/IP channel and vice versa. Below some simple functions you can link to your application in order to implement IO via DCC.

```
#define DSCR_WDTR_FULLL (1L<<29)
#define DSCR_RDTR_FULLL (1L<<30)

static unsigned int read_dtr(void)
{
    unsigned int c;

    __asm__ volatile(
        "mrc p14, 0, %0, c0, c5\n"
        : "=r" (c));
    return c;
}

static void write_dtr(unsigned int c)
{
    __asm__ volatile(
        "mcr p14, 0, %0, c0, c5\n"
        : "r" (c));
}

static unsigned int read_dscr(void)
{
    unsigned int ret;

    __asm__ volatile(
        "mrc p14, 0, %0, c0, c1\n"
        : "=r" (ret));
    return ret;
}

void write_dcc_char(unsigned int c)
{
    while(read_dscr() & DSCR_WDTR_FULLL);
    write_dtr(c);
}

unsigned int read_dcc_char(void)
{
    while(!(read_dscr() & DSCR_RDTR_FULLL));
    return read_dtr();
}

void write_dcc_string(const char* s)
{
    while (*s) write_dcc_char(*s++);
}
```

3.4 Telnet Interface

A Telnet server is integrated within the BDI. The Telnet channel is used by the BDI to output error messages and other information. Also some basic debug tasks may be done by using this interface. Enter help at the Telnet command prompt to get a list of the available commands.

Telnet Debug features:

- Display and modify memory locations
- Display and modify registers
- Single step a code sequence
- Set hardware breakpoints (for code and data accesses)
- Load a code file from any host
- Start / Stop program execution
- Programming and Erasing Flash memory

During debugging with GDB, the Telnet is mainly used to reboot the target (generate a hardware reset and reload the application code). It may be also useful during the first installation of the bdiGDB system or in case of special debug needs.

Multiple commands separated by a semicolon can be entered on one line.

Example of a Telnet session:

```
ARM1136>info
Core number      : 0
Core state       : debug mode (ARM)
Debug entry cause : Vector Catch (RESET)
Current PC       : 0x00000000
Current CPSR     : 0x000001d3 (Supervisor)
ARM1136>rd
GPR00: 000000fc f1c72a88 ff5ffdf7 3bb15ae6
GPR04: f87f47f7 3c7c6959 ba398649 ddf6fed
GPR08: fff3a7b1 ff3defdf fafb5fff fb99eb7d
GPR12: bdfedbf 7edfffd7 8ce356cf 00000000
PC : 00000000 CPSR: 000001d3
ARM1136>md 0
00000000 : 3de37365 ddaf8e8b 70a66636 52d11411 es.=...6f.p...R
00000010 : b672ee06 d6a94323 6e73fd29 a8d6e9a1 ..r.#C..).sn....
00000020 : 8f0a1aad 6c1a840f e1b1de9d 802e4839 .....l....9H..
00000030 : 9f9c2afa 9b818b86 63fdbab8 f2a63b91 .*.....c;...
00000040 : 440f75a4 fa7b254e c5efff5b 8f4829a5 .u.DN%{.[.....)H.
.....
```

Notes:

The DUMP command uses TFTP to write a binary image to a host file. Writing via TFTP on a Linux/Unix system is only possible if the file already exists and has public write access. Use "man tftpd" to get more information about the TFTP server on your host.

3.4.1 Command list

```

"MD    [<address>] [<count>]  display target memory as word (32bit)",
"MDH  [<address>] [<count>]  display target memory as half word (16bit)",
"MDB  [<address>] [<count>]  display target memory as byte (8bit)",
"DUMP <addr> <size> [<file>] dump target memory to a file",
"MM   <addr> <value> [<cnt>] modify word(s) (32bit) in target memory",
"MMH  <addr> <value> [<cnt>] modify half word(s) (16bit) in target memory",
"MMB  <addr> <value> [<cnt>] modify byte(s) (8bit) in target memory",
"MT   <addr> <count>       memory test",
"MC   [<address>] [<count>]  calculates a checksum over a memory range",
"MV                                       verifies the last calculated checksum",
"RD   [<name>]              display general purpose or user defined register",
"RDUMP [<file>]             dump all user defined register to a file",
"RDALL                                display all ARM registers ",
"RDCP [<cp>] <number>      display CP register, default is CP15",
"RDFP                                display floating point register",
"RM   {<nbr>|<name>} <value> modify general purpose or user defined register",
"RMCP [<cp>] <number><value> modify CP register, default is CP15",
"DTLB <from> [<to>]        display Data TLB entries",
"ITLB <from> [<to>]        display Inst TLB entries",
"LTLB <from> [<to>]        ARM11: display Lockable Main TLB entries",
"ATLB <from> [<to>]        ARM11: display Set-Associative Main TLB entries",
"DTAG <from> [<to>]        display L1 Data Cache Tag(s) ",
"ITAG <from> [<to>]        display L1 Inst Cache Tag(s) ",
"BOOT                                reset the BDI and reload the configuration",
"RESET [HALT | RUN [time]]  reset the target system, change startup mode",
"GO   [<pc>]                set PC and start current core",
"GO   <n> <n> [<n>[<n>]]    start multiple cores in requested order",
"TI   [<pc>]                single step an instruction",
"HALT [<n>[<n>[<n>[<n>]]]]  force core(s) to debug mode (n = core number)",
"BI   <addr>                set instruction breakpoint",
"CI   [<id>]                clear instruction breakpoint(s)",
"BD   [R|W] <addr>          set data watchpoint (32bit access)",
"BDH  [R|W] <addr>          set data watchpoint (16bit access)",
"BDB  [R|W] <addr>          set data watchpoint ( 8bit access)",
"CD   [<id>]                clear data watchpoint(s)",
"INFO                                display information about the current state",
"LOAD  [<offset>] [<file> [<format>]] load program file to target memory",
"VERIFY [<offset>] [<file> [<format>]] verify a program file to target memory",
"PROG  [<offset>] [<file> [<format>]] program flash memory",
"                                           <format> : SREC, BIN, AOUT, ELF or COFF",
"ERASE [<address> [<mode>]] erase a flash memory sector, chip or block",
"                                           <mode> : CHIP, BLOCK or SECTOR (default is sector)",
"ERASE <addr> <step> <count> erase multiple flash sectors",
"UNLOCK [<addr> [<delay>]]  unlock a flash sector",
"UNLOCK <addr> <step> <count> unlock multiple flash sectors",
"FLASH <type> <size> <bus> change flash configuration",
"FENA  <addr> <size>        enable autoamtic programming to flash memory",
"FDIS                                disable autoamtic programming to flash memory",
"DELAY <ms>                    delay for a number of milliseconds",
"MEMACC {CORE | AHB [<hprot>]} Cortex-A8: select memory access mode",
"SELECT <core>                  change the current core",
"HOST  <ip>                     change IP address of program file host",
"PROMPT <string>                defines a new prompt string",
"CONFIG                                display or update BDI configuration",
"CONFIG <file> [<hostIP> [<bdiIP> [<gateway> [<mask>]]]]",
"HELP                                display command list",
"QUIT                                terminate the Telnet session"

```

3.4.2 CPxx Registers

Via Telnet it is possible to access the Coprocessor 15,14,13 registers. Following the Telnet commands that are used to access CP registers:

```
"RDCP <number>          display control processor 15 register",
"RDCP 15 <number>       display control processor 15 register",
"RDCP 14 <number>       display control processor 14 register",
"RDCP 13 <number>       display control processor 13 register",
....

"RMCP <number> <value>  modify control processor 15 register",
"RMCP 15 <number> <value> modify control processor 15 register",
"RMCP 14 <number> <value> modify control processor 14 register",
"RMCP 13 <number> <value> modify control processor 13 register",
....
```

The parameter number selects the CPxx register. This parameter is used to build the appropriate MCR or MRC instruction.

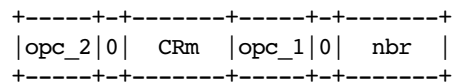

Some examples:

CP15 : ID register (CRn = 0, opcode_2 = 0)

```
BDI> rdcp 15 0x0000
```

CP15 : Cache Type (CRn = 0, opcode_2 = 1)

```
BDI> rdcp 15 0x2000
```

CP15 : Invalidate I cache line (CRn = 7, opcode_2 = 1, CRm = 5)

```
BDI> rmcp 15 0x2507 0xA0000000
```

3.5 Multi-Core Support

The bdiGDB system supports concurrent debugging of up to 4 ARM cores (same family) connected to the same JTAG scan chain. For every core you can start its own GDB session. The default port numbers used to attach the remote targets are 2001 ... 2004. In the Telnet you switch between the cores with the command "select <0..3>". In the configuration file, simply begin the line with the appropriate core number. If there is no #n in front of a line, the BDI assumes core #0.

The following example defines two cores on the scan chain.

```
[TARGET]
CLOCK      1          ;JTAG clock (0=Adaptive, 1=8MHz, 2=4MHz, 3=2MHz)
WAKEUP     1000      ;wakeup time after reset

#0 CPUTYPE  ARM1136
#0 SCANPRED 0 0      ;JTAG devices connected before this core
#0 SCANSUCC 1 4      ;JTAG devices connected after this core
#0 VECTOR   CATCH    ;catch unhandled exceptions
#0 BREAKMODE SOFT    ;SOFT or HARD
#0 DCC      8        ;DCC I/O via TCP port 8

#1 CPUTYPE  ARM1136
#1 SCANPRED 1 4      ;JTAG devices connected before this core
#1 SCANSUCC 0 0      ;JTAG devices connected after this core
#1 VECTOR   CATCH    ;catch unhandled exceptions
#1 BREAKMODE SOFT    ;SOFT or HARD
#1 DCC      7        ;DCC I/O via TCP port 7
```

Note:

It is not possible to concurrent debug an ARM11 and a Cortex-A8 core even if they are located on the same scan chain.

4 Specifications

Operating Voltage Limiting	5 VDC \pm 0.25 V
Power Supply Current	typ. 500 mA max. 1000 mA
RS232 Interface: Baud Rates	9'600, 19'200, 38'400, 57'600, 115'200
Data Bits	8
Parity Bits	none
Stop Bits	1
Network Interface	10 BASE-T
Serial Transfer Rate between BDI and Target	up to 16 Mbit/s
Supported target voltage	1.8 – 5.0 V (3.0 – 5.0 V with Rev. A/B)
Operating Temperature	+ 5 °C ... +60 °C
Storage Temperature	-20 °C ... +65 °C
Relative Humidity (noncondensing)	<90 %rF
Size	190 x 110 x 35 mm
Weight (without cables)	420 g
Host Cable length (RS232)	2.5 m

Specifications subject to change without notice

5 Environmental notice



Disposal of the equipment must be carried out at a designated disposal site.

6 Declaration of Conformity (CE)

CE

DECLARATION OF CONFORMITY

This declaration is valid for following product:

Type of device: BDM/JTAG Interface
Product name: BDI2000

The signing authorities state, that the above mentioned equipment meets the requirements for emission and immunity according to

EMC Directive 89/336/EEC

The evaluation procedure of conformity was assured according to the following standards:

EN 50081-2
EN 50082-2

This declaration of conformity is based on the test report no. QNL-E853-05-8-a of QUINEL, Zug, accredited according to EN 45001.

Manufacturer:

ABATRON AG
Stöckenstrasse 4
CH-6221 Rickenbach

Authority:

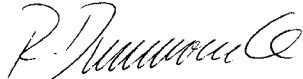
Max Vock
Marketing Director

Ruedi Dummermuth
Technical Director

Rickenbach, May 30, 1998

7 Warranty

ABATRON Switzerland warrants the physical diskette, cable, BDI2000 and physical documentation to be free of defects in materials and workmanship for a period of 24 months following the date of purchase when used under normal conditions.

In the event of notification within the warranty period of defects in material or workmanship, ABATRON will replace defective diskette, cable, BDI2000 or documentation. The remedy for breach of this warranty shall be limited to replacement and shall not encompass any other damages, including but not limited loss of profit, special, incidental, consequential, or other similar claims.

ABATRON Switzerland specifically disclaims all other warranties- expressed or implied, including but not limited to implied warranties of merchantability and fitness for particular purposes - with respect to defects in the diskette, cable, BDI2000 and documentation, and the program license granted herein, including without limitation the operation of the program with respect to any particular application, use, or purposes. In no event shall ABATRON be liable for any loss of profit or any other commercial damage, including but not limited to special, incidental, consequential, or other damages.

Failure in handling which leads to defects are not covered under this warranty. The warranty is void under any self-made repair operation except exchanging the fuse.

Appendices

A Troubleshooting

Problem

The firmware can not be loaded.

Possible reasons

- The BDI is not correctly connected with the target system (see chapter 2).
- The power supply of the target system is switched off or not in operating range (4.75 VDC ... 5.25 VDC) --> MODE LED is OFF or RED
- The built in fuse is damaged --> MODE LED is OFF
- The BDI is not correctly connected with the Host (see chapter 2).
- A wrong communication port (Com 1...Com 4) is selected.

Problem

No working with the target system (loading firmware is ok).

Possible reasons

- Wrong pin assignment (BDM/JTAG connector) of the target system (see chapter 2).
- Target system initialization is not correctly --> enter an appropriate target initialization list.
- An incorrect IP address was entered (BDI2000 configuration)
- BDM/JTAG signals from the target system are not correctly (short-circuit, break, ...).
- The target system is damaged.

Problem

Network processes do not function (loading the firmware was successful)

Possible reasons

- The BDI2000 is not connected or not correctly connected to the network (LAN cable or media converter)
- An incorrect IP address was entered (BDI2000 configuration)

B Maintenance

The BDI needs no special maintenance. Clean the housing with a mild detergent only. Solvents such as gasoline may damage it.

If the BDI is connected correctly and it is still not responding, then the built in fuse might be damaged (in cases where the device was used with wrong supply voltage or wrong polarity). To exchange the fuse or to perform special initialization, please proceed according to the following steps:

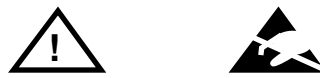

Observe precautions for handling (Electrostatic sensitive device)
Unplug the cables before opening the cover.
Use exact fuse replacement (Microfuse MSF 1.6 AF).

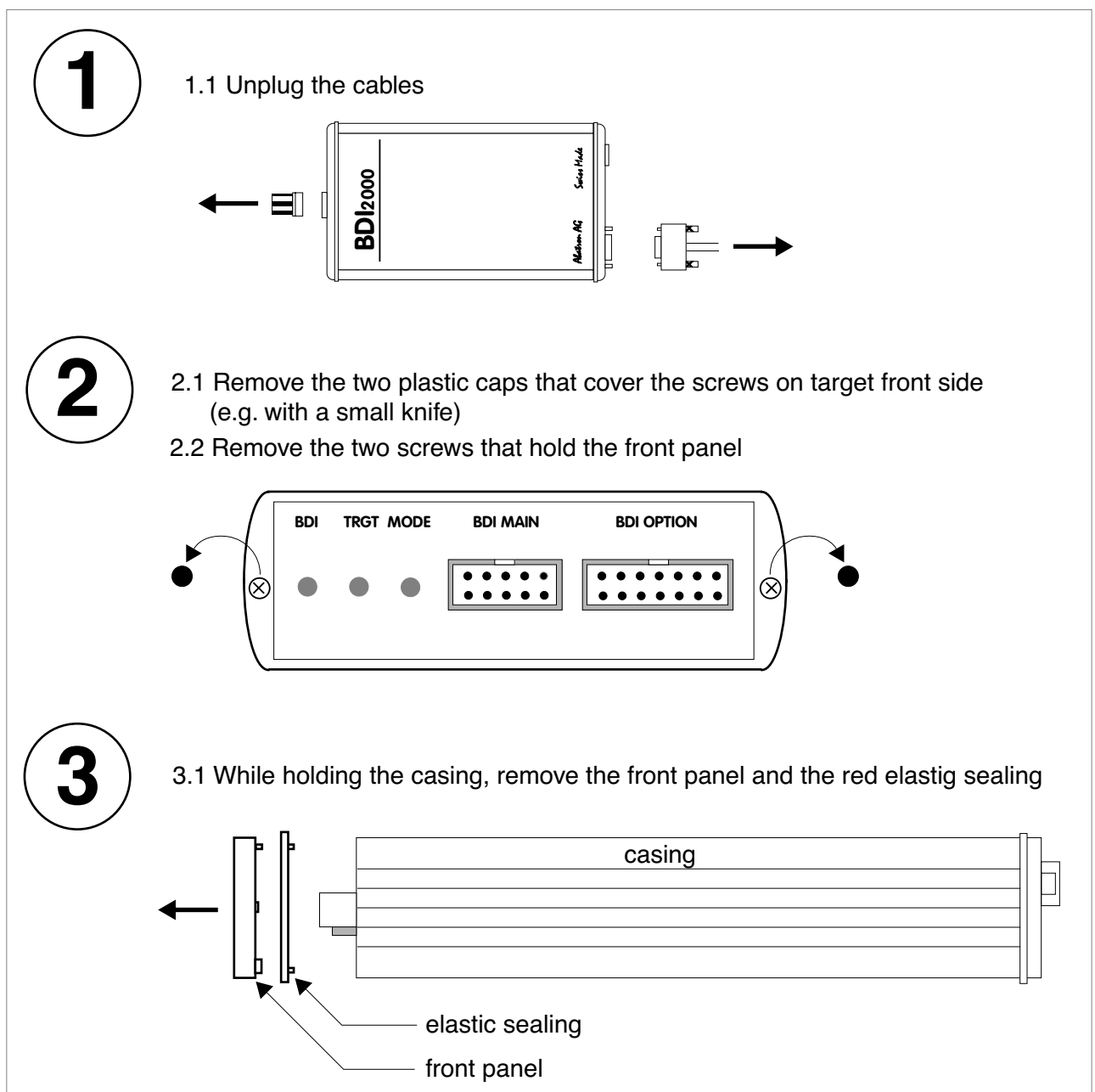

4

4.1 While holding the casing, slide carefully the print in position as shown in figure below

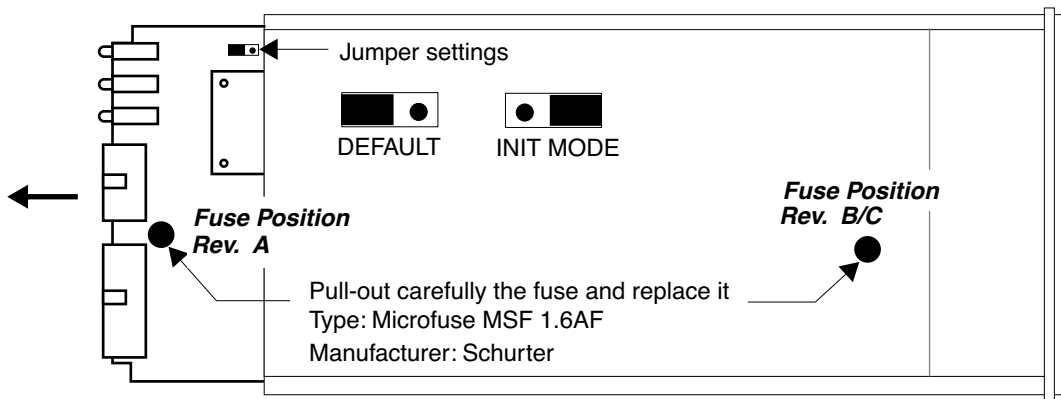

5

Reinstallation

5.1 Slide back carefully the print. Check that the LEDs align with the holes in the back panel.

5.2 Push carefully the front panel and the red elastic sealing on the casing. Check that the LEDs align with the holes in the front panel and that the position of the sealing is as shown in the figure below.

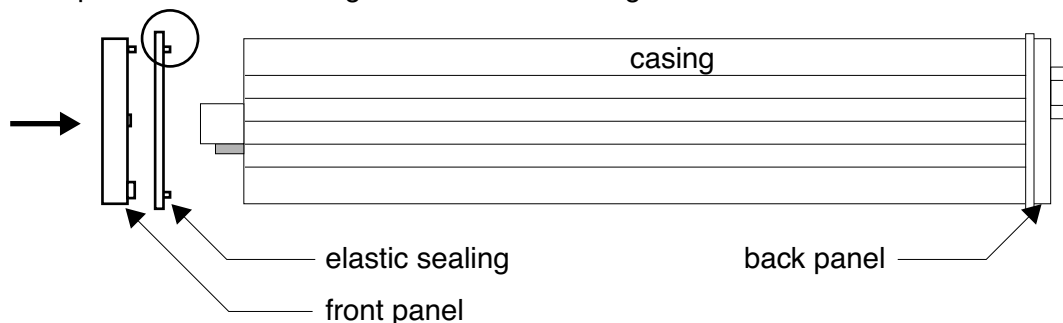

5.3 Mount the screws (do not overtighten it)

5.4 Mount the two plastic caps that cover the screws

5.5 Plug the cables



**Observe precautions for handling (Electrostatic sensitive device)
Unplug the cables before opening the cover.
Use exact fuse replacement (Microfuse MSF 1.6 AF).**

C Trademarks

All trademarks are property of their respective holders.