

Agilent Technologies 8935 Series E6380A CDMA Cellular/PCS Base Station Test Set

Reference Guide

Firmware Version: B.03.10 and above



Agilent Technologies

Agilent Part Number E6380-90019

Revision F

Printed in UK

January 2001

Notice

Information contained in this document is subject to change without notice.

All Rights Reserved. Reproduction, adaptation, or translation without prior written permission is prohibited, except as allowed under the copyright laws.

This material may be reproduced by or for the U.S. Government pursuant to the Copyright License under the clause at DFARS 52.227-7013 (APR 1988).

© Copyright 2001 Agilent Technologies

Contents

1. General Information

| | |
|---|----|
| Manufacturer's Declaration | 14 |
| Lifting and Handling | 18 |
| Consumables | 18 |
| Product Markings | 19 |
| Certification | 20 |
| Agilent Technologies Warranty Statement for Commercial Products | 22 |
| E6380A CDMA/Cellular PCS Base Station Test Set | 22 |
| Assistance | 24 |
| Power Cables | 25 |
| Product Description | 33 |
| Documentation | 35 |
| Conventions Used in This Manual | 35 |
| What is in This Manual | 35 |
| Which Document is Required? | 36 |
| Trademark Acknowledgments | 37 |

2. Getting Started

| | |
|--|----|
| Before Connecting a Radio | 41 |
| Changing the Test Set's Display | 42 |
| Changing the Measurement Screen | 42 |
| Changing the Control Fields | 44 |
| How do I Verify that the Test Set is Operating Properly? | 49 |
| Instrument Quick Check | 49 |

3. Operating Overview

| | |
|--|----|
| Displaying CDMA Measurements | 53 |
| Channel Power, Adjacent Channel Power (ACP), Rho, Error Vector Magnitude (EVM), Average Power | 53 |
| Code Domain Measurements (Power, Fast Power, Power & Noise, Complex Power, Phase, Timing, Fast Power Synchronization) | 54 |
| I/Q Diagram | 55 |
| Displaying Analog Measurements | 56 |
| RF Measurements | 56 |
| Displaying AF Measurements | 57 |
| Displaying Measurement Results on a Meter Scale | 59 |
| To display the meter scale | 59 |
| To set the meter's end points and scale intervals | 59 |
| Using Channel Numbers to Set Analyzer and Generator Frequencies | 60 |
| Calibrating the Channel Power Measurement – CDMA Analyzer | 61 |
| Calibrating the Channel Power Measurement – Code Domain | 62 |
| Calibrating the Adjacent Channel Power (ACP) Measurement | 63 |
| Changing the Increment or Decrement Setting | 64 |
| Specifying An Increment Value for the Arrow Keys or Knob | 64 |
| Using the Factor of 10 Increment/Decrement Keys | 64 |
| Using Measurement Limit Indicators | 65 |
| To set high and low limits | 65 |
| To reset or remove limits | 65 |

Contents

| | |
|--|-----------|
| To remove a limit | 66 |
| Setting A Measurement Reference | 67 |
| To set a reference | 67 |
| Averaging Measurements | 68 |
| To use measurement averaging | 68 |
| How the Test Set Averages Measurements | 68 |
| Setting an RF Generator/Analyzer Offset | 69 |
| To set an RF Offset | 69 |
| Saving and Recalling Instrument Setups | 70 |
| To save an instrument setup | 70 |
| To recall an instrument setup | 70 |
| To remove (clear) an individual save register | 71 |
| To clear all save registers | 71 |
| Register Names | 71 |
| Memory Considerations | 72 |
| Instrument Hardware Changes | 72 |
| Using USER Keys | 73 |
| Using Pre-Defined USER Keys | 73 |
| Assigning and Releasing USER Keys | 74 |
| Replacing Batteries | 75 |

4. Overview of the Test Set's

Built-In Tools

| | |
|--|------------|
| Using the RF Tools Program | 79 |
| Loading and Running RF Tools | 80 |
| Test Results/BTS Utility Setup | 81 |
| Swept Gain | 83 |
| Discrete Frequency Insertion Loss | 87 |
| Swept Insertion Loss | 89 |
| Swept Return Loss | 92 |
| Cable Fault | 97 |
| Replot Data Files | 102 |
| Transfer Stored Data | 104 |
| SA (Spectrum Analyzer) Self Calibration ON/OFF | 105 |
| Catalog PC (Memory) Card | 106 |
| Using the Code Domain Analyzer | 108 |
| Selecting the Code Domain Analyzer's Controls Menus | 108 |
| Using the Spectrum Analyzer | 111 |
| Automatic Calibration | 111 |
| Setting Resolution Bandwidth and Sweep Rate | 111 |
| Selecting the Spectrum Analyzer's Controls Menus | 112 |
| Using the Spectrum Analyzer's Delta Markers | 113 |
| Using the Spectrum Analyzer Mask | 115 |
| Using the Voltmeter and Audio Frequency Counter | 118 |
| Using the Oscilloscope (Scope) | 119 |
| Selecting the Oscilloscope's Input | 120 |
| Selecting the Oscilloscope's Filters | 121 |
| Triggering the Oscilloscope | 121 |
| Using the Oscilloscope's Marker | 121 |

Contents

| | |
|---|-----|
| Using IB_UTIL Programs | 122 |
| COPY_PL | 122 |
| FILE_XFER | 122 |
| RAM_USAGE | 122 |
| Securing a Test Procedure | 123 |
| Clearing RAM | 124 |
| Using the LISTOPTS (list options) Program | 125 |
| Using the DEMO Program | 126 |
| Using the ST_PLT (store or plot) Program | 127 |

5. CDMA Measurements - Screens and Control Fields

| | |
|---|-----|
| CDMA Measurements | 131 |
| Average Power Measurements | 131 |
| Adjacent Channel Power Measurements | 132 |
| Channel Power Measurements | 132 |
| Rho Measurements | 133 |
| Error Vector Magnitude (EVM) Measurements | 138 |
| Code Domain Measurements – IS-95 | 139 |
| Code Domain Measurements – IS-2000 | 142 |
| IQ Constellation Diagram, IS-2000 only | 149 |
| PN Offset Search | 149 |
| Control Fields for CDMA Measurements | 150 |
| # of Frames | 150 |
| ACP Cal | 150 |
| ACP Fltr BW | 150 |
| ACP Offset | 151 |
| ADCfs or ADC FS | 151 |
| Amplitude | 151 |
| Analyzer (CDMA analyzer) | 152 |
| Analyzer (code domain analyzer) | 152 |
| Anl Dir | 152 |
| Anl Special | 153 |
| Auto Zero | 153 |
| Carrier FT or Carrier Feedthru | 153 |
| Chan Num | 153 |
| Chan Size | 154 |
| CD pwr unit | 154 |
| Chn Pwr Cal | 154 |
| Controls | 155 |
| CW RF Path | 155 |
| Data Rate | 156 |
| Data Source | 157 |
| Even Sec In | 158 |
| Find PN | 158 |
| Freq Err | 158 |
| Gain | 159 |
| Gen Dir | 159 |
| Gen Mode | 160 |

Contents

| | |
|---------------------------|-----|
| Gen Special | 160 |
| Input Atten | 161 |
| Input Port | 161 |
| Lvl | 161 |
| I Power Level | 162 |
| Marker Lvl | 162 |
| Marker Pos | 162 |
| Meas Intvl or Meas Int | 162 |
| Meas Order | 163 |
| Measurement | 163 |
| Num Avgs | 163 |
| Ofs Transfer | 164 |
| Output Port | 164 |
| Phase/div | 164 |
| Phse | 165 |
| PN Incrment | 165 |
| PN Offset | 165 |
| PN Offset or PN Ofs | 166 |
| Pwr Gain | 166 |
| Pwr Intvl | 167 |
| Pwr Ref | 167 |
| Pwr Scale – IS-95 | 167 |
| Pwr Scale – IS-2000 | 167 |
| Pwr Zero | 168 |
| Q Power Level | 168 |
| Qual Event | 168 |
| Rate RC-3 | 169 |
| Rate RC-4 | 169 |
| Rate RC-5 | 169 |
| RF Channel | 170 |
| RF Gen Freq | 170 |
| RF In/Ant | 170 |
| Sprd Fact (Spread Factor) | 171 |
| Start Frame | 171 |
| Threshold | 171 |
| Time | 172 |
| Time/div | 172 |
| Time Offset | 173 |
| Time Ofs | 173 |
| Trig Event | 174 |
| Tune Freq | 174 |
| Walsh Chan | 175 |
| Walsh Order | 175 |

6. Analog Measurements - Screens and Control Fields

| | |
|----------------------|-----|
| Analog Measurements | 179 |
| AC Control | 179 |
| AM Depth Measurement | 179 |
| AF Freq Measurement | 180 |

Contents

| | |
|---|------------|
| DC Level Measurement | 180 |
| Distn (Distortion) Measurement | 181 |
| FM Deviation Measurement | 181 |
| Frequency Measurement | 182 |
| Frequency Error Measurement | 182 |
| TX Power Measurement | 183 |
| FM Deviation Measurement | 183 |
| SINAD Measurement | 184 |
| SNR Measurement | 184 |
| Control Fields for Analog Measurements | 185 |
| #Pts | 185 |
| AF Anl In | 185 |
| AF Cnt Gate | 186 |
| AFGen1 Freq | 186 |
| AFGen1 To | 187 |
| AFGen2 Freq | 187 |
| AFGen2 To | 188 |
| Amplitude | 189 |
| Atten Hold | 189 |
| Audio In Lo | 190 |
| Audio Out | 190 |
| Auto/Norm | 190 |
| Auto Zero | 191 |
| BW= | 191 |
| Center Freq | 191 |
| Controls | 192 |
| Cont/Single | 192 |
| DC FM Zero | 192 |
| De-Emp Gain | 192 |
| De-Emphasis | 192 |
| Detector | 193 |
| Display | 193 |
| Edit Mask | 194 |
| EditPt | 194 |
| Ext Load R | 195 |
| Ext (TTL) | 195 |
| Filter 1 | 195 |
| Filter 2 | 196 |
| FM Coupling | 196 |
| Freq (Delta Mrkr) | 197 |
| Freq (mask) | 197 |
| Freq (normal marker) | 198 |
| Freq (Ref Mrkr) | 198 |
| Gain Cntl | 199 |
| IF Filter | 199 |
| Input Atten | 200 |
| Input Gain | 200 |
| Input Port | 201 |
| Internal | 201 |

Contents

| | |
|---|-----|
| Level (div) | 202 |
| Level (mask) | 202 |
| Lvl (Delta Mrkr) | 202 |
| Lvl (marker) | 203 |
| Lvl (normal marker) | 203 |
| Lvl (Ref Mrkr) | 204 |
| Marker To Peak+ | 204 |
| Marker To Peak- | 204 |
| Marker To | 205 |
| Mask Beep | 205 |
| Mask Type | 205 |
| Mod In To | 206 |
| No Pk/Avg | 206 |
| Normalize | 207 |
| Norm/Delta | 207 |
| Notch Freq | 208 |
| Notch Gain | 208 |
| Offset Freq | 208 |
| Output Port | 209 |
| Pk Det To | 209 |
| Port/Sweep | 210 |
| Position | 210 |
| Pos/Neg | 211 |
| Ref Level | 211 |
| Ref Mrkr | 211 |
| Reset | 212 |
| RF Channel | 212 |
| RF Cnt Gate | 212 |
| RF Gen Freq | 213 |
| RF In/Ant | 213 |
| Scope To | 214 |
| Sensitivity (RF analyzer) | 214 |
| Sensitivity (spectrum analyzer) | 215 |
| Settling | 215 |
| Span | 216 |
| Speaker ALC | 216 |
| Speaker Vol | 216 |
| Squelch | 217 |
| Time | 218 |
| Time/div | 218 |
| Track/Fixed | 218 |
| Trig-Delay | 219 |
| Tune Freq | 220 |
| TX Pwr Meas | 220 |
| TX Pwr Zero | 221 |
| Vert/div | 221 |
| Vert Offset | 222 |

Contents

7. Configuration - Screens and Control Fields

| | |
|---|-----|
| Configuring the Instrument | 225 |
| Setting the Date and Time | 225 |
| Changing the Beeper's Volume | 225 |
| Turning Off User Messages | 225 |
| Configuring for Printing A Screen | 226 |
| Printing a Screen | 226 |
| Control Fields on the Configuration Screens | 227 |
| Abort Print | 227 |
| Antenna In | 227 |
| Base Freq (User Defined) | 228 |
| Beeper | 228 |
| Call | 229 |
| Chan Space (User Defined) | 229 |
| CDMA Std | 229 |
| Command Escape Character | 231 |
| Connection Time-out | 231 |
| Data Length | 231 |
| Date | 232 |
| Display User Messages | 232 |
| Duplex Out | 232 |
| Ext Ref In | 233 |
| FF at End | 233 |
| FF at Start | 233 |
| Firmware | 233 |
| Flow Control | 234 |
| Frame Clock Output | 234 |
| (Gen)-(Anl) | 235 |
| (Gen)-(Anl) (User Defined) | 235 |
| GPIB Adrs | 236 |
| Hold-off Delay | 236 |
| IBASIC Echo | 236 |
| Incoming Call Security | 237 |
| Inst Echo | 237 |
| Lines/Page | 237 |
| Mode | 237 |
| Model | 238 |
| Modem Configuration | 238 |
| Modem Initialization/Configuration | 239 |
| Modem Mode | 239 |
| Notch Coupl | 240 |
| Number to Call | 240 |
| Opt CDMA TB | 240 |
| Parity | 240 |
| Password | 241 |
| Printer Adrs | 241 |
| Printer Port | 241 |
| Print Title | 241 |
| Range Hold | 242 |

Contents

| | |
|---------------------------|-----|
| Ref Select | 243 |
| Remote Mode | 243 |
| Retries | 244 |
| RF Chan Std | 244 |
| RF Display | 245 |
| RF Gen Volts | 245 |
| RF In/Out | 246 |
| RF Level Offset | 246 |
| RF Offset | 247 |
| Save/Recall | 247 |
| Serial Baud | 248 |
| Serial_9 In | 248 |
| Serial No. | 248 |
| Serial Port | 249 |
| Status | 249 |
| Stop Length | 249 |
| Time | 250 |
| Total RAM | 250 |

8. Signaling Encoder and Decoder - Screens and Control Fields

| | |
|---|------------|
| Signaling Encoder and Decoder Screens | 252 |
| The Decoder's Signal Source | 252 |
| Decoder Frequency Measurements | 252 |
| The Encoder | 252 |
| AMPS-TACS, NAMPS-NTACS Encoder and Decoder | 253 |
| Control and Voice Channel Identifiers | 253 |
| Encoder/Decoder Interaction | 253 |
| AMPS-TACS, NAMPS-NTACS Decoder | 254 |
| Interpreting Decoded Data | 254 |
| DTMF Sequence Encoder and Decoder | 258 |
| Measurement Limits | 258 |
| Function Generator Encoder and Decoder | 259 |
| Decoding Considerations | 259 |
| Control Fields for the Signaling Encoder and Decoder | 260 |
| AF Anl In | 260 |
| AFGen2 To | 260 |
| Arm Meas | 260 |
| B/I Delay | 260 |
| Bursts | 260 |
| Busy/Idle | 261 |
| Channel | 261 |
| Data (hex) | 261 |
| Data Level | 262 |
| Data Rate (analog) | 262 |
| DSAT | 263 |
| DSAT/DST (hex) | 263 |
| Filler (FOCC) | 264 |
| Frequency | 265 |
| Gate Time | 265 |

Contents

| | |
|--------------------------------------|-----|
| Hi Tone | 265 |
| Input Level | 266 |
| Lo Tone | 267 |
| Measure | 267 |
| Message (FOCC) | 268 |
| Message (FVC) (AMPS-TACS) | 269 |
| Message (FVC) (NAMPS-TACS) | 270 |
| Message/DST (FVC) | 270 |
| Mode | 271 |
| Num of Bits | 271 |
| Off Time | 271 |
| On Time | 272 |
| Polarity | 272 |
| Pre-Emp | 273 |
| RECC Data (hex) | 273 |
| SAT Freq (FVC) | 273 |
| SAT Level (FVC) | 273 |
| Send | 274 |
| Send DSAT (FVC) | 274 |
| Send Filler (FOCC) | 274 |
| Send Mode | 275 |
| Sine Units | 275 |
| Single/Cont | 275 |
| Standard | 276 |
| Status | 276 |
| Stop | 276 |
| Stop DSAT (FVC) | 277 |
| Stop Filler (FOCC) | 277 |
| Stop Meas | 277 |
| Sym | 277 |
| Symbol Frequencies (Hz) | 277 |
| Trigger Pattern (bin) | 278 |
| Trig Level | 278 |
| Twist | 279 |
| Waveform | 280 |

9. Connectors

| | |
|---|-----|
| Connectors | 282 |
| 10 MHz REF OUT | 282 |
| 16 × CHIP CLOCK 19.6608 MHz OUT | 282 |
| ANALOG MODULATION IN | 282 |
| ANT IN | 283 |
| AUDIO IN | 284 |
| AUDIO OUT | 285 |
| BASEBAND OUT (I and Q) | 285 |
| Chassis Ground | 285 |
| CHIP CLOCK 1.2288 MHz OUT | 285 |
| DATA IN | 286 |
| DUPLEX OUT | 286 |

Contents

| | |
|----------------------------|-----|
| EVEN SECOND SYNC IN | 286 |
| EXT REF IN | 287 |
| EXT SCOPE TRIG IN | 288 |
| FRAME CLOCK OUT | 288 |
| GPIB | 288 |
| MEMORY CARD Slot | 288 |
| PARALLEL 15 | 289 |
| PARALLEL 16 | 289 |
| RF IN/OUT | 290 |
| SCOPE MONITOR OUT | 290 |
| SERIAL 9, 10, and 11 | 291 |
| TRIGGER QUALIFIER IN | 291 |
| VIDEO OUT | 292 |

10. Accessories, Manuals, Support

| | |
|--|---------------------|
| Modifications | 294 |
| Agilent Technologies Accessories | 295 |
| External Monitor | 295 |
| Agilent Technologies Manuals (English and Other) | 295 |
| Agilent Technologies Test Software | 296 |
| Options | 296 |
| Support for Your Instrument | 297 |
| Getting Help | 297 |
| Customer Training | 297 |

11. Error Messages

| | |
|--|---------------------|
| General Information About Error Messages | 300 |
| Positive Numbered Error Messages | 300 |
| Negative Numbered Error Messages | 301 |
| IBASIC Error Messages | 301 |
| GPIB Error Messages | 302 |
| Text Only Error Messages | 302 |
| The Message Display | 303 |
| Non-Recoverable Firmware Error | 303 |
| Text Only Error Messages | 304 |

1 **General Information**

This chapter contains generic information about the product, safety, warranty, sales and service offices, power cables, and other information.

Manufacturer's Declaration

This statement is provided to comply with the requirements of the German Sound Emission Directive, from 18 January 1991.

This product has the following sound pressure emission specification:

- sound pressure $L_p < 70$ dB(A)
- at the operator position
- under normal operation
- according to ISO 7779:1988/EN 27779:1991 (Type Test).

Herstellerbescheinigung

Diese Information steht im Zusammenhang mit den Anforderungen der Maschinenlärminformationsverordnung vom 18 Januar 1991.

- Schalldruckpegel $L_p < 70$ dB(A).
- Am Arbeitsplatz.
- Normaler Betrieb.
- Nach ISO 7779:1988/EN 27779:1991 (Typprüfung).

Safety Considerations

GENERAL

This product and related documentation must be reviewed for familiarization with safety markings and instructions before operation.

This product has been designed and tested in accordance with IEC Publication 61010-1+A1+A2:1992 Safety Requirements for Electrical Equipment for Measurement, Control and Laboratory Use and has been supplied in a safe condition. This instruction documentation contains information and warnings which must be followed by the user to ensure safe operation and to maintain the product in a safe condition.

SAFETY EARTH GROUND

A uninterruptible safety earth ground must be provided from the main power source to the product input wiring terminals, power cord, or supplied power cord set.

CHASSIS GROUND TERMINAL

To prevent a potential shock hazard, always connect the rear-panel chassis ground terminal to earth ground when operating this instrument from a dc power source.

SAFETY SYMBOLS



Indicates instrument damage can occur if indicated operating limits are exceeded. Refer to the instructions in this guide.



Indicates hazardous voltages.



Indicates earth (ground) terminal

WARNING

A WARNING note denotes a hazard. It calls attention to a procedure, practice, or the like, which, if not correctly performed or adhered to, could result in personal injury. Do not proceed beyond a WARNING sign until the indicated conditions are fully understood and met.

CAUTION

A CAUTION note denotes a hazard. It calls attention to an operation procedure, practice, or the like, which, if not correctly performed or adhered to, could result in damage to or destruction of part or all of the product. Do not proceed beyond an CAUTION note until the indicated conditions are fully understood and met.

Safety Considerations for this Instrument

WARNING

Whenever it is likely that the protection has been impaired, the instrument must be made inoperative and be secured against any unintended operation.

If this instrument is to be energized via an autotransformer (for voltage reduction), make sure the common terminal is connected to the earth terminal of the power source.

If this product is not used as specified, the protection provided by the equipment could be impaired. This product must be used in a normal condition (in which all means for protection are intact) only.

No operator serviceable parts in this product. Refer servicing to qualified personnel. To prevent electrical shock, do not remove covers.

Servicing instructions are for use by qualified personnel only. To avoid electrical shock, do not perform any servicing unless you are qualified to do so.

The opening of covers or removal of parts is likely to expose dangerous voltages. Disconnect the product from all voltage sources while it is being opened.

Adjustments described in the manual are performed with power supplied to the instrument while protective covers are removed. Energy available at many points may, if contacted, result in personal injury.

For Continued protection against fire hazard, replace the line fuse(s) with T 250 V 5.0 A fuse(s) or the same current rating and type. Do not use repaired fuses or short circuited fuseholders.

WARNING



This product is a Safety Class I instrument (provided with a protective earthing ground incorporated in the power cord). The mains plug shall only be inserted in a socket outlet provided with a protective earth contact. Any interruption of the protective conductor inside or outside of the product is likely to make the product dangerous. Intentional interruption is prohibited.

WARNING

Always use the three-prong ac power cord supplied with this product. Failure to ensure adequate earth grounding by not using this cord may cause personal injury and/or product damage.

This product is designed for use in Installation Category II and Pollution Degree 3 per IEC 61010 and IEC 60664 respectively.

This product has autoranging line voltage input, be sure the supply voltage is within the specified range.

To prevent electrical shock, disconnect instrument from mains (line) before cleaning. Use a dry cloth or one slightly dampened with water to clean the external case parts. Do not attempt to clean internally.

Ventilation Requirements: When installing the product in a cabinet, the convection into and out of the product must not be restricted. The ambient temperature (outside the cabinet) must be less than the maximum operating temperature of the product by 4° C for every 100 watts dissipated in the cabinet. If the total power dissipated in the cabinet is greater than 800 watts, then forced convection must be used.

Lifting and Handling

When lifting and handling the Agilent 8935 CDMA Cellular/PCS Base Station Test Set use ergonomically correct procedures. Lift and carry by the strap on the side panel.

When moving the Test Set more than a few feet, be sure to replace the front screen cover.

Consumables

Two AA alkalyne batteries are supplied with the Test Set and must be replaced periodically. When replacing batteries always dispose of old batteries in a conscientious manner, following manufacturer's instructions.

Product Markings



The CE mark shows that the product complies with all relevant European legal Directives (if accompanied by a year, it signifies when the design was proven).



The CSA mark is a registered trademark of the Canadian Standards Association.

Certification

Agilent Technologies certifies that this product met its published specifications at the time of shipment from the factory. Agilent further certifies that its calibration measurements are traceable to the United States National Institute of Standards and Technology, to the extent allowed by the Institute's calibration facility, and to the calibration facilities of other International Standards Organization members.

DECLARATION OF CONFORMITY

According to ISO/IEC Guide 22 and CEN/CENELEC EN45014

Manufacturer's Name: Agilent Technologies UK Limited

Manufacturer's Address: Electronic Products Solutions Group - Queensferry
South Queensferry
West Lothian, EH30 9TG
Scotland, United Kingdom

Declares that the product

Product Name: CDMA Base Station Test Set

Model Number: E6380A

Product Options: This declaration covers all options of the above product as detailed in TCF A-5951-9852-02.

EMC:
Conforms with the protection requirements of European Council Directive 89/336/EEC on the approximation of the laws of the member states relating to electromagnetic compatibility, against EMC test specifications EN 55011:1991 (Group 1, Class A) and EN 50082-1:1992.

As Detailed in: Electromagnetic Compatibility (EMC)
Technical Construction File (TCF) No. A-5951-9852-02.

Assessed by: DTI Appointed Competent Body
EMC Test Centre,
GEC-Marconi Avionics Ltd.,
Maxwell Building,
Donibristle Industrial Park,
Hillend,
Dunfermline
KY11 9LB
Scotland, United Kingdom

Technical Report Number:6893/2201/CBR, dated 23 September 1997

Safety:

The product conforms to the following safety standards:

IEC 61010-1(1990) +A1(1992) +A2(1995) / EN 61010-1:1993
IEC 60825-1(1993) / EN 60825-1:1994
Canada / CSA-C22.2 No. 1010.1-93

The product herewith complies with the requirements of the Low Voltage Directive 73/23/EEC, and carries the CE mark accordingly

South Queensferry, Scotland.

1st November 2000

R M Evans

*R.M. Evans / Manufacturing
Engineering Manager*

For further information, please contact your local Agilent Technologies sales office, agent, or distributor.

Agilent Technologies Warranty Statement for Commercial Products

E6380A CDMA/Cellular PCS Base Station Test Set

**Duration of
Warranty: 1 Year**

1. Agilent warrants Agilent hardware, accessories and supplies against defects in materials and workmanship for the period specified above. If Agilent receives notice of such defects during the warranty period, Agilent will, at its option, either repair or replace products which prove to be defective. Replacement products may be either new or like-new.
2. Agilent warrants that Agilent software will not fail to execute its programming instructions, for the period specified above, due to defects in material and workmanship when properly installed and used. If Agilent receives notice of such defects during the warranty period, Agilent will replace software media which does not execute its programming instructions due to such defects.
3. Agilent does not warrant that the operation of Agilent products will be uninterrupted or error free. If Agilent is unable, within a reasonable time, to repair or replace any product to a condition as warranted, customer will be entitled to a refund of the purchase price upon prompt return of the product.
4. Agilent products may contain remanufactured parts equivalent to new in performance or may have been subject to incidental use.
5. The warranty period begins on the date of delivery or on the date of installation if installed by Agilent. If customer schedules or delays Agilent installation more than 30 days after delivery, warranty begins on the 31st day from delivery.
6. Warranty does not apply to defects resulting from (a) improper or inadequate maintenance or calibration, (b) software, interfacing, parts or supplies not supplied by Agilent, (c) unauthorized modification or misuse, (d) operation outside of the published environmental specifications for the product, or (e) improper site preparation or maintenance.

7. TO THE EXTENT ALLOWED BY LOCAL LAW, THE ABOVE WARRANTIES ARE EXCLUSIVE AND NO OTHER WARRANTY OR CONDITION, WHETHER WRITTEN OR ORAL IS EXPRESSED OR IMPLIED AND Agilent SPECIFICALLY DISCLAIMS ANY IMPLIED WARRANTIES OR CONDITIONS OR MERCHANTABILITY, SATISFACTORY QUALITY, AND FITNESS FOR A PARTICULAR PURPOSE.
8. Agilent will be liable for damage to tangible property per incident up to the greater of \$300,000 or the actual amount paid for the product that is the subject of the claim, and for damages for bodily injury or death, to the extent that all such damages are determined by a court of competent jurisdiction to have been directly caused by a defective Agilent product.
9. TO THE EXTENT ALLOWED BY LOCAL LAW, THE REMEDIES IN THIS WARRANTY STATEMENT ARE CUSTOMER'S SOLE AND EXCLUSIVE REMEDIES. EXCEPT AS INDICATED ABOVE, IN NO EVENT WILL Agilent OR ITS SUPPLIERS BE LIABLE FOR LOSS OF DATA OR FOR DIRECT, SPECIAL, INCIDENTAL, CONSEQUENTIAL (INCLUDING LOST PROFIT OR DATA), OR OTHER DAMAGE, WHETHER BASED IN CONTRACT, TORT, OR OTHERWISE.

FOR CONSUMER TRANSACTIONS IN AUSTRALIA AND NEW ZEALAND: THE WARRANTY TERMS CONTAINED IN THIS STATEMENT, EXCEPT TO THE EXTENT LAWFULLY PERMITTED, DO NOT EXCLUDE RESTRICT OR MODIFY AND ARE IN ADDITION TO THE MANDATORY STATUTORY RIGHTS APPLICABLE TO THE SALE OF THIS PRODUCT TO YOU.

Assistance

Product maintenance agreements and other customer assistance agreements are available for Agilent Technologies products. For any assistance, contact your nearest Agilent Technologies Sales and Service Office.

Table 1-1 Regional Sales and Service Offices

| | | |
|--|---|--|
| <p>United States of America: Agilent Technologies Test and Measurement Call Center P.O. Box 4026 Englewood, CO 80155-4026</p> <p>(tel) 1 800 452 4844</p> | <p>Canada: Agilent Technologies Canada Inc. 5150 Spectrum Way Mississauga, Ontario L4W 5G1</p> <p>(tel) 1 877 894 4414</p> | <p>Europe: Agilent Technologies European Marketing Organization P.O. Box 999 1180 AZ Amstelveen The Netherlands</p> <p>(tel) (3120) 547 9999</p> |
| <p>Japan: Agilent Technologies Japan Ltd. Measurement Assistance Center 9-1 Takakura-Cho, Hachioji-Shi, Tokyo 192-8510, Japan</p> <p>(tel) (81) 456-56-7832 (fax) (81) 426-56-7840</p> | <p>Latin America: Agilent Technologies Latin America Region Headquarters 5200 Blue Lagoon Drive, Suite #950 Miami, Florida 33126 U.S. A.</p> <p>(tel) (305) 267 4245 (fax) (305) 267 4286</p> | <p>Australia/New Zealand: Agilent Technologies Australia Pty Ltd. 347 Burwood Highway Forest Hill, Victoria 3131</p> <p>(tel) 1 800 629 485 (Australia) (fax) (61 3) 9272 0749 (tel) 0 800 738 378 (New Zealand) (fax) (64 4) 802 6881</p> |
| <p>Asia Pacific: Agilent Technologies 24/F, Cityplaza One, 111 Kings Road, Taikoo Shing, Hong Kong</p> <p>(tel) (852) 3197 7777 (fax) (852) 2506 9233</p> | | |

Power Cables

Power Cables

Table 1-2 Power Cables

| Plug Type | Plug Descriptions male/female | Agilent Part # (cable & plug) | Cable Descriptions |
|--|---|----------------------------------|--|
|  | Straight/Straight Straight/90° | 8120-1689 8120-1692 | 79 inches, mint gray 79 inches, mint gray |
| Used in the following locations | | | |
| Afghanistan, Albania, Algeria, Angola, Armenia, Austria, Azerbaijan, Azores | | | |
| Bangladesh, Belgium, Benin, Bolivia, Bosnia-Herzegovina, Bulgaria, Burkina Faso, Burma, Burundi, Byelarus | | | |
| Cameroon, Canary Islands, Central African Republic, Chad, Chile, Comoros, Congo, Croatia, Czech Republic, Czechoslovakia | | | |
| Denmark, Djibouti | | | |
| East Germany, Egypt, Estonia, Ethiopia | | | |
| Finland, France, French Guiana, French Indian Ocean Areas | | | |
| Gabon, Gaza Strip, Georgia, Germany, Gozo, Greece | | | |
| Hungary | | | |
| Iceland, Indonesia, Iran, Iraq, Israel, Italy, Ivory Coast | | | |
| Jordan | | | |
| Kazakhstan, Korea, Kyrgystan | | | |
| Latvia, Lebanon, Libya, Lithuania, Luxembourg | | | |
| Macedonia, Madeira Islands, Malagasy Republic, Mali, Malta, Mauritania, Miquelon, Moldova, Mongolia, Morocco, Mozambique | | | |
| Nepal, Netherlands, Netherlands Antilles, Niger, Norway | | | |
| Oman | | | |
| Pakistan, Paraguay, Poland, Portugal | | | |

Table 1-2 Power Cables

| Plug Type | Plug Descriptions male/female | Agilent Part # (cable & plug) | Cable Descriptions |
|---|---|----------------------------------|--|
|  | Straight/Straight Straight/90° | 8120-1689 8120-1692 | 79 inches, mint gray 79 inches, mint gray |
| Rep. South Africa, Romania, Russia, Rwanda | | | |
| Saudi Arabia (220V), Senegal, Slovak Republic, Slovenia, Somalia, Spain, Spanish Africa, Sri Lanka, St.Pierce Islands | | | |
| Sweden, Syria | | | |
| Tajikistan, Thailand, Togo, Tunisia, Turkey, Turkmenistan | | | |
| USSR, Ukraine, Uzbekistan | | | |
| Western Africa, Western Sahara | | | |
| Yugoslavia | | | |
| Zaire | | | |

Table 1-3 Power Cables

| Plug Type | Plug Descriptions male/female | Agilent Part # (cable & plug) | Cable Descriptions |
|---|----------------------------------|----------------------------------|--------------------|
|  | Straight/Straight | 8120-0698 | 90 inches, black |
| Used in the following locations | | | |
| Peru | | | |

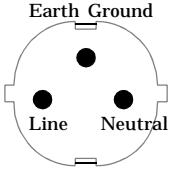
Table 1-4 Power Cables

| Plug Type | Plug Descriptions male/female | Agilent Part # (cable & plug) | Cable Descriptions |
|---|-----------------------------------|-------------------------------|------------------------------------|
|  | Straight/Straight Straight/90° | 8120-2104 8120-2296 | 79 inches, gray 79 inches, gray |
| Used in the following locations | | | |
| Switzerland | | | |

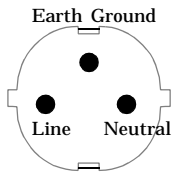
Table 1-5 Power Cables

| Plug Type | Plug Descriptions male/female | Agilent Part # (cable & plug) | Cable Descriptions |
|--|---|-------------------------------------|--|
|  | Straight/Straight Straight/90 Straight/Straight | 8120-1378 8120-1521 8120-1751 | 90 inches, jade gray 90 inches, jade gray 90 inches, jade gray |
| Used in the following locations | | | |
| American Samoa | | | |
| Bahamas, Barbados, Belize, Bermuda, Brazil, | | | |
| Caicos, Cambodia, Canada, Cayman Islands, Columbia, Costa Rica, Cuba | | | |
| Dominican Republic | | | |
| Ecuador, El Salvador | | | |
| French West Indies | | | |
| Guam, Guatemala, Guyana | | | |
| Haiti, Honduras | | | |
| Jamaica | | | |
| Korea | | | |
| Laos, Leeward and Windward Is., Liberia | | | |
| Mexico, Midway Islands | | | |

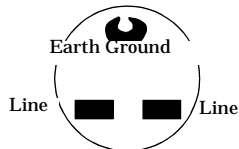
Table 1-5 Power Cables

| Plug Type | Plug Descriptions male/female | Agilent Part # (cable & plug) | Cable Descriptions |
|--|-------------------------------|-------------------------------|--------------------|
| Nicaragua | | | |
| Other Pacific Islands | | | |
| Panama, Philippines, Puerto Rico | | | |
| Saudi Arabia (115V,127V), Suriname | | | |
| Taiwan, Tobago, Trinidad, Trust Territories of Pacific Islands | | | |
| Turks Island | | | |
| United States | | | |
| Venezuela, Vietnam, Virgin Islands of the US | | | |
| Wake Island | | | |

Table 1-6 Power Cables

| Plug Type | Plug Descriptions male/female | Agilent Part # (cable & plug) | Cable Descriptions |
|--|---|--------------------------------|--|
| <p>JIS C 8303, 100 V</p>  | <p>Straight/Straight Straight/90°</p> | <p>8120-4753 8120-4754</p> | <p>90 inches, dark gray 90 inches, dark gray</p> |
| Used in the following locations | | | |
| Japan | | | |

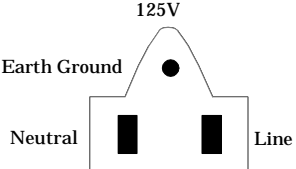
Table 1-7 Power Cables

| Plug Type | Plug Descriptions male/female | Agilent Part # (cable & plug) | Cable Descriptions |
|---|--|--|--|
|  | <p>90° /STRAIGHT 90°/90° Straight/Straight</p> | <p>8120-2956 8120-2957 8120-3997</p> | <p>79 inches, gray 79 inches, gray 79 inches, gray</p> |

Table 1-7 Power Cables

| Plug Type | Plug Descriptions male/female | Agilent Part # (cable & plug) | Cable Descriptions |
|---------------------------------|----------------------------------|----------------------------------|--------------------|
| Used in the following locations | | | |
| Denmark | | | |
| Greenland | | | |

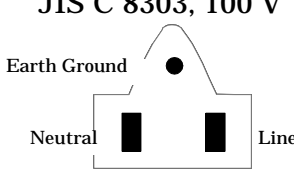
Table 1-8 Power Cables

| Plug Type | Plug Descriptions male/female | Agilent Part # (cable & plug) | Cable Descriptions |
|---|-----------------------------------|----------------------------------|--|
|  | Straight/Straight Straight/90° | 8120-4211 8120-4600 | 79 inches, mint gray 79 inches, mint gray |
| Used in the following locations | | | |
| Botswana | | | |
| India | | | |
| Lesotho | | | |
| Malawi | | | |
| South-West Africa (Namibia), Swaziland | | | |
| Zambia, Zimbabwe | | | |

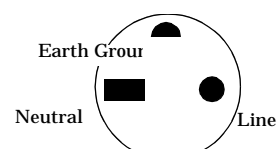
Table 1-9 Power Cables

| Plug Type (Male) | Plug Descriptions male/female | Agilent Part # (cable & plug) | Cable Descriptions |
|---|----------------------------------|----------------------------------|--|
|  | 90°/Straight 90°/90° | 8120-1351 8120-1703 | 90 inches, mint gray 90 inches, mint gray |
| Used in the following locations | | | |
| Bahrain, British Indian Ocean Terr., Brunei | | | |
| Canton, Cyprus | | | |

General Information
Power Cables

Table 1-9 Power Cables

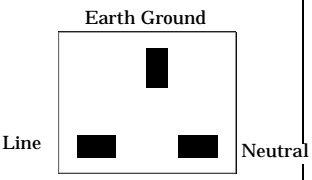
| Plug Type (Male) | Plug Descriptions male/female | Agilent Part # (cable & plug) | Cable Descriptions |
|---|-------------------------------|-------------------------------|--------------------|
| Enderbury Island, Equatorial Guinea | | | |
| Falkland Islands, French Pacific Islands | | | |
| Gambia, Ghana, Gibraltar, Guinea | | | |
| Hong Kong | | | |
| Ireland | | | |
| Kenya, Kuwait | | | |
| Macao, Malaysia, Mauritius | | | |
| Nigeria | | | |
| Qatar | | | |
| Seychelles, Sierra Leone, Singapore, Southern Asia, Southern Pacific Islands, St. Helena, Sudan | | | |
| Tanzania | | | |
| Uganda, United Arab Emirates, United Kingdom | | | |
| Yeman (Aden & Sana) | | | |

Table 1-10 Power Cables

| Plug Type | Plug Descriptions male/female | Agilent Part # (cable & plug) | Cable Descriptions |
|---|---|--------------------------------|--|
| <p>Earth Ground</p>  <p>Line Neutral</p> | <p>Straight/Straight Straight/90°</p> | <p>8120-1369 8120-0696</p> | <p>79 inches, gray 80 inches, gray</p> |
| Used in the following locations | | | |
| Argentina, Australia | | | |
| China (People's Republic) | | | |
| New Zealand | | | |
| Papua New Guinea | | | |
| Uruguay | | | |

Table 1-10 Power Cables

| Plug Type | Plug Descriptions male/female | Agilent Part # (cable & plug) | Cable Descriptions |
|---------------|----------------------------------|----------------------------------|--------------------|
| Western Samoa | | | |

Table 1-11 Power Cables

| Plug Type | Plug Descriptions male/female | Agilent Part # (cable & plug) | Cable Descriptions |
|---|--|--|--|
|  | Straight/Straight Straight/Straight Straight/90° Straight/90° | 8120-1860 8120-1575 8120-2191 8120-4379 | 60 inches, jade gray 30 inches, jade gray 60 inches, jade gray 15.5 inches, jade gray |
| Used in the following locations | | | |
| System Cabinets | | | |

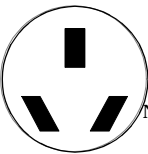
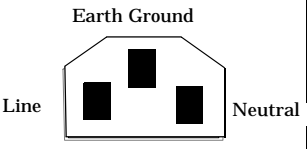
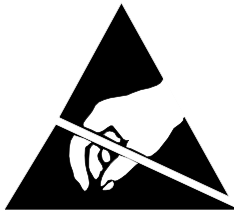

ATTENTION

Static Sensitive Devices

This instrument was constructed in an ESD (electro-static discharge) protected environment. This is because most of the semiconductor devices used in this instrument are susceptible to damage by static discharge.

Depending on the magnitude of the charge, device substrates can be punctured or destroyed by contact or mere proximity of a static charge. The result can cause degradation of device performance, early failure, or immediate destruction.

These charges are generated in numerous ways such as simple contact, separation of materials, and normal motions of persons working with static sensitive devices.

When handling or servicing equipment containing static sensitive devices, adequate precautions must be taken to prevent device damage or destruction.

Only those who are thoroughly familiar with industry accepted techniques for handling static sensitive devices should attempt to service circuitry with these devices.

Product Description

The Agilent Technologies 8935 Series E6380A CDMA Cellular/PCS Base Station Test Set offers full signal generation and analysis capability and support for cellular frequency bands and international PCS frequency bands.

You can perform the following CDMA measurements using the Test Set:

- Signal Quality Measurements
 - Rho (ρ)
 - Time Offset
 - Frequency Error
 - Carrier Feedthrough
- Code Domain Measurements (IS-95)
 - Code Domain Power
 - Code Domain Timing
 - Code Domain Phase
- Code Domain Measurements (IS-2000)
 - Code Domain Power
 - Code Domain Fast Power
 - Code Domain Complex Power
 - Code Domain Power & Noise
 - Code Domain Fast Power Synchronization
- Average Power
- Channel Power
- Error Vector Magnitude

The Test Set's CDMA generator also has the following capabilities:

- Reverse Channel Source with Data Buffer
- AWGN (built-in calibrated E_b/N_0 levels)

The Test Set also supports CDMA reference clocks and triggers.

In addition to its CDMA measurements and capabilities, the Test Set also provides the following analog measurements:

- AC Level
- AM Depth
- AF Frequency
- DC Level
- Distortion
- Frequency and Frequency Error
- Transmitter Power
- FM Deviation
- Audio Frequency
- SINAD
- SNR

Documentation

Conventions Used in This Manual

The following conventions are used throughout this manual to help clarify instructions and reduce unnecessary text:

- “Test Set” refers to the Agilent 8935 CDMA Cellular/PCS Base Station Test Set.
- Test Set keys are indicated like this: **Preset**
- Test Set screen information, such as a measurement result or an error message, is shown like this: TX Channel Power -1.3 dBm

NOTE

HP-IB and GPIB are one and the same.

What is in This Manual

- [Chapter 2, “Getting Started,” on page 39](#) familiarizes you with the front panel controls. It introduces the different types of control fields that are used to make measurements
- [Chapter 3, “Operating Overview,” on page 51](#) provides general information about how to change measurement screens and change control field settings. This chapter also provides some utility procedures: calibrating channel power, setting a reference, setting measurement limits, setting a generator/analyzer offset, averaging measurements, saving and recalling setups, and using USER keys.
- [Chapter 4, “Overview of the Test Set’s Built-In Tools,” on page 77](#) introduces the RFTOOLS program. This program automates some measurements: cable fault location, swept return loss, swept and discrete insertion loss, spectrum analyzer self-calibration. The program also includes utilities for printing and data collection.

Basic operation of the built-in signal strength meter, spectrum analyzer, oscilloscope, and code domain analyzer is also included in this chapter.

- [Chapter 5, “CDMA Measurements - Screens and Control Fields,” on page 129](#) explains the measurements that can be made from these screens and the fields that control the measurement’s parameters.

CDMA measurements include average power measurements, channel power measurements, rho measurements (including frequency error, time offset, and carrier feedthrough), EVM measurements (including phase error and magnitude error), and code domain measurements (both IS-95 and IS-2000 standards).

- [Chapter 6, “Analog Measurements - Screens and Control Fields,” on page 177](#) explains the measurements that can be made from these screens and the fields that control the measurement’s parameters.
Analog measurements include ac/dc level, AM depth, AF frequency, distortion, frequency and frequency error, transmitter power, FM deviation, SINAD, and SNR.
- [Chapter 7, “Configuration - Screens and Control Fields,” on page 223](#) explains the configuration controls for the Test Set.
- [Chapter 9, “Connectors,” on page 281](#) describes the function and physical attributes of each connector on the Test Set.
- [Chapter 10, “Accessories, Manuals, Support,” on page 293](#) describes any available upgrades, accessories, training and support for the Test Set.
- [Chapter 11, “Error Messages,” on page 299](#) provides any available information about error recovery when messages are displayed.

Which Document is Required?

The following documents are part of the Agilent 8935 document set. Use the table to help you decide which document you need.

Table 1-12 Document Navigation

| Document | Part Number | Usage |
|---|-------------|---|
| CDMA Application Guide | E6380-90016 | Use this manual for basic CDMA measurements and for getting started with the Test Set. |
| AMPS Application Guide | E6380-90017 | Use this manual for making AMPS base station measurements. |
| Reference Guide | E6380-90019 | Use this manual for screen and field descriptions and general operation information about the Test Set. |
| GPIB Syntax Reference Guide | E6380-90073 | Use this manual as a reference to the syntax and use of all available GPIB commands. |
| Programmer’s Guide | E6380-90018 | Use this manual to learn GPIB syntax and for learning how to program the Test Set. |
| Assembly Level Repair Guide (this manual) | E6380-90015 | Use this manual to perform calibration on the Test Set and for general service information. |
| Technical Specifications Publication | 5966-0512E | Test Set’s specifications data sheet |
| CDROM | E6380-90027 | Includes all of the above documents. |

Trademark Acknowledgments

Hewlett-Packard® and HP® are registered trademarks of Hewlett-Packard Company.

Microsoft, Windows®, and MS-DOS®, are registered trademarks of Microsoft Corporation.

ProComm, is a registered trademark of DataStorm Technologies, Inc.

HyperTerminal© is a registered trademark of Hilgraeve, Incorporated.

Pentium® is a registered trademark of Intel Corporation.

2 **Getting Started**

- “Before Connecting a Radio” on page 41
- “Changing the Measurement Screen” on page 42
- “Changing the Control Fields” on page 44
- “Instrument Quick Check” on page 49

Before Connecting a Radio

NOTE

The RF IN/OUT port should be used for all transmitter tests when the radio is connected directly to the Test Set. (All UUT transmitter power measurements are made through this port). Off-the-air measurements can be made using the ANT IN port.

CAUTION

Overpower Damage — Refer to the Test Set's side panel for maximum input power level at the RF IN/OUT, DUPLEX OUT, and ANT IN connectors. Exceeding these levels can cause permanent instrument damage.

Changing the Test Set's Display

Changing the Measurement Screen

The measurement screen is changed using the titlebar at the top of the screen and the cursor-control knob, using the GENERATOR/ANALYZER keys, or by using the UTILS keys. Rotate the knob to move the cursor from field to field or to change settings. Press the knob to make selections (see “Changing the Control Fields” on page 44 for more information about fields).

Figure 2-1 Using the cursor-control Knob or Screen Keys

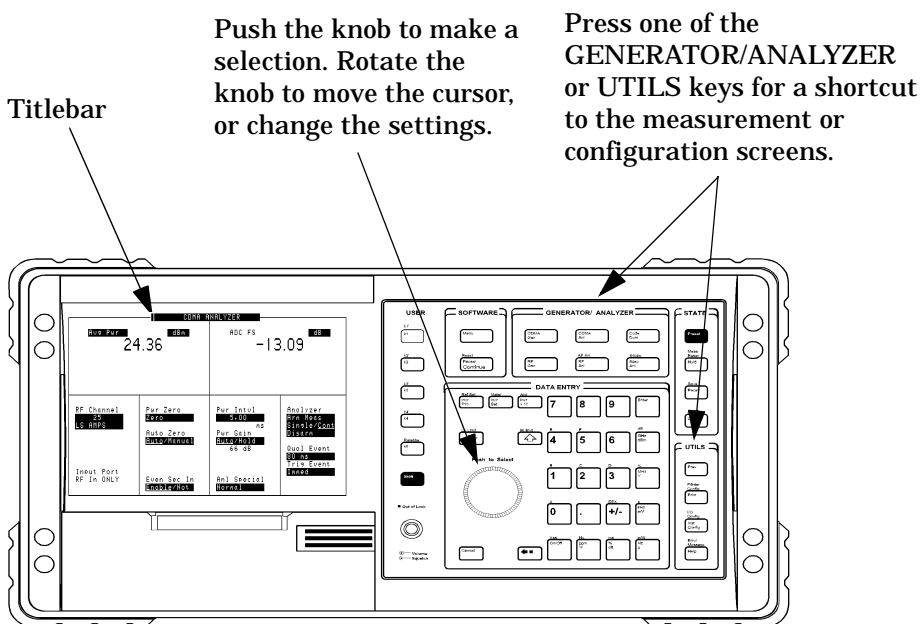

To change the measurement screen

- Step 1.** Select the titlebar at the top of the screen (placement of the titlebar may vary slightly on some screens).
- Step 2.** Select the measurement screen from the list of choices.

OR

- Step 1.** Press a screen key: CDMA Gen, CDMA Anl, Code Dom, RF Gen, RF Anl, Spec Anl, AF Anl, Scope, Prev, Inst Config, Help, Printer Config, I/O Config, Error Message.
AF Anl, Scope, Printer Config, I/O Config, and Error Message are shifted functions (labeled in blue above a key). You must press and release the blue **Shift** key then the key below the blue label to access the screen (or other function) labeled in blue.
Pressing the **Prev** key displays the previous screen.

Changing the Control Fields

There are several types of control fields in the Test Set. This section describes some of the different types of fields.

Unit-of-Measure Field

Unit-of-measure can be changed to display measurements in different values or magnitudes. The unit-of-measure field can also be used to turn a measurement on or off (use the **On/Off Yes** key).

Figure 2-2 Unit-of-Measure Field

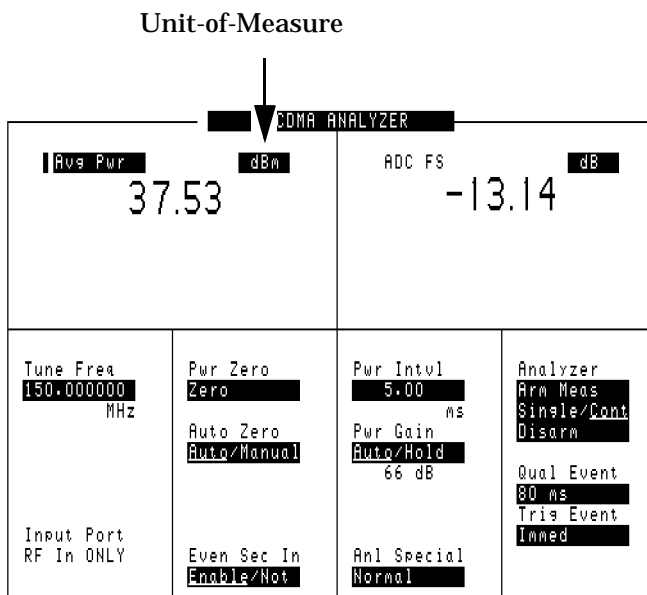

To change a unit-of-measure field

- Step 1.** Position the cursor at the unit field on the display.
- Step 2.** Press a key labeled with a different unit-of-measure (such as W).

If the new units are valid, the measurement value is displayed in the unit.

If the new units are not valid, the message **Invalid keystroke.** is displayed and the units are not changed.

Underlined Entry Field

Underlined entry fields provide a choice of two settings (toggle).

Figure 2-3 Underlined Entry Field

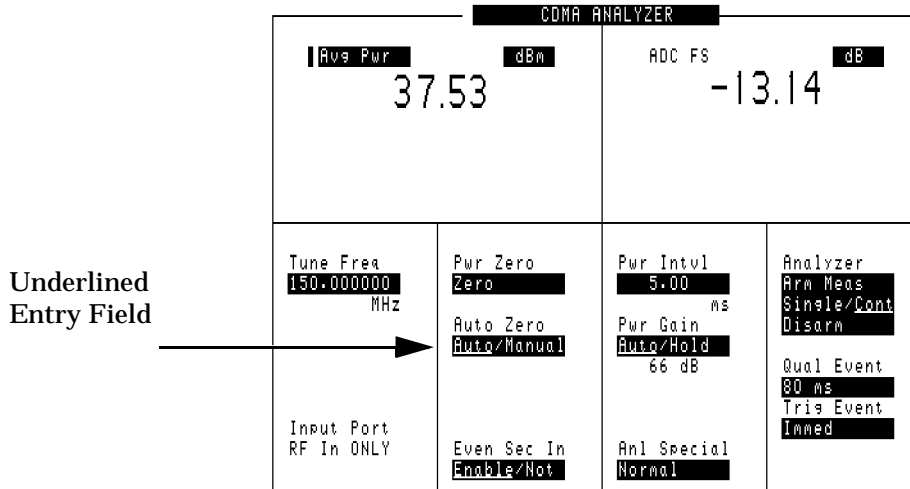

To Change an underlined entry

- Step 1.** Position the cursor at the field.
- Step 2.** Push the cursor-control knob or the **Enter** key to move the underline under the desired choice.

The underlined setting is immediately activated when selected.

One-of-Many Field

One-of-many fields display a list of choices when selected.

Figure 2-4 One-of-Many Field

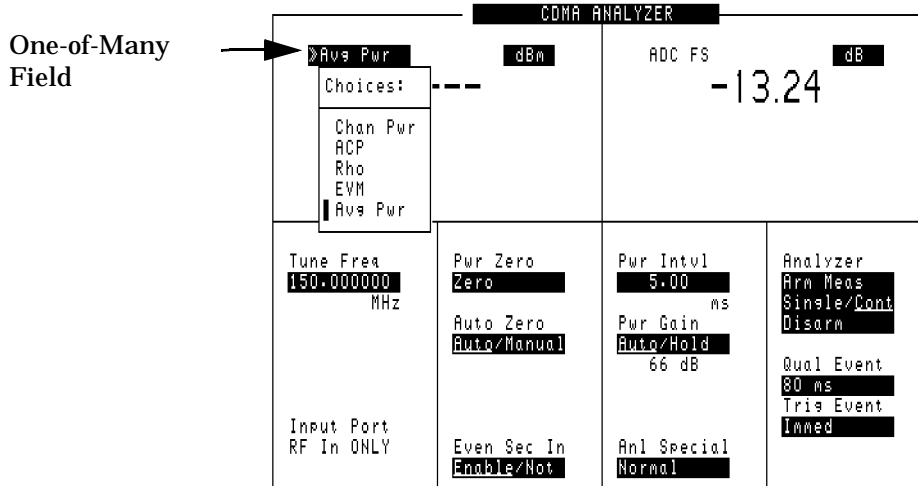

To make a one-of-many choice

- Step 1.** Position the cursor at the field.
 - Step 2.** Push the cursor-control knob or the **Enter** key to display the choices.
 - Step 3.** Move the cursor through the choices by turning the knob.
 - Step 4.** Push the cursor-control knob or the **Enter** key to make the choice.
- The choice is immediately activated when selected.

Numeric-Entry Fields

Values for numeric entry fields can be entered and changed using various methods, depending on your testing needs.

Figure 2-5 Numeric-Entry Field

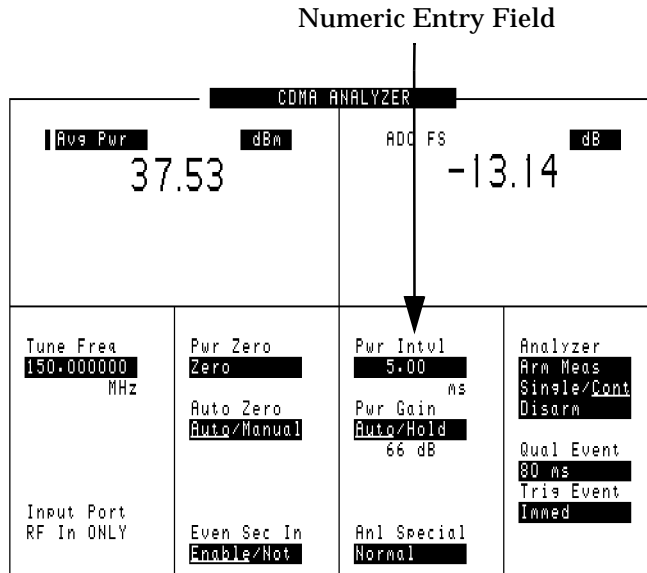

To change a value

- Step 1.** Position the cursor at the field.
 - Step 2.** Key in the desired number using the DATA ENTRY keys.
 - Step 3.** Press **Enter** to select the choice.
- OR
- Step 4.** Position the cursor at the field.
 - Step 5.** Push the cursor-control knob (the flashing >> cursor appears).
 - Step 6.** Turn the knob to increment or decrement the value. (The current increment value may not be appropriate for your operation. See [“Changing the Increment or Decrement Setting” on page 64](#))
 - Step 7.** Push the cursor-control knob or the **Enter** key to select the choice.
- OR
- Step 8.** Position the cursor at the field.
 - Step 9.** Use the up-arrow or down-arrow keys to increment or decrement the value.

Decimal Values

Decimal values are used for most numeric entry fields. The acceptable entries for decimal values are 0 through 9, ., +/-, and EEX.

The +/- key is used for entering negative numbers.

The EEX key is used to enter values in exponential notation. For example to enter 10^{-9} you would enter 1, 0, EEX (Shift, +/-), +/-, 9.

Hexadecimal Values

Hexadecimal (Hex) values are used for entering some signaling parameters. The acceptable entries values are 0 through 9 and A through F. No unit-of-measure is associated with these values.

Hexadecimal values are either entered from the keypad (A through F are shifted functions) or for some fields, values are selected from a list of choices.

How do I Verify that the Test Set is Operating Properly?

If your Test Set powers-up and displays the CDMA ANALYZER screen, but you suspect an instrument problem, use the Instrument Quick Check to verify operation of the basic instrument functions.

If no failure is indicated by this test, but you still suspect a problem, refer to the “Performance Tests” information in the *Assembly Level Repair Manual*.

Instrument Quick Check

Step 1. Set up the quick check:

- a. Remove any connected cables (except for AC or DC power).
- b. Turn instrument power on (if it is not already on).
- c. Press **Preset**.
- d. Press **Inst Config** and set the **RF Display** field to **Freq**.
- e. Press **CDMA Anl** and select the **Avg Pwr** field, then select **Rho** from the Choices: menu.
- f. Set the **Tune Freq** field to 800 MHz.
- g. Set the **Anl Dir** field to **Fwd**.
- h. Press **CDMA Gen** and set the **Output Port** field to **RF Out**.
- i. Set the **RF Gen Freq** field to 800 MHz.
- j. Set the **Amplitude** field to -40 dBm
- k. Set the **Gen Dir.** field to **Fwd**. (The **EQ In/Out** field is displayed.)

Step 2. Check the following reading:

- a. Rho should be greater than 0.96.

Step 3. Press **Spec Anl** to access the SPEC ANL screen.

You should see the characteristic CDMA spectrum.

Figure 2-6 CDMA Spectrum

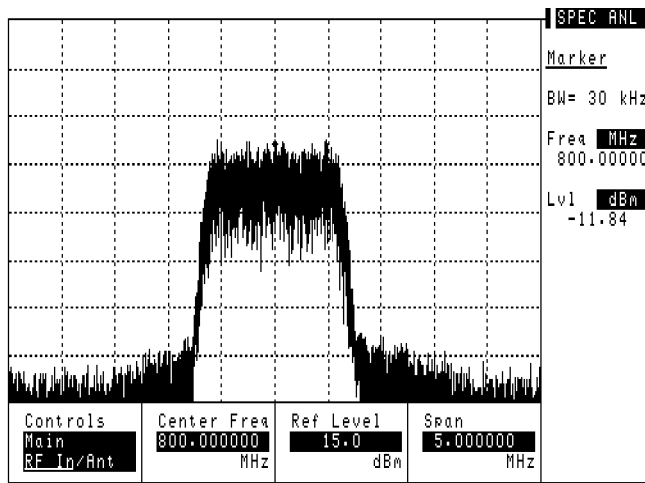

3 **Operating Overview**

- “Displaying CDMA Measurements” on page 53
- “Displaying Analog Measurements” on page 56
- “Using Channel Numbers to Set Analyzer and Generator Frequencies” on page 60
- “Calibrating the Channel Power Measurement – CDMA Analyzer” on page 61
- “Changing the Increment or Decrement Setting” on page 64
- “Using Measurement Limit Indicators” on page 65
- “Setting A Measurement Reference” on page 67
- “Averaging Measurements” on page 68
- “Setting an RF Generator/Analyzer Offset” on page 69
- “Saving and Recalling Instrument Setups” on page 70
- “Using USER Keys” on page 73
- “Replacing Batteries” on page 75

Displaying CDMA Measurements

Channel Power, Adjacent Channel Power (ACP), Rho, Error Vector Magnitude (EVM), Average Power

You can select channel power, ACP, rho, EVM, or average power on the CDMA ANALYZER or CDMA GENERATOR screen as shown in [Figure 3-1](#). For more information about these measurements see “CDMA Measurements” on page 131.

Figure 3-1 Displaying Channel Power, ACP, Rho, EVM, or Average Power

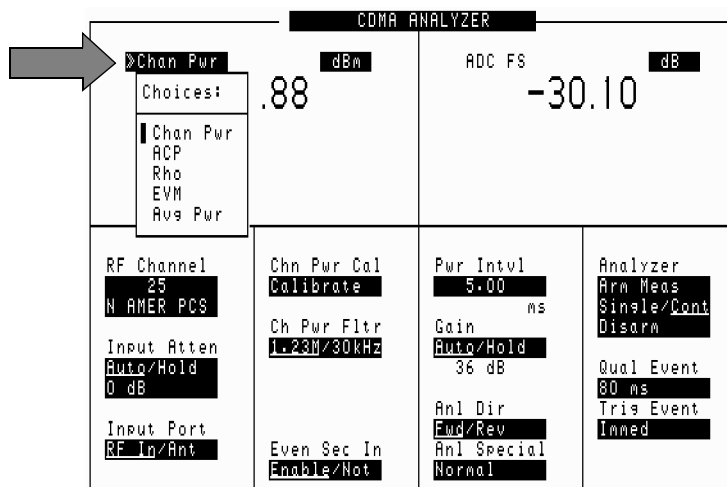

ADC Full Scale (ADC FS)

When you select **Avg Pwr** or **Chan Pwr**, the **ADC FS** measurement is also displayed.

Time Offset, Frequency Error, PN Offset, Carrier Feedthrough

When you select **Rho**, the **Time Offset**, **Freq Err** or **PN Offset**, (see [Figure 3-1](#)) and **Carrier Feedthru** measurements are displayed. These measurements are also displayed on the **CODE DOM** screen.

Figure 3-2 Frequency Error, and PN Offset

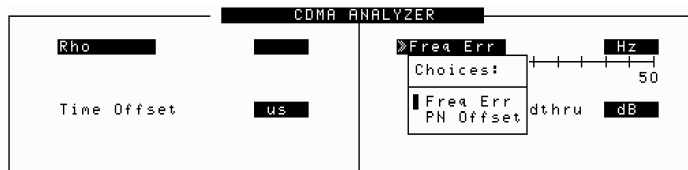

Magnitude Error, Phase Error

When you select **EVM**, the **Magnitude Error** and **Phase Error** measurements are displayed.

Code Domain Measurements (Power, Fast Power, Power & Noise, Complex Power, Phase, Timing, Fast Power Synchronization)

Code domain measurements are displayed on the **CODE DOM** screen. To select a code domain measurement, first press the **Inst Config** button and then select the standard for which you want to make a code domain measurement: **IS-95** or **IS-2000**.

For more information about code domain measurements see [“Code Domain Measurements – IS-95” on page 139](#) or [“Code Domain Measurements – IS-2000” on page 142](#) respectively.

The measurements available in the code domain under **IS-95** only, are:

- Power
- Fast Power
- Timing
- Phase

The measurements available in the code domain under **IS-2000** are:

- Power
- Fast Power
- Power & Noise
- Complex Power
- Fast Power Synchronization

Now go to the **CODE DOM** screen and select a measurement from the **Measurement** field in the **Main** controls menu. [Figure 3-3](#) shows the measurement selection for **IS-95**.

Figure 3-3 Selecting Code Domain Measurements

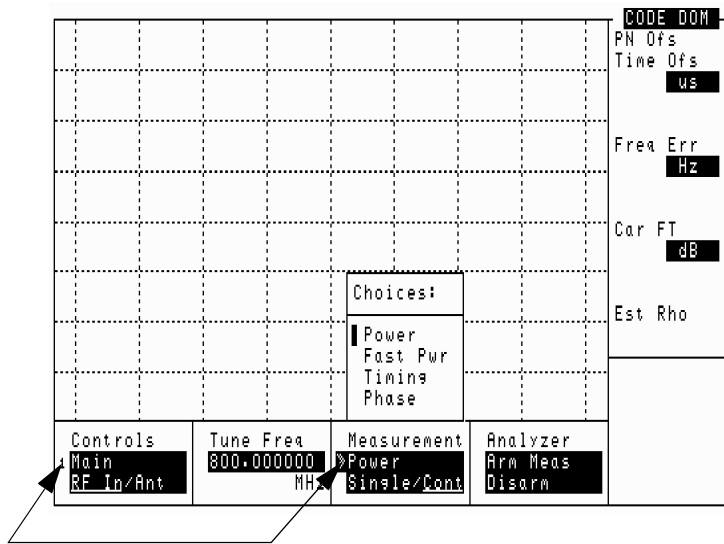

I/Q Diagram

Displays the I/Q convergence for the current measurement. See [“IQ Constellation Diagram, IS-2000 only”](#) on page 149 for additional information.

Figure 3-4 IQ Constellation Diagram

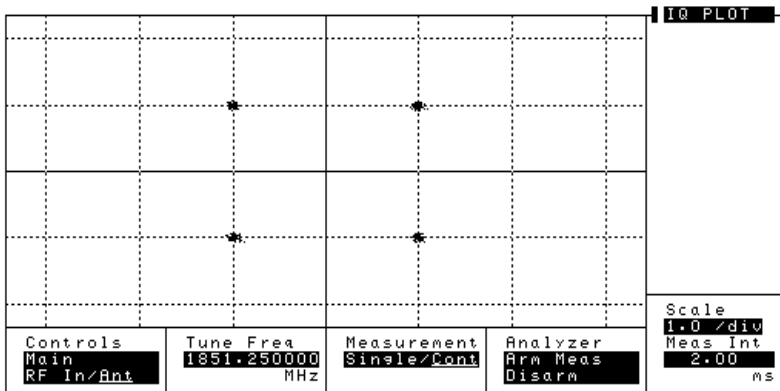

Displaying Analog Measurements

RF Measurements

Frequency Error, Frequency

RF Frequency Error and RF Frequency are displayed on the RF ANALYZER, RF GENERATOR, and AF ANALYZER screens.

Figure 3-5

Displaying RF Frequency Error or RF Frequency, and TX Power

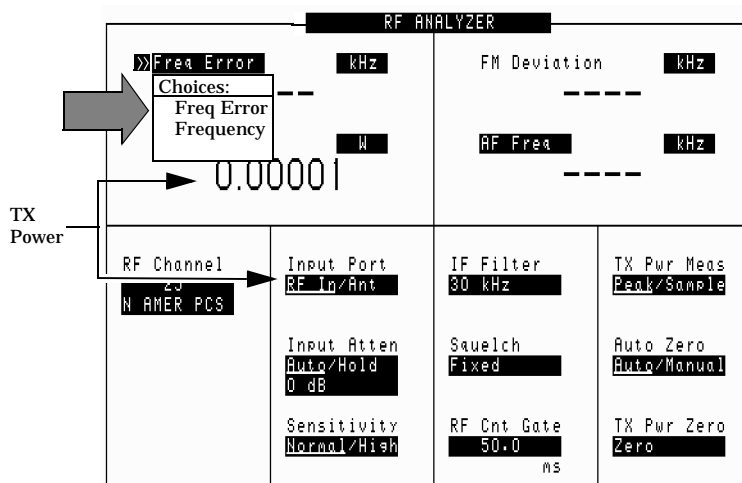

Transmitter (TX) Power

TX Power is only measured and displayed here when the Input Port on the RF ANALYZER screen is set to RF In. If Ant (antenna) is selected, the measurement is replaced by four dashes (- - - -).

You can measure low power levels on the ANT IN port using the spectrum analyzer.

Refer to “TX Power Measurement” on page 183 and “TX Pwr Zero” on page 221 for more information on measuring transmitter power.

CAUTION

Connecting a signal of >60 mW to the ANT IN (antenna) port can cause instrument damage (although internal protection circuits can typically withstand a short-duration signal of 1 or 2 Watts). If the overpower circuit is triggered, remove power from the ANT IN port and turn the Test Set off and on to reset it.

Displaying AF Measurements

FM Deviation, AM Depth, AC Level

The **AF An1 In** setting determines the AF analyzer's input and the measurement displayed in the top-right corner of the measurement area (see [Figure 3-6](#)). These measurements are displayed on the RF GENERATOR, RF ANALYZER, and AF ANALYZER screens.

[Table 3-6](#) lists the measurement displayed for each **AF An1 In** setting.

Figure 3-6 Displaying FM Deviation, AM Depth, or AC Level

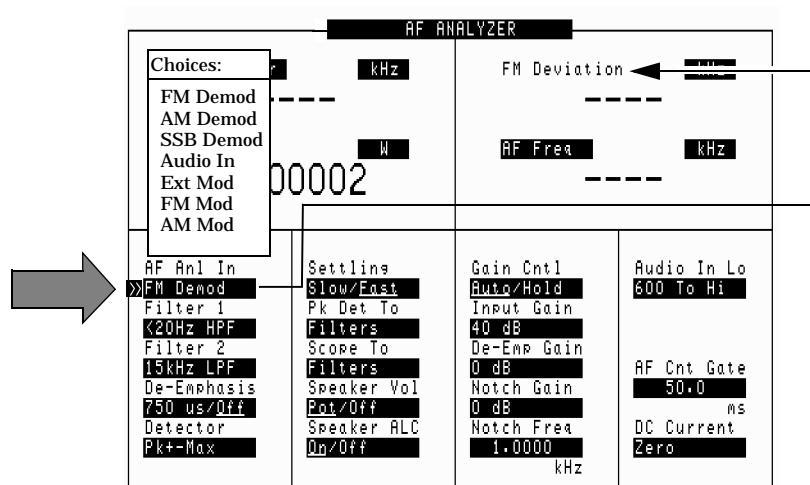

Table 3-1

| Measurement | AF An1 In Setting |
|--------------|---|
| FM Deviation | FM Demod, FM Mod |
| AM Depth | AM Demod, AM Mod |
| AC Level | SSB Demod, Audio In, Ext Mod, Audio Out |

SINAD, Distortion, SNR, AF Frequency, DC Level,

These measurements are available on the RF GENERATOR, RF ANALYZER, and AF ANALYZER screens. See [Figure 3-7](#) on page 58.

Figure 3-7 **Displaying SINAD, Distortion, SNR, DC Level, or AF Frequency**

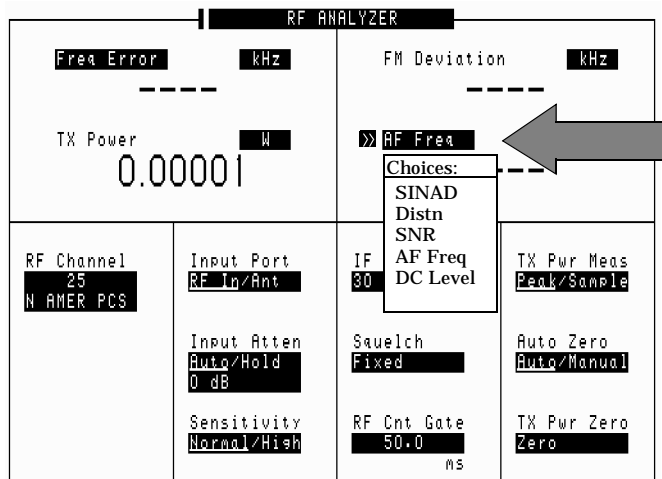

The Distortion and SINAD measurements use the variable frequency notch filter (audio analyzer screen frequency range 300 Hz – 10 kHz).

Selecting SNR (Signal/Noise Ratio) turns off any other audio measurement. For more information on making this measurement, see “RF Gen Freq” on page 213.

Displaying Measurement Results on a Meter Scale

Figure 3-8 Displaying the Meter Scale

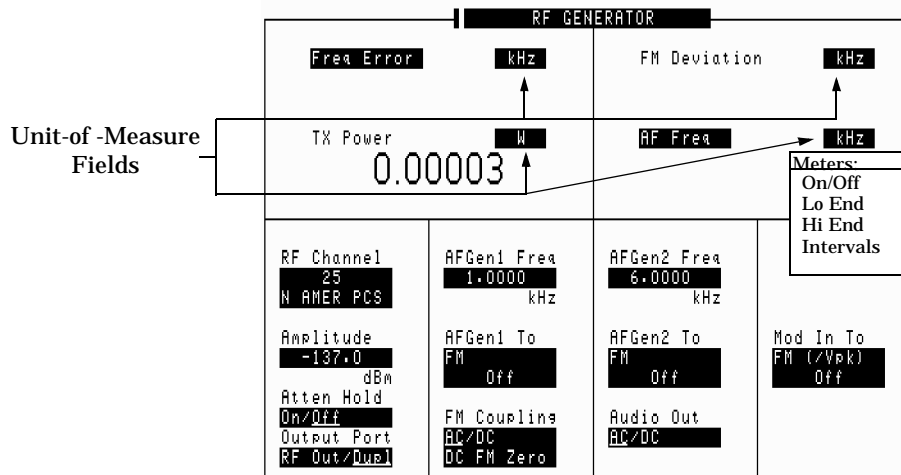

Measurement results can be displayed on a meter scale. The digital numeric value is still displayed (but smaller) under the meter scale.

To display the meter scale

1. Move the cursor to the unit-of-measure field for the measurement you want displayed on the meter.
2. Press and release the blue **Shift** key, then the **Incr Set** key to access the meter function.
3. Select **On/Off** from the **Meters:** menu (or press the **On/Off** key).

To set the meter's end points and scale intervals

1. Use the knob to select the unit-of-measure field for the measurement you want displayed on the meter.
2. Press and release the blue **Shift** key, then the **Incr Set** key to access the meter function.
3. Select **Hi End**, **Lo End**, or **Interval** from the **Meters:** menu and enter the value for your selection, then press the **Enter** key.
4. Repeat steps 2 and 3 until you have set the desired parameters for the meter's scale.

Using Channel Numbers to Set Analyzer and Generator Frequencies

RF analyzer and RF generator frequencies can be entered by channel number (the default setting) or by discrete frequencies (in MHz). The **RF Display** field on the INSTRUMENT CONFIGURE screen controls which way frequencies are entered. This screen is accessed by pressing the **Inst Config** key.

If the **RF Display** field is set to **Chan** for channel tuning, you also need to set the **RF Chan Std** field to indicate the standard for your base station (such as North American PCS). This automatically sets the correct frequency offset needed to generate reverse channel signals and analyze forward channel signals for base stations.

If you do not know the channel number of your base station, but know the transmit and receive frequencies, set the **RF Display** field to **Freq**. You can then enter these frequencies directly for the RF generator and RF analyzer during tests.

Figure 3-9 Configuration to Use Channel Numbers for RF Generator and Analyzer Settings

Set the **RF Display** field to **Chan** to turn on channel tuning.

Select the **RF Chan Std** field to display a list of system types....
 ..and then select the channel standard for testing your base stations.

| INSTRUMENT CONFIGURE | | | | |
|----------------------|------------|-------------|-------------|------------|
| Date | RF Level | RF Display | Ref Select | Firmware |
| 92397 | Off | Freq/Chan | Auto | Y.03.04 |
| MMDDYY | On/Off | | | |
| Time | RF In/Out | RF Chan Std | Ext Ref In | Total RAM |
| 15.22 | 0.0 | N AMER PCS | 10 MHz | 928 kB |
| HH.MM | | Choices: | | Serial No. |
| Beeper | Duplex Out | N AMER PCS | Frame Clock | US37120053 |
| Quiet | 0.0 | KOR PCS 0 | Output | |
| Display | | KOR PCS 1 | 2.00 s | |
| User Msgs | Antenna In | MS AMPS | | |
| Yes/No | 0.0 | LS AMPS | Out CDMA TB | |
| Range Hold | | MSL NAMPS | Internal | |
| Aut All | | MSM NAMPS | | |
| Hold All | | MSU NAMPS | | |
| State:Auto | | LSL NAMPS | | |
| | | LSM NAMPS | | |
| Notch Coupl | | | | |
| RFGen1/None | | | | |
| RFGen Volts | | | | |
| 50_ahm/enf | | | | |

Calibrating the Channel Power Measurement – CDMA Analyzer

To calibrate a channel power measurement using the internal CDMA generator:

- Step 4.** Remove power from the RF IN/OUT (or ANT IN) port.
- Step 5.** Go to the CDMA ANALYZER screen and choose the **Chan Pwr** measurement.
- Step 6.** Set the **Tune Freq** field (or **RF Channel** field) to the center frequency of your CDMA signal.
- Step 7.** Select the **Chn Pwr Cal** field and wait until the calibration is complete.

Calibrating the Channel Power Measurement – Code Domain

To calibrate a channel power measurement using the internal CDMA generator:

- Step 8.** Remove power from the RF IN/OUT (or ANT IN) port.
- Step 9.** Go to the CODE DOMAIN screen and choose the **CD Setup** (IS-95 only) or **Reference** (IS-2000) control.
- Step 10.** Select **Abs** from the **CD pwr unit** field.
- Step 11.** Select the **Chn Pwr Cal** field and and press the knob to start calibration. Wait until the calibration is complete.

Calibrating the Adjacent Channel Power (ACP) Measurement

To calibrate an ACP measurement using the internal CDMA generator:



- Step 12.** Remove power from the RF IN/OUT (or ANT IN) port.
- Step 13.** Go to the CDMA ANALYZER screen and choose the ACP measurement.
- Step 14.** Set the Tune Freq field (or RF Channel field) to the center frequency of your CDMA signal.
- Step 15.** Select the ACP Cal field and wait until the calibration is complete.

Changing the Increment or Decrement Setting

Specifying An Increment Value for the Arrow Keys or Knob

The **Incr Set** key is used to assign a specific increment value. The increment value may use different units than the field you are incrementing/decrementing. For instance; if the RF generator's **Amplitude** setting is displayed in dB μ V, you could increment in units of dB or mV.

To change the increment/decrement value

- Step 1.** Move the cursor to the numeric entry field to be changed.
- Step 2.** Press **Incr Set**, and enter the desired incremental value and unit-of-measure using the DATA ENTRY keys.
- Step 3.** Use the down-arrow and up-arrow keys   or cursor control knob to increment the field's value. The field's value changes by the value you set for each key press or knob click.

Using the Factor of 10 Increment/Decrement Keys

The **Incr \times 10** and **Incr \div 10** keys change the increment/decrement value by a factor of 10.

For example, if you set the increment for **Tune Freq** to 10 MHz for every click of the knob or push of the down-arrow or up-arrow keys, pushing **Incr \times 10** changes the increment value to 100 MHz.

Using Measurement Limit Indicators

The **Lo Limit** and **Hi Limit** functions are used to define a measurement “window.” You can set a high limit, a low limit, or both. When limits are assigned, **Lo**, **Hi** or both are indicated on the screen.

A measurement that goes above or below the defined limits causes three things to happen:

1. A message appears at the top of the screen indicating a limit was exceeded.
2. The **Lo** or **Hi** indicator flashes.
3. The beeper beeps (if it is has been enabled in the INSTRUMENT CONFIGURE screen).

Limits are helpful when you can't watch the Test Set's display while you are making an adjustment on the equipment you are testing or repairing. They are also a convenient way of alerting you to long-term measurement drift.

To set high and low limits

- Step 1.** Position the cursor in front of the unit-of-measure for the measurement for which you are setting limits.
- Step 2.** Press and release the **Shift** key, then the down-arrow key to access the **Lo Limit** function, and enter the measurement's low-limit value and its unit-of-measure.¹
- Step 3.** Press and release the **Shift** key, then the up-arrow key to access the **Hi Limit** function, and enter the measurement's high-limit value and its unit-of-measure.¹

To reset or remove limits

To *reset* a limit that has been exceeded

- Step 4.** Position the cursor in front of the measurement's unit-of-measure.
- Step 5.** Press and release the **Shift** key, then the down-arrow (or up-arrow key) to access the **Lo Limit** (or **Hi Limit**) function.
- Step 6.** Press **Enter** or **Shift** then **Hold** to access the **Meas Reset** function.

1. The fundamental unit for the limits does not have to be the same as the measurement's units. For instance; when measuring AC Level in Volts, you can set high and low limits in units of dBm.

To *remove* a limit

- Step 1.** Position the cursor in front of the unit-of-measure for the assigned limit.
- Step 2.** Press and release the **Shift** key, then the down-arrow (or up-arrow key) to access the **Lo Limit** (or **Hi Limit**) function, then press the **On/Off** key.

Setting A Measurement Reference

The reference set (Ref Set) function establishes a measurement reference point. This allows you to make a direct comparison between two measurement results, or between a measurement standard and the actual measurement results.

Depending on the type of measurement, referenced measurements are displayed in one of two ways:

1. *Displayed value = Measurement – Reference.* The difference between the measured value and the reference value is displayed.

or

2. *Displayed value = Measurement ÷ Reference.* A ratio of the measured value to the reference value is displayed. This ratio is expressed in dB.

To set a reference

- Step 1.** Position the cursor in front of the unit-of-measure for the measurement you want to set the reference for.
- Step 2.** Press and release the **Shift** key, then the **Incr ÷ 10** key to access the **Ref Set** function.
- Step 3.** Enter a reference value, then press **Enter**. (To use the currently measured value as a reference, just press **Enter**.)
- Step 4.** The Reference indicator shows that an internal reference has been set.
- Step 5.** To turn the reference off press and release the **Shift** key, then the **Incr + 10** key to access the **Ref Set** function, and then press the **On/Off** key.

Averaging Measurements

The **Avg** (average) function allows you to display the average value of a number of measurements. You enter the number of measurement samples used to calculate and display the measurement average. This dampens the effects of rapidly changing measurements, providing a more usable measurement display.

To use measurement averaging

- Step 1.** Position the cursor in front of the measurement's unit-of-measure.
- Step 2.** Press and release the **Shift** key, then the **Incr × 10** key to access the **Avg** function.
- Step 3.** Enter the desired number of measurement samples to be used for calculating the average, then press the knob or the **Enter** key.

or

Press **On/Off** to use the currently-displayed number of samples.
- Step 4.** To turn averaging off, position the cursor in front of the unit-of-measure and press and release the **Shift** key, then the **Incr × 10** key to access the **Avg** function, then press the **On/Off** key.

How the Test Set Averages Measurements

When the averaging function is first enabled, a numeric average is calculated and displayed each time a measurement is made. This continues until the specified number of samples is reached. From that point on, the averaging function performs an exponential filtering operation that mimics an RC filter.

Because of the exponential response, any large measurement changes result in a displayed value that ramps up or down to the actual measured value.

A measurement reset clears the measurement history for all measurements and starts the averaging process over. (Press and release the **Shift** key then the **Hold** key (**Meas Reset**) to reset the measurement.)

Setting an RF Generator/Analyzer Offset

You can set a fixed frequency offset between the RF generator and the RF analyzer. This feature is convenient for testing radios with a fixed transmit/receive frequency offset.

To set an RF Offset

- Step 1.** Go to the INSTRUMENT CONFIGURE screen.
- Step 2.** Set the **RF Display** field to **Freq**.
- Step 3.** Set the **RF Offset** field to **On**.
- Step 4.** Select the **(Gen)-(An1)** field and enter the frequency offset value.
- Step 5.** Go to the RF GENERATOR screen.
- Step 6.** Select the **RF Gen Freq** field, and rotate the cursor control knob to vary the RF generator's frequency.
- Step 7.** Go to the RF ANALYZER screen. Notice that the **Tune Freq** value changes to maintain the offset between the generator and the analyzer. (You can use the **Prev** key to switch between the generator and analyzer screens.)

Saving and Recalling Instrument Setups

The save and recall functions allow you to store different instrument setups and retrieve them later, eliminating the task of re-configuring the Test Set.

The number of available save registers depends on how many changes were made to the *base* instrument setup for each save. (See “[BASE Settings](#)” on page 72.) The smaller the number of changes, the greater the number of save registers that can be used (typically over 200).

Save/Recall register settings can be saved to internal RAM or to a PC card. Saving registers to a PC card allows you to “back up” the settings in case you need to clear them from memory for running large programs, or when a firmware upgrade is performed (see “[Memory Considerations](#)” on page 72).

To save an instrument setup

- Step 1.** Go to the I/O CONFIGURE screen.
- Step 2.** Select the storage media using the **Save/Recall** field. (The default is internal memory.)
- Step 3.** Make any changes to the instrument that you want to save in a register.
- Step 4.** Press and release the **Shift** key then the **Recall** key to access the **Save** function.
- Step 5.** Use the DATA ENTRY keys or the **save:** menu to enter the register’s name.

To recall an instrument setup

- Step 1.** Select the I/O CONFIGURE screen.
- Step 2.** Select the media to recall settings from using the **Save/Recall** field. The default is internal memory.
- Step 3.** Press **Recall**.
- Step 4.** Use the knob to select the desired setup to be recalled from the **Recall** menu.

To remove (clear) an individual save register

- Step 1.** Specify where the register is stored using the **Save/Recall** field on the I/O CONFIGURE screen.
- Step 2.** Press **Recall**.
- Step 3.** Use the knob to position the cursor in front of the register to be removed from the **Recall** menu at the bottom-right of the screen. The register name and percentage of memory occupied by that register are indicated at the top of the screen.
- Step 4.** Press **Yes On/Off**. A prompt appears, asking if you want to delete the save register.
- Step 5.** Press **Yes On/Off**.

To clear all save registers

- Step 1.** Press **Recall**.
- Step 2.** Use the knob to position the cursor in front of the ***Clr All*** entry in the **Recall** menu at the bottom-right of the screen.
- Step 3.** Press the knob or press **Enter**. A prompt appears at the top of the screen to verify that you want to clear all registers.
- Step 4.** Press **Yes On/Off**.

Register Names

You can use any number, letter, or combination of numbers and letters as a name for storing instrument settings. For instance; if you want to save a setup for testing a “Vulcan7” radio, you can save the setting as “VULCAN7”.

Two register names are reserved for special purposes: POWERON and BASE.

POWERON Settings

When the Test Set is turned on, it uses a set of instrument setup parameters specified at the time of manufacture. You can have the instrument power up in a different state by making the desired changes to the original settings, and then saving them using the name POWERON.

The next time the instrument is turned on, the instrument returns to the state present when you saved the POWERON setting. For instance; if the SCOPE screen was displayed when POWERON was saved, it is the screen that is displayed when you turn the instrument on.

BASE Settings

The *BASE* register contains any field settings the user has saved that are different from the instrument preset state. It establishes a reference point for all future saves. If a base is not saved, the preset state is used as the reference.

When you save an instrument setup, the new setup is compared to the base settings, and any *differences* are stored under the register name you supply. Because only differences are stored, a much larger number of instrument setups can be saved than if the contents of every field was saved.

When you recall an instrument setting, every field is reset to the base settings. The saved settings are then used to re-establish the desired instrument setup.

You can define your own base setting. If your desired settings are very different from the preset values, you may want to change the *BASE* register. This will decrease the amount of memory used to save each setup, and allow you to save many more setups.

CAUTION

Since each save/recall register only contains the differences between the setup being saved and the present *base* register settings, changing the base settings causes all other saved setups to be erased from memory (including the *POWERON* setting if one has been saved). Unless you consistently change the same fields to the same value each time you use the instrument, you should avoid creating your own *BASE* settings.

Memory Considerations

When the *Save/Recall* field of the *I/O CONFIGURE* screen is set to *Internal*, programs are saved to the same non-volatile RAM used to create RAM disk(s) and run *IBASIC* programs. By saving a large number of instrument setups, you reduce the amount of RAM available to run programs. If you get a “memory overflow” message while trying to load a program, you must clear one or more save/recall registers to free RAM space.

Instrument Hardware Changes

Recalling a saved register that uses a hardware option that has been removed results in unspecified operation. Re-install the needed option before attempting to recall the associated register(s).

Using USER Keys

You can use user keys to move quickly between fields on the same screen, and to access fields that are not normally available on the screen you are using.

Local user keys are used to move between settings on the screen that is displayed. Five local user keys are available for each screen: **k1**, **k2**, **k3**, **k4**, and **k5**. When the user key is pressed, the cursor instantly moves to, and selects, the assigned field; eliminating the need to turn and push the knob. Using these keys removes any other local user keys you may have set up.

Global user keys are used to access settings that are not available on the current screen. Three global user keys are available: **k1'**, **k2'**, and **k3'**. (Use the **Shift** key to access the global user keys)

Using Pre-Defined USER Keys

- Step 1.** Press and release the **Shift** key, the **k4** key; then the **Enter** key. The numbers 1 through 5 appear in front of various fields. (See [Figure 3-10](#).)
- Step 2.** Press the USER keys (**k1** to **k5**) and notice how the cursor immediately moves to the corresponding field.
- Step 3.** To stop using the default user keys, press and release the **Shift** key, then the **k5** key to access the **Release** function; then press the **Enter** key.

Figure 3-10 An Example of Pre-Assigned Local User Keys

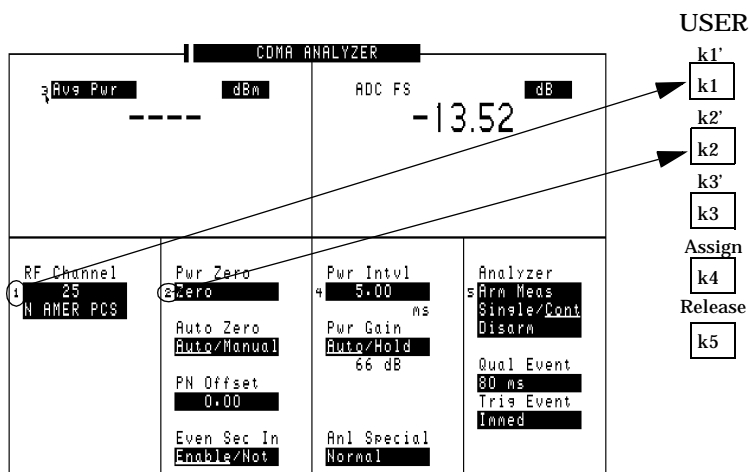

Assigning and Releasing USER Keys

When defining user keys, the **Assign** function is used to create key definitions; the **Release** function removes the definitions. Re-assigning a user key to a different field automatically releases it from its previous setting.

To assign local user keys

- Step 1.** Move the cursor to the field that you want to assign to a local user key.
- Step 2.** Press and release the **Shift** key, then the **k4** key to access the **Assign** function. Then press a USER key (**k1-k5**). The user key number appears in front of the field you assigned it to. (Since the cursor is at the newly assigned field, the USER key number is hidden until the cursor is moved.)

To release local user keys

- Step 1.** Display the screen containing the user key assignment to be removed.
- Step 2.** Press and release the **Shift** key, then the **k5** key to access the **Release** function; then press the USER key (**k1-k5**).

To assign global user keys

- Step 1.** Move the cursor to the field you want to assign a global USER key to.
- Step 2.** Press and release the **Shift** key, then the **k4** key to access the **Assign** function. Then press **Shift** and a USER key (**k1'- k3'**). Unlike a local user key, the user key number *does not* appear at this field; instead, a prompt appears at the top of the screen confirming the key assignment.

To release global user keys

- Step 1.** Move the cursor to the field with the global user key assigned to it.
- Step 2.** Press and release the **Shift** key, then the **k5** key to access the **Release** function. Then press **Shift** and the user key to be released.

Replacing Batteries

Test Set backs up its RAM using two battery types.

One type is a set of two AA batteries mounted inside the rear panel of the Test Set. You must periodically change these batteries.

The second type of RAM backup battery is not user serviceable.

CAUTION

Failure to take prompt action may result in loss of RAM data including IBASIC programs and SAVE / RECALL states stored in the RAM.

NOTE

Do not use rechargeable batteries.

To change the AA batteries, use the following procedure:

1. Turn off power and unplug the Test Set.
2. Remove the six screws in the rear panel using a TX-15 TORX (R) screwdriver.
3. Remove the rear panel.
4. Replace the AA batteries as indicated in the battery holder.
5. Replace the rear panel. Dispose of used batteries properly.

- “Using the RF Tools Program” on page 79
- “Using the Code Domain Analyzer” on page 108
- “Using the Spectrum Analyzer” on page 111
- “Using the Voltmeter and Audio Frequency Counter” on page 118
- “Using the Oscilloscope (Scope)” on page 119
- “Securing a Test Procedure” on page 123
- “Clearing RAM” on page 124
- “Using the LISTOPTS (list options) Program” on page 125
- “Using the DEMO Program” on page 126
- “Using the ST_PLT (store or plot) Program” on page 127

Using the RF Tools Program

The RF Tools program resides in the Test Set's ROM. This guide supports RF Tools version B.02.11.

- “Loading and Running RF Tools” on page 80
- “Test Results/BTS Utility Setup” on page 81
- “Swept Gain” on page 83
- “Discrete Frequency Insertion Loss” on page 87
- “Swept Insertion Loss” on page 89
- “Swept Return Loss” on page 92
- “Cable Fault” on page 97
- “Replot Data Files” on page 102
- “Transfer Stored Data” on page 104
- “SA (Spectrum Analyzer) Self Calibration ON/OFF” on page 105
- “Catalog PC (Memory) Card” on page 106

Loading and Running RF Tools

1. Press the MENU key to display the SOFTWARE MENU screen (shown below).

Figure 4-1 SOFTWARE MENU Screen

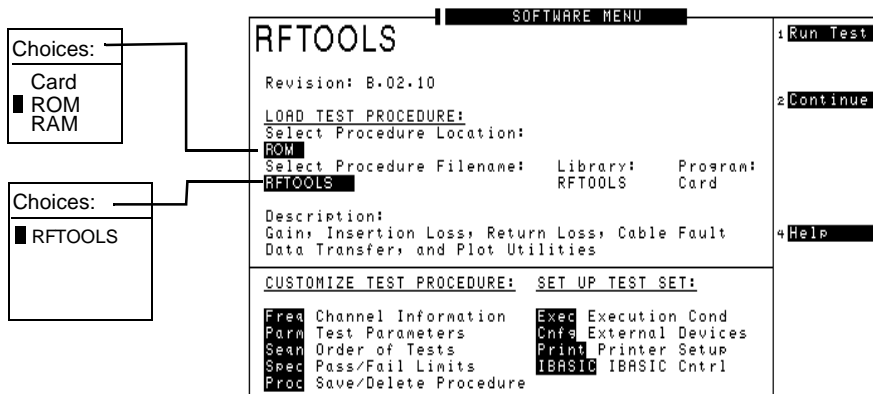

2. Position the cursor at the highlighted area under **Select Procedure Location** and push the knob to select it. A **Choices** menu appears.
3. Position the cursor at **ROM** and select it.
4. Position the cursor at the highlighted area under **Select Procedure Filename** and select it. A **Choices** menu appears.
5. Position the cursor at **RFTOOLS** and select it.
6. Press k1 (**Run Test**). The software is now loading. Wait for the RF Tools Main Menu screen ([Figure 4-2](#)).
7. Select an item from the menu.

Figure 4-2 RF Tools Main Menu Screen

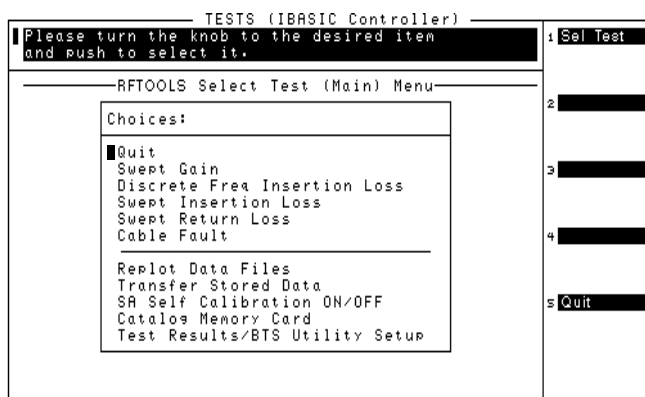

Test Results/BTS Utility Setup

Use this setup to configure a method for measurement data collection. Measurement results may be collected using a printer, a laptop, or a PC card.

Figure 4-3 Test Results/BTS Utility Setup Screens

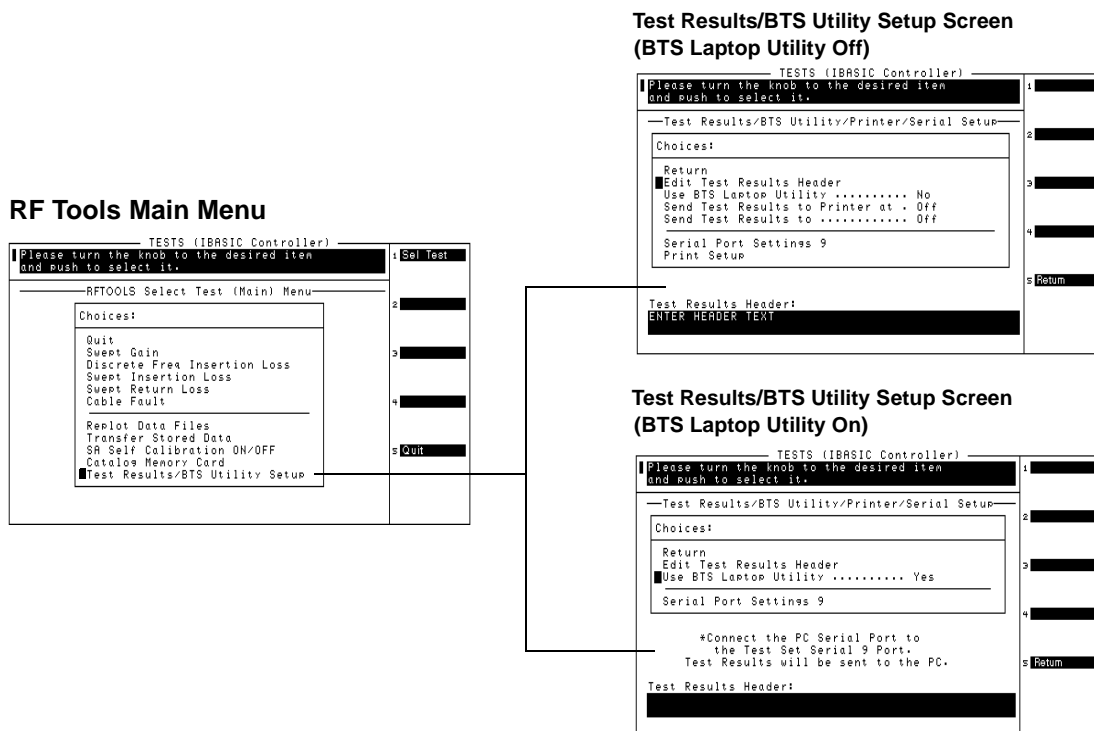

To use a laptop and the BTS Laptop Utility for data collection:

This function of RF Tools is used with the BTS Laptop Utility program. Test results can be stored as ASCII or plot data. For more information on this utility, refer to the on-line help accompanying the BTS Laptop Utility software.

1. Position the cursor at **Use BTS Laptop Utility** and select it (see [Figure 4-3 on page 81](#)). The screen changes to show only the appropriate options.
2. Position the cursor at **Serial Port Settings 9** and select it. The serial port settings appear. Serial baud, parity, data length, stop length, and flow control can be edited.
3. Confirm that these serial port settings match the BTS Laptop Utility settings on the laptop.
4. Press **k5 (Return)** to return to the Test Results/BTS Utility/Printer/Serial Setup.
5. Press **k5 (Return)** to exit the setup.

To use a printer for data collection:

1. If **Use BTS Laptop Utility** is set to **Yes**, change it to **No** by selecting the field.
2. Position the cursor at **Send Test Results to Printer at** and select it. A **Choices** menu appears.
3. Position the cursor at the correct port and select it.
4. Position the cursor at **Print Setup** and select it. Lines per page and form feed locations can be edited.
5. Press **k5 (Return)** to go back to the previous menu.

To use a laptop interface other than the BTS Laptop Utility

1. If **Use BTS Laptop Utility** is set to **Yes**, change it to **No** by selecting the field.
2. Position the cursor at **Send Test Results** to and select it. A **Choices** menu appears.
3. Position the cursor at **Serial 9** and select it.
4. Position the cursor at **Serial Port Settings 9** and select it. A list of serial port settings appears.
5. Confirm that these serial port settings and the settings on the laptop match.
6. Press **k5 (Return)** to return to the Test Results/BTS Utility/Printer/Serial Setup.
7. Press **k5 (Return)** to exit the setup.

Swept Gain

Measurement Description

This test measures the gain of a device by sweeping it over the specified frequency range. Gain is the ratio of the output power to the input power. For the swept gain test, gain is measured in dB. The gain is the output power in dBm minus the input power in dBm. For example, if the amplifier has an output of 22 dBm and an input of 4 dBm, it has a gain of 18 dB.

Making the Measurement

NOTE

This test radiates a test signal when testing antennas or cables with antennas attached to them. Verify that the level and frequency span used for the test cannot result in interference to other nearby antennas. To minimize interference when running the program, set the power level at the DUPLEX OUT port to the minimum value needed for good measurement resolution. Set the frequency range carefully.

1. Select **Swept Gain** from the Select Test (Main) Menu. The Swept Gain Measurement menu will appear.

Figure 4-4 Selecting the Swept Gain Measurement Test

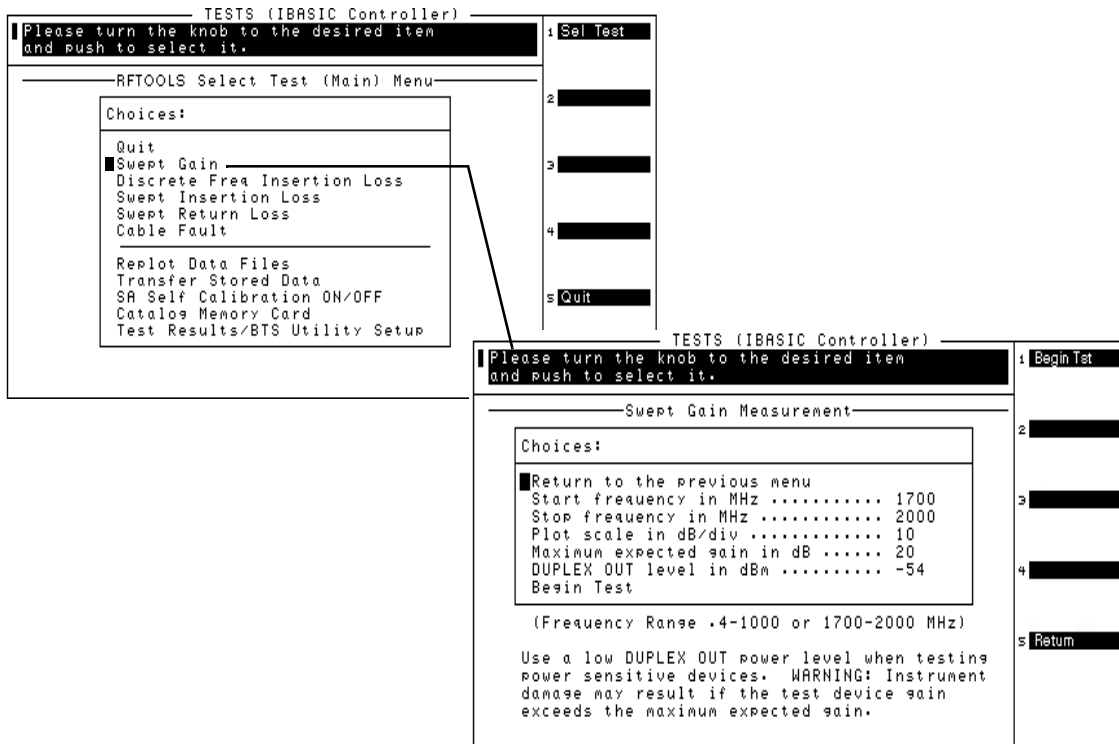

2. Position the cursor at **Start Frequency in MHz** and select it. Enter a value for the start of the frequency sweep from 0.4 MHz to 1000 MHz or 1700 MHz to 2000 MHz.
3. Position the cursor at **Stop frequency in MHz** and select it. Enter a value from 0.4 MHz to 1000 MHz or 1700 MHz to 2000 MHz. This value should be larger than the start frequency and in the same frequency band.
4. Position the cursor at **Plot scale in dB/div** and select it. A **Choices** menu appears. The available choices are 1, 5 or 10.
5. Position the cursor at **Maximum Expected Gain in dB** and select it. Enter a value in the range of - 50 to +40 dB. This parameter sets the expected worst case power for the ANT IN port. It is very important to overestimate the expected gain to avoid damage to the ANT IN port. This parameter also determines plot resolution by setting the upper limit.

6. Position the cursor at **DUPLEX OUT Level in dBm** and select it. Enter the power level, -54 to $+10$ dBm, at which the test should be conducted. If you are testing a power sensitive device, enter a low level value to avoid damage to that device.

CAUTION

Damage may result if the power input to the Test Set's ANT IN port exceeds 60 mW (which is equivalent to 18 dBm). Damage may also result to the unit-under-test if it is overdriven by the DUPLEX OUT power level. To avoid damage to the unit under test, enter a low power level for the **DUPLEX OUT level in dBm** parameter.

7. Press **k1 (Begin Tst)**.

Figure 4-5 Swept Gain Setups

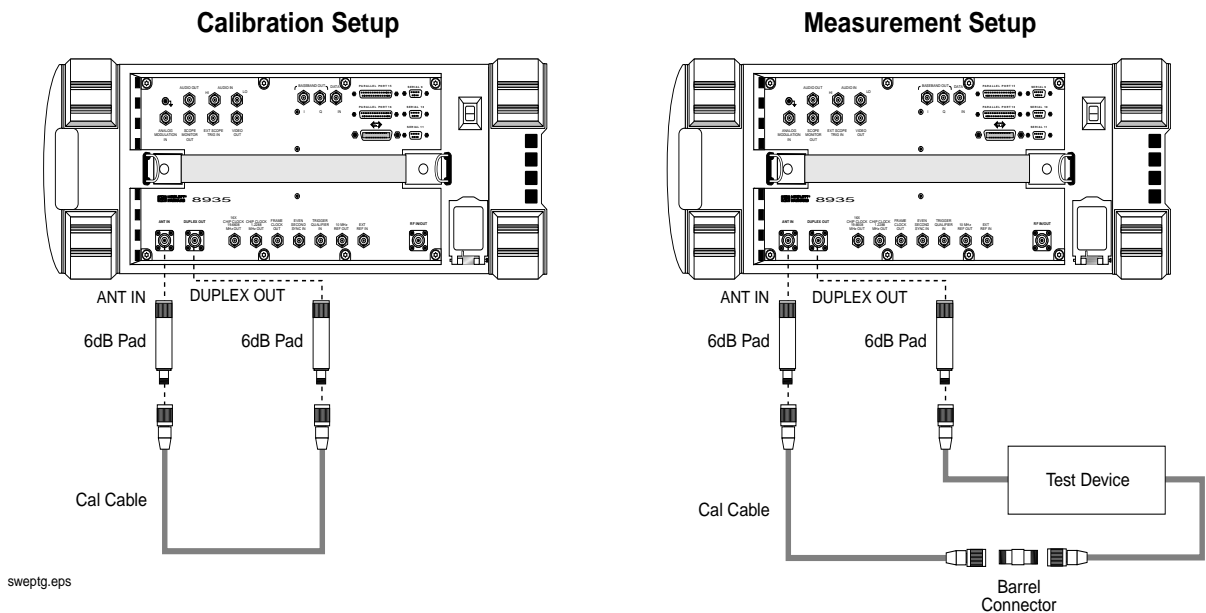

8. A setup screen appears with a diagram of the necessary connections, similar to the Calibration Setup of Figure 1-2. This test requires two 6-dB pads (attenuators). The pads are put on the Test Set's ANT IN and DUPLEX OUT ports to reduce impedance mismatch error at these ports. A reference level is obtained by connecting a short calibration cable between the pads on the DUPLEX OUT and ANT IN ports. Set up the hardware, then press **k1 (Proceed)** or the knob to continue.
9. Another setup screen appears similar to the Measurement Setup of Figure 4-5. Attach the device to be tested between the calibration cable and one of the pads. In this step, a measurement is made of the additional gain from the reference level. Press **k1 (Proceed)** or the knob to continue.

- The trace of the device gain over the frequency range swept is displayed. If the gain exceeds 40 dB, it will not appear on the trace. The maximum gain is also displayed as text on the screen. To save the plot to a PC card, press **k4** (**Save Plot**) and use the knob to enter a filename. Press **k5** (**Scr Dump**) to send the image to a printer or to the BTS Laptop Utility. Directions will appear at the top of the screen. Press **PRINT** and allow the image to print to the connected device. Then, press **PAUSE/CONTINUE**. Press **k1** (**Proceed**) when you are ready to continue.

Figure 4-6 Example of a Swept Gain Plot Screen

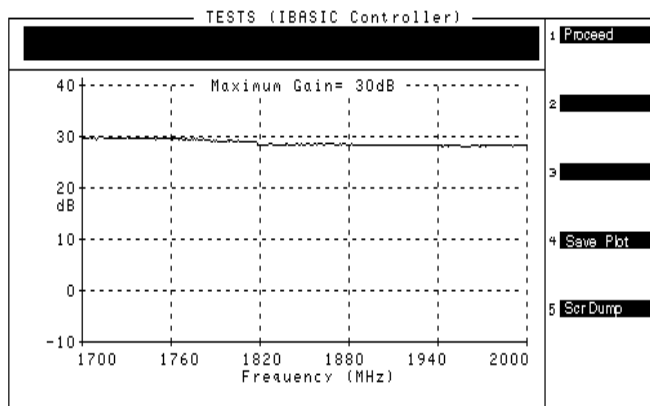

- The swept gain results screen (see [Figure 4-7](#)) appears with the test results. If the BTS Laptop Utility is in use, this data is collected by the laptop. If you wish to repeat the test using the same calibrated devices and test parameters, press **k1** (**Repeat**). To re-display the plot screen, press **k3** (**Disp Plot**). To return to the **Select Test Menu**, press **k5** (**Return**).

Figure 4-7 Example of a Swept Gain Results Screen

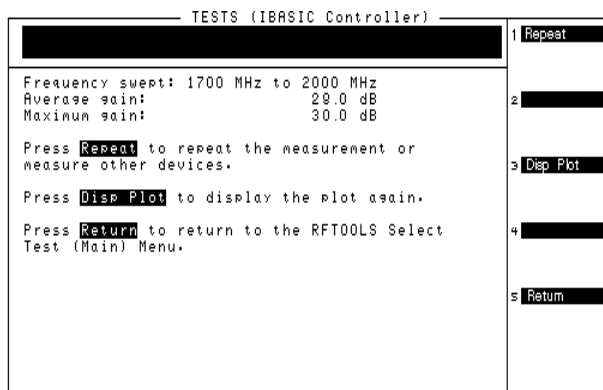

Specifications

- Frequency Range: 0.4-1000 MHz, 1.7-2.0 GHz
- Swept Signal Level: -54 dBm to +10 dBm

Discrete Frequency Insertion Loss

Measurement Description

The discrete frequency insertion loss test measures the loss of a cable or device at a specific frequency. DSP (Digital Signal Processing) is used to determine the results of this test, making it more accurate than the Swept Insertion Loss test.

Making the Measurement

1. Select **Discrete Freq Insertion Loss** from the Select Test (Main) Menu. The **Discrete Frequency Insertion Loss Test** menu will appear.

Figure 4-8 Selecting the Discrete Frequency Insertion Loss Test

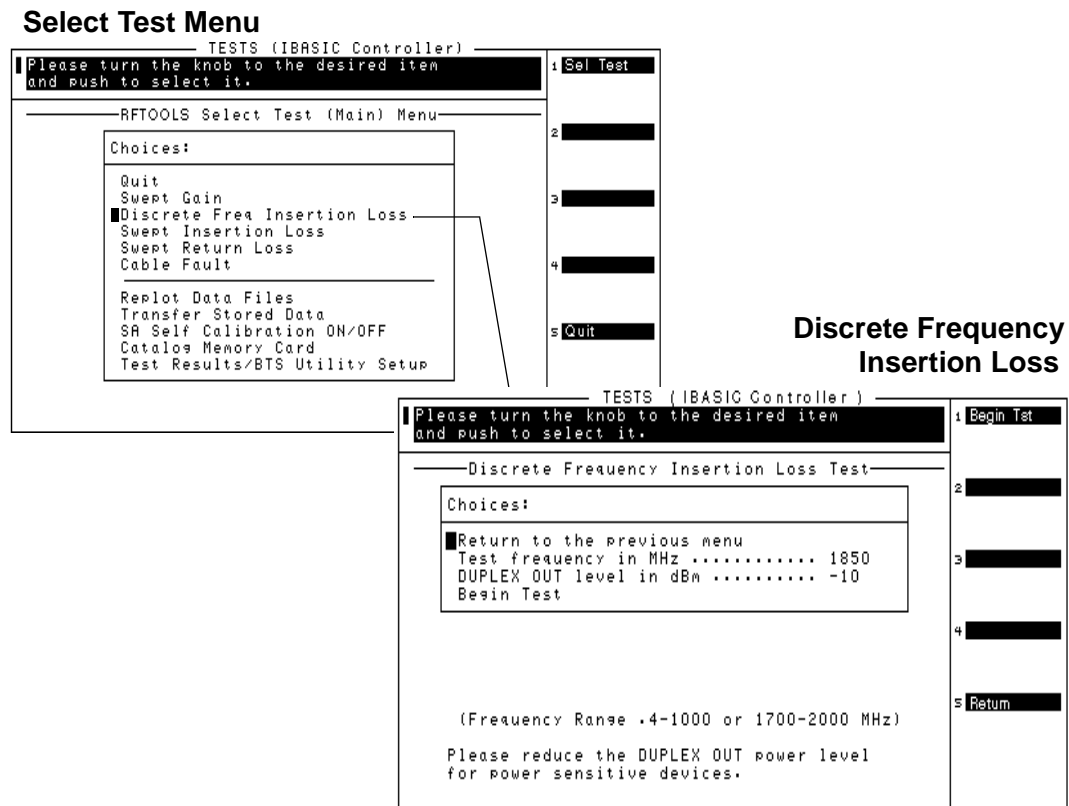

2. Position the cursor at **Test frequency in MHz** and enter the specific frequency to be tested.

3. Position the cursor at **DUPLEX OUT Level in dBm** and enter the power level at which the test should be conducted.
4. Press **k1 (Begin Tst)** to begin the test.

Figure 4-9 Discrete Frequency Insertion Loss Setups

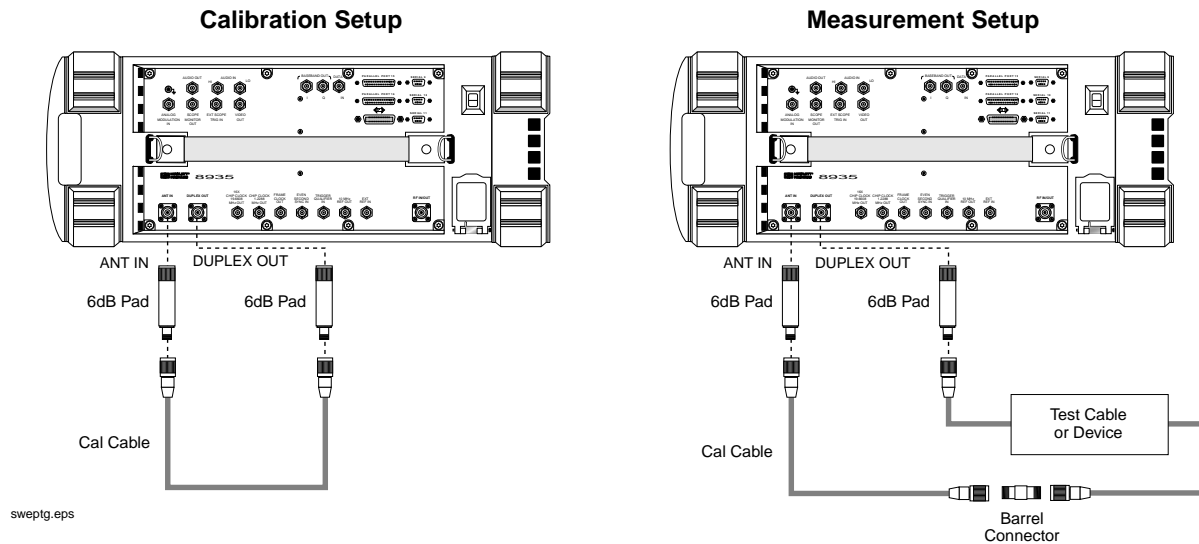

5. A screen appears with a setup diagram. (Figure 4-9) This test requires two 6-dB pads. The pads are put on the ANT IN and DUPLEX OUT ports on the Test Set to reduce impedance mismatch error at these ports. A reference level is obtained by connecting a short calibration cable between the pads on the DUPLEX OUT and ANT IN ports. Press **k1 (Proceed)**.
6. After the Test Set has finished calibrating, a second diagram appears on the screen. Connect the test cable or device to be tested between the calibration cable and one of the pads. Press **k1 (Proceed)**.
7. The discrete frequency insertion loss results screen appears with the results of the test. The loss is expressed as a negative number in this particular test.

NOTE

The insertion loss at the specified frequency is displayed twice. The second display is enlarged for easier reading.

8. Press **k1 (Proceed)** when you are finished with this screen. The Discrete Frequency Insertion Loss Test menu appears. If you would like to repeat the measurement press **k1 (Begin Tst)**. The calibration step will be skipped if none of the parameters were changed. To exit the test press **k5 (Return)**.

Swept Insertion Loss

Measurement Description

This test measures the loss of a cable or device by sweeping it over the specified frequency range. This test uses the Spectrum Analyzer to make measurements.

Making the Measurement

1. Select **Swept Insertion Loss** from the Select Test (Main) Menu. A Swept Insertion Loss Information menu will appear.

Figure 4-10 Selecting the Swept Insertion Loss Measurement

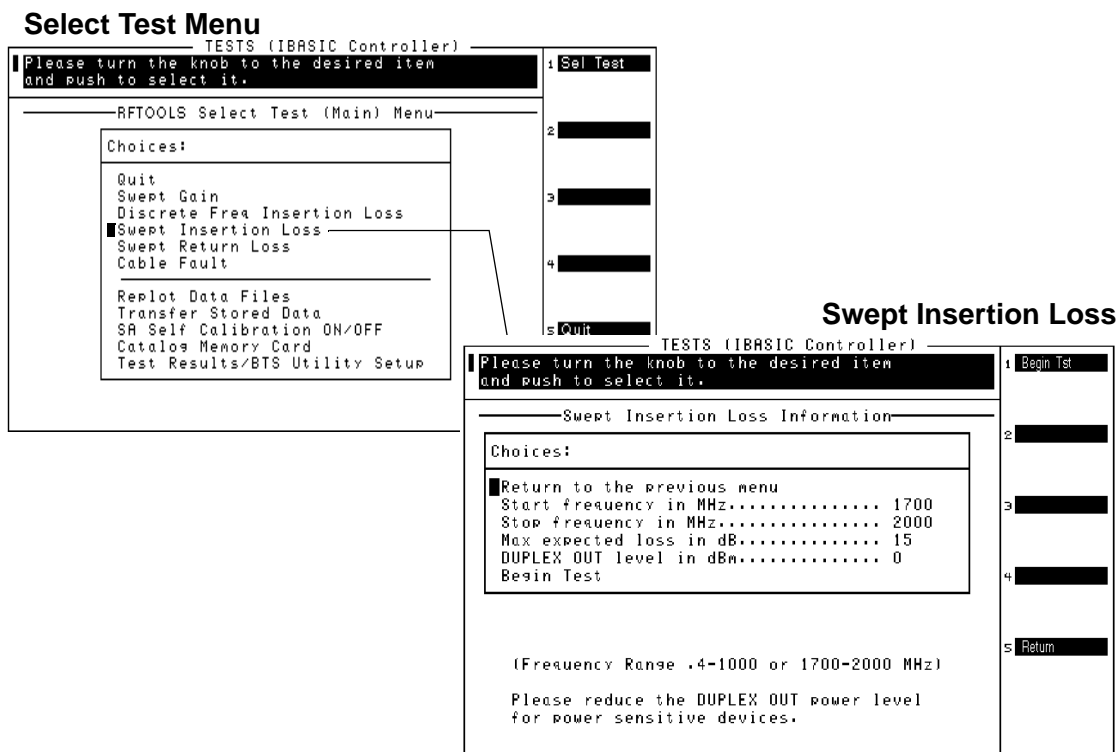

2. Position the cursor at **Start frequency in MHz** and select it. Enter a value for the start of the frequency sweep from 0.4 MHz to 1000 MHz or 1700 MHz to 2000 MHz.
3. Position the cursor at **Stop frequency in MHz** and select it. Enter a value from 0.4 MHz to 1000 MHz or 1700 MHz to 2000 MHz. This value should be larger than the start frequency.

4. Position the cursor at **Max expected loss in dB** and enter the greatest loss expected through your device. The insertion loss will be displayed from 0 dB to the value entered in this field. Therefore, if the **Max expected loss in dB** is set higher than the measured insertion loss, the plot will not display any test data. Enter the appropriate value.
5. Position the cursor at **DUPLEX OUT level in dBm** and enter the appropriate value. Unless you are measuring loss through a power sensitive device, the default level should work correctly.
6. Press **k1 (Begin Test)** to begin the test.

Figure 4-11 Swept Insertion Loss Setups

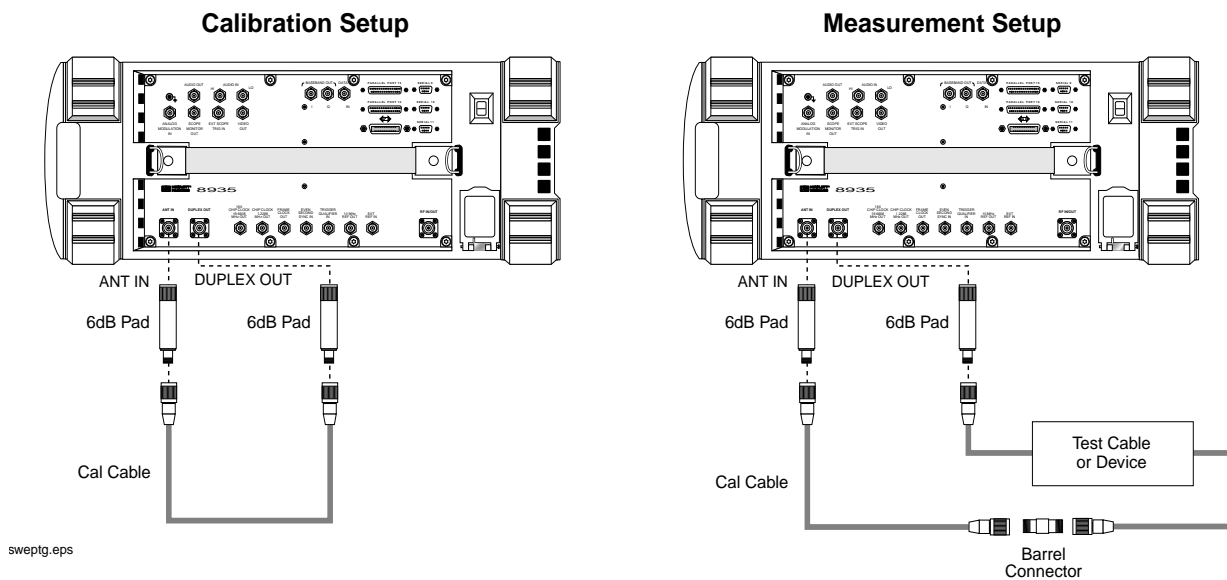

7. A calibration setup screen appears with a diagram of the necessary connections (Figure 4-11). This test requires two 6-dB pads. The pads are put on the ANT IN and DUPLEX OUT ports on the Test Set to reduce impedance mismatch error at these ports. A reference level is obtained by connecting a short calibration cable between the pads on the DUPLEX OUT and ANT IN ports. Setup the hardware, then press **k1 (Proceed)** or the knob to continue.
8. After the Test Set has finished calibrating, a second diagram similar to the Measurement Setup of Figure 4-11 appears on the screen. Connect the test cable or device to be tested between the calibration cable and one of the pads. Press **k1 (Proceed)** or the knob to continue.

9. The trace of the cable loss over the frequency range swept is displayed. The average loss is also displayed on the screen. To save the plot to a PC card, press **k4** (**Save Plot**) and use the knob to enter a filename. Press **k5** (**Scr Dump**) to send the image to a printer or to the BTS Laptop Utility. Directions will appear at the top of the screen. Press **PRINT** and allow the image to print to the connected device. Then, press **PAUSE/CONTINUE**. Press **k1** (**Proceed**) when you are ready to proceed
10. The swept insertion loss results screen appears with the test results. If the BTS Laptop Utility is in use, this data is collected by the laptop. If you wish to repeat the test using the same calibrated devices and test parameters, press **k1** (**Repeat**). To redisplay the plot screen, press **k3** (**Disp Plot**). To return to the **Select Test (Main) Menu**, press **k5** (**Return**).

Estimating Swept Insertion Loss Using a Single Connection

Rather than directly measuring the transmitted signal (requiring connections at both ends), a known high-quality short can be put at the end of the cable. Knowing that this will reflect 100% of the signal, the Swept Return Loss test ([page 92](#)) can be used and the measured return loss in dB can simply be divided by 2 to get the system's estimated insertion loss. If the return loss is not in dB, the square root of the measurement would be the system's insertion loss. An open can also be used instead of a short, but the results will not be as precise.

Specifications

- Frequency Range: 0.4-1000 MHz, 1.7-2.0 GHz
- Swept Signal Level: -54 dBm to +10 dBm
- Insertion Loss Accuracy: +/- 0.75 dBm

Swept Return Loss

Measurement Description

Swept return loss is a measure of reflection characteristics. The purpose of the swept return loss test is to detect problems in the antenna feedline system and the antenna itself. A portion of the incident power will be reflected back to the source from each transmission line fault as well as the antenna. The ratio of the reflected voltages to the incident voltage is called the reflection coefficient. The reflection coefficient is a complex number, meaning it has both magnitude and phase information.

The return loss is defined as the magnitude part of the reflection coefficient and is expressed in decibels (dB). Therefore, the return loss is a measure of how large the reflected wave is to the original incident wave. Remember that this measurement is in terms of loss, therefore a large number means that very little signal was reflected back. A loss of 0 dB indicates that all of the incident wave is reflected, whereas a return loss of 40 dB, for example, would indicate that very little of the signal is reflected. When a device is frequency swept, a graph similar to [Figure 4-14 on page 95](#) is obtained. This is an example of a radio transmitting at a particular frequency. It can be seen that the return loss at that frequency is a very large number which tapers off to small return losses at all other frequencies.

Another way of looking at the same information is the SWR (also known as VSWR: Voltage Standing Wave Ratio). VSWR is stated as a ratio. For example: 1.2:1 or “one point two to one” VSWR. The first number in the ratio is a value between 1 and infinity. 1 indicates that none of the incident wave is reflected. Infinity implies that all of the incident wave is reflected. Therefore, the closer this number is to 1, the better the feedline system performance. The second number in the ratio is always one.

Making the Measurement

NOTE

When testing antennas or cables with antennas attached to them, a test signal is radiated. Verify that the level and frequency span used for the test cannot result in interference to other nearby systems. To minimize interference when running the program, set the power level at the DUPLEX OUT port to the minimum value needed for good measurement resolution. Set the frequency range carefully.

1. Select **Swept Return Loss** from the Select Test (Main) Menu. The Swept Return Loss Information menu will appear.

Figure 4-12 Selecting the Swept Return Loss Measurement

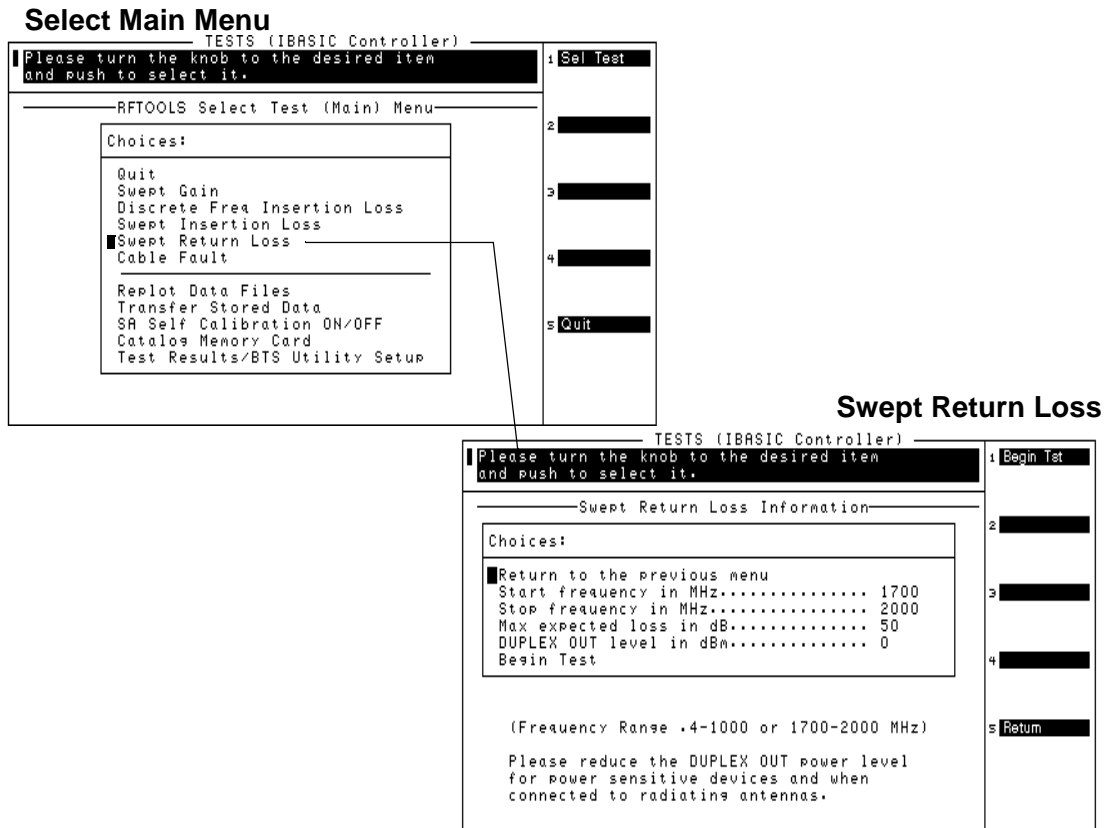

- Position the cursor at **Start frequency in MHz** and select it. Enter a value for the start of the frequency sweep from 0.4 MHz to 1000 MHz or 1700 MHz to 2000 MHz.
- Position the cursor at **Stop frequency in MHz** and select it. Enter a value from 0.4 MHz to 1000 MHz or 1700 MHz to 2000 MHz. This value should be larger than the start frequency and in the same frequency band.
- Position the cursor at **Max expected loss in dB** and select it. The return loss will be displayed from 0 dB to the value entered in this field. Therefore, if the **Max expected loss in dB** is set higher than the measured return loss, the plot will not display any test data. Enter the appropriate value.
- Position the cursor at **DUPLEX OUT Level in dBm** and select it. Enter the power level at which the test should be conducted.

CAUTION

Damage may result if the power input to the Test Set's ANT IN port exceeds 60 mW (which is equivalent to 18 dBm). Damage may also result to the unit-under-test if it is overdriven by the DUPLEX OUT power level. To avoid damage to the ANT IN port, enter an over-estimate gain value for the **Max expected gain in dB** parameter. To avoid damage to the unit under test, ensure a low power level for the **DUPLEX OUT level in dBm** parameter.

6. Press **k1 (Begin Tst)** or position the cursor at **Begin** and select it.

Figure 4-13 Swept Return Loss Setups

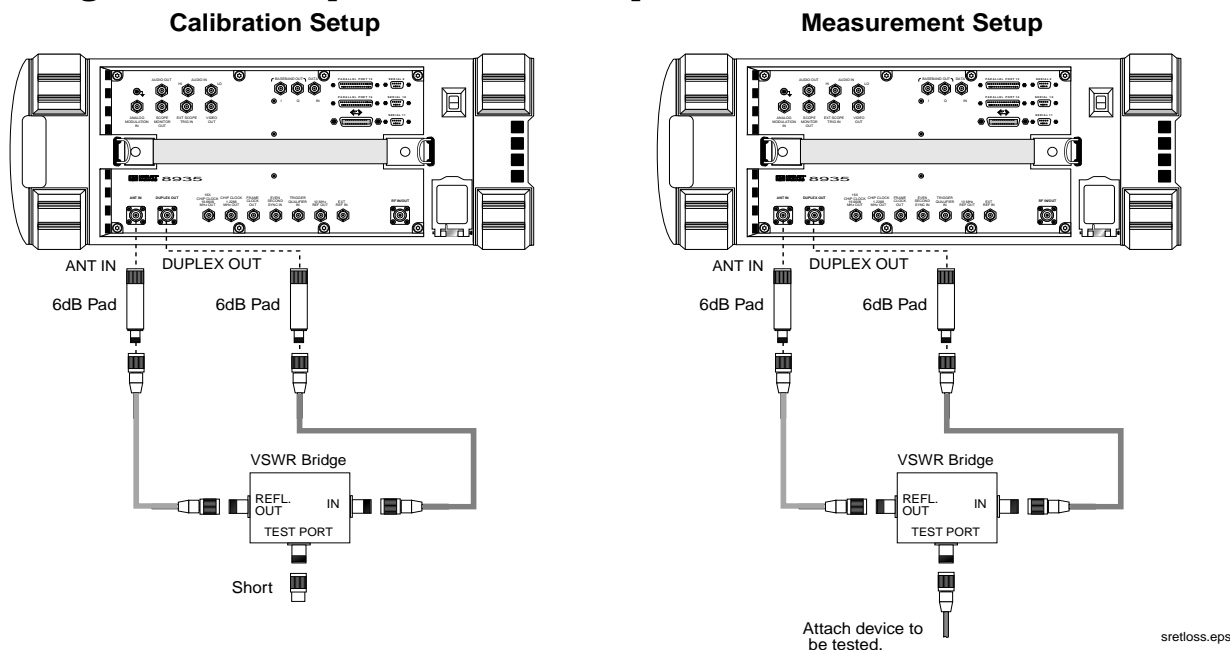

7. A setup screen appears with a diagram of the necessary connections, similar to [Figure 4-13](#). This is the calibration phase of the test to obtain a reference level for the device being tested. A VSWR bridge or a directional coupler and two 6 dB pads are connected to the Test Set. The pads are used to reduce impedance mismatch errors between the VSWR bridge and the DUPLEX OUT and ANT IN ports on the Test Set. A reference level is measured first with a short on the DUT (Device Under Test) port of the VSWR bridge. An open can be used as well, but the open must not be blocked in any way that might cause the signal to be reflected back. For example, using the open setup inside a van or other enclosed area may introduce inaccuracies in the measurement. Setup the hardware, then press **k1 (Proceed)** or the knob to continue.
8. Another setup screen appears. Attach the device being tested. Press **k1 (Proceed)** or the knob to continue.

- The plot screen appears. The trace showing return loss over the frequency band selected is displayed on the screen. Measured values for best and worst case return loss and VSWR are printed at the top of the screen. To save the plot to a PC card, press **k4** (**Save Plot**) and use the knob to enter a filename. Press **k5** (**Scr Dump**) to send the image to a printer or to the BTS Laptop Utility. Directions will appear at the top of the screen. Press **PRINT** and allow the image to print to the connected device. Then, press **PAUSE/CONTINUE**. Press **k1** (**Proceed**) when you are ready to proceed.

Figure 4-14 Example of a Swept Return Loss Plot Screen

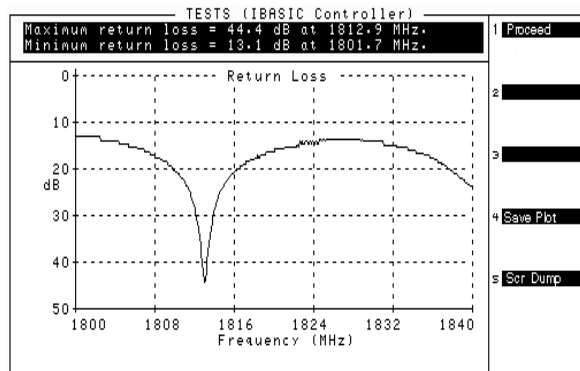

- The swept return loss results screen appears with the test results. If the BTS Laptop Utility is in use, this data is collected by the laptop. If you wish to repeat the test using the same calibrated devices and test parameters, press **k1** (**Repeat**). To redisplay the plot screen, press **k3** (**Disp Plot**). To return to the **Select Test (Main)Menu**, press **k5** (**Return**).

Figure 4-15 Example of an Swept Return Loss results screen

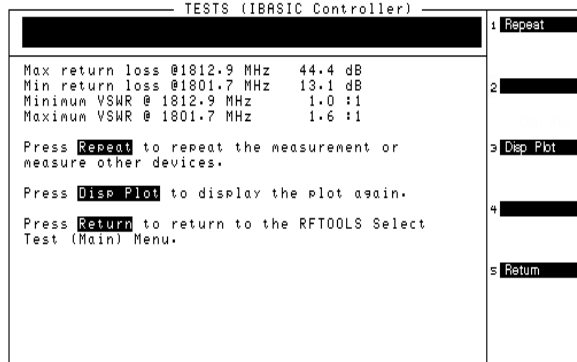

Estimating Antenna Return Loss

If you are measuring the return loss of an antenna connected to the end of a known good feed line, you can determine the approximate return loss of the antenna by subtracting twice the line loss. For example, if you measure a return loss of 24 dB and the line is known to have 2 dB loss, the estimated return loss of the antenna is 20 dB (since there is a total of 4 dB of loss from the feed line). For this estimate to be correct, the coaxial line and connectors must have a much smaller loss than the total return loss.

Specifications

- Frequency Range: 0.4-1000 MHz, 1.7-2.0 GHz
- Swept Signal Level: -54 dBm to +10 dBm
- Swept Return Loss Accuracy: +/- 2dB +/-10% of reading, for readings between 0 dB and 30 dB

Cable Fault

Measurement Description

A frequency-swept signal is transmitted from the DUPLEX OUT port of the Test Set through a resistive power divider to the cable-under-test. The signals reflected from faults in the cable are combined in the power divider with the transmitted signal and received at the ANT IN port.

The changing interference of the transmitted and reflected signals, over the swept frequency band, contains information about the distance to one or more faults. The software uses a Fast Fourier Transform (FFT) to convert the frequency domain into the time domain. The information in the time domain can be used to find the physical distances. The distance displayed on the Test Set's CRT is the physical distance to the fault with correction for the velocity factor of the cable. This test allows the operator to identify, characterize, and isolate potential problem locations by viewing it in units of distance.

NOTE**Test Signal Can Cause Interference**

When testing cables attached to antennas, test signals will be radiated. Verify that the signal used for the test cannot result in interference to another antenna.

Making the Measurement

1. Select **Cable Fault** from the Select Test (Main) Menu. The Cable Fault Information menu will appear.

Figure 4-16 Selecting the Cable Fault Measurement

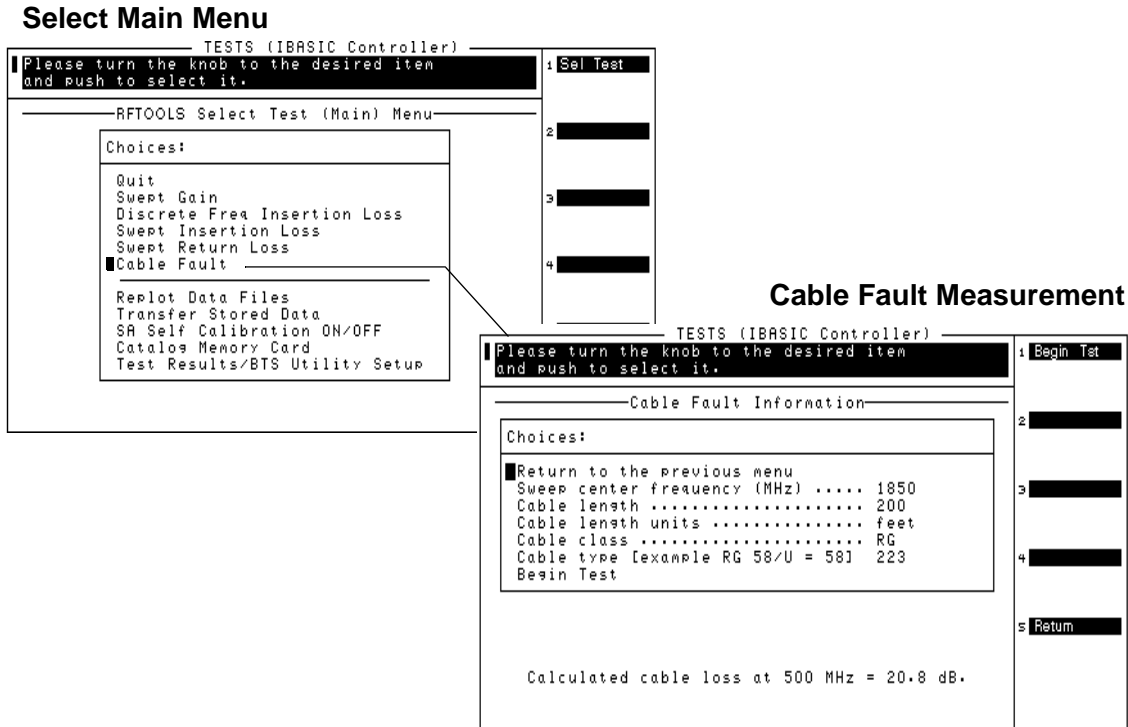

2. Position the cursor at **Sweep center frequency (MHz)** and select. A **Choices** menu appears.
 - **505 MHz** - Use this center frequency for high resolution, short range cable tests. The cable lengths can range from 10 to 1000 ft.
 - **850 MHz** - Use this center frequency for cable tests at cellular frequencies. This should be used for frequency sensitive devices, such as filters, and has a cable length range of 150 to 1000 ft.
 - **1850 MHz** - Use this center frequency for cable tests at PCS frequencies. This should also be used for frequency sensitive devices and has a cable length range of 150 to 1000 ft.
3. Position the cursor at **Cable length** and enter the appropriate value.

NOTE

The greatest accuracy is obtained when you enter a cable length slightly greater than the cable length being tested. If you are not sure of the cable length, enter a value 1.5 times the estimated length. Depending on the return loss of the antenna or device at the end of the cable, you may see a high relative mismatch displayed at the actual length of the cable. For example, a 50 foot cable was tested to generate the plot in [Figure 4-18 on page 101](#).

4. Position the cursor at **Cable length units**. Pressing the knob toggles the selection between feet and meters.
5. Position the cursor at **Cable class** and select it. A **Choices** menu appears allowing selection of Heliax, RG, and custom options. Select the appropriate cable class. (They can also be selected by pressing **k1 (HELIAX)**, **k3 (RG)**, or **k5 (Custom)**.)
6. The next menu varies depending on Cable class:
 - If **Heliax** is selected: Position the cursor at **Cable type** and select. A **Choices** menu appears with foam, air, and flex of varying thickness. Use the knob to select the desired cable type.
 - If **RG** is selected: Position the cursor at **Cable type** with the example [RG 58/U = 58] and select.
 - If **Custom** is selected:
 - a. Position the cursor at **Cable velocity propagation const** and select it. Enter the appropriate value. Cables that use polyethylene dielectric typically have a propagation velocity of 0.66, cables that use a teflon dielectric typically have a propagation velocity of 0.70. The propagation velocity must be a value between 0 and 1.
 - b. Position the cursor at **Cable atten. dB/100 ft. (or meters) at 500 MHz** and select it.
 - c. If the cable attenuation is unknown, enter 0 dB per 100 feet (or meters). Entering 0 dB/100 will produce return loss values lower than actual, but fault distance can be accurately detected.
7. Press **k1 (Begin Tst)**.

Figure 4-17 Cable Fault Setups

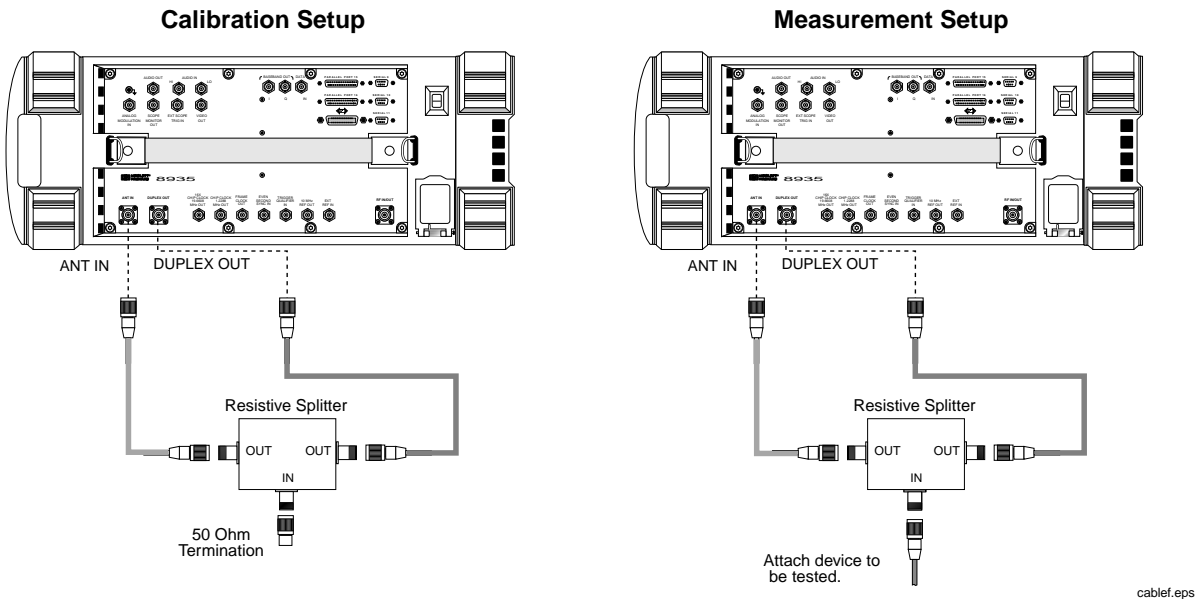

8. A setup screen appears with a diagram of the necessary connections (see Figure 4-17). It is very important that the power divider is a 2-way resistive device. Press **k1 (Proceed)** or the knob after the hardware is connected.
9. After the Test Set has finished calibrating, a second diagram appears on the screen. Connect the cable to be tested. Press **k1 (Proceed)** or the knob to continue.
10. The plot screen appears similar to Figure 4-18 on page 101. To save the plot to a PC card, press **k4 (Save Plot)** and use the knob to enter a filename. Press **k5 (Scr Dump)** to send the image to a printer or to the BTS Laptop Utility. Directions will appear at the top of the screen. Press **PRINT** and allow the image to print to the connected device. Then, press **PAUSE/CONTINUE**. Press **k1 (Proceed)** when you are ready to continue.

Figure 4-18 Example of a Cable Fault Plot Screen

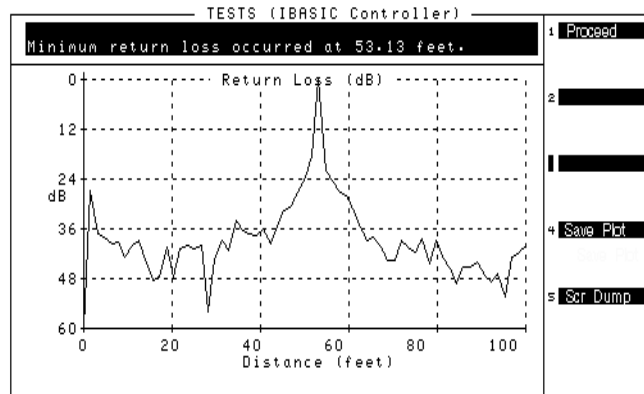

- The cable fault result screen appears with the test results (see [Figure 4-19](#) for an example). If the BTS Laptop Utility is in use, this data is collected by the laptop. If you wish to repeat the test using the same calibrated devices and test parameters, press **k1 (Repeat)**. To re-display the plot screen, press **k3 (Disp Plot)**. To return to the **Select Test (Main) Menu**, press **k5 (Return)**.

Figure 4-19 Example of a Cable Fault Results Screen

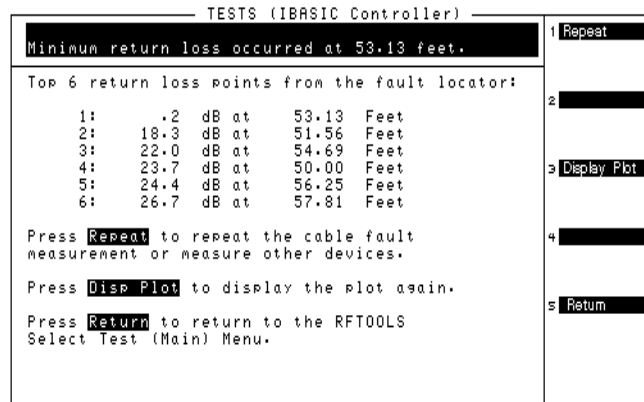

Typical cable fault return loss measurements

Return loss is a ratio of input power to reflected power. For example, if 100 Watts was applied to a cable and 10 Watts was returned, the return loss is 10 dB ($10 \log(100/10)$). In the same example, if 1 Watt was returned, the return loss is 20 dB ($10 \log(100/1)$). Typical return loss measurements for the cable loss test are listed below:

- Open-Circuit Cable = 0 dB (ignoring line loss)
- Short-Circuit Cable = 0 dB (ignoring line loss)
- 50-Ohm Terminated Cable = 40 to 60 dB
- Antenna = 10 to 20 dB (in the frequency band for which it was designed)

Return loss measurements greater than 20 dB should be considered good.

Cable Fault Performance

Measurements of the cable fault location can typically be made up to 500 feet on low-loss cables and 300 feet on higher-loss cables. Resolution of the fault location is approximately 0.4 feet for cable lengths up to 50 feet and then linearly increases to 4 feet for a 500 foot cable.

Specifications

- Cable Types Tested: Helix, RG, Custom
- Cable Length Range: 0 to 1000 feet, 0 to 300 meters
- Distance accuracy: +/-5% of the cable length value entered by the user

Replot Data Files

This utility allows you to easily retrieve and display plots which were previously stored on an SRAM PC card. One or two plots may be displayed at one time. No measurements are performed.

Figure 4-20 Replot Data Files

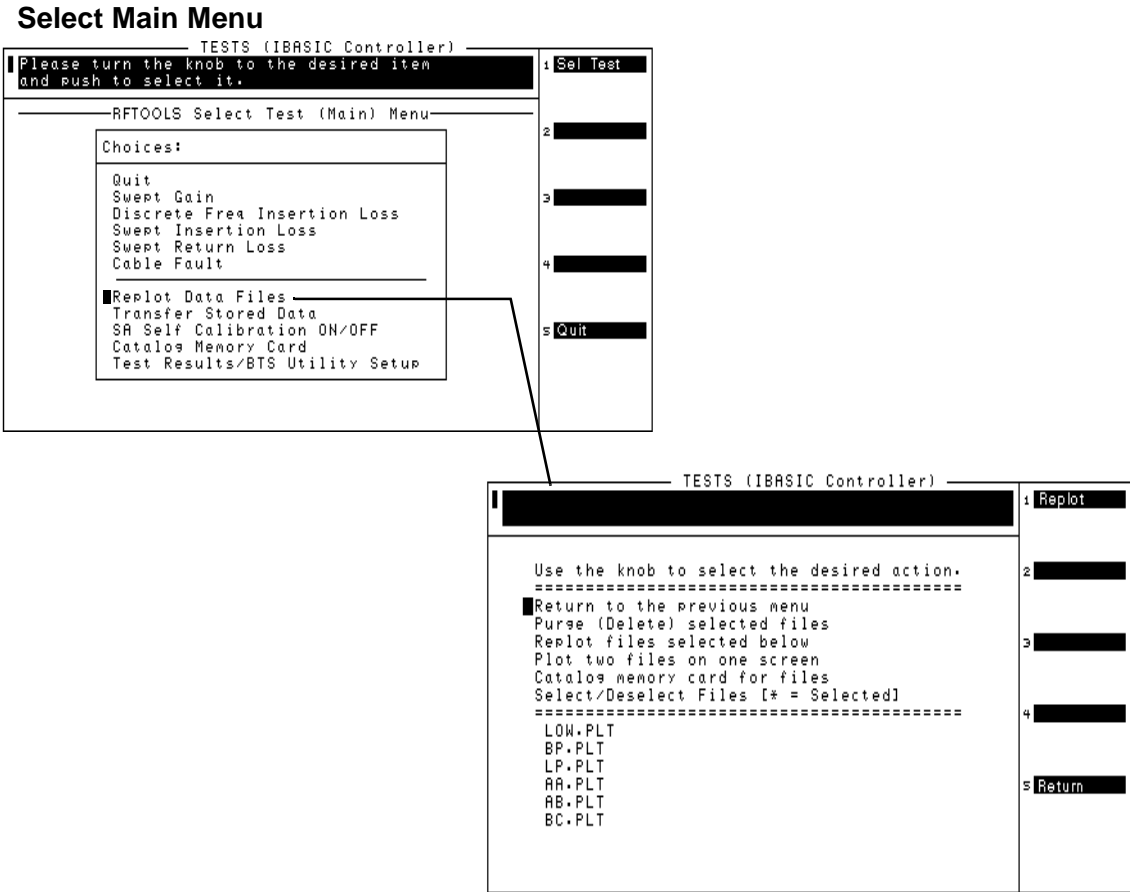

Transfer Stored Data

This utility may be used to easily transfer data collection files (test results) from an SRAM PC card over the serial, parallel, or GPIB port. You do not need to write an IBasic program. No measurements are performed.

Figure 4-21 Transfer Stored Data Screen

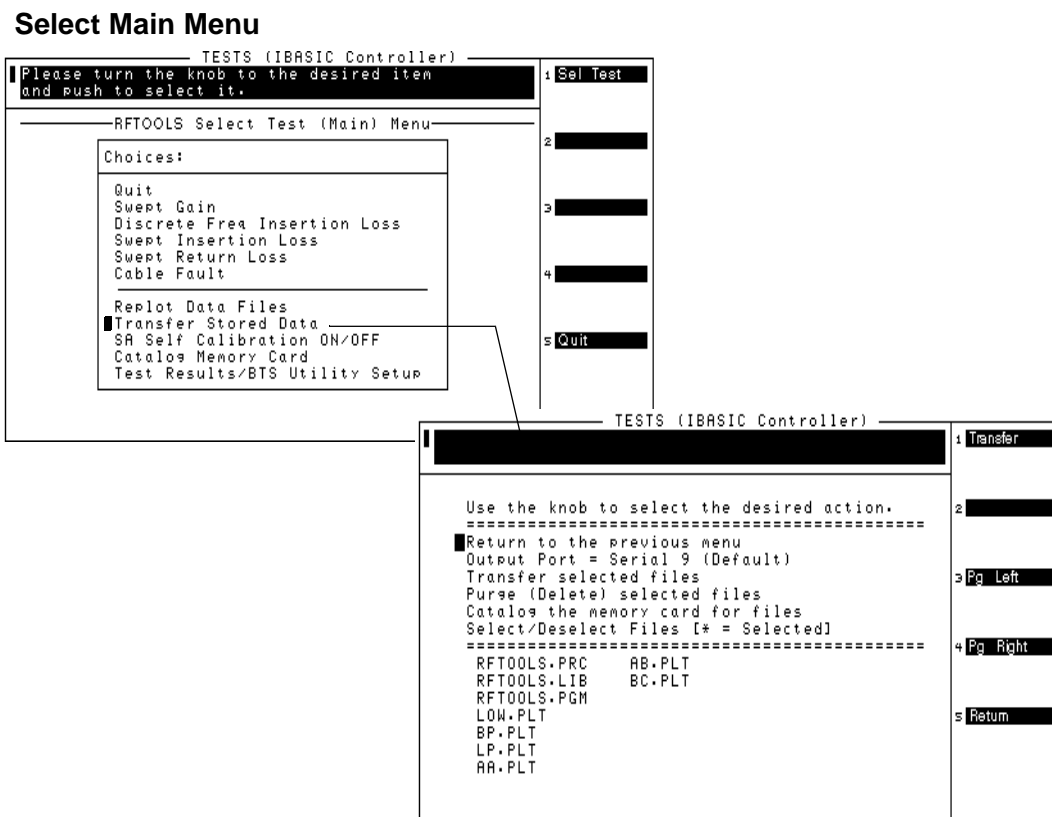

SA (Spectrum Analyzer) Self Calibration ON/OFF

This menu item allows you to check the calibration status of the Test Set's spectrum analyzer, and change the status if you desire.

Figure 4-22 SA Self Calibration OFF/ON Screen

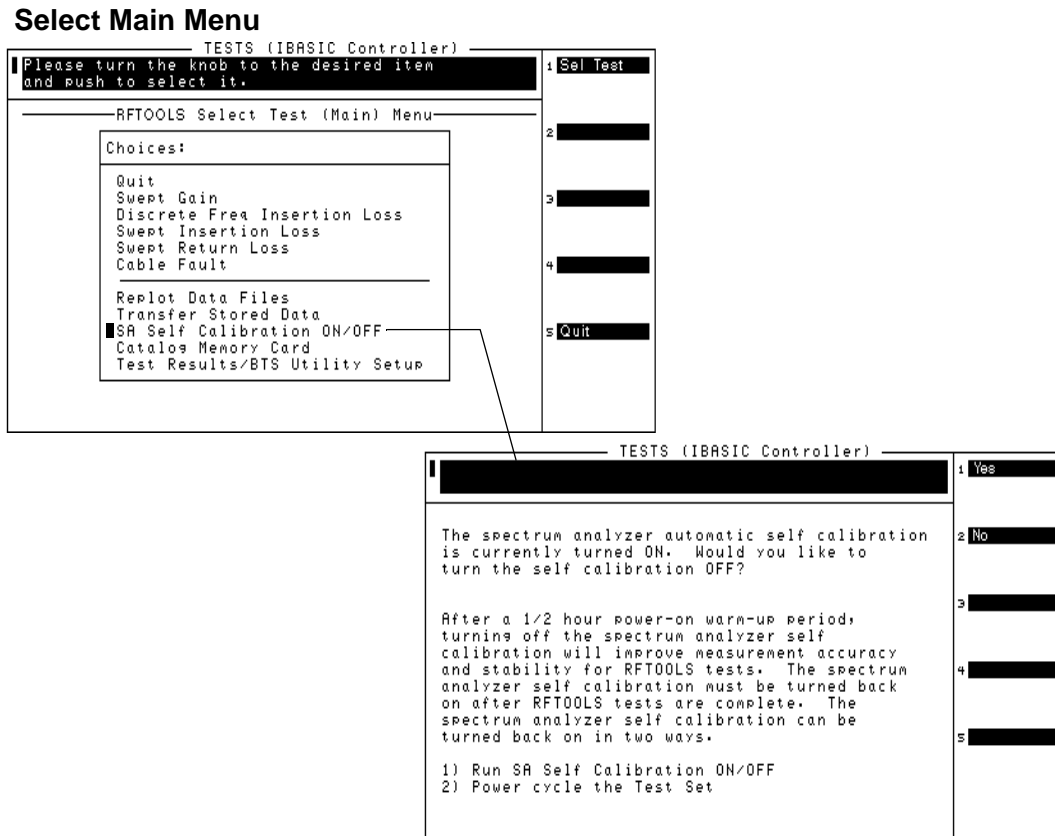

The RFTOOLS program uses the Test Set's internal spectrum analyzer for making swept network analyzer measurements. The internal spectrum analyzer performs an automatic self calibration every 5 minutes. This automatic self calibration ensures that the spectrum analyzer operates within specified limits regardless of the operating temperature. However, this self calibration can introduce inaccuracy in spectrum analyzer output after the Test Set is operating at a constant temperature (after approximately 30 minutes).

Each RFTOOLS test includes two parts: calibration and measurement. If the spectrum analyzer performs a self calibration between the calibration and measurement of the RFTOOLS test, the spectrum analyzer's automatic self calibration instability will increase RFTOOLS test measurement error. To avoid this problem, you may use this menu item to turn off the spectrum analyzer's self calibration. This self calibration should only be turned off after the unit has reached a constant powered-on operating temperature (approximately 30 minutes after power-on), therefore it is probably best to leave it on. After 30 minutes, turning the self calibration off will improve the measurement accuracy of RFTOOLS tests.

Catalog PC (Memory) Card

This utility lists all the files contained on the PC card. The PC card that you want to catalog must be inserted prior to selecting this test.

File types are denoted by the following suffixes:

- .PGM suffix denotes a program code file
- .LIB suffix denotes a library file
- .PRC suffix denotes a procedure file
- .DAT suffix denotes a data file
- .PLT suffix denotes a plot file

Figure 4-23 Catalog Memory Card Screen

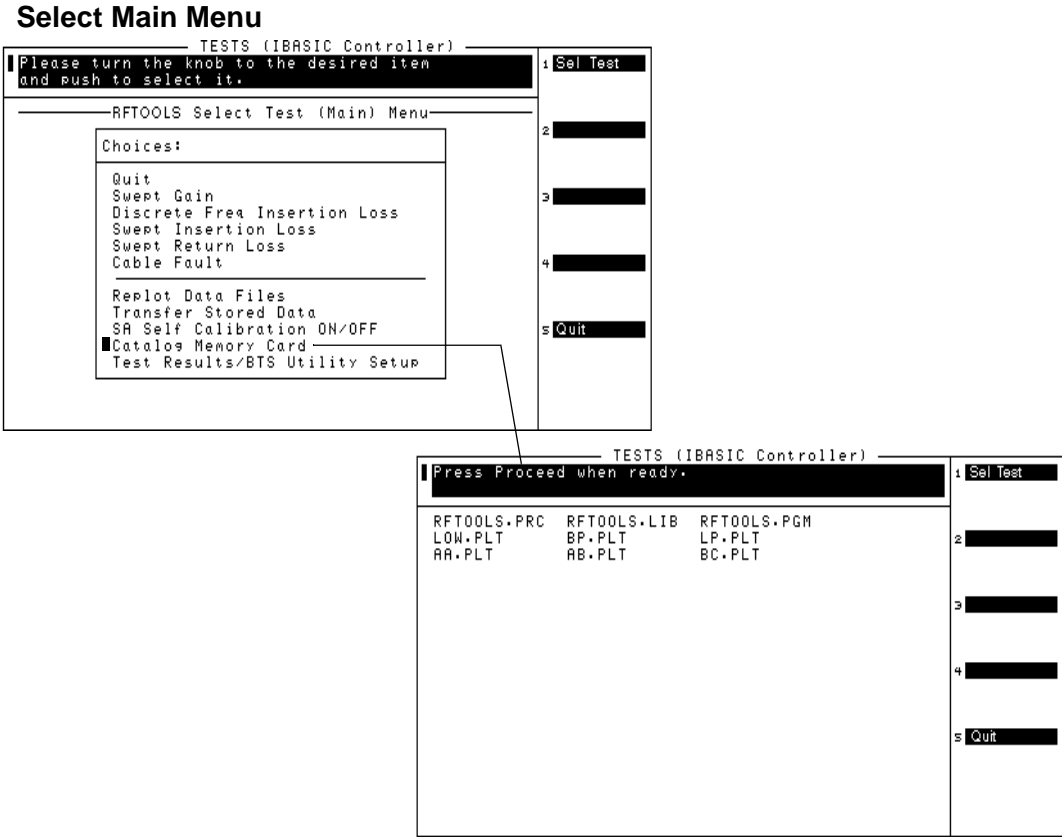

Using the Code Domain Analyzer

The code domain analyzer has two display modes, selected in the Inst Config screen:

- **IS-95** – corresponding to the standard that specifies 64 channels in the Hadamard (consecutive integer) ordering. This code domain view graphically displays the power, phase, and timing of the CDMA signal's 64 Walsh channels.
- **IS-2000** – corresponding to the standard that specifies 128 Walsh codes. This code domain view graphically displays power, fast power, power & noise and complex power of the CDMA signal's 128 Walsh codes.

Selecting the Code Domain Analyzer's Controls Menus

Several levels of menus are used to access the various controls associated with the code domain analyzer. [“Control Fields for CDMA Measurements” on page 150](#) provides a description for each field on the code domain analyzer's menus. See [“CDMA Measurements” on page 131](#) and the *Agilent Technologies 8935 CDMA Base Station Tests Applications Guide* for more information about code domain measurements.

Figure 4-24 Code Domain Analyzer Menus - IS-95

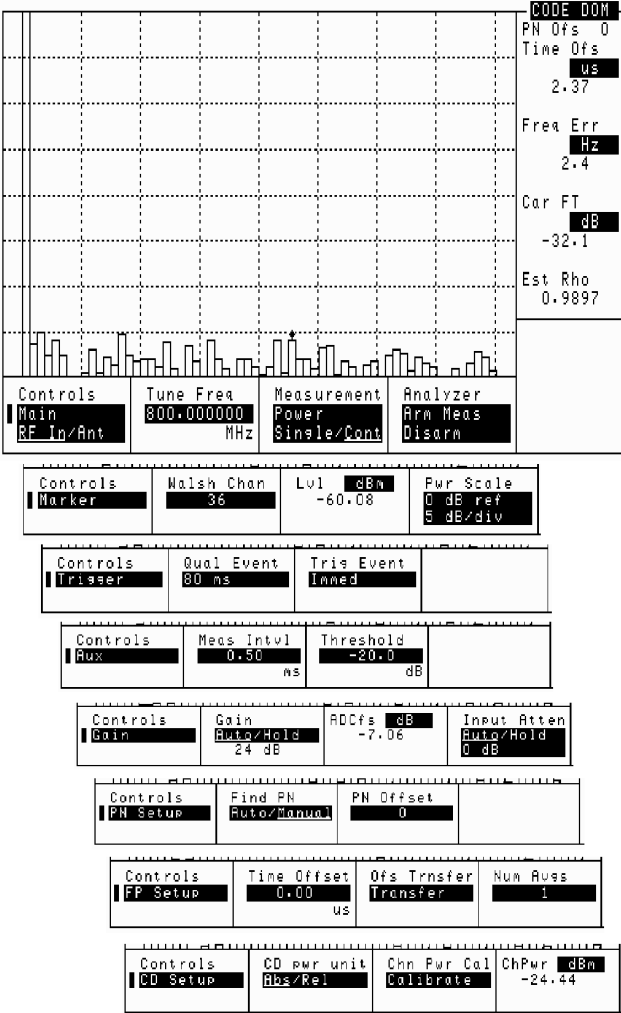

Overview of the Test Set's Built-In Tools
Using the Code Domain Analyzer

Figure 4-25 Code Domain Analyzer Menus - IS-2000

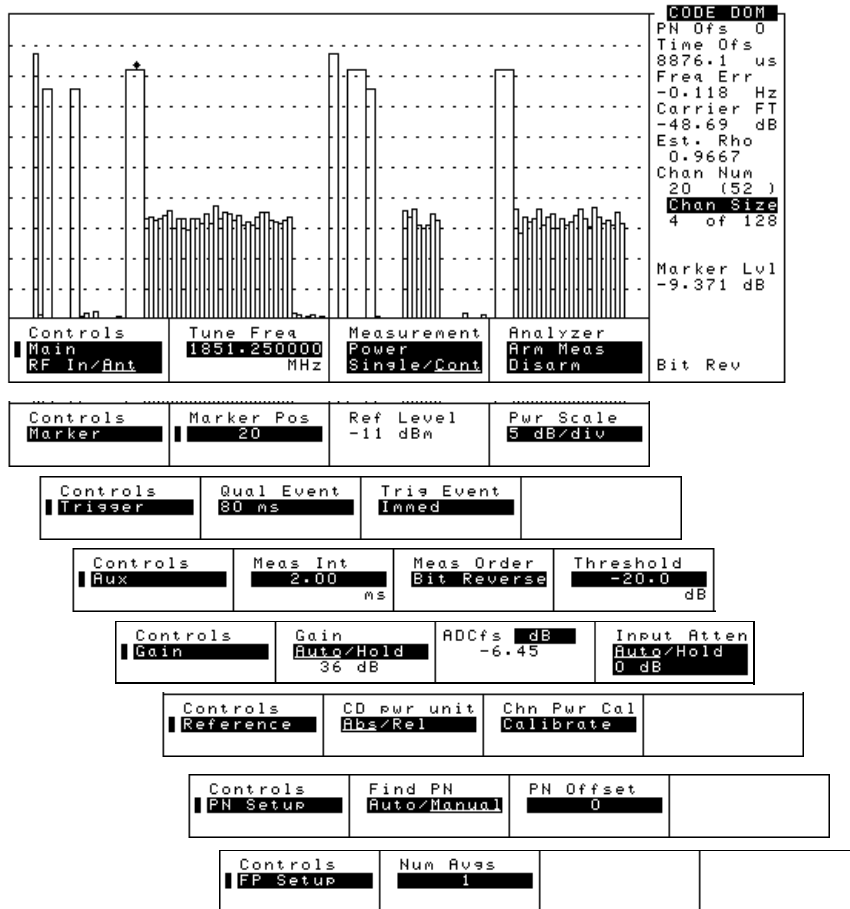

Using the Spectrum Analyzer

Automatic Calibration

During operation, the spectrum analyzer pauses for approximately 2 seconds every 5 minutes to recalibrate itself. This does not affect the accuracy of displayed measurements, but does cause a brief interruption of the displayed information during the process.

Setting Resolution Bandwidth and Sweep Rate

The resolution bandwidth and sweep rate are determined by the span setting, and cannot be set independently.

These settings are listed in the following table.

Table 4-1 Relationship between Span, Resolution Bandwidth, and Sweep Rate

| Span | Resolution BW (kHz) | Sweep Rate |
|----------|---------------------|------------------|
| <50 kHz | 0.3 | 28.6 kHz/second |
| <200 kHz | 1.0 | 329.0 kHz/second |
| <1.5 MHz | 3.0 | 3.0 MHz/second |
| <3 MHz | 30.0 | 21.4 MHz/second |
| <18 MHz | 30.0 | 36.3 MHz/second |
| <200 MHz | 300.0 | 257.0 MHz/second |
| 1 GHz | 300.0 | 1.0 GHz/second |

Selecting the Spectrum Analyzer's Controls Menus

Several levels of menus are used to access the various controls associated with the spectrum analyzer (see [Figure 4-26 on page 112](#)).

“[Control Fields for Analog Measurements](#)” on page 185 provides a description for each field on the spectrum analyzer's menus.

Figure 4-26 **Spectrum Analyzer Controls Menus**

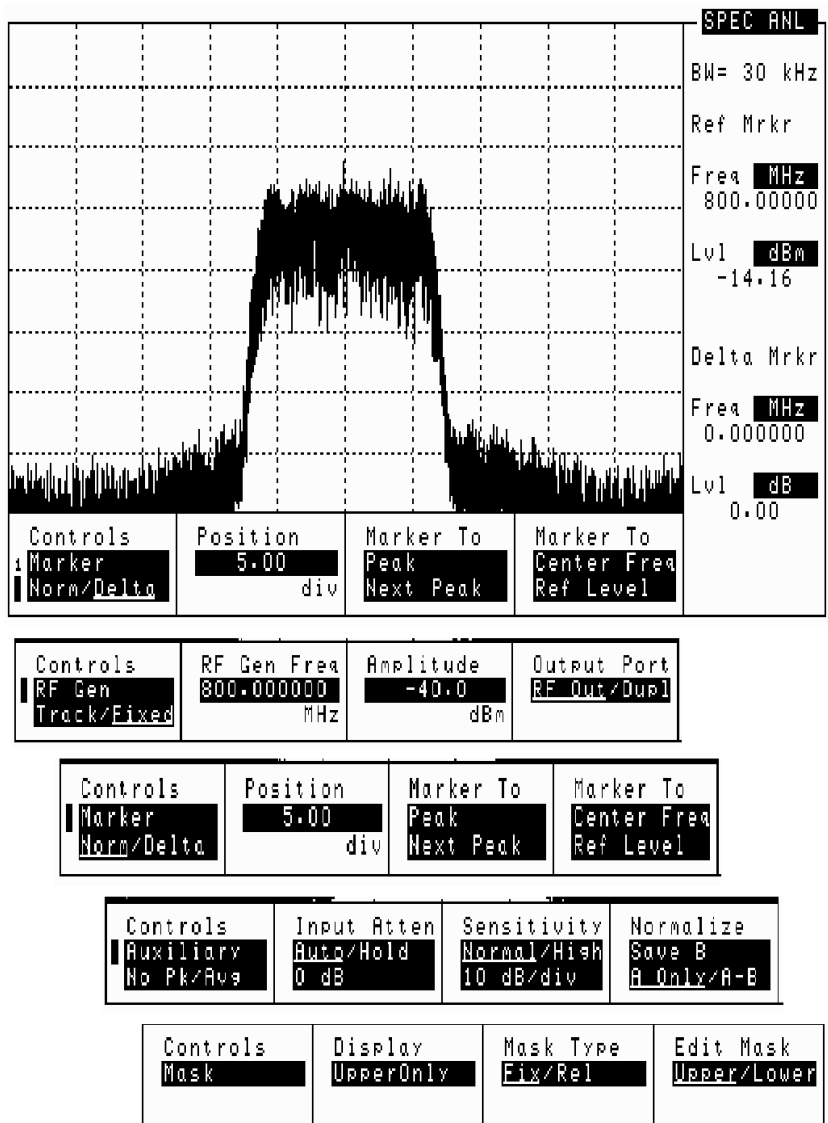

Using the Spectrum Analyzer's Delta Markers

Delta markers are displayed when the **Norm/Delta** field on the spectrum analyzers **Marker** menu is set to **Delta**.

The delta makers are positioned in the same way as the normal markers using the **Marker** menu of the spectrum analyzer screen. See [“Marker To” on page 205](#)

When the delta maker is activated, the **Marker To Peak**, **Next Peak**, **Center Freq**, and **Ref Level** fields control only the delta marker.

- **Peak or Next Peak** - The normal marker remains stationary. When a delta marker to center frequency measurement would move the reference marker off the screen, the measurement is aborted and the following message is displayed: **Attempt to move Reference Marker off the screen**.
- **Center Freq or Ref Level** - The normal marker moves as necessary to stay at the same signal frequency when the spectrum display changes.

Delta Frequency

The delta marker frequency measurement (**Delta Mrkr Freq**) is the frequency of the delta marker minus the frequency of the normal marker. If the delta marker is to the right of the normal marker, the delta frequency is positive. If the delta marker is to the left of the normal marker, the delta frequency is negative.

The units for this measurement are GHz, MHz, kHz, and Hz.

Delta Level

The delta marker level measurement (**Delta Mrkr Lvl**) is the level of the normal marker minus the level of the delta marker in dBm. If the delta marker is higher than normal marker, the delta level is positive. If the delta marker is lower than the normal marker, the delta level is negative.

The units for this measurement are dB. (There is a percent unit available; however, since the spectrum analyzer level is always displayed on a logarithmic scale, linear units are inappropriate.)

Reference Marker (Ref Mrkr) Level and Frequency

In the delta marker mode, a second (reference) marker is placed at the current location of the marker. The first marker becomes a moveable delta marker. When the delta marker is moved, the difference in frequency and level between the reference marker and the delta marker are shown as the **Delta Mrkr** measurements on the right-hand side of the screen. The reference marker can be set to either **Hold** or **Norm**.

When the **Ref Mrkr** field is set to **Hold**, the reference marker is frozen at its current position (frequency and level) regardless of changes in the signal level. This is useful for measuring multiple off-air carriers and looking at the difference in power levels. The reference marker can also be used when zeroing return loss.

When you switch from **Hold** to **Norm**, the reference marker will stay at its current horizontal setting (frequency), but will track the level of the incoming signal.

When switching from delta mode to normal mode, the delta marker becomes the normal marker.

Using the Spectrum Analyzer Mask

The spectrum analyzer mask consists of two adjustable limit lines. They show the upper and lower limits of spectral occupancy. You can choose to set and display either upper or lower limits for the mask, or both. When the mask is turned on, it continuously monitors the signal spectrum with respect to these limits and indicates a failure when the spectrum exceeds these limits. A “Fail” message, along with a beep (if activated), indicates a failure. “Pass” is displayed if the signal remains within the limits of the mask.

Displaying the Spectrum Analyzer Mask

1. On the SPEC ANL screen, set the **Controls** field to **MASK**. (See [“Selecting the Spectrum Analyzer’s Controls Menus” on page 112](#) for instructions.)
2. Set the **Display** field to show the mask on the screen, and to indicate which limits you want to measure against.
 - **Upper Only**
 - **Lower Only**
 - **Both**

Setting this field to **Off** turns off the mask and the pass/fail indicator.

3. Set the **Mask Type** field to the type of mask you want to measure against.
 - **Fix** sets the mask to absolute limits defined in the **#Pts**, **EditPoint**, **Lvl**, and **Freq** fields. When using fixed limits a change in the center frequency or level may cause the mask to move beyond the viewable area of the screen.
 - **Rel** sets the mask relative to the center frequency and reference level defined in the **Center Freq** and **Ref Lvl** fields on the spectrum analyzer’s **Main** controls menu.

You can define two masks, one fixed and one relative and switch between the two using this field.

Defining the Fixed Mask's Limits

1. Set the **Edit Mask** field to the limit you want to edit (**Upper** or **Lower**).

You might want to set the **Mask Beep** field to **Off** while you are defining the mask.
2. Set the **Mask Type** field to **Fix**.
3. Set the **#Pts** field to the number of points you want defined by the mask. You can define up to 15 points. The starting point is always the left graticule on the display, and the end point is always the right graticule on the display.

To define a straight-line mask, set the number of points to 1. The default mask is a straight line at the top of the display.

4. Set the **EditPt** field to the point you want to define.
5. Set the **Lvl** and **Freq** fields to the frequency and level you want for the point you chose in the **EditPoint** field.

In [Figure 4-27](#) the frequency and level settings for each point are as follows:

Table 4-2 Settings for mask in [Figure 4-27](#)

| Point | Level | Frequency |
|-------|---------|---------------|
| 1 | -50 dBm | 1799.7000 |
| 2 | 1 dBm | 1799.7000 |
| 3 | 1 dBm | 1800.3000 |
| 4 | -50 dBm | 1800.3000 MHz |

Figure 4-27 Setting the Spectrum Analyzer Mask

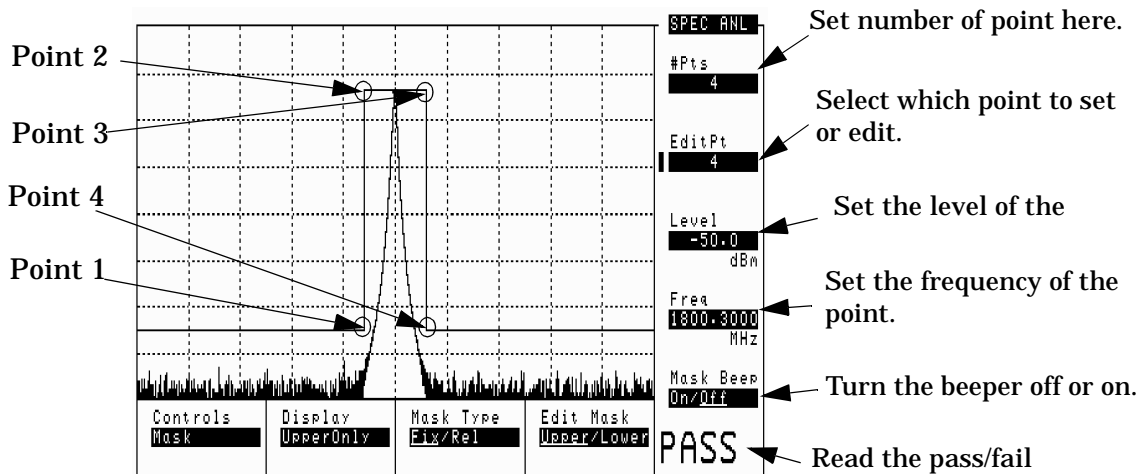

samask.pcx

Defining the Relative Mask's Limits

1. Set the **Edit Mask** field to the limit you want to edit (**Upper** or **Lower**).

You might want to set the **Mask Beep** field to **Off** while you are defining the mask.

2. Set the **Mask Type** field to **Rel**.
3. Set the **#Pts** field to the number of points you want defined by the mask. The starting point is always the left graticule on the display, and the end point is always the right graticule on the display.

To define a straight-line mask, set the number of points to 1.

The default mask is a straight line at the top of the display.

4. Set the **EditPt** field to the point you want to define.
5. Set the **Level Ofs** and **Freq Ofs** fields to the frequency and level offsets you want for the point you chose in the **EditPt** field.

The offsets are relative to the frequency and level set in the **Center Freq** and **Ref Level** fields on the spectrum analyzer's **Main** controls menu.

Refer to [Figure 4-27 on page 116](#). Instead of setting **Level** and **Freq**, set the **Level Ofs** and **Freq Ofs**.

Turning Off the Mask

1. Set the **Display** field to **Off** to turn off the spectrum analyzer mask.

Turning Off the Mask's Failure Beeper

1. Set the **Mask Beep** field to **Off** to turn off the beeping failure indicator.

Using the Voltmeter and Audio Frequency Counter

The voltmeter can be used to measure ac and dc voltages. The input to the voltmeter is determined by the **AF An1 In** field on the AF ANALYZER screen.

To measure external voltages:

1. Select the AF ANALYZER screen.
2. Set the AF An1 In field to Audio In.
3. Set the Audio In Lo field to match the source you are measuring (600 ohm impedance, floating output amplifier, ground referenced voltage). See “Audio In Lo” on page 190 for more information.
4. Connect the signal to be measured to the AUDIO IN connector(s). The AUDIO IN HI connector can be used alone as long as the **Audio In Lo** field is set to **Gnd**. The AUDIO IN LO connector must also be used if the **Audio In Lo** field is set to **600** to **Hi** or **Float**.

The ac level is displayed. See Figure 4-28.

5. Select the lower-right measurement display field. See Figure 4-28.
 - Select **DC Level** to display the dc level.
 - Select **AF Freq** to display the audio frequency.

Figure 4-28 Measuring AC and DC Voltages

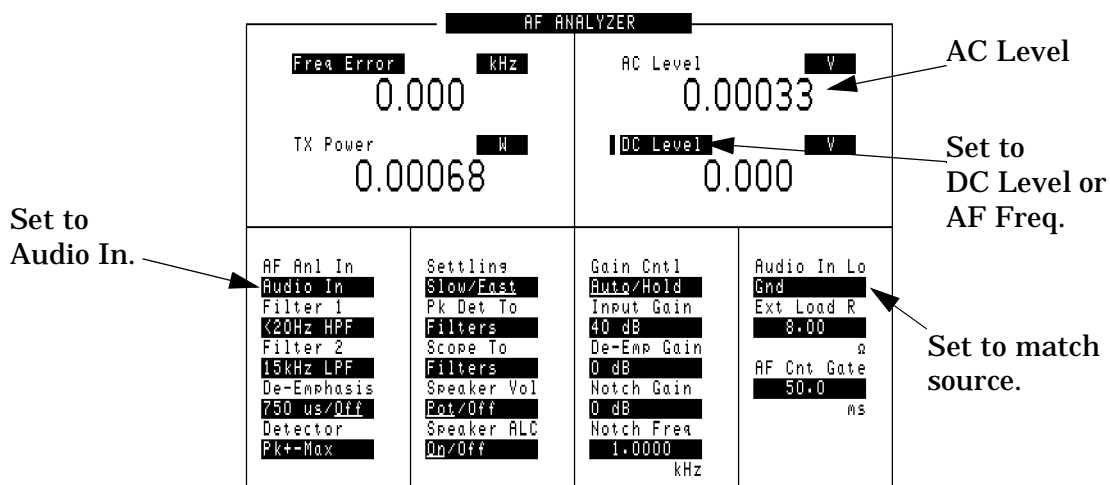

Using the Oscilloscope (Scope)

The built-in 50 kHz oscilloscope provides

- multiple triggering formats (internal and external)
- single-shot and pre-trigger viewing for single events
- full marker capability with automatic level and time readout

Time/division, volts/division and vertical offset are displayed and can be changed using the front-panel knob.

Input to the oscilloscope is provided from various sources including direct inputs to the AUDIO IN (HI and LO) and ANALOG MODULATION IN connectors. Oscilloscope functions are accessed from the AF ANALYZER and SCOPE screens.

Figure 4-29 Inputs and Filters for the Oscilloscope

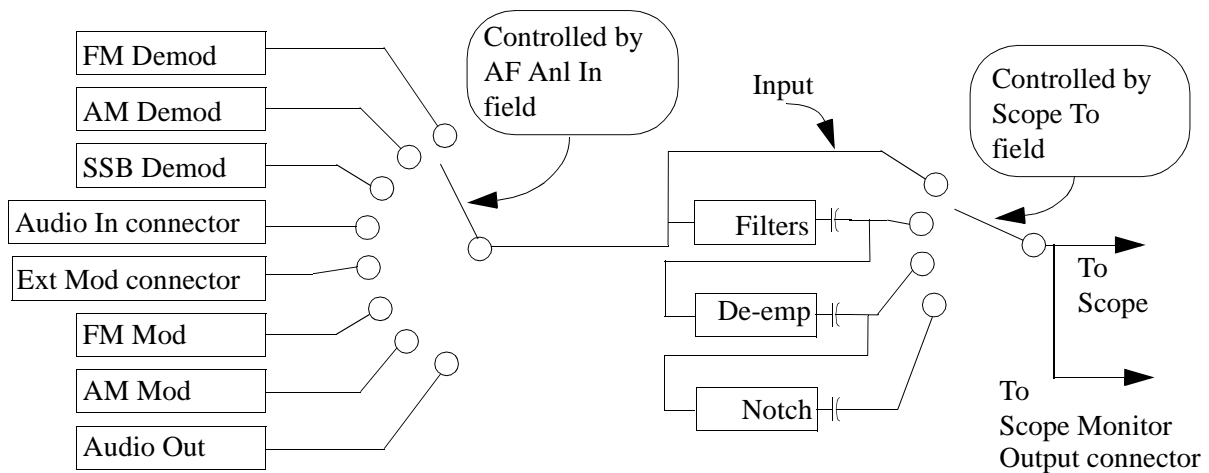

Selecting the Oscilloscope's Input

Step 1. Press **Shift**, then **RF An1 (AF An1)** to select the AF ANALYZER screen.

Step 2. Select the **AF An1 In** field. A list of choices appears.

Step 3. Select the desired input to the scope:

- **FM Demod** for FM demodulated audio from input signals connected to the RF IN/OUT or ANT IN connectors.
- **AM Demod** for AM demodulated audio from input signals connected to the RF IN/OUT or ANT IN connectors.
- **SSB Demod** for SSB demodulated audio from input signals connected to the RF IN/OUT or ANT IN connectors.
- **Audio In** for a signal connected to the AUDIO IN connector.
- **Ext Mod** for a signal connected to the ANALOG MODULATION IN connector.
- **FM Mod** for the FM modulated audio from the RF generator section.
- **AM Mod** for the AM modulated audio from the RF generator section.
- **Audio Out** for the signal present at the SCOPE MONITOR OUTPUT connector.

The input to the oscilloscope is displayed on the SCOPE screen.

Selecting the Oscilloscope's Filters

- Step 1.** Press **Shift**, then **RF Anl (AF Anl)** to select the AF ANALYZER screen.
- Step 2.** Select the **scope To** field. A list of choices should appear.
- Step 3.** Select the desired filtering for the signal:
- **Input** if you want no filtering (dc coupled)
 - **Filters** to route the audio to the oscilloscope after passing through Filters 1 and 2 (ac coupled).
 - **De-emp** to route the audio to the oscilloscope after passing through Filters 1 and 2, and the de-emphasis circuitry (ac coupled).
 - **Notch** to route the audio to the oscilloscope after passing through Filters #1 and #2, the de-emphasis circuitry, and notch circuitry (ac coupled).

Triggering the Oscilloscope

You can control following triggering features of the oscilloscope:

- Trigger external or internal
- Automated or normal triggering
- Continuous or single shot triggering
- Trigger level
- Trigger delay

The oscilloscope is triggered using the Trigger menu. Select this menu with the following procedure:

- Step 1.** Press **Shift**, then **Spec Anl (Scope)** to go to the SCOPE screen.
- Step 2.** Select the **Controls** field, then choose **Trigger** from the list of choices.

Using the Oscilloscope's Marker

The marker is used to help you make measurements with the oscilloscope. By repositioning the marker, you can measure the level and time.

The marker is controlled using the marker menu. Select this menu with the following procedure:

- Step 1.** Press **Shift**, then **Spec Anl (Scope)** to go to the SCOPE screen.
- Step 2.** Select the **Controls** field, then choose **Marker** from the list of choices.

Using IB_UTIL Programs

See “[Securing a Test Procedure](#)” on page 123 for information about the SECURE_IT program. See “[Clearing RAM](#)” on page 124 for information about the RAM_MANAGER program.

COPY_PL

The COPY_PL program allows you to copy procedures and libraries from one PC card to another. See the *Agilent Technologies 8935 Programmer's Guide* for more information about procedures and libraries.

FILE_XFER

The FILE_XFER (file transfer) program transfers files on a PC card to a device attached to either the GPIB or to SERIAL PORT 9.

RAM_USAGE

The RAM_USAGE program lists the following information about the Test Set's RAM:

- Total RAM installed
- RAM disk allocations
- Save register allocations
- Approximate RAM available for IBASIC programs

Securing a Test Procedure

The password option for securing a test procedure is accessed by loading and running the `SECURE_IT` ROM program. This program is accessed by running the `IB_UTIL` program.

- Step 1.** Select the SOFTWARE MENU screen.
- Step 2.** Select the `select Procedure Location:` field and choose `ROM`.
- Step 3.** Select the `select Procedure Filename:` field.
 - a.** Select `IB_UTIL` from the list of programs. Press `Run Test` to display a list of procedures; select `SECURE_IT` and follow directions to secure the desired information.

Clearing RAM

RAM can be cleared using the `RAM_MANAGER` program in the Test Set's ROM. This program clears *all* RAM, including any SAVE/RECALL registers saved to Internal RAM.

This program is accessed by running the `IB_UTIL` program.

- Step 1.** Select the SOFTWARE MENU screen.
- Step 2.** Select the `Select Procedure Location:` field and choose `ROM`.
- Step 3.** Select the `Select Procedure Filename:` field.
 - Select `IB_UTIL` from the list of programs. Press `Run Test` to display a list of procedures; select `RAM_MANAGER` and follow directions to clear RAM.

To preserve the SAVE/RECALL registers, do not use the `RAM_MANAGER` program. Instead, load any other test program from a card or from RAM to clear the previous test program, and then reload the desired test.

See the [“Save/Recall” on page 247](#), and [“Saving and Recalling Instrument Setups” on page 70](#) for more information about save/recall registers.

Using the LISTOPTS (list options) Program

You can list the options that are installed in your Test Set (if any) using the LISTOPTS program. LISTOPTS also displays the firmware version of your Test Set.

Follow the steps below to run the LISTOPTS program

- Step 1.** Select the SOFTWARE MENU screen.
- Step 2.** Select the `Select Procedure Location:` field and choose ROM.
- Step 3.** Select the `Select Procedure Filename:` field.
- Step 4.** Select LISTOPTS from the list of programs.
- Step 5.** Press `Run Test` to run the program and follow the directions on the screen.

Using the DEMO Program

You can use the DEMO program to learn about the capabilities of the Test Set. This program demonstrates some of the most useful features of the Test Set.

Follow the steps below to run the DEMO program

- Step 1.** Select the SOFTWARE MENU screen.
- Step 2.** Select the `Select Procedure Location:` field and choose ROM.
- Step 3.** Select the `Select Procedure Filename:` field.
- Step 4.** Select DEMO from the list of programs.
- Step 5.** Press `Run Test` to run the program and follow the directions on the screen.

Using the ST_PLT (store or plot) Program

This program allows you to store a spectrum analyzer, or oscilloscope trace. The storage medium can be either a memory card or internal RAM. PC card or to plot a stored trace from a PC card.

Before running the program the test set must be setup to display the spectrum analyzer or oscilloscope trace as you want it plotted. They you run the ST_PLT program. Follow the steps below to run the ST_PLT program.

- Step 1.** Select the SOFTWARE MENU screen.
- Step 2.** Select the `Select Procedure Location:` field and choose ROM.
- Step 3.** Select the `Select Procedure Filename:` field.
- Step 4.** Select ST_PLT from the list of programs.
- Step 5.** Press k1 (Run Test) to run the program, instructions will be displayed on the Test Set display.
- Step 6.** Select the storage medium, either memory card (k1, Card) or an external disk drive (k5, Disk) connected to the GPIB connector.

NOTE

To use an GPIB disk drive, the instrument must be a sole controller. The program will prompt you.

- Step 7.** Select k1 Store OSC, k2 Store SA, or k4 Plot. You must first store a trace before plotting.
- Step 8.** After the trace is acquired, type a name of nine characters or less using the knob to select the character. Select Done with the knob when finished.
- Step 9.** Rerun ST_PLT by selecting k1 Run.
- Step 10.** Select k5 Plot, then select the file name using the knob. The trace will now be plotted on the screen.
- Step 11.** If you want the grid to show with the trace, select k4 Plotgrid. If you want to view the plot parameters, center frequency, V per division, etc., select k2 Show Info. If you want to exit, select k1 Done.

- “Average Power Measurements” on page 131
- “Adjacent Channel Power Measurements” on page 132
- “Rho Measurements” on page 133
- “Error Vector Magnitude (EVM) Measurements” on page 138
- “Code Domain Measurements – IS-95” on page 139
- “Code Domain Measurements – IS-2000” on page 142
- “IQ Constellation Diagram, IS-2000 only” on page 149
- “PN Offset Search” on page 149
- “Control Fields for CDMA Measurements” on page 150

CDMA Measurements

Average Power Measurements

Avg Pwr

Avg Pwr displays the average power level of all signals at the RF IN/OUT port. The units (watts, volts, or dBm) can be changed by positioning the cursor in front of the units field and then pressing the desired units key. (See “[Input Port](#)” on page 201.) Refer to the *Agilent Technologies 8935 CDMA Base Station Tests Applications Guide* for more information about average power measurements.

Screens on which this measurement is displayed

- CDMA ANALYZER
- CDMA GENERATOR

ADC FS

ADC FS is displayed when average power is measured. **ADC FS** indicates how close the measured power level is to the maximum allowed input level at the RF IN/OUT port for a particular **Pwr Gain** setting (on the CDMA ANALYZER screen). Changes to **ADC FS** can be made by altering the **Pwr Gain** field setting and by altering the signal level into the RF IN/OUT port. **ADC FS** should be between -1.0 and -10 dB when the **Pwr Gain** field is set to **Auto**, and can be manually set up to -0.5 dB when set to **Hold**. The measurement will be aborted if **ADC FS** goes above -0.5 dB. Measurement accuracy may be degraded if **ADC FS** goes below -10 dB.

Screens on which ADC FS is displayed in conjunctions with Average Power measurements

- CDMA ANALYZER
- CDMA GENERATOR

Adjacent Channel Power Measurements

ACP

Adjacent channel power can be measured at frequency offsets of 0 to 3 MHz, and filter bandwidths of 10 kHz to 1.23 MHz with 100 Hz resolution. This measurement returns three, channel-tuned power values:

- **Center Channel** - the channel power at the center frequency
- **Upper ACP Ratio** - the ratio of the total power in the specified bandwidth at the specified offset above the center frequency, to the power at the center frequency.
- **Lower ACP Ratio** - the ratio of the total power in the specified bandwidth at the specified offset below the center frequency, to the power at the center frequency.

NOTE

This measurement must be calibrated using the **ACP Cal** field each time the tune frequency is changed. You must always remove power at the ANT IN or RF IN/OUT connector before calibrating channel power to ensure accurate calibration.

Screens on which this measurement is made:

- CDMA ANALYZER
- CDMA GENERATOR

Channel Power Measurements

Chan Pwr

Channel power can be measured using one of two filters selected with the **Ch Pwr Filt** field on the CDMA ANALYZER screen:

- **1.23M** - Channel power is the absolute power level of the RF signal in a 1.23 MHz bandwidth centered around the RF channel or tune frequency setting.
- **30kHz** - Channel Power measures the power in a 30 kHz band.

NOTE

This measurement must be calibrated using the **Chan Pwr Cal** field each time the tune frequency is changed. You must always remove power at the ANT IN or RF IN/OUT connector before calibrating channel power to ensure accurate calibration.

Refer to the *Agilent Technologies 8935 CDMA Base Station Tests Applications Guide* for more information about channel power measurements.

ADC FS

ADC FS is displayed when channel power is measured. ADC FS indicates how close the measured power level is to the maximum allowed input level at the RF IN/OUT port for a particular Gain setting (on the CDMA ANALYZER screen). Changes to ADC FS can be made by altering the Gain field setting and by altering the signal level into the RF IN/OUT port. ADC FS should be between -1.0 and -0.5 dB. Measurement accuracy may be degraded if ADC FS goes below -10 dB when the Gain field is set to Auto, and can be manually set up to -0.5 dB when set to Hold. The measurement will be aborted if ADC FS goes above.

Screens on which this measurement is displayed

- CDMA ANALYZER
- CDMA GENERATOR

Rho Measurements

Rho

Rho is a measure of CDMA waveform quality which indicates how well the measured signal (the pilot signal transmitted by the base station under test) correlates with the ideal reference waveform (the ideal pilot generated by the Test Set which is mathematically perfect). This measurement is done through a complex DSP algorithm. Perfect correlation is when rho is equal to 1. The CDMA standard specifies 0.912 as the minimum accepted performance for CDMA base stations.

To make rho measurements, the base station needs to be configured to transmit only a pilot signal. The test equipment is then triggered by any of the selectable CDMA clocks.

Many different factors can contribute to rho failure, including:

- compression in the linear power amplifier
- phase non-linearities (group delay)
- carrier feedthrough (see [“Carrier Feedthrough” on page 136](#))
- I/Q magnitude and phase errors (see [“Magnitude Error” on page 138](#) and [“Phase Error” on page 138](#))

Figure 5-1

Rho

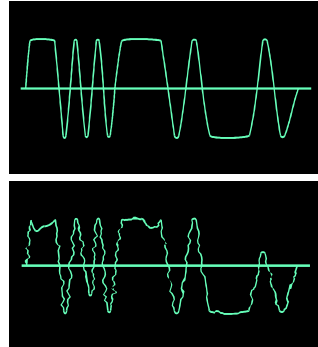

$$\rho = \frac{\text{Power that correlates with ideal}}{\text{Total Power}}$$

$$\rho = \frac{\text{Signal Power}}{\text{Signal Power} + \text{Error Power}}$$

$$\rho > 0.912$$

Screens on which this measurement is displayed

- CDMA ANALYZER
- CDMA GENERATOR

Estimated Rho (Est Rho)

Estimated rho is an calculated approximation of rho that is made without taking the base station out of service.

Screens on which this measurement is displayed

- CODE DOM (Code Domain Analyzer)

Frequency Error (Freq Err)

Frequency error is displayed when the Rho measurement is selected. Frequency error is the difference between the base station's transmitter frequency and the frequency you enter in the **Tune Freq** field.

Screens on which this measurement is displayed

- CDMA ANALYZER
- CDMA GENERATOR
- CODE DOM (Code Domain Analyzer)

Time Offset

Time offset is displayed when the **Rho** measurement is selected. Time offset is the time difference between the base station's even second and the start of the short sequence. It indicates how well your transmitter's signal is time-aligned to system time. Time offset is measured at the base station's antenna. The displayed value is based on the value entered in the **PN Offset** field. (See "PN Offset" on page 165.)

In [Figure 5-2 on page 136](#) the first example is a measurement with a time offset of zero. The beginning of the received data block aligns with the first pilot PN chip of the reference signal. Zero time offset indicates that the trigger event to the CDMA Analyzer coincided with the arrival of the base station signal's first pilot PN chip.

When the base station's signal is delayed relative to the trigger event, time offset will be a positive value. The second example is a measurement with a positive time offset. The beginning of the data block will align with a portion of the reference signal toward the end of a pilot PN sequence. This indicates that the trigger event to the CDMA Analyzer occurred when the base station was still transmitting a pilot PN sequence prior to the first pilot PN chip of the expected sequence.

When the base station's signal is early relative to the trigger event, time offset will be a negative value. The third example is a measurement with a negative time offset. The beginning of the data block will align with a portion of the reference signal after the first pilot PN chip. This indicates that the trigger event to the CDMA Analyzer occurred after arrival of the base station signal's first pilot PN chip.

Screens on which this measurement is displayed

- CDMA ANALYZER
- CDMA GENERATOR
- CODE DOM (Code Domain Analyzer)

Figure 5-2

Time Offset

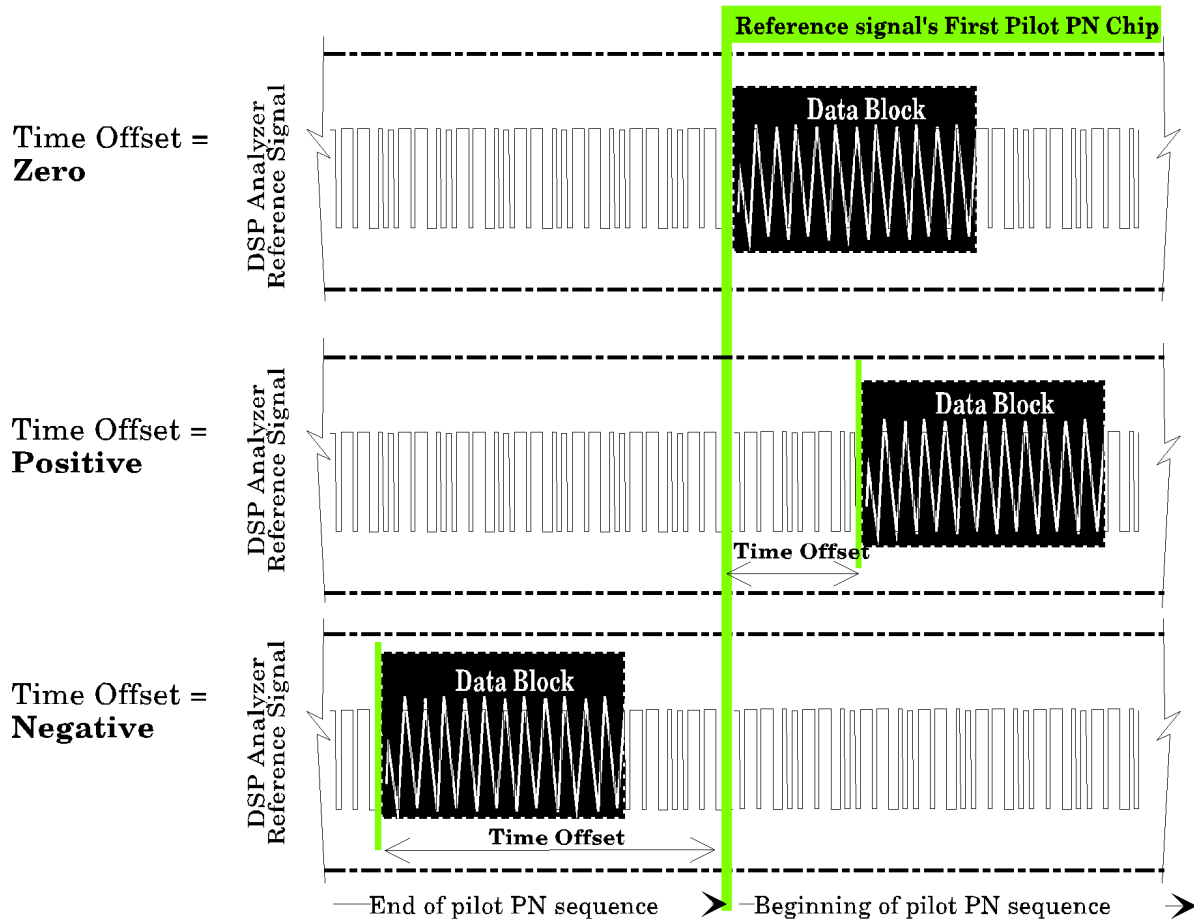

Carrier Feedthrough

Carrier feedthrough is displayed when the Rho measurement is selected. Carrier feedthrough is a common cause of bad rho measurements. Carrier feedthrough is a result of RF carrier signal feeding through the I/Q modulator and getting on the output circuitry without getting modulated. A good carrier feedthrough level is lower than -25 dB (such as -29 dB).

As shown in the diagram, a perfect constellation is offset by the magnitude of the carrier feedthrough. In the frequency domain, carrier feedthrough can show up as an uncorrelated energy spike that can be seen on the spectrum analyzer by closely scanning the top of the trace. The effects of carrier feedthrough can also show up as higher noise levels on the CODE DOM screen. The inactive Walsh codes will be pushing the -27 dB specification for noise. Carrier feedthrough can be caused by the lack of isolation across the mixer and cavity of the transmitter's I/Q modulator. Shielding can help reduce carrier feedthrough.

Figure 5-3

Carrier Feedthrough

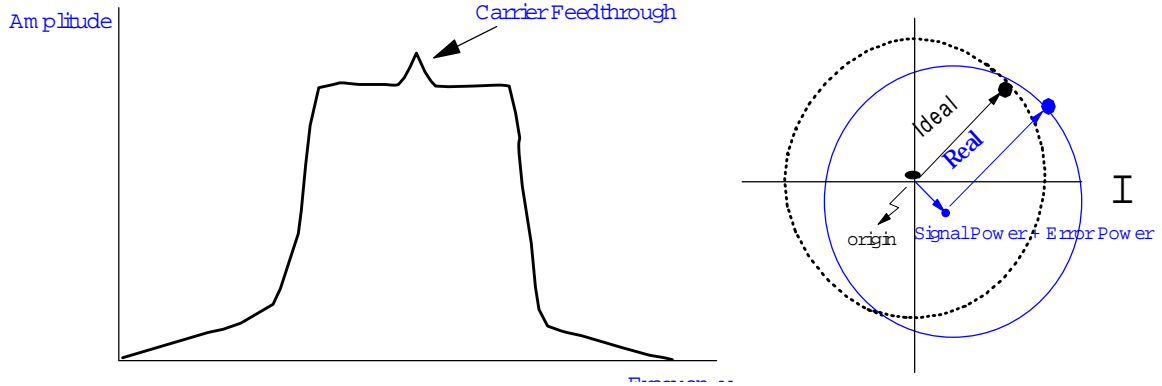

Screens on which this measurement is displayed

- CDMA ANALYZER
- CDMA GENERATOR
- CODE DOM (Code Domain Analyzer)

Error Vector Magnitude (EVM) Measurements

EVM

EVM is a measurement of the accuracy of the phase and amplitude of the QPSK (Quadrature Phase Shift Keying) or Offset QPSK (OQPSK) modulation. Expressed as a percentage, it is the RMS magnitude value of the error vector which connects the ideal signal phasor to a measured signal phasor at the detection decision points.

Figure 5-4 Components of Error Vector Magnitude

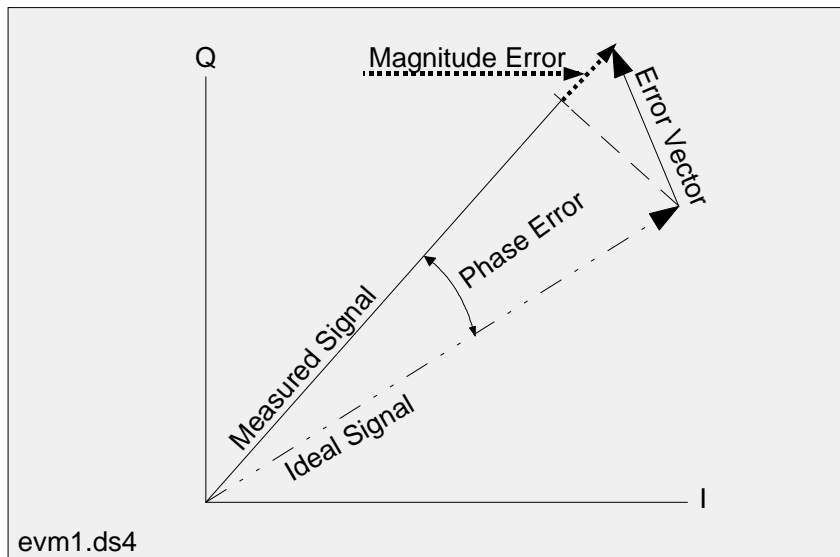

The magnitude of this error vector represents the “error” between the ideal signal and the measured signal.

As part of the measurement, the signal is corrected for clock delay, carrier frequency, carrier phase, and amplitude scaling.

Magnitude Error

Magnitude Error is the difference in the RMS magnitude value (in percent) between the ideal signal phasor and the compensated, measured signal phasor at the detected decision points.

Phase Error

Phase Error is the RMS value of the difference in phase (degrees) between the ideal signal phasor and the compensated, measured signal phasor at the detection decision points.

Screens on which this measurement is displayed

- CDMA ANALYZER
- CDMA GENERATOR

Code Domain Measurements – IS-95

If you have selected IS-95 only in the INSTRUMENT CONFIGURE screen, the Code Domain screen will appear as described in this section, with the Walsh Code ordering following the Hadamard paradigm, with 64 channels, total. These channels are referred to as “I” channels.

If you wish to make use of the extended Walsh ordering - Bit Reverse - as described by the IS-2000 standard, see See “Code Domain Measurements – IS-2000” on page 142.

The following measurements are displayed on the CODE DOM (code domain analyzer) screen: power, fast power, timing and phase. Measurements are selected from the **Measurement** field on the **Main** controls menu.

Time offset (Tm Ofs) and frequency error (Freq Err) are always displayed when any code domain measurement is made. Carrier feedthrough (CarFT) is also displayed except when fast power is measured.

Figure 5-5

Code Domain Power

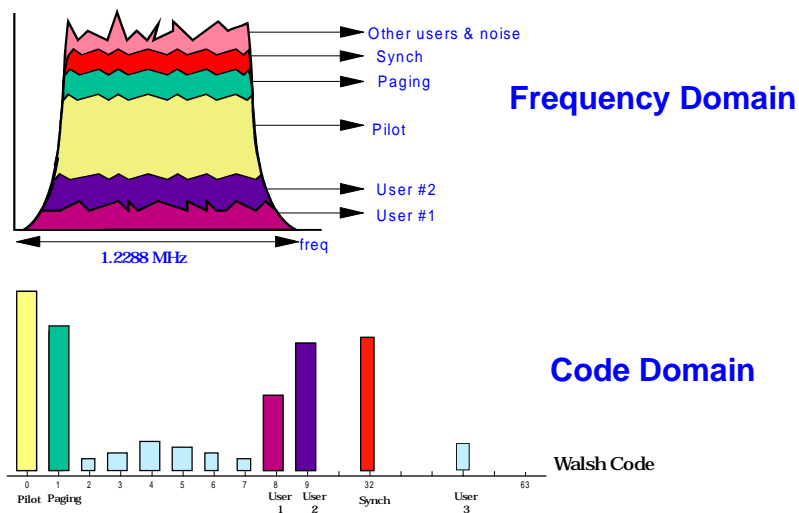

Code Domain Power, IS-95

The Test Set provides two code domain power measurements.

- Absolute code domain power displays the power in each of the 64 Walsh channels, relative to the total power inside a 1.23 MHz bandwidth centered at the tune frequency. The 64 Walsh channels (0 through 63) are represented by a vertical bar on the analyzer’s display. To measure absolute code domain power the **Ch pwr unit** field on the **CD Setup** menu must be set to **Abs** (see Figure 5-6). Use the **Marker** controls to move the marker to the Walsh channel (**Walsh Chan**) you want to measure (see Figure 5-7 on page 140).

- Relative code domain power displays the power in each of the 64 Walsh channels, relative to the pilot's power. (Pilot power is approximately two-thirds of the total power.) The 64 Walsh codes (0 through 63) are represented by a vertical bar on the analyzer's display. To measure relative code domain power the **Ch pwr unit** field on the **CD Setup** menu must be set to **Rel** (see Figure 5-6). Use the **Marker** controls to move the marker to the Walsh channel (**Walsh Chan**) you want to measure (see Figure 5-7 on page 140).

Figure 5-6 Selecting Absolute or Relative Code Domain Power, IS-95 only

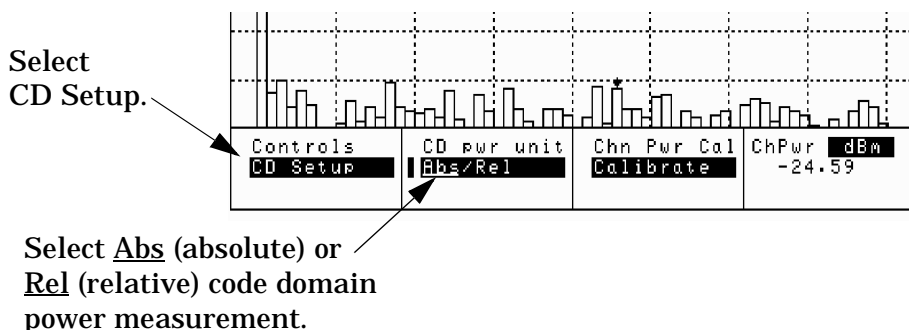
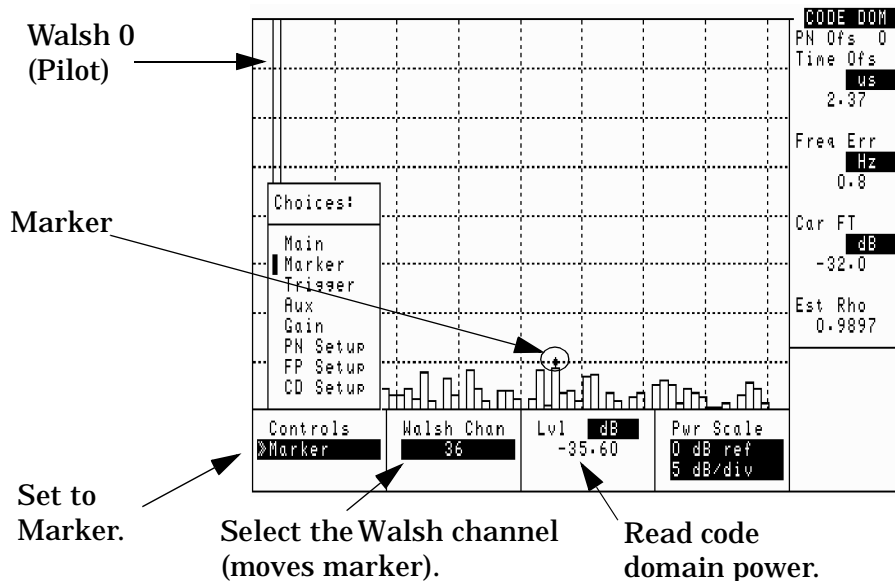

Figure 5-7 Reading Code Domain Power, IS-95 only



The units for absolute power are dBm. The units for relative power are dB.

Screens on which this measurement is displayed

- CODE DOM (Code Domain Analyzer, IS-95 only)

Fast Power

Fast power is a faster method of measuring code domain power. A value for Time Offset must be transferred from a non-fast power measurement before fast measurements begin, or when changes to any of the following fields occur: **Data Rate**, **PN Offset**, **CDMA TB**, **Synth Ref**.

See “[Ofs Trnsfer](#)” on page 164 for more information.

The number of measurement averages can be entered in the Num Avgs field on the FP Setup menu. This number is used to calculate and display successive code domain power measurements.

Screens on which this measurement is displayed

- CODE DOM (Code Domain Analyzer)

Code Domain Timing (Timing)

Code domain timing is the difference in time between pilot (Walsh 0) and other Walsh codes with the same forward CDMA channel. In the CODE DOM screen, this measurement is indicated as positive or negative bar with the size of the bar indicating how far ahead or behind the other Walsh channels are relative to the pilot. Signals above the reference are leading in time; signals below the reference are lagging. (See [Figure 5-8](#) on page 142.)

Screens on which this measurement is displayed

- CODE DOM (Code Domain Analyzer, IS-95 only)

Code Domain Phase (Phse)

Code domain phase is the difference in phase between the pilot and other code channels (Walsh codes) within the same forward CDMA channel. It displays the phase error for each of the 64 Walsh channels relative to the pilot channel (Walsh 0). This measurement is indicated as positive or negative bars on the Test Set's CODE DOM screen. The size of the bar indicates how much the phase of other Walsh codes lead or lag the pilot. Signals above the reference are leading in phase; signals below the reference are lagging.

Figure 5-8 Code Domain Timing and Phase

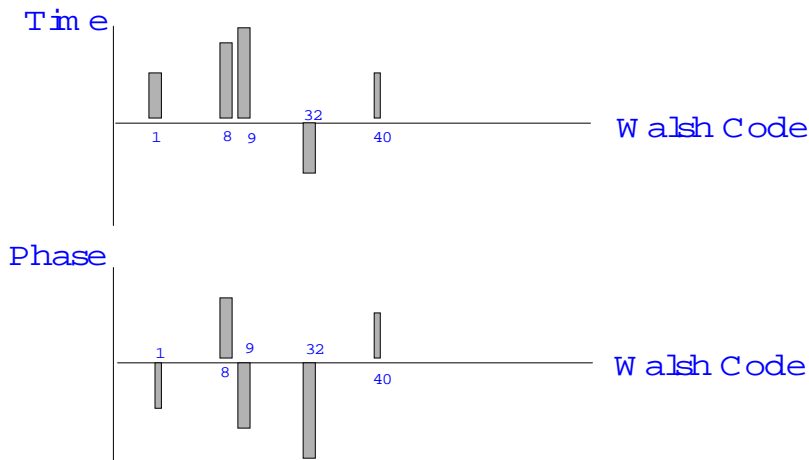

Screens on which this measurement is displayed

- CODE DOM (Code Domain Analyzer, IS-95 only)

Code Domain Measurements – IS-2000

If you have selected IS-2000 in the INSTRUMENT CONFIGURE screen, the Code Domain screen will appear as described in this section, with a default Walsh Code ordering following the Bit Reverse paradigm, with 128 channels.

If you wish to make use of the traditional Walsh ordering - Hadamard - as described by the IS-95 standard, see [“Meas Order” on page 163](#).

Bit Reverse, or Walsh index ordering display mode for Code Domain Power is a newly defined order for code domain measurements supporting IS-2000 CDMA. This coding sequence differs from IS-95's, or Hadamard ordering as shown in [Figure 5-10](#).

Advantages of Using IS-2000

The CDMA standard, IS-2000, offers a number of enhancements to the IS-95 standard including the following:

- Reverse Link Pilot for Each Mobile – Allows base stations to perform synchronous detection during demodulation, resulting in a performance gain.
- True QSPK Modulation – Yields 2 bits per symbol, allowing twice the processing gain to be applied to both I and Q data. This, more efficient modulation also allows for stronger convolutional encoding.
- Continuous Reverse Link Waveform – Continuous (no pulse) reverse link provides less biomedical interference and better transmit power averaging.

- Improved Convolutional Encoding for 14.4 Kbps Voice Channels – Improved spectral efficiency and higher spreading rates allow voice channels using the 14.4 Kbps vocoder now have robust convolutional encoding.
- Fast Closed Loop Power Control on Forward Link traffic.
- Auxiliary Pilot support for Beam Forming
- Forward Link Transmit Diversity - OTD, Multi-Antenna

Interpreting IS-2000 Channel Ordering

The IS-95 standard includes only 64 Walsh codes which map directly into channels, numbered consecutively from 0 to 63 (Hadamard ordering). This provided a uniform channel size regardless of purpose.

The IS-2000 standard allows up to 128 Walsh codes. In addition, to handle the wide range of data rates available in IS-2000 (9.6 kbps for voice up to 307.2 kbps for low mobility data), variable length Walsh code spreading is used. The code tree representation, shown in [Figure 5-9](#), of the variable length Walsh codes is useful in understanding how these codes are generated and how they can be selected to maintain orthogonality.

Figure 5-9

Building a tree using the Bit Reverse method

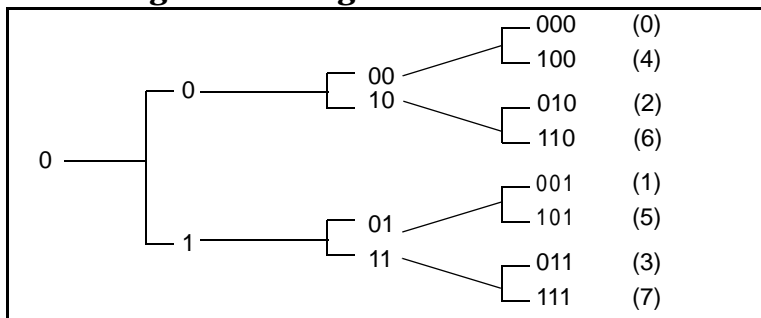

To generate a Walsh code tree, take the initial code, first add a place (bit) in the most significant number's (MSN) place. Then, for the upper branch, give this bit the value "0". Finally, for the lower branch give this number the value "1". This process proceeds to generate more and more branches until you have reached the desired Walsh code length. The code sets are denoted by their length in bits which corresponds to the vertical columns (all codes that have the same Spread Factor) in the tree.

The Walsh order (number of bits that comprises the specified code) (see [Figure 5-10](#)) indicates the bit number to use to spread the data. Before being spread, data is assigned to the Walsh codes encompassed by the spread. After encoding and interleaving, the data is spread according to the Walsh order.

Figure 5-10 IS-95 representation utilized Walsh order 6 alone in assigning channel numbers. The Walsh index utilizes Walsh orders 0 - 7

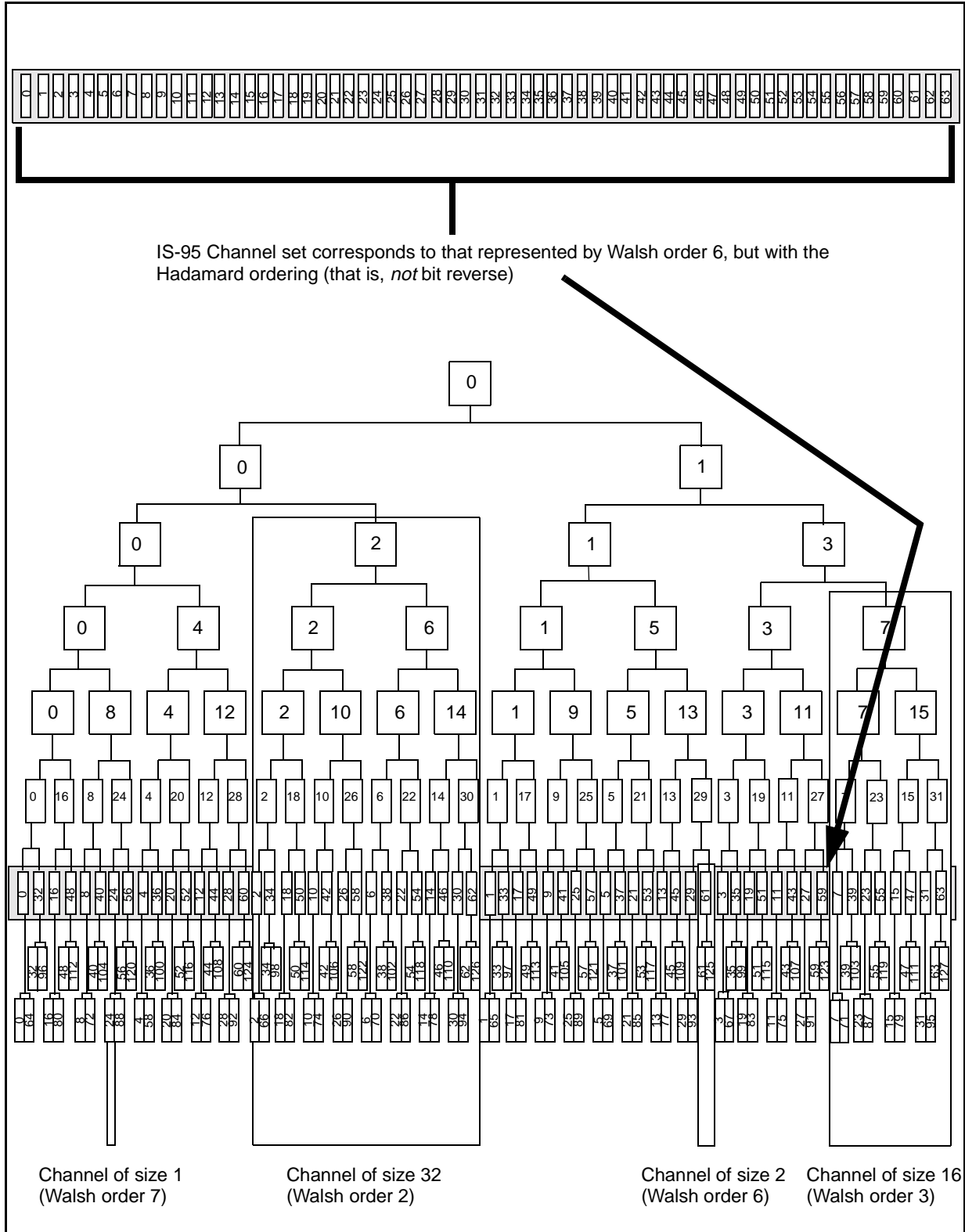

The order selected depends on the data type. A Walsh order of 1 (one), will result in a channel size of 128. This size excludes all other channel numbers from the transmission. However, a Walsh order of 2, on any of the 4 possible Walsh codes at that level (3, 1, 2 or 0)) reserves *all* the channels which can be generated from this channel, using the bit reverse algorithm, on Walsh orders 2 through 7.

This is shown in [Figure 5-10](#), where the channel 1 has been selected with Walsh order 2. The shaded box indicates all the channels which will be assigned this code set. The Channel size indicates the number of Walsh orders implicated in the original Walsh order/Walsh code selection.

Available Measurements in the Code Domain

The following measurements may be selected from within the Code Domain screen:

- Power
- Fast Power
- Complex Power
- Power & Noise
- Fast Power Synchronize

Channels are indicated both by the selected number (0-127) as well as by the Walsh order to which they have been assigned or the channel size, depending on your selection.

The Code Domain may be viewed either in the Bit Reverse ordering as shown in [Figure 5-11](#) or using the Hadamard ordering, as shown in [Figure 5-12](#).

Figure 5-11 Code Domain Power, Bit Reverse Ordering

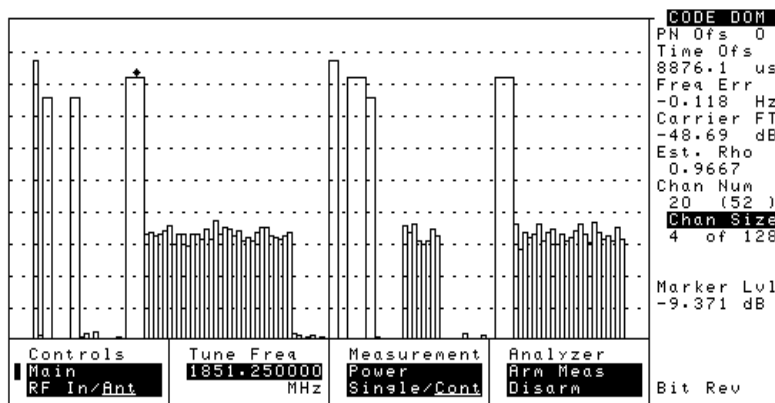
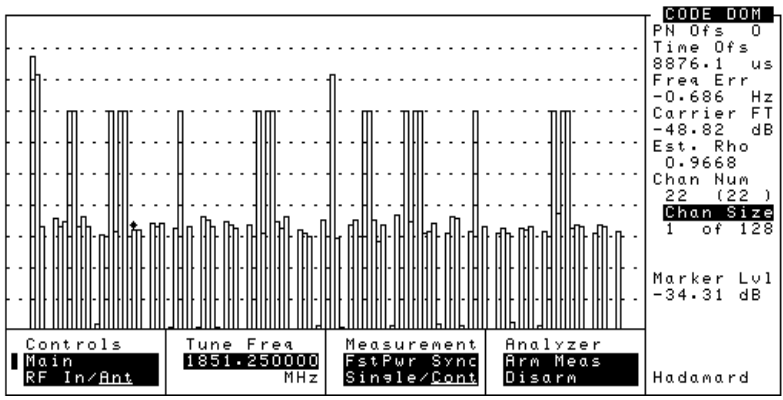

Figure 5-12 Code Domain Power, IS-2000, Hadamard Ordering



Time offset (**Tm Ofs**) and frequency error (**Freq Err**) are always displayed when any code domain measurement is made. Carrier feedthrough (**CarFT**) is also displayed except when fast power is measured.

Code Domain Power, IS-2000

The code domain power displays the power in each of the 128 Walsh channels, relative to the total power inside a 1.23 MHz bandwidth centered at the tune frequency. The 128 Walsh channels (0 through 127) are represented by a vertical bar on the analyzer's display. Use the **Marker** controls to move the marker to the channel you want to measure. Reading the Code Domain Power in IS-2000 mode is slightly different than in IS-95 only mode. [Figure 5-13](#) illustrates some of the important parameters. Note that **Chan Num** is now comprised of two values: the supplemental channel (20 in [Figure 5-13](#)) and the Walsh channel ((52) in [Figure 5-13](#)).

Figure 5-13 Reading Code Domain Power, IS-2000

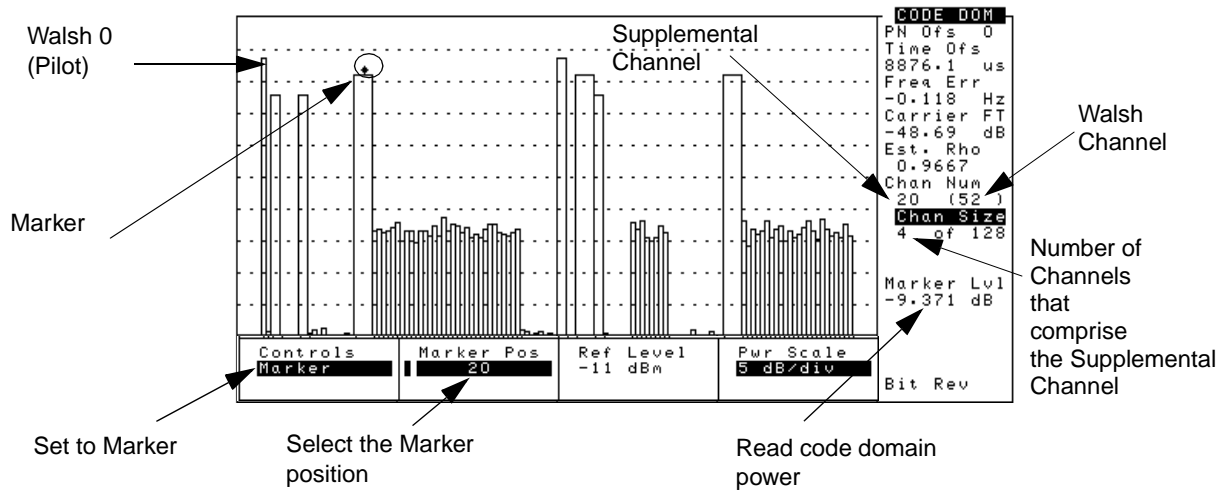

Screens on which this measurement is displayed

- CODE DOM (Code Domain Analyzer, IS-2000)

Fast Power

Fast power is a faster method of measuring code domain power. A number of internal values must be transferred from a non-fast power measurement before fast measurements begin, or when changes to any of the following fields occur: Data Rate, PN Offset, CDMA TB, Synth Ref.

The Fast Power Synchronize measurement is designed to set these internal variables.

The number of measurement averages can be entered in the Num Avgs field on the FP Setup menu. This number is used to calculate and display successive code domain power measurements.

Screens on which this measurement is displayed

- CODE DOM (Code Domain Analyzer)

Code Domain Power & Noise

The Power & Noise option displays the Code Domain channels along with channel noise, shown as hatch marks within each channel area. Noise and power are combined in supplemental channels to take into account the relationship between channel width and noise power. For example, a supplemental channel with a width of 2, in which each individual channel has a noise power value of -15 dBm, will have a combined noise power value of -12 dBm, or an increase of roughly 3 dB.

Figure 5-14 Code Domain Power & Noise

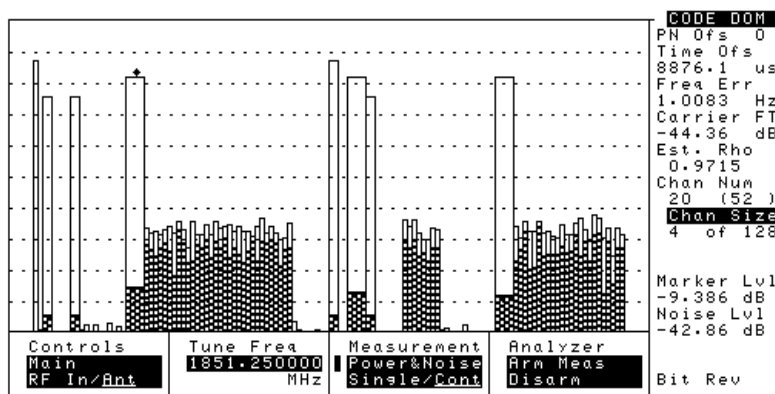

Screens on which this measurement is displayed

- CODE DOM (Code Domain Analyzer)

Code Domain Complex Power

The Complex Power measurements provides two views of the current Power values in the code domain:

- I Code View – IS-95 channels *and* IS-2000 channels combined
- Q Code View – IS-2000 channels only

Figure 5-15 Code Domain Complex Power

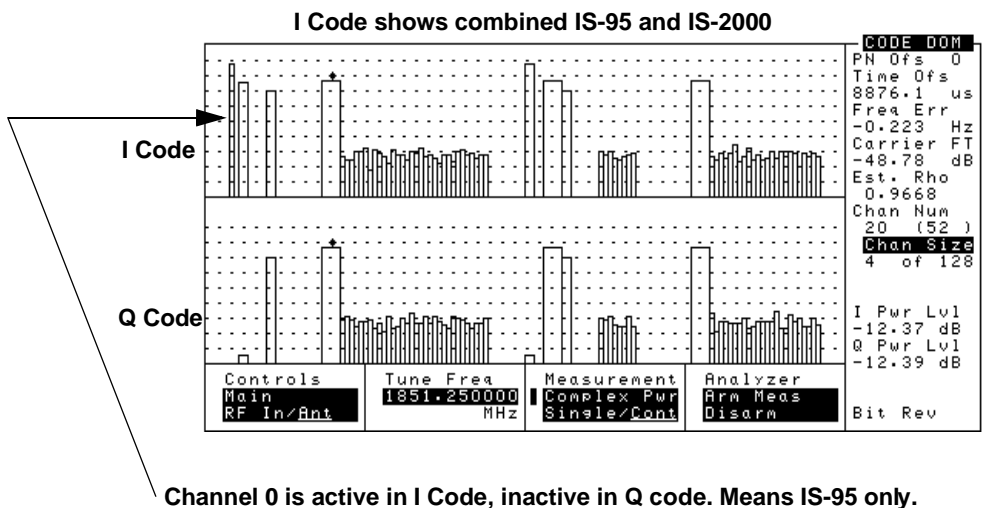

Screens on which this measurement is displayed

- CODE DOM (Code Domain Analyzer)

Code Domain Fast Power Synchronize

The Fast Power Synchronize measurement is designed to make a Power measurement and ensure that all the internal values are set properly for a Fast Power measurement. It will have the same look and feel as a IS-2000 Code Domain Power measurement (see [“Code Domain Power, IS-2000” on page 146](#)). After one fast power synchronize measurement is made the Fast Power measurement can be made (see [“Fast Power” on page 147](#)).

Screens on which this measurement is displayed

- Code Dom (Code Domain Analyzer, IS-2000)

IQ Constellation Diagram, IS-2000 only

If you have the IS-2000 option installed, you will be able to select the I/Q PLOT screen from the set of available measurements.

Figure 5-16 IQ Constellation Diagram

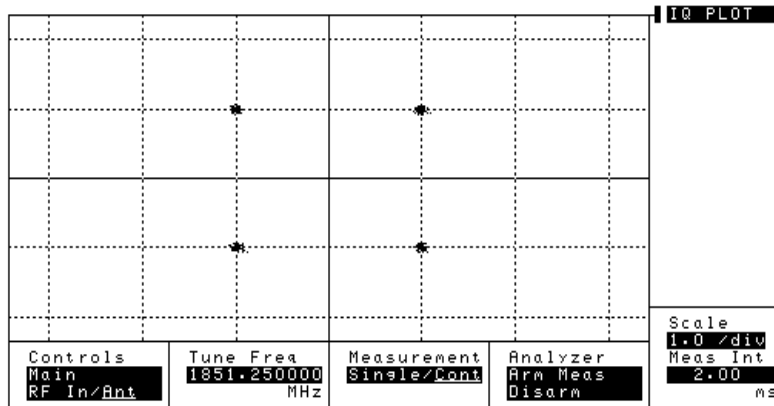

The I/Q Constellation Diagram screen graphically shows I/Q decision points. This is a useful troubleshooting tool when investigating Rho problems

Visual presentation helps identify IQ errors. [Figure 5-16](#) shows no errors. However, the 4 point groupings could be skewed away from perfect square or offset indicating a phase error. This will result in interference from I to Q and from Q to I. Phase errors can result from crosstalk between I and Q in the base station baseband processing section, misaligned LOs or intermodulation between Walsh codes.

PN Offset Search

There are two ways to provide your Base Station's PN Offset value to the Test Set:

- Enter the value directly. See [“PN Offset” on page 165](#)
- Have the Test Set determine the value from the received signals. See [“PN Increment” on page 165](#)

Control Fields for CDMA Measurements

of Frames

See “Data Source” on page 157.

ACP Cal

This field calibrates the ACP measurement for the current RF analyzer frequency at the selected frequency offset (**ACP Offset**) and filter bandwidth (**ACP Fltr BW**).

This field is displayed only when the ACP measurement is selected.

NOTE

You must always remove power at the ANT IN or RF IN/OUT connector before calibrating adjacent channel power to ensure accurate calibration.

Operating Considerations

The Test Set can memorize approximately 16 sets of ACP calibration data. If calibration data does not exist for a given channel and offset setting, the following message will be displayed:

ACP UNCAL: No Freq or ACP Offset cal. Start ACP Cal.

To clear this message, select the **ACP Cal** field to start the calibration. When the calibration is finished, the message will be gone.

Screens on which this field is present

CDMA ANALYZER

ACP Fltr BW

This field designates the filter bandwidth around the adjacent channels at which the measurements are made. Valid values are 10 kHz to 1.23 MHz with 100 Hz resolution.

This field is displayed only when the ACP measurement is selected.

Operating Considerations

Power is only *measured* with bandwidths up to 100 kHz. If a wider bandwidth is specified, the power in the first 100 kHz is measured and used to *calculate* the power in the total specified bandwidth.

Screens on which this field is present

CDMA ANALYZER

ACP Offset

This field designates the frequency offset from the center frequency at which the ACP measurement is made in the adjacent channels. Valid values are 100 kHz to 3 MHz.

This field is displayed only when the ACP measurement is selected.

Screens on which this field is present

CDMA ANALYZER

ADCfs or ADC FS

ADCfs indicates how close the measured power level is to the maximum allowed input level for the analyzer's Analog-to-Digital Converter (ADC). This level is affected by the **Gain** setting on the CODE DOM screen, the **Input Atten**, **Gain**, and, **Pwr Gain** settings on the CDMA ANALYZER screen, and the RF level of the signal connected to the Test Set.

For best measurement performance, ADCfs should be between -1.0 and -10 dB. The measurement will be aborted if ADCfs goes above 0.5 dB. Measurement accuracy may be degraded if ADCfs goes below -10 dB.

Screens on which this field is present

CODE DOM (Code Domain Analyze screen: gain controls menu)
CDMA ANALYZER (ADC FS)
CDMA GENERATOR (ADC FS)

Amplitude

This field sets the output level of the RF generator to the RF IN/OUT or DUPLEX OUT port. Use the DUPLEX OUT port for signal levels greater than -26 dBm.

Screens on which this field is present

CDMA GENERATOR

Analyzer (CDMA analyzer)

The **Analyzer** field controls three functions:

- **Arm Meas** arms the CDMA analyzer. The CDMA analyzer needs to be armed only when **Single** (see below) is selected.
- **Single/Cont** selects between “single” measurements and “continuous” measurements.
 - When **Single** is chosen, you must arm each measurement by selecting the **Arm Meas** field (see above).
 - When **Cont** (continuous) is chosen, measurements are automatically armed.

The default selection is **Cont**.

- **Disarm** disarms the CDMA analyzer during single operation. To stop continuous measurements, select **Single**. Selecting **Disarm** does not prevent the analyzer from being re-armed during continuous measurements

Screens on which this field is present

CDMA ANALYZER

Analyzer (code domain analyzer)

This field is used to arm or disarm measurements when making a single measurement (does not affect continuous measurements). Selecting **Disarm** stops the analyzer during a single measurement.

See “[Measurement](#)” on page 163 for more information.

Screens on which this field is present

COD DOM (Code Domain Analyzer): main controls menu

Anl Dir

This field is used to select the type of signal (forward or reverse link) to analyze.

- **Fwd** sets the analyzer to look for base station transmitter data (forward link).
- **Rev** sets the analyzer to look for mobile transmitter data (reverse link).

Default selection: **Fwd**

Screens on which this field is present

CDMA ANALYZER

Anl Special

Analyzer special modes change how IQ modulated signals are analyzed.

- **Normal** sets the CDMA generator and CDMA analyzer to create and analyze signals with standard rotation.
- **Inverted** sets reverse rotation for I and Q signals; opposite to the direction specified in the IS-95 standards. In this mode, the CDMA generator creates reverse-rotation IQ signals and the CDMA analyzer expects reverse-rotation IQ signals.

Screens on which this field is present

CDMA ANALYZER

Auto Zero

This field is displayed for average power measurements.

Auto is used to automatically zero the average power measurement periodically during operation.

Manual is used to override the **Auto** feature. When **Manual** is selected, you must manually zero the average power measurement by selecting the **Pwr Zero** field.

Screens on which this field is present

CDMA ANALYZER

Carrier FT or Carrier Feedthru

This field is a measurement display field. See [“Carrier Feedthrough” on page 136](#) for more information about this measurement.

Screens on which this field is present

COD DOM (Code Domain Analyzer)
CDMA ANALYZER
CDMA GENERATOR

Chan Num

IS-2000 only. Indicates the supplemental channel and Walsh channel or code (in parenthesis), at which the marker is currently located. The field will change when you change the value of the marker position using the numeric keypad or the knob in Marker control mode with Marker Pos is selected.

Screens on which this field is present

COD DOM (Code Domain Analyzer, IS-2000 only)

Chan Size

This field appears only in IS-2000 Code Domain measurements. The size reflects its location in the Walsh set, with 1 indicating that there is only one channel included. By comparison, a channel size of 32, will encompass (and therefore make unavailable) a total of 32, channels.

Screens on which this field is present

COD DOM (Code Domain Analyzer, IS-2000 only)

CD pwr unit

This field allows you to select absolute or relative power measurements for the code domain analyzer. See [“Code Domain Power, IS-95” on page 139](#) for more information about these measurements.

Screens on which this field is present

CODE DOM (Code Domain Analyzer)

Chn Pwr Cal

This field is displayed when the channel power measurements are selected. It is used to calibrate the channel power measurement. When this field is selected, an internally generated calibration signal is measured using the average power technique. Channel power is also measured and a correction factor is generated. This correction factor is applied to subsequent channel power measurements.

Calibration should be performed whenever a new set of measurements is made and whenever the frequency of the measured signal is changed. See [“Calibrating the Channel Power Measurement – CDMA Analyzer” on page 61](#) for more information on analyzer calibration and [“Calibrating the Channel Power Measurement – Code Domain” on page 62](#) for code domain calibration.

Screens on which this field is present

CDMA ANALYZER

CODE DOM (Code Domain Analyzer, IS-95 option): CD Setup Control menu, **Abs** selected for CD pwr unit.

CODE DOM (Code Domain Analyzer, IS-2000 option): Reference Control menu, **Abs** selected for CD pwr unit.

Controls

Code domain analyzer settings are arranged into several menus that are accessed using the **Controls** field. The control groups are:

- **Main** accesses the **RF In/Ant**, **Tune Freq** (or **RF Channel**), **Measurement**, and **Analyzer** fields.
- **Marker** controls the marker to look at the level of individual Walsh channels.
- **Trigger** accesses the trigger controls: **Qual Event** and **Trig Event**.
- **Aux** accesses the **Threshold** and **Meas Intvl** fields. In IS-2000 mode, **Aux** also accesses **Meas Order**.
- **Gain** lets you alter the gain **Gain** into the CDMA analyzer while reading the **ADCfs** value. The attenuation can also be changed **Input Atten**.
- **PN Setup** accesses the **PN Offset**, **PN Incrment**, and **Find PN** fields.
- **Reference**, only in IS-2000 mode, accesses the **CD pwr unit** and **Chn Pwr Cal** fields. **CD pwr unit** allows you to specify either absolute or relative values for power measurements.
- **FP Setup** accesses the offset transfer and number of averages fields used to make **fast power** measurements.
- **CD Setup**, in IS-95 only, accesses the **CD pwr unit**, **Chn Pwr Cal**, and **ChPwr** fields. **CD pwr unit** allows you to choose either relative or absolute power measurements.

Many of these controls are duplicates of those found on the CDMA ANALYZER and CDMA GENERATOR screens.

Screens on which this field is present

COD DOM (Code Domain Analyzer): all menus

CW RF Path

This field selects the path for the RF generator's signal.

- **Bypass** disables the IQ modulator. This mode is used when generating standard AM, FM, or CW signals in the Test Set.
- **IQ** enables the IQ modulator.

See "[Data Source](#)" on page 157 for more information.

Screens on which this field is present

CDMA GENERATOR

Data Rate

This field allows receiver testing at data rates of 9.6 or 14.4 Kbps.

If the data buffer is the selected data source, and the data rate is changed, the transmission state will change to `Idle`. Select `send` to resume data output at the new rate.

Choices

- 14.4 Kbps
- 9.6 Kbps

Default selection: `9.6 Kbps`

Screens on which this field is present

CDMA GENERATOR

Data Source

This field selects where the baseband quadrature spreader gets its data. This field is removed when the **Gen Mode** field is set to **Noise**.

- **Zeroes** uses a data stream of all 0's that is not encoded before being applied to the baseband quadrature spreader and output.
- **Ext** uses external data from the DATA IN connector. This data is not encoded before being applied to the baseband quadrature spreader.
- **Random** uses 300 frames of random, error-free data. (See **Data Buff** (below) for **Single/Cont**, **Idle/Send** operation.)
- **Data Buff** uses data previously loaded into the data buffer. You can load your own data into the buffer over GPIB. This data is encoded before baseband quadrature spreading. Choosing this selection displays these additional fields:
 - **Single/Cont**
 - **single** causes the data stream to be output once when **Send** is selected.
 - **Cont** causes the data stream to be repeated continuously when **Send** is selected. Changing to single operation while sending causes the data to be interrupted after the current 20 ms frame.
 - **Idle/Send**
 - **Idle** indicates that data from the buffer is not being transmitted. Selecting **Idle** while sending data interrupts the data at the completion of the current 20 ms frame. A data stream of all zeroes (encoded) continues to be transmitted after the initial data stream is interrupted. This is different from the **Zeroes** selection above where the data is not encoded.
 - **Send** causes the data stream to be output after two rising edges of the internal 80 ms clock are detected.
 - **Start Frame** specifies the first frame of data to send.
 - **# of Frames** specifies how many frames of data to send.

Screens on which this field is present

CDMA GENERATOR

Even Sec In

This field controls the internal connection of the EVEN SECOND SYNC IN connector to the CDMA analyzer or generator.

- When **Enable** is selected, signals applied to the EVEN SECOND SYNC IN connector synchronize the timing circuits.
- When **Not** is selected, input signals applied to the EVEN SECOND SYNC IN are ignored. This mode may be useful when signals other than an even-second clock are used for synchronization. For example, when using a one-second clock, you would select **Not** after synchronization to prevent the internal even-second clock from being retriggered half-way through its cycle.

Screens on which this field is present

CDMA ANALYZER
CDMA GENERATOR

Find PN

This field selects whether the PN offset will be automatically calculated (**Auto**), or manually entered (**Manual**). (See [“PN Increment” on page 165](#) and [“PN Offset” on page 165](#) for more information.)

Screens on which this field is present

CODE DOM (Code Domain Analyzer)

Freq Err

This measurement display field displays the frequency error. See [“Frequency Error \(Freq Err\)” on page 134](#) for more information about this measurement.

Screens on which this field is present

CODE DOM (Code Domain Analyzer)
CDMA ANALYZER
CDMA GENERATOR

Gain

This field sets the IF gain of the CDMA analyzer for rho, EVM, and channel power measurements. (Range: 0 dB to 36 dB in 6 dB steps.)

Gain is adjusted two ways:

- **Auto** measures the signal level and automatically adjusts the gain.
- **Hold** disables automatic operation to allow you to manually enter the desired gain by selecting the current gain setting and entering a new value using the keypad or cursor control knob.

This field is replaced by the **Pwr Gain** field when measuring average power on the CDMA ANALYZER screen. See “[Input Atten](#)” on page 161 for more information.

Screens on which this field is present

CDMA ANALYZER

COD DOM (Code Domain Analyzer): gain controls menu

Gen Dir

This field sets the link direction of the CDMA signal.

- **Fwd** (forward) sets the CDMA generator to produce QPSK modulation to imitate a base station. The EQ filter field is automatically displayed and set to **EQ In** to apply an equalizing filter to the I and Q paths as part of the baseband filtering, but it can be changed to **Out**.
- **Rev** (reverse) sets the CDMA generator to produce OQPSK modulation to imitate a mobile station. The EQ filter field is not displayed because it is automatically set to **Out** (and cannot be changed). It is set to **Out** to remove the equalizing filter from the I and Q paths.

Screens on which this field is present

CDMA GENERATOR

Gen Mode

This field selects the type of modulation information sent to the CDMA generator's IQ modulator.

- **Data** allows data to be transmitted to simulate a traffic channel with no additive noise. (See “Data Source” on page 157.)
- **Eb/No** causes a combination of data and White Gaussian Noise (AWGN) noise to be transmitted. The value entered is the ratio between the energy of each information bit (E_b) and the noise spectral density (N_0), expressed in dB.
- **Noise** causes a signal modulated by White Gaussian Noise to be generated. The noise is band limited to 2 MHz and white inside a 1.25 MHz bandwidth centered around the RF Gen Freq. This selection removes the Data Source, Start Frame, and # of Frames fields from the screen; those fields are only used with the Data and Eb/No entries.

Screens on which this field is present

CDMA GENERATOR

Gen Special

Generator special modes change how IQ modulated signals are generated.

- **Normal** sets the CDMA generator and CDMA analyzer to create and analyze signals with standard rotation.
- **Inverted** sets reverse rotation for I and Q signals; opposite to the direction specified in the IS-95 standards. In this mode, the CDMA generator creates reverse-rotation IQ signals and the CDMA analyzer expects reverse-rotation IQ signals.

Screens on which this field is present

CDMA GENERATOR

Input Atten

This field controls the RF attenuators of the Test Set. If an **ADC Overdriven** message is displayed at the top of the screen while making measurements, increase the attenuator setting until the message is no longer displayed. This is the coarse level adjustment for the signal level into the CDMA analyzer. Fine level adjustment is performed using the **Gain** field.

See [“Gain” on page 159](#) for more information.

NOTE

The **Input Atten** setting does not affect, and is not displayed with, the average power measurement.

Screens on which this field is present

CDMA ANALYZER
CODE DOM (Code Domain Analyzer): gain controls menu

Input Port

This field selects which Test Set port to use as the RF input. This field is not displayed when measuring average power, since you *must* use the RF IN/OUT port to measure average power.

CAUTION

Instrument Damage

To prevent instrument damage, do not exceed the maximum power level labeled at the connectors on your Test Set. The ANT IN connector is for measuring *low level* RF signals. High level (>60 mW) transmitter signals must be measured using the RF IN/OUT port.

Screens on which this field is present

CDMA ANALYZER
CODE DOM (Code Domain Analyzer): main controls menu

Lvl

This measurement displays the relative level of the selected Walsh channel when compared to the total power in a 1.23 MHz bandwidth centered around the **Tune Freq** setting. The measurement is displayed when the **code domain analyzer's** main controls **Measurement** field is set to **Power** or **Fast Pwr**. This function is appears as **Marker Lvl** for the IS-2000 option. See [“Marker Lvl” on page 162](#)

Screens on which this field is present

COD DOM (Code Domain Analyzer, IS-95 only): Marker controls menu

I Power Level

This IS-2000 Code Domain display field shows the power of the currently selected I (in the top bar graph) Walsh code.

Screens on which this field is present

COD DOM (Code Domain Analyzer, IS-2000 only): Complex Power measurement.

Marker Lvl

This display field shows the level of the channel or Walsh order at the current marker location (IS-2000 only) relative to the 0 dB reference level shown in **Pwr Ref** in the Marker control view. The location of the top of the channel relative to the reference level is determined by the **Pwr Scale** setting, also in the Marker control view.

The value for the power is calculated by averaging the total power over a 1.23 MHz bandwidth centered around the **Tune Freq** setting.

Screens on which this field is present

COD DOM (Code Domain Analyzer, IS-2000 only)

Marker Pos

This Code Domain field sets the index (starting at the left side of the bar graph) for the current marker location (IS-2000 only).

Screens on which this field is present

COD DOM (Code Domain Analyzer, IS-2000 only): Marker Controls menu.

Meas Intvl or Meas Int

This field determines the length of the data block. The data block is a time record over which correlated measurements are computed. As the interval is increased, measurement time is increased. Increasing the interval gives more accurate measurement results, particularly with frequency error and phase error measurements.

This field is displayed on the CDMA ANALYZER screen when a rho or EVM measurement is selected. It is also displayed on the CODE DOM (Code Domain Analyzer) controls menu.

Screens on which this field is present

CDMA ANALYZER
CODE DOM (Code Domain Analyzer): auxiliary controls menu

Meas Order

This field is displayed in the Code Domain Analyzer, IS-2000. The Measurement Order is the way in which the Walsh channels are shown on the screen. Select **Bit Reversed** to show channels grouped according to their Walsh order. Select **Hadamard** to show channels grouped by channel number, as in the IS-95 standard.

Screens on which this field is present

CDMA ANALYZER

CODE DOM (Code Domain Analyzer, IS-2000 only): auxiliary controls menu

Measurement

This field controls the type of code domain measurement to make. In IS-95 only mode, this includes power, fast power, timing, or phase. In IS-2000 mode, this includes power, fast power, power and noise, complex power, and fast power synchronization.

It also controls the measurement mode (single or continuous):

- **single** is used when you want to make one measurement. You must select the **Arm Meas** function of the **Analyzer** field before a measurement can be made.
- **cont** is used to continuously make measurements. Measurements are automatically re-armed after each measurement.

Screens on which this field is present

COD DOM (Code Domain Analyzer): main controls menu

Num Avgs

The number of averages determines how many measurements are averaged when measuring fast power. Averaging reduces measurement speed.

Screens on which this field is present

COD DOM (Code Domain Analyzer): fast power setup controls menu

Ofs Transfer

IS-95 only. This field transfers the time offset value from the time offset measurement (displayed in **TmOfs**) to the **Time Offset** field automatically. Before selecting **Ofs Transfer**, you must make at least one of the following code domain measurements:

- Power
- Timing
- Phase

Operating Considerations

When using this command programmatically, be sure a value for **TmOfs** has been obtained from a power, timing, or phase measurement. (One method of ensuring the measurement has been completed would be to send an GPIB command to query the results of the **TmOfs** field before sending the transfer command).

Screens on which this field is present

COD DOM (Code Domain Analyzer): FP setup controls menu

Output Port

This field selects the output port for the signal from the Test Set's RF and CDMA generators.

RF Out selects the RF IN/OUT connector.

Dup1 selects the DUPLEX OUT connector.

Screens on which this field is present

CDMA GENERATOR

Phase/div

This field sets the display resolution for the code domain phase measurement: 1, 2, 5, 10, 20, or 50 milliradians (mrad). This field is displayed on the CODE DOM screen's **Marker** menu when the **Measurement** field is set to **Phase**.

Screens on which this field is present

CODE DOM (Code Domain Analyzer, IS-95 only): marker controls menu

Phse

This field displays the results of the code domain phase measurement. This field is displayed on the CODE DOM screen when the **Measurement** field is set to **Phase**.

For more information about the code domain phase measurement see [“Code Domain Phase \(Phse\)” on page 141](#).

Screens on which this field is present

CODE DOM (Code Domain Analyzer, IS-95 only)

PN Incrment

This value is used to calculate the PN offset for the system. This field is displayed for EVM or Rho measurements when the **Find PN** field is set to **Auto**.

If you know the PN increment for the system you are testing, you can enter it in this field (this speeds the PN offset calculation). Enter 1 in this field if the PN increment is unknown.

Screens on which this field is present

CDMA ANALYZER

CODE DOM (Code Domain Analyzer): PN setup controls menu

PN Offset

This field is displayed for EVM or Rho measurements when the **Find PN** field is set to **Manual**.

Use this field to enter the PN sequence offset index for your base station. Each whole offset is equal to 64 chips (= 52.08 μ s). Fractional values are rounded off, and can be entered, in increments of 0.015625 (1 chip). Once entered, this value is shared by all CDMA screens.

This value is used by the analyzer when the **Even Sec In** field on the CDMA GENERATOR screen is set to **Enable**.

If the PN offset is unknown, the Test Set can calculate the PN offset using the PN increment. See [“PN Incrment” on page 165](#)

NOTE

When the **Even Sec In** field is set to **Not**, changes to the **PN Offset** field have no effect on the analyzer.

Screens on which this field is present

CDMA ANALYZER

CODE DOM (Code Domain Analyzer): PN setup controls menu

PN Offset or PN Ofs

This measurement display field (PN Offset) is displayed on the CDMA ANALYZER and CDMA GENERATOR screens when Rho measurements are selected. If the PN Offset measurement is not displayed, select the Freq Err measurement field, then choose PN Offset. The same measurement is displayed in the **PN Ofs** measurement field on the CODE DOM screen.

See “[Find PN](#)” on page 158 for more information.

NOTE

When the **Even Sec In** field is set to **Not**, changes to the **PN Offset** field have no effect on the analyzer.

Screens on which this field is present

CDMA ANALYZER

CDMA GENERATOR

CODE DOM (Code Domain Analyzer): PN setup controls menu

Pwr Gain

This field is used to set the level into the CDMA analyzer when making average power measurements. Levels are set in 6 dB increments. The IF signal level is displayed as **ADC FS** when average power is measured, and should be between -1.0 and -5 dB for best measurement results.

- **Auto** automatically sets the gain for an ADC FS value in the range of -1 to -5 dB. This is the recommended mode of operation.
- **Hold** lets you override the automatic setting to manually set the gain.

This field is only displayed when an average power measurement is selected.

Screens on which this field is present

CDMA ANALYZER

Pwr Intvl

This field determines the length of the data block when measuring average power. The data block is a time record over which correlated measurements are computed.

Range: 0.25 to 15.0 ms

Screens on which this field is present

CDMA ANALYZER

Pwr Ref

This Code Domain field determines the reference level from which the power reading is taken. This value is always 0 dB.

Screens on which this field is present

COD DOM (Code Domain Analyzer, IS-2000): marker controls menu

Pwr Scale – IS-95

The upper subfield is used to select the reference level for power measurements (relative to the total power of the entire CDMA channel). The reference is the top line of the screen and defaults to 0 dB.

The lower subfield is used to select the display resolution for the power measurement; 1, 2 or 5 dB per vertical division.

The power scale fields are displayed in the **Marker** menu when the **Main** controls **Measurement** field is set to **Power** or **Fast Pwr**.

Screens on which this field is present

COD DOM (Code Domain Analyzer): marker controls menu

Pwr Scale – IS-2000

This Code Domain field (IS-2000) is used to select the display resolution for the power measurement: 1, 2 or 5 dB per vertical division

The power scale field is displayed in the **Marker** menu when the **Main** controls **Measurement** field is set to **Power**, **Fast Pwr**, **Power & Noise**, **Complex Power** or **FstPwr Sync**.

Screens on which this field is present

COD DOM (Code Domain Analyzer, IS-2000 only): marker controls menu

Pwr Zero

Selecting this field calibrates (zeroes) the average power meter. This operation should be performed immediately before making an average power measurement. This field is only displayed if the average power measurement is selected.

Operating Considerations

The **Auto Zero** field causes average power to be periodically calibrated when set to **Auto**. If the **Auto Zero** field is set to **Manual**, you must use the **Pwr Zero** field to zero average power. (See “**Auto Zero**” on page 153 for more information.)

Screens on which this field is present

CDMA ANALYZER

Q Power Level

This IS-2000 Code Domain display field shows the power (in the lower bar graph) of the currently selected Q (IS-2000) Walsh code.

Screens on which this field is present

COD DOM (Code Domain Analyzer, IS-2000 only): Complex Power measurement.

Qual Event

This field selects a trigger qualifier. The trigger qualifier serves as a precursor to the analyzer’s trigger event. Selecting a trigger qualifier is required when a time-delayed trigger event is desired, or if the trigger signal is externally supplied at the TRIGGER QUALIFIER IN connector.

If a time-delayed trigger is used (see “**Trig Event**” on page 174), the qualifier starts the delay timer. When the timer expires, a trigger event occurs and a measurement is made.

- **None** causes the trigger event to be determined solely by the selection in the **Trig Event** field.
- **27 ms** is an internally generated clock signal.
- **20 ms** is an internally generated clock signal.
- **80 ms** is an internally generated clock signal (default selection).
- **2 s** is an internally generated clock signal.
- **Amp1 Lo** qualifies a trigger each time the input to the CDMA analyzer rises above -18 dB ADC FS. **ADC FS** is displayed when the average power measurement is selected, or when adjusting the **Gain**

field on the CODE DOMAIN ANALYZER screen.

- **Amp1 Mid** qualifies a trigger each time the input to the CDMA analyzer rises above -12 ADC FS.
- **Amp1 Hi** qualifies a trigger each time the input to the CDMA analyzer rises above - 6 ADC FS.
- **External** must be selected if the trigger qualifier is provided by an external source. The external signal connects to the TRIGGER QUALIFIER IN connector. A qualifier occurs on the input signal's rising edge.

Screens on which this field is present

CDMA ANALYZER

CODE DOM (Code Domain Analyzer): trigger controls menu

Rate RC-3

This field appears only in IS-2000 Code Domain measurements. The field displays the data rate of the currently selected channel in terms of an RC3 radio configuration.

Screens on which this field is present

CODE DOM (Code Domain Analyzer, IS-2000 only)

Rate RC-4

This field appears only in IS-2000 Code Domain measurements. The field displays the data rate of the currently selected channel in terms of an RC4 radio configuration.

Screens on which this field is present

CODE DOM (Code Domain Analyzer, IS-2000 only)

Rate RC-5

This field appears only in IS-2000 Code Domain measurements. The field displays the data rate of the currently selected channel in terms of an RC5 radio configuration.

Screens on which this field is present

CODE DOM (Code Domain Analyzer, IS-2000 only)

RF Channel

The **RF Channel** field is displayed when the **RF Display** field on the INSTRUMENT CONFIGURE screen is set to **Chan**.

This field displays the current channel number. Channel tuning eliminates the need to enter transmit and receive frequencies directly into the Test Set. Once the radio's RF channel standard is selected, you only have to enter the channel number to automatically set the **RF Generator** and **RF Analyzer** to the correct frequency.

Operating Considerations

To utilize the correct transmit and receive frequencies select the appropriate channel standard from the **RF Chan Std** field on the INSTRUMENT CONFIGURE screen.

Screens on which this field is displayed

CDMA ANALYZER
CDMA GENERATOR
CODE DOM (Code Domain Analyzer): main controls menu

RF Gen Freq

This field specifies the center frequency of the generated CDMA signal. This field is displayed only when the **RF Display** field on the INSTRUMENT CONFIGURE screen is set to **Freq**.

NOTE**Channel Tuning**

You can configure the Test Set to allow direct entry of channel numbers (instead of entering the frequency) by using the **RF Display** field on the INSTRUMENT CONFIGURE screen. See [“RF Channel” on page 170](#) for more information.

Screens on which this field is present

CDMA GENERATOR

RF In/Ant

This field selects the Test Set's RF input.

CAUTION

The maximum safe level into the ANT IN connector is 60mW. Exceeding this level could cause permanent damage to the Test Set.

Screens on which this field is present

CODE DOM (Code Domain Analyzer): main controls menu

Sprd Fact (Spread Factor)

This selectable IS-2000 Code Domain field shows the spread factor (Walsh set) of the currently selected channel. The spread factor represents the number of Walsh channels available if all channels use this spread factor. A spread factor of 128 corresponds to a Walsh order of 7 and a channel width of 1 (out of 128). A spread factor of 8 corresponds to a Walsh order 3 and a channel size of 16. The spread factor is inversely proportional to the number of channels being used to generate a signal: The lower the spread factor the greater the number of channels being used to generate the signal. A lower spread factor, while using up bandwidth can accommodate a large amount of data, resulting in a higher data rate.

Lower spread factors are usually reserved for data transmission while higher spread factors are used for voice transmission.

Screens on which this field is present

CODE DOM (Code Domain Analyzer, IS-2000)

Start Frame

See [“Data Source” on page 157](#).

Threshold

For Code Domain measurements. Enter the measurement display threshold for making code domain measurements. Walsh channels that have power levels below the threshold value are not displayed as active channels.

Operating Considerations

Querying Phase and Timing measurements for Walsh channels that are below the threshold level using GPIB will return a default value of 9e99.

Screens on which this field is present

CODE DOM (Code Domain Analyzer): auxiliary controls menu

Time

For IS-95 Code Domain measurements only. This field displays the results of the code domain timing measurement. This field is displayed on the CODE DOM screen menu when the **Measurement** field is set to **Timing**.

For more information about the code domain timing measurement see “[Code Domain Timing \(Timing\)](#)” on page 141.

Screens on which this field is present

CODE DOM (Code Domain Analyzer, IS-95 only).

Time/div

For IS-95 Code Domain measurements only. This field sets the display resolution for the code domain timing measurement: 1, 2, 5, 10, 20, or 50 nanoseconds (ns). This field is displayed on the CODE DOM screen's **Marker** menu when the **Measurement** field is set to **Timing**.

Screens on which this field is present

CODE DOM (Code Domain Analyzer, IS-95 only): marker controls menu

Time Offset

This field allows you to manually enter a time offset. To obtain a value to enter in this field you must make at least one of the following measurements.

- Power
- Timing
- Phase
- Rho

After making the measurement, access the **FP Setup** menu on the CODE DOM screen, and enter the value obtained from the **Time Ofs** field or, for rho measurements, the **Time Offset** measurement field on the CDMA ANALYZER screen.

An entry into the **Time Offset** field can also be made automatically, using the **Ofs Transfer** field. See [“Ofs Transfer” on page 164](#).

When measuring fast power, the code domain analyzer uses the value in the **Time Offset** field instead of re-measuring the time offset parameters each time a code domain measurement is made.

Screens on which this field is present

CODE DOM (Code Domain Analyzer, IS-95 only): FP setup controls menu

Time Ofs

This measurement field displays the time offset when a rho measurement is made. See [“Time Offset” on page 135](#) for more information about this measurement.

Screens on which this field is present

CODE DOM (Code Domain Analyzer).

Trig Event

This field determines when the trigger event to the analyzer occurs. When the selected trigger in this field is qualified by the selection in the **Qual Event** field, the analyzer is triggered.

Choices

- 27 ms is an internally generated clock.
- 20 ms is an internally generated clock.
- 80 ms is an internally generated clock.
- 2 s is an internally generated clock.
- **Delay** controls a trigger delay timer, beginning from the positive edge of the selected qualifier. A delay of 20 μ s to 10 s is valid. Initially, the time delay will be 100 μ s.
- **Immed** triggers immediately after receiving the **Qual Event** signal.

Default selection: **Immed**.

Screens on which this field is present

CDMA ANALYZER

COD DOM (Code Domain Analyzer): trigger controls menu

Tune Freq

Use this field to enter the center frequency of the CDMA channel you are analyzing. This field is displayed only when the **RF Display** field on the INSTRUMENT CONFIGURE screen is set to **Freq**.

NOTE

Channel tuning

You can configure the Test Set to allow direct entry of channel numbers (instead of entering the frequency) by using the **RF Display** field on the INSTRUMENT CONFIGURE screen. See [“RF Channel” on page 170](#) for more information.

Screens on which this field is present

CDMA ANALYZER

COD DOM (Code Domain Analyzer): main controls menu

Walsh Chan

This field selects the Walsh channel to which to move the marker (IS-95 only mode). The marker can be moved by either entering the Walsh channel number using the keypad, or by using the cursor-control knob.

Screens on which this field is present

COD DOM (Code Domain Analyzer, IS-95 only): marker controls menu

Walsh Order

This selectable IS-2000 Code Domain display field shows the Walsh order of the currently selected channel. The Walsh order represents the number of bits used to specify a selected channel (which also determines channel size). Walsh order 7 (the highest order), will generate a set of 128 distinct values, or channels of size 1. Walsh order 3, comprised of code values of 3 bits each, will generate 8 distinct values of channel size 16. The Walsh order (or channel size) indicates how many channels are used to generate the signal. The lower the Walsh order, the larger number of channels are used to generate the signal. A lower Walsh order, while using up bandwidth, can accommodate a larger amount of data, resulting in a higher data rate.

Lower Walsh orders are usually reserved for data transmission, while higher Walsh orders are used for voice transmissions.

Screens on which this field is present

CODE DOM (Code Domain Analyzer, IS-2000 only): Complex Power measurement.

6

**Analog Measurements - Screens
and Control Fields**

- “AC Control” on page 179
- “AM Depth Measurement” on page 179
- “AF Freq Measurement” on page 180
- “DC Level Measurement” on page 180
- “Distn (Distortion) Measurement” on page 181
- “Frequency Measurement” on page 182
- “Frequency Error Measurement” on page 182
- “TX Power Measurement” on page 183
- “FM Deviation Measurement” on page 183
- “AF Freq Measurement” on page 180
- “SINAD Measurement” on page 184
- “SNR Measurement” on page 184
- “Control Fields for Analog Measurements” on page 185

Analog Measurements

AC Control

The type of measurement shown is dependent on the **AF Anl In** settings. **AC Level** is displayed when the **AF Anl In** field is set to **SSB Demod**, **Audio In**, **Ext Mod**, or **Audio Out**.

The **AC Level** measurement field displays either rms potential (voltage) or audio power (Watts or dBm).

See “[Displaying AF Measurements](#)” on page 57, or “[AF Anl In](#)” on page 185 for more information.

Screens on which this field is displayed

AF ANALYZER
RF ANALYZER
RF GENERATOR

AM Depth Measurement

This measurement field displays the percent depth of modulation of the AM signal. This measurement is displayed when the **AF Anl In** field is set to **AM MOD** or **AM DEMOD**.

See “[Displaying AF Measurements](#)” on page 57, or “[AF Anl In](#)” on page 185 for more information.

Screens on which this field is displayed

AF ANALYZER
RF ANALYZER
RF GENERATOR

AF Freq Measurement

The AF frequency measurement is the audio frequency of the signal present at the input selected in the **AF An1 In** field (on the AF ANALYZER screen). Four dashes (- - - -) indicate that no audio frequency is present to measure.

See “SINAD, Distortion, SNR, AF Frequency, DC Level,” on page 57 for more information. See also “AF An1 In” on page 185.

Screens on which this measurement is displayed

AF ANALYZER
RF GENERATOR
RF ANALYZER

DC Level Measurement

This measurement field displays the dc voltage entering at the source set in the **AF An1 In** field (on the AF ANALYZER screen).

See “SINAD, Distortion, SNR, AF Frequency, DC Level,” on page 57 for more information. See also “AF An1 In” on page 185.

Operating Considerations

When the **AF An1 In** field is set to **FM Demod** or **AM Demod**, the unit-of-measure is kHz (for FM Demod) or % (for AM Demod). For these two settings this measurement indicates the dc modulation component of the received signal.

Screens on which this field is displayed

AF ANALYZER
RF GENERATOR
RF ANALYZER

Distn (Distortion) Measurement

This measurement field displays the percent of distortion for an audio signal tone.

See “[SINAD, Distortion, SNR, AF Frequency, DC Level,](#)” on page 57 for more information.

Operating Considerations

Set the **Notch Freq** field (on the AF ANALYZER screen) to match the AF frequency used for your distortion measurement.

Screens on which this field is displayed

AF ANALZYER
RF ANALYZER
RF GENERATOR

FM Deviation Measurement

This measurement field displays the deviation of FM signals. This measurement is displayed when the **AF An1 In** field (on the AF ANALYZER screen) is set to **FM Demod** or **FM Mod**.

See “[Displaying AF Measurements](#)” on page 57 for more information.

Screens on which this field is displayed

AF ANALZYER
RF ANALYZER
RF GENERATOR

Frequency Measurement

This measurement field displays the center frequency the signal being measured.

Operating Considerations

This measurement cannot be used for measuring CDMA signals; use the CDMA analyzer.

Screens on which this field is displayed

AF ANALZYER
RF ANALYZER
RF GENERATOR

Frequency Error Measurement

This measurement field displays the difference between the Test Set's RF channel or tune frequency setting set and measured signal's frequency.

You can display the frequency error in ppm by pressing the **ppm W** key.

Operating Considerations

This measurement cannot be used for measuring CDMA signals; use the CDMA analyzer.

Screens on which this field is displayed

AF ANALZYER
RF ANALYZER
RF GENERATOR

TX Power Measurement

Transmitter power measures RF power at the RF IN/OUT port.

Operating Considerations

Only the RF IN/OUT port can be used for measuring TX power. When the **Input Port** is set to **Ant**, four dashes (- - -) appear in place of digits for this measurement.

Use the spectrum analyzer to measure low-level RF power (≤ 60 mW) at the ANT IN port.

See [“Input Port” on page 201](#) or [“TX Pwr Zero” on page 221](#) for more information.

CAUTION

Connecting a signal of >60 mW to the ANT IN port can cause instrument damage (although internal protection circuits can typically withstand a short-duration signal of several Watts). If the overpower circuit is triggered (signified by a warning message at the top of the screen), remove the signal from the ANT IN port, and reset using **Meas Reset** (press and release the **Shift** key, then the **Hold** key) or turn the Test Set off and on to reset it.

Screens on which this field is displayed

AF ANALYZER
RF ANALYZER
RF GENERATOR

FM Deviation Measurement

This is the default setting for this measurement field. The FM deviation measurement is the frequency deviation of the carrier. This measurement field is only displayed when the **AF An1 In** field (on the AF ANALYZER screen) is set to **FM Demod** or **FM Mod**.

See [“Displaying AF Measurements” on page 57](#) for more information.
See also [“AF An1 In” on page 185](#).

Screens on which this field is displayed

AF ANALYZER
RF ANALYZER
RF GENERATOR

SINAD Measurement

SINAD is the measure of the ratio of the signal+noise+distortion to the noise+distortion produced at the output of a receiver that is the result of a modulated signal input. This ratio is expressed in dB.

See “SINAD, Distortion, SNR, AF Frequency, DC Level,” on page 57 for more information.

Screens on which this field is displayed

AF ANALYZER
RF GENERATOR
RF ANALYZER

SNR Measurement

The is signal to noise ratio of the audio input signal.

See “SINAD, Distortion, SNR, AF Frequency, DC Level,” on page 57 for more information.

Operating Considerations

- Selecting **SNR** turns off any other audio measurements.
- The RF generator and audio frequency generator 1 (**AFGen1**) must be set up to provide the radio's carrier. (**AFGen1** is automatically turned on and off repeatedly during this measurement.)
- The **AFGen2 To** field on the RF GENERATOR screen must be set to **Off**.
- The audio output of the radio's receiver must be connected to the AUDIO IN port (set the **AF An1 In** field on the AF ANALYZER screen to **Audio In**).

Screens on which this measurement is displayed

AF ANALYZER
RF GENERATOR
RF ANALYZER

Control Fields for Analog Measurements

#Pts

This field sets the number of points to define or edit on the spectrum analyzer's mask. You can define up to 15 points on the mask.

See [“Using the Spectrum Analyzer Mask” on page 115](#) for more information about the spectrum analyzer mask.

Operating Considerations

The starting point of the mask is always the left graticule on the display, and the end point is always the right graticule on the display.

To define a straight-line mask, set the number of points to 1. The default mask is a straight line at the top of the display.

Screens on which this field is displayed

SPEC ANL: mask controls menu

AF Anl In

The audio frequency analyzer input selects the input for the analyzer. When selected, this field displays a list of choices.

Signals can be analyzed from three different types of inputs:

- The output of the AM, FM, or SSB demodulators.
- The AUDIO IN, ANALOG MODULATION IN, and AUDIO OUT connectors.
- The signal present at the AM or FM modulators for the RF generator.

Operating Considerations

Changing this field changes the audio measurement (in the upper-right of the screen) to correspond to the selected signal.

See [“Selecting the Oscilloscope's Input” on page 120](#) for more information.

Screens on which this field is displayed

AF ANALYZER
SIGNALING DECODER (All Modes)

AF Cnt Gate

Audio frequency counter gate specifies how long the AF counter samples the signal before displaying the frequency. Specifying a shorter gate time may enable you to see frequency fluctuations that might not be seen using a longer gate time.

Screens on which this field is displayed

AF ANALYZER

AFGen1 Freq

This field sets the frequency for the first audio frequency sinewave generator.

Screens on which this field is displayed

RF GENERATOR

AFGen1 To

This field has two subfields:

- The upper field sets the destination port for audio frequency generator 1
 - **FM** -RF generator FM modulator
 - **AM** -RF generator AM modulator
 - **Audio Out** -AUDIO OUT connector
- The lower field
 - sets FM modulation deviation if the upper field set to **FM**
 - sets AM modulation depth if the upper field set to **AM**
 - sets the amplitude of audio signal (volts RMS) at the AUDIO OUT connector if upper field is set to **Audio Out**
 - turns off the AF generator if the **Yes On/Off** key is pressed.

Operating Considerations

Simultaneous FM and AM, using both AF generators is not allowed.

AF generators 1 and 2 are automatically turned off any time the CDMA screens are displayed. This prevents accidental amplitude or frequency modulation of the CDMA carrier. The AF generators are turned back on when you exit the CDMA screens (if they were previously turned on).

Screens on which this field is displayed

RF GENERATOR

AFGen2 Freq

This field sets the frequency for the second audio frequency sinewave generator.

Screens on which this field is displayed

RF GENERATOR

AFGen2 To

This field has two subfields:

- The upper field sets the destination port for audio frequency generator 2
 - **FM** -RF generator FM modulator
 - **AM** -RF generator AM modulator
 - **Audio Out** -AUDIO OUT connector
- The lower field
 - sets FM modulation deviation if the upper field set to **FM**
 - sets AM modulation depth if the upper field set to **AM**
 - sets the amplitude of audio signal (volts RMS) at the AUDIO OUT connector if upper field is set to **Audio Out**
 - turns off the AF generator if the **Yes On/Off** key is pressed.

Operating Considerations

Simultaneous FM and AM, using both AF generators is not allowed.

AF generators 1 and 2 are automatically turned off any time the CDMA screens are displayed. This prevents accidental amplitude or frequency modulation of the CDMA carrier. The AF generators are turned back on when you exit the CDMA screens (if they were previously turned on).

Screens on which this field is displayed

RF GENERATOR
SIGNALING ENCODER (All Modes)

Amplitude

This field adjusts the amplitude of the RF generator.

See for Atten Hold (below) for more information.

Screens on which this field is displayed

RF GENERATOR

SPEC ANL: RF generator controls menu

Atten Hold

Attenuator hold prevents the fixed RF output attenuators from switching in and out, eliminating the loss of the output signal as the level is changed. This function is helpful when making squelch measurements.

Operating Considerations

When this function is set to **On**, the RF output level is restricted to a range around the present **Amplitude** setting. This range varies with the amplitude setting. Attempting to set an amplitude outside the allowed range results in an error message and beep (if the beeper is on). RF output level accuracy is greatly degraded outside the allowed range.

Screens on which this field is displayed

RF GENERATOR

Audio In Lo

This field sets the AUDIO IN LO connector's state.

- **Gnd** causes the center pin of the connector to be connected directly to chassis ground.
- **Float** isolates the center pin of the connector from ground, providing a floating input to the AF analyzer.
- **600 To Hi** establishes a 600-ohm impedance between the center pins of the AUDIO IN LO and AUDIO IN HI connectors. Also, the **Ext Load R** field is removed, since the load is now fixed to 600 ohms.

Screens on which this field is displayed

AF ANALYZER

Audio Out

Audio output coupling selects ac or dc coupling of the AF generator to the AUDIO OUT connector.

Screens on which this field is displayed

RF GENERATOR

Auto/Norm

This field specifies how the trigger level is set.

- **Auto** automatically triggers if a triggering signal is not detected within approximately 50 ms of the last trigger.
- **Norm** requires a specific triggering signal before triggering.

Operating Considerations

Automatic triggering should be used for signals >20 Hz. Normal triggering should be used for signals ≤ 20 Hz.

Also, when measuring ≤ 1 Hz signals, you should set the **Scope To** field in the AF ANALYZER screen to **Input** to provide dc coupling to the oscilloscope's input.

Screens on which this field is displayed

SCOPE: trigger controls menu

Auto Zero

This field is displayed for average power measurements.

Auto is used to automatically zero the TX power measurement periodically during operation.

Manual is used to override the **Auto** feature. When **Manual** is selected, you must manually zero the TX power measurement by selecting the **TX Pwr Zero** field.

Screens on which this field is present

RF ANALYZER

BW=

This field displays the spectrum analyzer's resolution bandwidth. The resolution bandwidth and sweep rate are determined by the span setting, and cannot be set independently. See [“Setting Resolution Bandwidth and Sweep Rate” on page 111](#) for more information.

Screens on which this field is displayed

SPEC ANL: all menus except mask controls

Center Freq

This field sets the tune frequency for the center of the spectrum analyzer's screen. The center frequency field is displayed when the **RF Display** field on the INSTRUMENT CONFIGURE screen is set to **Freq**.

Operating Considerations

This field also changes the center frequency of the tracking generator and the RF analyzer.

Screens on which this field is displayed

SPEC ANL: main controls menu

Controls

The spectrum analyzer and oscilloscope settings are arranged in several menus that are accessed using the **Controls** field. A list of menu options is displayed when the controls field is selected.

See the descriptions for the individual control fields on each menu for more information.

Screens on which this field is displayed

SPEC ANL
SCOPE

Cont/Single

This field specifies whether the oscilloscope is continuously triggered (**Cont**), or if it is only triggered each time **Reset** is selected (**Single**).

Screens on which this field is displayed

SCOPE: trigger controls menu

DC FM Zero

See [“FM Coupling” on page 196](#)

De-Emp Gain

De-emphasis gain displays and selects the desired AF analyzer de-emphasis amplifier gain.

See [“Gain Cntl” on page 199](#) for more information.

Screens on which this field is displayed

AF ANALYZER

De-Emphasis

This setting selects or bypasses the 750 μ s de-emphasis networks in the audio analyzer and internal speaker circuitry.

Screens on which this field is displayed

AF ANALYZER

Detector

This setting selects the type of detector used when measuring and displaying AF signal levels.

Detector Types

- **RMS** displays the root mean square (rms) value of signals.
- **RMS*SQRT2** displays the rms value of a signal multiplied by the square root of 2.
- **Pk+** displays the positive peak value.
- **Pk -** displays the negative peak value.
- **Pk±/2** adds the positive and negative peak values, and divides the sum by 2.
- **Pk± Max** compares the positive and negative peaks and displays the greater value (polarity is not indicated).
- **Pk+ Hold** displays and holds the positive peak value until the measurement is reset. To reset, use **Meas Reset** (press and release the **Shift** key, then the **Hold** key), select a different detector, or re-select the same detector.
- **Pk - Hold** displays and holds the negative peak value until the measurement is reset. To reset, use **Meas Reset** (press and release the **Shift** key, then the **Hold** key), select a different detector, or re-select the same detector.
- **Pk±/2 Hold** divides the sum of the positive and negative peak values by 2, and displays the value until the measurement is reset. To reset, use **Meas Reset** (press and release the **Shift** key, then the **Hold** key), select a different detector, or re-select the same detector.
- **Pk± Mx Hold** compares the positive and negative peaks and displays the greater value until the measurement is reset. To reset, use **Meas Reset** (press and release the **Shift** key, then the **Hold** key), select a different detector, or re-select the same detector.

Screens on which this field is displayed

AF ANALYZER

Display

This field selects which limits to display on the spectrum analyzer's mask: Upper, Lower, Both, or Off.

Screens on which this field is displayed

SPEC ANL: mask controls menu

Edit Mask

This field selects which limits to set or edit on the spectrum analyzer's mask: Upper or Lower.

To change the mask use the `EditPt` and `#Pts` fields.

See [“Using the Spectrum Analyzer Mask” on page 115](#) for more information about the spectrum analyzer mask.

Screens on which this field is displayed

SPEC ANL: mask controls menu

EditPt

This field selects which point to define or edit on the spectrum analyzer's mask

See [“Using the Spectrum Analyzer Mask” on page 115](#) for more information about the spectrum analyzer mask.

Screens on which this field is displayed

SPEC ANL: mask controls menu

Ext Load R

External load resistance is used to calculate and display AF power. Power is calculated using the voltage measured at the AUDIO IN connections and the resistance value you enter into this field.

This field is displayed only when the **Audio In** field on the AF ANALYZER screen is set to **GND** or **Float**.

Operating Considerations

To display audio power, set the **AC Level** measurement's unit of measure to **W** (watts).

Screens on which this field is displayed

AF ANALYZER

Ext (TTL)

See ["Internal" on page 201](#)

Filter 1

This field selects an audio frequency filter which can be used to condition the audio signal before it is analyzed by the audio frequency analyzer.

The following filter choices are available:

- <20 Hz HPF
- 50 Hz HPF
- 300Hz HPF
- C MESSAGE

Operating Considerations

The audio from the Test Set's speaker is not affected by Filter 1 or Filter 2 settings.

Screens on which this field is displayed

AF ANALYZER

Filter 2

This field selects an audio frequency filter which can be used to condition the audio signal before it is analyzed by the audio frequency analyzer.

The following filter choices are available:

- 300Hz LPF
- 3kHz LPF
- 15kHz LPF
- > 99kHz LP
- 6 kHz BPF

Operating Considerations

The audio from the Test Set's speaker is not affected by Filter 1 or Filter 2 settings.

Screens on which this field is displayed

AF ANALYZER

FM Coupling

This field alters the FM modulator to allow DCFM from internal and external modulation sources. The upper subfield selects ac or dc coupling between the RF generator's frequency modulator and the ANALOG MODULATION IN connector. The lower subfield, **DC FM Zero**, zeroes any dc bias that exists when **FM Coupling** is set to **DC**.

Operating Considerations

This field should be set to **DC** whenever the **AFGen2 To** field is set to **FM**; this provides better modulation response at low data rates.

Screens on which this field is displayed

RF GENERATOR

Freq (Delta Mrkr)

Marker frequency (**Delta Mrkr Freq**) displays the difference between the frequency at delta marker and the frequency at the reference marker on the spectrum analyzer. This measurement is displayed when the **Norm/Delta** field on the **Marker** controls menu is set to **Delta**.

See “Using the Spectrum Analyzer’s Delta Markers” on page 113 for more information on the spectrum analyzer’s delta marker.

Screens on which this field is displayed

SPEC ANL: all menus (when marker controls is set to **Delta**) except mask controls

Figure 6-1

Delta and Reference Marker Frequency (Freq) and Level (Lvl) Display Fields

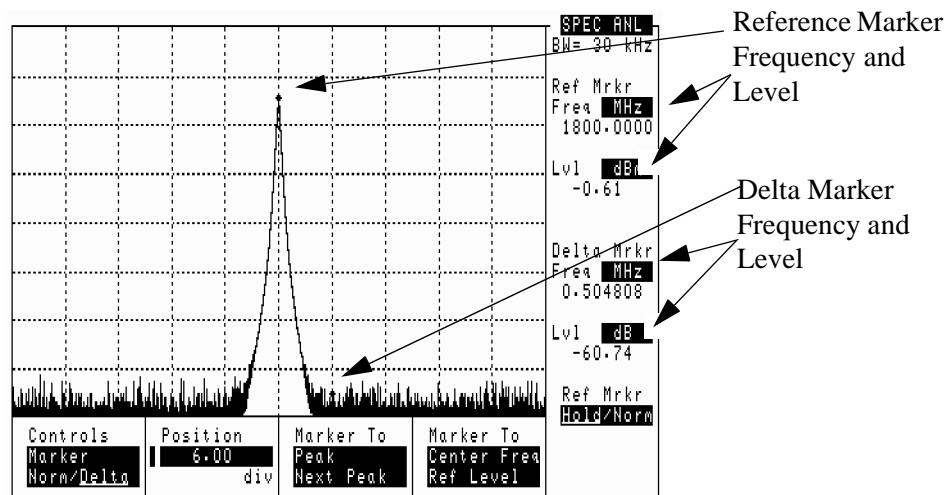

Freq (mask)

This field sets the frequency of the point on the spectrum analyzer mask selected in the **EditPt** field.

See “Using the Spectrum Analyzer Mask” on page 115 for more information about the spectrum analyzer mask.

Screens on which this field is displayed

SPEC ANL: mask controls menu

Freq (normal marker)

Marker frequency (**Marker Freq**) displays the frequency at the marker's present position on the spectrum analyzer when the **Norm/Delta** field on the **Marker** controls menu is set to **Norm**.

See [“Using the Spectrum Analyzer’s Delta Markers”](#) on page 113 for more information about using the spectrum analyzer’s markers.

Operating Considerations

When switching from delta mode to normal mode, the delta marker becomes the normal marker.

Screens on which this field is displayed

SPEC ANL: all menus (when in normal mode) except mask controls

Figure 6-2

Normal Marker Frequency (Freq) and Level (Lvl) Display Fields

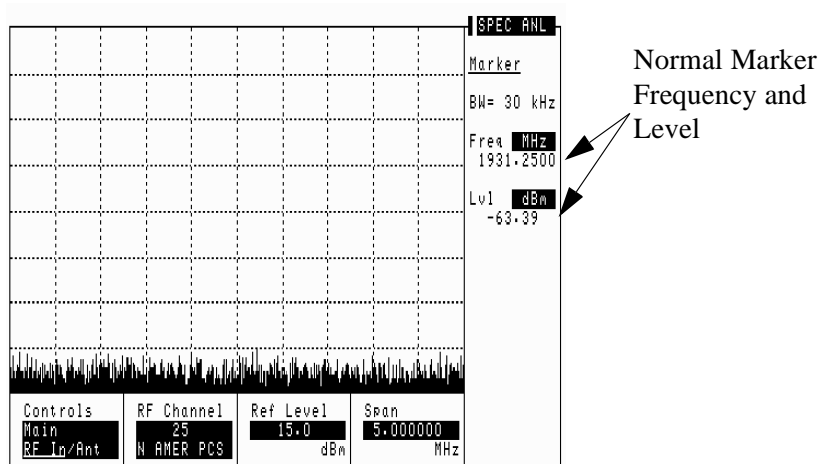

Freq (Ref Mrkr)

Marker frequency (**Ref Mrkr Freq**) displays the frequency at the reference marker's present position on the spectrum analyzer. This marker is displayed when the **Norm/Delta** field on the **Marker** controls menu is set to **Delta**.

See [“Using the Spectrum Analyzer’s Delta Markers”](#) on page 113 for more information on the spectrum analyzer’s delta marker.

Screens on which this field is displayed

SPEC ANL: all menus (when marker controls is set to **Delta**) except mask controls

Gain Cntl

AF analyzer gain control specifies whether the AF analyzer's gain settings are controlled automatically by AF autoranging (**Auto**), or by manual control (**Hold**).

The following settings are affected by AF autoranging:

- Input Gain
- De-Emp Gain
- Notch Gain

Operating Considerations

The normal mode of operation for the **Gain Cntl** field is **Auto**, allowing the instrument to adjust the AF gain settings for optimum measurement accuracy.

This field can be set to **Hold** to disable the autoranging routines to increase measurement speed. However, this requires you to select the desired gain settings manually for each measurement.

Autoranging Interference After a signal is input, the RF autoranging function (**Auto**) takes a small amount of time to determine the required input attenuator setting. If your transmitter begins sending information the instant it transmits, the initial part of the demodulated signal may not appear on the oscilloscope. When trying to capture the initial modulation waveform of a signal on the oscilloscope, set the upper field to **Hold** and set the lower field to an appropriate level for the signal being decoded (start with 40 dB).

Setting the upper field to **Hold** also prevents the RF autoranging process from interrupting spectrum analyzer operation when a signal is first measured. This can be helpful when you need to see the signal the instant the source is input, but requires you to set the needed amount of input attenuation.

Screens on which this field is displayed

AF ANALYZER

IF Filter

This field selects the desired IF filter bandwidth for modulated signals being analyzed.

Screens on which this field is displayed

RF ANALYZER

Input Atten

Input attenuation sets the amount of input attenuation for the RF IN/OUT and ANT IN connectors. This function controls two settings:

- The upper field determines if you want the instrument to set the attenuation automatically (**Auto**), or if you want to set the value manually (**Hold**).
- The lower field displays the present attenuation value, and is used to set the desired attenuation level when the upper area is set to **Hold**.

Operating Considerations

Autoranging Interference After a signal is input, the RF autoranging function (**Auto**) takes a small amount of time to determine the required input attenuator setting. If your transmitter begins sending information the instant it transmits, the initial part of the demodulated signal may not appear on the oscilloscope. When trying to capture the initial modulation waveform of a signal on the oscilloscope, set the upper field to **Hold** and set the lower field to an appropriate level for the signal being decoded (start with 40 dB).

Setting the upper field to **Hold** also prevents the RF autoranging process from interrupting spectrum analyzer operation when a signal is first measured. This can be helpful when you need to see the signal the instant the source is input, but requires you to set the needed amount of input attenuation.

Screens on which this field is displayed

RF ANALYZER
SPEC ANL: auxiliary controls menu

Input Gain

This field displays and selects the gain of the AF analyzer's input amplifier. The choices are 0 dB, 20 dB, or 40 dB. Refer to the **Gain Cntl** field more information.

Screens on which this field is displayed

AF ANALZYER

Input Port

This field selects the RF IN/OUT or ANT IN port for making RF measurements. The RF IN/OUT port must be used for making TX power measurements.

Operating Considerations

If the RF power at the RF IN/OUT port exceeds allowable limits, a loud warning signal sounds and a message appears at the top of the screen. If this occurs, disconnect the RF power, reset using **Meas Reset** (press and release the **Shift** key, then the **Hold** key), and allow the Test Set to cool off for approximately two minutes before making any other measurements on this port.

The ANT IN (antenna input) connector provides a highly-sensitive input for very low level signals (such as “off the air” measurements). You cannot measure TX (RF) power on the RF ANALYZER screen using the ANT IN port.

CAUTION

Connecting a signal of >60 mW to the ANT IN port can cause instrument damage (although internal protection circuits can typically withstand a short-duration signal of several Watts).

If the overpower circuit is triggered (signified by a warning message at the top of the screen), remove the signal from the ANT IN port, and reset using **Meas Reset** (press and release the **Shift** key, then the **Hold** key) or turn the Test Set off and on.

Maximum signal levels at the RF IN/OUT, DUPLEX OUT, and ANT IN ports are printed on the connector panel. Exceeding these levels can cause permanent instrument damage.

Screens on which this field is displayed

SPEC ANL: RF IN/ANT main controls menu
RF ANALYZER

Internal

This field selects the trigger source.

- **Internal** uses the signal being displayed for triggering.
- **Ext (TTL)** uses the EXT SCOPE TRIGGER INPUT for triggering. This is a TTL level trigger (approximately 2.5 V).

Screens on which this field is displayed

SCOPE: trigger controls menu

Level (div)

This control is divided into two subfields:

The upper subfield (0.00) sets the *internal* trigger level as a function of vertical divisions. The trigger level is indicated by small pointers that appear on each side of the screen (only used for internal triggering).

The lower subfield (Pos/Neg) specifies whether triggering happens when the waveform being measured is positive-going (Pos), or negative-going (Neg).

Screens on which this field is displayed

SCOPE: trigger controls menu

Level (mask)

This field sets the level of the point on the spectrum analyzer mask selected in the **EDITPt** field.

See [“Using the Spectrum Analyzer Mask” on page 115](#) for more information about the spectrum analyzer mask.

Screens on which this field is displayed

SPEC ANL: mask controls menu

Lvl (Delta Mrkr)

Marker level (**Delta Mrkr Lvl**) displays the difference between the level at delta marker and the level at the reference marker on the spectrum analyzer. This marker is displayed when the **Norm/Delta** field on the **Marker** controls menu is set to **Delta**. See [Figure 6-1 on page 197](#).

See [“Using the Spectrum Analyzer’s Delta Markers” on page 113](#) for more information on the spectrum analyzer’s delta marker.

Screens on which this field is displayed

SPEC ANL: all menus (when marker controls is set to **Delta**) except mask controls

Lvl (marker)

This measurement field displays the signal level of the signal at the current marker position on the oscilloscope.

Operating Considerations

The unit-of-measure for this field is dependent on the source of the signal being measured. For instance, when measuring a signal from the AUDIO IN connector, the amplitude is measured in Volts. When looking at a signal from the FM demodulator, the amplitude is given in units of kHz.

When the `Vert Offset` field is $\neq 0.00$, the displayed marker level is referenced to the center line generated by the vertical offset feature, not the center line of the screen.

The `Ref Set` function can be used with this measurement to display levels relative to a specific value. (See [“Setting A Measurement Reference” on page 67.](#))

Screens on which this field is displayed

SCOPE: all control menus

Lvl (normal marker)

Marker frequency (`Marker Lvl`) displays the frequency at the marker's present position on the spectrum analyzer when the `Norm/Delta` field on the `Marker` controls menu is set to `Norm`. See [Figure 6-2 on page 198.](#)

See [“Using the Spectrum Analyzer's Delta Markers” on page 113](#) for more information about using the spectrum analyzer's markers.

Operating Considerations

When switching from delta mode to normal mode, the delta marker becomes the normal marker.

Screens on which this field is displayed

SPEC ANL: all menus except mask controls

Lvl (Ref Mrkr)

Marker level (**Ref Mrkr Lvl**) displays the level at the reference marker's present position on the spectrum analyzer. This marker is displayed when the **Norm/Delta** field on the **Marker** controls menu is set to **Delta**. See [Figure 6-1 on page 197](#).

See ["Using the Spectrum Analyzer's Delta Markers" on page 113](#) for more information on the spectrum analyzer's delta marker.

Screens on which this field is displayed

SPEC ANL: all menus (when marker controls is set to **Delta**) except mask controls

Marker To Peak+

Peak+ causes the marker to move to the maximum value of the *average* level measured on the display.

Because this functions look at the average value for each displayed pixel, the marker may not appear directly on the displayed peak of a noisy signal.

Screens on which this field is displayed

SCOPE: marker controls menu

Marker To Peak-

Peak - causes the marker to move to the minimum value of the *average* level measured on the display.

Because this functions look at the average value for each displayed pixel, the marker may not appear directly on the displayed peak of a noisy signal.

Screens on which this field is displayed

SCOPE: marker controls menu

Marker To

These two fields position the spectrum analyzer's marker as follows:

- **Peak** moves the marker to the highest peak and enters the location in the **Position** field.
- **Next Peak** moves the marker to the next peak to the right and enters the location in the **Position** field.
- **Center Freq** changes the center frequency value to match the current position of the marker.
- **Ref Level** changes the reference level setting to match the current position of the marker.

Screens on which this field is displayed

SPEC ANL: marker controls menu

Mask Beep

When the signal exceeds the limits set by the spectrum analyzer mask, the FAIL indicator is displayed along with an audible tone (beep). You can use this field to turn on (or off) the beep.

This field is displayed only when the spectrum analyzers mask is displayed (**Display** field on **Mask** controls menu set to **UpperOnly**, **LowerOnly**, or **Both**.)

Screens on which this field is displayed

SPEC ANL: mask controls menu

Mask Type

This field selects the type of spectrum analyzer mask.

- **Fix** sets the mask to absolute limits defined in the **#Pts**, **EditPoint**, **Lvl**, and **Freq** fields. When using fixed limits a change in the center frequency or level may cause the mask to move beyond the viewable area of the screen.
- **Rel** sets the mask relative to the center frequency and reference level defined in the **Center Freq** and **Ref Lvl** fields on the spectrum analyzer's **Main** controls menu. The mask remains displayed even though the center frequency or reference level are changed.

For more information, see [“Using the Spectrum Analyzer Mask” on page 115](#).

Screens on which this field is displayed

SPEC ANL: mask controls menu

Mod In To

This modulation input field defines how an external modulation source is used with the RF generator. Two fields are used:

- The upper field determines whether the ANALOG MODULATION IN signal is set for AM or FM modulation of the RF GENERATOR.
- The lower field sets the modulation sensitivity. For instance, if **FM (/Vpk)** is selected for the upper field, and you set the lower field to **1.0000 kHz**, the RF generator will deviate 1 kHz for every 1 Volt peak at the ANALOG MODULATION IN connector.

Screens on which this field is displayed

RF GENERATOR

No Pk/Avg

This field performs two functions:

Pk Hold (peak hold) prevents the spectrum analyzer from erasing the previous trace each time it sweeps. This causes the traces to 'build-up' on the screen until **Off**, **No Pk/Avg** or measurement reset (using **Meas Reset** (press and release the **Shift** key, then the **Hold** key) is performed. This allows the capture of transient signals that are not displayed long enough to view during normal operation.

Avg 1 through 100 (video averaging) enables the spectrum analyzer to display a trace representing the average of several measurements. The number of samples used for measurement averaging range from 1 to 100 (see below). **No Pk/Avg** and **Off** function identically. **Off** is provided to maintain backwards compatibility with earlier firmware and software.

- **No Pk/Avg** means that peak hold and video averaging are off.
- **Pk Hold** means that peak hold is on.
- **Avg [n]** enables video averaging over [n] measurements, where n = 1, 2, 3, 4, 5, 10, 20, 50, or 100
- **Off** means that peak hold and video averaging are off.

Operating Considerations

After capturing the desired signal, you can use the hold function (press **Hold** key) to prevent additional signals from building-up on the display.

Screens on which this field is displayed

SPEC ANL: auxiliary controls menu

Normalize

This area performs three display operations:

- **Save B** saves the currently displayed trace for the A-B operation.
- **A Only** provides a continuously updated display (the “normal” mode of operation).
- **A-B** displays the difference between the trace saved using **Save B** and the currently displayed trace. The comparison can yield either losses or gains in amplitude.

Operating Considerations

The A-B function works correctly only if the center frequency and span settings are the same for both signals.

The reference level (**Ref Level**) can be changed (on the **Main** controls menu) to move the trace below the top line of the display if the A-B function results in a gain.

The **Hold** key can be used to “freeze” the display at any time. This allows you to view a trace before performing the **Save B** or **A-B** functions.

Screens on which this field is displayed

SPEC ANL: auxiliary controls menu

Norm/Delta

This field selects which marker will be controlled by the marker positioning fields on the spectrum analyzer’s **Marker** menu.

See [“Using the Spectrum Analyzer’s Delta Markers”](#) on page 113.

Screens on which this field is displayed

SPEC ANL: marker controls menu

Notch Freq

This field sets the center frequency for the variable frequency notch filter. It is typically used for distortion and SINAD measurements at frequencies below or above the standard 1 kHz notch filter.

Operating Considerations

When the **Notch Coupl** field on the INSTRUMENT CONFIGURE screen is set to **AFGen1**, this filter and the **AFGen1 Freq** field match their settings. A warning message is then displayed if you attempt to set the **AFGen1 Freq** value outside the 300 Hz to 10 kHz range of this filter. When the **Notch Coupl** field is set to **None**, this filter and **AFGen1 Freq** operate independently.

Screens on which this field is displayed

AF ANALYZER

Notch Gain

This field displays and selects the gain of the AF analyzer's notch filter amplifier. This amplifier is only used for making SINAD and distortion measurements. (See "Gain Cntl" on page 199 for more information.)

Screens on which this field is displayed

AF ANALYZER

Offset Freq

Frequency offset (RF generator) sets the difference between the instantaneous frequencies of the tracking generator and the center frequency of the spectrum analyzer.

This field is displayed only when **Track** is selected in the **Track/Fixed** field on the **RF Gen** controls menu.

Operating Considerations

The offset can be a positive or negative value. When set to zero, the tracking generator produces a sweeping signal that matches the spectrum analyzer's tune frequency.

Screens on which this field is displayed

SPEC ANL: RF generator controls menu

Output Port

This field selects the RF generator's output port. Higher RF generator levels are available at the DUPLEX OUT port than at the RF IN/OUT port.

Operating Considerations

CAUTION

Applying reverse RF power to the DUPLEX OUT connector can damage the instrument. (A message is displayed when an overpower conditions occurs.) Whenever possible, use the RF IN/OUT connector when testing transceivers to prevent damage from accidental transmitter keying.

If a reverse-power condition triggers the internal protection circuit, remove the reverse-power signal and reset using **Meas Reset** (press and release the **Shift** key, then the **Hold** key) or turn the Test Set off and on to reset it.

Maximum signal levels at the RF IN/OUT, DUPLEX OUT, and ANT IN ports are printed on the connector panel. Exceeding these levels can cause permanent instrument damage.

Screens on which this field is displayed

RF GENERATOR
SPEC ANL: (**Fixed**) RF generator controls menu

Pk Det To

This field selects the signal source for the peak detectors. This allows you to bypass certain sections of the AF analyzer's circuitry when making ac-level measurements.

- **Filters** analyzes the signal after filtering through Filter 1.
- **De-Emp** analyzes the signal after filtering through Filter 1 and Filter 2, and after de-emphasis.

Screens on which this field is displayed

AF ANALYZER

Port/Sweep

This control performs two functions:

- The upper field specifies the output port of the tracking generator.
- The lower field specifies whether the tracking generator sweeps from low-to-high frequencies (**Norm**), or from high-to-low frequencies (**Invert**). (The spectrum analyzer always sweeps from low to high frequencies.) The swept frequency range is determined by the **Span** setting in the spectrum analyzer's main controls menu.

This field is displayed only when **Track** is selected in the **Track/Fixed** field on the spectrum analyzer's **RF Gen** controls menu.

Operating Considerations

When using the tracking generator, if the output port is set to **RF Out**, or the main menu **Input Port** is set to **RF In**, internal instrument coupling can occur. For the best isolation between the tracking generator and the spectrum analyzer, use **Dup1** for the output, and **Ant** for the input.

For measurements on high-power devices, such as amplifiers, use the **RF IN/OUT** port for the input.

Screens on which this field is displayed

SPEC ANL: RF generator controls menu

Position

This field indicates the number of scale divisions from the left side of the screen to the marker.

Use the **DATA ENTRY** keys or cursor-control knob to move the marker to any point on the displayed signal.

Screens on which this field is displayed

SCOPE: marker controls menu

SPEC ANL: marker controls menu

Pos/Neg

See “Level (div)” on page 202

Ref Level

Reference level sets the amplitude reference level for the top line of the display. All signals displayed are referenced to this line.

Operating Considerations

The unit-of-measure for the reference can be changed as needed. For instance, 0 dBm, 0.224 V, 107.0 dBmV, and 0.00100 W can all be used to represent the same level.

Screens on which this field is displayed

SPEC ANL: main controls menu

Ref Mrkr

In the delta marker mode, a second (reference) marker is placed at the current location of the marker. The first marker becomes a moveable delta marker. When the delta marker is moved, the difference in frequency and level between the reference marker and the delta marker are shown as the **Delta Mrkr** measurements on the right-hand side of the screen. The reference marker can be set to either **Hold** or **Norm**.

When the **Ref Mrkr** field is set to **Hold**, the reference marker is frozen at its current position (frequency and level) regardless of changes in the signal level.

When you switch from **Hold** to **Norm**, the reference marker will stay at its current horizontal setting (frequency), but will track the level of the incoming signal.

When switching from delta mode to normal mode, the delta marker becomes the normal marker.

Screens on which this field is displayed

SPEC ANL: all menus except mask controls

Reset

Reset retriggers the measurement when **Single** triggering is selected. See “**Cont/Single**” on page 192.

Screens on which this field is displayed

SCOPE: trigger controls menu

RF Channel

The **RF Channel** field is displayed on the screens listed below when the **RF Display** field on the INSTRUMENT CONFIGURE screen is set to **Chan**.

This field displays the current channel number. Channel tuning eliminates the need to set transmit and receive frequencies directly into the Test Set. Once the radio’s RF channel standard is selected, you only have to enter the channel number to automatically set the **RF Generator** and **RF Analyzer** to the correct frequency.

Operating Considerations

To utilize the correct transmit and receive frequencies select the appropriate channel standard from the **RF Chan Std** field on the INSTRUMENT CONFIGURE screen.

The lower subfield of the **RF Channel** field on the spectrum analyzer’s **RF Gen** controls menu also sets the RF channel standard.

Screens on which this field is displayed

RF ANALYZER
SPEC ANL: RF generator or main controls menu

RF Cnt Gate

RF counter gate specifies how long the RF counter samples the signal before displaying the frequency. Specifying a shorter gate time may enable you to see frequency fluctuations that might not be seen using a longer gate time.

Screens on which this field is displayed

RF ANALYZER

RF Gen Freq

This field sets the RF generator's frequency.

This field is displayed on the screens listed below when the **RF Display** field on the INSTRUMENT CONFIGURE screen is set to **Freq**.

Screens on which this field is displayed

SPEC ANL: RF Gen controls menu
RF GENERATOR

RF In/Ant

This field selects the input port for the spectrum analyzer.

Operating Considerations

Maximum signal levels are printed on the connector panel.

CAUTION

Connecting a signal of >60 mW to the ANT IN port can cause instrument damage (although internal protection circuits can typically withstand a short-duration signal of several Watts).

If the overpower circuit is triggered (signified by a warning message at the top of the screen), remove the signal from the ANT IN port, and reset using **Meas Reset** (press and release the **Shift** key, then the **Hold** key) or turn the Test Set off and on to reset it.

Using the ANT IN port with the **sensitivity** field set to **High** can result in uncalibrated operation (a message appears on the screen when this happens). The purpose for the high sensitivity setting is to allow you to look and listen to very low level signals when absolute accuracy is not essential.

See "[Sensitivity \(spectrum analyzer\)](#)" on page 215 for more information.

Screens on which this field is displayed

SPEC ANL

Scope To

This field selects the signal source for the oscilloscope. This allows you to bypass certain sections of the AF analyzer's circuitry when viewing and measuring a signal. It also allows you to select measurement paths that include additional gain stages, improving the oscilloscope's resolution when measuring low-level signals.

- **Input** looks at the unfiltered signal directly from the input.
- **Filters** looks at the signal after filtering through Filter 1 and Filter 2.
- **De-Emp** looks at the signal after filtering through Filter 1 and Filter 2, and after 750 μ s de-emphasis (if the **De-emphasis** field is set to 750 μ s.)
- **Notch** looks at the signal after filtering through Filter 1 and Filter 2, after de-emphasis (if used), and after the notch filter.

Screens on which this field is displayed

AF ANALYZER

Sensitivity (RF analyzer)

RF analyzer sensitivity adds about 6 dB of sensitivity for the ANT IN port when **High** is selected and the **Input Atten** field is set to 0 dB.

Operating Considerations

Selecting **High** sensitivity may cause spectrum analyzer measurements to be uncalibrated when the ANT IN port is used (a message appears when this occurs).

High-level AM measurements may be distorted when high sensitivity is used with the ANT IN port.

Screens on which this field is displayed

RF ANALYZER

Sensitivity (spectrum analyzer)

This area performs two functions:

- The lower field selects the vertical resolution of the display. You can choose from 1 dB, 2 dB, or 10 dB per graticule.
- The upper field selects **Normal** or **High** sensitivity for the RF input. The **High** setting adds about 6 dB of sensitivity to the ANT IN port (when the **Input Atten** field is set to 0 dB) for looking at very low level signals. However, this setting can cause measurements to be uncalibrated (indicated by a message on the screen). **High** sensitivity can also cause high-level AM signals to be distorted.

Screens on which this field is displayed

SPEC ANL: auxiliary controls menu

Settling

This field selects the settling time for making AF measurements. Lower frequency signals require additional settling time (**Slow**). Higher frequency measurements require less settling time (**Fast**).

Operating Considerations

Use **slow** for ≤ 200 Hz signals. Use **Fast** for > 200 Hz signals.

If the signal being measured is a composite of different frequencies above and below 200 Hz, select the appropriate filtering to analyze the desired signal component.

Screens on which this field is displayed

AF ANALZYER

Span

Sets the span of frequencies to be displayed on the screen.

Operating Considerations

When the tracking generator is used, the span also defines the frequency sweep range.

Spans >1.5 MHz disable the AF analyzer when the analyzer's **AF An1 In** field is set to **FM Demod**, **AM Demod**, or **SSB Demod**. This disables all the AF analyzer's measurement and output functions. When the AF analyzer's **AF An1 In** field is set to any of the other available inputs, such as **Audio In** or **Ext Mod**, the speaker and SCOPE MONITOR OUTPUT are not affected when the spectrum analyzer's span is changed.

Screens on which this field is displayed

SPEC ANL: main controls menu

Speaker ALC

Speaker automatic level control enables/disables the ALC function for the instrument's internal speaker. When **On** is selected, the speaker volume is *independent* of the signal level being measured. When **Off** is selected, the speaker volume is *dependent* on the signal level being measured.

Screens on which this field is displayed

AF ANALYZER

Speaker Vol

Speaker Volume enables/disables the instrument's internal speaker. When **Pot** is selected, the Volume control knob operates normally. When **Off** is selected, the speaker is disconnected.

Screens on which this field is displayed

AF ANALYZER

Squelch

This setting determines the squelch operation when demodulating FM, AM, or SSB signals. Three settings are available:

- **Pot** uses the front-panel SQUELCH knob for squelch level adjustment.
- **Open** disables squelch operation.
- **Fixed** sets the squelch to a fixed level, disabling the front-panel SQUELCH knob control.

Operating Considerations

Most measurements are not displayed on the screen if the incoming signal falls below the squelch level (with the exception of **TX Power**). The measurements are replaced by four dashes (- - - -) to indicate they have been squelched.

Oscilloscope measurements are also disabled when the signal has been squelched.

Spectrum analyzer measurements are not affected by the squelch setting (although squelch still affects whether the demodulated signal can be heard while viewing the RF signal).

Trying to read a squelched measurement using GPIB will cause your program to halt until the squelch is either turned down, a measurement is made, or until a program time-out aborts the measurement.

Screens on which this field is displayed

RF ANALYZER

Time

This measurement displays the time elapsed from the trigger point to the current marker position.

The **Ref Set** function can be used with this measurement to display time relative to a specific position. (See “[Setting A Measurement Reference](#)” on page 67.)

Screens on which this field is displayed

SCOPE: all control menus

Time/div

This field selects the horizontal sweep time per division.

Operating Considerations

The time-per-division is selected from a list of choices.

Screens on which this field is displayed

SCOPE: main controls menu

Track/Fixed

When this field is set to **Track**, the tracking generator is enabled. The tracking generator performs a frequency sweep operation. The start and stop frequencies are determined by the Span setting (main controls menu). The tracking generator allows you to characterize devices (such as filter networks) over wide span of frequencies.

An RF offset can be set between the tracking generator and the center frequency of the spectrum analyzer. This allows you to look at a signal that is related to a source whose frequency is outside the displayed span.

Screens on which this field is displayed

SPEC ANL: RF generator controls menu

Trig-Delay

The trigger delay is used to specify the time relationship between the trigger and displayed signal.

- **Positive** values delay the measurement trigger by a specific period. The delayed trigger point is the left edge of the screen.
- **Negative** values perform a pre-trigger function, displaying a section of the waveform before the trigger point. The trigger point is indicated by small pointers that appear at the top and bottom of the screen.

Operating Considerations

Negative Value The maximum negative delay cannot exceed ten divisions of the current time-per-division setting. For example; if the **Time/Div** field is set to 1 ms, the maximum allowed negative delay is -10 ms. Larger negative numbers cause an **Excessive negative Trig-Delay will be truncated.** message.

Positive Values For **Time/Div** settings of 50 μ s/div and smaller, the maximum delay is 400 ms.

For **Time/Div** settings of 100 μ s/div and larger, the maximum delay is 3300 ms.

Resolution

For delays of 400 ms and less, the resolution is 6.4 ms. For delays greater than 400 ms, the resolution is 51.2 ms. All entries are rounded to the nearest multiple of 6.4 ms or 51.2 ms (depending on the delay value).

Screens on which this field is displayed

SCOPE: trigger controls menu

Tune Freq

This field is displayed when the **RF Display** field on the INSTRUMENT CONFIGURE screen is set to **Freq**.

RF analyzer tune frequency sets the center frequency for the RF signal to be analyzed.

Screens on which this field is displayed

RF ANALYZER

TX Pwr Meas

The transmitter power measurement field specifies how transmitter power measurements are made:

- **Peak** can be used to measure AM, FM, and un-modulated (CW) signals.
- **Sample** can be used to measure FM or CW signals with increased measurement speed. This method can only be used with signals having no amplitude modulation component.

Operating Considerations

If you change this field, zero the power measurement (using the **TX Pwr Zero** field) before measuring power.

Screens on which this field is displayed

RF ANALYZER

TX Pwr Zero

The transmitter power zero function establishes a 0.0000 W reference for measuring RF power at the RF IN/OUT port.

Operating Considerations

When power is applied to the RF IN/OUT connector, the temperature of the internal circuitry increases. This can cause changes in the TX power measurement when low power levels are measured immediately following high power measurements.

When alternately making high and low power measurements, always zero the power meter immediately before making the low power measurements; this provides the best measurement accuracy.

If the **Auto Zero** field is set to **Auto**, the TX power measurement is periodically zeroed (automatically). Manual calibration is only needed if **Auto Zero** is set to **Manual**, or if you are measuring highly variable signal levels (as mentioned above).

Screens on which this field is displayed

RF ANALYZER

Vert/div

Vertical sensitivity sets the vertical amplitude per division.

Operating Considerations

The value for this field is selected from a list of choices.

Depending on the AF analyzer's **AF An1 In** setting, the units for this field may be in Volts, kHz, or Percent (AM). For example; if the **AF An1 In** field is set to **FM Demod**, the amplitude is displayed in kHz/div.

Screens on which this field is displayed

SCOPE: main controls menu

Vert Offset

Vertical offset moves the displayed signal above or below the oscilloscope's fixed centerline.

Operating Considerations

A centerline is displayed for the signal when an offset is used.

When the vertical offset is $\neq 0.00$, the marker level is referenced to the center line generated by the vertical offset feature, not the center line of the screen.

Screens on which this field is displayed

SCOPE: main controls menu

7

Configuration - Screens and Control Fields

- “Configuring the Instrument” on page 225
 - “Setting the Date and Time” on page 225
 - “Changing the Beeper’s Volume” on page 225
 - “Turning Off User Messages” on page 225
- “Configuring for Printing A Screen” on page 226
- “Control Fields on the Configuration Screens” on page 227

Configuring the Instrument

Setting the Date and Time

The Test Set has a built-in clock that keeps track of the date and time. It is powered by an internal battery to keep it operating when the instrument is off.

To set the date and time

- Step 1.** Access the INSTRUMENT CONFIGURE screen.
- Step 2.** Select the **Date** field and use the DATA ENTRY keys to enter the date (MMDDYY -- October 31, 1997 = 103197).
- Step 3.** Select the **Time** field and use the DATA ENTRY keys to enter the time (HH.MM -- 2:13 pm = 14.13).

Changing the Beeper's Volume

The beeper alerts you to important operating and measurement conditions. It beeps any time a message is displayed at the top of the screen. These messages warn you of conditions such as exceeding the RF input level or trying to set a field to an unacceptable value. Therefore, it is recommended that you do not disable the beeper.

To change the beeper's volume

- Step 1.** Access the INSTRUMENT CONFIGURE screen.
- Step 2.** Select the **Beeper** field to display the volume choices.
- Step 3.** Select the desired choice.

Turning Off User Messages

To turn off user messages

- Step 1.** Access the INSTRUMENT CONFIGURE screen.
- Step 2.** Set the **Display User Mssgs** field to **No**.

To display user messages

- Step 1.** Access the INSTRUMENT CONFIGURE screen.
- Step 2.** Set the **Display User Mssgs** field to **Yes**.

Configuring for Printing A Screen

Printing a Screen

NOTE Throughout this manual, the terms “GPIB” and “HP-IB” are used interchangeably.

- Step 1.** Connect a printer to the appropriate connector (**SERIAL 9**, **PARALLEL 15**, **HP-IB**).
- Step 2.** Go to the **PRINTER CONFIGURE** screen set the **Printer Port:** field to the appropriate type of printer connection.

If **HP-IB** is selected, enter the GPIB address (**Printer Adrs**) of the printer.
- Step 3.** Select the type of printer you are using in the **Model** field. If your printer is not listed, configure your printer to emulate one that is listed. (Some printers that operate with Windows® only are not supported.)
- Step 4.** Enter a **Print Title** if desired. This text will appear at the top of your printout.
 - a.** Use the knob to select letters, numbers, or symbols from the list (up to 50 characters).
 - b.** Select **Done** from the list when you have finished the title.
- Step 5.** Display the screen you want to print and press **Print**.

To interrupt printing

- Step 1.** Go to the **PRINTER CONFIGURE** screen.
- Step 2.** Select the **Abort Print** field.

Control Fields on the Configuration Screens

Abort Print

Select this field to interrupt the printing job in progress.

Abort Print is not directly programmable over the GPIB.

Screen(s) Where Field is Present

PRINTER CONFIGURE

Antenna In

This field is used to indicate losses or gains between the ANT IN port and the device-under-test.

Enter a *positive* value to indicate a gain (such as an amplifier). The spectrum analyzer's marker level (**Lv1**) measurement is automatically reduced by that amount. The spectrum analyzer's **Ref Level** is automatically decreased by the same amount, so the trace position does not appear to change.

Enter a *negative* value to indicate a loss (such as cable loss). The spectrum analyzer marker's level (**Lv1**) measurement is automatically increased by that amount. The spectrum analyzer's **Ref Level** is automatically increased by the same amount, so the trace position does not appear to change.

This field is only used when the **RF Level Offset** field is set to **On**. See ["RF Level Offset" on page 246](#).

Screen(s) Where Field is Present

INSTRUMENT CONFIGURE

Base Freq (User Defined)

The base frequency field sets the RF generator reference for channel 0 (zero) when the **RF Chan Std** field is set to **USER-DEF**, and the **RF Display** field is set to **Chan**.

Channel frequencies are calculated using the following formula:

$$\text{Channel N} = \text{Base Frequency} + (\text{N})(\text{Channel Spacing})$$

The Base Frequency is calculated using the following formula:

$$\text{Base Frequency} = \text{Channel 1 Frequency} - \text{Channel Spacing}$$

For example, if your multi-channel radio's lowest *receive* channel frequency is 870.030 MHz and the system channel spacing is 30 kHz, you would enter **870 MHz** in this field. You would also use the **Chan Space** and **(Gen)-(An1)** fields to tell the Test Set where other transmit and receive channel frequencies are in relation to the base frequency, and whether or not the system is duplex.

For more information see the following related topics:

[“Chan Space \(User Defined\)” on page 229](#)

[“\(Gen\)-\(An1\)” on page 235](#)

[“RF Chan Std” on page 244](#)

[“RF Display” on page 245](#)

Operating Considerations

The value of this field is only used if the **RF Display** field is set to **Chan**, and the **RF Chan Std** field is set to **USER-DEF**.

Screen(s) Where Field is Present

INSTRUMENT CONFIGURE

Beeper

This field changes the audio beeper volume by selecting the desired level from a list of choices (Off, Quiet, Loud). The beeper always beeps when the instrument is turned on, regardless of this setting.

Operating Considerations

The beeper alerts you any time a message is displayed. Since a message may be removed from the screen before you notice it, it is better to leave the beeper on to alert you to errors during operation.

The beeper's volume setting is retained when the instrument is turned off.

Screen(s) Where Field is Present

INSTRUMENT CONFIGURE

Call

- **Originate** places a call using the dialing sequence entered in the **Number to Call** field. This field is inactive when the **Modem Mode** field is set to **Disable**.
- **Disconnect** causes the modem to disconnect from the call in progress. It also cancels any pending call origination **Retries**. This field is inactive when the **Modem Mode** field is set to **Disable**.

Screen(s) Where Field is Present

MODEM CONFIGURE

Chan Space (User Defined)

This field specifies the RF channel spacing when the **RF Display** field is set to **Chan**, and the **RF Chan Std** field is set to **USER-DEF**.

For example, entering **25 kHz** causes a 25 kHz spacing between each channel. If the receive frequency for channel 1 is 150.500 MHz, channel 2's receive frequency would be 150.525 MHz.

Operating Considerations

The value of this field is only used if the **RF Display** field is set to **Chan**, and the **RF Chan Std** field is set to **USER-DEF**.

For more information see the following related topics:

[“Base Freq \(User Defined\)” on page 228](#)

[“\(Gen\)-\(Anl\)” on page 235](#)

[“RF Chan Std” on page 244](#)

Screen(s) Where Field is Present

INSTRUMENT CONFIGURE

CDMA Std

This field allows you to specify the CDMA standard to be used in Code Domain measurements. Select **IS-95 only** to show Power, Timing and Phase using IS-95 protocol. Select **IS-2000** to show Power, Complex Power, Power & Noise and Fast Power Synchronize, using the IS-2000 protocol.

For more information on the results of this selection see:

[“Code Domain Measurements – IS-95” on page 139](#)

“Code Domain Measurements – IS-2000” on page 142

Screen(s) Where Field is Present

INSTRUMENT CONFIGURE

Command Escape Character

This field allows you enter a one-character, non-printable escape character to define your own escape command sequence.

The **Decimal Equivalent** of the escape character is displayed to the right of the entry. This character is sent to the modem automatically when the modem is configured (see “[Modem Configuration](#)” on page 238).

This setting is retained when the instrument is turned off.

Screen(s) Where Field is Present

MODEM CONFIGURE

Connection Time-out

This field sets the number of seconds to wait before aborting a connection attempt. This applies to both answer and originate activities. This information is sent to the modem automatically when the modem is configured (see “[Modem Configuration](#)” on page 238).

This setting is retained when the instrument is turned off.

Screen(s) Where Field is Present

MODEM CONFIGURE

Data Length

This field specifies the number of bits used for each word of serial data when using the serial port.

This setting is retained when the instrument is turned off.

Operating Considerations

When in remote mode (**Remote Mode** field is set to **On**), this field is inaccessible.

Screen(s) Where Field is Present

I/O CONFIGURE

Date

This field specifies the current date for the internal clock. The date can be read by a controller using GPIB and printed on test results.

The format is MMDDYY (Month Day Year), using two digits for each term. When entering months January through September (01-09), the leading zero is not displayed when entered. Example; May 5, 1993 is entered as 050593, but is displayed as 50593.

The internal clock still functions when the instrument is turned off.

Screen(s) Where Field is Present

INSTRUMENT CONFIGURE

Display User Messages

This field controls whether or not user messages and prompts are displayed at the top of the screen when a user action is required or an error occurs.

Screen(s) Where Field is Present

INSTRUMENT CONFIGURE

Duplex Out

This field is used to indicate losses or gains between the DUPLEX OUT port and the device-under-test.

- Enter a *positive* value to indicate a gain (such as an amplifier gain). The RF generator's level is automatically set that amount *below* what is indicated in the RF generator's **Amplitude** field. (Example; if this value is 10 dB, and the **Amplitude** field shows 0 dBm, the actual level out this port is -10 dBm.) The value at the output of the external amplifier should then be at the level indicated in the **Amplitude** field.
- Enter a *negative* value to indicate a loss (such as cable loss). The RF generator's level is automatically set that amount *above* what is indicated in the RF generator's **Amplitude** field to compensate. The value at the opposite end of the cable (loss) should then be at the level indicated in the **Amplitude** field; unless the resulting RF generator setting exceeds the maximum output level, then an error occurs: **Input value out of range**. In that case, reduce the **Amplitude** setting, or decrease the **Duplex Out** value.

This field is only used when the **RF Level Offset** field is set to **On**.

Screen(s) Where Field is Present

INSTRUMENT CONFIGURE

Ext Ref In

This field selects the reference frequency of the signal at the EXT REF IN connector. You can select 1, 2, 5, or 10 MHz; 1x, 2x, 4x, 8x, or 16x chip.

Operating Considerations

This signal is used as a reference for, and directly affects, these functions:

- RF Generator Frequency (including the Tracking Generator)

- RF Frequency Counter

- AF Frequency Counter

- RF Analyzer Tune Frequency

- Spectrum Analyzer Center Frequency

AF generators 1 and 2 are not affected by the external reference; they use their own reference.

See [“EXT REF IN” on page 287](#) for more information.

FF at End

This field is used to specify if you want the printer to make a form feed (blank page) at the end of printing.

Screen(s) Where Field is Present

PRINTER CONFIGURE

FF at Start

This field is used to specify if you want the printer to make a form feed (blank page) at the start of printing.

Screen(s) Where Field is Present

PRINTER CONFIGURE

Firmware

This field displays the current firmware revision for your Test Set. The revision number is automatically changed when updated firmware is installed.

Screen(s) Where Field is Present

INSTRUMENT CONFIGURE

Flow Control

The flow control field is used when sending or receiving serial data.

- **None** disables the Xon/Xoff function.
- **Xon/Xoff** lets the Test Set “talk/listen” to the transceiver to alter the rate of the data being sent.
- **Hardware** uses the serial port’s RTS and CTS lines to transfer data at high baud rates.

NOTE

Do not turn flow control on (set **Flow Cntl** to **Hardware** in the I/O CONFIGURE screen) for the serial port until you have a device attached to the port that can respond to the flow control communications.

Example: You have a printer attached to SERIAL PORT 9. Before you run any IBASIC software (for example, the RFTOOLS program), you must make sure that the printer is properly connected and that its power is turned on.

Operating Considerations

This setting is retained when the instrument is turned off.

Baud rates of 38400 and above must use **Hardware** flow control.

When in remote mode (**Remote Mode** field is set to **On**), this field is inaccessible.

Screen(s) Where Field is Present

I/O CONFIGURE

Frame Clock Output

This field selects the frame clock signal to send to the FRAME CLOCK OUT connector.

Screen(s) Where Field is Present

INSTRUMENT CONFIGURE

(Gen)-(Anl)

This field is used with the **RF Offset** field to specify the amount of frequency offset between the RF generator and RF analyzer.

This field is always displayed when the **RF Display** field is set to **Freq**.

See “[Setting an RF Generator/Analyzer Offset](#)” on page 69 for more information.

Screen(s) Where Field is Present

INSTRUMENT CONFIGURE

(Gen)-(Anl) (User Defined)

This field defines the receiver-transmitter frequency offset when using user-defined channel operation.

Use a *positive* value (such as 45 MHz) when the radio’s receive frequency is higher than the transmit frequency.

Use a *negative* value (such as –45 MHz) when the radio’s receive frequency is lower than the transmit frequency.

Operating Considerations

The value of this field is only used if the **RF Display** field is set to **Chan**, and the **RF Chan Std** field is set to **USER-DEF**.

For more information see the following related topics:

“[Chan Space \(User Defined\)](#)” on page 229

“[RF Chan Std](#)” on page 244

“[RF Display](#)” on page 245

Screen(s) Where Field is Present

INSTRUMENT CONFIGURE

GPIB Adrs

This field is used to display and change the GPIB address of the Test Set.

Operating Considerations

The address can be set from 0 to 30 by using the DATA keys, or by pushing and then turning the cursor-control knob.

This setting is retained when the instrument is turned off.

Screen(s) Where Field is Present

I/O CONFIGURE

Hold-off Delay

This field sets the number of seconds to wait before attempting an origination. This applies to the delay prior to attempting a dialback as well as the delay prior to retrying an origination as part of the retry sequence.

This setting is retained when the instrument is turned off.

Screen(s) Where Field is Present

MODEM CONFIGURE

IBASIC Echo

This field enables/disables screen and error message echoing from IBASIC.

This setting is retained when the instrument is turned off.

Screen(s) Where Field is Present

I/O CONFIGURE

Incoming Call Security

This field controls the usage of a password security challenge.

- **Off** - no password challenge on connection
- **On** - issues a password challenge on connection. The user must enter a password. The password must match the string entered in the **Password** field.

Operating Considerations

The password is case sensitive and may not contain a space.

This setting is retained when the instrument is turned off.

Screen(s) Where Field is Present

MODEM CONFIGURE

Inst Echo

This field enables/disables character and screen echoing when using an external ASCII RS-232 terminal or computer to enter or edit IBASIC programs.

This setting is retained when the instrument is turned off.

Screen(s) Where Field is Present

I/O CONFIGURE

Lines/Page

This field is used to specify how many lines are printed per page.

Screen(s) Where Field is Present

PRINTER CONFIGURE

Mode

This field sets the GPIB operating mode. **Talk&Lstn** is used for normal GPIB operation. **Control** is used to control external instruments using the Test Set.

This setting is retained when the instrument is turned off.

Screen(s) Where Field is Present

I/O CONFIGURE

Model

This field is used to specify the type of printer used. If your printer is not listed in the **Choices** menu when you select this field, configure your printer to emulate one of those that is listed. (Some printers that operate with Windows only are not supported.)

Screen(s) Where Field is Present

PRINTER CONFIGURE

Modem Configuration

This field is used to configure the modem. When **Send to Hardware** is selected, an automatically generated string is sent. This initial string includes the escape character and connection time-out information. After this initial string is sent to the modem, the strings entered in the **Modem Initialization/Configuration** field are sent.

Operating Considerations

Do not send configuration strings when a data session is in progress. This field is inactive when the **Modem Mode** field is set to **Disable**.

Screen(s) Where Field is Present

MODEM CONFIGURE

Modem Initialization/Configuration

This field is used to enter configuration strings for the modem. It is a three-line field. Each string has a maximum of 40 characters. Blank lines will be skipped.

This setting is retained when the instrument is turned off.

To send these strings to the modem, select **Send to Hardware** under the **Modem Configuration** field.

Operating Considerations

An initial string containing the decimal equivalent of the escape character and the value of the connection time-out is automatically generated and sent when **Send to Hardware** is selected. Then the strings entered in this field are sent.

The first line is blank by default, but can be used to make settings such as baud rate if your modem is not set to autobaud detection. The second and third line's default settings are common modem configuration strings, but they can be changed if they do not match your modem's requirements. (Refer to your modem's documentation for further information.)

Screen(s) Where Field is Present

MODEM CONFIGURE

Modem Mode

This field selects modem's response to a carrier detect signal.

- **Disable** turns off the modem mode.
- **Ignore** disregards or hangs-up any calls. The modem is not enabled to look for incoming calls.
- **Answer** establishes a data session in response to the carrier detect signal.
- **Dialback**, answers the call, then drops the call (disconnects), then originates a call to the number entered in the **Modem Number to Call** field.

This setting is retained when the instrument is turned off.

Screen(s) Where Field is Present

MODEM CONFIGURE

Notch Coupl

This field selects if the **Notch Freq** setting of the AF ANALYZER screen is coupled to the **AF Gen1 Freq** setting. When set to **None**, the notch filter and AF generator 1 do not interact. When set to **AFGen1** (coupled), the settings track each other unless the AF generator's frequency is set outside the 300 Hz to 10 kHz limits of the notch filter.

Screen(s) Where Field is Present

INSTRUMENT CONFIGURE

Number to Call

This field is used enter the dialing sequence to be used whenever the modem originates a call. The maximum number of characters is 36.

This setting is retained when the instrument is turned off.

Screen(s) Where Field is Present

MODEM CONFIGURE

Opt CDMA TB

This control is provided for future enhancements. It must be set to **Internal** until options are available.

Screen(s) Where Field is Present

INSTRUMENT CONFIGURE

Parity

This field specifies the serial communication parity setting when using the serial ports.

This setting is retained when the instrument is turned off.

Operating Considerations

When in remote mode (**Remote Mode** field is set to **On**), this field is inaccessible.

Screen(s) Where Field is Present

I/O CONFIGURE

Password

This field is used to enter the password needed to verify access for incoming calls when the **Incoming Call Security** field is set to **On**.

The maximum number of characters is 8 characters (no spaces are allowed).

Operating Considerations

When you select this field a list of characters is displayed. Select the characters for your password using the knob. Then select **Done** (from the top of the list) when you are finished.

The password is case sensitive.

Screen(s) Where Field is Present

MODEM CONFIGURE

Printer Adrs

This field is used to select the GPIB address of the printer. This field is displayed when the **Printer Port** field is set to **HP-IB**.

Screen(s) Where Field is Present

PRINTER CONFIGURE

Printer Port

This field is used to select the port to which your printer is connected (**SERIAL 9, PARALLEL 15, HP-IB**).

Screen(s) Where Field is Present

PRINTER CONFIGURE

Print Title

This field is used to enter up to 50 characters to be displayed at the top of the printout.

Screen(s) Where Field is Present

PRINTER CONFIGURE

Range Hold

These fields enable/disable several autoranging.

Auto All enables these routines, providing automatic adjustment when making AF or RF measurements.

Hold All disables these routines, requiring you to manually set the affected settings.

The following fields are affected by the **Range Hold** field:

- **Input Atten** in the RF ANALYZER and SPEC ANL screens.
- **Gain Cntl** in the AF ANALYZER screen. This field controls three AF gain setting fields:

Input Gain

De-Emp Gain

Notch Gain

Operating Considerations

The **Hold All** setting is primarily used when the instrument is operated by remote control, such as in an automated test system.

Unless you have very specific reasons for disabling the automatic functions, you should set this field to **Auto All** when operating the instrument manually.

Screen(s) Where Field is Present

INSTRUMENT CONFIGURE

Ref Select

This field selects the timebase reference signal to use for generating and analyzing signals.

- **Auto** automatically selects an external reference if a signal of sufficient level is detected at the EXT REF IN.
- **Internal** uses the Test Set's internal timebase and ignores signals connected to the EXT REF IN connector.
- **External** requires a valid reference signal to be connected to the EXT REF IN connector.

Operating Considerations

The front-panel REFERENCE indicators show which source is selected and whether or not the timebase is phase locked. The Test Set will not operate correctly if it is unlocked.

Locking to an external reference may take several seconds. The lower the frequency the longer it may take to lock to the signal.

Screen(s) Where Field is Present

INSTRUMENT CONFIGURE

Remote Mode

This field is reserved for use with special software that enables remote operation through a PC.

Operating Considerations

When remote mode is enabled, the information displayed on the CRT will be mirrored and sent out over the SERIAL 11 port. The incoming serial stream will be interpreted as escape-key sequences. Access to the configuration fields for serial port 11 will be limited, but serial ports 9 and 10 will not be affected.

This setting is retained when the instrument is turned off.

Screen(s) Where Field is Present

I/O CONFIGURE

Retries

This field sets the number of calls that will be tried before an origination attempt is terminated. The total number of tries will be the number entered in this field, plus one for the original attempt.

This setting is retained when the instrument is turned off.

Screen(s) Where Field is Present

MODEM CONFIGURE

RF Chan Std

Use the RF channel standard field to select the channel standard for the radio-under-test. The RF generator's and the RF analyzer's frequencies are automatically set to correspond to the channel number entered in the **RF Channel** field. **RF Channel** replaces the **RF Gen Freq** and **Tune Freq** fields on several screens when the **RF Display** field on the INSTRUMENT CONFIGURE screen is set to **Chan**.

Each standard has a prefix code that indicates what type of radio to test; mobile station (MS) or land station (LS). For example, if you are testing an AMPS base station, select **LS AMPS**.

For the NAMPS standards, a third letter is added indicating which frequency band is used: upper, middle, or lower. For example, when testing a base station using the upper band you would select **LSU NAMPS**.

The **USER-DEF** selection is used to define your own channel assignments. When selected, you enter the **Base Freq**, **Chan Space**, and **(Gen)-(Anl)** settings.

For more information see the following related topics:

[“Base Freq \(User Defined\)” on page 228](#)

[“Chan Space \(User Defined\)” on page 229](#)

[“\(Gen\)-\(Anl\)” on page 235](#)

Operating Considerations

The channel standard can also be changed in the lower subfield of the **RF Channel** field on the SPEC ANL, RF GENERATOR, and RF ANALYZER screen.

Screen(s) Where Field is Present

INSTRUMENT CONFIGURE

RF Display

This field selects the format for entering the RF generator's and RF analyzer's frequencies:

- When **Freq** is selected, you enter the RF generator's and the RF analyzer's frequencies directly using the keypad or knob.
- When **Chan** is selected, the **RF Gen Freq** and **Tune Freq** fields on all screens are replaced by the **RF Channel** field, and only the channel number is entered and displayed.

Channel tuning eliminates the need to enter transmit and receive frequencies directly into the Test Set. Once your radio's RF channel standard is selected, you only have to enter the channel number to automatically set the RF generator and RF analyzer to the correct frequencies.

Operating Considerations

See the [“RF Chan Std” on page 244](#) for more information.

Screen(s) Where Field is Present

INSTRUMENT CONFIGURE

RF Gen Volts

This field specifies whether you want RF voltages expressed as the voltage across a 50 ohm load, or the open circuit voltage (emf).

Operating Considerations

This setting affects the RF generator's and the tracking generator's amplitudes.

Screen(s) Where Field is Present

INSTRUMENT CONFIGURE

RF In/Out

This field is used to indicate losses or gains between the RF IN/OUT port and the device-under-test.

- Enter a *positive* value to indicate a gain (such as an amplifier gain). When the RF IN/OUT port is used as an output, the RF generator's (or tracking generator's) level is automatically set the specified amount *below* what is indicated in the RF generator's **Amplitude** field. Example; if this value is 10 dB, and the **Amplitude** field shows 0 dBm, the actual level out of this port is -10 dBm.

When this port is used as an input, the **TX Power** measurement and spectrum analyzer's marker level (**Lvl**) are automatically *reduced* by that amount.

- Enter a *negative* value to indicate a loss (such as cable loss). The RF generator's (or tracking generator's) level out this port is automatically set that amount *above* what is indicated in the RF generator's **Amplitude** field.

When used as an input, the **TX Power** and the spectrum analyzer's marker level (**Lvl**) measurements are *increased* by that amount.

This field is only used when the **RF Level Offset** field is set to **On**.

See the “[RF Level Offset](#)” on page 246 for more information.

Screen(s) Where Field is Present

INSTRUMENT CONFIGURE

RF Level Offset

This field enables/disables the RF level offsets entered in the **RF In/Out**, **Duplex Out**, and **Antenna In** fields below it.

- When set to **On**, the RF generator's amplitude and RF analyzer's power measurement are offset by the values entered in these fields.
- When set to **Off**, the values in these fields are ignored.

For more information see the following related topics:

“[Antenna In](#)” on page 227

“[Duplex Out](#)” on page 232

“[RF In/Out](#)” on page 246

Screen(s) Where Field is Present

INSTRUMENT CONFIGURE

RF Offset

This field is displayed when the **RF Display** field is set to **Freq.**

This field enables/disables the RF generator – RF analyzer frequency offset specified in the **(Gen)-(An1)** field below it.

Operating Considerations

When an RF offset is used, changing the RF generator's frequency or RF analyzer's tune frequency automatically alters the other setting.

See [“Setting an RF Generator/Analyzer Offset” on page 69](#) for more information.

Screen(s) Where Field is Present

INSTRUMENT CONFIGURE

Save/Recall

This field specifies which memory device the Test Set accesses when the save and recall functions are used.

- **Internal** is a section of internal RAM. RAM is also used for running IBASIC programs, which may require you to delete the save/recall registers if the program is very large.
- **Card** is the front-panel MEMORY CARD (PC card) slot. A **Save/Recall Device is not Present** message is displayed if you try to save or recall an instrument setup when a write-able PC card is not installed in the Test Set.
- **RAM** refers to RAM disks that you can create on internal RAM. Refer to the *Programmer's Guide* for information on creating RAM disks. This is part of the same memory used when “internal” is specified, and may have to be erased when loading very large IBASIC programs. A **Save/Recall Device is not initialized** message is displayed if you try to save or recall an instrument setup when a RAM disk has not been created.

Screen(s) Where Field is Present

I/O CONFIGURE

Serial Baud

This field selects the baud rate for serial communications when using the serial ports. Selecting this field displays a list of baud rate choices.

This setting is maintained after the instrument is turned off.

Operating Considerations

When in remote mode (**Remote Mode** field is set to **On**), this field is inaccessible.

Screen(s) Where Field is Present

I/O CONFIUGRE

Serial_9 In

This field selects the destination of characters received by the Test Set on the SERIAL PORT 9.

- **Inst** configures the serial port to connect to an external ASCII terminal or computer to enter IBASIC programs, or to control the Test Set using an external keyboard.
- **IBASIC** is used to allow the IBASIC controller to read the serial port while a program is running.

Operating Considerations

If a serial printer is connected, the PRINT command causes the printer to take control of the serial port until printing is done.

This setting is maintained after the instrument is turned off.

Screen(s) Where Field is Present

I/O CONFIGURE

Serial No.

This field displays the serial number of the Test Set.

Screen(s) Where Field is Present

INSTRUMENT CONFIGURE

Serial Port

This field selects the serial port. The SERIAL 9 port must be used for serial printing. SERIAL 11 is reserved for use with special software that enables remote operation through a PC.

For more information about the serial ports see [“SERIAL 9, 10, and 11” on page 291](#).

Screen(s) Where Field is Present

I/O CONFIGURE
MODEM CONFIGURE

Status

This field indicates the status of the modem connection.

- Connected
- Idle
- Waiting
- Dialing
- Authenticating
- Disconnecting

Screen(s) Where Field is Present

MODEM CONFIGURE

Stop Length

This field specifies the number of stop bits (1 or 2) used for serial communications when using the serial port.

This setting is maintained after the instrument is turned off.

Operating Considerations

When in remote mode (`Remote Mode` field is set to `On`), this field is inaccessible.

Screen(s) Where Field is Present

I/O CONFIGURE

Time

This field sets the time-of-day for the instrument's 24 hour clock.
(Example, 4:53 PM is entered 16:53)

Operating Considerations

The internal clock still functions when the instrument is turned off.

Screen(s) Where Field is Present

INSTRUMENT CONFIGURE

Total RAM

This field displays the total amount of RAM available for IBASIC programs and save/recall registers.

Screen(s) Where Field is Present

INSTRUMENT CONFIGURE

8 **Signaling Encoder and Decoder -
Screens and Control Fields**

Signaling Encoder and Decoder Screens

The Decoder's Signal Source

The decoder *always* gets its signal immediately after the de-emphasis network of the AF analyzer. De-emphasis can be turned on or off on the AF ANALYZER screen, or can be controlled while using the decoder by assigning a global USER key to the De-**Emphasis** field.

Decoder Frequency Measurements

The decoder uses a different timebase for frequency counting than the AF Analyzer. Therefore, their measurements may be different when measuring the same signal (by a very small amount).

The Encoder

The encoder's uses AF Generator 2 to generate its signals. The available signaling formats are AMPS-TACS, NAMPS-NTACS, DTMF, and a function (waveform) generator.

AMPS-TACS, NAMPS-NTACS Encoder and Decoder

The following signaling formats are available for this decoder.

- AMPS = Advanced Mobile Phone Service.
- NAMPS = Narrowband Advanced Mobile Phone Service.
- TACS = Total Access Communications Systems.
- JTACS = Total Access Communications System for Japan.
- NTACS = Narrowband Total Access Communications Systems (NTACS is an extension of JTACS).

The theory and applications of cellular telephone systems are beyond the scope of this manual. If additional information is needed, refer to the many technical manuals available on the subject of cellular telephones.

Control and Voice Channel Identifiers

The AMPS/TACS and NAMPS/NTACS encoder modes use the same forward control channel (FOCC) settings and output format. However, the forward voice channel (FVC) information is different.

The control and voice channel fields are available in separate menus. The **Channel** field is used to select the **Cnt1** (FOCC) or **Voice** (FVC) menu.

Fields available only in the forward control channel menu have (FOCC) printed in the field title.

Fields available only in the forward voice channel menu have (FVC) printed in the field title.

Encoder/Decoder Interaction

The AMPS-TACS/NAMPS-NTACS encoder acts like a base station transmitter, creating *forward* control and voice channel information (FOCC/FVC). The AMPS-NAMPS-TACS/NTACS decoder acts like a base station receiver, analyzing *reverse* control and voice channel signals (RECC/RVC).

The decoder uses the encoder's **Data Rate** setting to specify how fast the incoming message is being sent. Therefore, when using the decoder, you must first specify the data rate in the encoder.

AMPS-TACS, NAMPS-NTACS Decoder

The AMPS-TACS, NAMPS-NTACS decoder acts like a base station receiver by analyzing Reverse Control Channel (RECC) and Reverse Voice Channel (RVC) message streams for various cellular telephone formats.

The decoder can also be used to analyze Forward Control Channel (FOCC) and Forward Voice Channel (FVC) data from the base station.

Decoder Mode Differences

The AMPS-TACS and NAMPS-NTACS decoder modes are essentially the same for analyzing reverse control channel (RECC) information. However, the voice channel (RVC) information for NAMPS-NTACS is displayed differently than AMPS-TACS information. Fields and decoder measurements that are only used for either mode are noted in their descriptions.

Interpreting Decoded Data

RECC and AMPS-TACS RVC Measurements

See [“NAMPS-NTACS Reverse Voice Channel Measurements” on page 256](#) for information about NAMPS-NTACS RVC measurements.

After being armed, the measurement begins when the last bit of Word Sync has been received. The **Gate Time** field specifies the measurement period for all RECC measurements and the AMPS-TACS RVC measurement.

The received bits are displayed as hexadecimal (hex) characters. If the last bits received do not complete the last hex character, the received bits are used as the most significant bits in the character, and the remaining bit positions are filled with zeros.

For example; if the last bits received are “01”, two zeros are added to the right to produce the binary number 0100. The hexadecimal equivalent, 4, is displayed.

The first two hex characters of the RECC data displayed contain the 7-bit Digital Color Code of the Seizure Precursor. The characters are right-justified so the farthest bit to the left for the first hex character is always 0. The first word of the RECC message begins in the third hex character of the displayed data.

All bits of the RECC and RVC data streams received after the initial Word Sync are displayed, including Parity and additional Dotting and Word Sync sequences.

The decoder does not check for any errors in the received data stream.

Figure 8-1 Decoding the Reverse Control Channel (RECC) Data

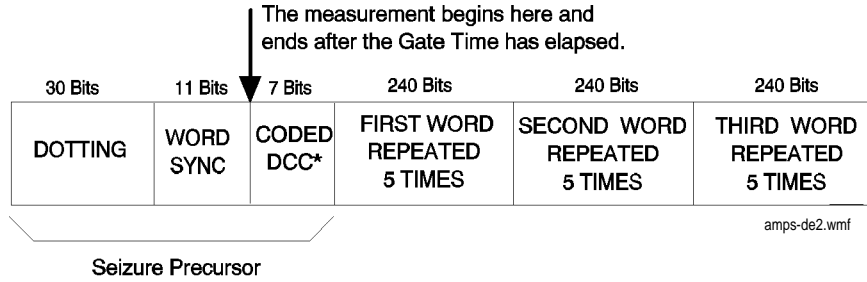

* Digital Color Code

Figure 8-2 Decoding the AMPS-TACS Reverse Voice Channel (RVC) Data

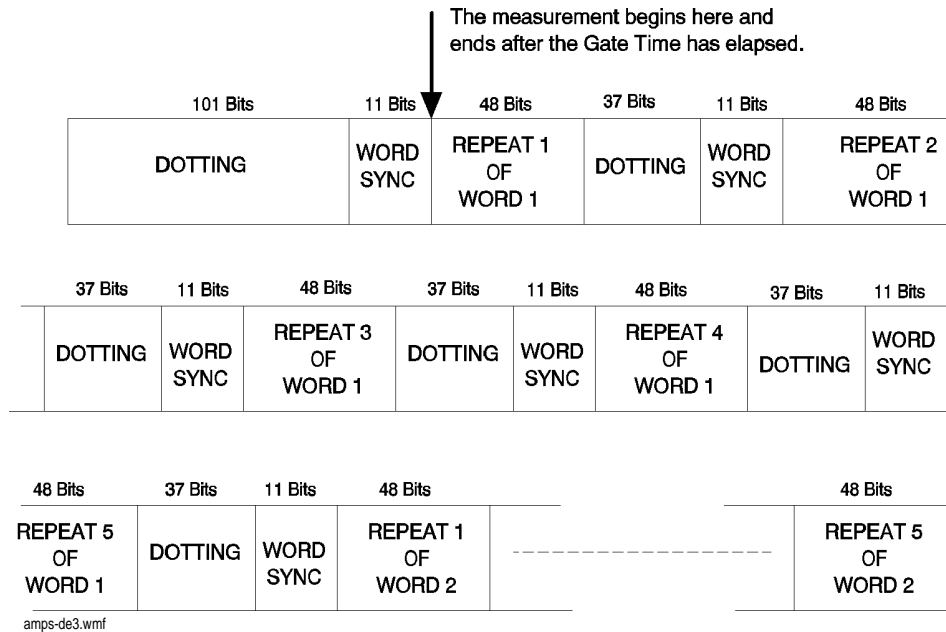

NAMPS-NTACS Reverse Voice Channel Measurements

Three types of RVC information can be decoded; selected using the Measure field. See Figure 8-3.

Figure 8-3 Measure Field

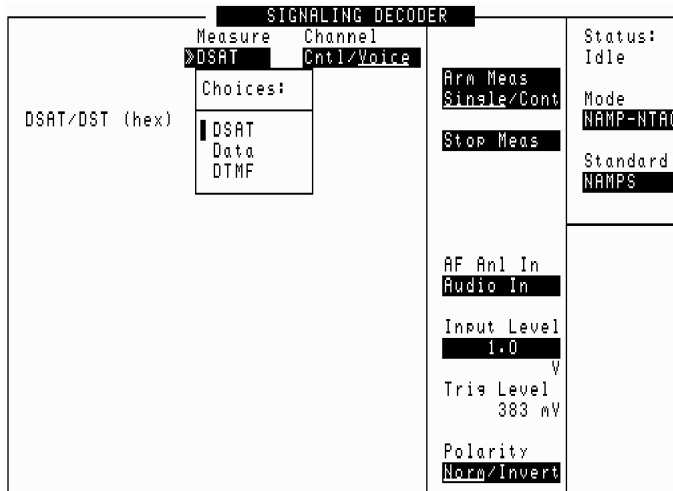

- **DSAT** displays the 6-digit DSAT (Digital Supervisory Audio Tone) or DST (Digital Signaling Tone) number, depending on the type of signal being received. If the received number is not one of the 14 standard combinations (7 DSAT or 7 DST), the decoder displays a constantly changing number until one of the standard values is detected. See Figure 8-4 on page 257.

Data displays the 36 message bits and 12 parity bits of the RVC message. The measurement begins when the last sync word bit is received, and ends after the last parity bit is received. The measurement is re-triggered when the next sync word is received: there is no gate time function for this decoder mode. See Figure 8-4 on page 257.

DTMF displays Dual-Tone Multi-Frequency tone pair frequencies and on/off times. These are tones that may be used to trigger connected equipment after a mobile-to-base station connection has been made (such as an answering machine or voice-mail system). See Figure 8-4 on page 257.

Figure 8-4 Decoding NAMPS-NTACS Reverse Voice Channel (RVC) Data

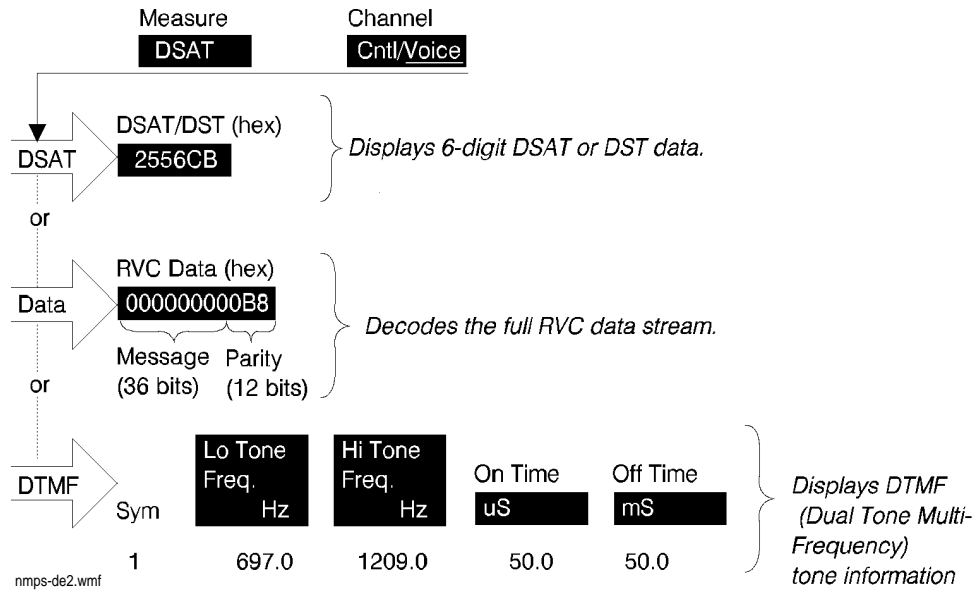

DTMF Sequence Encoder and Decoder

The DTMF sequence encoder creates dual-tone multi-frequency tone sequences of variable frequency, amplitude, and duration. Its signal can be used to modulate the RF generator, or it can be output through the AUDIO OUT connector.

The DTMF sequence decoder analyzes dual-tone multi-frequency tone sequences and displays the associated parameters.

Measurement Limits

Lo Tone: 680 - 960 Hz

Hi Tone: 1190 - 1660 Hz

Actual limits are typically slightly wider than this. However, the crossover point between Hi and Lo tone decoding is approximately 1.1 kHz. If incoming tones approach this point, unreliable measurements may be displayed (frequency measurement errors and spurious off times).

Function Generator Encoder and Decoder

The function generator provides single-tone audio frequency signals of various waveforms, amplitudes, and frequencies. Its signal can be used to modulate the RF generator, or it can be output through the AUDIO OUT connector.

Decoding Considerations

Frequency measurements are affected by the **Filter1**, **Filter2**, **Settling**, and **De-Emphasis** settings in the AF ANALYZER screen.

Four dashes (- - -) are displayed if the incoming signal is out of range, or if the **Gate Time** is too long for the frequency being measured.

Control Fields for the Signaling Encoder and Decoder

AF Anl In

See “AF Anl In” on page 185

AFGen2 To

See “AFGen2 To” on page 188

Arm Meas

Arm measurement prepares the decoder to be triggered by an incoming signal when `single` is selected. When selected, the `status:` field indicates `Armed`.

Screens Where Field is Present

SIGNALING DECODER (All Modes)

B/I Delay

Busy/idle delay determines the number of bits that are counted before a busy/idle bit changes from the Idle state to the busy state. This function is used with the `WS Delay` and `1stBitDly` settings in the `Busy/Idle` field.

Screens Where Field is Present

SIGNALING ENCODER (Modes: AMPS-TACS, NAMP-NTAC)

Bursts

This field defines the number of times the message data is output when `send` is selected. This function only works when the `send Mode` field is set to `Burst`.

Screens Where Field is Present

SIGNALING ENCODER (Modes: AMPS-TACS, NAMP-NTAC, DTMF)

Busy/Idle

This field selects the busy/idle status information to be included in the signaling sequence.

- **Idle** sets the busy/idle bits of the forward control channel information to indicate an idle state.
- **Busy** sets the busy/idle bits of the forward control channel information to indicate a busy state.
- **WS Delay**, word sync delay, prevents a busy/idle change until the word sync information has been received and a defined number of delay bits has been counted. The delay bit value is set in the **B/I Delay** field.
- **1stBitDly**, first bit delay causes the busy/idle bit to be set after a bit has been received and a defined number of delay bits has been counted. The delay bit value is set in the **B/I Delay** field.

Screens Where Field is Present

SIGNALING ENCODER (Modes: AMPS-TACS, NAMP-NTAC)

Channel

For the Signaling Decoder this field selects the type of data to decode: Reverse Control Channel (**Cnt1**), or Reverse Voice Channel (**voice**).

For the Signaling Encoder this field selects the forward control channel (FOCC) or forward voice control (FVC) menus.

Screens Where Field is Present

SIGNALING DECODER (Modes: AMPS-TACS, NAMP-NTAC)

SIGNALING ENCODER (Modes: AMPS-TACS, NAMP-NTAC)

Data (hex)

This display field lists the decoded data serially as it is received. This field is labeled **RECC Data (hex)** for the NAMPS-NTACS mode, but performs the same function.

Screens Where Field is Present

SIGNALING DECODER (Modes: AMPS-TACS, NAMP-NTAC)

Data Level

This setting determines the signal level change that occurs when a logical high (1) or low (0) is output. The unit-of-measure used depends on the **AFGen2 To** setting. The direction of the output level change depends on the **Polarity** setting.

Screens Where Field is Present

SIGNALING ENCODER (Modes: AMPS-TACS, NAMP-NTAC)

Data Rate (analog)

Signaling Decoder

This measurement field displays the data rate in bits-per-second for the data stream being received.

The encoder screen's Data Rate field tells the decoder how fast the incoming message is being sent. Set the **Data Rate** field's value before using the AMPS-TACS or NAMPS-NTACS decoder.

Signaling Encoder

This field specifies how fast the data stream is output in bits-per-second.

This setting is also used to determine the turn off code frequency (TOC frequency Hz = Data Rate in bps). Example: 1000 bps = 1 kHz

This field specifies the data rate for the signal being decoded, and must be set before using the AMPS-TACS/NAMPS-NTACS decoder.

Screens Where Field is Present

SIGNALING DECODER (Modes: AMPS-TACS, NAMP-NTAC)

SIGNALING ENCODER (Modes: AMPS-TACS, NAMP-NTAC)

DSAT

The signaling encoder's **DSAT:** field is displayed only when the **Mode** field is set to **NAMP-NTAC** and the **Channel** field is set to **Voice**.

This field is used to set one of the 7 valid DSAT sequences to be used on the designated voice channel.

DSAT is output continuously when **send DSAT** is selected, and is only stopped when **stop DSAT** is selected. If message or DST information is sent using **send**, the DSAT signal is temporarily interrupted until that information has been sent.

Screens Where Field is Present

SIGNALING ENCODER (Modes: NAMP-NTAC)

DSAT/DST (hex)

The **DSAT/DST (hex)** field is displayed only when the **Mode** field is set to **NAMP-NTAC** and the **Channel** field is set to **Voice**.

The DSAT/DST field displays the received **DSAT/DST** sequence. The received sequence is displayed in hexadecimal and can be checked against the DSAT value displayed in the DSAT right-hand DSAT field.

Screens Where Field is Present

SIGNALING DECODER (Modes: NAMP-NTAC)

Filler (FOCC)

Figure 8-5

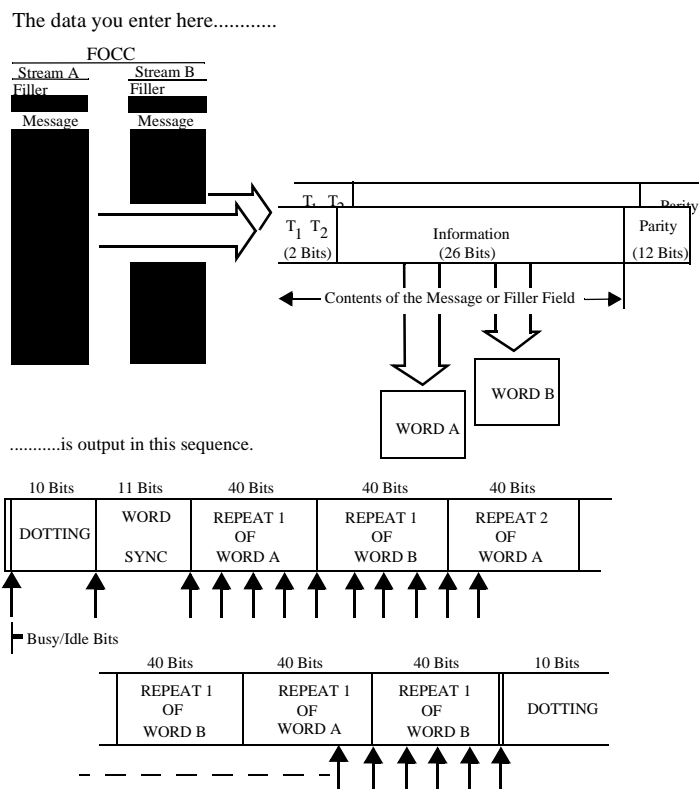

Each Filler field contains 7 hexadecimal characters representing the 2 type bits and 26 information bits of the control filler/message word. The dotting, word sync, and parity bits are generated automatically.

Operating Considerations

The control filler is sent continuously when **Send Filler** is selected, or after a control message has been sent using **Send**. The control message is stopped whenever **Stop Filler**, **Filler**, **Channel**, **Data Rate**, **Polarity**, or **AFGen2 To** is selected.

Both filler fields must be full (seven digits) for the forward control channel information to be structured correctly. Do not leave any blank spaces.

Screens Where Field is Present

SIGNALING ENCODER (Modes: AMPS-TACS, NAMP-NTAC)

Frequency

This measurement displays the decoded signal's frequency.

Screens Where Field is Present

SIGNALING DECODER (Modes: Func Gen)

Gate Time

This field specifies how long the decoder analyzes a signal after it has been triggered. Up to 65 seconds of gate time can be specified. The gate time should be set long enough to allow the preamble and all necessary data bits to be captured.

Operating Considerations

If the gate time is too long, the decoder's data buffer becomes full. A message is displayed instructing you to decrease the gate time.

This function is not used with the NAMPS-NTACS RVC decoder.

Screens Where Field is Present

SIGNALING DECODER (All Modes)

Hi Tone

This is for the high frequency tone in each tone pair. The measurement type is selected by selecting the **Freq** field to display a list of measurement choices.

Operating Considerations

Frequency error is calculated by comparing the DTMF encoder's frequency settings for each tone pair with the decoded frequencies.

Screens Where Field is Present

SIGNALING DECODER (Modes: DTMF)

Input Level

This field specifies the expected data signal level (after de-emphasis if used). The higher the level of signal expected by the analyzer, the higher the trigger level is set. See “De-emphasis Effects on Input Level” on page 266.

Operating Considerations

The unit-of-measure is determined by the **AF An1 In** setting.

The input level should be set high enough to prevent false triggering, but low enough to allow triggering for valid signals (typically about 3 kHz). *This you to set the input level well below the expected level.*

When using de-emphasis, the **Input Level** setting may need to be reduced significantly to properly decode the incoming signal. De-Emphasis is enabled/disabled using the **De-Emphasis** field on the AF ANALYZER screen.

If de-emphasis is used (by setting the AF Analyzer’s **De-Emphasis** field to 750 μ s), the **Input Level** should be set to about 1/5 of the measured signal’s level. For example, a 1 kHz, 1 V_{peak} sinewave into the AF Analyzer’s input requires an **Input Level** of approximately 0.212 V to trigger correctly.

De-emphasis Effects on Input Level

De-emphasis is a single-pole, low-pass filter with a 212.2 Hz corner frequency. It is enabled/disabled using the **De-Emphasis** field on the AF ANALYZER screen. The input level is the expected level at the output of the de-emphasis network.

Assuming a mean DTMF frequency of approximately 1 kHz, decoding with de-emphasis on (set to

750 μ s) requires the input level to be set to $212/1000 = 0.212$ times the peak deviation, or about 1/5 the incoming level of the tone.

Examples of Input Level Settings

Example 8-1

Example 1

Peak deviation 3 kHz, De-emphasis off. Set the input level to 3 kHz.

Example 8-2

Example 2

Peak deviation 3 kHz, De-emphasis 750 ms. Set the input level to $3 \times 0.212 = 636$ Hz

See Also

[“Trig Level” on page 278](#)

Screens Where Field is Present

SIGNALING DECODER (All Modes)

Lo Tone

This measurement field lists the frequency or frequency error for the low frequency tone in each tone pair. The measurement type is selected by selecting the **Freq** field to display a list of measurement choices.

Operating Considerations

Frequency error is calculated by comparing the DTMF Encoder's frequency settings for each tone pair with the decoded frequencies.

Screens Where Field is Present

SIGNALING DECODER (Modes: DTMF)

Measure

This field is only displayed when the **Channel** field is set to **Voice**. This field selects the type of decoded data to display: DSAT or DST codes, message data (Data), or DTMF (Dual-Tone Multi-Frequency) tone data.

Screens Where Field is Present

SIGNALING DECODER (Modes: NAMP-NTAC)

Message (FOCC)

Figure 8-6

AMPS-TACS/NAMPS-NTACS FOCC Message and Filler Data Format

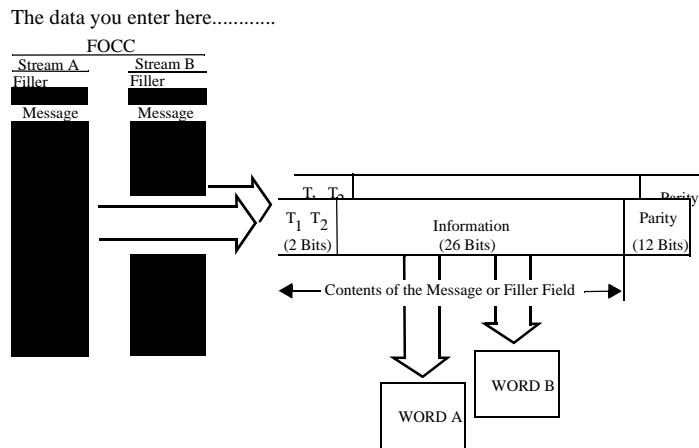

.....is output in this sequence.

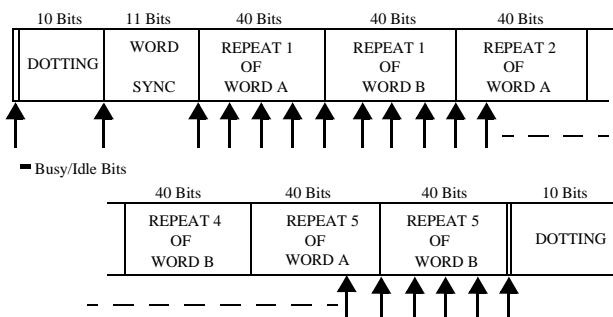

Message streams A and B specify various forward control channel parameters.

Operating Considerations

Like the filler information, the message information can only be input in full (seven digit) lines. Also, message streams A and B must have the same number of lines in them.

Screens Where Field is Present

SIGNALING ENCODER (Modes: AMPS-TACS, NAMPS-NTACS)

Message (FVC) (AMPS-TACS)

Figure 8-7 AMPS-TACS FVC Message Data Output Format

The data you enter here.....

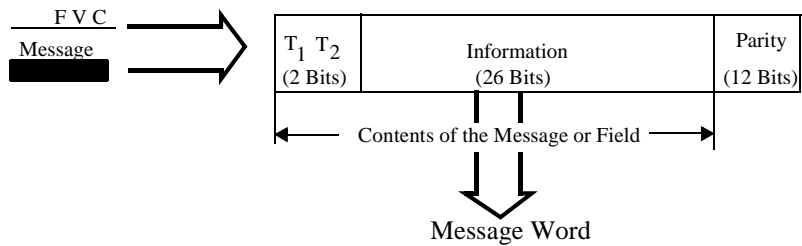

.....is output in this sequence

| | | | | | |
|----------|---------|------------------------|---------|---------|------------------------|
| 101 Bits | 11 Bits | 40 Bits | 37 Bits | 11 Bits | 40 Bits |
| DOTTING | W.S. | REPEAT 1 OF WORD | DOTTING | W.S. | REPEAT 2 OF WORD |

W.S.=Word Sync

| | | | | | | | | |
|---------|---------|------------------------|---------|---------|-------------------------|---------|---------|-------------------------|
| 37 Bits | 11 Bits | 40 Bits | 37 Bits | 11 Bits | 40 Bits | 37 Bits | 11 Bits | 40 Bits |
| DOTTING | W.S. | REPEAT 9 OF WORD | DOTTING | W.S. | REPEAT 10 OF WORD | DOTTING | W.S. | REPEAT 11 OF WORD |

This description applies to the AMPS-TACS mode.

The 7 hexadecimal characters of the FVC **Message** field represent the 2 type bits and 26 information bits in the FVC message word.

The generation of dotting, word sync, parity, and the 11 repetitions of these parameters in the FVC message stream is done automatically.

Operating Considerations

The entire field must contain data, no blank spaces are allowed. SAT is turned off while the FVC message stream is being sent.

Screens Where Field is Present

SIGNALING ENCODER (Modes: AMPS-TACS)

Message (FVC) (NAMPS-TACS)

Figure 8-8 NAMPS-NTACS FVC Message Data output Format

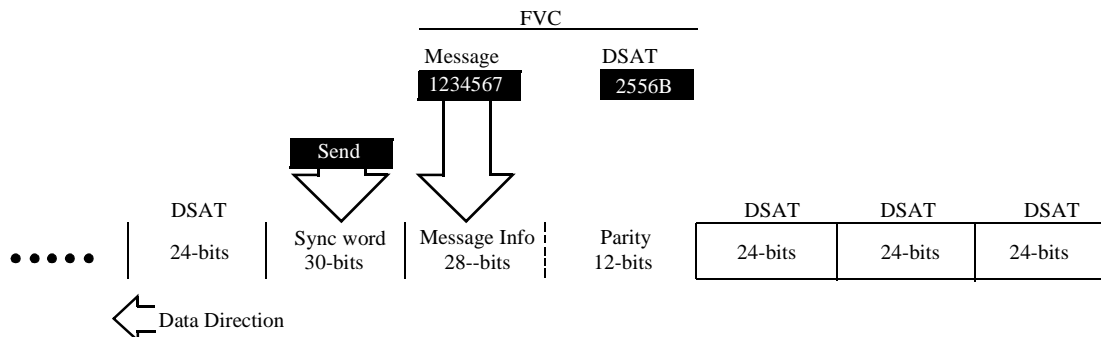

This description applies to the NAMPS-NTAC mode.

The 7 hexadecimal characters (28 bits) of this FVC message are combined with 12 parity bits calculated by the encoder to output a 40-character data stream. This information is output when the **Message/DST** field is set to **Message**, and **Send** is selected.

Operating Considerations

The entire field must contain data, no blank spaces are allowed. DSAT is turned off while the FVC Message Stream is being sent.

Screens Where Field is Present

SIGNALING ENCODER (Modes: NAMPS-NTAC)

Message/DST (FVC)

This field is available only in NAMPS-NTAC mode.

This field determines what type of data is sent when **Send** is selected:

1. Selecting **Message** causes the contents of the **Message** field to be output.
2. Selecting **DST** causes the digital signaling tone sequence to be output. The sequence sent is the inverse of the sequence entered in the **DSAT** field, and is automatically determined by the Encoder.

The DST values are: DAA934, DAA4D4, DA9564, DA52B2, D954D4, D94D52, and D69654.

Screens Where Field is Present

SIGNALING ENCODER (Modes: NAMPS-NTAC)

Mode

This field is used to choose which of the Test Set's Decoder screens to display.

Func Gen
DTMF
AMPS-TACS
NAMP-NTAC

Screens Where Field is Present

SIGNALING DECODER (All Modes)
SIGNALING ENCODER (All Modes)

Num of Bits

This field lists the total number of bits displayed. This number is dependent on Data Rate of the signal being decoded, the **Gate Time** of the decoder, and the size of the decoder's data buffer.

Operating Considerations

The buffer has a maximum capacity of:

- 1584 bits for decoding Reverse Voice Channel (RVC) data streams.
- 1583 bits for decoding Reverse Control Channel (RECC) data streams.

This measurement is not available for NAMPS-NTACS RVC decoding.

See Also

["Gate Time" on page 265](#)

Screens Where Field is Present

SIGNALING DECODER (Modes: AMPS-TACS, NAMP-NTAC)

Off Time

For the encoder, this field sets the length of time each DTMF tones is off during the sequence.

For the decoder, this measurement column lists the length of time each tone is "off" prior to the next tone being received.

Screens Where Field is Present

SIGNALING ENCODER (Modes: DTMF)
SIGNALING DECODER (Modes: DTMF)

On Time

For the encoder, this field sets the length of time each DTMF tone is on during the sequence.

For the decoder, this measurement column lists the length of time each tone is on during the sequence.

Screens Where Field is Present

SIGNALING ENCODER (Modes: DTMF)

SIGNALING DECODER (Modes: DTMF)

Polarity

This field is used to match the polarity of the encoded signal being analyzed.

This function is helpful to restore the proper data polarity when the transmitter, repeater, or receiver used in your communications system has an odd number of inversions; causing the received data to be inverted when decoded. (This is common when a signal is translated to a lower frequency using an LO whose frequency is higher than the signal's frequency; or when inverting amplifiers are used.)

Normal Operation

When this field is set to **Norm**, a logical high (1) is displayed when a positive peak in the received signal is detected. A negative peak displays a logical low (0).

Inverted Operation

When this field is set to **Invert**, a logical low (0) is displayed when a positive peak in the received signal is detected. A negative peak displays a logical high (1).

Operating Considerations

Inverting amplifiers used in transmitters, receivers, and repeaters can cause an inversion of the modulating digital data. If the decoded signal does not display the expected results, change this field's setting to see if the signal may be getting inverted before being decoded.

Screens Where Field is Present

SIGNALING DECODER (Modes: AMPS-TACS, NAMP-NTAC)

SIGNALING ENCODER (Modes: AMPS-TACS, NAMP-NTAC)

Pre-Emp

This field determines whether the encoder's signal passes through or bypasses the 750 ms pre-emphasis network. Pre-emphasis may be required when testing some FM receivers.

Pre-emphasis, when used, attenuates the lower frequency tone (1200 Hz at 1200 bps) to 2/3 of the **AF Gen2 To** field level setting.

See Also

["Twist" on page 279](#)

Screens Where Field is Present

SIGNALING ENCODER (Modes: DTMF)

RECC Data (hex)

This display field lists the decoded data serially as it is received. This is the same information that the AMPS-TACS **Data (hex)** measurement displays.

Screens Where Field is Present

SIGNALING DECODER (Modes: AMPS-TACS, NAMP-NTAC)

SAT Freq (FVC)

This field is available only in AMPS-TACS mode.

This field sets the supervisory audio tone's frequency. This signal is sent continuously whenever the FVC is selected, except while the Message is being sent.

Screens Where Field is Present

SIGNALING ENCODER (Modes: AMPS-TACS, NAMP-NTAC)

SAT Level (FVC)

This field sets the supervisory audio tone's level. The unit-of-measure depends on the **AFGen2 To** setting.

Operating Considerations

SAT is turned off while the FVC message stream is being sent.

Screens Where Field is Present

SIGNALING ENCODER (Modes: AMPS-TACS, NAMP-NTAC)

Send

Selecting this field causes the FVC or FOCC message to be output.

Operating Considerations

When sending an FOCC message stream, the contents of the **Filler** are continuously output after the message data has been sent. **stop Filler** is used to stop the output.

Screens Where Field is Present

SIGNALING ENCODER (Modes: AMPS-TACS, NAMP-NTAC, DTMF)

Send DSAT (FVC)

This field is available only in NAMP-NTAC mode.

Selecting this field causes the contents (24 bits) of the **DSAT** field to be continuously output until **stop DSAT** is selected. If a message or **DST** is sent by selecting **send**, the DSAT data is output continuously **after** the message is output.

Screens Where Field is Present

SIGNALING ENCODER (Modes: AMPS-TACS, NAMP-NTAC)

Send Filler (FOCC)

Selecting this field causes the contents of the **Filler** fields for Stream A and Stream B to be output. The fillers continue to be output until **stop Filler** is selected.

Screens Where Field is Present

SIGNALING ENCODER (Modes: AMPS-TACS, NAMP-NTAC)

Send Mode

This field selects the mode used when **Send** is selected to output the message.

- **Single** outputs the entire message once.
- **Burst** outputs the Message the number of times specified in the **Bursts** field.
- **Cont** causes the message to be output continuously until **Stop** is selected.
- **Step** is not used in the AMPS-TACS mode.

Screens Where Field is Present

SIGNALING ENCODER (Modes: AMPS-TACS, NAMP-NTAC, DTMF)

Sine Units

This field specifies whether the signal's output is in units of rms or peak. This field is only present when the **AFGen2 To** field is set to **Audio Out**.

Screens Where Field is Present

SIGNALING ENCODER (Modes: Func Gen)

Single/Cont

This field specifies how long you want the analyzer to decode incoming signals:

- **Single** tells the analyzer to display the information received during one **Gate Time**. Measurements are displayed until **Arm Meas** is selected again.
- **Cont** is used to automatically re-arm the analyzer and display the measurements on a continual basis until **Single** is selected. Previous measurement results are over-written by subsequent measurements.

Operating Considerations

To dis-arm the decoder in single mode, select the **Stop Meas** field. The Stop Meas function is disabled when **Cont** is selected.

Screens Where Field is Present

SIGNALING DECODER (All Modes)

Standard

This field specifies the standard for the signal being tested.

Decoder Operating Considerations

This setting alters the decoder's function by specifying the expected frame structure and channel range for the incoming signal.

Trying to run a test with the wrong standard selected will result in incorrect decoded data, or will display an operating error message.

Encoder Operating Considerations

Each standard affects the following conditions:

- The types of frames that can be sent.
- The range of valid channel numbers.
- The encoding of the frame data.
- The interpretation of received frames.

Screens Where Field is Present

SIGNALING DECODER (Modes: AMPS-TACS, NAMP-NTAC, DTMF)
SIGNALING ENCODER (Modes: AMPS-TACS, NAMP-NTAC, DTMF)

Status

This field indicates what the encoder or decoder is doing.

- **Idle** is displayed when no data is being sent.
- **Control** is displayed when control channel data is being output.
- **Working** is displayed when a handshake has been performed and working channel data is being sent.

Screens Where Field is Present

SIGNALING ENCODER (Modes: AMPS-TACS, NAMP-NTAC, DTMF)
SIGNALING DECODER (All Modes)

Stop

Selecting this field stops the data stream being output when the **send Mode** is set to **Cont** or **Burst**. After this field is selected, the current repetition of the data stream is finished, and the turn-off code is output.

Screens Where Field is Present

SIGNALING ENCODER (Modes: AMPS-TACS, NAMP-NTAC, DTMF)

Stop DSAT (FVC)

This field is available only in NAMP-NTAC mode.

Selecting this field stops the digital supervisory audio tone.

Screens Where Field is Present

SIGNALING ENCODER (Modes: NAMP-NTAC)

Stop Filler (FOCC)

Selecting this field stops the **Filler** information from being output after **Send Filler** or **Send** is used.

Screens Where Field is Present

SIGNALING ENCODER (Modes: AMPS-TACS, NAMP-NTAC)

Stop Meas

This field is used to disarm the decoder when making single measurements (encoder **Send Mode** is set to **Single**). It is not used when making continuous (**Cont**) measurements.

Screens Where Field is Present

SIGNALING DECODER (Modes: All Modes)

Sym

The symbol column corresponds to the DTMF decoder's symbols assigned for each tone. As each tone pair is analyzed, the corresponding symbol is listed in this column.

Operating Considerations

The symbol assigned to a received tone is based on the closest symbol frequency to that pair.

Screens Where Field is Present

SIGNALING DECODER (Modes: DTMF)

Symbol Frequencies (Hz)

The eight column/row frequencies are automatically entered by the **standard** field setting. You can change the frequency values using the **DATA** keys.

Screens Where Field is Present

SIGNALING ENCODER (Modes: DTMF)

Trigger Pattern (bin)

This field allows you to enter a specific bit pattern to filter displayed information. The decoder only displays the received data when this binary pattern is encountered immediately after triggering. This is helpful when you only want to display messages containing very specific information.

The trigger pattern is entered as a sequence of ones, zeros, and dots. A dot will cause the decoder to trigger for either a one or a zero in that bit position in the received data stream.

Operating Considerations

This function is not available for decoding NAMPS-NTACS RVC information.

Screens Where Field is Present

SIGNALING DECODER (Modes: AMPS-TACS, NAMP-NTAC)

Trig Level

The trigger level indicates the minimum signal level required to begin a measurement that has been “armed.” The level is adjusted by changing the **Input Level** field’s setting.

The input level should be set high enough to prevent false triggering, but low enough to allow triggering for valid signals. *This may require you to set the input level well below the expected level.*

Screens Where Field is Present

SIGNALING DECODER (Modes: AMPS-TACS, NAMP-NTAC, Func Gen)

Twist

Twist is the ratio of amplitudes (in dB) between the high frequency and low frequency tone in each DTMF pair. A positive value indicates a higher amplitude for the high frequency tones. A negative value indicates a higher amplitude for the low frequency tones.

The amplitude of the combined tones is set in the **AFGen2 To** field.

Twist and Pre-emphasis Interaction

Twist and Pre-emphasis affect the relative levels of the high and low tones within each symbol (tone pair). If pre-emphasis is off, twist sets the difference in deviation (in dB) between the high and low tones. If twist is off, pre-emphasis places a 6 dB per octave difference in deviation between the high and low tones. If both twist and pre-emphasis are on, the two effects are summed.

For most conditions, set **Twist** to 2.5 dB, **Pre-Emp** on, and 60% rated deviation (3 kHz for a typical 5 kHz deviation rated receiver).

[“Examples of Twist and Pre-emphasis Interaction” on page 279](#)

Examples of Twist and Pre-emphasis Interaction

Example 8-3

Example 1:

3 kHz deviation, Twist 0 dB, Pre-emphasis off.

The level of each low tone and high tone individually generate 1.5 kHz deviation. The tones are summed to produce 3 kHz deviation.

Example 8-4

Example 2:

3 kHz deviation, Twist 2.5 dB, Pre-emphasis off.

The high tone has 2.5 dB (a factor of 1.334) more deviation than the low tone. The two tones are summed to produce 3 kHz peak deviation. Therefore, the low tone's deviation is 1286 Hz and the high tone's deviation is 1714 Hz.

Example 8-5

Example 3:

3 kHz deviation, Twist 0 dB, Pre-emphasis on.

There is a 6 dB per octave difference between the high and low tones. For example, if sending a 1, which has a low tone of 697 Hz and a high tone of 1209 Hz, the high tone has a deviation of $1209/697 = 1.735$ times the low tone's deviation. The high tone's deviation is then $20 \times \log(1209/697) = 4.78$ dB higher than the low tone. Since their sum must equal 3 kHz, the low tone's deviation is 1097 Hz, and the high tone's deviation is 1903 Hz.

Example 8-6

Example 4:

3 kHz deviation, Twist 2.5 dB, Pre-emphasis on.

If sending a 1 (697 Hz low tone and 1209 Hz high tone), the high tone's deviation is 1.334 (see "Example 2:" on page 279) \times 1.735 (see "Example 3:" on page 279) approximately 2.314 times the low tone's deviation. Since the peak deviation of their sum is 3 kHz, the low tone's deviation is 905.5 Hz and the high tone's deviation is 2094.5 Hz.

Screens Where Field is Present

SIGNALING ENCODER (Modes: DTMF)

Waveform

This field selects the desired waveform for AF Generator 2. The available waveforms are as follows:

- Sine wave
- Square wave
- Triangle wave
- Ramp (positive-going and negative-going)
- DC \pm
- Universal Noise
- Gaussian Noise

Screens Where Field is Present

SIGNALING ENCODER (Modes: Func Gen)

9 **Connectors**

Alphabetical Listing of [“Connectors”](#) on page 282.

Connectors

10 MHz REF OUT

This connector furnishes a 10 MHz reference for external instruments.

Operating Considerations

Waveform = sinewave
Output frequency = 10 MHz
Output level >0.5 V rms
Output impedance approximately 50 Ω

NOTE

The reference output frequency is always 10 MHz, independent of the selected input reference frequency.

16 \times CHIP CLOCK 19.6608 MHz OUT

This output provides a 19.6608 MHz (16 times the CDMA chip rate) square wave with a 60% duty cycle. This signal comes from the CDMA frame clocks.

Operating Considerations

Nominal output level = TTL
Output impedance = 50 Ω

ANALOG MODULATION IN

This connector provides an external modulation connection to the RF generator.

Operating Considerations

The **Mod In To** field of the RF GENERATOR screen sets the type of modulation (AM or FM).

The **FM Coupling** field on the RF GENERATOR screen selects ac or dc coupling of this signal for FM operation.

ANT IN

The antenna input is used for analyzing low-power RF signals (≤ 60 mW), and is typically used for off-the-air measurements. This port can be selected in the RF ANALYZER, SPEC ANL, CDMA ANALYZER, or CODE DOM screens.

CAUTION

Connecting a signal of >60 mW (17.78 dBm) to the ANT IN port can cause instrument damage (although internal protection circuits can typically withstand a short-duration signal of several Watts).

If the overpower circuit is triggered (signified by a warning message at the top of the screen), remove the signal from the ANT IN port, and reset using **Meas Reset** (press and release the **Shift** key, then the **Hold** key) or turn the Test Set off and on to reset it.

Operating Considerations

Input impedance = 50Ω

TX power cannot be measured using this port; use the RF IN/OUT port. However, low power levels can be measured using this port with the spectrum analyzer.

Additional sensitivity for this port is available using the **sensitivity** field in the RF ANALYZER and SPEC ANL screens.

AUDIO IN

Two connectors are used to input audio signals to the AF analyzer:

- HI is the main audio signal input connection.
- LO is used for the audio signal reference. Three choices are available using the AF ANALYZER screen's **Audio In Lo** field:
 - **Gnd** connects the center pin through approximately 100 Ω to chassis ground.
 - **Float** is a floating input.
 - **600 To Hi** provides a 600 Ω internal load to match an audio source with an output impedance of 600 Ω

The measured level is the potential between the HI and LO center pins. The shells of both connectors are at chassis ground.

For more information see “AF Anl In” on page 185, and “Audio In Lo” on page 190.

Operating Considerations

Input impedance is switchable between 1 M Ω
in parallel with 95 pF, or 600 Ω
floating.

This port is selected as the AF analyzer's input using the **AF Anl In** field on the AF ANALYZER screen.

Signals input to the AF analyzer are routed through different filters, amplifiers, and detectors that affect the displayed measurement.

CAUTION

The maximum level between the HI and LO center pins is 42 V peak (approximately 30 Vrms). Exceeding this value can cause permanent instrument damage.

AUDIO OUT

This port is used to output signals from audio frequency generators 1 and 2.

Operating Considerations

The output level is set by the AF generators and is not affected by the front-panel VOLUME control.

Output impedance $< 1 \Omega$

Maximum output current = 20 mA peak

Maximum reverse voltage = 12 V peak

AC/DC coupling is selected using the **Audio Out** field. This field is available on the RF GENERATOR screen.

BASEBAND OUT (I and Q)

These outputs provide buffered versions of the I and Q drive signals.

Operating Considerations

The I and Q drive signals are balanced by DACs that provide the correct dc offset for the I/Q modulator.

Output impedance = 50Ω

Nominal output level = 250 mV (open circuit)

Frequency = approximately 600 kHz

Chassis Ground

The chassis ground terminal provides a general chassis connection.

CHIP CLOCK 1.2288 MHz OUT

This output provides a 1.2288 MHz (CDMA chip rate) square wave with a 50% duty cycle. This signal comes from the CDMA frame clocks.

Operating Considerations

Nominal output level = TTL

Output impedance = 50Ω

DATA IN

This connector provides a data input to the CDMA generator.

Operating Considerations

Input level = TTL
Input impedance = 50k Ω

Data Rate = 1.2288 Mcps

DUPLEX OUT

This connector is an output for the RF generator, CDMA generator and tracking generator.

Operating Considerations

Output impedance = 50 Ω

The RF generator's output is selected in the **Output Port** field. This field is available on the RF GENERATOR, CDMA GENERATOR, and SPEC ANL screens.

CAUTION

Connecting a signal of >60 mW (17.78 dBm) to the DUPLEX OUT port can cause instrument damage (although internal protection circuits can typically withstand a short-duration signal of several Watts).

If the overpower circuit is triggered (signified by a warning message at the top of the screen), remove the signal from the DUPLEX OUT port, and reset using **Meas Reset** (press and release the **Shift** key, then the **Hold** key) or turn the Test Set off and on to reset it.

EVEN SECOND SYNC IN

This port is an input for the even second clock from the base station under test. A positive edge on this connector starts two timers. One timer, after reaching terminal counts, starts CDMA frame clocks. The other timer starts pilot PN sequence generation. The **Even Sec In** field on the CDMA GENERATOR screen controls this port. See "[Even Sec In](#)" on page 158.

Operating Considerations

Input impedance = 50 k Ω
Input level range = TTL

EXT REF IN

This connector allows you to input an external reference. The reference frequency is selected using the **Ext Ref In** field on the INSTRUMENT CONFIGURE screen.

Operating Considerations

Input frequency = 1, 2, 5, 10, or 15 MHz; 1x, 2x, 4x, 8x, or 16x chip

Input level >0.15 V rms

Input impedance approximately 50Ω

When a valid signal is applied to the EXT REF IN port, the Test Set automatically switches from internal to external reference if the **Ref Select** field is set to **Auto**.

This signal is used as a reference for, and directly affects, these functions:

- RF Generator Frequency (including the Tracking Generator)

- RF Frequency Counter

- AF Frequency Counter

- RF Analyzer Tune Frequency

- Spectrum Analyzer Center Frequency

- CDMA Generator Frequency

- CDMA Analyzer Frequency

AF generators 1 and 2 are not affected using an external reference; they use their own reference.

NOTE

The reference output frequency is always 10 MHz, independent of the selected input reference frequency.

Electrostatic discharges to the EXT REF IN port of 0.5 kV or above may cause degradation of performance requiring operator intervention.

EXT SCOPE TRIG IN

This connector provides an external oscilloscope's trigger input.

Operating Considerations

Input threshold approximately 2.5 V

Maximum Input level approximately 20 V peak

Input impedance is:

- 100 k Ω for signals ≤ 5.6 V peak
- 5 k Ω for signals >5.6 V peak

When measured with no load on the input, a 5 Volt level is present on the connector due to the internal pull-up resistor design.

FRAME CLOCK OUT

This output provides an external connection to several internal clocks. The clocks are selected using the `Frame Clock Output` field on the `INSTRUMENT CONFIGURE` screen. The frame clock selections are as follows:

- 20.00 ms
- 26.67 ms
- 80.00 ms
- 2.00 s

GPIB

This connector allows communication between the Test Set and other instruments or computers using the GPIB Interface Bus.

For more information see the [“GPIB Adrs” on page 236](#).

MEMORY CARD Slot

This front-panel opening is where PC cards are inserted.

PARALLEL 15

This port is used with printers requiring a parallel interface when printing screen images or test results. Set the `Printer Port:` field (on the `PRINTER CONFIGURE` screen or `TESTS (Printer Setup)` screen) to `Parallel` to print to this port. Use address `PARALLEL_15` when sending data to this port from IBASIC programs.

Pin numbers are embossed on the connector. Pin assignments are as follows:

Figure 9-1

Parallel Port Pin Assignments

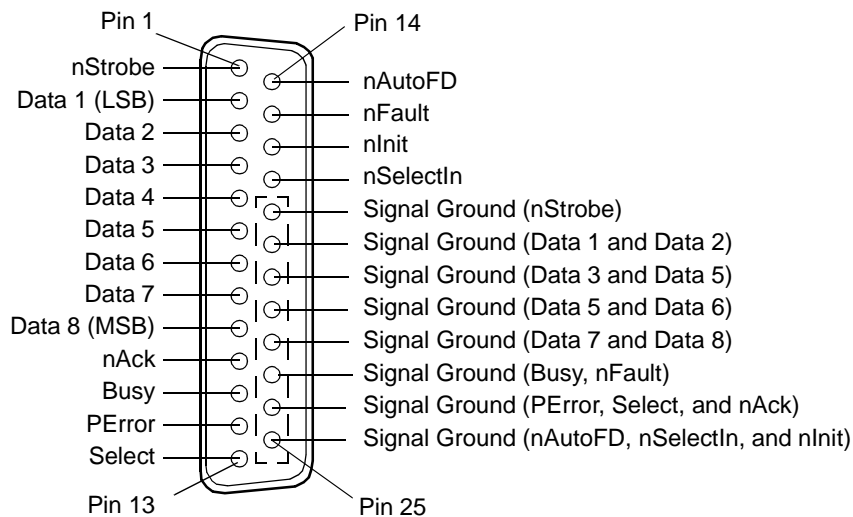

PARALLEL 16

PARALLEL PORT 16 is reserved for future enhancements.

RF IN/OUT

This Type-N connection is used to output signals from the RF generator and to input RF signals.

CAUTION

Overpower Damage — Refer to the Test Set's connector panel for maximum input power level. Exceeding this level can cause permanent instrument damage.

If the RF power at the RF IN/OUT port exceeds allowable limits, a loud warning signal sounds and a message appears at the top of the screen. If this occurs, disconnect the RF power, reset using **Meas Reset** (press and release the **Shift** key, then the **Hold** key), and allow the Test Set to cool off for approximately 2 minutes before making any other measurements on this port.

Operating Considerations

This port must be used when measuring TX (RF) power.

Signals ≤ 60 mW can be input to the ANT IN connector for all RF measurements except TX Power.

This port can be selected on the RF ANALYZER, RF GENERATOR, CDMA GENERATOR, CDMA ANALYZER, CODE DOM, or SPEC ANL screens.

SCOPE MONITOR OUT

This connector provides an external output from the AF analyzer.

Operating Considerations

The **scope To** field in the AF ANALYZER screen determines the source of this signal. For more information see the [“Scope To” on page 214](#).

The level is not affected by the front-panel VOLUME knob.

Output impedance < 1 k Ω

SERIAL 9, 10, and 11

The serial ports are used to input and output serial data for entering programs, printing tests results and screen images, and sending test results to a connected controller or terminal.

Operating Considerations

The serial communications settings are defined on the I/O CONFIGURE screen.

SERIAL 9 must be used for serial printing.

The IBASIC controller sends and receives data to the serial ports using address 9 for the primary port, and 10, 11 for the other ports. For example, to enter data from the primary serial port into a program variable named SDATA, you could use the following command:

```
ENTER SERIAL_9;SDATA
```

To send data from your program out of the primary serial port, you could use the following command:

```
OUTPUT SERIAL_9;SDATA
```

SERIAL 10 can only be configured through GPIB.

SERIAL 11 is reserved for future use with special software that enables remote operation through a PC.

Figure 9-2 Serial Port Pin Assignments

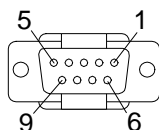

Table 9-1 Serial Port Pin Assignments

| Pin | Description |
|-----|---------------------------|
| 1 | CD - Carrier Detect |
| 2 | RD - Receive Data |
| 3 | TD - Transmit Data |
| 4 | DTR - Data Terminal Ready |
| 5 | Ground |
| 6 | DSR - Data Set Ready |
| 7 | RTS - Request to Send |
| 8 | CTS - Clear to Send |
| 9 | RI - Ring Indicator |

TRIGGER QUALIFIER IN

This input is active when an external trigger qualifier is selected with the Qual Event

field on the CDMA ANALYZER and CODE DOM screens.

If the trigger is to occur on the TRIGGER QUALIFIER IN signal, select **Delay** in the **Trig Event** field and select a delay of 0.0 μ s. If the TRIGGER QUALIFIER IN signal is a qualifier, select a trigger source in the **Trig Event** field.

For more information see [“Qual Event” on page 168](#), and [“Trig Event” on page 174](#).

Operating Considerations

Input impedance = 50 k Ω

Input level range = TTL

VIDEO OUT

This connector provides a signal for using an external video monitor. The signal provides a duplicate of the Test Set's screen.

Operating Considerations

The CRT's Video Output drives a multisync monitor at 19.2 kHz (analog). Examples of this type of monitor include the Electrohome ECM 1410-DMS 14-inch color monitor and the EVM 1242-P4VID 12-inch monochrome monitor.

10 **Accessories, Manuals, Support**

Modifications

The following information can be found in the Agilent Technologies 8935 Assembly Level Repair Manual:

- Hardware Upgrades/Modifications
- Firmware Upgrades
- Power Cables

Agilent Technologies Accessories

Table 10-1 Accessories

| Descriptions | Ordering Number |
|--|--------------------------------|
| 8935 Samsung CDMA BTS Test Solution 8935 RF Tools Hardware Accessory Kit | E6550A E6550A Option 001 |
| 8935 RF Tools Kit (CDMA & TDMA) | E6554A |
| 8935 Lucent Base Station Connector Kit 8935 RF Tools Hardware Accessory Kit | E8300A E8300A Opt 001 |

External Monitor

The CRT Video Output drives a multisync monitor at 19.2 kHz (analog). Examples of this type of monitor include the Electrohome ECM 1410-DMS 14-inch color monitor and the EVM 1242-P4VID 12-inch monochrome monitor.

Agilent Technologies Manuals (English and Other)

Table 10-2 Manuals

| Descriptions | Language | Ordering Number |
|---|----------|-----------------|
| 8935 Series E6380A Manuals on CD-ROM | English | E6380-90027 |
| 8935 Series E6380A CDMA Application Guide (paper) | English | E6380-90016 |
| 8935 Series E6380A Programmer's Guide (paper) | English | E6380-90018 |
| 8935 Series E6380A Reference Guide (paper) | English | E6380-90019 |
| 8935 Series E6380A AMPS Application Guide (paper) | English | E6380-90017 |
| 8935 Series E6380A Assembly Level Repair Manual (paper) | English | E6380-90015 |
| 8935 Series E6380A GPIB Syntax Reference Guide | English | E6380-90073 |
| 8935 Series E6380A CDMA Application Guide | Korean | E6380-90063 |
| 8935 Series E6380A Reference Guide | Korean | E6380-90064 |
| 8935 Series E6386A Samsung CDMA Cellular/PCS Base Station Test Set Software | Korean | E6386-90002 |

Agilent Technologies Test Software

The Radio Test Software performs automated tests on radios used in various radio communication systems. Each test package is contained on an individual memory card.

Table 10-3

| Number | Description |
|---------------|--|
| E6385A | 8935 Series Lucent CDMA Cellular/PCS Base Station Test Set Software |
| E6386A | 8935 Series Samsung CDMA Cellular/PCS Base Station Test Set Software |
| E6387A | 8935 Series Nortel CDMA Cellular/PCS Base Station Test Set Software |
| E6389A | 8935 Series Nortel P-Series Base Station Test Set Software 935 Series Nortel TRU Base Station Test Set Software |
| E8303A | 8935 Series Motorola Base Station Test Set Software |

Options

Table 10-4

| Order Number | Description |
|---------------------|--------------------------|
| 1D5 | High Stability Reference |

Support for Your Instrument

Getting Help

If you have problems using this Test Set, and cannot find the solution in these documents or the Help screens, please use one of the following contacts:

- Your local or regional sales office listed in [Table 10-5 on page 298.](#))
- U.S. Call Center: 800 542-4844
- Korea Agilent Technologies Direct: (82/2) 769-0800
- Canada Agilent Technologies Direct: (800) 387-3154
- European Call center: +31 20 547-9990
- Test and Measurement Organization on the web.

Parts and service for your Test Set can be ordered by

Customer Training

Agilent Technologies offers customers a variety of training materials and classes that explain the theory and applications of many Agilent Technologies products. Contact your Agilent Technologies regional sales office to arrange training for you or your group.

Table 10-5 Agilent Regional Sales and Service Offices

| | | |
|--|---|--|
| <p>United States of America: Agilent Technologies Test and Measurement Call Center P.O. Box 4026 Englewood, CO 80155-4026</p> <p>(tel) 1 800 452 4844</p> | <p>Canada: Agilent Technologies Canada Inc. 5150 Spectrum Way Mississauga, Ontario L4W 5G1</p> <p>(tel) 1 877 894 4414</p> | <p>Europe: Agilent Technologies European Marketing Organization P.O. Box 999 1180 AZ Amstelveen The Netherlands</p> <p>(tel) (3120) 547 9999</p> |
| <p>Japan: Agilent Technologies Japan Ltd. Measurement Assistance Center 9-1 Takakura-Cho, Hachioji-Shi, Tokyo 192-8510, Japan</p> <p>(tel) (81) 456-56-7832 (fax) (81) 426-56-7840</p> | <p>Latin America: Agilent Technologies Latin America Region Headquarters 5200 Blue Lagoon Drive, Suite #950 Miami, Florida 33126 U.S. A.</p> <p>(tel) (305) 267 4245 (fax) (305) 267 4286</p> | <p>Australia/New Zealand: Agilent Technologies Australia Pty Ltd. 347 Burwood Highway Forest Hill, Victoria 3131</p> <p>(tel) 1 800 629 485 (Australia) (fax) (61 3) 9272 0749 (tel) 0 800 738 378 (New Zealand) (fax) (64 4) 802 6881</p> |
| <p>Asia Pacific: Agilent Technologies 24/F, Cityplaza One, 111 Kings Road, Taikoo Shing, Hong Kong</p> <p>(tel) (852) 3197 7777 (fax) (852) 2506 9233</p> | | |

11 **Error Messages**

General Information About Error Messages

Information concerning error messages displayed by the Test Set may be found in one of the following manuals:

- *Agilent Technologies 8935 Programmer's Guide*
- *Agilent Technologies 8935 Assembly Level Repair Manual*
- *Agilent Technologies Instrument BASIC User's Handbook:*
- *A Beginner's Guide to SCPI*

The format of the displayed message determines which manual contains information about the error message. There are four basic error message formats:

- Positive numbered error messages
- IBASIC error messages
- GPIB error messages
- Text only error messages

The following paragraphs give a brief description of each message format and direct you to the manual to look in for information about error messages displayed in that format.

Positive Numbered Error Messages

Positive numbered error messages are generally associated with IBASIC. Refer to the *Agilent Technologies Instrument BASIC User's Handbook* for information on IBASIC error messages.

Example 11-1 **Positive numbered error messages take the form:**

```
ERROR XX
```

Example 11-2 **For example:**

```
Error 54 Duplicate file name
```

or

```
Error 80 in 632 Medium changed or not in drive
```

Negative Numbered Error Messages

Negative numbers preceding the error messages text correspond to the error conditions outlined in the Standard Commands for Programmable Instruments (SCPI). For more information on SCPI, order the following book,

A Beginner's Guide to SCPI Addison-Wesley Publishing Company ISBN 0-201-56350-9 Agilent Technologies P/N 5010-7166

or contact,

Fred Bode, Executive Director SCPI Consortium
8380 Hercules Drive, Suite P3
La Mesa, CA 91942
Phone: (619) 697-8790, FAX: (619) 697-5955 CompuServe Number:
76516,254

Negative numbered error messages take the form: ERROR – X <error message>

Example 11-3 For example

```
Error -128 Numeric data not allowed
```

or

```
Error -141 Invalid character data
```

IBASIC Error Messages

IBASIC Error Messages are associated with IBASIC operation. IBASIC error messages can have both positive and negative numbers. Refer to the *Agilent Technologies Instrument BASIC User's Handbook* for information on positive numbered error messages. Refer to the GPIB Error Messages section of the *Programmer's Guide* for information on negative numbered error messages (the error message associated with a negative number is the same for GPIB errors and IBASIC errors).

Example 11-4 IBASIC error messages take the form:

```
IBASIC Error: -XX
```

For example:

```
IBASIC Error: -286 Program runtime error
```

GPIB Error Messages

NOTE

For the purposes of this documentation, the terms “GPIB” and “HP-IB” may be considered one and the same.

GPIB Error Messages are associated with GPIB operation. Refer to the Programmers Guide for information on GPIB error messages.

Example 11-5 GPIB error messages take the form:

HP-IB Error: -XX

or

HP-IB Error

For example:

HP-IB Error: -410 Query INTERRUPTED.

or

HP-IB Error: Input value out of range.

Text Only Error Messages

Text only error messages are generally associated with manual operation of the Test Set. This manual contains information on text only error messages.

Text only error messages can also be displayed while running the Test Set’s built-in diagnostic or calibration utility programs. Refer to the *Assembly Level Repair* manual for information on text only error messages displayed while running the Test Set’s built-in diagnostic or calibration utility programs.

Example 11-6 Text only error messages take the form:

This is an error message.

Input value out of range.

The Message Display

During instrument operation, various messages may appear on the Test Set's display. Prompt-type messages generally appear on the first line of the Test Set's display. General operating and error messages usually appear on the second line of the display. Some messages are persistent; they remain displayed until the error condition no longer exists, or until another persistent message with greater priority occurs. Other messages are only displayed when the error first occurs; they are removed when a key is pressed or the knob is turned, or when a GPIB command is received. Many of the messages are displayed on the ERROR MESSAGE screen until the instrument is turned off.

Messages that are about error conditions may tell you what to do to correct the error (turn something off, reduce a field's value, press a certain key, and so forth). Messages and prompts are sometimes accompanied by a beep or warble.

NOTE

Warbles and Beeps

A warble sound indicates that an instrument-damaging event is occurring. Beeps often occur only with the first occurrence of the message. Prompts are generally silent.

Non-Recoverable Firmware Error

The non-recoverable firmware error is very important. It appears when an unanticipated event occurs that the Test Set's firmware cannot handle. The message appears in the center of the Test Set's display and (except for the two lines in the second paragraph) has the form:

```
Non-recoverable firmware error. Please record the 2 lines of
text below and contact Agilent Technologies through your
local
service center or by calling (800) 827-3848 (USA, collect)
and
asking to speak to the Service Engineer.
```

```
'Address error exception'
at line number 0
```

To continue operation, turn POWER off and back on.

Follow the instructions in the message.

Unfortunately, you will not be able to recover from this condition. You must switch the Test Set off and back on. When you rerun the test where the Error Message occurred, it may not occur again. If it does reappear, it would be helpful to Agilent Technologies to record exactly what the configuration of the instrument was when the error appeared and contact Agilent Technologies.

Text Only Error Messages

Operation errors generally occur when you try to do something the Test Set was not designed to do. Most messages tell you what to do to correct the problem, (turn something off, reduce a field's value, press a certain key,...and so forth).

Some common messages are listed here:

- All self tests passed.

The Test Set did not detect any hardware or firmware failures during its initial self-diagnostics

This message should always be displayed immediately after instrument turn on.
- Chan Pwr UNCAL: No Freq or Ch Pwr Fltr cal. Start Chan Pwr Cal.

These messages are displayed when a channel power measurement is being performed but no valid calibration data exists. The message is accompanied by an audible tone (beep). Remove power from the ANT IN or RF IN/OUT connector and select **CaLiBrate** under the **Ch Pwr Cal** field on the CDMA ANALYZER screen. Then reconnect the input signal to proceed.
- ACP UNCAL: No Freq or ACP Offset cal. Start ACP Cal.

These messages are displayed when a channel power measurement is being performed but no valid calibration data exists. The message is accompanied by an audible tone (beep). Remove power from the ANT IN or RF IN/OUT connector and select **CaLiBrate** under the **ACP Cal** field on the CDMA ANALYZER screen. Then reconnect the input signal to proceed.
- Tune freq out of range for ACP. Change freq or ACP Offset.

This message is displayed if you try to perform an ACP measurement or calibration that would cause the Test Set to be tuned to a frequency out of its valid range (for example, the range between 1015 MHz and 1700 MHz). Note that although the tune frequency or channel cannot be set to these frequencies, it could be possible that an invalid tune frequency would be within the range of an attempted adjacent channel power measurement (offset and BW). The message is accompanied by an audible tone (beep).
- Remove power at ANT IN and RF IN/OUT. Restart calibration.

This message is displayed during channel power or ACP calibration if a signal is detected at the ANT IN or RF IN/OUT port with an amplitude high enough degrade the calibration. Remove power at the ANT IN or RF IN/OUT port, and move the cursor (turn the knob) to remove the message. The message is accompanied by an audible tone (beep).

- Input value out of range.

A number was entered that was too large or small for the selected field, for example, trying to set **AFG1 Freq** to 125 kHz.
- Invalid keystroke.

You used a key that has no function relating to the selected field, for example, pressing the **On/Off** key while the **Filter 1** field is selected.
- Option not installed.

You selected a function that requires optional hardware that is not present.
- Turn off either AM or FM settings.

You tried to create simultaneous AM and FM (using any combination of **AFGen1**, **AFGen2**, and the **Mod In To** field). The Test Set does not provide simultaneous AM and FM.
- Squelch interrupt overflow. Reset using **Meas Reset** (press and release the **Shift** key, then the **Hold** key).

The Test Set temporarily interrupts audio measurements when squelch is first broken to prevent internal switching transients from influencing measurements (except when using the **SCOPE**, **SPEC ANL**, **SERVICE** screens). If squelch is repetitively broken in a period of a few seconds, the duration of measurement interruption becomes too great, and the Test Set stops interrupting the signal. Following measurements may be influenced by transient signals.

Meas Reset clears the data buffer used to generate interrupts, resetting the normal squelch operation to eliminate transients.

This condition may occur when monitoring low-level off-the-air signals.
- Cal file checksum incorrect - initializing file.

This error usually occurs after changing the Test Set's firmware ROM's. It is not a problem in that instance, but should not re-appear during subsequent operation of the Test Set.
- One or more self tests failed. Error code: XXXX

An instrument failure was detected when the Test Set was turned on. (For example, having a stuck front-panel key during turn on.) The numbered error message corresponds to a binary-weighted group of errors listed in the ***TST Common Command** description in the Programmer's Guide.

- Change Ref Level, Input Port or Attenuator (if using **Hold**).

The RF signal level is either too great or too small for the current input port, attenuator setting, or both. This error often occurs when trying to make a low-level measurement using the RF IN/OUT port with the spectrum analyzer. Make the indicated changes until this message is no longer displayed.

- Change RF Gen Amplitude, Output Port or Atten Hold (if on).

This message appears when the RF Generator's **Amplitude** field is set too high when using the RF IN/OUT port or when adjusting the amplitude with the **Atten Hold** field set to **On**.

- The RF IN/OUT port has a lower maximum output level than the DUPLEX OUT port. Use the DUPLEX OUT port, or reduce the RF generator's level.

If **Atten Hold** is **On**, you may be adjusting the amplitude outside of the allowed range. Change the amplitude

- Direct latch write occurred. Cycle power when done servicing.

— The SERVICE screen was accessed and one or more internal latch settings were changed. Turn the instrument off and back on to reset the latches. (This condition can occur during periodic calibration.)

- meaning of, squelch, 217
meaning of, TX power measurement, 56
meaning of, TX power measurements, 183
- Symbols**
of Frames field, 157
#Pts field
 Spectrum Analyzer screen, 185
% delta key, 44
% key, 44
+/- key, 48
- Numerics**
1.23 MHz channel power, 132
10 MHz REF OUTPUT connector, 282
16 x CHIP CLOCK connector, 282
19.6608 MHz OUT connector, 282
30 kHz channel power, 132
600 ohm impedance
 at AUDIO IN, 190
- A**
A Only/A-B field
 Spectrum Analyzer screen, 207
Abort Print field
 Printer Configure screen, 227
abort printing, 226
Abs/Rel field
 Code Domain Analyzer screen, 154
absolute power measurements, 154
ac coupling
 input, 196
 output, 190
ac level
 measurements, 57
 peak detector, 209
AC Level field
 AF Analyzer screen, 179
 RF Analyzer screen, 179
accessories, 295
ACP Cal field
 CDMA Analyzer screen, 150, 151
ACP field
 CDMA Analyzer screen, 132
 CDMA Generator screen, 132
ACP Fltr BW field
 CDMA Analyzer screen, 150
ACP UNCAL, 304
ACP. *See also* adjacent channel power
ADC FS field
 CDMA Analyzer screen, 151
ADC FS measurements, 131, 133
ADCFS field
 CDMA Analyzer screen, 131, 133
 CDMA Generator screen, 131, 133
ADCfs field
 CDMA Generator screen, 151
 Code Domain Analyzer screen, 151
address
 HP-IB, printer, 241
 HP-IB, test set, 236
adjacent channel power calibrating, 63
adjacent channel power measurements, 132
AF analyzer
 input, 185
 level, 266
 signal types analyzed, 185
AF Analyzer screen
 AC Level field, 179
 AF Anl In field, 185
 AF Cnt Gate field, 186
 AF Freq field, 180
 AM Depth field, 179
 Audio In Lo field, 190
 DC Level field, 180
 De-Emp Gain, 192
 De-Emphasis field, 192
 Detector field, 193
 Distn field, 181
 Ext Load R field, 195
 Filter 1 field, 195
 Filter 2 field, 196
 FM Deviation field, 181, 183
 Freq Error field, 182
 Frequency field, 182
 Gain Cntl field, 199
 Input Gain field, 200
 Notch Freq field, 208
 Notch Gain field, 208
 Pk Det To field, 209
 Scope To field, 214
 Settling field, 215
 SINAD field, 184
 SNR field, 184
 Speaker ALC field, 216
 Speaker Vol field, 216
 TX Power field, 183
 TX Pwr Zero, 221
AF Anl In field
 AF Analyzer screen, 185
 Signaling Decoder screen, 185
AF Anl Input field, 120
AF Anl key, 43
AF Cnt Gate field
 AF Analyzer screen, 186
AF Freq field
 AF Analyzer screen, 180
 RF Analyzer screen, 180
 RF Generator screen, 180
AF frequency measurements, 57
AF generator 1
 amplitude, 187
 frequency, 186
 output destination, AUDIO
 OUT connector, 187
 output destination, RF
 generator AM modulator, 187
 output destination, RF
 generator FM modulator, 187
 turning off, 187
AF generator 2
 amplitude, 188
 frequency, 187
 output destination, AUDIO
 OUT connector, 188
 output destination, RF
 generator AM modulator, 188
 output destination, RF
 generator FM modulator, 188
 turning off, 188
AFGen1 Freq field
 RF Generator screen, 186
AFGen1To field
 RF Generator screen, 187
AFGen2 Freq field
 RF Generator screen, 187
AFGen2 To
 Signaling Encoder screen, 188
AFGen2 To field
 RF Generator screen, 188
Agilent Direct assistance
 Canada, 297
 Korea, 297
Agilent sales offices, 24
Agilent service centers, 24
ALC
 disabling, 216
 internal speaker, 216
AM
 input, 206
AM Demod

- AF Anl In, 57
- oscilloscope input, 120
- AM Depth
 - AF Analyzer screen, 179
- AM depth
 - measurements, 57
 - setting, 187, 188
- AM Depth field
 - RF Analyzer screen, 179
 - RF Generator screen, 179
- AM depth measurements, 57
- AM Mod
 - oscilloscope input, 120
- Ampl Hi
 - trigger qualifier, 169
- Ampl Lo
 - trigger qualifier, 168
- Ampl Mid
 - trigger qualifier, 169
- amplifier
 - for distortion measurements, 208
 - for SINAD measurements, 208
- amplitude
 - AF generator, 187, 188
 - RF generator, 189
 - twist, 279
 - vertical sensitivity, 221
- Amplitude field
 - CDMA Generator screen, 151
 - RF Analyzer screen, 189
 - RF Generator screen, 189
 - Spectrum Analyzer screen, 189
- AMPS channel standard, 244
- AMPS-TACS signaling decoder, 253
 - See Also* Signaling Decoder screen, AMPS-TACS mode
- AMPS-TACS signaling encoder, 253
 - See Also* Signaling Encoder screen, AMPS-TACS mode
- analog meter, 59
- ANALOG MODULATION IN connector
 - description, 282
- ANALOG MODULATION INPUT connector
 - coupling, 196
 - for modulating RF generator, 206
- analyzer
 - AF level, 266
 - arming measurements, 275
 - calibration, 111
 - disarming measurements, 277
 - input port, 213
- Analyzer field
 - CDMA Analyzer screen, 152
 - Code Domain Analyzer screen, 152
- analyzer, RF
 - frequency, 220
 - sensitivity, 214
- Anl Dir field
 - CDMA Analyzer screen, 152
- Anl Special field
 - CDMA Analyzer screen, 153
- Answer modem mode, 239
- ANT IN connector
 - avoiding damage, 56, 183, 201, 213
 - connecting to, 41, 213
 - description, 283
 - for off-the-air measurements, 201
 - for RF measurements, 201
 - gain at, 227
 - input attenuation, 200
 - loss at, 227
 - sensitivity, 214, 215
- Antenna In field
 - Instrument Configure screen, 227
- arm
 - measurement, 260, 275
- Arm Meas field
 - CDMA Analyzer screen, 152
 - Signaling Decoder screen, AMPS-TACS mode, 260
 - Signaling Decoder screen, DTMF mode, 260
 - Signaling Decoder screen, Func Gen mode, 260
 - Signaling Decoder screen, NAMP-NTAC mode, 260
- arrow down
 - key, 64
- arrow up
 - key, 64
- ASCII terminal
 - configuring, 248
- ASSIGN, 74
- Assign key, 74
- assistance
 - Agilent Direct, Canada, 297
 - Agilent Direct, Korea, 297
 - call center, Europe, 297
 - call center, United States, 297
- Atten Hold field
 - RF Generator screen, 189
- attenuation
 - automatic control, 200
 - input, RF analyzer, 200
 - manual control, 200
- attenuator hold, 189
- attenuator input, 200
- audio amplitude
 - setting, 187, 188
- audio frequency counter
 - gate time, 186
 - sampling, 186
- audio frequency measurements, 57
- Audio In
 - AF Anl In, 57
 - oscilloscope input, 120
- AUDIO IN connector
 - avoiding damage to, 284
 - description, 284
 - for ac level measurements, 57
- AUDIO IN HI connector, 284
- AUDIO IN LO connector
 - 600 ohm impedance, 190, 284
 - floating, 190, 284
 - grounded, 190, 284
- Audio In Lo field
 - AF Analyzer screen, 190
- Audio Out
 - oscilloscope input, 120
- AUDIO OUT connector
 - coupling, 190
 - description, 285
- Audio Out field
 - RF Generator screen, 190
- audio power measurements, 179
- Authenticating modem status, 249
- Auto All
 - Range Hold, 242
- Auto Zero field
 - CDMA Analyzer screen, 153
 - RF Analyzer screen, 191
- Auto/Norm field
 - Oscilloscope screen, 190
- automatic level control, 216
- autoranging
 - AF/RF measurements, 242
 - gain setting, 199
 - oscilloscope interference, 199, 200
 - spectrum analyzer interference, 199, 200
- Aux field
 - Code Domain Analyzer screen, 155
- average power measurements, 131
- averaging
 - measurement results, 68
 - restart averaging, 68

- Avg 1-100 field
 - Spectrum Analyzer screen, 206
- Avg key, 68
- Avg Pwr field
 - CDMA Analyzer screen, 131
 - CDMA Generator screen, 131
- AWGN generator, 160
- B**
- bandwidth
 - IF filter, 199
- bandwidth, spectrum analyzer, 191
- Base Freq field
 - Instrument Configure screen, 228
- base settings
 - changing, 72
 - default, 72
- BASEBAND OUT connector, 285
- basic operation, 51
- battery, replacing, 75
- baud rate, 248
- beeper
 - error alert, 228
 - spectrum analyzer mask, 205
 - volume control, 225, 228
- Beeper field
 - Instrument Configure screen, 225, 228
- B/I Delay field
 - Signaling Encoder screen, AMPS-TACS mode, 260
 - SignalingEncoder screen, NAMP-NTAC mode, 260
- bits
 - dotting, 264, 269
 - information, 264, 269
 - parity, 264, 269, 270
 - serial data word, 231
 - specifying patter to display, 278
 - triggering, 278
 - type, 264, 269
 - word sync, 264, 269
- BTS Laptop Utility, 82
- Bursts field
 - Signaling Encoder screen, AMPS-TACS mode, 260
 - Signaling Encoder screen, DTMF mode, 260
 - Signaling Encoder screen, NAMP-NTAC mode, 260
- Busy, 261
- Busy/Idle field
 - Signaling Encoder screen, AMPS-TACS mode, 261
- Signaling Encoder screen, NAMP-NTACS mode, 261
- BW= field
 - Spectrum Analyzer screen, 191
- Bypass
 - CW RF Path, 155
 - bypass IQ modulator, 155
- C**
- cable fault measurements, 97
- cables
 - power, 25
- calibrating adjacent channel
 - power, 63
- calibrating channel power, 61, 62
- calibration
 - channel power measurements, 154
 - spectrum analyzer, 111
- Call field
 - Modem Configure screen, 229
- CarFT field
 - Code Domain Analyzer screen, 136, 153, 154
- carrier feedthrough
 - measurements, 136
- Carrier Feedthru field
 - CDMA Analyzer screen, 136
 - CDMA Generator screen, 136
- catalog memory card, 106
- CD pwr unit field
 - Code Domain Analyzer screen, 154
- CD Setup field
 - Code Domain Analyzer screen, 155
- CDMA Analyzer screen
 - ACP Cal field, 150, 151
 - ACP field, 132
 - ACP Fltr BW field, 150
 - ADC FS field, 131, 133, 151
 - Analyzer field, 152
 - Anl Dir field, 152
 - Anl Special field, 153
 - Auto Zero field, 153
 - Avg Pwr field, 131
 - Carrier Feedthru field, 136
 - Chan Pwr field, 132
 - Chn Pwr Cal field, 154
 - Even Sec In field, 158
 - EVM field, 138
 - Freq Error field, 134
 - Gain field, 159
 - Input Atten field, 161
 - Input Port field, 161
 - Magnitude Error field, 138
 - Meas Intvl field, 162, 163
- Phase Error field, 138
- PN Increment field, 165
- PN Offset field, 165, 166
- Pwr Gain field, 166
- Pwr Intvl field, 167
- Pwr Zero field, 168
- Qual Event field, 168
- RF Channel field, 170
- Rho field, 133
- Time Offset field, 135
- Trig Event field, 174
- CDMA Anl key, 43
- CDMA Gen key, 43
- CDMA Generator screen
 - ACP field, 132
 - ADC FS field, 131, 133, 151
 - Amplitude field, 151
 - Avg Pwr field, 131
 - Carrier Feedthru field, 136
 - Chan Pwr field, 132
 - CW RF Path field, 155
 - Data Rate field, 156
 - Data Source field, 157
 - EVM field, 138
 - Freq Error field, 134
 - Gen Dir field, 159
 - Gen Mode field, 160
 - Gen Special field, 160
 - Magnitude Error field, 138
 - Output Port field, 164
 - Phase Error field, 138
 - RF Channel field, 170
 - RF Gen Freq field, 170
 - Rho field, 133
 - Time Offset field, 135
- CDMA standard
 - IS-2000, 142
 - IS95A, 142
- Center Freq
 - Marker To field, 205
- Center Freq field
 - Spectrum Analyzer screen, 191
- center frequency, 174, 182
 - for notch filter, 208
 - for spectrum analyzer, 191
 - RF signal, 220
- Chan
 - RF Display mode, 170, 245
- Chan Num, 153
- Chan Pwr field
 - CDMA Analyzer screen, 132
 - CDMA Generator screen, 132
- Chan Pwr UNCAL, 304
- Chan Size, 154
- Chan Space field
 - Instrument Configure screen, 229

- Channel field
 - Signaling Decoder screen, AMPS-TACS mode, 261
 - Signaling Decoder screen, NAMP-NTAC mode, 261
- channel numbers
 - for analyzer/generator frequencies, 60
- channel power
 - calibrating, 61, 62
- channel power measurements, 132
- channel spacing, user defined, 229
- channel standard
 - AMPS (MS, LS), 244
 - ETACS (MS, LS), 244
 - JTACS (MS, LS), 244
 - KOR PCS (1, 0), 244
 - N AMER PCS, 244
 - NAMPS(MSL, MSM, MSU, LSL, LSM, LSU), 244
 - NTACS (MS, LS), 244
 - TACS (MS, LS), 244
 - USER-DEF, 244
- channel tuning, 60, 170, 245
- chassis ground, 285
- CHIP CLOCK 1.288 MHz OUT
 - connector, 285
- Chn Pwr Cal field
 - CDMA Analyzer screen, 154
- clear
 - global user key assignment, 74
 - RAM, 124
 - register contents, 71, 124
- clock
 - date/time, 232
 - time-of-day, 250
- Code Dom key, 43
- Code Domain Analyzer screen
 - ADCfs field, 151
 - Analyzer field, 152
 - Aux field, 155
 - Bit Reverse Ordering, 145
 - CarFT, 136
 - CarFT field, 153, 154
 - CD pwr unit field, 154
 - CD Setup field, 155
 - Chan Num, 153
 - Chan Size, 154
 - Code Domain Power & Noise, 147
 - Complex Power, 145, 148
 - Controls field, 155
 - Est Rho field, 134
 - Fast Power, 145, 147
 - Find PN field, 158
 - FP Setup field, 155
 - Freq Err field, 158
 - Gain field, 155
 - Hadamard Ordering, 146
 - I Power Level, 162
 - Input Port field, 161
 - Lvl field, 161, 162, 168, 169, 175
 - Main field, 155
 - Marker field, 155
 - Marker Lvl, 162
 - Meas Intvl field, 162, 163
 - Meas Order, 163
 - Measurement field, 163
 - Num Avgs field, 163
 - Ofs Trnsfer field, 164
 - Phase/div field, 164, 172
 - Phse field, 165
 - PN Setup field, 155
 - Power, 145
 - Power & Noise, 145
 - Pwr Ref, 167
 - Pwr Scale, 167
 - Pwr Scale – IS-2000, 167
 - Pwr Scale – IS-95A, 167
 - Pwr Scale field, 167
 - Q Power Level, 168
 - Qual Event field, 168
 - RF Channel field, 170
 - RF In/Ant field, 170
 - Threshold field, 171
 - Time field, 172
 - Time Offset field, 173
 - TmOfs field, 135, 173
 - Trig Event field, 174
 - Trigger field, 155
 - Walsh Chan field, 175
 - Walsh Order, 169, 175
- Code Domain Measurements – IS-2000, 142
- Code Domain Measurements – IS-95A, 139
- code domain phase measurements, 141, 148
- Code Domain Power IS-2000, 146
- code domain power measurements, 139, 142, 146
- code domain timing measurements, 141, 147
- Command Escape Character field
 - Modem Configure screen, 231
- Configure Instrument screen
 - RF Offset field, 247
 - Serial No. field, 248
 - Time field, 250
 - Total RAM field, 250
- Connected modem status, 249
- Connection Timeout field
 - Modem Configure screen, 231
- connectors
 - 10 MHz REF OUTPUT, 282
 - 16 x CHIP CLOCK, 282
 - 19.6608 MHz OUT, 282
 - ANALOG MODULATION IN, 282
 - ANT IN, 283
 - AUDIO IN, 284
 - AUDIO OUT, 285
 - BASEBAND OUT, 285
 - CHIP CLOCK 1.2288 MHz OUT, 285
 - DATA IN, 286
 - DUPLEX OUT, 286
 - EVEN SECOND SYNC IN, 286
 - EXT REF IN, 287
 - EXT SCOPE TRIG IN, 288
 - FRAME CLOCK OUT, 288
 - ground, 285
 - HP-IB, 288
 - I BASEBAND OUT, 285
 - PARALLEL PORT 15, 289
 - PARALLEL PORT 16, 289
 - Q BASEBAND OUT, 285
 - RF IN/OUT, 290
 - SCOPE MONITOR OUTPUT, 290
 - SERIAL PORT 10, 291
 - SERIAL PORT 11, 291
 - SERIAL PORT 9, 291
 - TRIGGER QUALIFIER IN, 291
 - VIDEO OUT, 292
- Cont/Single field
 - Oscilloscope screen, 192
- continuous measurements, 152
- Continuous Reverse Link
 - Waveform, 142
- control filler, 264
- control message, 264
- control status, 276
- Controls field
 - Code Domain Analyzer screen, 155
 - Oscilloscope screen, 192
 - Spectrum Analyzer screen, 192
- Convolutional Encoding, 143
- COPY_PL, IB_UTIL ROM
 - program, 122
- counter
 - AF, 186
 - RF, 212
- coupling
 - ac, 190, 196
 - dc, 190, 196

- notch frequency, 240
- cursor control knob
 - increment setting of, 64
- CW RF Path field
 - CDMA Generator screen, 155
- D**
- dashes
 - meaning of, squelch, 217
 - meaning of, TX power measurements, 56, 183
- Data (hex) field
 - Signaling Decoder screen, AMPS-TACS mode, 261
 - Signaling Decoder screen, NAMP-NTAC mode, 261
- Data Buff
 - data source, 157
- data buffer, 160
 - capacity, 271
- Data field, 256
- data files, replotting, 102
- data files, transferring, 104
- DATA IN connector, 286
- Data Length field
 - I/O Configure screen, 231
- Data Level field
 - Signaling Encoder screen, AMPS-TACS mode, 262
 - Signaling Encoder screen, NAMP-NTAC mode, 262
- data rate
 - signaling encoder, 253
- Data Rate field
 - CDMA Generator screen, 156
 - Signaling Decoder screen, AMPS-TACS mode, 262
 - Signaling Decoder screen, NAMP-NTAC mode, 262
 - Signaling Encoder screen, AMPS-TACS mode, 262
 - Signaling Encoder screen, NAMP-NTAC mode, 262
- Data Source field
 - CDMA Generator screen, 157
- date and time, 225
- Date field
 - Instrument Configure screen, 225, 232
- dB key, 44
- dBm key, 44
- dBuV key, 44
- dc coupling
 - input, 196
 - output, 190
- DC FM Zero field
 - RF Generator screen, 196
- DC Level field
 - AF Analyzer screen, 180
- dc level measurements, 57, 180
- dc wave
 - function generator, 280
- DCFM, 196
- Decimal Equivalent field
 - Modem Configure screen
 - See Command Escape Character, 231
- decimal numbers, 48
- decoder. *See Also* Signaling Decoder screen
- decrement
 - changing setting, 64
- De-emp
 - oscilloscope filters, 121
- De-Emp Gain field
 - AF Analyzer screen, 192
- de-emphasis
 - bypassing, 192
 - effect on DTMF frequency, 266
 - filter, description, 266
 - gain, 192
 - input level, 266
 - selecting, 192
- De-Emphasis field
 - AF Analyzer screen, 192
- default settings
 - base, 72
 - changing, 71, 72
 - power-on, 71
- delay
 - busy/idle, 260
 - first bit, 261
 - trigger, 174
 - word sync, 261
- delete
 - global user key assignment, 74
 - RAM contents, 124
 - register contents, 71, 124
- delta markers, 113, 207
 - frequency, 197
 - level, 202
- DEMO, 126
- demodulation
 - AM, 57, 120
 - FM, 57, 120
 - SSB, 57, 120
- depth, AM, 57
- detector
 - peak, 193, 209
 - rms, 193
 - selecting, 193
- Detector field
 - AF Analyzer screen, 193
- deviation
 - FM, 57, 181, 183
- Dialback modem mode, 239
- Dialing modem status, 249
- Disable modem mode, 239
- Disarm, 152
- disarm measurement, 277
- Disconnect call (modem), 229
- Disconnecting modem status, 249
- Display field
 - Spectrum Analyzer screen, 193
- Distn field
 - AF Analyzer screen, 181
 - RF Analyzer screen, 181
 - RF Generator screen, 181
- distortion, 58
 - measurements, 57, 181
 - measurements, amplifier, 208
 - measurements, variable notch filter, 208
- dotting bits, 264, 269
- DSAT field
 - Signaling Decoder screen, NAMP-NTAC mode, 256, 263
- DSAT/DST (hex) field
 - Signaling Decoder screen, NAMP-NTAC mode, 263
- DTMF field, 256
- DTMF pair, 256
- DTMF signaling decoder, 258
 - See Also* Signaling Decoder screen, DTMF mode
- DTMF signaling encoder, 258
 - See Also* Signaling Encoder screen, DTMF mode
- dual-tone multi-frequency. *See* DTMF
- dump graphics, 226
- DUPLEX OUT connector
 - avoiding damage, 209
 - description, 286
 - gain at, 232
 - loss at, 232
- Duplex Out field
 - Instrument Configure screen, 232
- E**
- Eb/No, 160
- Edit Mask field
 - Spectrum Analyzer screen, 194
- EditPt field
 - Spectrum Analyzer screen, 194
- EEX key, 48
- emf voltage, 245
- encoder/decoder
 - interactions, 253

- See Also* Signaling Encoder screen, Signaling Decoder screen
- EQ In/Out field, 159
- Error Message key, 43
- error messages, 300
- IBASIC echo, 236
- operation, 304
- error vector magnitude. *See* EVM
- escape characters, modem, 231
- Est Rho field
- Code Domain Analyzer screen, 134
- ETACS channel standard, 244
- European Call Center, assistance, 297
- Even Sec In field
- CDMA Analyzer screen, 158
- EVEN SECOND SYNC IN connector, 286
- EVM field
- CDMA Analyzer screen, 138
- CDMA Generator screen, 138
- EVM measurements, 138
- exponents
- entering numbers, 48
- Ext
- data source, 157
- Ext Load R field
- AF Analyzer screen, 195
- Ext Mod
- AF Anl In, 57
- oscilloscope input, 120
- EXT REF IN connector, 287
- Ext Ref In field
- Instrument Configure screen, 233
- EXT SCOPE TRIG IN connector, 288
- external AM input, 206
- external FM input, 206
- external modulation input, 206
- external monitor, 295
- external reference, 287
- external trigger qualifier, 169
- F**
- fast power measurements, 141, 147
- FF at End field
- Printer Configure screen, 233
- FF at Start field
- Printer Configure screen, 233
- fields
- changing settings, 42
- types of, 42
- FILE_XFER, IB_UTIL ROM program, 122
- files
- securing, 123
- Filler (FOCC) field
- Signaling Encoder screen, AMPS-TACS mode, 264
- Signaling Encoder screen, NAMP-NTAC mode, 264
- Filter 1 field
- AF Analyzer screen, 195
- Filter 2 field
- AF Analyzer screen, 196
- Filters
- oscilloscope filters, 121
- filters
- IF bandwidth, 199
- variable notch, 208
- Find PN field
- Code Domain Analyzer screen, 158
- firmware
- revision number, 233
- Firmware field
- Instrument Configure screen, 233
- Fix/Rel mask type, 205
- floating input
- at AUDIO IN LO, 190
- Flow Control field
- I/O Configure screen, 234
- FM
- deviation, 57
- deviation, measurements, 181, 183
- deviation, setting, 187, 188
- input, 206
- FM Coupling field
- RF Generator screen, 196
- FM Demod
- AF Anl In, 57
- oscilloscope input, 120
- FM Deviation field
- AF Analyzer screen, 181, 183
- RF Analyzer screen, 181, 183
- RF Generator screen, 181, 183
- FM deviation measurements, 57
- FM Mod
- AF Anl In, 57
- oscilloscope input, 120
- FOCC, 253
- menu, 261
- outputting, 274
- form feed, 233
- forward control channel. *See* FOCC
- forward link, 152
- forward voice channel. *See* FVC
- four dashes
- meaning of, squelch, 217
- meaning of, TX power measurement, 56
- meaning of, TX power measurements, 183
- FP Setup field
- Code Domain Analyzer screen, 155
- FRAME CLOCK OUT connector, 288
- Frame Clock Output field
- Instrument Configure screen, 234
- Freq
- RF Display mode, 170, 174, 245
- Freq (Delta Mrkr) field
- Spectrum Analyzer screen, 197
- Freq (mask) field
- Spectrum Analyzer screen, 197
- Freq (normal marker) field
- Spectrum Analyzer screen, 198
- Freq (Ref Mrkr) field
- Spectrum Analyzer screen, 198
- Freq Err field
- Code Domain Analyzer screen, 158
- Freq Error field
- CDMA Analyzer screen, 134
- CDMA Generator screen, 134
- frequency
- AF generator 2, 187
- AFGen1, 186
- center, 181, 182
- center, for notch filter, 208
- center, for spectrum analyzer, 191
- center, RF signal, 220
- decoded signal, 265
- delta markers, 113
- effects of RF offset, 247
- for DTMF sequence, 277
- measurements, 182
- RF generator, reference, 228
- setting, 213, 245
- span, 216
- frequency error
- measurements, 134, 182
- Frequency Error field
- AF Analyzer screen, 182
- RF Analyzer screen, 182
- RF Generator screen, 182
- Frequency field
- AF Analyzer screen, 182
- RF Analyzer screen, 182
- RF Generator screen, 182

- Signaling Decoder screen, Func Gen mode, 265
- frequency offset, 69
 - receiver/transmitter, 235
 - RF generator/analyzer, 235
 - tracking generator, 208
- frequency tuning, 60, 170, 245
- function generator
 - waveform, 280
- Function Generator signaling decoder, 259
 - See Also* Signaling Decoder screen, Func Gen mode
- Function Generator signaling encoder, 259
 - See Also* Signaling Encoder screen, Func Gen mode
- functional test
 - for verifying operation, 49
- FVC, 253
 - menu, 261
 - outputting, 274
- G**
- gain
 - automatic control, 199
 - between ANT IN and device-under-test, 227
 - between DUPLEX OUT and device-under-test, 232
 - between RF IN/OUT and device-under-test, 246
 - de-emphasis, 192
 - input, 200
 - manual control, 199
 - notch filter, 208
- Gain Cntl field
 - AF Analyzer screen, 199
- Gain field
 - CDMA Analyzer screen, 159
 - Code Domain Analyzer screen, 155
- gain measurement, swept, 83
- gate time, 186
 - decoder, 265
 - RF counter, 212
- Gate Time field
 - Signaling Decoder screen, AMPS-TACS mode, 265
 - Signaling Decoder screen, NAMP-NTAC mode, 265
- Gaussian noise, 280
- Gen Dir field
 - CDMA Generator screen, 159
- Gen Mode field
 - CDMA Generator screen, 160
- Gen Special field
 - CDMA Generator screen, 160
 - (Gen)-(Anl) (user defined) field
 - Instrument Configure screen, 235
 - (Gen)-(Anl) field
 - Instrument Configure screen, 235
 - generator, AF
 - amplitude, 187, 188
 - frequency, 186, 187
 - output destination, AUDIO OUT connector, 187, 188
 - output destination, RF generator AM modulator, 187, 188
 - output destination, RF generator FM modulator, 187, 188
 - turning off, 187, 188
 - generator, RF
 - amplitude, 189
 - frequency, 213
 - output port, 209, 210
 - reference frequency, 228
 - generator, tracking
 - frequency, 191
 - frequency offset, 208
 - output port, 210
 - sweep, 210
 - sweep frequency range, 216
- GHz key, 44
- grounded input
 - at AUDIO IN LO, 190
- grounding, 285
- H**
- heading
 - for printout, 241
- help
 - how to contact a human, 297
- Help key, 43
- hexadecimal format, 48
- HI indicator, 65
- Hi Limit key, 65
- Hi Tone field
 - Signaling Decoder screen, DTMF mode, 265
- high limit
 - removing, 65
 - setting, 65
- Hold All
 - Range Hold, 242
- Hold/Norm spectrum analyzer marker, 211
- Holdoff Delay field
 - Modem Configure screen, 236
- horizontal sweep
 - oscilloscope, 218
- HP-IB address
 - printer, 241
 - test set, 236
- HP-IB Address field
 - Configure I/O screen, 236
- HP-IB connector, 288
- HP-IB operation
 - squelch effects, 217
- Hz key, 44
- I**
- I BASEBAND OUT connector, 285
- I Power Level, 162
- I/O Config key, 43
- I/O Configure screen
 - Data Length field, 231
 - Flow Control field, 234
 - HP-IB Address field, 236
 - IBASIC Echo field, 236
 - Inst Echo field, 237
 - Mode field, 237
 - Parity field, 240
 - Remote Mode field, 243
 - Save/Recall field, 247
 - Serial Baud field, 248
 - Serial In field, 248
 - Serial Port field, 249
 - Stop Length field, 249
- IB_UTIL
 - COPY_PL, 122
 - FILE_XFER, 122
 - RAM_MANAGER, 124
 - RAM_USAGE, 122
 - ROM program, 122
 - SECURE_IT, 123
- IBASIC controller
 - configuring, 248
- IBASIC Echo field
 - I/O Configure screen, 236
- IBASIC error messages, 236
- Idle, 261
- idle
 - state, 261
 - status, 276
- Idle modem status, 249
- Idle/Send field, 157
- IF filter bandwidth
 - selecting, 199
- IF Filter field
 - RF Analyzer screen, 199
- Ignore modem mode, 239
- impedance
 - input, 284
- Incoming Call Security field
 - Modem Configure screen, 237

- Incr (divide-by)10 key, 64
- Incr Set key, 64
- Incr x10 key, 64
- increment
 - changing setting, 64
- information bits, 264, 269
- Input
 - oscilloscope filters, 121
- input
 - analyzer, 213
 - audio, 600 ohm impedance, 190
 - audio, floating, 190
 - audio, grounded, 190
 - coupling, 196
 - gain, 200
 - RF, 201
 - spectrum analyzer, 213
 - types of, 185
- Input Atten field
 - CDMA Analyzer screen, 161
 - Instrument Configure screen, 200
 - RF Analyzer screen, 200
 - Spectrum Analyzer screen, 200
- input attenuation
 - automatic control, 200
 - manual control, 200
 - setting, 200
- input attenuator
 - oscilloscope, 199, 200
 - spectrum analyzer, 199, 200
- Input Gain field
 - AF Analyzer screen, 200
- input impedance
 - selecting, 284
- Input Level field
 - Signaling Decoder screen, AMPS-TACS mode, 266
 - Signaling Decoder screen, NAMP-NTAC mode, 266
- Input Port field
 - CDMA Analyzer screen, 161
 - Code Domain Analyzer screen, 161
 - Instrument Configure screen, 201
 - RF Analyzer screen, 201
 - Spectrum Analyzer screen, 201
- insertion loss measurements
 - discrete frequency, 87
 - swept, 89
- Inst Config key, 43
- Inst Echo field
 - I/O Configure screen, 237
- Instrument Configure screen
 - Antenna In field, 227
 - Base Freq field, 228
 - Beeper field, 225, 228
 - Chan Space field, 229
 - Date field, 225, 232
 - Duplex Out field, 232
 - Ext Ref In field, 233
 - Firmware field, 233
 - Frame Clock Output field, 234
 - (Gen)-(Anl) field, 235
 - Input Atten field, 200
 - Input Port field, 201
 - Notch Coupl field, 240
 - Range Hold field, 242
 - Ref Select field, 243
 - RF Chan Std field, 244
 - RF Display field, 245
 - RF Gen Volts field, 245
 - RF In/Out field, 246
 - RF Level Offset field, 246
 - Time field, 225
 - User Def Base Freq field, 228
- interactions
 - encoder/decoder, 253
 - high-power/low-power measurements, 221
 - Range Hold and other fields, 242
 - RF generator/analyzer, RF offset, 247
 - twist and pre-emphasis, 279
- Internal field
 - Oscilloscope screen, 201
- inverted data, 272
- IQ
 - CW RF path, 155
- IQ Constellation Diagram, 149
- IQ modulator, 155
- IQ RFOUT
 - connector, 155
- J**
 - JTACS channel standard, 244
 - JTACS signaling encoder/decoder, 253
- K**
 - k1 through k5 keys, 73
 - k1' through k3' keys, 73
- keyboard
 - external, 248
- keys
 - %, 44
 - % delta, 44
 - +/-, 48
 - AF Anl, 43
 - Assign, 74
 - Avg, 68
 - CDMA Anl, 43
 - CDMA Gen, 43
 - Code Dom, 43
 - dB, 44
 - dBm, 44
 - dBuV, 44
 - down-arrow, 64
 - EEX, 48
 - Error Message, 43
 - GHz, 44
 - Help, 43
 - Hi Limit, 65
 - Hz, 44
 - I/O Config, 43
 - Incr (divide-by)10, 64
 - Incr Set, 64
 - Incr x10, 64
 - Inst Config, 43
 - k1 through k5, 73
 - k1' through k3', 73
 - kHz, 44
 - Lo Limit, 65
 - Meter, 59
 - MHz, 44
 - ms, 44
 - mV, 44
 - mW, 44
 - On/Off, 59, 66, 67, 68, 71
 - ppm, 44
 - Printer Config, 43
 - Recall, 70
 - Ref Set, 67
 - Release, 74
 - RF Anl, 43
 - RF Gen, 43
 - s, 44
 - Save, 70
 - Scope, 43
 - Spec Anl, 43
 - up-arrow, 64
 - uV, 44
 - V, 44
 - W, 44
- kHz key, 44
- knob
 - increment setting, 64
- L**
 - level
 - ac, 57
 - AF analyzer, 266
 - data, 262
 - dc, 57
 - delta marker, 113
 - oscilloscope, 203
 - reference for spectrum analyzer, 211
 - supervisory audio tone, 273

- triggering, 278
- Level (div) field
 - Oscilloscope screen, 202
- Level (mask) field
 - Spectrum Analyzer screen, 202
- limits
 - indicators, 65
 - pass/fail, 65
 - removing, 65
 - setting, 65
- Lines/Page field
 - Printer Configure screen, 237
- LISTOPTS, 125
- LO indicator, 65
- Lo Limit key, 65
- Lo Tone field
 - Signaling Decoder screen, DTMF mode, 267
- loss
 - between ANT IN and device-under-test, 227
 - between DUPLEX OUT and device-under-test, 232
 - between RF IN/OUT and device-under-test, 246
- low limit
 - removing, 65
 - setting, 65
- low-level RF power
 - measurements, 183
- Lucent software, 296
- Lvl (Delta Mrkr) field
 - Spectrum Analyzer screen, 202
- Lvl (marker) field
 - Oscilloscope screen, 203
 - Spectrum Analyzer screen, 203
- Lvl (normal marker) field
 - Spectrum Analyzer screen, 203
- Lvl (Ref Mrkr) field
 - Spectrum Analyzer screen, 204
- Lvl field
 - Code Domain Analyzer screen, 161, 162, 168, 169, 175
- M**
- Magnitude Error field
 - CDMA Analyzer screen, 138
 - CDMA Generator screen, 138
- magnitude error measurements, 138
- Main field
 - Code Domain Analyzer screen, 155
- manuals, 18, 295
- Marker field
 - Code Domain Analyzer screen, 155
- Marker Lvl, 162
- Marker To field
 - Spectrum Analyzer screen, 205
- Marker To Peak- field
 - Oscilloscope screen, 204
- Marker To Peak+ field
 - Oscilloscope screen, 204
- markers
 - delta, 113, 207
 - delta frequency, 197
 - delta level, 202
 - level, 203, 204
 - normal frequency, 198
 - normal level, 203
 - oscilloscope, 121, 204
 - oscilloscope, peak-, 204
 - oscilloscope, peak+, 204
 - reference frequency, 198
 - reference, spectrum analyzer, 114, 211
 - spectrum analyzer, 205
 - spectrum analyzer, center frequency, 205
 - spectrum analyzer, next peak, 205
 - spectrum analyzer, peak, 205
 - spectrum analyzer, reference level, 205
 - time, 218
 - triggering, 218
- Mask Beep field
 - Spectrum Analyzer screen, 205
- Mask Type field
 - Spectrum Analyzer screen, 205
- mask, spectrum analyzer, 115
 - displaying, 193
 - frequency, 197
 - level, 202
 - number of points, 185
- mask, spectrum analyzer editing, 194
- Meas Intvl field
 - CDMA Analyzer screen, 162, 163
 - Code Domain Analyzer screen, 162, 163
- Meas Order, 163
- Measure field
 - Signaling Decoder screen, NAMP-NTAC mode, 267
- measurement accuracy
 - gain control for, 199
 - zeroing power for, 221
- measurement arming, 275
- measurement averaging, 68
- measurement disarming, 277
- Measurement field
 - Code Domain Analyzer screen, 163
- measurement limits
 - indicators, 65
 - removing, 65
 - setting, 65
- measurement reference, setting, 67
- measurement settling time, 215
- measurement setups
 - saving and recalling, 70
- measurements
 - absolute power, 154
 - ac level, 57, 179
 - ac level, peak detector, 209
 - ADC FS, 131, 133
 - adjacent channel power, 132
 - AF frequency, 57
 - AM depth, 57
 - audio frequency, 57
 - audio power, 179
 - average power, 131
 - cable fault, 97
 - carrier feedthrough, 136
 - channel power, 132
 - code domain phase, 141, 148
 - code domain power, 139, 142, 146
 - code domain timing, 141, 147
 - dc level, 57, 180
 - deviation, FM, 181
 - distortion, 57, 58, 181
 - EVM, 138
 - fast power, code domain, 141, 147
 - FM demodulation, 57
 - FM deviation, 57, 183
 - frequency error, 134, 182
 - frequency error, DTMF, 265
 - frequency, center, 182
 - frequency, DTMF, 265
 - function generator frequency, 265
 - insertion loss, discrete frequency, 87
 - insertion loss, swept, 89
 - magnitude error, 138
 - phase error, 138
 - relative power, 154
 - return loss, swept, 92
 - RF, 56
 - RF power, 183
 - rho, 133
 - rms potential, 179
 - signal/noise ratio, 58
 - SINAD, 57, 184
 - SNR, 57, 58, 184

- swept gain, 83
- time offset, 135
- transmitter power, 56, 183
- transmitter power, peak, 220
- transmitter power, sample, 220
- voltage, 179
- memory
 - considerations, 72
 - total RAM, 250
- memory card catalog, 106
- memory overflow error, 72
- message
 - beeper alert, 228
 - displaying, 225
 - error, 300
 - IBASIC error, 236
 - operation, 304
 - output, FOCC, 274
 - output, FVC, 274
 - turn off, 225
 - types of, 300
- Message field
 - Signaling Encoder screen, AMPS-TACS mode, 269
 - Signaling Encoder screen, NAMP-NTAC mode, 270
- Message field (FOCC)
 - Signaling Encoder screen, AMPS-TACS mode, 268
 - Signaling Encoder screen, NAMP-NTAC mode, 268
- Message/DST field
 - Signaling Encoder screen, NAMP-NTAC mode, 270
- meter
 - end points, 59
 - on/off, 59
 - scale interval, 59
- Meter key, 59
- MHz key, 44
- pre-emphasis
 - 750, 273
- uV (microvolts) key, 44
- Mod In To field
 - RF Generator screen, 206
- Mode field
 - I/O Configure screen, 237
 - Signaling Decoder screen, AMPS-TACS mode, 271
 - Signaling Decoder screen, DTMF mode, 271
 - Signaling Decoder screen, Func Gen mode, 271
 - Signaling Decoder screen, NAMP-NTAC mode, 271
 - Signaling Encoder screen, AMPS-TACS mode, 271
- Modem
 - Signaling Encoder screen, DTMF mode, 271
 - Signaling Encoder screen, Func Gen mode, 271
 - Signaling Encoder screen, NAMP-NTAC mode, 271
- Model field
 - Printer Configure screen, 238
- modem, 239
 - configuration, 238, 239
- Modem Configuration field
 - Modem Configure screen, 238
- Modem Configure screen
 - Call field, 229
 - Command Escape Character field, 231
 - Connection Timeout field, 231
 - Decimal Equivalent field
 - See Command Escape Character, 231
 - Holdoff Delay field, 236
 - Incoming Call Security field, 237
 - Modem Configuration field, 238
- Modem
 - Initialization/Configuration field, 239
 - Modem Mode field, 239
 - Number to Call field, 240
 - Password field, 241
 - Retrys field, 244
 - Status field, 249
- Modem
 - Initialization/Configuration field
 - Modem Configure screen, 239
- Modem Mode field
 - Modem Configure screen, 239
- modulation
 - external AM, 206
 - external, FM, 206
 - external, input, 206
 - input, 206
 - input, coupling, 196
 - OQPSK, 159
 - QPSK, 159
 - sensitivity, input, 206
- monitor, external, 295
- ms key, 44
- mV key, 44
- mW key, 44
- N**
 - names
 - printout, 241
 - registers, 71
 - NAMPS channel standard, 244
 - NAMPS-NTACS signaling decoder, 253
 - See Also Signaling Decoder screen, NAMP-NTAC mode
 - NAMPS-NTACS signaling encoder, 253
 - See Also Signaling Encoder screen, NAMP-NTAC mode
 - negative edge triggering, 202
 - Next Peak Marker To field, 205
 - No Pk/Avg field
 - Spectrum Analyzer screen, 206
 - Norm/Delta field
 - Spectrum Analyzer screen, 207
 - Normalize field
 - Spectrum Analyzer screen, 207
 - Nortel software, 296
 - Notch
 - oscilloscope filters, 121
 - Notch Coupl field
 - Instrument Configure screen, 240
 - used with variable notch, 208
 - notch filter
 - gain, 208
 - variable, 208
 - Notch Freq field
 - AF Analyzer screen, 208
 - Notch Gain field
 - AF Analyzer screen, 208
 - NTACS channel standard, 244
 - Num Avgs field
 - Code Domain Analyzer screen, 163
 - Num of Bits field
 - Signaling Decoder screen, AMPS-TACS mode, 271
 - Signaling Decoder screen, NAMP-NTAC mode, 271
 - # of Frames field, 157
 - Number to Call field
 - Modem Configure screen, 240
 - numbers
 - decimal format, 48
 - hexadecimal format, 48
 - negative, 48
 - scientific notation, 48
- O**
 - Off Time field
 - Signaling Encoder screen, DTMF mode, 271
 - offset
 - frequency, receiver/transmitter, 235

- frequency, RF
 - generator/analyzer, 235
- frequency, tracking generator, 208
- RF generator/analyzer, 247
- RF level, 246
- setting, frequency, 69
- vertical, oscilloscope, 203, 222
- Offset Freq (Tracking Gen) field
 - Spectrum Analyzer screen, 208
- off-the-air measurements, 201, 283
- Ofs Trnsfer field
 - Code Domain Analyzer screen, 164
- On Time field
 - Signaling Encoder screen, DTMF mode, 272
- On/Off key, 59, 66, 67, 68, 71
- operating basics, 51
- operation messages, 304
- options, for Test Set, 296
- options, Test Set, 125
- OQPSK modulation, 159
- Originate call (modem), 229
- origination attempts (modem), 244
- oscilloscope
 - description of, 119
 - features, 119
 - filters, block diagram of, 119
 - filters, selection of, 121
 - input attenuator, 199, 200
 - inputs, block diagram of, 119
 - inputs, selection of, 120
 - level, markers, 203
 - marker types, 204
 - markers, 121
 - markers, level, 203
 - resolution, 214
 - scale, 210
 - signal source, 214
 - squelch effects, 217
 - triggering, 121
- oscilloscope interference
 - autoranging, 199, 200
- Oscilloscope screen
 - Auto/Norm field, 190
 - Cont/Single field, 192
 - Controls field, 192
 - Internal field, 201
 - Level (div) field, 202
 - Lvl (marker) field, 203
 - Marker To Peak- field, 204
 - Marker To Peak+ field, 204
 - Output Port field, 209
 - Pos/Neg field, 202
 - Position field, 210
 - Reset field, 212
 - Time (marker) field, 218
 - Time/div field, 218
 - Trig-Delay field, 219
 - Vert Offset field, 222
 - Vert/div field, 221
- output
 - coupling, 190
 - F0CC, 274
 - FVC, 274
 - RF, 209, 210
 - tracking generator, 210
- Output Port field
 - CDMA Generator screen, 164
 - Oscilloscope screen, 209
 - RF Generator screen, 209
 - Spectrum Analyzer screen, 209
- overpower
 - at RF IN/OUT connector, 201
 - damage, at ANT IN, 56
 - damage, at ANT IN connector, 183, 213
 - damage, at DUPLEX OUT, 209
 - warning, 201
- overpower damage, 41
- overview of operation, 51
- P**
- PARALLEL PORT 15 connector, 289
- PARALLEL PORT 16 connector, 289
- parallel port pin assignments, 289
- parity bits, 264, 269, 270
- Parity field
 - I/O Configure screen, 240
- pass/fail limits, 65
- password, 123
- Password field
 - Modem Configure screen, 241
- PC card catalog, 106
- PCS
 - Korean channel standard, 244
 - North American channel standard, 244
- Peak
 - Marker To field, 205
 - TX Pwr Meas field, 220
- peak
 - hold, spectrum analyzer, 206
- peak-
 - oscilloscope marker, 204
- peak detector, 193, 209
 - signal source, 209
- peak units, 275
- peak+
 - oscilloscope marker, 204
 - % delta key, 44
 - % key, 44
- Phase Error field
 - CDMA Analyzer screen, 138
 - CDMA Generator screen, 138
- phase error measurements, 138
- Phase/div field
 - Code Domain Analyzer screen, 164, 172
- Phse field
 - Code Domain Analyzer screen, 165
- Pk Det To field
 - AF Analyzer screen, 209
- Pk Hold field
 - Spectrum Analyzer screen, 206
- PN Incrment field
 - CDMA Analyzer screen, 165
- PN Offset field
 - CDMA Analyzer screen, 165, 166
- PN Setup field
 - Code Domain Analyzer screen, 155
- Polarity field
 - Signaling Decoder screen, AMPS-TACS mode, 272
 - Signaling Decoder screen, NAMP-NTAC mode, 272
 - Signaling Encoder screen, AMPS-TACS mode, 272
 - Signaling Encoder screen, NAMP-NTAC mode, 272
- Port/Sweep (Tracking Gen)
 - Spectrum Analyzer screen, 210
- Pos/Neg field
 - Oscilloscope screen, 202
- Position field
 - Oscilloscope screen, 210
- positive edge
 - triggering, 202
- power
 - 1.23 MHz channel, 132
 - 30 kHz channel, 132
 - adjacent channel, 132
 - average, 131
 - channel, 132
 - code domain, 139, 142, 146
 - code domain, fast, 141, 147
 - transmitter, 56
 - zero reference, 221
- power cables, 25
- power meter
 - zeroing, 221
- power-on settings
 - changing, 71

- ppm key, 44
- Pre-Emp field
 - Signaling Encoder screen, DTMF mode, 273
- pre-emphasis
 - bypassing, 273
- preset state
 - changing, 72
 - default, 72
- print
 - screens, 226
- Print Title field
 - Printer Configure screen, 241
- printer
 - connecting, 241
 - model, 238
- Printer Adrs field
 - Printer Configure screen, 241
- Printer Config key, 43
- Printer Configure screen
 - Abort Print field, 227
 - FF at End field, 233
 - FF at Start field, 233
 - Lines/Page field, 237
 - Model field, 238
 - Print Title field, 241
 - Printer Adrs field, 241
 - Printer Port field, 241
- Printer Port field
 - Printer Configure screen, 241
- printing
 - aborting, 227
 - form feed, 233
 - lines per page, 237
 - printer model, 238
 - selecting HP-IB address, 241
 - selecting printer port, 241
 - title, 241
- Pwr Gain field
 - CDMA Analyzer screen, 166
- Pwr Intvl field
 - CDMA Analyzer screen, 167
- Pwr Ref, 167
- Pwr Scale field
 - Code Domain Analyzer screen, 167
- Pwr Zero field
 - CDMA Analyzer screen, 168
- Q**
- Q BASEBAND OUT connector, 285
- Q Power Level, 168
- QPSK modulation, 159
- QSPK Modulation, 142
- Qual Event field
 - CDMA Analyzer screen, 168
- Code Domain Analyzer screen, 168
- R**
- radio standard
 - AMPS, 253
 - JTACS, 253
 - NAMPS, 253
 - NTACS, 253
 - TACS, 253
- radio test software, 296
- RAM
 - back-up batteries, 75
 - clearing, 124
 - disk allocations, 122
 - loss of data, 75
 - total available, 250
 - total installed, 122
- RAM_MANAGER, IB_UTIL ROM program, 124
- RAM_USAGE, IB_UTIL ROM program, 122
- ramp wave
 - function generator, 280
- random
 - data source, 157
- Range Hold field
 - Instrument Configure screen, 242
- recall
 - instrument setups, 70
 - saved register with hardware change, 72
 - settings, 70
- Recall key, 70
- RECC, 253
 - decoding, AMPS-TACS/NAMPS-NTACS, 261
- RECC Data field
 - Signaling Decoder screen, NAMP-NTAC mode, 273
- Ref Level
 - Marker To field, 205
- Ref Level field
 - Spectrum Analyzer screen, 211
- Ref Mrkr field
 - Spectrum Analyzer screen, 211
- Ref Select field
 - Instrument Configure screen, 243
- Ref Set key, 67
- reference
 - external input, 287
 - external output, 282
 - level, spectrum analyzer, 211
 - setting, 67, 203
 - transmitter power, zero, 221
- Reference indicators, 67
- reference markers, 204
- reference markers, spectrum analyzer, 114, 211
- registers
 - clearing, 71
 - naming, 71
- relative power measurements, 154
- release
 - global user key assignment, 74
- Release key, 74
- Remote Mode field
 - I/O Configure screen, 243
- remote operation
 - mode, 237
 - squelch effects, 217
- remove high/low limits, 65
- remove pass/fail limits, 65
- remove register contents, 71
- replot data files, 102
- Reset field
 - Oscilloscope screen, 212
- resolution
 - bandwidth, spectrum analyzer, 111
 - oscilloscope, 214
- resolution bandwidth, spectrum analyzer, 191
- Retrys field
 - Modem Configure screen, 244
- return loss measurements, swept, 92
- reverse control channel. *See* RECC
- reverse link, 152
- Reverse Link Pilot, 142
- reverse RF power, 209
- reverse voice channel. *See* RVC
- revision number
 - firmware, 233
- RF Analyzer screen
 - AC Level field, 179
 - AF Freq field, 180
 - AM Depth field, 179
 - Amplitude field, 189
 - Auto Zero field, 191
 - Distn field, 181
 - FM Deviation field, 181, 183
 - Frequency Error field, 182
 - Frequency field, 182
 - IF Filter field, 199
 - Input Atten field, 200
 - Input Port field, 201
 - RF Channel field, 212
 - RF Cnt Gate field, 212

- Sensitivity field, 214
 - SINAD field, 184
 - SNR field, 184
 - Squelch field, 217
 - Tune Freq field, 220
 - TX Power field, 183
 - TX Pwr Meas field, 220
 - TX Pwr Zero field, 221
 - RF Anl key, 43
 - RF Chan Std field
 - Instrument Configure screen, 244
 - RF Channel field
 - CDMA Analyzer screen, 170
 - CDMA Generator screen, 170
 - Code Domain Analyzer screen, 170
 - RF Analyzer screen, 212
 - RF Cnt Gate field
 - RF Analyzer screen, 212
 - RF counter
 - sampling, 212
 - RF Display field
 - Instrument Configure screen, 245
 - RF Gen Freq field
 - CDMA Generator screen, 170
 - RF Generator screen, 213
 - Spectrum Analyzer screen, 213
 - RF Gen key, 43
 - RF Gen Volts field
 - Instrument Configure screen, 245
 - RF generator
 - amplitude, 189
 - frequency, 213
 - output, 210
 - output port, 209
 - RF Generator screen
 - AF Freq field, 180
 - AFGen1 Freq field, 186
 - AFGen1 To field, 187
 - AFGen2 Freq field, 187
 - AFGEN2 To field, 188
 - AM Depth field, 179
 - Amplitude field, 189
 - Atten Hold field, 189
 - Audio Out field, 190
 - DC FM Zero field, 196
 - Distn field, 181
 - FM Coupling field, 196
 - FM Deviation field, 181, 183
 - Frequency Error field, 182
 - Frequency field, 182
 - Mod In To field, 206
 - Output Port field, 209
 - RF Gen Freq field, 213
 - SINAD field, 184
 - SNR field, 184
 - RF In/Ant field
 - Code Domain Analyzer screen, 170
 - Spectrum Analyzer screen, 213
 - RF IN/OUT connector
 - connecting to, 41
 - description, 290
 - for measuring high-power devices, 210
 - for measuring transmitter power, 201
 - for RF measurements, 201
 - for testing transceivers, 209
 - gain at, 246
 - input attenuation, 200
 - loss at, 246
 - power measured at, 183
 - RF In/Out field
 - Instrument Configure screen, 246
 - RF input, 161, 170
 - selecting port, 201
 - RF Level Offset field
 - Instrument Configure screen, 246
 - RF measurements, 56
 - RF offset
 - setting, 69
 - RF Offset field
 - Configure Instrument screen, 247
 - RF output
 - selecting port, 209, 210
 - RF power
 - exceeding limits, 201
 - measurements, 183
 - zero reference, 221
 - RFTOOLS
 - cable fault measurements, 97
 - catalog memory card, 106
 - discrete frequency insertion loss measurements, 87
 - replot data files, 102
 - SA Self Calibration ON/OFF, 105
 - swept gain measurements, 83
 - swept insertion loss measurements, 89
 - swept return loss measurements, 92
 - transfer stored data, 104
 - Rho field
 - CDMA Analyzer screen, 133
 - CDMA Generator screen, 133
 - rho measurements, 133
 - rms detector, 193
 - rms potential
 - measurements, 179
 - rms units, 275
 - ROM program
 - SERVICE4. *See the Agilent 8935 Assembly Level Repair Manual.*
 - ROM programs
 - COPY_PL, 122
 - DEMO, 126
 - FILE_XFER, 122
 - IB_UTIL, 122
 - LISTOPTS, 125
 - RAM_MANAGER, 124
 - RAM_USAGE, 122
 - RFTOOLS, 79
 - SECURE_IT, 123
 - ST_PLT, 127
 - RVC, 253
 - decoding, AMPS-TACS/NAMPS-NTA CS, 261
- S**
- s, 273
 - s key, 44
 - safety warnings and cautions, 16
 - Sample
 - TX Pwr Meas field, 220
 - sampling
 - AF counter, 186
 - RF counter, 212
 - Samsung software, 296
 - SAT Freq field
 - Signaling Encoder screen, AMPS-TACS mode, 273
 - Signaling Encoder screen, NAMP-NTAC mode, 273
 - SAT Level field
 - Signaling Encoder screen, AMPS-TACS mode, 273
 - Signaling Encoder screen, NAMP-NTAC mode, 273
 - save
 - instrument setups, 70
 - settings, 70
 - Save B field
 - Spectrum Analyzer screen, 207
 - Save key, 70
 - save register memory allocations, 122
 - Save/Recall field
 - I/O Configure screen, 247
 - saving instrument setups, 70
 - saving settings, 70
 - scale

- for oscilloscope, 210
 - scientific notation
 - entering numbers, 48
 - scope
 - horizontal sweep, 218
 - level, markers, 203
 - markers, 203
 - vertical offset, 222
 - Scope key, 43
 - SCOPE MONITOR OUTPUT
 - connector, 290
 - Scope To field
 - AF Analyzer screen, 214
 - scope. *See* oscilloscope.
 - screen dump, 226
 - screens
 - printing, 226
 - SECURE_IT, IB_UTIL ROM
 - program, 123
 - securing files, 123
 - security, modem connection, 237, 241
 - Send DSAT field
 - Signaling Encoder screen, AMPS-TACS mode, 274
 - Signaling Encoder screen, NAMP-NTAC mode, 274
 - Send field
 - Signaling Encoder screen, AMPS-TACS mode, 274
 - Signaling Encoder screen, DTMF mode, 274
 - Signaling Encoder screen, NAMP-NTAC mode, 274
 - Send Filler field
 - Signaling Encoder screen, AMPS-TACS mode, 274
 - Signaling Encoder screen, NAMP-NTAC mode, 274
 - Send Mode field
 - Signaling Encoder screen, AMPS-TACS mode, 275
 - Signaling Encoder screen, DTMF mode, 275
 - Signaling Encoder screen, NAMP-NTAC mode, 275
 - Send to Hardware
 - Modem Configuration, 238
 - sensitivity
 - adverse effects on
 - measurements, 214, 215
 - ANT IN, 214, 215
 - modulation input, 206
 - Sensitivity field
 - RF Analyzer screen, 214
 - Spectrum Analyzer screen, 215
 - Serial Baud field
 - I/O Configure screen, 248
 - serial data word
 - bits, 231
 - Serial In field
 - I/O Configure screen, 248
 - Serial No. field
 - Configure Instrument screen, 248
 - SERIAL PORT 10 connector, 291
 - SERIAL PORT 11 connector, 291
 - SERIAL PORT 9 connector, 291
 - Serial Port field
 - I/O Configure screen, 249
 - serial port pin assignments, 291
 - SERVICE4. *See* the Agilent 8935 Assembly Level Repair Manual.
 - settings
 - base, 72
 - beeper volume, 225
 - changing, field, 42
 - date, 225
 - default, 71, 72
 - power-on, 71
 - recalling, 70
 - saving, 70
 - time, 225
 - Settling field
 - AF Analyzer screen, 215
 - settling time
 - AF measurements, 215
 - setups
 - recalling, 70
 - saving, 70
 - signal level
 - data, 262
 - signal to noise ratio, 57
 - signal/noise ratio
 - measurements, 58
 - Signaling Decoder screen
 - AMPS-TACS mode
 - AF Anl In field, 185
 - DTMF mode
 - AF Anl In field, 185
 - Func Gen mode
 - AF Anl In field, 185
 - NAMP-NTAC mode
 - AF Anl In field, 185
 - Signaling Decoder screen, AMPS-TACS mode
 - Arm Meas field, 260
 - Channel field, 261
 - Data (hex) field, 261
 - Data Rate field, 262
 - Gate Time field, 265
 - Input Level field, 266
 - Mode field, 271
 - Num of Bits field, 271
 - Polarity field, 272
 - Single/Cont field, 275
 - Standard field, 276
 - Status field, 276
 - Stop Meas field, 277
 - Trig Level field, 278
 - Trigger Pattern (bin) field, 278
- Signaling Encoder screen,
 - AMPS-TACS mode
 - AFGen2 To, 188
 - B/I Delay field, 260
 - Bursts field, 260
 - Busy/Idle field, 261
 - Channel field, 261
 - Data Level field, 262
 - Data Rate field, 262
 - Filler (FOCC) field, 264
 - Message (FOCC) field, 268
 - Message (FVC) field, 269
 - Gen mode
 - Arm Meas field, 260
 - Frequency field, 265
 - Mode field, 271
 - Status field, 276
 - Stop Meas field, 277
- Signaling Decoder screen, NAMP-NTAC mode
 - Arm Meas field, 260
 - Channel field, 261
 - Data (hex) field, 261
 - Data Rate field, 262
 - DSAT field, 256, 263
 - DSAT/DST (hex) field, 263
 - Gate Time field, 265
 - Input Level field, 266
 - Measure field, 267
 - Mode field, 271
 - Num of Bits field, 271
 - Polarity field, 272
 - RECC Data field, 273
 - Single/Cont field, 275
 - Standard field, 276
 - Stop Meas field, 277
 - Trig Level field, 278
 - Trigger Pattern (bin) field, 278

- Mode field, 271
- Polarity field, 272
- SAT Freq field, 273
- SAT Level (FVC) field, 273
- Send DSAT field, 274
- Send field, 274
- Send Filler field, 274
- Send Mode field, 275
- Standard field, 276
- Status field, 276
- Stop field, 276
- Stop Filler field, 277
- Signaling Encoder screen, DTMF mode
 - AFGen2 To, 188
 - Bursts field, 260
 - Mode field, 271
 - Off Time field, 271
 - On Time field, 272
 - Pre-Emp field, 273
 - Send field, 274
 - Send Mode field, 275
 - Standard field, 276
 - Status field, 276
 - Stop field, 276
 - Symbol Frequencies field, 277
 - Twist field, 279
- Signaling Encoder screen, Func Gen mode
 - AFGen2 To, 188
 - Mode field, 271
 - Sine Units field, 275
 - Status field, 276
 - Waveform field, 280
- Signaling Encoder screen, NAMP-NTAC mode
 - AFGen2 To, 188
 - B/I Delay field, 260
 - Bursts field, 260
 - Busy/Idle field, 261
 - Channel field, 261
 - Data Level field, 262
 - Data Rate field, 262
 - Filler (FOCC) field, 264
 - Message (FOCC) field, 268
 - Message (FVC) field, 270
 - Message/DST field, 270
 - Mode field, 271
 - Polarity field, 272
 - SAT Freq field, 273
 - SAT Level (FVC) field, 273
 - Send DSAT field, 274
 - Send field, 274
 - Send Filler field, 274
 - Send Mode field, 275
 - Standard field, 276
 - Stop DSAT field, 277
 - Stop field, 276
 - Stop Filler field, 277
- signaling format
 - AMPS, 253
 - JTACS, 253
 - NAMPS, 253
 - NTACS, 253
 - TACS, 253
- simultaneous AM and FM (not allowed), 187, 188
- SINAD
 - measurements, 184
 - measurements, amplifier, 208
 - measurements, variable notch filter, 208
- SINAD field
 - AF Analyzer screen, 184
 - RF Analyzer screen, 184
 - RF Generator screen, 184
- SINAD measurements, 57
- Sine Units field, 275
- sine wave, 280
- Single, 152
- Single/Cont field
 - Data Source, 157
 - Signaling Decoder screen, AMPS-TACS mode, 275
 - Signaling Decoder screen, NAMP-NTAC mode, 275
- SNR
 - measurements, 58, 184
- SNR field
 - AF Analyzer screen, 184
 - RF Analyzer screen, 184
 - RF Generator screen, 184
- SNR measurements, 57
- software
 - automated testing, 296
 - Lucent, 296
 - Nortel, 296
 - Samsung, 296
- source
 - oscilloscope, 214
 - peak detector, 209
- span
 - effect on AF analyzer, 216
 - spectrum analyzer, 111
- Span field
 - Spectrum Analyzer screen, 216
- speaker
 - ALC, 216
 - disabling, 216
 - volume control, 216
- Speaker ALC
 - AF Analyzer screen, 216
- Speaker Vol field
 - AF Analyzer screen, 216
- Spec Anl key, 43
- spectrum analyzer
 - calibration, 111
 - calibration, self, 105
 - input attenuator, 199, 200
 - input port, 213
 - interference when autoranging, 199, 200
 - markers, 205
 - markers, delta, 197, 202
 - markers, normal, 198, 203
 - markers, reference, 198
 - measuring low-level RF power, 183
 - reference markers, 204
 - resolution bandwidth, 111
 - span, 111
 - squelch effects, 217
 - sweep rate, 111
 - traces, 207
 - use of, 183
- spectrum analyzer bandwidth, 191
- spectrum analyzer mask, 115
 - displaying, 193
 - editing, 194
 - fixed, 205
 - frequency, 197
 - level, 202
 - number of points, 185
 - relative, 205
- Spectrum Analyzer screen
 - #Pts, 185
 - A Only/A-B field, 207
 - Amplitude field, 189
 - Avg 1-100 field, 206
 - BW= field, 191
 - Center Freq field, 191
 - Controls field, 192
 - Display field, 193
 - Edit Mask field, 194
 - EditPt field, 194
 - Freq (Delta Mrkr) field, 197
 - Freq (mask) field, 197
 - Freq (normal marker) field, 198
 - Freq (Ref Mrkr) field, 198
 - Input Atten field, 200
 - Input Port field, 201
 - Level (mask) field, 202
 - Lvl (Delta Mrkr) field, 202
 - Lvl (marker) field, 203
 - Lvl (normal marker) field, 203
 - Lvl (Ref Mrkr) field, 204
 - Marker To field, 205
 - Mask Beep field, 205
 - Mask Type field, 205
 - No Pk/Avg field, 206

- Normalize field, 207
 - Offset Freq (Tracking Gen) field, 208
 - Output Port field, 209
 - Pk Hold field, 206
 - Port/Sweep (Tracking Gen), 210
 - Ref Level field, 211
 - RF Gen Freq field, 213
 - RF In/Ant field, 213
 - Save B field, 207
 - Sensitivity field, 215
 - Span field, 216
 - Track/Fixed field, 218
 - Spectrum Analyzer screen
 - Norm/Delta field, 207
 - square wave, 280
 - squelch
 - effects on HP-IB operation, 217
 - effects on remote operation, 217
 - effects on spectrum analyzer, 217
 - fixed level, 217
 - manual control, 217
 - off, 217
 - using attenuator hold, 189
 - Squelch field
 - RF Analyzer screen, 217
 - SSB Demod
 - AF Anl In, 57
 - oscilloscope input, 120
 - ST_PLT, 127
 - Standard field
 - Signaling Decoder screen, AMPS-TACS mode, 276
 - Signaling Decoder screen, DTMF mode, 276
 - Signaling Decoder screen, NAMP-NTAC mode, 276
 - Signaling Encoder screen, AMPS-TACS mode, 276
 - Signaling Encoder screen, DTMF mode, 276
 - Signaling Encoder screen, NAMP-NTAC mode, 276
 - Start Frame field, 157
 - status
 - control, 276
 - idle, 276
 - working, 276
 - Status field
 - Modem Configure screen, 249
 - Signaling Decoder screen, AMPS-TACS mode, 276
 - Signaling Decoder screen, DTMF mode, 276
 - Signaling Decoder screen, NAMP-NTAC mode, 276
 - Signaling Encoder screen, AMPS-TACS mode, 276
 - Signaling Encoder screen, DTMF mode, 276
 - Signaling Encoder screen, NAMP-NTAC mode, 276
 - stop bit, 249
 - Stop DSAT field
 - Signaling Encoder screen, NAMP-NTAC mode, 277
 - Stop field
 - Signaling Encoder screen, AMPS-TACS mode, 276
 - Signaling Encoder screen, DTMF mode, 276
 - Signaling Encoder screen, NAMP-NTAC mode, 276
 - Stop Filler field
 - Signaling Encoder screen, AMPS-TACS mode, 277
 - Signaling Encoder screen, NAMP-NTAC mode, 277
 - Stop Length field
 - I/O Configure screen, 249
 - Stop Meas field
 - Signaling Decoder screen, AMPS-TACS mode, 277
 - Signaling Decoder screen, DTMF mode, 277
 - Signaling Decoder screen, Func Gen mode, 277
 - Signaling Decoder screen, NAMP-NTAC mode, 277
 - support, 297
 - sweep
 - frequency range, tracking generator, 216
 - oscilloscope, 218
 - rate, spectrum analyzer, 111
 - time per division, 218
 - tracking generator, 210
 - swept gain measurements, 83
 - swept return loss measurements, 92
 - Sym field
 - Signaling Decoder screen, DTMF mode, 277
 - symbol
 - for tone sequence, 277
 - frequency, 277
 - Symbol Frequencies field
 - Signaling Encoder screen, DTMF mode, 277
 - sync word delay, 261
- ## T
- TACS channel standard, 244
 - talk & listen, 237
 - Threshold field
 - Code Domain Analyzer screen, 171
 - time
 - markers, 218
 - Time (marker) field
 - Oscilloscope screen, 218
 - time and date, 225
 - Time field
 - Code Domain Analyzer screen, 172
 - Configure Instrument screen, 250
 - Instrument Configure screen, 225
 - Time Offset field
 - CDMA Analyzer screen, 135
 - CDMA Generator screen, 135
 - Code Domain Analyzer screen, 173
 - time offset measurements, 135
 - Time/div field
 - Oscilloscope screen, 218
 - timebase
 - decoder, 252
 - external output, 282
 - timeout, modem connection, 231
 - title
 - for printout, 241
 - TmOfs field
 - Code Domain Analyzer screen, 135, 173
 - tone length, DTMF encoder, 272
 - Total RAM field
 - Configure Instrument screen, 250
 - trace
 - comparison, spectrum analyzer, 207
 - spectrum analyzer, 207
 - Track/Fixed field
 - Spectrum Analyzer screen, 218
 - tracking generator
 - enabling, 218
 - frequency, 191
 - frequency offset, 208
 - output, 210
 - output port, 210
 - sweep, 210
 - training, 297
 - transmitter power, 56
 - measurements, 183
 - Peak, 220
 - Sample, 220

- zero reference, 221
- triangle wave, 280
- Trig Event field
 - CDMA Analyzer screen, 174
 - Code Domain Analyzer screen, 174
- Trig Level field
 - Signaling Decoder screen, AMPS-TACS mode, 278
 - Signaling Decoder screen, NAMP-NTAC mode, 278
- Trig-Delay field
 - Oscilloscope screen, 219
- Trigger field
 - Code Domain Analyzer screen, 155
- Trigger Pattern (bin) field
 - Signaling Decoder screen, AMPS-TACS mode, 278
 - Signaling Decoder screen, NAMP-NTAC mode, 278
- TRIGGER QUALIFIER IN connector, 291
- TRIGGER/QUALIFIER IN connector, 169
- triggering
 - automatic, 190
 - bit position, 278
 - continuous, 192
 - decoder,
 - AMPS-TACS/NAMPS-NTA CS, 275
 - external, oscilloscope, 201
 - external, oscilloscope connector, 288
 - gate time, 265
 - input level, 266
 - internal, 202
 - internal, oscilloscope, 201
 - level, 190, 278
 - negative edge, 202
 - oscilloscope, 121
 - positive edge, 202
 - signal, 190
 - source, oscilloscope, 201
 - time, 218
- Tune Freq, 174
- Tune Freq field
 - RF Analyzer screen, 220
- tuning
 - channel versus frequency, 60
 - channel, automatic, 245
- turn off code
 - frequency, 262
- turning off squelch, 217
- twist
 - recommended settings, 279
 - twist and pre-emphasis interactions, 279
- Twist field
 - Signaling Encoder screen, DTMF mode, 279
- TX Power field
 - AF Analyzer screen, 183
 - RF Analyzer screen, 183
- TX Pwr Meas field
 - RF Analyzer screen, 220
- TX Pwr Zero
 - AF Analyzer screen, 221
- TX Pwr Zero field
 - RF Analyzer screen, 221
- type bits, 264, 269
- U**
 - U.S. Call Center, assistance, 297
- units
 - peak, 275
 - rms, 275
 - universal noise, 280
- User Def Base Freq field
 - Configure Instrument screen, 228
- user keys
 - assigning global, 74
 - assigning, local, 74
 - clearing, global assignment, 74
 - deleting, global assignment, 74
 - explanation, 73
 - global, assignment, 74
 - global, defined, 73
 - local, defined, 73
 - preassigned, 73
 - releasing, global assignment, 74
 - releasing, local assignment, 74
 - setting, global, 74
- utilities
 - catalog memory card, 106
 - data collection, transferring data, 104
 - replot data files, 102
 - spectrum analyzer self calibration, 105
- uV key, 44
- V**
 - V key, 44
- variable frequency notch filter, 208
- version number
 - firmware, 233
- Vert Offset field
 - Oscilloscope screen, 222
- Vert/div field
 - Oscilloscope screen, 221
- vertical offset
 - oscilloscope, 203, 222
- vertical sensitivity
 - oscilloscope, 221
- video averaging
 - spectrum analyzer, 206
- VIDEO OUT connector, 292
- voltage
 - measurements, 179
 - RF, across 50 ohm load, 245
 - RF, emf (open circuit), 245
- volume
 - beeper, 225, 228
 - internal speaker, 216
- W**
 - W key, 44
 - Waiting modem status, 249
 - Walsh Chan field
 - Code Domain Analyzer screen, 175
 - Walsh Order, 169, 175
 - waveform
 - dc, 280
 - Gaussian noise, 280
 - selecting, 280
 - sine, 280
 - square, 280
 - triangle, 280
 - universal noise, 280
 - Waveform field
 - Signaling Encoder screen, Func Gen mode, 280
 - waveform generator, 259
 - web site
 - Hewlett-Packard Test and Measurement Organization, 297
 - word sync bits, 264, 269
 - WS Delay, 261
 - www.tmo.hp.com, 297
- X**
 - Xon/Xoff, 234
- Z**
 - zero reference
 - transmitter power, 221
 - Zeroes

data source, 157
zeroing
 dc bias, 196
 power meter, 221