

AEG-Electrolux

**viva spin 7418, 7440, 7460, 7480,
7481, 7485, 7486, 1800 TRIO**

Bodenstaubsauger
Vacuum Cleaner

Aspirateur traîneau

Vloerstofzuiger

Aspirapolvere

Aspirado de polvo

Aspirador

Ηλεκτρική σκούπα

Porszívó

Odkurzacz

Usisavač

Podlahový vysávač

Vysavač prachu

Aspirator

Navodila

Пылесос

Elektrikli süpürge

Gebrauchsanweisung

Operating Instructions

Mode d'emploi

Gebruiksaanwijzing

Istruzioni per l'uso

Instrucciones de uso

Instrucções de utilização

Οδηγίες χρήσεως

Használati útmutató

Instrukcja obsługi

Upute za uporabu

Návod na používanie

Návod k použití

Cuprins

Navodila za uporabo

Инструкция по эксплуатации

Kullanma talimatlar

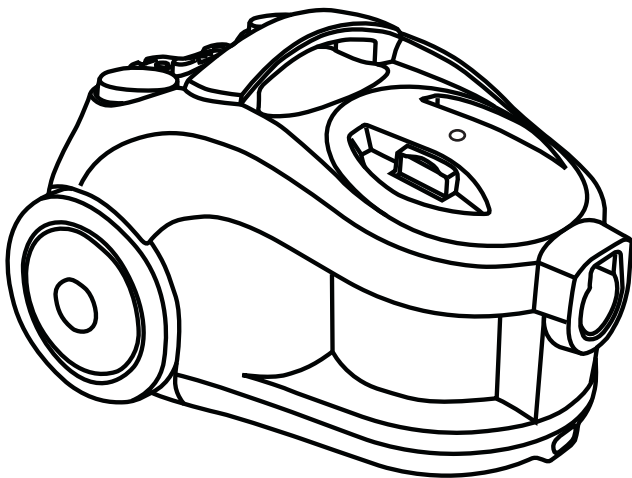

PERFEKT IN FORM UND FUNKTION

AEG

 **Electrolux**

Sehr geehrte Kundin, sehr geehrter Kunde, 6	Gentile cliente..... 18
Ausstattung.....6	Le caratteristiche di viva spin..... 18
Zubehör.....6	Accessori dell'aspirapolvere viva spin..... 18
Sicherheitshinweise.....6	Per la vostra sicurezza..... 18
Inbetriebnahme.....7	Per cominciare..... 19
Die besten Ergebnisse erzielen.....7	Per ottenere i migliori risultati..... 19
Ausleeren des Staubbehälters..... 7	Svuotare il contenitore della polvere..... 19
Auswechseln / Reinigen der Filter.....7	Pulizia dei filtri.....19
Reinigen des Cartridge Rundfilters.....8	Pulizia del filtro a cartuccia.....20
Wechseln des Abluffilters..... 8	Pulizia del filtro in uscita..... 20
Fehlersuche und -behebung.....8	Diagnosi dei guasti..... 20
Dear Customer.....9	Estimado cliente..... 21
Features.....9	Las características de su viva spin.....21
Accessories..... 9	Accesorios para su viva spin.....21
Safety instructions.....9	Para garantizar su Seguridad.....21
Getting Started.....9	Listo para comenzar..... 21
Getting the best results..... 10	Cómo obtener los mejores resultados.....22
Removing the contents of the dust container..... 10	Ver contenido del depósito de polvo..... 22
Cleaning the filters..... 10	Limpia los filtros.....22
Cleaning the cartridge filter.....10	Limpieza del filtro cartucho.....22
Cleaning the exhaust filter..... 11	Limpia el filtro de salida de aire / microfiltro:..... 23
Troubleshooting..... 11	Reparación de averías.....23
Chère Cliente, Cher Client,.....12	Instruções de utilização.....24
Accessoires..... 12	Características.....24
Votre viva spin possède les caractéristiques suivantes..... 12	Acessórios.....24
Accessoires..... 12	Certifique-se da sua Segurança.....24
Assurer votre sécurité.....12	Preparação Inicial.....24
Mise en marche..... 13	Como conseguir os melhores resultados...25
Comment obtenir les meilleurs résultats.... 13	Limpar o conteúdo do contentor do pó.....25
Comment vider le conteneur à poussière.. 13	Limpar os filtros..... 25
Nettoyage des filtres.....13	Limpar a cassette filtro..... 25
Le remplacement de la cartouche filtrante. 14	Limpar o filtro de exaustão.....26
Le remplacement du filtre de sortie d'air.... 14	Identificação e resolução de problemas.....26
Gestion des pannes..... 14	Αξιότιμη πελάτισσα, αξιότιμη πελάτη.....27
Geachte klant,.....15	Χαρακτηριστικά..... 27
Kenmerken van uw viva spin..... 15	Εργαλεία για την ηλεκτρική σας σκούπα..... 27
Toebehoren.....15	Οδηγίες ασφαλείας..... 27
Veiligheid voorop..... 15	Ετοιμασία για να αρχίσετε δουλειά..... 27
Voordat u begint..... 15	Για να επιτύχετε τα καλύτερα αποτελέσματα..... 28
Optimale resultaten.....16	Αφαίρεση περιεχομένων δοχείου σκόνης... 28
Ledig de inhoud van de stofcontainer..... 16	Αλλαγή/καθάρισμα των φίλτρων.....28
Het schoonmaken van en het vervangen van de filters..... 16	Καθαρισμός χάρτινου φίλτρου..... 28
Vervanging van de filtercassette..... 17	Καθαρισμός φίλτρου εξαγωγής..... 29
Vervanging van de uitlaatfilter..... 17	Επίλυση προβλημάτων.....29
Problemen oplossen..... 17	

Kedves Vásárlónk.....	30	Vážení zákazníci.....	42
Az Ön viva spin porszívójának jellemzői....	30	Vybavení.....	42
Az Ön viva spin porszívójának tartozékai.....	30	Příslušenství.....	42
Az Ön biztonsága érdekében.....	30	Bezpečnostní pravidla.....	42
Kezdzünk hozzá.....	31	Vlastní používání.....	42
A legjobb eredmény elérése érdekében.....	31	Dosažení nejlepšího výsledku.....	43
A portartály tartalmának eltávolítása.....	31	Vyndávání obsahu prachového zásobníku.....	43
A filterek tisztítása / cseréje.....	31	Čištění filtrů.....	43
A HEPA hengerfilter tisztítása.....	32	Čištění kazetového filtru.....	44
A kimeneti szűrő cseréje.....	32	Čištění výstupního filtru.....	44
Hibakeresés.....	32	Odstraňování závad.....	44
Szanowni Klienci.....	33	Stimate Client.....	45
Elementy.....	33	Characteristici.....	45
Akcesoria.....	33	Accesorii.....	45
Wskazówki dotyczące bezpieczeństwa.....	33	instrucțiuni privind siguranța.....	45
Eksplatacja.....	33	Utilizare.....	45
Aby osiągnąć najlepsze rezultaty.....	34	Obținerea celor mai bune rezultate.....	46
Opróżnianie pojemnika na kurz.....	34	Îndepărtarea continutului containerului pentru praful.....	46
Czyszczenie filtrów.....	34	Curățarea filtrelor.....	46
Czyszczenie filtra z kasetą.....	34	Curățarea filtru cartus.....	46
Czyszczenie filtra wylotowego.....	35	Curățarea filtru de evacuare.....	47
Usuwanie usterek.....	35	Disfuncționalități.....	47
Poštovani kupče.....	36	Spoštovani kupec.....	48
Značajke.....	36	Značilnosti.....	48
Pribor.....	36	Priključki.....	48
Sigurnosne napomene.....	36	Navodila za varno uporabo.....	48
Uključivanje usisavača.....	36	Kako začeti.....	48
Postizanje najboljih rezultata.....	37	Kako doseći najbolje rezultate.....	49
Pražnjenje spremnika za prašinu.....	37	Praznjenje posode za prah.....	49
Čišćenje filtera.....	37	Čišćenje filterov.....	49
Čišćenje kasetnog filtera.....	37	Čišćenje filtrirnega vložka.....	49
Čišćenje filtera izlaznog zraka.....	38	Čišćenje izhodnega filtra.....	50
Problemi u radu.....	38	Odpravljanje nepravilnosti v delovanju.....	50
Vážení zákazníci, vážený zákazník.....	39	Уважаемые покупатели.....	51
Vybavenie.....	39	Внешний вид (см. стр.3).....	51
Příslušenstvo.....	39	Принадлежности.....	51
Bezpečnostné pokyny.....	39	Техника безопасности.....	51
Uvedenie do prevádzky.....	39	Приступая к работе.....	51
Ako dosiahnuť najlepšie výsledky.....	40	Рекомендации по использованию (см. стр. 5).....	52
Vyprázdenie kontajnera.....	40	Очистка пылесборника (см. стр. 5).....	52
Výmena / čistenie filtrov.....	40	Чистка фильтров.....	52
Čistenie kazetového kruhového filtra.....	40	Чистка касетного фильтра.....	53
Výmena výfukového filtra.....	41	Чистка выхлопного фильтра.....	53
V prípade poruchy.....	41	Устранение неисправностей.....	53

Değerli Müşterimiz.....	54
Özellikler.....	54
Aksesuarlar.....	54
Emniyet önlemleri.....	54
Kullanıma başlarken.....	54
En iyi sonuçları almak için.....	55
Toz haznesinin boşaltılması.....	55
Filtrelerin temizlenmesi.....	55
Silindir filtrenin temizlenmesi.....	55
Hava çıkış filtrenin temizlenmesi.....	56
Sorun giderme.....	56

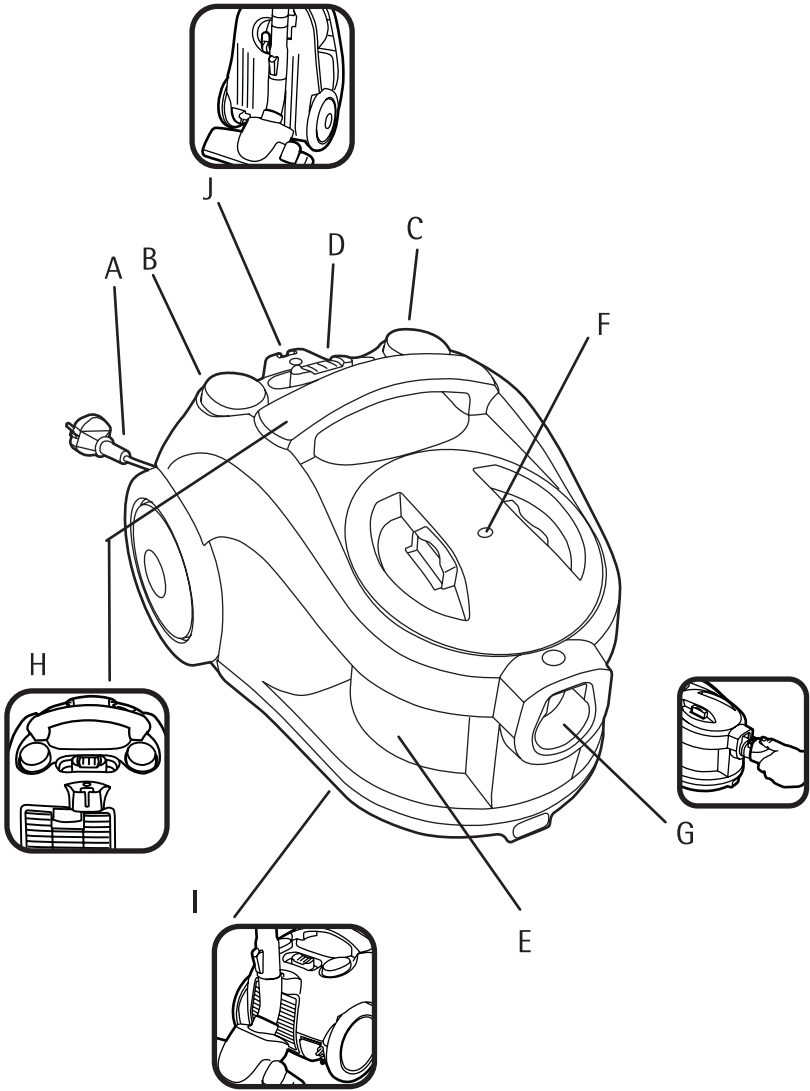

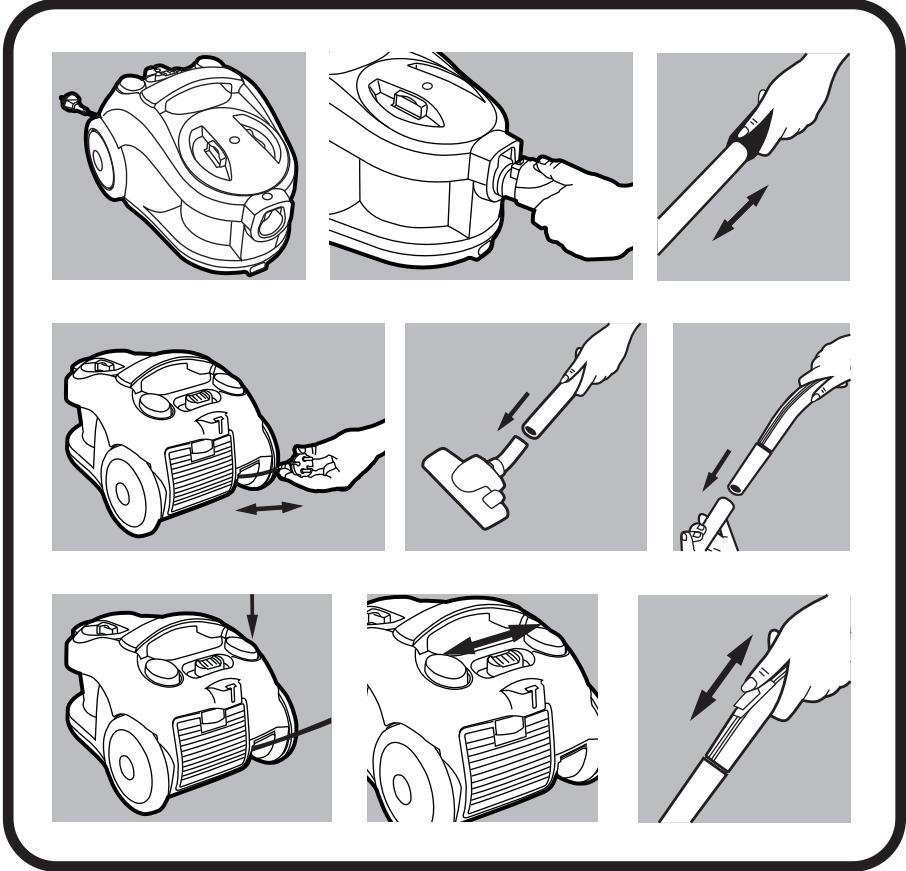
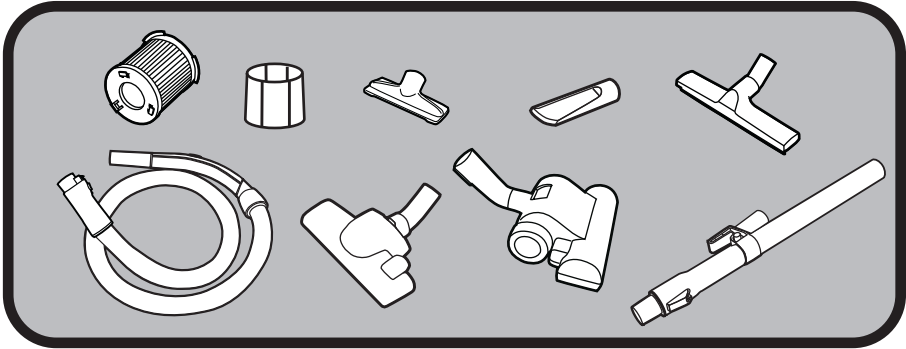

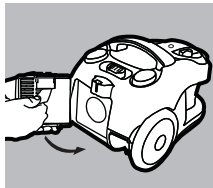
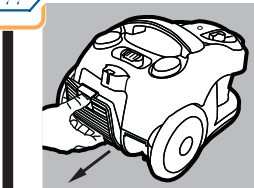
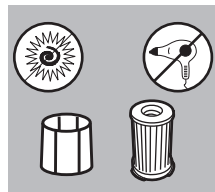
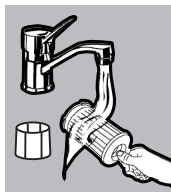
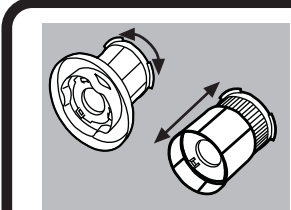
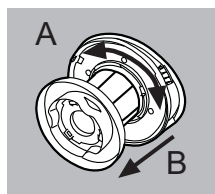
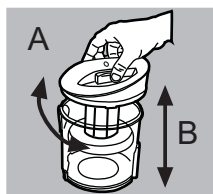
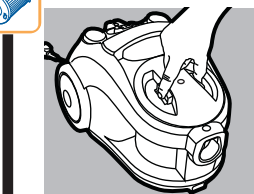
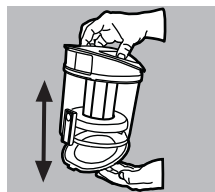
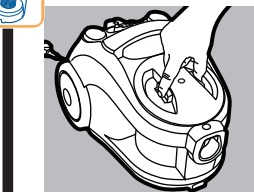
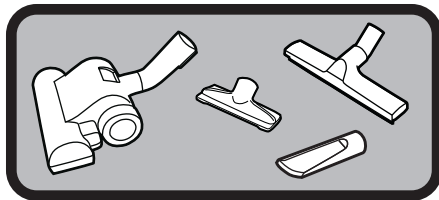
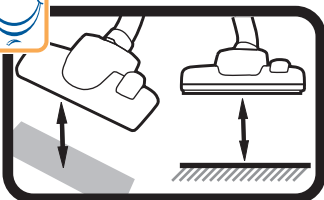

Dear Customer

Thank you for choosing an AEG-Electrolux cleaner. To ensure total satisfaction, read this Instruction book carefully.

Features (see page 3)

- A Mains cable
- B Cable rewind button
- C On/off button
- D Suction control
- E Dust container
- F Dust container indicator
- G Hose connection
- H Carrying handle
- I Horizontal parking position
- J Vertical parking position



Accessories (see page 4)

- Cartridge filter
- Protector mesh
- Telescopic tube
- Swivel hose and handle with manual suction control
- Combination carpet/hard floor nozzle
- Hard floor nozzle (7460, 7480 7481, 7485, 7486, 1800 TRIO)
- Turbo nozzle (7480, 7481, 7485, 7486, 1800 TRIO)
- Narrow crevice nozzle
- Combination upholstery nozzle/brush
- Accessory holder ('caddy')



Safety instructions

The cleaner is for domestic use only and has been designed to ensure maximum safety and performance. Please follow these simple precautions:

- The cleaner is double-insulated so it must not be earthed.
- The cleaner is only to be used by adults. Young children or infirm persons should be supervised to ensure that they do not play with the appliance.

- Always store in a dry place.
- Do not use to pick up liquids.
- Avoid sharp objects.
- Do not vacuum up very fine dust from plaster, cement, cold cinders, flour or ash.

These materials can cause serious damage to the motor – a damage which is not covered by the warranty.

- Do not use near flammable gases.
- Avoid tugging on the mains cable and check cable regularly for damage.
- **Note: Do not use your cleaner with a damaged cable. If the cable is damaged, it should be replaced at an AEG-Electrolux Service Centre.**
- The plug must be removed from the socket-outlet before cleaning or maintaining the appliance.
- All service and repairs must be carried out by authorised AEG-Electrolux service staff.



Getting Started (see page 4)



Check the dust container is in place.





To connect the hose into the suction inlet push it until it clicks.

To disconnect the hose from the suction inlet push the button at the end of the hose.



Attach the telescopic tube to the hose handle and floor nozzle by pushing and twisting together. (Twist and pull apart to dismantle).

 Extend the cable and connect to mains. The cleaner is fitted with cable rewind, ensure cable is not twisted before use. (Press foot pedal to rewind. **Note: Please hold the plug to prevent it striking you or the machine).**

 Press the On/Off button to activate the cleaner.

 By moving the variable power control, the suction power can be adjusted.

Suction can also be regulated on the hose handle by opening/closing the aperture.

Getting the best results (see page 5)

- **Carpets:** Use the floor nozzle with the lever in horizontal position.
- **Hard floors:** Use the floor nozzle with the lever in vertical position.
- **Loose rugs/curtains/lightweight fabrics:** Reduce the suction power. Use the floor nozzle for loose rugs and the upholstery nozzle for curtains, cushions etc.
- **Confined areas:** Use the crevice nozzle for crevices, corners and radiators.
- **Hard floor / parquetry:** use the hard floor nozzle to avoid scratching (7460, 7480, 7481, 7485, 7486, 1800 TRIO).
- **For the perfect care of your carpets:** use the turbo nozzle. The rotary motion of its brush gently loosens short-pile carpets where the dirt has been trodden in. It removes stubborn fluff and pet hairs (7480, 7481, 7485, 7486, 1800 TRIO).



Removing the contents of the dust container (see page 5)

Never operate the cleaner without the dust container installed.

The dust container must be emptied if the window of the dust container indicator changes its colour into red when the cleaner is operating at maximum power and the nozzle is raised from the floor.



Remove the dust container from the cleaner by pushing the opening button on both sides.



Remove the contents of the dust container by pushing the orange-coloured opening button.



Close the dust container lid until it clicks.



Put the dust container back into the cleaner.



Cleaning the filters (see page 5)

Filters should be replaced at least twice a year or when they become visibly soiled.

Always operate the cleaner with filters installed to avoid reduced suction and the damage of the motor.

Always operate the cleaner with the cartridge filter installed.

Disconnect from electrical outlet before changing the filters.













Cleaning the cartridge filter:



Remove the dust container from the cleaner by pushing the opening button on both sides.





Rotate the dust container cover counter-clockwise (A) and pull it out from the dust container (B).

-  Remove the cartridge filter by turning it counter-clockwise (A) and pull it out from the dust container cover (B).
-  Remove the cartridge filter from the cartridge filter plate by turning it counter-clockwise.
-  Remove the protector mesh by pulling it out.
-  Shake the dirt from the filter and the mesh into a bin. If necessary, the filter and mesh can be rinsed, with cold water, under a tap .
-  Air dry them for approximately 24 hours, to ensure it is completely dry before re-using. Avoid direct sunlight and extreme drying circumstances (hair-dryer, etc.). If you wish to use your appliance while the cartridge filter is drying, you may use the extra cartridge filter inserted in the packaging box (7440, 7460, 7480, 7485).
-  Insert the protector mesh back into its place by pulling it onto the cartridge filter.
-  Insert the cartridge filter back into the cartridge filter plate by turning it clockwise.
-  Insert the cartridge filter back into the dust container cover (B) and turn it clockwise (A).
-  Insert the dust container cover back into the dust container (B) and turn it clockwise (A).
-  Put the dust container back into the cleaner.

Cartridge filter reference number:
407 135 654/9.

Cleaning the exhaust filter:

-  Open the filter grill to remove the exhaust filter.
-  Take the filter out of the grill and insert a new one.
-  Close the filter grill.

Exhaust filter reference number:
Menalux D09.

Troubleshooting

- **Power:** If the electric power does not come on, disconnect from mains and check plugs, cable and fuses where appropriate.
- **Blockages/dirty filters:** The cleaner may switch itself off in the event of a severe blockage or excessively dirty filter(s). In such cases, disconnect from mains and allow to cool for 20-30 minutes. Clear blockage and/or replace filter(s) and restart. The clearing of blocked hoses is not covered by the guarantee. Please also see AEG-Electrolux additional information in the separate AEG-Electrolux Warranty Booklet.
- **Water:** If water is sucked into the cleaner the motor must be changed at an AEG-Electrolux Service Centre.

German



Das Symbol  auf dem Produkt oder seiner Verpackung weist darauf hin, dass dieses Produkt nicht als normaler Haushaltsabfall zu behandeln ist, sondern an einem Sammelpunkt für das Recycling von elektrischen und elektronischen Geräten abgegeben werden muss. Durch Ihren Beitrag zum korrekten Entsorgen dieses Produkts schützen Sie die Umwelt und die Gesundheit Ihrer Mitmenschen. Umwelt und Gesundheit werden durch falsches Entsorgen gefährdet. Weitere Informationen über das Recycling dieses Produkts erhalten Sie von Ihrem Rathaus, Ihrer Müllabfuhr oder dem Geschäft, in dem Sie das Produkt gekauft haben.

French



Le symbole  sur le produit ou son emballage indique que ce produit ne peut être traité comme déchet ménager. Il doit plutôt être remis au point de ramassage concerné, se chargeant du recyclage du matériel électrique et électronique. En vous assurant que ce produit est éliminé correctement, vous favorisez la prévention des conséquences négatives pour l'environnement et la santé humaine qui, sinon, seraient le résultat d'un traitement inapproprié des déchets de ce produit. Pour obtenir plus de détails sur le recyclage de ce produit, veuillez prendre contact avec le bureau municipal de votre région, votre service d'élimination des déchets ménagers ou le magasin où vous avez acheté le produit.

English



The symbol  on the product or on its packaging indicates that this product may not be treated as household waste. Instead it shall be handed over to the applicable collection point for the recycling of electrical and electronic equipment. By ensuring this product is disposed of correctly, you will help prevent potential negative consequences for the environment and human health, which could otherwise be caused by inappropriate waste handling of this product. For more detailed information about recycling of this product, please contact your local city office, your household waste disposal service or the shop where you purchased the product.

Dutch



Het symbool  op het product of op de verpakking wijst erop dat dit product niet als huishoudafval mag worden behandeld. Het moet echter naar een plaats worden gebracht waar elektrische en elektronische apparatuur wordt gerecycled. Als u ervoor zorgt dat dit product op de correcte manier wordt verwijderd, voorkomt u mogelijk voor mens en milieu negatieve gevolgen die zich zouden kunnen voordoen in geval van verkeerde afvalbehandeling. Voor meer details in verband met het recyclen van dit product, neemt u het best contact op met de gemeentelijke instanties, het bedrijf of de dienst belast met de verwijdering van huishoudafval of de winkel waar u het product hebt gekocht.

Italian



Il simbolo  sul prodotto o sulla confezione indica che il prodotto non deve essere considerato come un normale rifiuto domestico, ma deve essere portato nel punto di raccolta appropriato per il riciclaggio di apparecchiature elettriche ed elettroniche. Provvedendo a smaltire questo prodotto in modo appropriato, si contribuisce a evitare potenziali conseguenze negative per l'ambiente e per la salute, che potrebbero derivare da uno smaltimento inadeguato del prodotto. Per informazioni più dettagliate sul riciclaggio di questo prodotto, contattare l'ufficio comunale, il servizio locale di smaltimento rifiuti o il negozio in cui è stato acquistato il prodotto.

Portuguese



O símbolo  no produto ou na embalagem indica que este produto não pode ser tratado como lixo doméstico. Em vez disso, deve ser entregue ao centro de recolha selectiva para a reciclagem de equipamento eléctrico e electrónico. Ao garantir uma eliminação adequada deste produto, irá ajudar a evitar eventuais consequências negativas para o meio ambiente e para a saúde pública, que, de outra forma, poderiam ser provocadas por um tratamento incorrecto do produto. Para obter informações mais pormenorizadas sobre a reciclagem deste produto, contacte os serviços municipalizados locais, o centro de recolha selectiva da sua área de residência ou o estabelecimento onde adquiriu o produto.

Spanish



El símbolo  en el producto o en su embalaje indica que este producto no se puede tratar como desperdicios normales del hogar. Este producto se debe entregar al punto de recolección de equipos eléctricos y electrónicos para reciclaje. Al asegurarse de que este producto se deseche correctamente, usted ayudará a evitar posibles consecuencias negativas para el ambiente y la salud pública, lo cual podría ocurrir si este producto no se manipula de forma adecuada. Para obtener información más detallada sobre el reciclaje de este producto, póngase en contacto con la administración de su ciudad, con su servicio de desechos del hogar o con la tienda donde compró el producto.

Greek



Το σύμβολο  στο προϊόν ή επάνω στη συσκευασία του υποδεικνύει ότι δεν πρέπει να μ εταχειρίζετε το προϊόν αυτό ως οικιακό απόρριμμα . Αντιθέτως θα πρέπει να παραδίδεται στο κατάλληλο σημείο συλλογής για την ανακύκλωση ηλεκτρικού και ηλεκτρονικού εξοπλισμού. Εξασφαλίζοντας ότι το προϊόν αυτό διατίθεται σωστά, συμβάλλετε στην αποτροπή ενδεχόμενων αρνητικών συνεπειών για το περιβάλλον και την ανθρώπινη υγεία, οι οποίες θα μπορούσαν διαφορετικά να προκληθούν από ακατάλληλο χειρισμό απόρριψης του προϊόντος αυτού. Για λεπτομερέστερες πληροφορίες σχετικά με την ανακύκλωση του προϊόντος αυτού, επικοινωνήστε με το δημαρχείο της περιοχής σας, την τοπική σας υπηρεσία αποκομιδής οικιακών

Hungarian

A terméken vagy a csomagoláson található

 szimbólum azt jelzi, hogy a termék nem kezelhető háztartási hulladékként. Ehelyett a terméket el kell szállítani az elektromos és elektronikai készülékek újrahasznosítására szakosodott megfelelő begyűjtő helyre. Azzal, hogy gondoskodik ezen termék helyes hulladékba helyezéséről, segít megelőzni azokat, a környezetre és az emberi egészségre gyakorolt potenciális kedvezőtlen következményeket, amelyeket ellenkező esetben a termék nem megfelelő hulladékkezelése okozhatna. Ha részletesebb tájékoztatásra van szüksége a termék újrahasznosítására vonatkozóan, kérjük, lépjen kapcsolatba a helyi önkormányzattal, a háztartási hulladékok kezelését végző szolgálattal vagy azzal a bolttal, ahol a terméket vásárolta.

Polish

Symbol  na produkcie lub na opakowaniu oznacza, że tego produktu nie wolno traktować tak, jak innych odpadów domowych. Należy oddać go do właściwego punktu skupu surowców wtórnych zajmującego się złomowanym sprzętem elektrycznym i elektronicznym. Właściwa utylizacja i złomowanie pomaga w eliminacji niekorzystnego wpływu złomowanych produktów na środowisko naturalne oraz zdrowie. Aby uzyskać szczegółowe dane dotyczące możliwości recyklingu niniejszego urządzenia, należy skontaktować się z lokalnym urzędem miasta, służbami oczyszczania miasta lub sklepem, w którym produkt został zakupiony.

Slovak

Symbol  na výrobku alebo na jeho obale znamená, že s výrobkom sa nesmie zaobchádzať ako s domovým odpadom. Namiesto toho ho treba odovzdať v zbernom stredisku na recykláciu elektrických alebo elektronických zariadení. Zabezpečte, že tento výrobok bude zlikvidovaný správnym postupom, aby ste predišli negatívnym vplyvom na životné prostredie a ľudské zdravie, čo by bolo spôsobené nesprávnym postupom pri jeho likvidácii. Podrobnejšie informácie o recyklácii tohto výrobku získate, ak zavoláte miestny úrad vo Vašom bydlisku, zberné suroviny alebo obchod, v ktorom ste výrobok kúpili.

Croatian

Simbol  na proizvodu ili na njegovoj ambalaži označuje da se s tim proizvodom ne smije postupiti kao s otpadom iz domaćinstva. Umjesto toga treba biti určen prikladnim sabirnim točkama za recikliranje električnih i električkih aparata. Ispravnim odvoženjem ovog proizvoda spriječit ćete potencijalne negativne posljedice na okoliš i zdravlje ljudi, koje bi inače mogli ugroziti neodgovarajućim rukovanjem otpada ovog proizvoda. Za detaljnije informacije o recikliranju ovog proizvoda molimo Vas da kontaktirate Vaš lokalni gradski ured, uslugu za odvoženje otpada iz domaćinstva ili trgovinu u kojoj ste kupili proizvod.

Czech

Symbol  na výrobku nebo jeho balení udává, že tento výrobek nepatří do domácího odpadu. Je nutné odvézt ho do sběrného místa pro recyklaci elektrického a elektronického zařízení. Zajištěním správné likvidace tohoto výrobku pomůžete zabránit negativním důsledkům pro životní prostředí a lidské zdraví, které by jinak byly způsobeny nevhodnou likvidací tohoto výrobku.

Podrobnější informace o recyklaci tohoto výrobku zjistíte u příslušného místního úřadu, služby pro likvidaci domovního odpadu nebo v obchodě, kde jste výrobek zakoupili.

Romanian

Simbolul  de pe produs sau de pe ambalaj indică faptul că produsul nu trebuie aruncat împreună cu gunoiul menajer. Trebuie predat la punctul de colectare corespunzător pentru reciclarea echipamentelor electrice și electronice. Asigurându-vă că ați eliminat în mod corect produsul, ajutați la evitarea potențialelor consecințe negative pentru mediul înconjurător și pentru sănătatea persoanelor, consecințe care ar putea deriva din aruncarea necorespunzătoare a acestui produs. Pentru mai multe informații detaliate despre reciclarea acestui produs, vă rugăm să contactați biroul local, serviciul pentru eliminarea deșeurilor sau magazinul de la care l-ați achiziționat.

Slovenian

Simbol  na izdelku ali na njegovi embalaži označuje, da z izdelkom ni dovoljeno ravnati kot z običajnimi gospodinjskimi odpadki. Izdelek odpeljite na ustrezno zbirno mesto za predelavo električne in elektronske opreme.

S pravilnim načinom odstranjevanja izdelka boste pomagali preprečiti morebitne negativne posledice in vplive na okolje in zdravje ljudi, ki bi se lahko pojavile v primeru nepravilnega odstranjevanja izdelka.

Za podrobnejše informacije o odstranjevanju in predelavi izdelka se obrnite na pristojen mestni organ za odstranjevanje odpadkov, komunalno službo ali na trgovino, v kateri ste izdelek kupili.

Türkçe

Ürünün ya da ambalajının üzerindeki  simgesi, bu ürünün normal ev çöprü gibi atılmayıp, elektrik ve elektronik cihazların geri dönüşüm için verildiği özel toplama noktalarından birine verilmesi gerektiğini belirtir. Bu ürünün doğru şekilde imha edilmesine katkıda bulunmakla hem çevreyi, hem de çevrenizdekilerin sağlığını korumuş olursunuz. Yanlış şekilde imha ise hem çevreye hem sağlığa zararlıdır. Bu ürünün geri dönüşümüne ilişkin daha ayrıntılı bilgileri belediyenizden, çöp dairenizden veya ürünü satın almış olduğunuz satıcıdan edinebilirsiniz.

Russian

Символ  на изделии или на его упаковке указывает, что оно не подлежит утилизации в качестве бытовых отходов. Вместо этого его следует сдать в соответствующий пункт приемки электронного и электрооборудования для последующей утилизации. Соблюдая правила утилизации изделия, Вы можете предотвратить причинение окружающей среде и здоровью людей потенциального ущерба, который возможен, в противном случае, вследствие неподобающего обращения с подобными отходами. За более подробной информацией об утилизации этого изделия просьба обращаться к местным властям, в службу по вывозу и утилизации отходов или в магазин, в котором Вы приобрели изделие.

AEG Hausgeräte GmbH
Postfach 1036
D-90327 Nürnberg

<http://www.aeg-electrolux.com>

© Copyright by AEG

T4003 02 06 07



From the Electrolux Group.
The world's No.1 choice.