

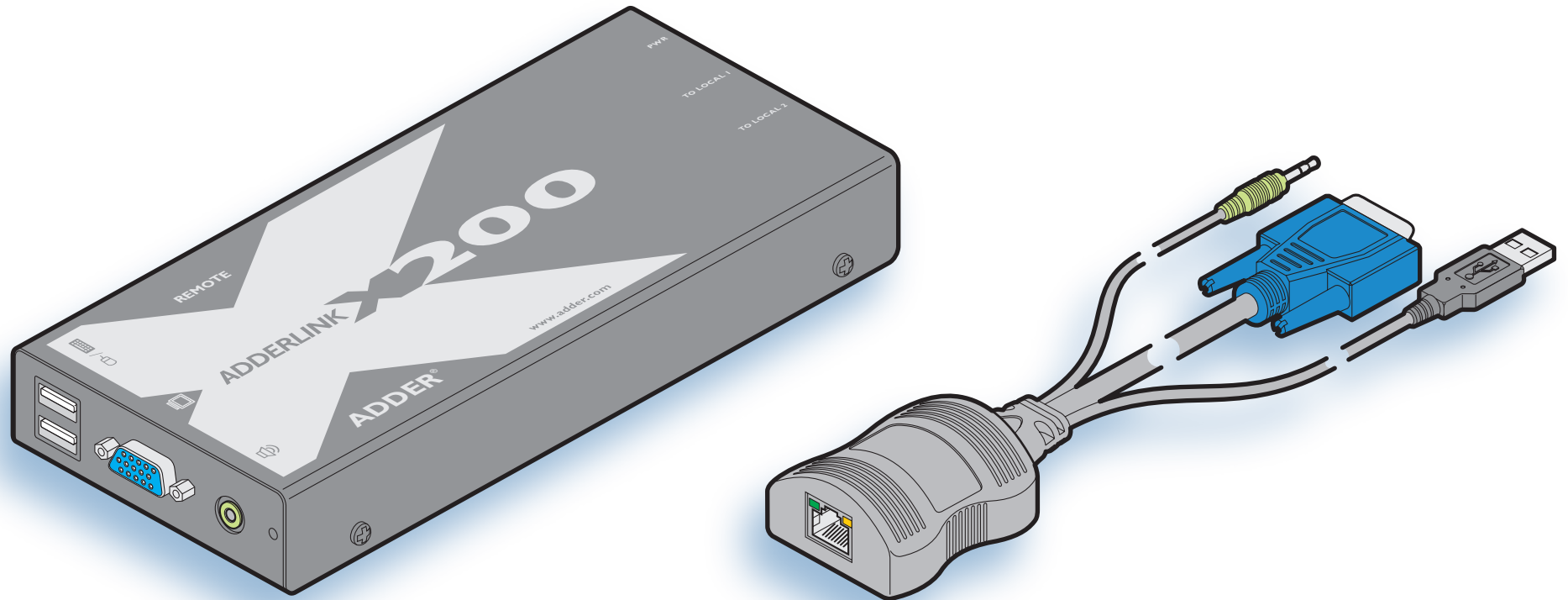

# Adder X200 Extender

## User Guide



[CONTENTS](#)

# Contents



## Welcome

Introduction .....	2
What you may additionally need .....	3

## Installation & Operation

Connections .....	4
Cable length advice .....	4
Connections at each CAM (local) unit .....	5
Connections at the X200 (remote) module .....	6
Operation .....	8
General use .....	8
Selecting and using computers .....	8
Locking and unlocking the system .....	8

## Special configuration

Configuration .....	9
What are hotkeys? .....	9
Entering, using and exiting configuration mode .....	9
Password setting .....	10
Mouse switching control .....	10
Hot plugging PS/2-style connections and mouse restoration .....	11
Which restore setting do I use? .....	11
Microsoft and Logitech -specific mouse settings .....	11
Video compensation (sharpness and brightness) .....	12
Video skew adjustment (X200AS models only) .....	13
Miscellaneous settings .....	14
Performing flash upgrades .....	15

## Further information

Getting assistance .....	17
Warranty .....	18
Safety information .....	18
Radio Frequency Energy .....	19

CONTENTS

WELCOME

INSTALLATION  
& OPERATION

SPECIAL  
CONFIGURATION

FURTHER  
INFORMATION

# Welcome



## Introduction

Thank you for choosing the Adder X200 extender set. These compact modules allow you to remotely control up to two computer systems from a common keyboard, video monitor, mouse and speaker set. The controlling peripherals can be situated up to 300 metres\* from each computer system (\* X200AS skew compensation model).

Peripheral connections to each computer system are handled by Computer Access Modules (or CAMs). The long distance link between the CAMs and the common X200 module is made via Category 5, 5e or 6 twisted pair cabling.

Special circuitry within the remote module allows you to make adjustments to the sharpness and brightness settings to suit your own preferences.

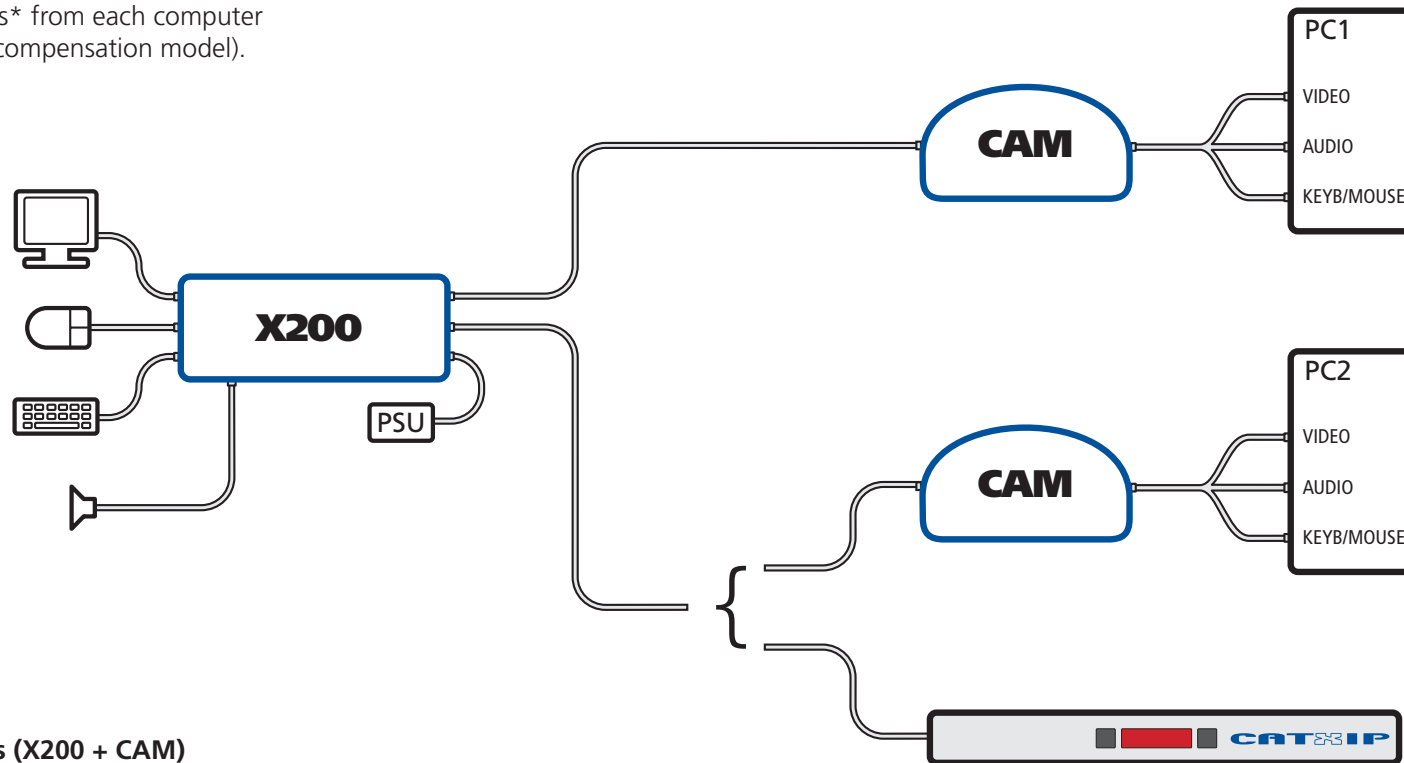

X200 modules can be used to connect to individual computer systems via CAMs or to many computers via AdderView CATx switches

## X200 model range

### Extender pair packages (X200 + CAM)

- X200-USB/P 100m extender pair, USB CAM, no audio, no de-skew
- X200A-USB/P 100m extender pair, USB CAM, audio, no de-skew
- X200AS-USB/P 300m extender pair, USB CAM, audio and de-skew

### X200 receivers only (for use with CATx switches etc.)

- X200 /R 100m receiver, no audio, no de-skew
- X200A /R 100m receiver, audio, no de-skew
- X200AS /R 300m receiver, audio and de-skew

CONTENTS

WELCOME

INSTALLATION  
& OPERATION

SPECIAL  
CONFIGURATION

FURTHER  
INFORMATION

## Supplied items

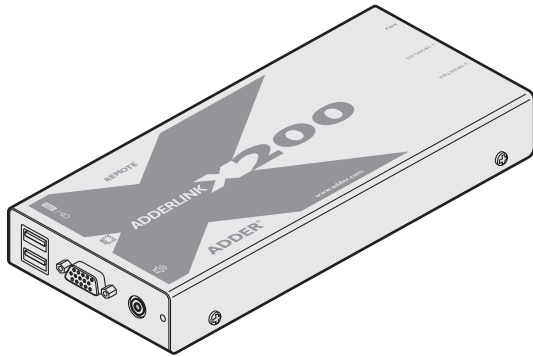

**X200 Module**  
Available with or without audio and skew compensation capabilities

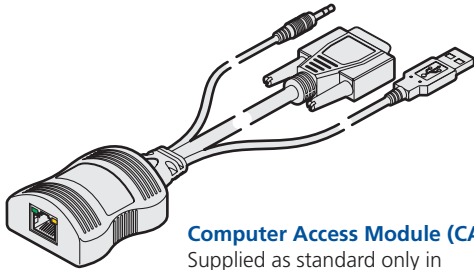

**Computer Access Module (CAM)**  
Supplied as standard only in extender pair packages, otherwise available as options - see opposite.

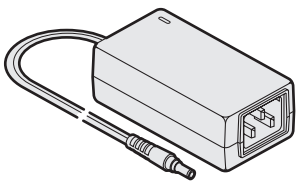

**Power adapter and country-specific power lead**

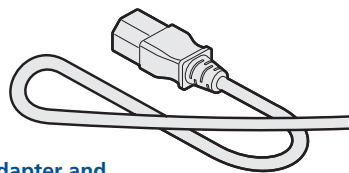

**Serial flash upgrade cable (4-way jack connector to 9-way D-type male serial connector) - not pictured**

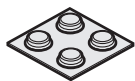

**Four self-adhesive rubber feet**

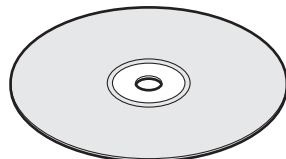

**CD-ROM**

## What you may additionally need

**Additional Computer Access Module (CAM) modules:**  
**USB CAM, no audio** Part number: CATX-USB  
**USB CAM with audio** Part number: CATX-USBA  
**PS/2 CAM** Part number: CATX-PS2  
**PS/2 CAM with audio** Part number: CATX-PS2A  
**SUN CAM with audio** Part number: CATX-SUNA

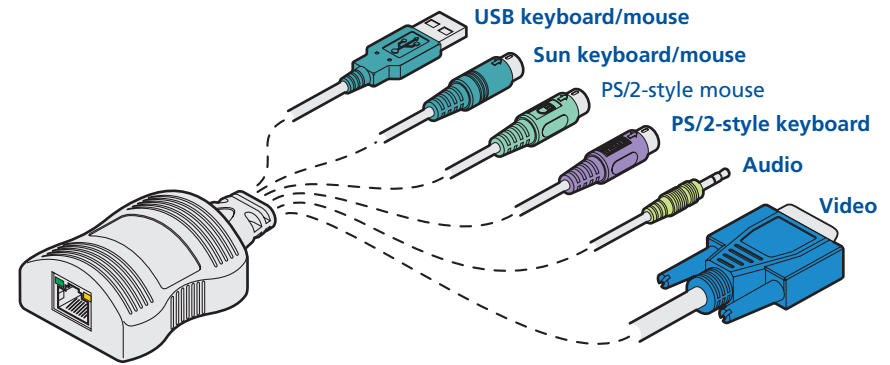

**Part number: CAB-9DF-RJ9-2M**



CONTENTS

WELCOME

INSTALLATION & OPERATION

SPECIAL CONFIGURATION

FURTHER INFORMATION

# Installation & Operation



## Connections

Installation of the X200 modules is straightforward and minimal configuration requirements in most cases. Each of the (up to) two moulded CAMs (*Computer Access Modules*) connect directly to a computer system, while the remote X200 module is at the other end of the twisted pair cable runs and attaches to the keyboard, mouse, etc.

X200 receiver units can also be used with AdderView CATx switches to allow one or more user consoles to be placed remotely from the central unit.

- [Connections at each CAM \(local\) unit](#)
- [Connections at the X200 \(remote\) module](#)

## Cable length advice

The X200 modules support twisted-pair structured cabling within categories 5, 5e and 6. Of these three cable types, category 5 generally provides the best transmission of video signals because its four pairs of conductors are the most evenly twisted.

Category 5e and 6 cables use conductor pairs that are unevenly twisted in order to combat interference effects encountered within higher frequency networks. While these uneven twists work well for Ethernet signals, they can impose problems for the video signals transceived by the X200 modules. The X200 modules send the red, green and blue video signals on separate twisted pairs within the cable. If any of the colour signals are made to travel slightly further or shorter distances than the others, the result is seen as misaligned colours on screen. This is called *skew* and becomes more noticeable as cable runs become longer and screen resolutions/refresh rates increase.

As an approximate guide, you should expect the following maximum cable lengths:

Resolution	X200 without de-skew	X200 with de-skew
1920 x 1200	50m	50m
1600 x 1200	100m	200m
1280 x 1024	-	300m

### When used with an AdderView CATx switch

It is possible to locate each CAM up to 50 metres from the AdderView CATx switch. This distance must be taken into account when planning the cable run from the X200 to the CATx switch. The total distance from any X200 to any CAM must not exceed 300 metres (or less if an X200 without de-skew is used).

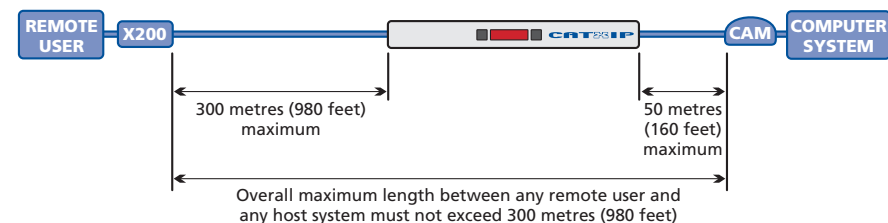

CONTENTS

WELCOME

INSTALLATION  
& OPERATION

SPECIAL  
CONFIGURATION

FURTHER  
INFORMATION

## Connections at each CAM (local) unit

- 1 Where possible ensure that power is disconnected from the system(s) to be connected. For CAMs with PS/2 keyboard and mouse connections, see [Hot plugging PS/2-style connections and mouse restoration](#).
- 2 For each CAM, attach its various connectors to the relevant sockets on the computer system.

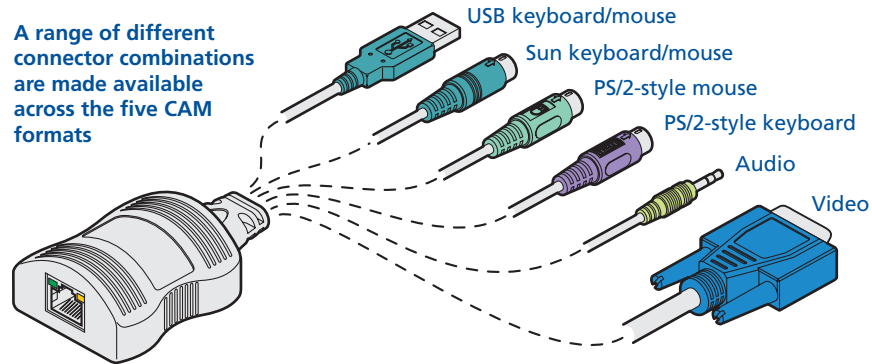

- 3 Lay a suitable length of category 5, 5e or 6 cabling between each computer system/CAM and the location of the remote peripherals - see [Cable length advice](#).

- 4 For each cable run, attach the cable connector to the socket of the CAM. The other end of each cable run will attach to the remote X200 module.

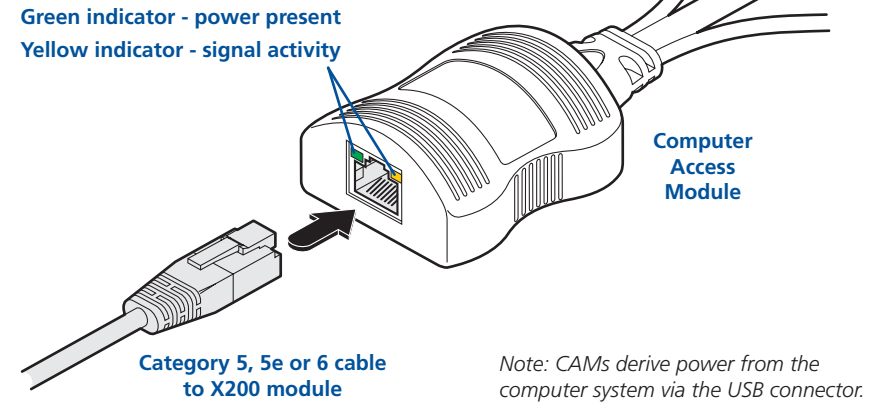

## Connections at the X200 (remote) module

- 1 Place the X200 module adjacent to the remote user location.
- 2 Attach the video monitor, USB keyboard, USB mouse and speaker connectors to the sockets of the Adder X200 module.

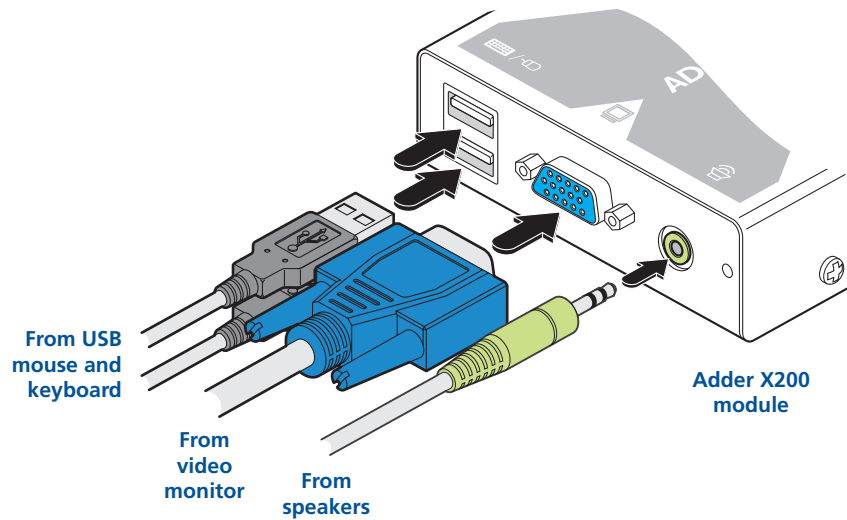

### X200 indicators

Red indicator - power present

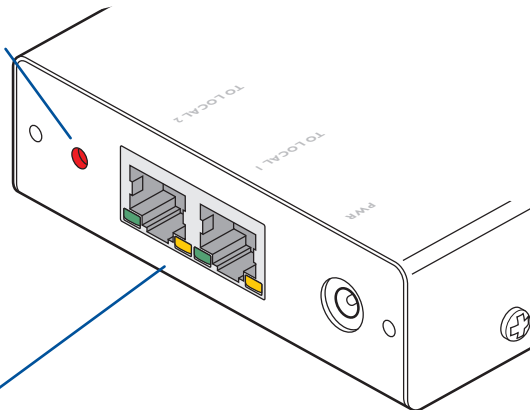

Green indicators - On when the corresponding channel is selected

Yellow indicators - On when link to CAM or CATx switch is made  
Flashing to show signal activity

Both green indicators off - X200 module is password locked

Green indicator for channel 1 flashing - X200 is in flash upgrade mode (SW1 ON)

- 3 Attach the connector of each cable run leading from the CAMs (and/or AdderView CATx switch) to the **TO LOCAL 1** and **TO LOCAL 2** sockets of the X200.

Category 5, 5e or 6 cables leading to the CAM modules or CATx switch (which are attached to the host computers)

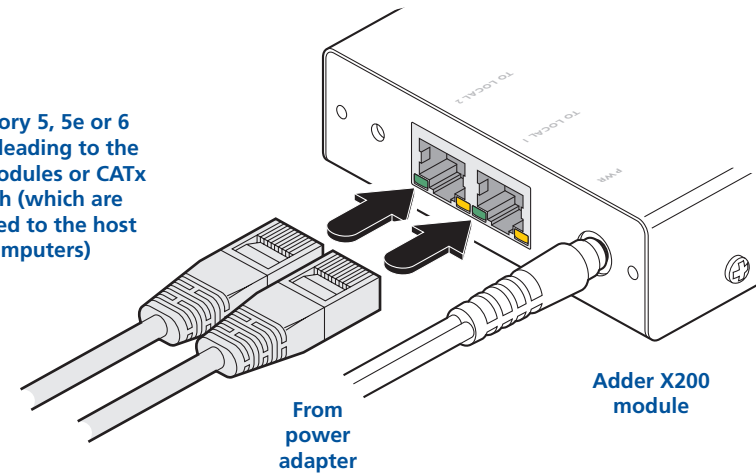

- 4 Insert the output connector of the power supply into the socket at the front edge of the X200 module labelled **POWER**.
- 5 Insert the IEC connector of the supplied power lead into the corresponding socket of the power supply. Connect the other end of the power lead to a nearby mains socket.
- 6 Where necessary, use the in-built video compensation feature to eliminate any effects caused by the cable run. See [Video compensation](#) for details.

## X200 module switches

Certain aspects of operation can be affected by the switches on the X200 module.

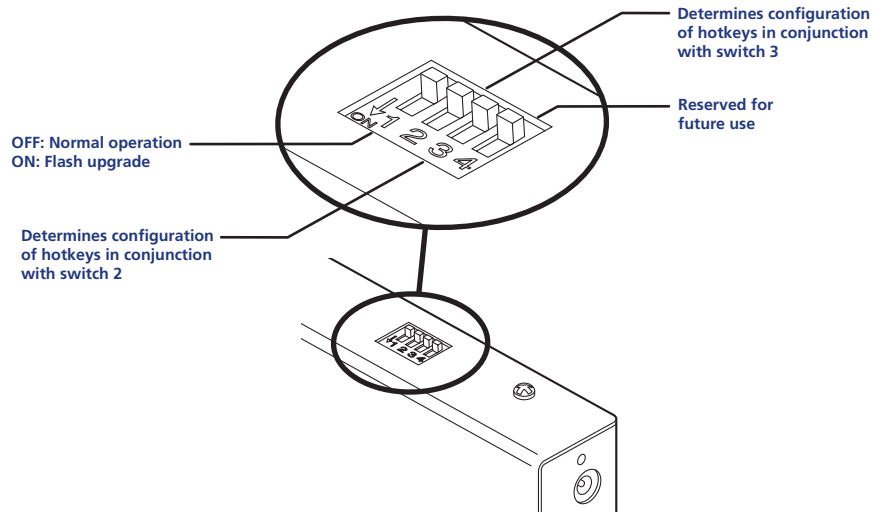

*Note: When shipped, all switches are set in the OFF positions and this will produce normal operation.*

### Switch 1

OFF: Normal operation.

ON: (Before power is applied) Places the X200 module into flash upgrade mode so that the internal software can be changed. Please see the [Flash upgrade](#) section in the 'Special configuration' chapter.

### Switches 2 and 3

Switches 2 and 3 determine which two keyboard keys (when pressed in unison) are to be designated as 'hotkeys'. Hotkeys signal to the X200 module that the next key to be pressed is a special configuration command for the module and is not to be passed to the computer system.

2 OFF

3 OFF      Hotkeys = CTRL and SHIFT

2 OFF

3 ON      Hotkeys = ALT and SHIFT

2 ON

3 OFF      Hotkeys = CTRL and ALT

2 ON

3 ON      Hotkeys disabled

### Switch 4

This switch is reserved for future use.



# Operation

## General use

In use, the X200 module should be transparent - the system and its peripherals should operate exactly as normal, the only difference being that they are now a long distance apart and two computer systems (or more when used with an AdderView CATx switch) can be viewed from a single set of peripherals.

In some installations, you may see some 'shadows' to the right of high contrast screen characters. This can be caused by an incorrectly selected sharpness setting and it may be necessary to make adjustments to correct this. Please see [Video compensation - sharpness and brightness](#) in the 'Special configuration' section.

## Selecting and using computers

### To select a system using the keyboard

Use the keypress combinations (on the common keyboard) to switch between the two computer systems. In each case, you need to simultaneously press the currently configured hotkeys (by default, **Ctrl** and **Shift**) together with the number of the required system:

- System 1: Press the hotkeys (by default, **Ctrl** and **Shift**) along with **1**
- System 2: Press the hotkeys (by default, **Ctrl** and **Shift**) along with **2**

Once entered, (providing the system isn't locked - see opposite) the remote peripherals will be connected to the chosen system and you can begin using it as normal.

### To disconnect from both systems (using the keyboard)

Press the currently configured hotkeys (by default, **Ctrl** and **Shift**) along with **0**

### To select a system using a 3 button mouse

You can use a 3 button mouse to change between channels. A 3 button mouse can either have three distinct buttons or alternatively be a 'wheel mouse' where the central scroll wheel may be depressed.

*Notes: You first need to enable mouse switching - see [Mouse switching control](#). When mouse switching is enabled, the click of the centre button (or wheel) will not be passed to the host computer - the rotary action of a scroll wheel will, however, continue as normal.*

Press and hold the centre mouse button and then click the left mouse button to change between the two channels.

## Locking and unlocking the system

In situations where the computer systems (and their local CAMs) can be locked away, the X200 module offers a viable security system to deter unauthorised use. Once a password has been set, a simple key sequence allows each system to be quickly and securely detached from the common peripherals. Only the correct password will reconnect the remote and local modules.

### To lock the system

- 1 First set a password. For further details, please refer to the [Password setting](#) section in the 'Special configuration' chapter.
- 2 Simultaneously press the currently configured hotkeys (by default, **Ctrl** and **Shift**) along with **L**.

*The screen will go blank and the three keyboard indicators will begin alternately flashing between the 'Num Lock' and 'Scroll Lock', and 'Caps Lock'. This sequence indicates that a password is required.*

*Additionally neither of the green indicators adjacent to the CATx connectors on the X200 module will be lit.*

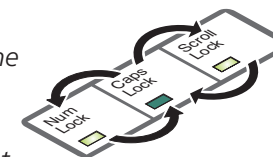

### To unlock the system

- 1 Enter the correct password and press **Enter**.

*Note: Passwords are NOT case sensitive.*

*Note: If an invalid password has been entered and the keyboard indicators are not flashing as described above, press **Enter** to clear the incorrect attempt.*

- 2 If the correct password is entered, the screen will be restored and normal operation can continue.

# Special configuration

## Configuration

You can alter the way that the X200 module operates to suit your requirements. This is done using the Configuration mode and you can affect the following settings:

- [Password setting](#) – allows you to lock the remote module to prevent unauthorised system access.
- [Mouse switching control](#) – determines whether channels may be selected using a three button mouse.
- [Video compensation](#) - sharpness & brightness – allows you to manually adjust the video image to ensure that it is crisp and bright.
- [Video skew adjustment](#) - X200AS models only - allows you to compensate for the effects of long cable runs on colour reproduction.
- [Miscellaneous settings](#) – report firmware version and restore settings.

### What are hotkeys?

Hotkeys are two normal keyboard keys that, when pressed simultaneously with a third key, signal to the X200 module that you are sending a message specifically to it and not to the connected computer. The hotkeys are ordinarily **Ctrl** and **Shift**, while a third keypress determines what you want the module to do.

If the standard **Ctrl** and **Shift** hotkeys are also needed for computer tasks, you can change them for another combination using switches 2 and 3 on the X200 remote module:

- 2 OFF
- 3 OFF Hotkeys = **Ctrl** and **Shift** (default setting)
- 2 OFF
- 3 ON Hotkeys = **Alt** and **Shift**
- 2 ON
- 3 OFF Hotkeys = **Ctrl** and **Alt**
- 2 ON
- 3 ON Hotkeys disabled

## Entering, using and exiting configuration mode

### To enter and use configuration mode:

- 1 Simultaneously press the currently configured hotkeys (by default, **Ctrl** and **Shift**) along with **F1**.  
*The three keyboard indicators ('Num Lock', 'Caps Lock' and 'Scroll Lock') will now begin to flash in sequence to show that you are in configuration mode.*
- 2 Press the first letter of the required configuration option, for instance **F**.  
*All three keyboard indicators will illuminate continuously.*
- 3 Press the number of the required configuration option, for instance **8**.  
*The 'Scroll Lock' indicator will extinguish, leaving the 'Num Lock' and 'Caps Lock' indicators lit.*
- 4 Press **F1** to confirm your option.  
*The three keyboard indicators ('Num Lock', 'Caps Lock' and 'Scroll Lock') will now begin to flash in sequence again.*

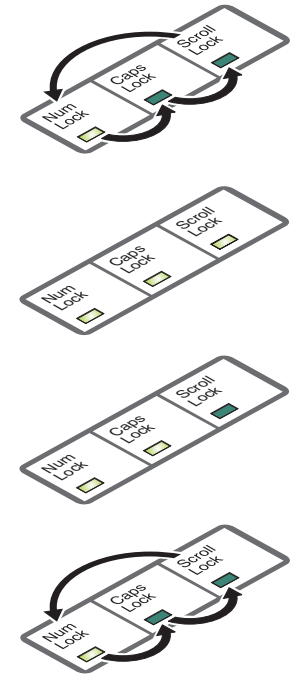





### To exit from configuration mode:

- 1 Within configuration mode, the three keyboard indicators should be flashing in sequence to show that the module is ready to receive a new command.
- 2 Press **F1**.  
*The three indicators will return to their normal states.*

## Password setting

Password protection allows you restrict access to the system only to authorised personnel. A password first needs to be set and then, using the keyboard attached to the remote X200 module, a simple key sequence allows the system to be quickly and securely detached from its peripherals.

### To set a password

- 1 Simultaneously, press the hotkeys (by default, **Ctrl** and **Shift**) along with  to enter configuration mode.
- 2 Press **F** followed by .
- 3 Now enter your new password, within the following constraints:
  - Passwords are NOT case sensitive,
  - Passwords may be any length from one character to a maximum of forty characters,
  - The following keys may NOT be used: **Ctrl**, **Alt**, **Shift**, or .
- 4 When you have entered the password, press  to signal its completion.
- 5 Press  once more to exit configuration mode.

For full details about how to lock and unlock the system using your password, please see the [Locking and unlocking the system](#) section in the 'Installation and operation' chapter.

### To clear a password (and restore factory default settings)





- 1 Connect the X200 module to a computer in the same manner as you would to carry out a flash upgrade - see [Performing flash upgrades](#).
- 2 While power is applied, set the X200 upgrade switch SW1 to its ON position.
- 3 Remove power from the X200 unit and then re-apply power.
- 4 Set the computer serial settings to the following: 19200, n, 8, 1
- 5 Using 'TeraTerm' (recommended) or some other terminal program, send "CLEAR<cr>" - in upper or lower case from the keyboard. The X200 unit should respond with "OK".
- 6 The password is now clear and all factory default settings restored.

## Mouse switching control

In order to allow a 3 button mouse (or scroll wheel mouse) to be used to change channels, it is first necessary to enable the feature using the process described here. For details about switching using a mouse - see [Selecting and using computers](#).

*Note: When mouse switching is enabled, the click of the centre button (or wheel) will not be passed to the host computer - the rotary action of a scroll wheel will, however, continue as normal.*

### To enable/disable mouse switching

- 1 Simultaneously, press the hotkeys (by default, **Ctrl** and **Shift**) along with  to enter configuration mode.
- 2 To enable mouse switching: Press **M** **2**   
To disable mouse switching: Press **M** **1** 
- 3 Press  to exit configuration mode.



## Hot plugging PS/2-style connections and mouse restoration

For computer systems that use PS/2-style keyboard and mouse connections, it is strongly recommended that you switch off the computer system before attempting to connect it via the CAM. However, if this is not possible then you need to 'hot plug' the CAM while power is still applied to the system (keyboards and mice with USB connections are unaffected by hot-plugging). There is not normally a danger of damage to the system, however, when PS/2 mouse communications are interrupted, often they fail to reinitialise when reconnected. CAMs provide a feature to reinstate mouse communications once the necessary connections have been made.

There are two main types of data formats used by current PC mice, these are the older 'PS/2' format and the more recent 'IntelliMouse®' format introduced by Microsoft. These use slightly different data arrangements and it is important to know which type was being used before you hot-plugged the CAM module. The previous setting depends both on the type of mouse and the type of driver as various combinations of PS/2 and Intellimouse are possible. Using the incorrect restore function may produce unpredictable results and require the system to be rebooted.

### Which restore setting do I use?

The general rule is that unless both the mouse *and* the driver are *both* Intellimouse compatible then you need to restore the mouse as 'PS/2'.





### Recognising an Intellimouse-style mouse

The Intellimouse format was introduced to support, among other features, the scroll wheel function. If your mouse has a scroll wheel, then it is likely to support the Intellimouse format. If you have a Microsoft mouse, then it will usually state that it is an Intellimouse on its underside label.

### Recognising an Intellimouse driver

Before hot plugging your CAM (or afterwards using only keyboard control), access the Windows Control Panel and select either the *Mouse* option (on Windows NT, 2000 and XP) or the *System* option (on Windows 95, 98, ME). Look for the name of the driver, which will usually include the words *PS/2* or *Intellimouse*.

### To restore mouse operation when hot plugging:





- 1 Carefully connect the CAM to the system and its keyboard, mouse, monitor and audio output (if used).
- 2 Simultaneously, press the hotkeys (by default, **Ctrl** and **Shift**) along with  to enter configuration mode.
- 3 Enter the appropriate restore function code:
  - *PS/2* – press **M** **6** 
  - *IntelliMouse* – press **M** **7** 
- 4 To exit configuration mode, press .
- 5 Move the mouse a short distance and check for appropriate on-screen cursor movement. If the mouse cursor darts erratically around the screen, then cease moving the mouse. This is an indication that the chosen restore function is incorrect. Try again using the other restore function.

*Note: The restore functions predict the likely mouse resolution settings but may not restore the exact speed or sensitivity settings that were originally set.*

## Microsoft and Logitech -specific mouse settings

In certain installations some Logitech mouse drivers may lose the action of the mouse buttons when used with the standard 'Microsoft compatible' signalling protocol used between the modules. To solve this problem, select the 'Logitech compatible' mouse signalling protocol.

### To change mouse signalling protocols

- 1 Simultaneously, press the hotkeys (by default, **Ctrl** and **Shift**) along with  to enter configuration mode.
- 2 Enter the appropriate protocol code:
  - *Microsoft compatible* – press **M** **3** 
  - *Logitech compatible* – press **M** **4** 
- 3 To exit configuration mode, press .

## Video compensation (sharpness and brightness)

Using the in-built X200 controls you can adjust the picture sharpness and brightness to improve the remote picture quality.

Video compensation is best carried out when viewing high contrast images with vertical edges, such as black lines on a white background. When doing so, if you notice that the screen image is 'fuzzy' or 'dark' then the image controls may not be able to solve this condition.

### To display a suitable high contrast image

The best way to clearly view the effect of sharpness and brightness adjustments is to display a high contrast image, with vertical edges, on the screen.

- Open a word processor, type the capital letter 'H', or 'M' and increase the point size to 72 or higher. For best results, the background should be white and the character should be black.
- A BLACK shadow on the right of the character indicates UNDER compensation.
- A WHITE shadow on the right of the character indicates OVER compensation.

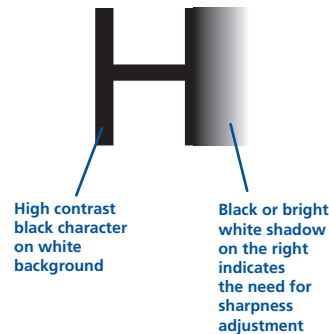

*Note: The Word processor method is accurate and quick. However, for the very finest video compensation, use the latest Adder "skew" test pattern program which shows both the skew pattern and a section of mixed size Hs (black on white and white on black).*

### To apply remote user video compensation

Video compensation is controlled by the X200 module and it maintains independent compensation settings for each of its two ports.

*Note: When used with an AdderView CATx switch, also see the section opposite.*

- 1 *First select the port that you wish to adjust:* On the keyboard that is connected to the X200 remote module, simultaneously, press the hotkeys (by default, **Ctrl** and **Shift**) along along with **1** for the first port or **2** for the second port.
- 2 *Now enter video configuration mode:* On the same keyboard, simultaneously, press the hotkeys along with **F1**.

The three keyboard indicators ('Num Lock', 'Caps Lock' and 'Scroll Lock') will now begin to flash in sequence. The speed of the sequence indicates the level of the sharpness adjustment currently applied: the slower the rate, the lower the level of sharpness being applied.

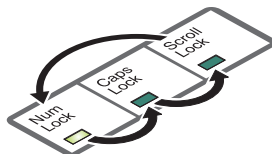

- 3 While viewing the displayed screen image, use the following keys to adjust the controls:

**Sharpness:** **↑** **↓** for fine adjustment, **Page Up** **Page Down** for coarse adjustment.

There are 255 sharpness levels (one coarse step jumps 10 levels).

*Note: If the monitor goes blank and switches off (due to oversetting the sharpness adjustment) press the Home key to restore.*

**Brightness:** **←** **→** for adjustment. There are 255 brightness levels.

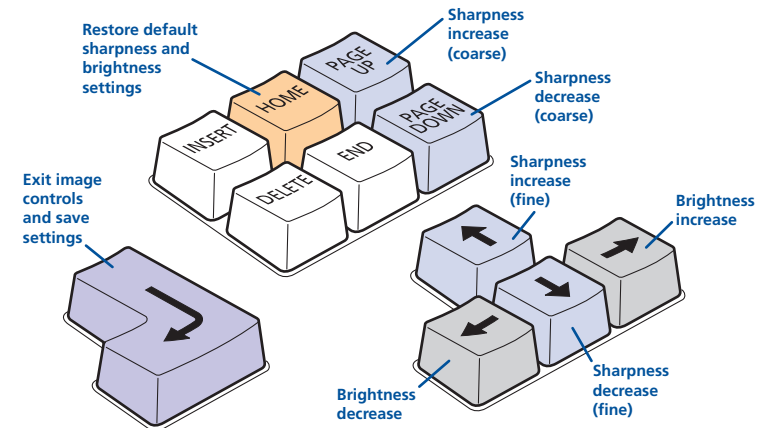

- 4 When no shadows are visible and the displayed images have crisp edges, press **F1** to exit configuration mode and permanently save all settings. The new compensation settings will be stored, even when power is removed or if a complete reset is initiated. These settings should not require further changes unless the cabling arrangements are altered.

*Note: To adjust video compensation for the other channel, you must exit from configuration mode (as described above), select the other channel (as described in step 1) and then re-enter configuration mode (step 2).*

### When used with an AdderView CATx switch

The CATx switch will communicate with the X200 module and automatically add any further CATx to CAM video compensation (set within the OSD of the CATx switch) to compensate for the distance between the CATx switch and the final CAM. *Important: Ensure that the CATx to CAM compensation has been configured before adjusting the X200 video compensation.*

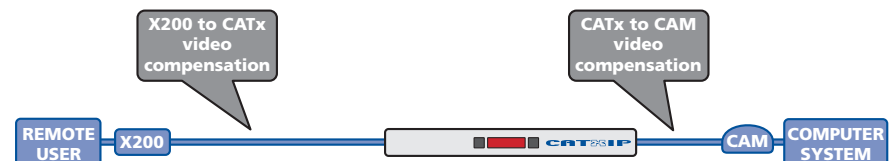

## Video skew adjustment (X200AS models only)

The category 5, 5e and 6 cabling supported by the AdderView CATx consists of four pairs of wires per cable. Three of these pairs are used to convey red, green and blue video signals to the remote video monitor. Due to the slight difference in twist rate between these three pairs, the red, green and blue video signals may not arrive at precisely the same time. This is visible as separate colour shadows on high contrast screen images and is particularly apparent when using higher screen resolutions and some types of category 5e cables.

To alleviate this situation, the Adder X200AS modules provide internal skew adjustment that can help to rectify the situation. The skew adjustment works by delaying or advancing the timing of any of the red, green or blue colour signals so that they are all delivered to the monitor at precisely the same time. For best results, the "skew" program supplied on the disk or downloadable from [www.adder.com](http://www.adder.com) or [www.adder.info](http://www.adder.info) is the most accurate way of setting skew as the red, green and blue lines are rendered exactly on the screen as single pixel wide lines. The skew.bmp test pattern can also be used but it is less accurate. Alternatively, you can create your own skew pattern using a standard image creation package, as detailed opposite.

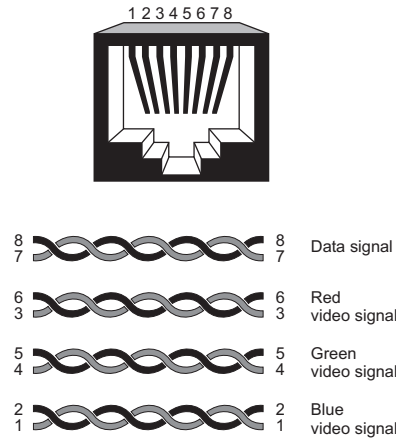

## To use skew adjustment

- 1 Display a skew pattern on the appropriate computer. You can either use the supplied skew pattern or create your own:

### Using the supplied skew pattern

- i Insert the supplied Adder Installation CD-ROM into the CD player of the computer.
- ii Within Windows, use the *My Computer* option (usually available as a desktop icon or within the Start menu) to view the contents of the CD-ROM. Double-click the **Skew** entry to display the standard test pattern. If necessary, maximise the application window so that the image fills the screen.

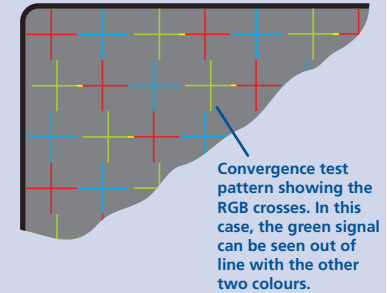

The screen will show a series of fine red, green and blue crosses which should all be in line, vertically and horizontally. Skew affects the horizontal placement of the colours and using this pattern it is much easier to discover which, if any, colours are being adversely affected by the cable link.

### Creating a skew test pattern

- i Run any image creation/editing application, such as the Paint program supplied with Windows.
- ii Using the image application create three stacked horizontal rectangles (one red, one green and one blue) that fill the width of the screen.
- iii Draw a vertical black line down across the coloured bars and then repeat this vertical line at intervals along the width of the coloured bars. These lines create breaks across the colours and give you more opportunities to view the horizontal position of each colour relative to the others.

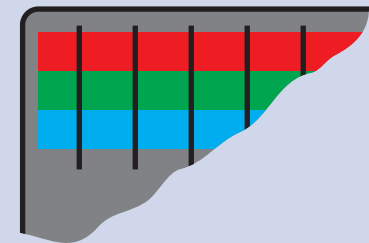

- 2 On the keyboard connected to the X200AS, simultaneously, press the hotkeys (by default, **Ctrl** and **Shift**) along with **F1** to enter configuration mode.

The three keyboard indicators ('Num Lock', 'Caps Lock' and 'Scroll Lock') will now begin to flash in sequence.

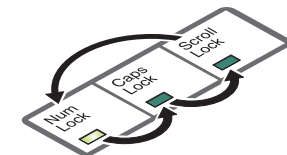

- 3 As appropriate, press either the R, G or B keyboard keys to select the appropriate colour channel. Corresponding keyboard indicators will flash rapidly to show which channel is currently selected for adjustment: Num Lock for Red, Caps Lock for Green and Scroll Lock for Blue.

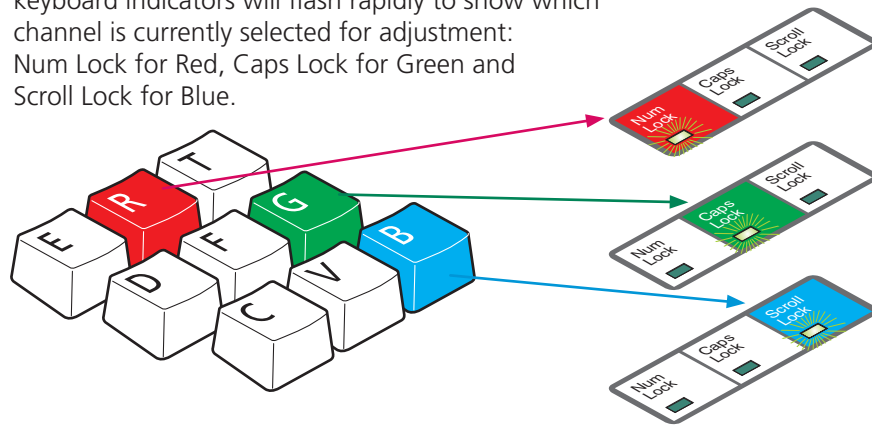

- 4 Press the ← and → keys to retard or advance the timing of the selected colour channel respectively. On screen you will see a change in the position of the selected colour crosses (or colour bars) in relation to the other two.

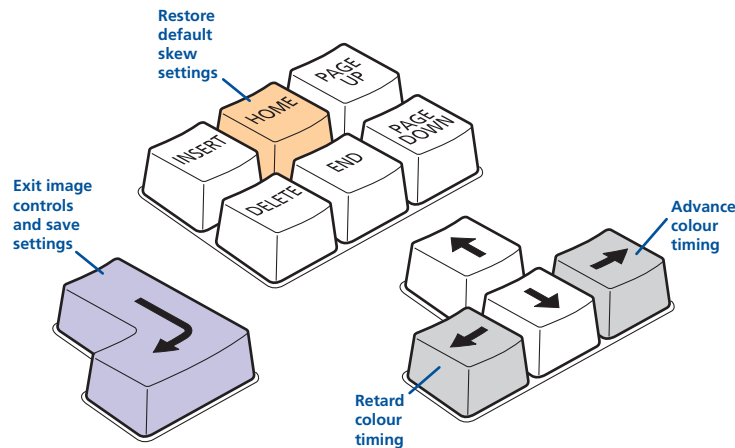

- 5 When the selected colour crosses (or colour bars) are correctly positioned, press ↵ to exit that colour channel. The keyboard indicators will return to flashing in sequence.
- 6 If required, repeat steps 3 to 5 to select and adjust any colour channel until the vertical lines of the red, green and blue crosses are all aligned.
- 7 When all colours are correctly aligned on all video channels, press ↵ to exit configuration mode and permanently save all settings.

*Note: Once you have made the skew adjustments, it may be necessary to re-adjust the image controls to attain optimum screen images.*

## Miscellaneous settings

The following are configuration settings within the modules that are not covered in other sections of this guide. These can be achieved once within configuration mode by pressing the indicated keys:

### Report X200-series firmware version - F1 ↵

Before initiating this command, ensure that the system is running an application that can display typed keys as screen characters - e.g. a word processor or Windows Notepad. The current firmware version will be written to the application in the form of the letter 'V' followed by three numbers - for example V201 means version 2.01.

### Reset all configuration options to default states - F8 ↵

Returns all user configurable options to the settings that are installed at manufacture. The password will be cleared, however, any current image control settings or skew adjustments will not be reset.

## Performing flash upgrades

The Adder X200 modules and CAMs are fully reconfigurable via flash upgrades using the KVM Firmware Uploader utility.

During the upgrade you will be required to connect the X200 module directly to the serial port of a computer system using an optional cable. The upgrade utility will update the firmware of the X200 and also temporarily transform it so that it can update the CAM unit. Once completed, the X200 will return to its normal operation.

The KVM Firmware Uploader utility is available from the Adder Technology website ([www.adder.com](http://www.adder.com)) and allows you to check the current revision of the X200 firmware.

### To perform a flash upgrade

- 1 Remove power from the X200 module. If one or both CAMs also need to be upgraded, ensure that they are connected to the X200 in the usual manner.
- 2 On the side of the X200 module, place switch 1 into its ON position.
- 3 Use the optional upgrade cable to link between the socket adjacent to the X200 switch block and a vacant RS232 9-way serial port of the computer system to be used.

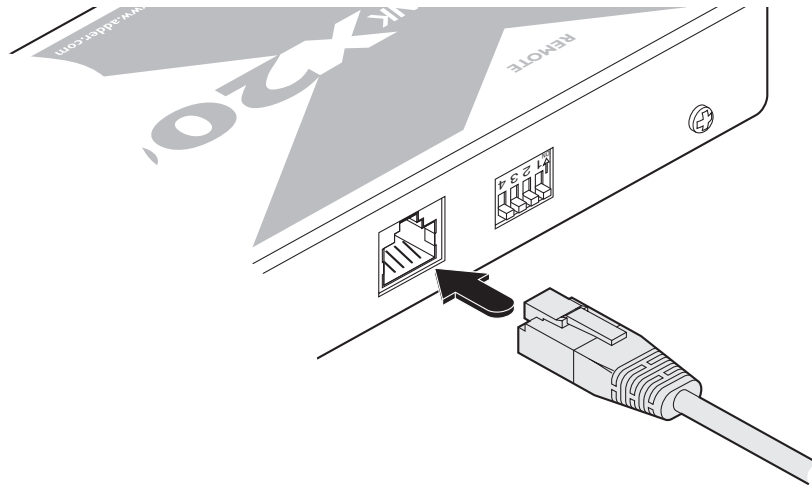

- 4 Apply power to the X200 module. The green indicator on the **TO LOCAL 1** socket will flash to indicate upgrade mode.

- 5 On the computer, select the KVMUploader icon to run the upgrade utility. The KVM Firmware Uploader dialog will be displayed:

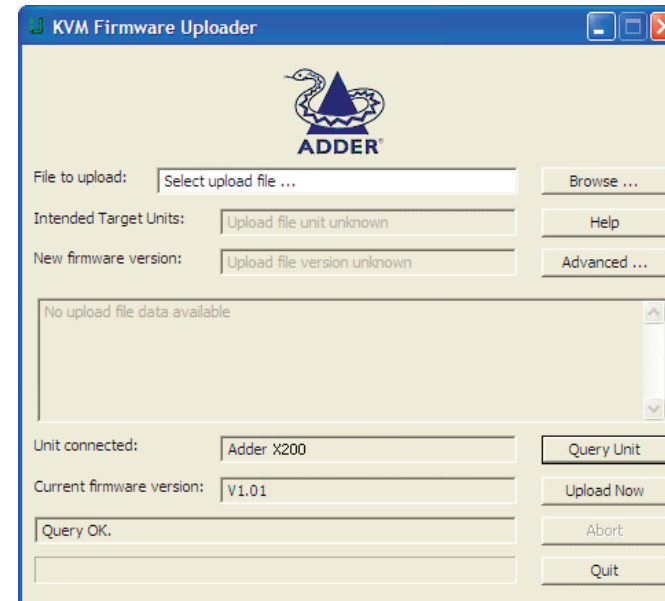

- 6 Click the *Query Unit* button to confirm that communication is possible with the X200 and to establish the existing firmware details.

*Note: The computer to which each CAM is connected must be powered before the respective CAM can be accessed.*

If the application cannot contact the X200 module, recheck the connection cable and click the *Advanced...* button to check that the correct serial port is being used. Change the serial port within the *Advanced* section, if necessary. The results of the unit query will be displayed in the Device/Dongle Selection dialog:

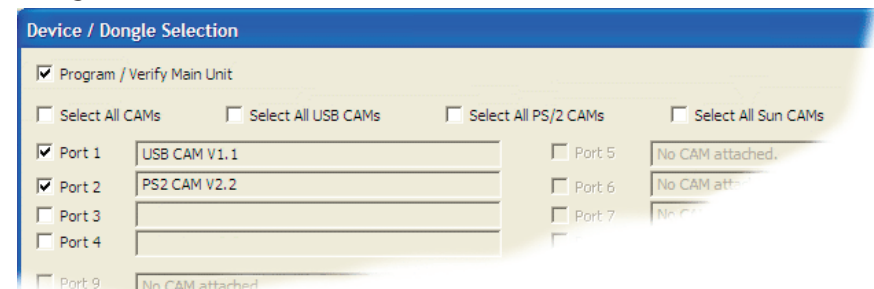

The type and firmware revision of each discovered CAM will be displayed alongside the port number to which it is connected.





- 7 Using the Device/Dongle Selection dialog determine which items should receive a firmware upgrade:
  - Use the *Program / Verify Main Unit* option to include or exclude the X200 module itself.
  - Use the *Select All CAMs* option to upgrade every discovered CAM.
  - Use the *Select All USB / PS2 / Sun CAMs* options to upgrade only CAMs of a certain type.
  - Use the individual port options to select particular CAM devices to upgrade.

When the required options have been selected, click OK.

*Note: Approximate upgrade times are: Adder X200 module = 4½ minutes; each selected CAM = 20 seconds.*

- 8 From the main KVM Firmware Uploader dialog, click the *Browse...* button and select the upgrade file that is appropriate to your AdderView CATx unit:

Adder X200: X200\_Vxxx

where Vxxx is the upgrade file version number.

The upgrade file details will be displayed within the dialog.

**IMPORTANT:** Check that the 'Intended Target Units' field matches the 'Unit Connected' field. If these fields do not match then you may have an incorrect upgrade file, check with Adder Technology Ltd before proceeding. Check also that the 'New firmware version' is greater than the 'Current firmware version'.

- 9 To begin the upgrade process, click the Upload Now button. The progress will be shown within the dialog. Should you decide not to continue with the upload at any stage, click the Abort button; response to this is usually immediate, however, during an erase command, the upload will not be aborted until the erase is complete (this may take a few seconds).

- 10 Change the X200 switch 1 to the OFF position and cycle the power. When the power is re-applied the X200 module and any upgraded CAMs will operate using the new firmware.

### Issues to consider when performing flash upgrades

The upgrade program rewrites the Adder X200 firmware code. If the upgrade process is interrupted then the X200 will have invalid code and will not be able to operate. It is therefore good practice to ensure that the upgrade process is always fully completed. A partial or failed upgrade may be rectified by performing another upgrade. If the upgrade process is interrupted accidentally then you should immediately repeat the upgrade process without moving switch 1 from the upgrade (ON) position. Switch 1 forces the X200 into flash upgrade mode and prevents the upgraded code from being run. Running faulty or partially upgraded code may have unpredictable results and may damage your Adder X200 or computing equipment.

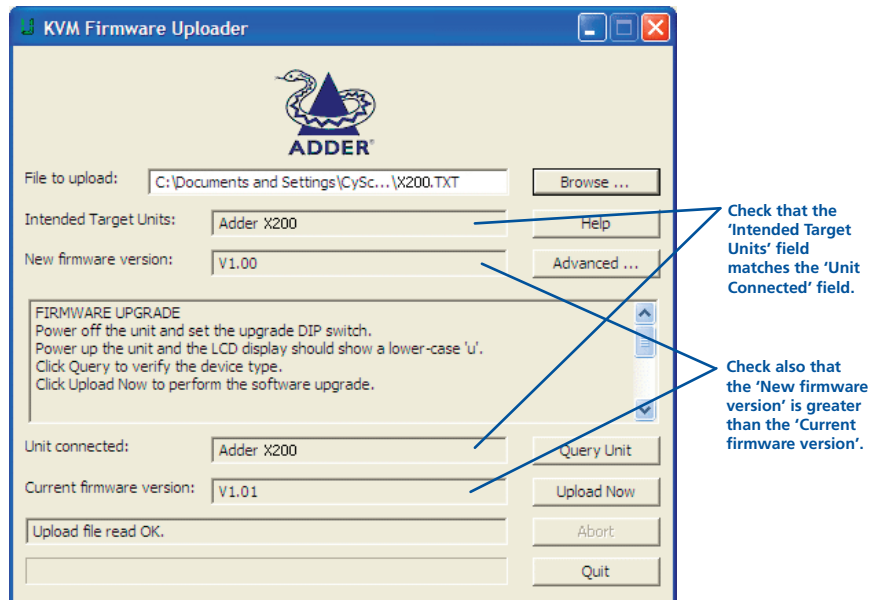

# Further information



## Getting assistance

- Adder Technology website – [www.adder.com](http://www.adder.com)  
Check the Support section of our website for the latest solutions and driver files.
- Email – [support@adder.com](mailto:support@adder.com)
- Fax      in the UK:    **01954 780081**  
              in the US:    **+1 888 275 1117**
- Phone    in the UK:    **01954 780044**  
              in the US:    **+1 888 932 3337**

CONTENTS

WELCOME

INSTALLATION  
& OPERATION

SPECIAL  
CONFIGURATION

FURTHER  
INFORMATION

## Warranty

Adder Technology Ltd warrants that this product shall be free from defects in workmanship and materials for a period of two years from the date of original purchase. If the product should fail to operate correctly in normal use during the warranty period, Adder will replace or repair it free of charge. No liability can be accepted for damage due to misuse or circumstances outside Adder's control. Also Adder will not be responsible for any loss, damage or injury arising directly or indirectly from the use of this product. Adder's total liability under the terms of this warranty shall in all circumstances be limited to the replacement value of this product.

If any difficulty is experienced in the installation or use of this product that you are unable to resolve, please contact your supplier.

## Safety information

- For use in dry, oil free indoor environments only.
- Do not use to link between buildings.
- Ensure that all twisted pair interconnect cables are installed in compliance with all applicable wiring regulations.
- Do not connect CATx link interfaces (RJ45 style connectors) to any other equipment, particularly network or telecommunications equipment.
- Warning – the power adapter contains live parts.
- No user serviceable parts are contained within the power adapter - do not dismantle.
- Plug the power adapter into a socket outlet close to the X200 module that it is powering.
- Replace the power adapter with a manufacturer approved type only.
- Do not use the power adapter if the power adapter case becomes damaged, cracked or broken or if you suspect that it is not operating properly.
- If you use a power extension cord with the X200 module, make sure the total ampere rating of the devices plugged into the extension cord do not exceed the cord's ampere rating. Also, make sure that the total ampere rating of all the devices plugged into the wall outlet does not exceed the wall outlet's ampere rating.
- Do not attempt to service the modules yourself.
- The X200 module and power supply can get warm in operation – do not situate them in an enclosed space without any ventilation.
- The X200 module does not provide ground isolation and should not be used for any applications that require ground isolation or galvanic isolation.



CONTENTS

WELCOME

INSTALLATION  
& OPERATION

SPECIAL  
CONFIGURATION

FURTHER  
INFORMATION

## Radio Frequency Energy

A Category 5 (or better) twisted pair cable must be used to connect the units in order to maintain compliance with radio frequency energy emission regulations and ensure a suitably high level of immunity to electromagnetic disturbances.

All other interface cables used with this equipment must be shielded in order to maintain compliance with radio frequency energy emission regulations and ensure a suitably high level of immunity to electromagnetic disturbances.

## European EMC directive 89/336/EEC

This equipment has been tested and found to comply with the limits for a class A computing device in accordance with the specifications in the European standard EN55022. These limits are designed to provide reasonable protection against harmful interference. This equipment generates, uses and can radiate radio frequency energy and if not installed and used in accordance with the instructions may cause harmful interference to radio or television reception. However, there is no guarantee that harmful interference will not occur in a particular installation. If this equipment does cause interference to radio or television reception, which can be determined by turning the equipment on and off, the user is encouraged to correct the interference with one or more of the following measures: (a) Reorient or relocate the receiving antenna. (b) Increase the separation between the equipment and the receiver. (c) Connect the equipment to an outlet on a circuit different from that to which the receiver is connected. (d) Consult the supplier or an experienced radio/TV technician for help.

## FCC Compliance Statement (United States)

This equipment generates, uses and can radiate radio frequency energy and if not installed and used properly, that is, in strict accordance with the manufacturer's instructions, may cause interference to radio communication. It has been tested and found to comply with the limits for a class A computing device in accordance with the specifications in Subpart J of part 15 of FCC rules, which are designed to provide reasonable protection against such interference when the equipment is operated in a commercial environment. Operation of this equipment in a residential area may cause interference, in which case the user at his own expense will be required to take whatever measures may be necessary to correct the interference. Changes or modifications not expressly approved by the manufacturer could void the user's authority to operate the equipment.

## Canadian Department of Communications RFI statement

This equipment does not exceed the class A limits for radio noise emissions from digital apparatus set out in the radio interference regulations of the Canadian Department of Communications.

*Le présent appareil numérique n'émet pas de bruits radioélectriques dépassant les limites applicables aux appareils numériques de la classe A prescrites dans le règlement sur le brouillage radioélectriques publié par le ministère des Communications du Canada.*

© 2007 Adder Technology Limited  
All trademarks are acknowledged.  
Release 1.0d  
October 2007  
Part No. ADD0073

Adder Technology Limited,  
Technology House,  
Trafalgar Way, Bar Hill,  
Cambridge, CB3 8SQ,  
United Kingdom  
Tel: +44 (0)1954 780044  
Fax: +44 (0)1954 780081

Adder Corporation,  
29 Water Street,  
Newburyport,  
MA 01950,  
United States of America  
Tel: +1-888-932-3337  
Fax: +1-888-275-1117

Adder Asia Pacific  
6 New Industrial Road,  
Hoe Huat Industrial Building  
#07-01,  
Singapore 536199  
Tel: +65 6288 5767  
Fax: +65 6284 1150

CONTENTS

WELCOME

INSTALLATION  
& OPERATION

SPECIAL  
CONFIGURATION

FURTHER  
INFORMATION