

# Aspire 4736G/4736Z Series Service Guide

Service guide files and updates are available on the ACER/CSD web; for more information, please refer to <http://csd.acer.com.tw>

PRINTED IN TAIWAN

---

# Revision History

Please refer to the table below for the updates made to this service guide.

Date	Chapter	Updates

---

## Copyright

Copyright © 2009 by Acer Incorporated. All rights reserved. No part of this publication may be reproduced, transmitted, transcribed, stored in a retrieval system, or translated into any language or computer language, in any form or by any means, electronic, mechanical, magnetic, optical, chemical, manual or otherwise, without the prior written permission of Acer Incorporated.

## Disclaimer

The information in this guide is subject to change without notice.

Acer Incorporated makes no representations or warranties, either expressed or implied, with respect to the contents hereof and specifically disclaims any warranties of merchantability or fitness for any particular purpose. Any Acer Incorporated software described in this manual is sold or licensed *as is*. Should the programs prove defective following their purchase, the buyer (and not Acer Incorporated, its distributor, or its dealer) assumes the entire cost of all necessary servicing, repair, and any incidental or consequential damages resulting from any defect in the software.

Acer is a registered trademark of Acer Corporation.

Intel is a registered trademark of Intel Corporation.

Pentium and Pentium II/III are trademarks of Intel Corporation.

Other brand and product names are trademarks and/or registered trademarks of their respective holders.

---

## Conventions

The following conventions are used in this manual:

<b>SCREEN MESSAGES</b>	Denotes actual messages that appear on screen.
<b>NOTE</b>	Gives bits and pieces of additional information related to the current topic.
<b>WARNING</b>	Alerts you to any damage that might result from doing or not doing specific actions.
<b>CAUTION</b>	Gives precautionary measures to avoid possible hardware or software problems.
<b>IMPORTANT</b>	Reminds you to do specific actions relevant to the accomplishment of procedures.

---

## Preface

Before using this information and the product it supports, please read the following general information.

1. This Service Guide provides you with all technical information relating to the BASIC CONFIGURATION decided for Acer's *global* product offering. To better fit local market requirements and enhance product competitiveness, your regional office MAY have decided to extend the functionality of a machine (e.g. add-on card, modem, or extra memory capability). These LOCALIZED FEATURES will NOT be covered in this generic service guide. In such cases, please contact your regional offices or the responsible personnel/channel to provide you with further technical details.
2. Please note WHEN ORDERING FRU PARTS, that you should check the most up-to-date information available on your regional web or channel. If, for whatever reason, a part number change is made, it will not be noted in the printed Service Guide. For ACER-AUTHORIZED SERVICE PROVIDERS, your Acer office may have a DIFFERENT part number code to those given in the FRU list of this printed Service Guide. You MUST use the list provided by your regional Acer office to order FRU parts for repair and service of customer machines.



<b>System Specifications</b>	<b>1</b>
Features	1
System Block Diagram	4
Your Acer Notebook tour	5
Front View	5
Closed Front View	6
Left View	7
Right View	8
Rear View	8
Bottom View	9
Indicators	10
Easy-Launch Buttons	10
Touchpad Basics (with fingerprint reader)	11
Using the Keyboard	12
Lock Keys and embedded numeric keypad	12
Windows Keys	13
Hot Keys	14
Special Key	15
Using the System Utilities	16
Acer GridVista (dual-display compatible)	16
Hardware Specifications and Configurations	18
 <b>System Utilities</b>	 <b>29</b>
BIOS Setup Utility	29
Navigating the BIOS Utility	29
Information	30
Main	31
Security	32
Power	35
Boot	37
Exit	38
BIOS Flash Utility	39
DOS Flash Utility	40
WinFlash Utility	42
Remove HDD/BIOS Password Utilities	43
Removing BIOS Passwords:	44
Miscellaneous Utilities	46
 <b>Machine Disassembly and Replacement</b>	 <b>49</b>
Disassembly Requirements	49
General Information	50
Pre-disassembly Instructions	50
Disassembly Process	50
External Module Disassembly Process	51
External Modules Disassembly Flowchart	51
Removing the Battery Pack	52
Removing the SD dummy card	53
Removing the Lower Covers	54
Removing the WLAN Module	56
Removing the DIMM Modules	57
Removing the Hard Disk Drive Module	58
Removing the Optical Disk Drive Module	60
Main Unit Disassembly Process	62
Main Unit Disassembly Flowchart	62

# Table of Contents

Removing the Hinge Covers . . . . .	64
Removing the Switch Cover . . . . .	65
Removing the Keyboard . . . . .	67
Removing the Speaker Module . . . . .	68
Removing the LCD Module . . . . .	70
Removing the Upper Base . . . . .	75
Removing the Finger Print Reader . . . . .	78
Removing the TouchPad Bracket . . . . .	80
Removing the Media Board . . . . .	82
Removing the USB Board . . . . .	84
Removing the Modem Module . . . . .	86
Removing the Bluetooth Module . . . . .	87
Removing the Mainboard . . . . .	88
Removing the RJ-11 Port . . . . .	90
Removing the Thermal Module . . . . .	92
Removing the CPU . . . . .	94
LCD Module Disassembly Process . . . . .	95
LCD Module Disassembly Flowchart . . . . .	95
Removing the LCD Bezel . . . . .	96
Removing the Camera Module . . . . .	98
Removing the LCD Panel . . . . .	99
Removing the LCD Brackets and FPC Cable . . . . .	101
Removing the Antennas . . . . .	102
Removing the MIC Module . . . . .	103
LCD Module Reassembly Procedure . . . . .	104
Replacing the MIC Module . . . . .	104
Replacing the Antennas . . . . .	105
Replacing the LCD Panel . . . . .	108
Replacing the Camera Module . . . . .	110
Replacing the LCD Bezel . . . . .	111
Main Module Reassembly Procedure . . . . .	112
Replacing the CPU . . . . .	112
Replacing the Thermal Module . . . . .	113
Replacing the RJ-11 Port . . . . .	114
Replacing the Mainboard . . . . .	116
Replacing the Bluetooth Board . . . . .	117
Replacing the Modem Module . . . . .	117
Replacing the USB Board . . . . .	118
Replacing the Media Board . . . . .	119
Replacing the TouchPad Bracket . . . . .	121
Replacing the Finger Print Reader . . . . .	121
Replacing the Upper Cover . . . . .	123
Replacing the LCD Module . . . . .	126
Replacing the Speaker Module . . . . .	130
Replacing the Keyboard . . . . .	131
Replacing the Switch Cover . . . . .	132
Replacing the Hinge Covers . . . . .	134
Replacing the ODD Module . . . . .	135
Replacing the Hard Disk Drive Module . . . . .	136
Replacing the DIMM Modules . . . . .	136
Replacing the WLAN Module . . . . .	137
Replacing the Lower Covers . . . . .	137
Replacing the SD Card Dummy Trays . . . . .	138
Replacing the Battery . . . . .	138



# Table of Contents

<b>Troubleshooting</b>	<b>139</b>
Common Problems	139
Power On Issue	140
No Display Issue	141
Random Loss of BIOS Settings	142
LCD Failure	143
Built-In Keyboard Failure	143
Touchpad Failure	144
Internal Speaker Failure	144
Internal Microphone Failure	146
HDD Not Operating Correctly	147
ODD Failure	148
USB Failure (Rightside)	151
Modem Function Failure	151
Wireless Function Failure	152
Bluetooth Function Failure	152
EasyTouch Button Failure	153
Media Board Failure	153
Fingerprint Reader Failure	154
Thermal Unit Failure	154
External Mouse Failure	155
Other Failures	155
Intermittent Problems	156
Undetermined Problems	156
POST Codes Tables	157
Sec:	157
Memory:	157
BDS & Specific action:	158
Each PEIM entry point used in 80_PORT	159
Each Driver entry point used in 80_PORT	159
Each SmmDriver entry point used in 80_PORT	162
<b>Jumper and Connector Locations</b>	<b>163</b>
Top View	163
Bottom View	164
Clearing Password Check and BIOS Recovery	165
Clearing Password Check	165
BIOS Recovery by Crisis Disk	166
<b>FRU (Field Replaceable Unit) List</b>	<b>167</b>
Aspire 4736G/4736Z Series Exploded Diagrams	168
Main Module	168
Aspire 4736G/4736Z Series FRU List	169
Screw List	175
<b>Model Definition and Configuration</b>	<b>176</b>
Aspire 4736G/4736Z Series	176
<b>Test Compatible Components</b>	<b>177</b>
Microsoft® Windows® Vista Environment Test	178
<b>Online Support Information</b>	<b>183</b>
<b>Index</b>	<b>185</b>

# ***Table of Contents***

# System Specifications

---

## Features

Below is a brief summary of the computer's many features:

**NOTE:** Items marked with \* denote only selected models.

## Operating System

- Genuine Windows® Vista™

## Platform

- Intel® Centrino® 2 processor technology, featuring:
  - Intel® Core™ 2 Duo processor
  - Mobile Intel® PM45/GM45 Express Chipset\*
  - Intel® Wireless WiFi Link 5100/5300\*
  - Intel® Wireless WiFi Link 5150/5350\*

## System Memory

- Dual-Channel SDRAM support
- Up to 2 GB of DDRIII 800/1066 MHz memory, upgradeable to 4 GB using two SO-DIMM modules

## Display and graphics

- 16:9 aspect ratio
- 14" HD 1366 x 768
- Mobile Intel® GM45 Express Chipset
- NVIDIA® GeForce® 10MGE1

## Storage subsystem

- 2.5" hard disk drive
- Optical drive option:
  - Blu-ray Disc™ /DVD-Super Multi double-layer drive\*
  - DVD-Super Multi double-layer drive\*
- 5-in-1 card reader

## Audio

- Dolby®-optimized surround sound system with two built-in stereo speakers
- True 5.1-channel surround sound output
- High-definition audio support
- S/PDIF (Sony/Philips Digital Interface) support for digital speakers
- Acer PureZone technology with two built-in stereo microphones
- MS-Sound compatible

---

## Communication

- Acer Video Conference, featuring:
  - Integrated Acer Crystal Eye webcam\*
  - Acer PureZone technology\*
  - Optional Acer Xpress VoIP phone\*
- WLAN:
  - Intel® Wireless WiFi Link 5100/5300\*
- Wi-Fi®/WiMAX™:
  - Intel® Wireless WiFi Link 5150/5350\*
- WPAN: Bluetooth® 2.0+Enhanced Data Rate (EDR)\*
- LAN: Gigabit Ethernet; Wake-on-LAN ready
- Modem: 56K ITU V.92; Wake-on-Ring ready

## Dimensions and Weight

- 342 (W) x 239 (D) x 23/38.6 (H) mm (13.4 x 9.4 x 0.9/1.5 inches)
- 2.3 (5.07lbs) with 6-cell battery

## Privacy control

- Acer Bio-Protection fingerprint solution\*
- BIOS user, supervisor, HDD passwords
- Kensington lock slot

## Power subsystem

- ACPI 3.0
- 48.8 W 4400 mAh
- 3-pin 65 W AC adapter\*
- 3-pin 90 W AC adapter\*
- ENERGY STAR® 4.0\*

## Special keys and controls

- 88-/89-/93-key keyboard
- Touchpad pointing device

## I/O interface

- 5-in-1 card reader (SD/MMC/MS/MS PRO/xD)
- 3 USB 2.0 ports
- Consumer infrared (CIR) port
- HDMI™ port with HDCP support\*
- External display (VGA) port
- Headphones/speaker/line-out jack with S/PDIF support\*
- Microphone-in jack

- 
- Line-in jack
  - Ethernet (RJ-45) port
  - Modem (RJ-11) port
  - DC-in jack for AC adapter

## Environment

- Temperature:
  - Operating: 5 °C to 35 °C
  - Non-operating: -20 °C to 65 °C
- Humidity (non-condensing):
  - Operating: 20% to 80%
  - Non-operating: 20% to 80%

**NOTE:** Items marked with \* denote only selected models. The specifications listed above are for reference only. The exact configuration of your PC depends on the model purchased.

# System Block Diagram

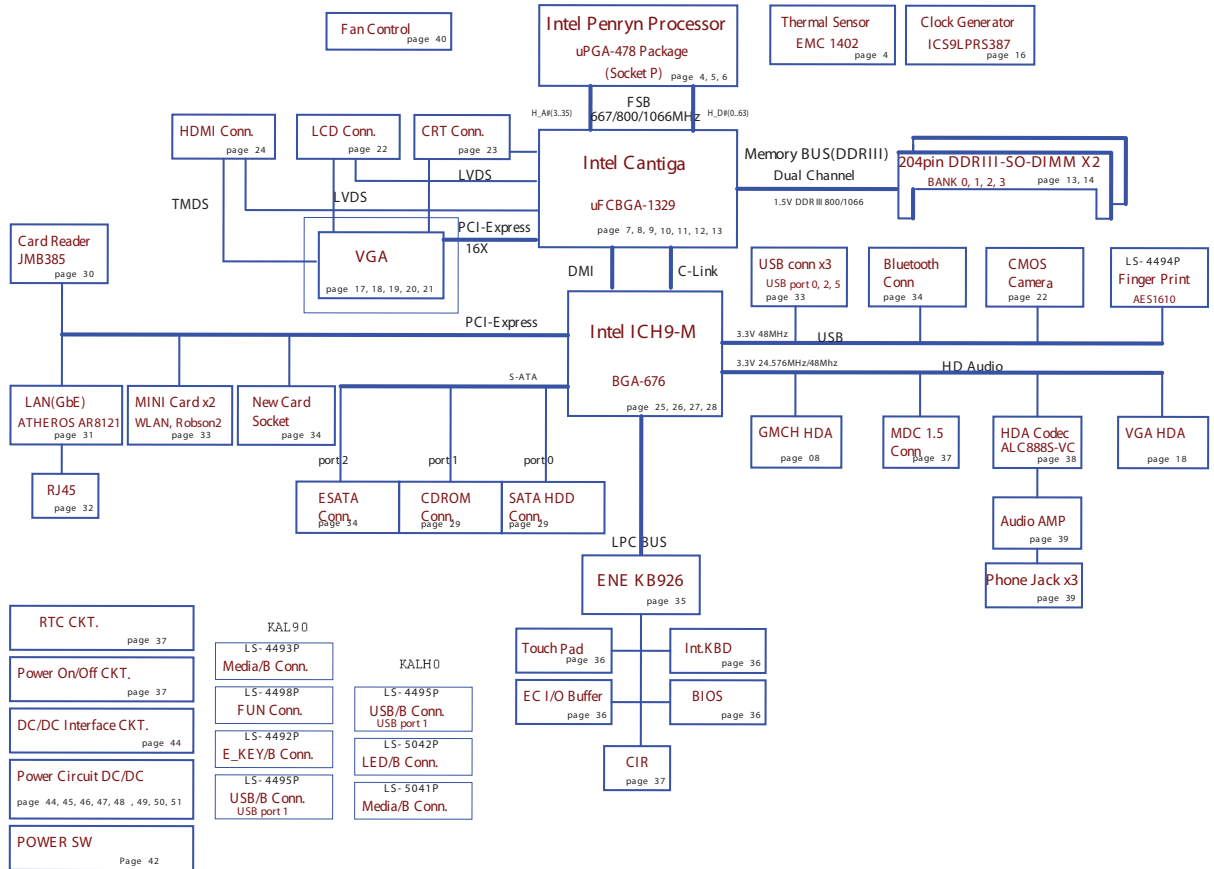





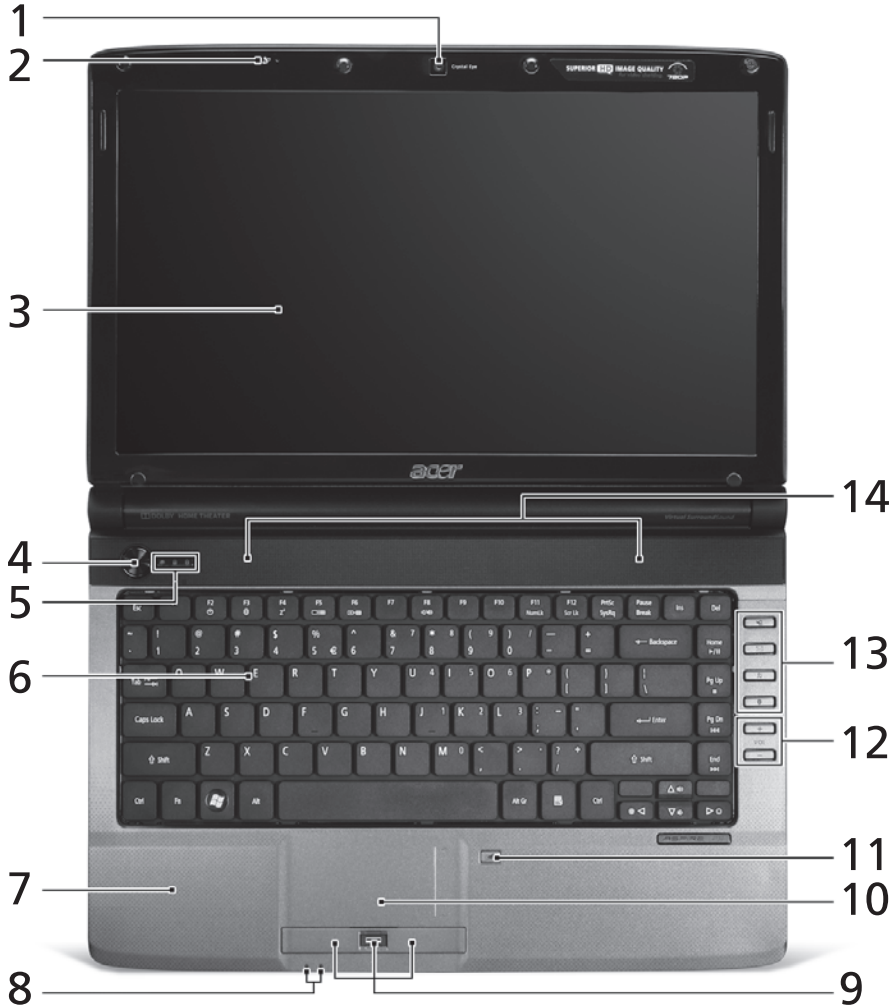

# Your Acer Notebook tour

After knowing your computer features, let us show you around your new computer.

## Front View



No.	Icon	Item	Description
1		Acer Crystal Eye webcam	Web camera for video communication (only for certain models).
2		Microphone	Internal microphone for sound recording.
3		Display screen	Also called Liquid-Crystal Display (LCD), displays computer output (Configuration may vary by models).
4		Power button	Turns the computer on and off.

No.	Icon	Item	Description
5		Status indicators	Light-Emitting Diodes (LEDs) that light up to show the status of the computer's functions and components.
6		Keyboard	For entering data into your computer.
7		Palmrest	Comfortable support area for your hands when you use the computer.
8		Status indicators	Light-Emitting Diodes (LEDs) that light up to show the status of the computer's functions and components.
9		Click buttons (left, center* and right)	The left and right buttons function like the left and right mouse buttons. *The center button serves as Acer Bio-Protection fingerprint reader supporting Acer FingerNav 4-way control function (only for certain models).
10		Touchpad	Touch-sensitive pointing device which functions like a computer mouse.
11		Touchpad Toggle	Turns the internal touchpad on and off.
12		Volume Up/ Volume Down	Increase system volume/decrease system volume.
13		Acer PowerSmart key	Puts your computer into power-saving mode.
		Backup key	Launches Acer Backup Management for three-step data backup.
		Wireless LAN communication button/indicator	Enables/disables the wireless LAN function. Indicates the status of wireless LAN communication.
		Bluetooth communication button/indicator	Enables/disables the Bluetooth function. Indicates the status of Bluetooth communication. (only for certain models)
14		Speakers	Left and right speakers deliver stereo audio output.

## Closed Front View









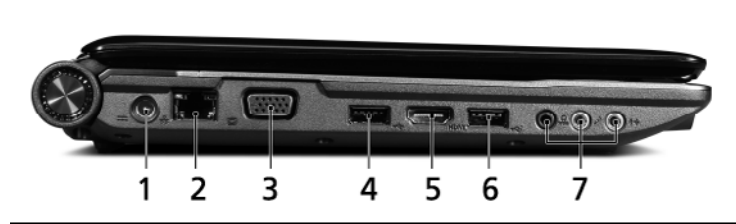

No.	Icon	Item	Description
1		5-in-1 card reader	Accepts Secure Digital (SD), MultiMediaCard (MMC), Memory Stick (MS), Memory Stick Pro (MS PRO), and xD-Picture Card. <b>Note:</b> Push to remove/install the card. Only one card can operate at any given time.







## Left View

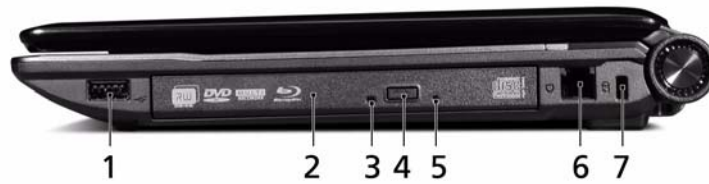

No.	Icon	Item	Description
1		DC in jack	Connects to an AC adapter
2		Ethernet (RJ-45) port	Connects to an Ethernet 10/100/1000-based network.
3		External display (VGA) port	Connects to a display device (e.g. external monitor, LCD projector).
4		USB 2.0	Connects to USB 2.0 devices.
5	HDMI	HDMI port	Supports high definition digital video connections.
6		USB 2.0 port	Connect to USB 2.0 devices (e.g. USB mouse, USB camera).
7		Headphones/speaker/line-out jack with S/PDIF support	Connects to audio line-out devices (e.g., speakers, headphones).
		Microphone jack	Accepts inputs from external microphones.
		Line-in jack	Accepts audio line-in devices (e.g., audio CD player, stereo walkman, mp3 player).

## Right View



No.	Icon	Item	Description
1		USB 2.0 port	Connect to USB 2.0 devices (e.g. USB mouse, USB camera).
2		Optical drive	Internal optical drive; accepts CDs or DVDs.
3		Optical disk access indicator	Lights up when the optical drive is active.
4		Optical drive eject button	Ejects the optical disk from the drive.
5		Emergency eject hole	Ejects the optical drive tray when the computer is turned off. <b>Note:</b> Insert a paper clip into the emergency eject hole to eject the optical drive tray when the computer is off.
6		Modem (RJ-11) port	Connects to a phone line.
7		Kensington lock slot	Connects to a Kensington-compatible computer security lock.





## Rear View

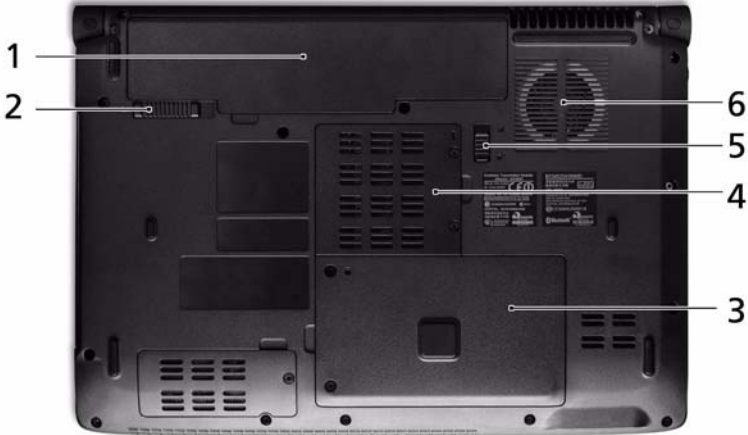

No.	Item	Description
1	Ventilation slots	Enable the computer to stay cool, even after prolonged use.

# Bottom View







No.	Icon	Item	Description
1		Battery bay	Houses the computer's battery pack.
2		Battery release latch	Releases the battery for removal.
3		Hard disk bay	Houses the computer's hard disk (secured with screws).
4		Memory compartment	Houses the computer's main memory.
5		Battery lock	Locks the battery in position.
6		Ventilation slots and cooling fan	Enable the computer to stay cool, even after prolonged use. <b>Note:</b> Do not cover or obstruct the opening of the fan.

---

## Indicators

The computer has several easy-to-read status indicators:

The front panel indicators are visible even when the computer cover is closed.





Icon	Function	Description
	Power	Indicates the computer's power status.
	Battery	Indicates the computer's battery status.
	HDD	Indicates when the hard disk drive is active.
	Num Lock	Lights up when Num Lock is activated.
	Caps Lock	Lights up when Caps Lock is activated.

**NOTE:** 1. **Charging:** The battery light shows amber when the battery is charging. 2. **Fully charged:** The light shows green when in AC mode.

## Easy-Launch Buttons

Located beside the keyboard are application buttons. These buttons are called easy-launch buttons. They are: WLAN, Internet, email, Bluetooth, Arcade and Acer Empowering Technology.

The mail and Web browser buttons are pre-set to email and Internet programs, but can be reset by users. To set the Web browser, mail and programmable buttons, run the Acer Launch Manager.

Icon	Function	Description
	Wireless communication switch	Enables/disables the wireless function.
	Web browser	Internet browser (user-Programmable)
	Mail	Email application (user-Programmable)
	Bluetooth communication switch	Enables/disables the Bluetooth function.
	Empowering Technology	Launch Acer Empowering Technology. (user-programmable)

# Touchpad Basics (with fingerprint reader)

The following items show you how to use the touchpad with Acer Bio-Protection fingerprint reader:

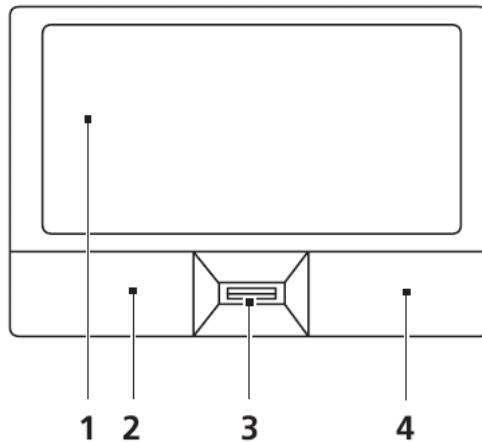

- Move your finger across the touchpad (1) to move the cursor.
- Press the left (2) and right (4) buttons located beneath the touchpad to perform selection and execution functions. These two buttons are similar to the left and right buttons on a mouse. Tapping on the touchpad is the same as clicking the left button.
- Use Acer Bio-Protection fingerprint reader (3) supporting Acer FingerNav 4-way control function (only for certain models) or the 4-way scroll (3) button (only for certain models) to scroll up or down and move left or right a page. This fingerprint reader or button mimics your cursor pressing on the right scroll bar of Windows applications.

Function	Left Button (2)	Right Button (4)	Main touchpad (1)
Execute	Quickly click twice.		Tap twice (at the same speed as double-clicking a mouse button).
Select	Click once.		Tap once.
Drag	Click and hold, then use finger on the touchpad to drag the cursor.		Tap twice (at the same speed as double-clicking a mouse button); rest your finger on the touchpad on the second tap and drag the cursor.
Access context menu		Click once.	

**NOTE:** When using the touchpad, keep it - and your fingers - dry and clean. The touchpad is sensitive to finger movement; hence, the lighter the touch, the better the response. Tapping too hard will not increase the touchpad's responsiveness.

# Using the Keyboard

The keyboard has full-sized keys and an embedded numeric keypad, separate cursor, lock, Windows, function and special keys.

## Lock Keys and embedded numeric keypad

The keyboard has three lock keys which you can toggle on and off.





















Lock key	Description
Caps Lock	When Caps Lock is on, all alphabetic characters typed are in uppercase.
Num Lock <Fn> + <F11>	When Num Lock is on, the embedded keypad is in numeric mode. The keys function as a calculator (complete with the arithmetic operators +, -, *, and /). Use this mode when you need to do a lot of numeric data entry. A better solution would be to connect an external keypad.
Scroll Lock <Fn> + <F12>	When Scroll Lock is on, the screen moves one line up or down when you press the up or down arrow keys respectively. Scroll Lock does not work with some applications.

The embedded numeric keypad functions like a desktop numeric keypad. It is indicated by small characters located on the upper right corner of the keycaps. To simplify the keyboard legend, cursor-control key symbols are not printed on the keys.

Desired access	Num Lock on	Num Lock off
Number keys on embedded keypad	Type numbers in a normal manner.	
Cursor-control keys on embedded keypad	Hold <Shift> while using cursor-control keys.	Hold <Fn> while using cursor-control keys.
Main keyboard keys	Hold <Fn> while typing letters on embedded keypad.	Type the letters in a normal manner.

# Windows Keys

The keyboard has two keys that perform Windows-specific functions.

Key	Description
 Windows key	<p>Pressed alone, this key has the same effect as clicking on the Windows Start button; it launches the Start menu. It can also be used with other keys to provide a variety of functions:</p> <ul style="list-style-type: none"> <li>&lt;  &gt;: Open or close the Start menu</li> <li>&lt;  &gt; + &lt;D&gt;: Display the desktop</li> <li>&lt;  &gt; + &lt;E&gt;: Open Windows Explore</li> <li>&lt;  &gt; + &lt;F&gt;: Search for a file or folder</li> <li>&lt;  &gt; + &lt;G&gt;: Cycle through Sidebar gadgets</li> <li>&lt;  &gt; + &lt;L&gt;: Lock your computer (if you are connected to a network domain), or switch users (if you're not connected to a network domain)</li> <li>&lt;  &gt; + &lt;M&gt;: Minimizes all windows</li> <li>&lt;  &gt; + &lt;R&gt;: Open the Run dialog box</li> <li>&lt;  &gt; + &lt;T&gt;: Cycle through programs on the taskbar</li> <li>&lt;  &gt; + &lt;U&gt;: Open Ease of Access Center</li> <li>&lt;  &gt; + &lt;X&gt;: Open Windows Mobility Center</li> <li>&lt;  &gt; + &lt;BREAK&gt;: <b>Display</b> the System Properties dialog box</li> <li>&lt;  &gt; + &lt;SHIFT+M&gt;: Restore minimized windows to the desktop</li> <li>&lt;  &gt; + &lt;TAB&gt;: Cycle through programs on the taskbar by using Windows Flip 3-D</li> <li>&lt;  &gt; + &lt;SPACEBAR&gt;: Bring all gadgets to the front and select Windows Sidebar</li> <li>&lt;CTRL&gt; + &lt;  &gt; + &lt;F&gt;: Search for computers (if you are on a network)</li> <li>&lt;CTRL&gt; + &lt;  &gt; + &lt;TAB&gt;: Use the arrow keys to cycle through programs on the taskbar by using Windows Flip 3-D</li> </ul> <p><b>Note:</b> Depending on your edition of Windows Vista, some shortcuts may not function as described.</p>
 Application key	<p>This key has the same effect as clicking the right mouse button; it opens the application's context menu.</p>

# Hot Keys

The computer employs hotkeys or key combinations to access most of the computer's controls like screen brightness, volume output and the BIOS utility.

To activate hot keys, press and hold the <Fn> key before pressing the other key in the hotkey combination.



Hotkey	Icon	Function	Description
<Fn> + <F1>	?	Hotkey help	Displays help on hotkeys.
<Fn> + <F2>		Acer eSettings Management	Launches Acer eSettings Management in Acer Empowering Technology.
<Fn> + <F3>		Acer ePower Management	Launches Acer ePower Management in Acer Empowering Technology.
<Fn> + <F4>	Z <sup>Z</sup>	Sleep	Puts the computer in Sleep mode.
<Fn> + <F5>		Display toggle	Switches display output between the display screen, external monitor (if connected) and both.
<Fn> + <F6>		Screen blank	Turns the display screen backlight off to save power. Press any key to return.
<Fn> + <F7>		Touchpad toggle	Turns the internal touchpad on and off.
<Fn> + <F8>		Speaker toggle	Turns the speakers on and off.
<Fn> + <▷>		Brightness up	Increases the screen brightness.
<Fn> + <◁>		Brightness down	Decreases the screen brightness.



---

## Special Key

You can locate the Euro symbol and the US dollar sign at the upper-center and/or bottom-right of your keyboard.



### The Euro symbol

1. Open a text editor or word processor.
2. Hold <Alt Gr> and then press the <5> key at the upper-center of the keyboard.

**NOTE: Note:** Some fonts and software do not support the Euro symbol. Please refer to [www.microsoft.com/typography/faq/faq12.htm](http://www.microsoft.com/typography/faq/faq12.htm) for more information.

### The US dollar sign

1. Open a text editor or word processor.
2. Hold <Shift> and then press the <4> key at the upper-center of the keyboard.

**NOTE:** This function varies by the operating system version.

# Using the System Utilities

Acer Bio-Protection (only for certain models) Acer Bio-Protection Fingerprint Solution is a multi-purpose fingerprint software package integrated with the Microsoft Windows operating system. Utilizing the uniqueness of one's fingerprint features, Acer Bio-Protection Fingerprint Solution has incorporated protection against unauthorized access to your computer with centralized password management with Password Bank, easy music player launching with Acer MusicLaunch, secure Internet favorites via Acer MyLaunch, and fast application/website launching and login with Acer FingerLaunch, while Acer ProfileLaunch can launch up to three applications/websites from a single finger swipe.

Acer Bio-Protection Fingerprint Solution also allows you to navigate through web browsers and documents using Acer FingerNav. With Acer Bio-Protection Fingerprint Solution, you can now enjoy an extra layer of protection for your personal computer, as well as the convenience of accessing your daily tasks with a simple swipe of your finger!

For more information refer to the Acer Bio-Protection help files.

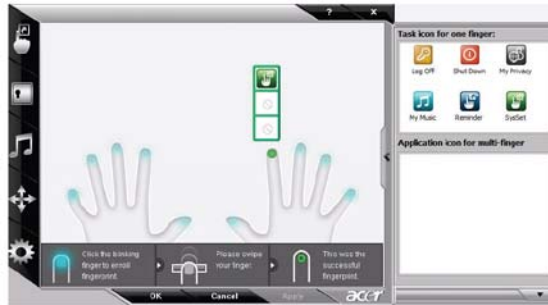

## Acer GridVista (dual-display compatible)

**NOTE:** This feature is only available on certain models.

To enable the dual monitor feature of the notebook, first ensure that the second monitor is connected, then select **Start, Control Panel, Display** and click on **Settings**. Select the secondary monitor (**2**) icon in the display box and then click the check box **Extend my windows desktop onto this monitor**. Finally, click **Apply** to confirm the new settings and click **OK** to complete the process.

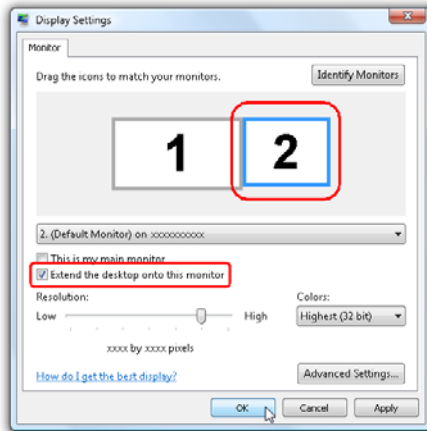

Acer GridVista is a handy utility that offers four pre-defined display settings so you can view multiple windows on the same screen. To access this function, please go to **Start → All Programs** and click on **Acer GridVista**. You may choose any one of the four display settings indicated below:



Double (vertical), Triple (primary at left), Triple (primary at right), or Quad Acer GridVista is dual-display compatible, allowing two displays to be partitioned independently.

Acer GridVista is dual-display compatible, allowing two displays to be partitioned independently.

AcerGridVista is simple to set up:

1. Run Acer GridVista and select your preferred screen configuration for each display from the task bar.
2. Drag and drop each window into the appropriate grid.
3. Enjoy the convenience of a well-organized desktop.

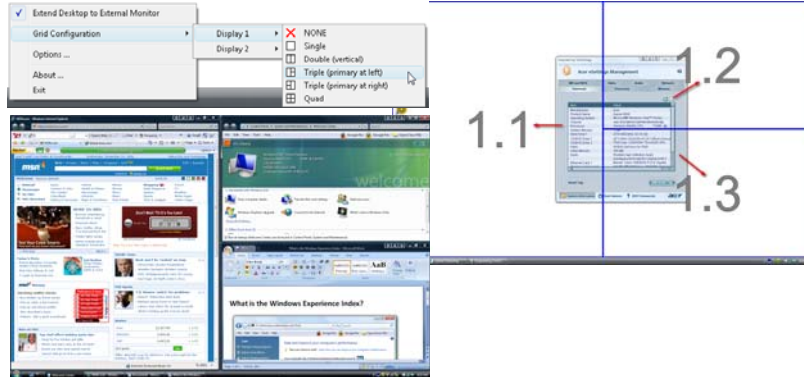

**NOTE:** Please ensure that the resolution setting of the second monitor is set to the manufacturer's recommended value.

# Hardware Specifications and Configurations

## Processor

Item	Specification
CPU Type	Intel Core 2 Duo T6400 PGA 2.0G 3M 800 35W r-0 (see Processor Specification below for more information)
Core Logic	Intel Cantiga GM—800/1066MHz FSB supported Intel Cantiga PM—800/1066MHz FSB supported ICH9-M
CPU Package	Micro uPGA-478 Package
CPU Core Voltage	Refer to table below

## Processor Specifications

Processor #	CPU Speed	Cores	Bus Speed	Mfg Tech	Cache Size	Package	Core Voltage	Acer P/N
T1600	1.66 GHz	2	667		1 MB	uPGA		KC.16001.CMT
T6400	2.0 GHz	2	800		3 MB	uPGA		KC.64001.DTP
T6600	2.2 GHz	2	800		2 MB	uPGA		KC.66001.DTP
P7450	2.13 GHz	2	1066		3 MB	uPGA		KC.74501.DPP
T4200	2.4 GHz	2	800		2 MB	uPGA		KC.42001.DTP

## System Board Major Chips

Item	Specifications
Core logic	Intel Cantiga PM45 / GM45 (667/800/1066MHz FSB supported) ICH9-M
VGA	<ul style="list-style-type: none"> <li>NB10MGE1-512MB-DDR3</li> <li>Integrated VGA solution for CANTIGA GM / On board VGA card for CANTIGA PM</li> </ul>
LAN	ATHEROS AR8121 for Giga LAN
Media Card Reader	JMICRON JMB385
Audio Codec	REALTEK ALC888S-VC for High Definition Audio Codec with Dolby Digital Live

## CPU Fan True Value Table

CPU Temperature (°C)		Fan Speed (rpm)	SPL Spec (dBA)
Core1	Core 2		
50	50	-	-
66	66	3200	31
74	74	3500	34
85	85	3900	37
100	100	4300	40

- Throttling 50%: On =100°C; Off=90°C
- OS Shut down: 105°C
- H/W Shut down: 96°C

## BIOS ROM

Item	Specification
BIOS Vendor	Insyde H20

Item	Specification
BIOS Version	V0.09
BIOS ROM Type	Flash ROM
BIOS ROM Size	1 MB
Supported Protocols	<ul style="list-style-type: none"> <li>• Support ISIPP</li> <li>• Support Acer UI</li> <li>• Support multi-boot</li> <li>• Suspend to RAM (S3)/Disk (S4)</li> <li>• Various hot-keys for system control</li> <li>• Support SMBUS 2.0, PCI2.3</li> <li>• ACPI 2.0 compliance with Intel Speed Step Support C1, C2, C3, C4 and S3, S4 for mobile CPU</li> <li>• DMI utility for BIOS serial number configurable/asset tag</li> <li>• Support PXE</li> <li>• Support Y2K solution</li> <li>• Support Win Flash Wake on LAN from S3</li> <li>• Wake on LAN form S4 in AC mode</li> <li>• System information</li> </ul>
BIOS Password control	Supervisor, User, and HDD

## System Memory

Item	Specifications
Memory Controller	Onboard
Memory Size	0MB (No on-board Memory)
DIMM socket number	2 sockets
Supports Memory size per socket	2 GB
Support maximum memory size	8 GB for 64bit OS (with two 2GB SO-DIMM)
Support DIMM type	DDR III Synchronous DRAM
Support DIMM Speed	800/1066 MHz
Support DIMM voltage	1.5V
Support DIMM package	204-pin DDR III-800/1066 SO-DIMM
Cache	6MB L2 on CPU
VGA Memory	512 MB with optional adjustable 128MB UMA VGA memory share from North Bridge
Memory module combinations	You can install memory modules in any combination as long as they match the above specifications

## Memory Combinations

Slot 1	Slot 2	Total Memory
0MB	512MB	512MB
0MB	1024MB	1024MB
0MB	2048MB	2048MB
512MB	512MB	1024MB
512MB	1024MB	1536MB
512MB	2048MB	2560MB
1024MB	0MB	1024MB
1024MB	512MB	1536MB
1024MB	1024MB	2048MB
1024MB	2048MB	3072MB
2048MB	0MB	2048MB
2048MB	512MB	2560MB
2048MB	1024MB	3072MB
2048MB	2048MB	4096MB
4096MB	4096MB	8192MB

**NOTE:** Above table lists some system memory configurations. You may combine DIMMs with various capacities to form other combinations. On above table, the configuration of slot 1 and slot 2 could be reversed.

### Hard Disk Drive Interface

Item	Specifications				
Vendor & Model Name	Seagate ST9250827AS	Seagate ST9320320AS ST9160310AS	Seagate ST9500325AS	Toshiba MK3252GSX MK2552GSX MK1652GSX	WD WD5000BEVT WD3200BEVT WD2500BEVT WD1600BEVT
Capacity (MB)	250	320, 160	500	320, 250, 160	500, 320, 250, 160
Bytes per sector	512	512	512	512	512
Data heads	4	4, 2	4	4, 4, 2	4, 3, 2, 2
Drive Format					
Disks	2	2 or 1, 1	2	2, 2, 1	2, 2, 1, 1
Spindle speed (RPM)	5400	5400	5400	5400	5400
Performance Specifications					
Buffer size	8 MB	8 MB	8 MB	8 MB	8 MB
Interface	SATA	SATA	SATA	SATA	SATA
Internal transfer rate (Mbits/sec, max)	778	352	1,175	400 ~ 794 typical	106 Mbits/s maximum
I/O data transfer rate (Mbytes/sec max)	300	150	300	300	300 maximum
DC Power Requirements					
Voltage	5V ±5%	5V ±5%	5V ±5%	5V ±5%	5V ±5%

### Super-Multi Combo Module

Item	Specification	
Vendor & model name	Philips DS-8A2S, Toshiba Digi/TS-L633A	
Performance Specification	With CD Diskette	With DVD Diskette
Transfer rate (MB/sec)	Sustained: Max 3.5 Mbytes/sec	Sustained: Max 10 Mbytes/sec
Buffer Memory	2MB	
Interface	SATA	
Applicable disc format	Applicable media types: Writing: Confirms to DVD+R Version 1.2 and DVD+RW Version 1.3 / DVD+R DL Version 1.0 / DVD-R Version 2.0 / DVD-RW Version 1.2 / DVD-R DL Version 3.0. Reading: DVD single/dual layer (PTP, OTP), DVD-R single/dual layer DVD+R single/double layer DVD-RW DVD+RW CD-DA CD-ROM CD-ROM/XA Photo-CD, Multi-session, Video CD CD-I FMV, CD Extra, CD Plus, CD-R, and CD-RW	
Loading mechanism	Drawer (Solenoid Open) Tact SW (Open) Emergency Release (draw open hole)	
Power Requirement		
Input Voltage	DC 5 V +/- 5%	



### Super-Multi Combo Module (continued)

Item	Specification			
Vendor & model name	HLDS GT10N		Sony AD7580S	
Performance Specification	With CD Diskette	With DVD Diskette	With CD Diskette	With DVD Diskette
Transfer rate (MB/sec)	Sustained: 3,600 KB/s (24x) max.	Sustained: 11.08 Mbytes/s (8x) max.	Sustained: 1,571 (typical)	Sustained: 10,993 (typical)
Buffer Memory	2 MB			
Interface	SATA			
Applicable disc formats	<ul style="list-style-type: none"> <li>• DVD-ROM:               <ul style="list-style-type: none"> <li>• 4.7GB (Single Layer)</li> <li>• 8.5GB (Dual Layer)</li> </ul> </li> <li>• DVD-R:               <ul style="list-style-type: none"> <li>• 3.95GB (Ver. 1.0: read only)</li> <li>• 4.7GB (Ver. 2.0 for Authoring: read only)</li> <li>• 4.7GB (Ver. 2.1 for General: read &amp; write)</li> <li>• (DL) 8.5GB (Ver. 3.0)</li> </ul> </li> <li>• DVD-RW:               <ul style="list-style-type: none"> <li>• 4.7GB (Ver. 1.2/ Rev 1.0, 2.0, 3.0)</li> </ul> </li> <li>• DVD-RAM: 1.46GB/side, 4.7GB/side (Ver. 2.2)</li> <li>• DVD+R: 4.7GB (Ver. 1.3)               <ul style="list-style-type: none"> <li>• (DL) 8.5GB (Ver. 1.1)</li> </ul> </li> <li>• DVD+RW:               <ul style="list-style-type: none"> <li>• 4.7GB (Vol.1 Ver.1.3)</li> </ul> </li> <li>• CD-ROM Mode-1 data disc</li> <li>• CD-ROM Mode-2 data disc</li> <li>• CD-ROM XA, CD-I, Photo-CD Multi-Session, Video CD</li> <li>• CD-Audio Disc</li> <li>• Mixed mode CD-ROM disc (data and audio)</li> <li>• CD-Extra</li> <li>• CD-Text</li> <li>• CD-R (Conforming to "Orange Book Part 2": read &amp; write)</li> <li>• CD-RW (Conforming to "Orange Book Part 3": read &amp; write)</li> </ul>		DVD Read: DVD-ROM (DVD-5, DVD-9, DVD-10, DVD-18), DVD-Video, DVD-Audio, SACD (Hybrid), UDF DVD, DVD-R, DVD-R DL, DVD-R 3.95 GB, DVD-R Authoring, DVD-R Multi-Border, DVD-RW, DVD+R, DVD+R DL, DVD+R Multi-Session, DVD+RW, DVD-RAM V1.0, DVDRAM V2.0 & 2.1 & 2.2.  CD Read: CD-DA, CD-ROM Mode-1, CD-ROM/XA Mode-2 Form-1 and Mode-2 Form-2, CD-i, CD-i Bridge, Video-CD (MPEG-1), Karaoke CD, Photo-CD, Enhanced CD, CD Plus, CD Extra, itrax CD, CD-Text, UDF CD, CD-R, and CD-RW  DVD Write: DVD Data & Video  CD Read: CD-DA, CD-ROM Mode-1, CD-ROM/XA Mode-2 Form-1 and Mode-2 Form-2, CD-i, Video-CD, CD-Text	
Loading mechanism	Drawer (Solenoid Open) Tact SW (Open) Emergency Release (draw open hole)			
Power Requirement				
Input Voltage	DC 5 V +/- 5%			

## Blueray Combo Drive

Item	Specification
Manufacturer and Model	Sony NEC Optiarc BC-5500S-AR
Type	Drawer loading
Interface	SATA
Data Transfer Modes	<ul style="list-style-type: none"> <li>• PIO mode</li> <li>• DMA</li> <li>• Ultra DMA33</li> </ul>
Buffer Memory Size	4.5 MB
Maximum Write Speed	11 Mbytes/sec
Maximum Read Speed	9 Mbytes/sec
Formats Supported	<p>Read</p> <ul style="list-style-type: none"> <li>• BD-Video (12cm, Single and Dual Layer), BD-ROM (12cm, Single and Dual Layer)</li> <li>• DVD-Video (8cm/12cm, Single and Dual Layer), DVD-ROM (8cm/12cm, Single and Dual Layer), Multi-Boarder, Multi-Session</li> </ul> <p>CD Write</p> <ul style="list-style-type: none"> <li>• CD-R Media (48x/40x/32x/24x/16x/8x) Mitsubishi (Verbatim), Taiyo-Yuden, Mitsui, Ricoh, Fuji film, Sony, Hitachi Maxell, Memorex, RITEK, CMC, P.V.C, JVC, SKC, ACER, Prime Disc, TDK</li> <li>• CD-RW Media (10x/4x) Ricoh, Mitsubishi (Verbatim), ACER, OPTROM, Memorex, P.V.C, RITEK, CMC, LEADDATA, GigaStorage, Prodisc, Fornex, Samsung, Philips</li> </ul> <p>DVD Write</p> <ul style="list-style-type: none"> <li>• DVD+R Media (16x/8x/4x/2.4x) Taiyo-Yuden, Mitsubishi (Verbatim), Ricoh, TDK</li> <li>• DVD+R Double Layer Media (8x/2.4x) Mitsubishi (Verbatim)</li> <li>• DVD+RW Media (8x/4x/2.4x) Mitsubishi (Verbatim), Ricoh, TDK</li> <li>• DVD-R Media (16x/8x/4x/2x) Mitsubishi (Verbatim), TDK, Taiyo-Yuden, PVC, Fuji Film, Ritek</li> <li>• DVD-R DL Media (8x/4x) Mitsubishi (Verbatim)</li> <li>• DVD-RW Media (6x/4x/2x/1x) JVC, PVC, Mitsubishi (Verbatim), TDK</li> <li>• DVD-RAM Ver2.2 Media (5x/3x/2x) Panasonic, Hitachi Maxell</li> </ul>
Power Supply	+5V (DC)
Voltage Allowance	+5V (DC) ±5%

**LCD 14"**

Item	Specification			
Vendor/model name	<ul style="list-style-type: none"> <li>• Samsung LTN140AT01-G01</li> <li>• AUO B140XW01</li> <li>• LG LP140WH1</li> <li>• CMO N140B6 - L02</li> </ul>			
Screen Diagonal (mm)	355.6 (14.0")			
Display Area (mm)	309.399(H) X 173.952(V)			
Display resolution (pixels)	1366 x 768			
Pixel Pitch	0.2265(H) x 0.2265(V)			
Display Mode	Normally white			
Typical White Luminance (cd/m <sup>2</sup> ) (also called Brightness)	220 (typ.)			
Contrast Ratio (typical)	500			
Response Time (Optical Rise Time/Fall Time) msec	8 (typ.)			
Input Voltage	3.3V ±0.3V			
Typical Power Consumption (watt)	5W (max.)			
Weight	375g (max.)			
Physical Size (mm)	324.0(H) x 192.5(V) x 5.2(D)			
Electrical Interface	LVDS			
Support Color	262,144			
Viewing Angle (degree)			Min.	Typ.
	Horizontal	CR => 10	40	45
			40	45
	Vertical		10	15
25			30	
Temperature Range (°C)				
Operating	0 to 50°C			
Storage (shipping)	-20 to 60°C			

### VGA Graphic Controller

Item	Specification
Type	NB10MGE1-512MB-DDR3
Features	•
Power	
Package	

### Keyboard

Item	Specification
Keyboard Controller	ENE KB926
Total number of keypads	88-/89-/93-key
Windows logo key	Yes
Internal & external keyboard work simultaneously	Yes

### Media Card Reader

Item	Specification
Type	JMICRON JMB385
Features	6-in-1 Card Reader

### Audio Interface

Item	Specification
Audio Controller	REALTEK ALC888S-VC
Audio onboard or option	Onboard
Mono or Stereo	Stereo
Internal Microphone	AC-coupled input, 100mV <sub>P-P</sub> maximum
Internal speaker/ Quantity	2 * 4 Ohm 2W Main Speakers

### LAN

Item	Specification
Type	ATHEROS AR8121 for GIGA LAN
Features	10/100/1000 MHz

### CIR

Item	Specification
Type	
Features	•
Power	
Package	

### Bluetooth

Item	Specification
Type	
Features	•
Power	

---

### Finger Print Reader

Item	Specification
Type	AES1610
Power	
Package	

### WLAN

Item	Specification
Chipset	•
Protocol	
Interface	
Antenna	

### Battery

Item	Specifications (3S2P)
Vendor & model name	<ul style="list-style-type: none"><li>• SONY AS-2007A</li><li>• Panasonic AS-2007A</li><li>• Simplo AS-2007A</li><li>• Sanyo AS-2007A</li></ul>
Battery Type	Li-ion
Pack capacity	4400 mAh
Number of battery cell	6
Package configuration	3S2P



# System Utilities

---

## BIOS Setup Utility

The BIOS Setup Utility is a hardware configuration program built into your computer's BIOS (Basic Input/Output System).

Your computer is already properly configured and optimized, and you do not need to run this utility. However, if you encounter configuration problems, you may need to run Setup. Please also refer to Chapter 4 Troubleshooting when problem arises.

To activate the BIOS Utility, press **F2** during POST (when **Press <F2> to enter Setup** message is prompted on the bottom of screen).

Press **F2** to enter setup. The default parameter of F12 Boot Menu is set to "disabled". If you want to change boot device without entering BIOS Setup Utility, please set the parameter to "enabled".

Press **<F12>** during POST to enter multi-boot menu. In this menu, user can change boot device without entering BIOS SETUP Utility.

## Navigating the BIOS Utility

There are six menu options: Information, Main, Advanced, Security, Power, Boot, and Exit.

Follow these instructions:

- To choose a menu, use the left and right arrow keys.
- To choose an item, use the up and down arrow keys.
- To change the value of a parameter, press **F5** or **F6**.
- A plus sign (+) indicates the item has sub-items. Press **Enter** to expand this item.
- Press **Esc** while you are in any of the menu options to go to the Exit menu.
- In any menu, you can load default settings by pressing **F9**. You can also press **F10** to save any changes made and exit the BIOS Setup Utility.

**NOTE:** You can change the value of a parameter if it is enclosed in square brackets. Navigation keys for a particular menu are shown on the bottom of the screen. Help for parameters are found in the Item Specific Help part of the screen. Read this carefully when making changes to parameter values. **Please note that system information is subject to different models.**

# Information

The Information screen displays a summary of your computer hardware information.

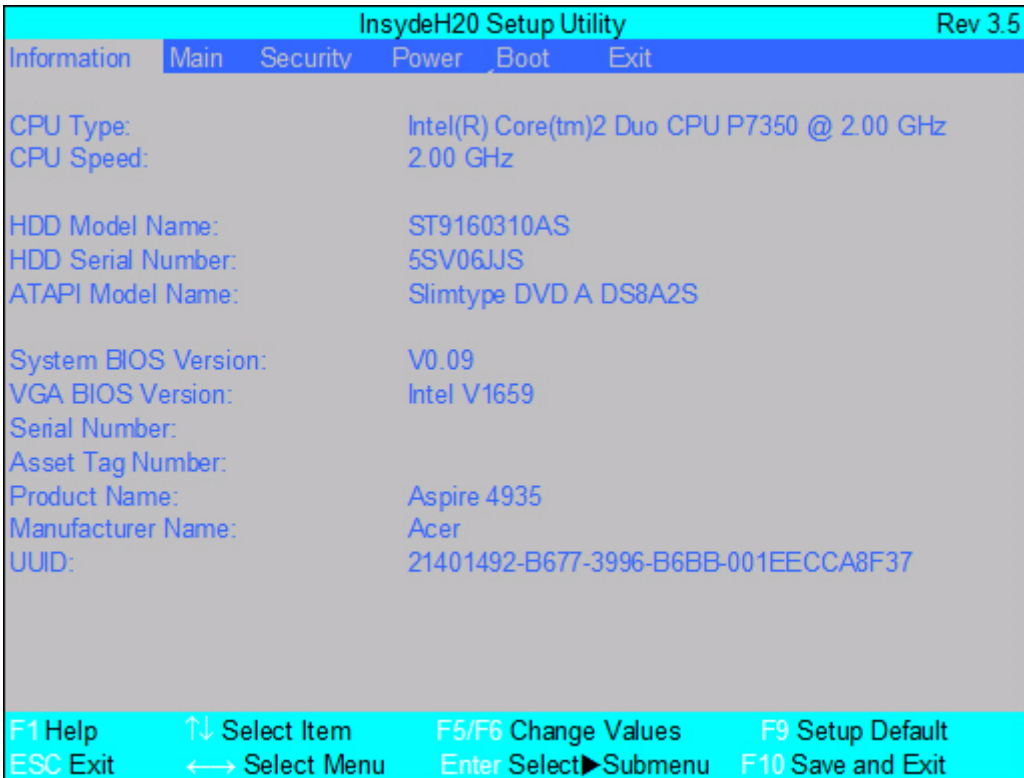

**NOTE:** The system information is subject to different models.

Parameter	Description
CPU Type	This field shows the CPU type and speed of the system.
CPU Speed	This field shows the speed of the CPU.
HDD Model Name	This field shows the model name of HDD installed on primary IDE master.
HDD Serial Number	This field displays the serial number of HDD installed on primary IDE master.
ATAPI Model Name	This field displays the model name of the installed ODD drive.
System BIOS Version	Displays system BIOS version.
VGA BIOS Version	This field displays the VGA firmware version of the system.
Serial Number	This field displays the serial number of this unit.
Asset Tag Number	This field displays the asset tag number of the system.
Product Name	This field shows product name of the system.
Manufacturer Name	This field displays the manufacturer of this system.
UUID Number	Universally Unique Identifier (UUID) is an identifier standard used in software construction, standardized by the Open Software Foundation (OSF) as part of the Distributed Computing Environment (DCE).



# Main

The Main screen allows the user to set the system time and date as well as enable and disable boot option and recovery.

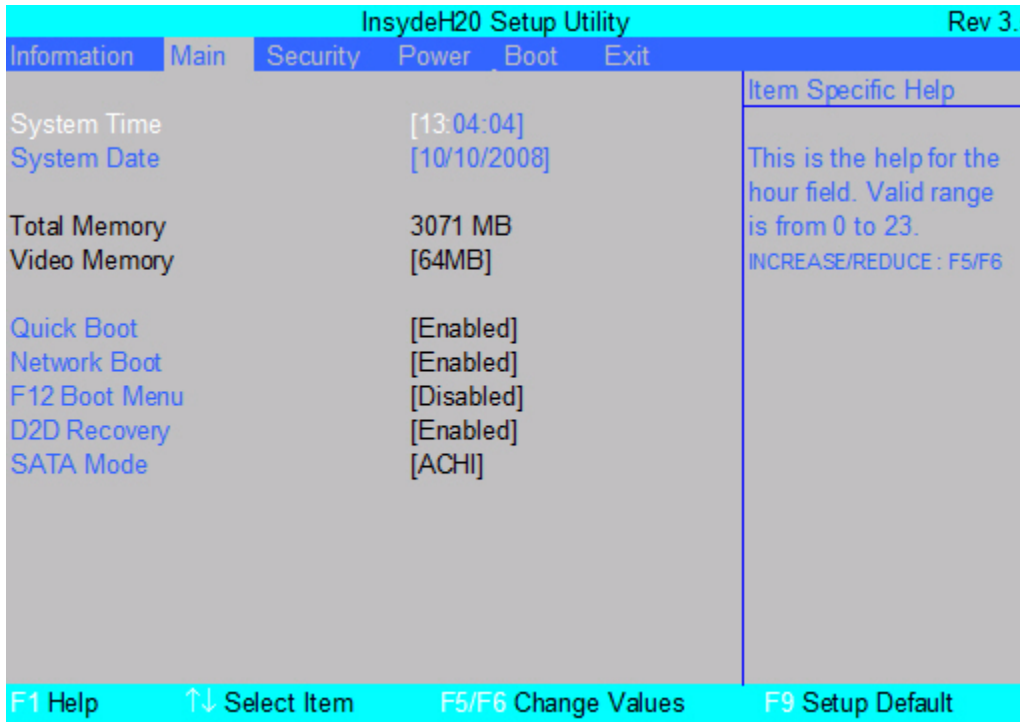

**NOTE:** The screen above is for your reference only. Actual values may differ.

The table below describes the parameters in this screen. Settings in **boldface** are the default and suggested parameter settings.

Parameter	Description	Format/Option
System Time	Sets the system time. The hours are displayed with 24-hour format.	Format: HH:MM:SS (hour:minute:second)
System Date	Sets the system date.	Format MM/DD/YYYY (month/day/year)
Total Memory	This field reports the memory size of the system. Memory size is fixed to 3071 MB.	N/A
Video Memory	This field reports the video Memory size.	N/A
Quick Boot	Enables the boot sequence to skip some processes to boot up more quickly.	Option: <b>Enabled</b> or Disabled
Network Boot	Enables, disables the system boot from LAN (remote server).	Option: <b>Enabled</b> or Disabled
F12 Boot Menu	Enables or disables the <b>Press &lt;F12&gt; to display boot menu</b> message during startup.	Option: <b>Enabled</b> or Disabled
D2D Recovery	Enables, disables D2D Recovery function. The function allows the user to create a hidden partition on hard disc drive to store operation system and restore the system to factory defaults.	Option: <b>Enabled</b> or Disabled
SATA Mode	Control the mode in which the SATA controller should operate.	Option: <b>AHCI</b> or IDE

# Security

The Security screen contains parameters that help safeguard and protect your computer from unauthorized use.

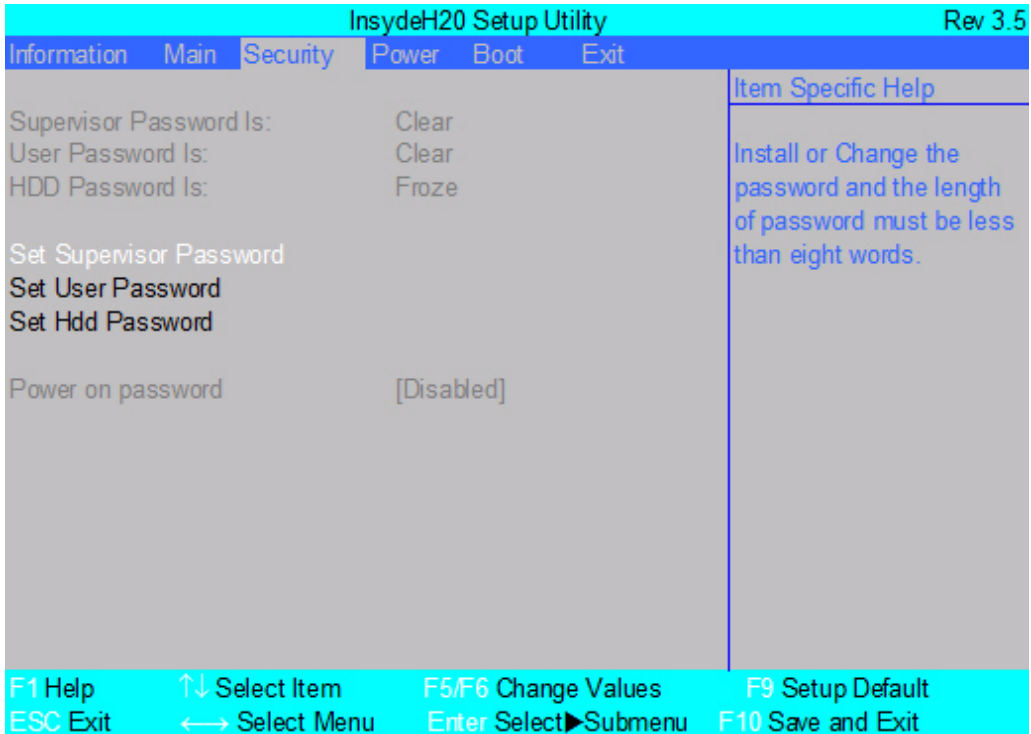

The table below describes the parameters in this screen. Settings in **boldface** are the default and suggested parameter settings.

Parameter	Description	Option
Supervisor Password Is	Shows the setting of the Supervisor password	<b>Clear</b> or Set
User Password Is	Shows the setting of the user password.	<b>Clear</b> or Set
HDD Password Is	Shows the setting of the hard disk password.	Clear, Set, or <b>Frozen</b>
Set Supervisor Password	Press Enter to set the supervisor password. When set, this password protects the BIOS Setup Utility from unauthorized access. The user can not either enter the Setup menu nor change the value of parameters.	N/A
Set User Password	Press Enter to set the user password. When user password is set, this password protects the BIOS Setup Utility from unauthorized access. The user can enter Setup menu only and does not have right to change the value of parameters.	N/A
Set Hdd Password	Press Enter to set the Hdd password. When Hdd password is set, this password protects the Hdd from unauthorized access.	N/A
Power on password	Defines whether a password is required or not while the system powers on.	<b>Disabled</b> or Enabled

**NOTE:** When you are prompted to enter a password, you have three tries before the system halts. Don't forget your password. If you forget your password, you may have to return your notebook computer to your dealer to reset it.

---

## Setting a Password

Follow these steps as you set the user or the supervisor password:

1. Use the ↑ and ↓ keys to highlight the Set Supervisor Password parameter and press the **Enter** key. The Set Supervisor Password box appears:

```
Set Supervisor Password
Enter New Password    [          ]
Confirm New Password  [          ]
```

2. Type a password in the “Enter New Password” field. The password length can not exceeds 8 alphanumeric characters (A-Z, a-z, 0-9, not case sensitive). Retype the password in the “Confirm New Password” field.

**IMPORTANT:** Be very careful when typing your password because the characters do not appear on the screen.

3. Press **Enter**. After setting the password, the computer sets the User Password parameter to “Set”.
4. If desired, you can opt to enable the Password on boot parameter.
5. When you are done, press F10 to save the changes and exit the BIOS Setup Utility.

## Removing a Password

Follow these steps:

1. Use the ↑ and ↓ keys to highlight the Set Supervisor Password parameter and press the **Enter** key. The Set Password box appears:

```
Set Supervisor Password
Enter current password [          ]
Enter New Password    [          ]
Confirm New Password  [          ]
```

2. Type the current password in the Enter Current Password field and press **Enter**.
3. Press **Enter** twice **without** typing anything in the Enter New Password and Confirm New Password fields. The computer then sets the Supervisor Password parameter to “Clear”.
4. When you have changed the settings, press u to save the changes and exit the BIOS Setup Utility.

---

## Changing a Password

1. Use the ↑ and ↓ keys to highlight the Set Supervisor Password parameter and press the **Enter** key. The Set Password box appears.

```
Set Supervisor Password
Enter current password  [          ]
Enter New Password     [          ]
Confirm New Password   [          ]
```

2. Type the current password in the Enter Current Password field and press **Enter**.
3. Type a password in the Enter New Password field. Retype the password in the Confirm New Password field.
4. Press **Enter**. After setting the password, the computer sets the User Password parameter to "Set".
5. If desired, you can enable the Password on boot parameter.
6. When you are done, press **F10** to save the changes and exit the BIOS Setup Utility.

If the verification is OK, the screen will display as following.

```
Setup Notice
Changes have been saved.
[ continue]
```

The password setting is complete after the user presses **Enter**.

If the current password entered does not match the actual current password, the screen will show you the Setup Warning.

```
Setup Warning
Invalid password
Re-enter Password
[ continue]
```

If the new password and confirm new password strings do not match, the screen displays the following message.

```
Setup Warning
Password do not match
Re-enter Password
```

# Power

The Power screen allows the user to configure CPU and power management options.

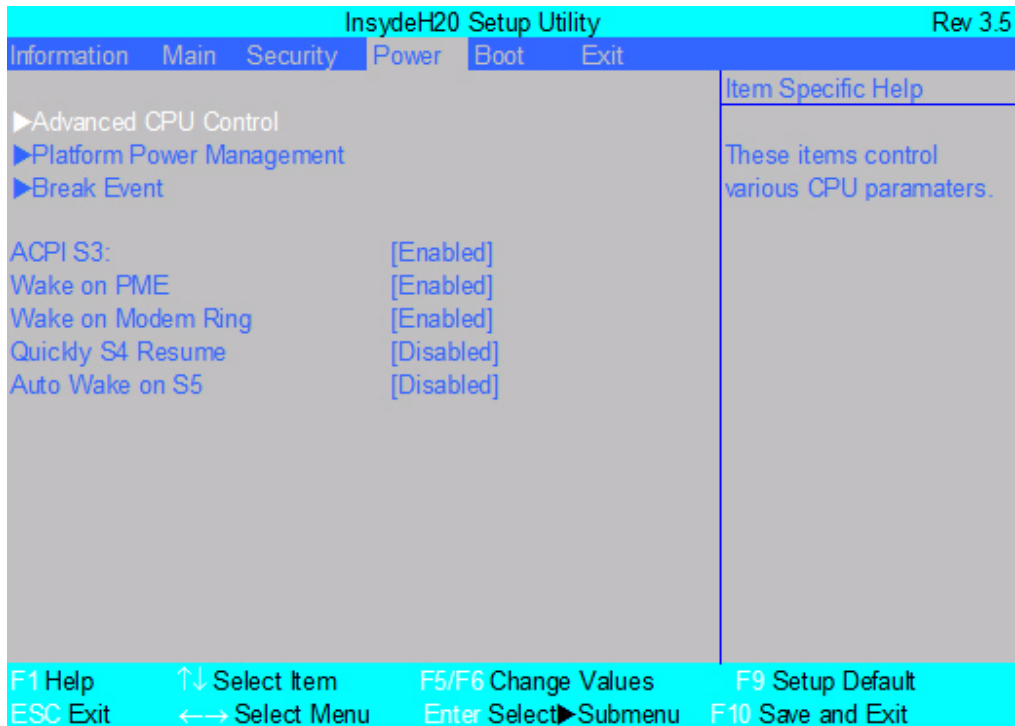

The table below describes the parameters in this screen. Settings in **boldface** are the default and suggested parameter settings.

Parameter	Description	Submenu Items
Advanced CPU Control	Enter the Advanced CPU Control menu.	<ul style="list-style-type: none"> <li>• P-States (IST)</li> <li>• Boot performance mode</li> <li>• Thermal Mode</li> <li>• CMP Support</li> <li>• Use XD capability</li> <li>• VT Support</li> <li>• SMRR Support</li> <li>• C-States</li> <li>• Enhanced C-States</li> <li>• C-State Pop Up Mode</li> <li>• C-State Pop Down Mode</li> <li>• C4 Exit Timing Mode</li> <li>• DeepC4</li> <li>• Hard C4E</li> <li>• Enable C6</li> <li>• EMTTM</li> <li>• Bi-directional PROCHOT#</li> <li>• Dynamic FSB Switching</li> <li>• Turbo Mode</li> <li>• ACPI 3.0 T-States</li> <li>• DTS</li> <li>• DTS Calibration</li> <li>• Thermal Trip Points Setting (Fan On Temp., Throttle On Temp.)</li> </ul>

Parameter	Description	Submenu Items
Platform Power Management	Enter the Platform Power Management menu.	<ul style="list-style-type: none"> <li>• PCI Clock Run</li> </ul>
Break Event	Enter the Break Event menu.	<ul style="list-style-type: none"> <li>• Storage Break Event</li> <li>• PCIE Break Event</li> <li>• PCI Break Event</li> <li>• EHCI Break Event</li> <li>• UHCI Break Event</li> <li>• HDA Break Event</li> </ul>
ACPI S3	<b>Enable</b> or Disable ACPI S1/S3 Sleep State.	N/A
Wake on PME	<b>Enable</b> or Disable wake up when the system power is off and a PCI Power Management Enable wake up event occurs.	N/A
Wake on Modem Ring	<b>Enable</b> or Disable wake up when the system power is off and a modem attached to the serial port is ringing.	N/A
Quickly S4 Resume	<b>Disable</b> or Enable optional quick boot from S4 Resume.	N/A
Auto wake on S5	<b>Disable</b> or Enable auto wake up by date and time or at a fixed time everyday.	N/A

# Boot

This menu allows the user to decide the order of boot devices to load the operating system. Bootable devices includes the USB diskette drives, the onboard hard disk drive and the DVD drive in the module bay.

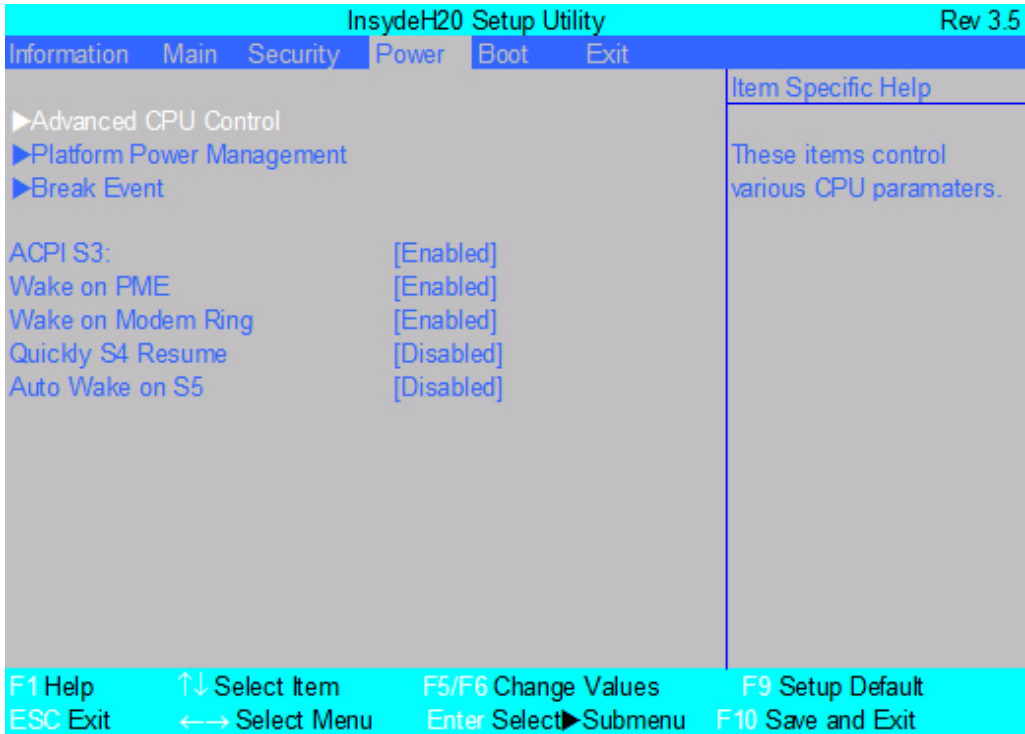

# Exit

The Exit screen allows you to save or discard any changes you made and quit the BIOS Utility.

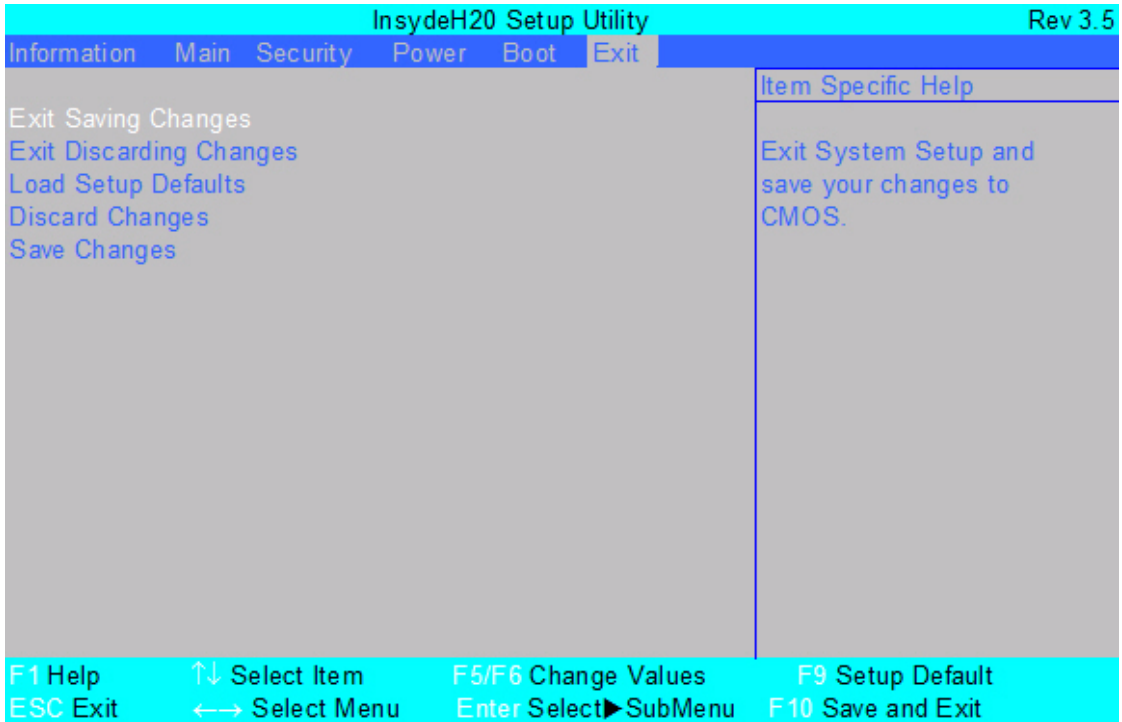

The table below describes the parameters in this screen.

Parameter	Description
Exit Saving Changes	Exit System Setup and save your changes to CMOS.
Exit Discarding Changes	Exit utility without saving setup data to CMOS.
Load Setup Default	Load default values for all SETUP item.
Discard Changes	Load previous values from CMOS for all SETUP items.
Save Changes	Save Setup Data to CMOS.



---

# BIOS Flash Utility

The BIOS flash memory update is required for the following conditions:

- New versions of system programs
- New features or options
- Restore a BIOS when it becomes corrupted.

Use the Phlash utility to update the system BIOS flash ROM.

**NOTE:** If you do not have a crisis recovery diskette at hand, then you should create a Crisis Recovery Diskette before you use the Phlash utility.

**NOTE:** Do not install memory-related drivers (XMS, EMS, DPMI) when you use the Phlash.

**NOTE:** Please use the AC adaptor power supply when you run the Phlash utility. If the battery pack does not contain enough power to finish BIOS flash, you may not boot the system because the BIOS is not completely loaded.

Follow the steps below to run the Phlash.

1. Prepare a bootable diskette.
2. Copy the flash utilities to the bootable diskette.
3. Then boot the system from the bootable diskette. The flash utility has auto-execution function.

# DOS Flash Utility

Perform the following steps to use the DOS Flash Utility:

1. Press F2 during boot to enter the Setup Menu.
2. Select **Boot Menu** to modify the boot priority order, for example, if using USB HDD to Update BIOS, move USB HDD to position 1.



3. Execute the **FLASH.BAT** batch file to update BIOS.

The flash process begins as shown.

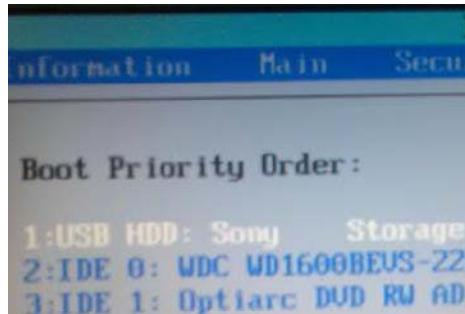

4. In flash BIOS, the message **Please do not remove AC Power Source** displays.

**NOTE:** If the AC power is not connected, the following message displays.

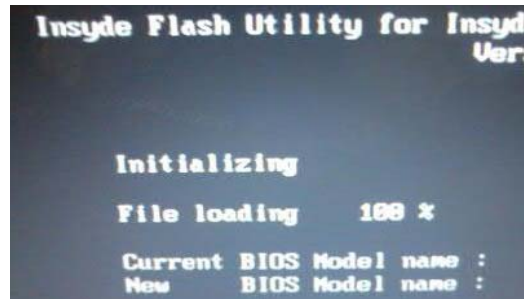

Plug in the AC power to continue.

5. Flash is complete when the message Flash programming complete displays.

---

## WinFlash Utility

Perform the following steps to use the WinFlash Utility:

1. Double click the WinFlash executable.
2. Click **OK** to begin the update. A progress screen displays.



3. When the process is complete, close all programs and applications and reboot the system.

---

# Remove HDD/BIOS Password Utilities

This section provide you with removing HDD/BIOS method:

## Remove HDD Password:

When the user keys in the wrong password three times, the system reports the following error code to user.

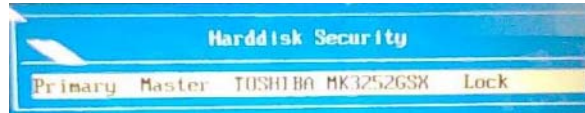

To unlock the HDD password, perform the following steps:

1. Press **Enter** to display the Select Item screen.

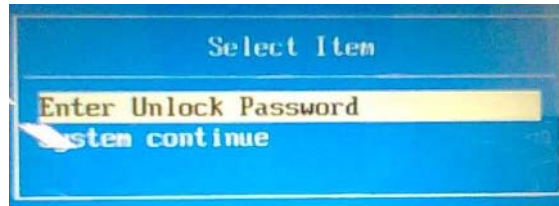

2. Select **Enter Unlock Password** and press **Enter**.

An Unlock Password displays.



3. Make a note of the key, **76943488** in the example.
4. Boot up the system to a removable bootable drive containing DOS and the UnlockHD.EXE program and open a DOS prompt. For instructions on changing boot priority see "Boot" on page 37.
5. Enter the **UnlockHD.EXE** command and input the key to create an unlock code. Make a note of the result, for example **46548274**.
6. Reboot and enter the BIOS by pressing F2 when prompted.
7. Go to the Security menu and select Set Hdd Password.



8. Enter the unlock code generated by UnlockHD.EXE as the current password, **46548274** in the example, and complete the **New Password** and **Confirm** fields to create a new HDD password.
9. Save and exit the BIOS to complete the process.

---

## Removing BIOS Passwords:

If you key in the wrong Supervisor Password three times, System Disabled displays on the screen. See the image below.

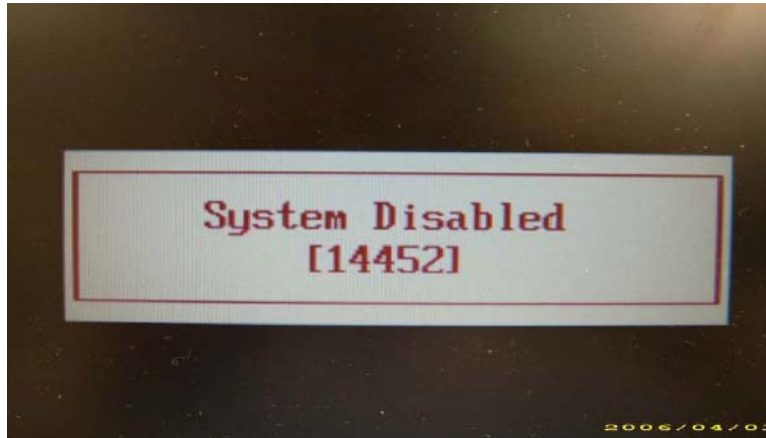

To reset the BIOS password, run BIOS\_PW.EXE as follows:

1. Key in **bios\_pw 14452 0**
2. Select one string from the list.

```
C:\WINDOWS\system32\cmd.exe
Microsoft Windows XP [Version 5.1.2600]
Copyright 1985-2001 Microsoft Corp.
C:\Documents and Settings\M54>d:
D:\>bios_pw 14452 0 1.
unlockb.exe v1.0 I July 1997
qjlg9vy
07yqmjd
cjl14tm
6mbzjaj 2.
D:\>_
```

3. Reboot the system and key in the selected string (qjlg9vy, 07yqmjd etc.) for the BIOS user password.

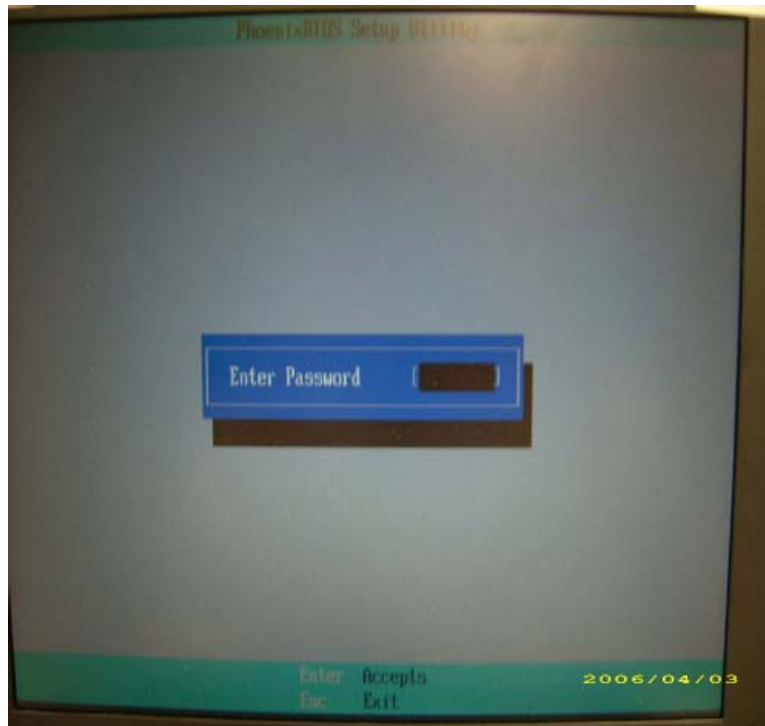

### Cleaning BIOS Passwords

To clear the password, perform the following steps:

1. From a DOS prompt, Execute **clnpwd.exe**

```
d:\Clnpwd>clnpwd
ACER Clean Password Utility V1.00
Press 1 or 2 to clean any password shown as below
    1.User Password
    2.Supervisor Password

Clean User Password Successfully!
```

2. Press 1 or 2 to clean the desired password shown on the screen.  
The onscreen message determines whether the function is successful or not.

---

# Miscellaneous Utilities

## Using Boot Sequence Selector

Boot Sequence Selector allows the boot order to be changes without accessing the BIOS. To use Boot Sequence Selector, perform the following steps:

1. Enter into DOS.
2. Execute **BS.exe** to display the usage screen.

```
d:\B00TSEQ>bs
*** Boot Sequence Selector Version 0.03 ***
Create by Rockwell Chuang 10/01/2005.
Usage:
      BS [ 1 | 2 | 3 | 4 ]
BS 1 : [ Floppy ] => [ HardDisk ] => [ CD-ROM ] => [ LAN   ]
BS 2 : [ HardDisk ] => [ CD-ROM ] => [ LAN   ] => [ Floppy ]
BS 3 : [ CD-ROM ] => [ HardDisk ] => [ LAN   ] => [ Floppy ]
BS 4 : [ LAN   ] => [ Floppy ] => [ HardDisk ] => [ CD-ROM ]
d:\B00TSEQ>
```

3. Select the desired boot sequence by entering the corresponding sequence, for example, enter BS2 to change the boot sequence to HDD|CD ROM|LAN|Floppy.

## Using DMITools

The DMI (Desktop Management Interface) Tool copies BIOS information to eeprom to be used in the DMI pool for hardware management.

When the BIOS displays **Verifying DMI pool data** it is checking the table correlates with the hardware before sending to the operating system (Windows, etc.).

To update the DMI Pool, perform the following steps:

1. Enter into DOS.
2. Execute **dmitools.exe**. The following messages show dmitools usage:
  - dmitools /r ==> Read dmi string from memory
  - dmitools /wm xxxx ==> Write manufacturer name to EEPROM (max. 16 characters)
  - dmitools /wp xxxx ==> Write product name to EEPROM (max. 16 characters)
  - dmitools /ws xxxx ==> Write serial number to EEPROM (max. 22 characters)
  - dmitools /wu xxxx ==> Write uuid to EEPROM (Ignore String)
  - dmitools /wa xxxx ==> Write asset tag to EEPROM (max. 32 characters)

**NOTE:** The following write examples (2 to 5) require a system reboot to take effect

### Example 1: Read DMI Information from Memory

Input:

```
dmitools /r
```

Output:

```
Manufacturer (Type1, Offset04h): Acer
Product Name (Type1, Offset05h): eMachines xxxxx
Serial Number (Type1, Offset07h): 01234567890123456789
UUID String (Type1, Offset08h): xxxxxxxx-xxxx-xxxx-xxxx-xxxxxxxxxxxx
Asset Tag (Type3, Offset04h): Acer Asstag
```



---

**Example 2: Write Product Name to EEPROM**

Input:

```
dmitools /wp Acer
```

**Example 3: Write Serial Number to EEPROM**

Input:

```
dmitools /ws 01234567890123456789
```

**Example 4: Write UUID to EEPROM**

Input:

```
dmitools /wu
```

**Example 5: Write Asset Tag to EEPROM**

Input:

```
dmitools /wa Acer Asstag
```



# Machine Disassembly and Replacement

---

This chapter contains step-by-step procedures on how to disassemble the notebook computer for maintenance and troubleshooting.

## Disassembly Requirements

To disassemble the computer, you need the following tools:

- Wrist grounding strap and conductive mat for preventing electrostatic discharge
- Flat screwdriver
- Philips screwdriver
- Plastic flat screwdriver
- Plastic tweezers

**NOTE:** The screws for the different components vary in size. During the disassembly process, group the screws with the corresponding components to avoid mismatch when putting back the components.

---

# General Information

## Pre-disassembly Instructions

Before proceeding with the disassembly procedure, make sure that you do the following:

1. Turn off the power to the system and all peripherals.
2. Unplug the AC adapter and all power and signal cables from the system.



3. Place the system on a flat, stable surface.
4. Remove the battery pack.

## Disassembly Process

The disassembly process is divided into the following stages:

- External module disassembly
- Main unit disassembly
- LCD module disassembly

The flowcharts provided in the succeeding disassembly sections illustrate the entire disassembly sequence. Observe the order of the sequence to avoid damage to any of the hardware components. For example, if you want to remove the main board, you must first remove the keyboard, then disassemble the inside assembly frame in that order.

### Main Screw List

Description	Quantity	Acer P/N
M2.0D 3.0L K4.6D 0.8T ZK	17	86.AD302.001
M2.5D 3.0L K5.5D 0.8T ZK	15	86.AD302.002
M2.5D 5L K 5.5D ZK NL	21	86.AD302.003
M2.5D 10.0L K 5.5D 0.8T ZK	12	86.AD302.004
M3.0D 3.0L K 4.9D NI+	4	86.AD302.005
M2.5D 3.2L K 6D NI+	4	86.AD302.006

# External Module Disassembly Process

## External Modules Disassembly Flowchart

The flowchart below gives you a graphic representation on the entire disassembly sequence and instructs you on the components that need to be removed during servicing. For example, if you want to remove the main board, you must first remove the keyboard, then disassemble the inside assembly frame in that order.

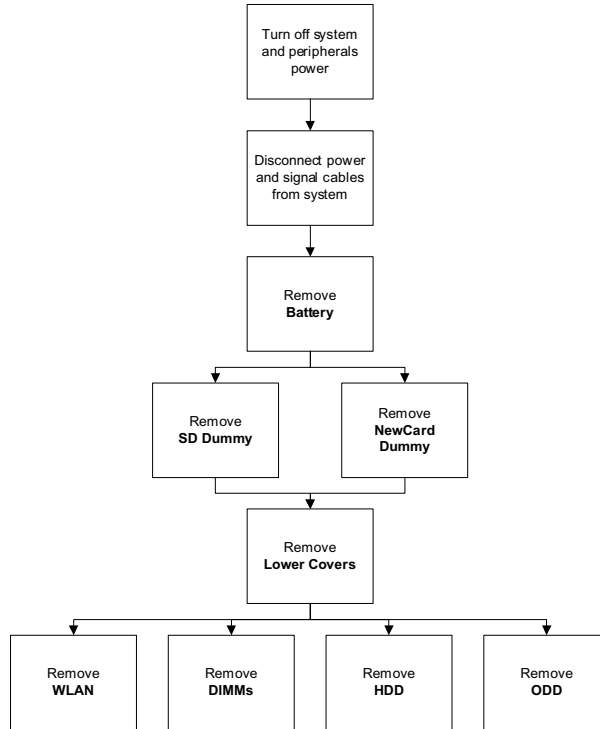

### Screw List

Step	Screw	Quantity	Part No.
WLAN Module	M2*3	2	86.AD302.001
HDD Carrier	M3*3	4	86.AD302.005
ODD Module	M2.5*5	1	86.AD302.003
ODD Bracket	M2*3	2	86.AD302.001

---

## Removing the Battery Pack

1. Turn computer over.
2. Slide the battery lock/unlock latch to the unlock position.



3. Slide and hold the battery release latch to the release position (1), then lift out the battery pack from the main unit (2).

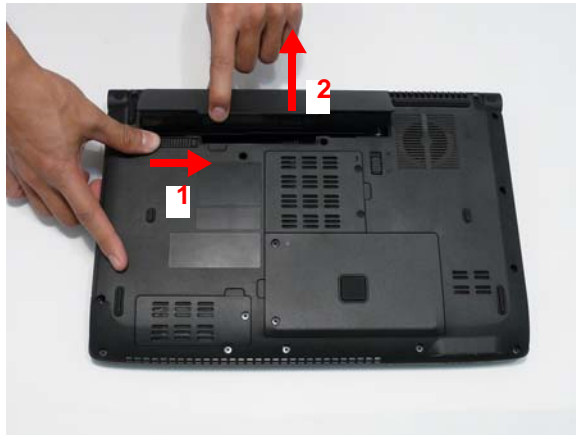

---

## Removing the SD dummy card

1. Push the SD dummy card all the way in to eject it.



2. Pull it out from the slot.



---

## Removing the Lower Covers

1. See “Removing the Battery Pack” on page 52.
2. See “Removing the SD dummy card” on page 53.
3. Loosen the five captive screws in the covers as shown.

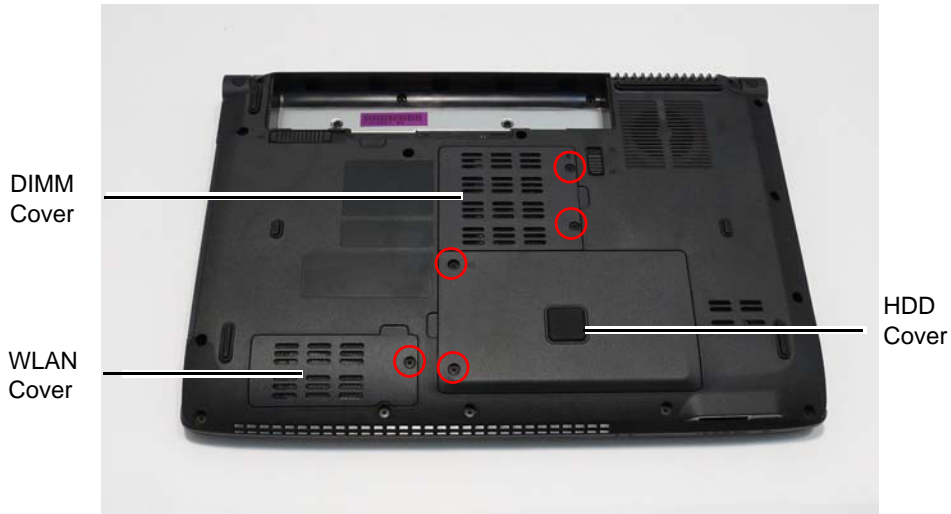

4. Carefully open the DIMM Cover.

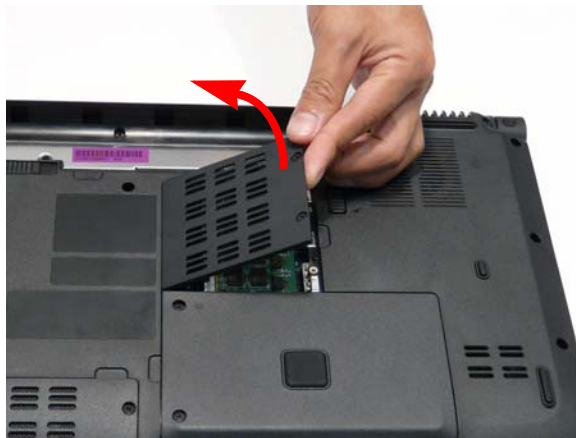

5. Remove the WLAN Cover as shown.





---

6. Carefully open the HDD Cover.

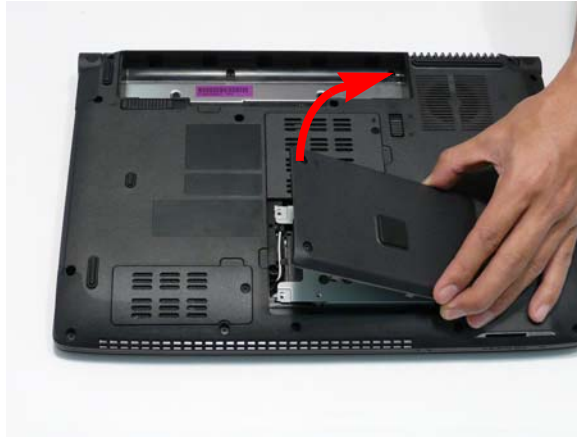

# Removing the WLAN Module

1. See "Removing the Lower Covers" on page 54.
2. Disconnect the two antenna cables.



3. Remove the two securing screws.



Step	Size	Quantity	Screw Type
WLAN Module	M2*3	2	

4. Remove the WLAN module as shown.



---

## Removing the DIMM Modules

1. See “Removing the Lower Covers” on page 54.
2. Push out the release latches on both sides of the DIMM socket to release the DIMM module.

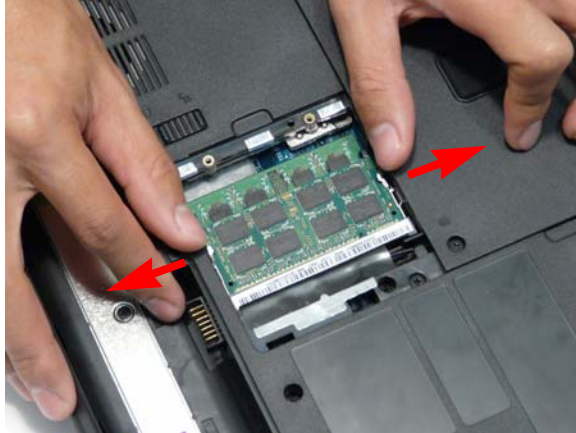

3. Remove the DIMM module.

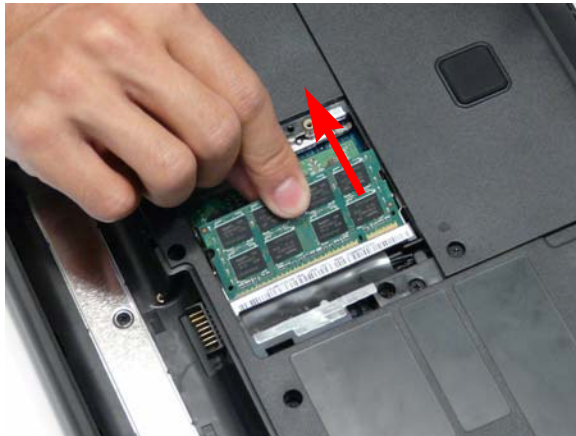

4. Repeat steps for the second DIMM module.

---

## Removing the Hard Disk Drive Module

1. See "Removing the Lower Covers" on page 54.
2. Hold the Pull Tab and slide the HDD away from the connector.





3. Pull the HDD up as shown to remove.

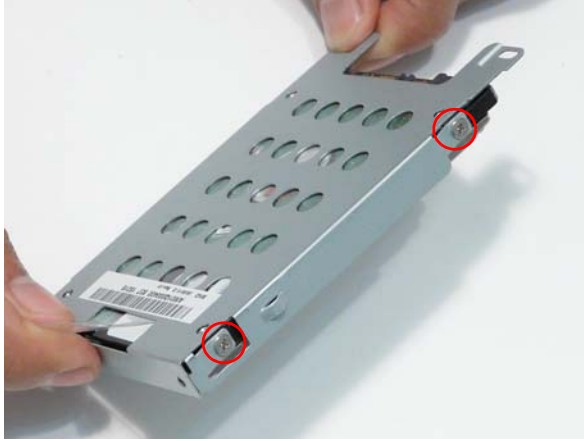

**NOTE:** To prevent damage to HDD, avoid pressing down on it or placing heavy objects on top of it.

4. Remove the four screws (two each side) securing the HDD to the carrier.



Step	Size	Quantity	Screw Type
HDD Carrier	M3*3	4	

5. Lift the HDD carrier to remove.



# Removing the Optical Disk Drive Module

1. See "Removing the Lower Covers" on page 54.
2. Remove the screw securing the ODD module.



Step	Size	Quantity	Screw Type
ODD Module	M2.5*5	1	

3. Insert a screw driver as shown and push the ODD Module out of the bay.

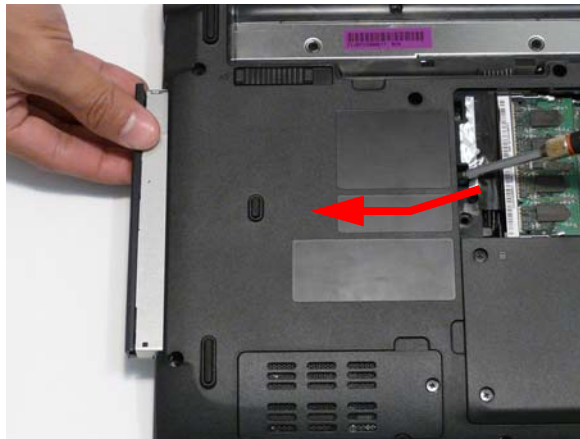

4. Remove the two screws securing the ODD bracket and remove the ODD bracket from the optical disk drive module.



Step	Size	Quantity	Screw Type
ODD Bracket	M2*3	2	

5. Insert a pin in the eject hole of the ODD to eject the ODD tray.

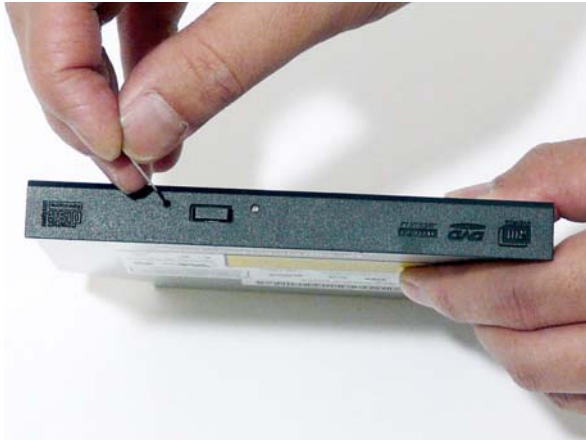

6. Press down on the locking catch to release the ODD cover and remove.

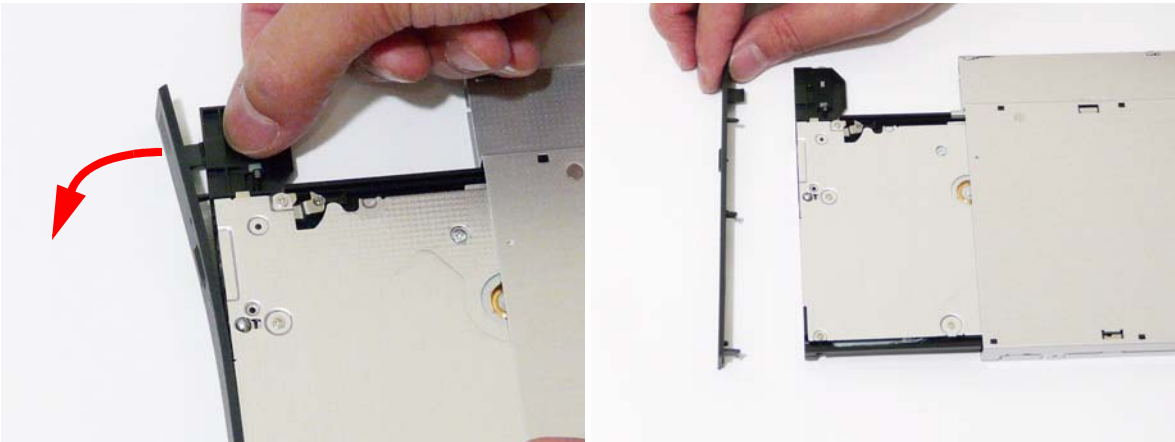

# Main Unit Disassembly Process

## Main Unit Disassembly Flowchart



### Screw List

Step	Screw	Quantity	Part No.
Hinge Covers	M2*3	2	86.AD302.001
Switch Cover	M2.5*3	4	86.AD302.002
	M2.5*10	2	86.AD302.004
Speaker Module	M2.5*3	2	86.AD302.002
LCD Module	M2.5*5	6	86.AD302.003
Upper Cover	M2.5*10	10	86.AD302.004
	M2.5*5	6	86.AD302.003
	M2.5*3	1	86.AD302.002



---

<b>Step</b>	<b>Screw</b>	<b>Quantity</b>	<b>Part No.</b>
Finger Print Reader	M2*3	1	86.AD302.001
TouchPad Bracket	M2*3	2	86.AD302.001
USB Board	M2.5*3	1	86.AD302.002
Modem Module	M2*3	2	86.AD302.001
BT Module	M2.5*3	1	86.AD302.002
Mainboard	M2.5*3	1	86.AD302.002
Thermal Module	M2.5*5*3.2	4	86.AD302.006
Media Board		3	

# Removing the Hinge Covers

- 1. See "Removing the Battery Pack" on page 52.
- 2. Remove the two screw caps and screws from the Hinge Covers.



Step	Size	Quantity	Screw Type
Hinge Covers	M2*3	2	

- 3. Slide the covers off the hinges in the direction of the arrows.

**IMPORTANT:**The left and right Hinge Covers are shaped differently and marked **L** and **R** on the inside. Ensure that the correct cover is used during reassembly.





# Removing the Switch Cover

**CAUTION:** Using tools to remove the Switch Cover may cause damage to the outer casing. It is recommended that only fingers are used to remove the Switch Cover.

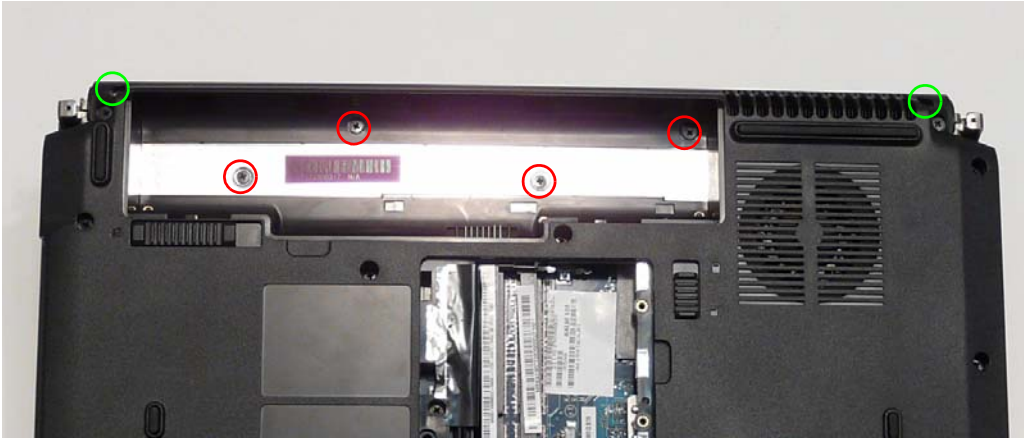
1. See “Removing the Battery Pack” on page 52.
2. See “Removing the Hinge Covers” on page 64.
3. Locate and remove the ten securing screws on the bottom of the computer.



Step	Size	Quantity	Screw Type
Switch Cover (red callout)	M2.5*3	4	
Switch Cover (green callout)	M2.5*10	2	

4. Turn the computer over and open the LCD module to expose the Switch Cover.

**IMPORTANT:**The LCD module does not fully extend. Damage will occur if you attempt to extend the LCD module beyond the manufacturer’s design.

5. Push the Switch Cover downward (1) and lift the left side of the cover upward (2) to release the securing pins.



---

6. Using both hands, lift both sides of the rear edge of the Switch Cover upward as shown.



7. Lift the left side of the Switch Cover first and gently rotate it while lifting the right side clear of the casing.



8. Lift the Switch Cover clear of the chassis.

---

## Removing the Keyboard

1. See “Removing the Switch Cover” on page 65.
2. Lift the keyboard from both sides to clear the securing tabs on both sides of the Keyboard.



3. Push the Keyboard toward the LCD screen to expose the Keyboard FFC cable.



4. Unlock the connector and pull the FFC to remove it from the Mainboard.

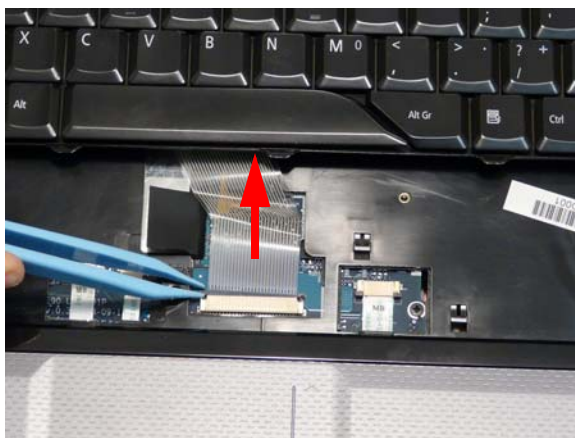

5. Remove the keyboard from the chassis.

# Removing the Speaker Module

1. See "Removing the Keyboard" on page 67.
2. Remove the two securing screws from the Speaker Module.

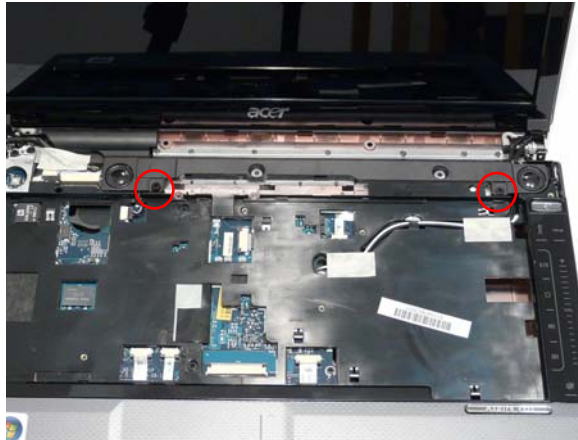

Step	Size	Quantity	Screw Type
Speaker Module	M2.5*3	2	

3. Remove the adhesive tape securing the LCD cables to the Speaker Module.

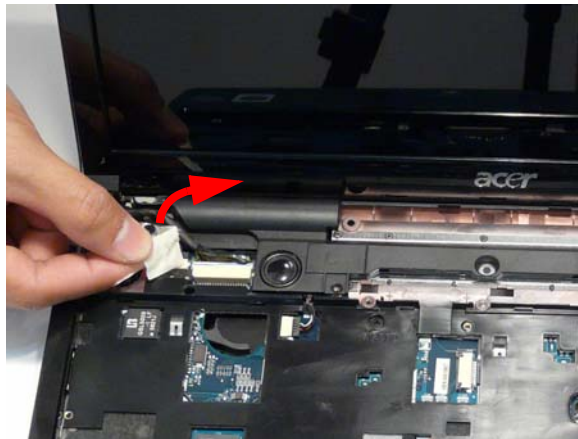

4. Disconnect the speaker cable as shown.



---

5. Rotate the Speaker Module upward, rear edge first to clear the LCD cables, and remove it from the chassis.

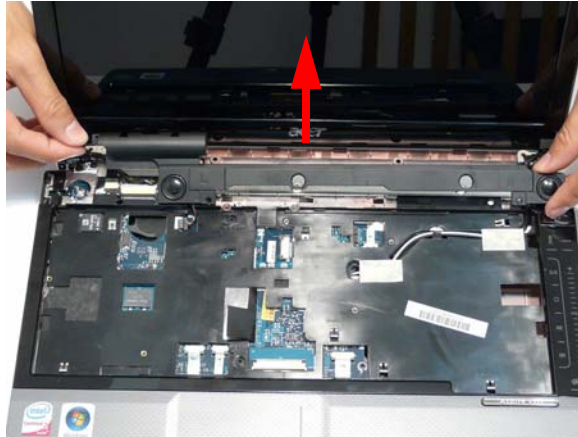

# Removing the LCD Module

1. See "Removing the WLAN Module" on page 56.
2. See "Removing the Keyboard" on page 67.
3. Turn the computer over. Remove the two securing screws as shown.



Step	Size	Quantity	Screw Type
LCD Module	M2.5*5	2	

4. Lift the securing tape to expose the Antenna cable as shown.



5. Push the Antenna cables through the casing as shown.

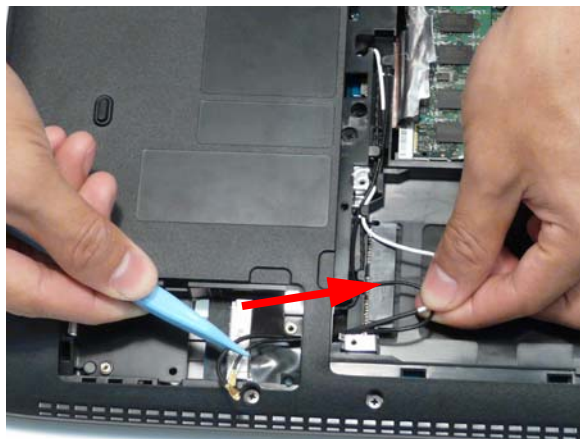



6. Completely remove the Antenna cable from the cable channel.

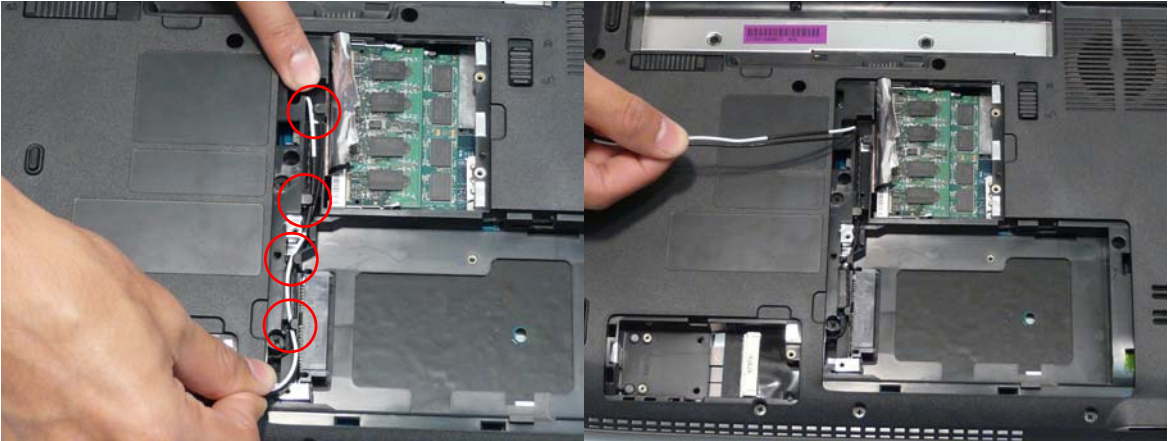

7. Turn the computer over. Remove the two adhesive strips from the Antenna cable.

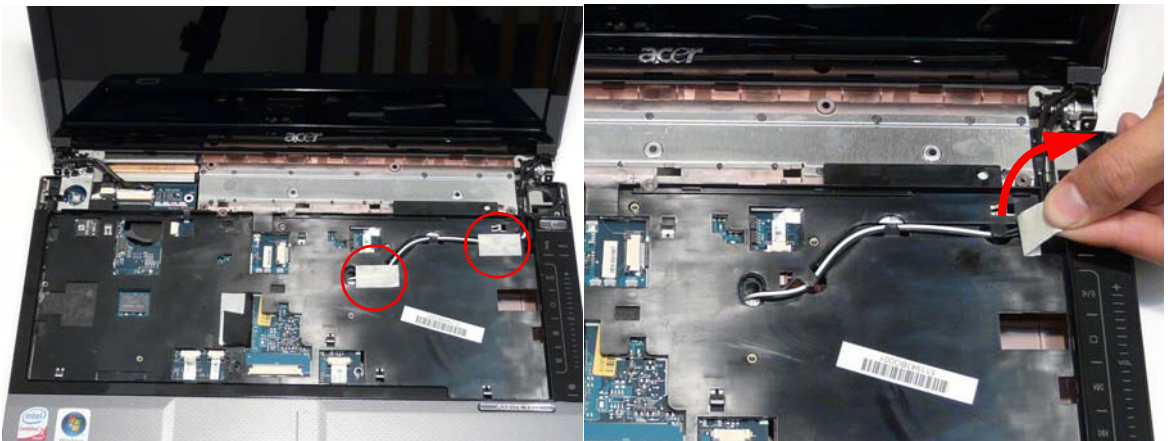

8. Rest the computer on the LCD Module and push the Antenna cable through the chassis as shown.



9. Completely remove the Antenna from the cable channel.

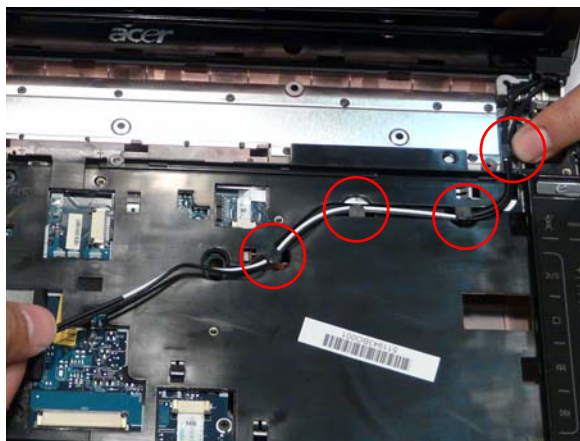

10. Disconnect the LCD cables from the Mainboard as shown.

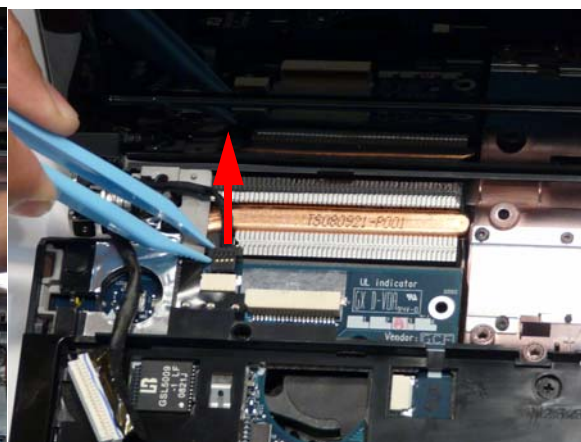
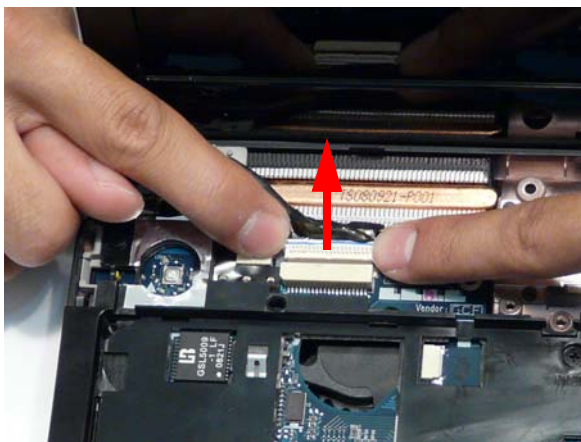
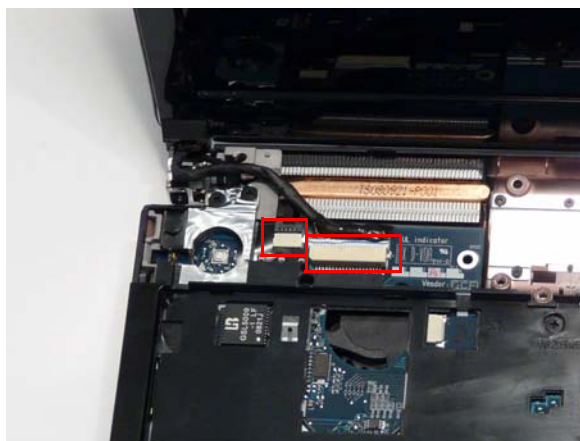

11. Remove the two securing screws from the left LCD hinge.



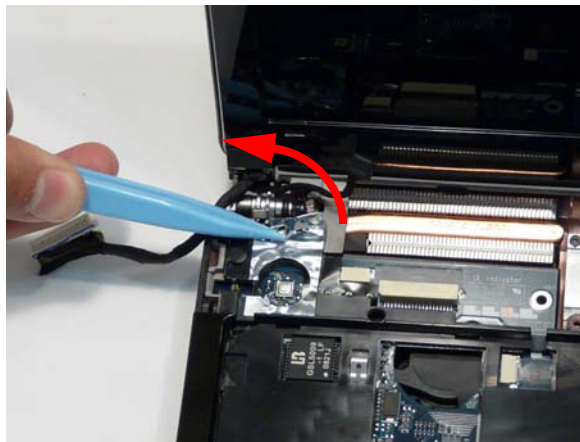

Step	Size	Quantity	Screw Type
LCD Module	M2.5*5	2	

12. Peel back the adhesive strip from the LCD Hinge as shown.

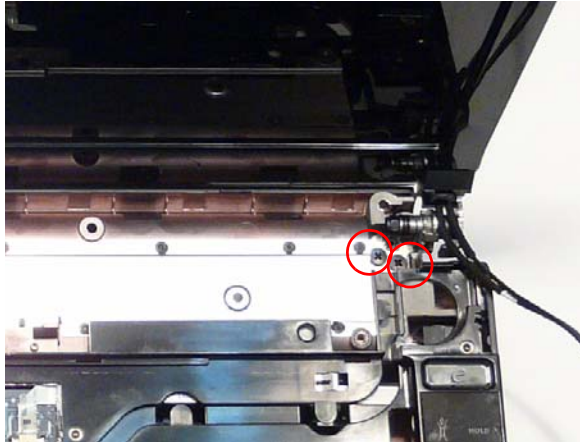

13. Remove the two securing screws from the right LCD hinge.



Step	Size	Quantity	Screw Type
LCD Module	M2.5*5	2	

14. Carefully remove the LCD Module from the chassis.

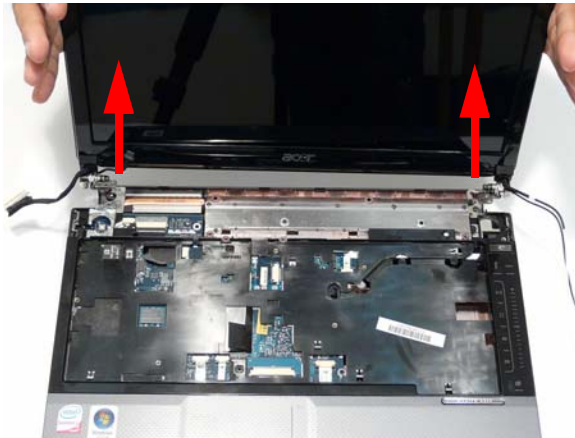

# Removing the Upper Base

1. See "Removing the LCD Module" on page 70.
2. Turn the computer over. Remove the ten screws on the bottom panel.

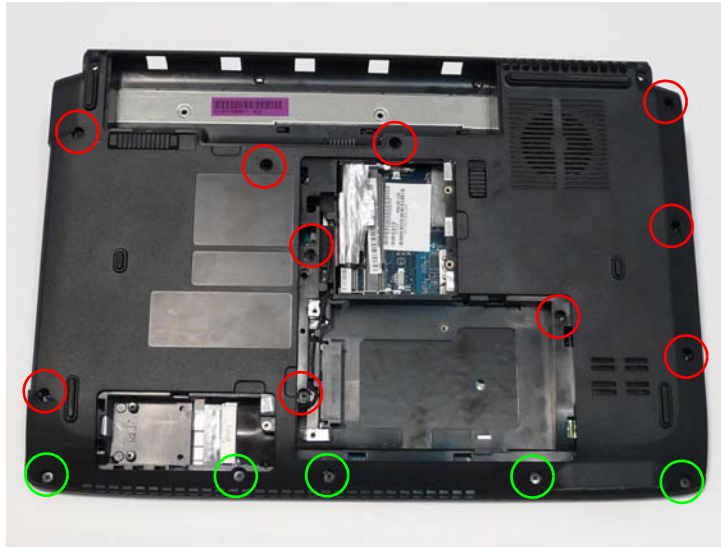

Step	Size	Quantity	Screw Type
Upper Cover (red call out)	M2.5*10	10	
Upper Cover (green callout)	M2.5*5	5	

3. Turn the computer over. Remove the two securing screws on the top panel.



Step	Size	Quantity	Screw Type
Upper Cover (red callout)	M2.5*5	1	
Upper Cover (green callout)	M2.5*3	1	

4. Turn the computer over and disconnect the three FFC cables from the mainboard.



Unlock the connector and disconnect A as shown.

Unlock the connector and disconnect B as shown.

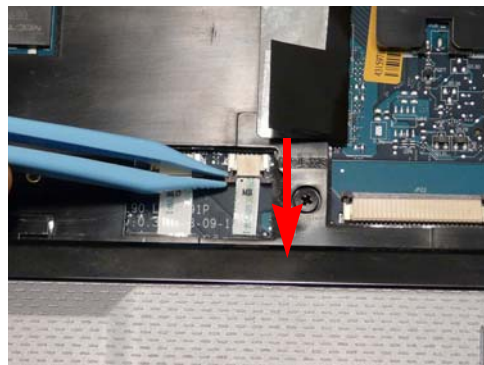
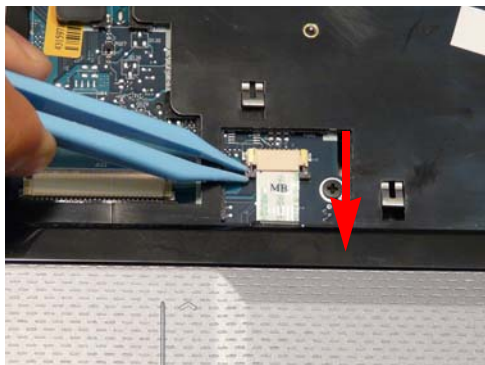

Unlock the connector and disconnect C as shown.

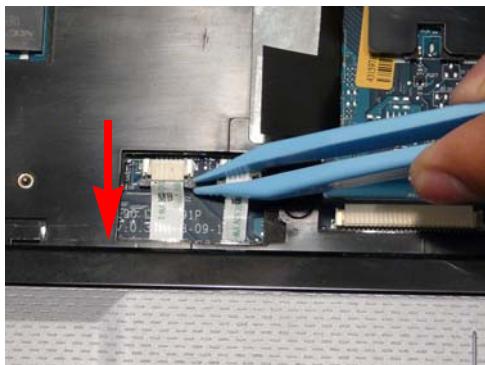

---

**WARNING:** Care must be taken when removing v from the Lower Base to prevent damage or stress to the surface.

5. Ease the lower casing outward to clear the securing clips and pry apart the left side as shown, and lift the rear edge of the Upper Base upward.



6. Ease the lower casing outward to clear the securing clips and pry apart the right side as shown. Lift the rear edge of the Upper Base upward.



7. Completely remove the Upper Base from the Lower Base.

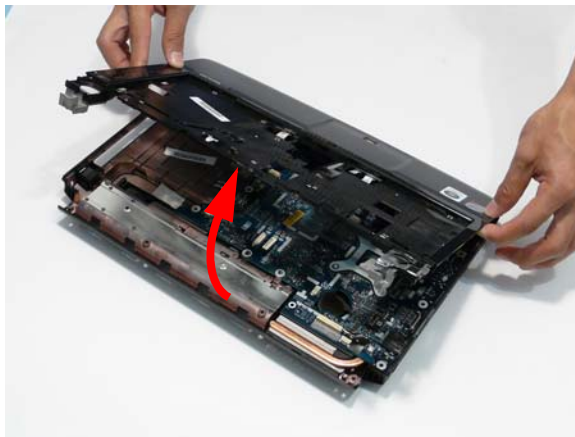

# Removing the Finger Print Reader

**NOTE:** Only the Discrete SKU supports Finger Print Reader technology.

1. See “Removing the Upper Base” on page 75.
2. Remove the single securing screw on the bracket.

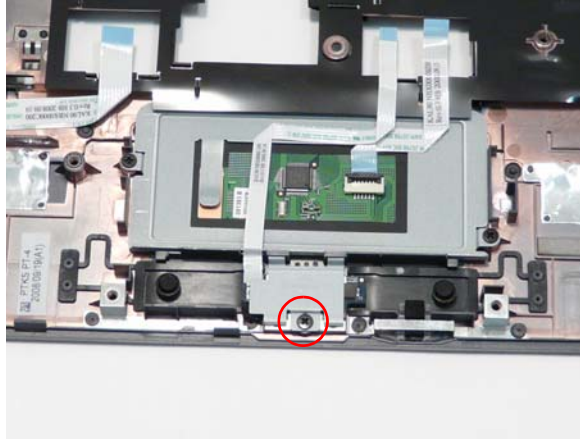

Step	Size	Quantity	Screw Type
Finger Print Reader	M2*3	1	

3. Lift the bracket clear of the casing.

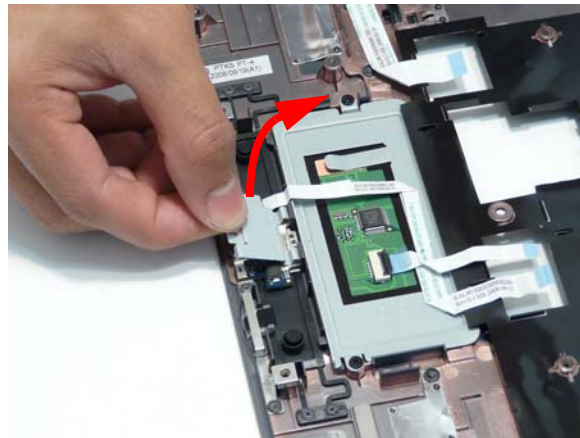



4. Lift the FFC, as shown, to disengage the adhesive and remove the Finger Print Reader Board from the casing.

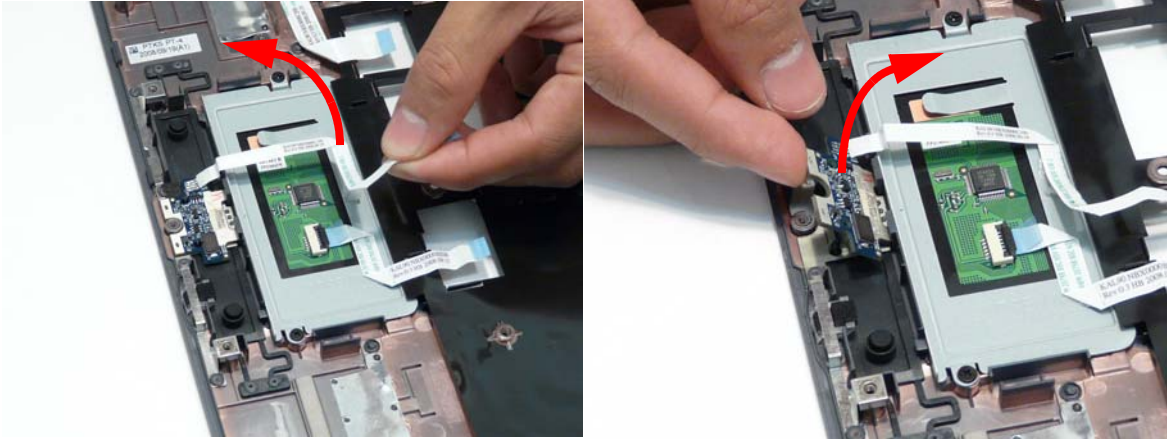

# Removing the TouchPad Bracket

1. See "Removing the Upper Base" on page 75.
2. Lift the FFC, as shown, to disengage the adhesive.

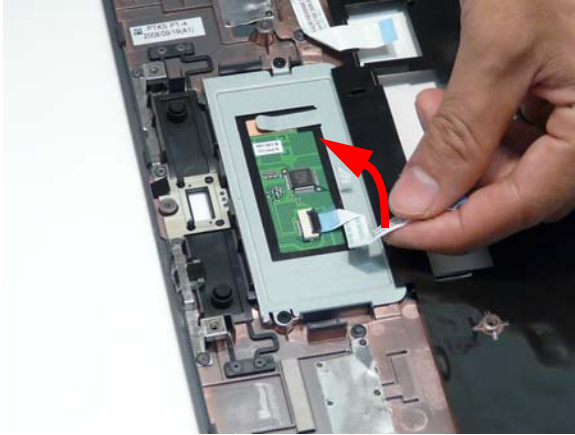

3. Open the FFC locking latch as shown and remove the FFC.

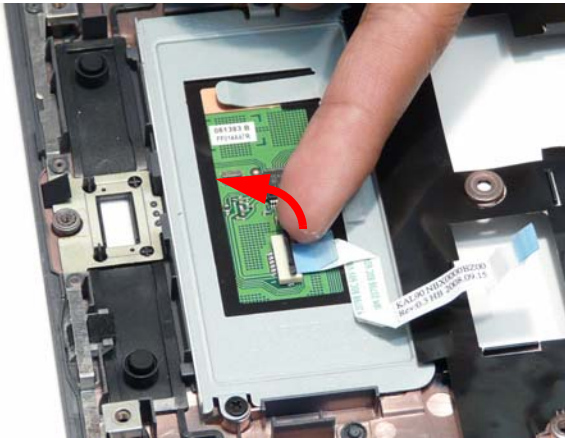

4. Remove the two screws from the TouchPad Bracket and remove it from the casing.

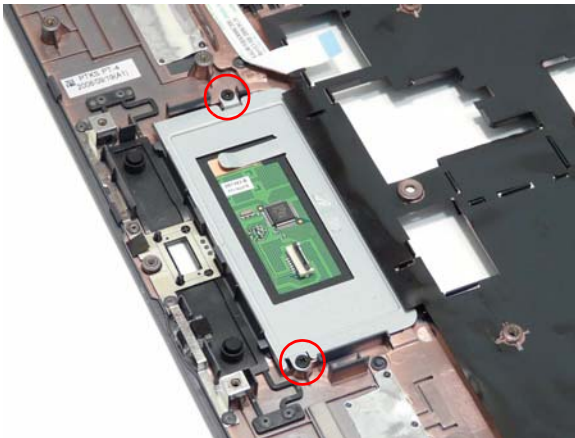

Step	Size	Quantity	Screw Type
TouchPad Bracket	M2*3	2	

---

5. Remove the TouchPad Bracket from the Upper Base.

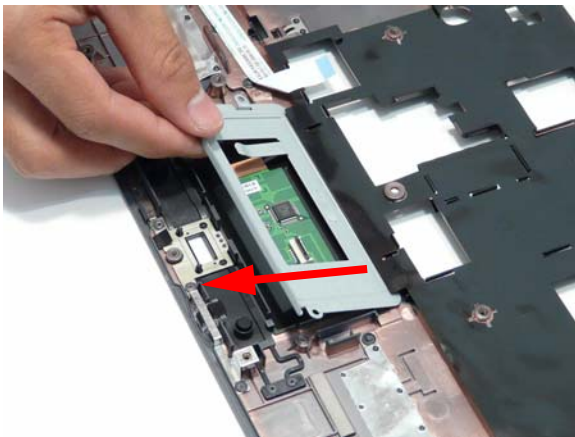

---

## Removing the Media Board

**WARNING:** Care must be taken when removing the Media Board Cover from the Upper Base to prevent damage or stress to the surface.

1. See "Removing the Upper Base" on page 75.
2. Detach the media board FFC from the upper case.

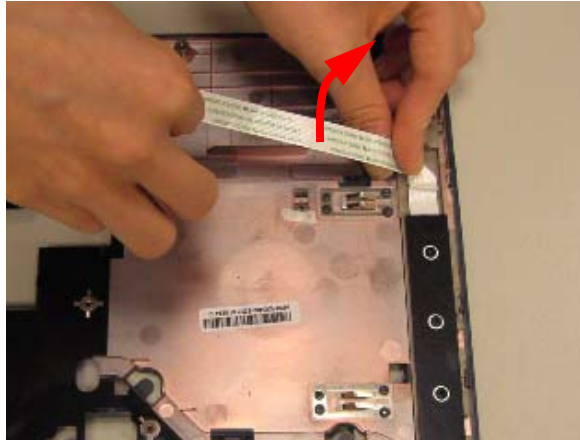

3. Remove the three securing screws as shown.

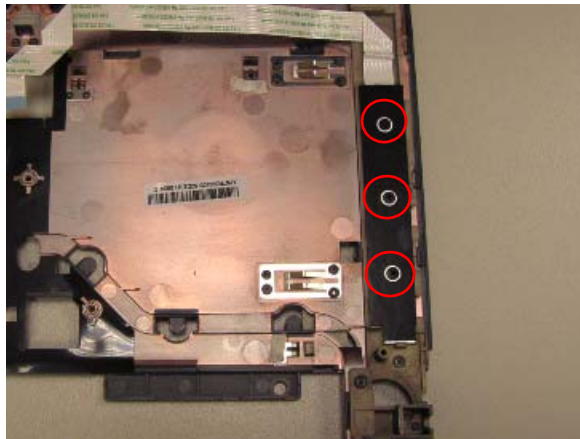

4. Lift the media board clear of the upper case.

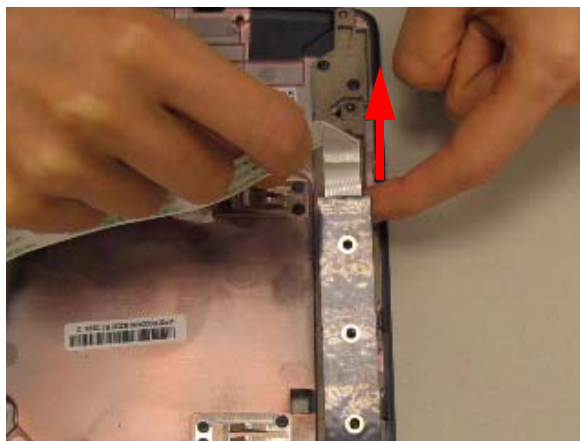



---

Step	Size	Quantity	Screw Type
Media Board	M2.5*3	3	

# Removing the USB Board

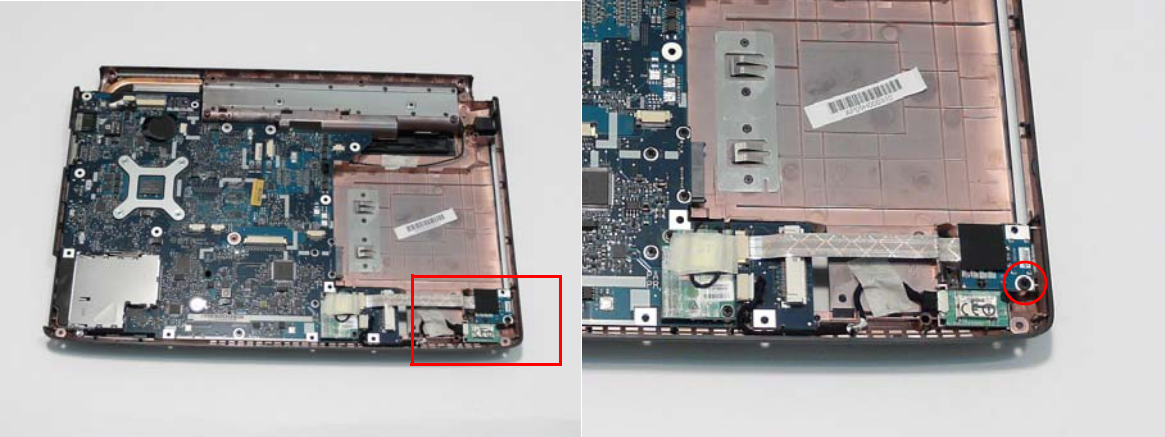
1. See "Removing the Upper Base" on page 75.
2. Remove the single securing screw from the USB board.



Step	Size	Quantity	Screw Type
USB Board	M2.5*3	1	

3. Open the FFC locking latch and remove the FFC from the Mainboard.

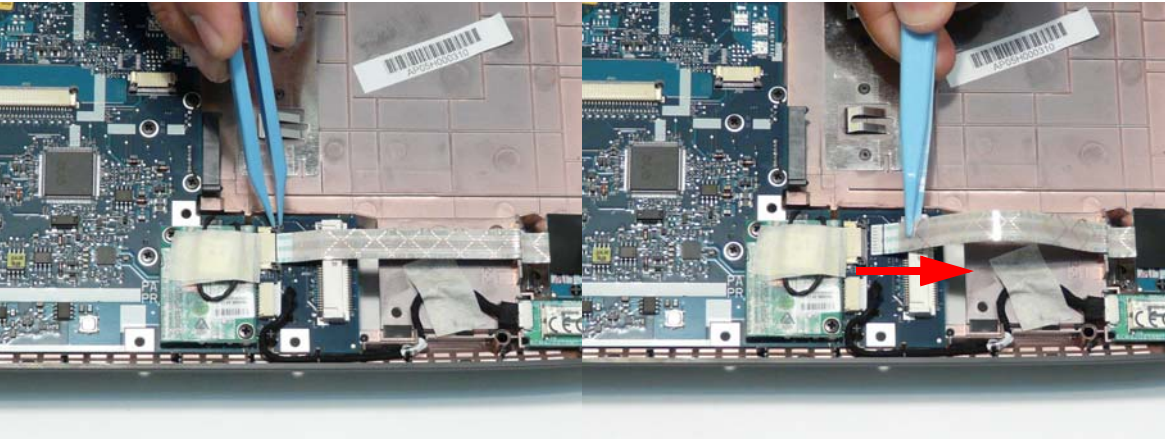

4. Lift the FFC to detach the adhesive from the casing.



---

5. Lift the USB Board clear of the casing.

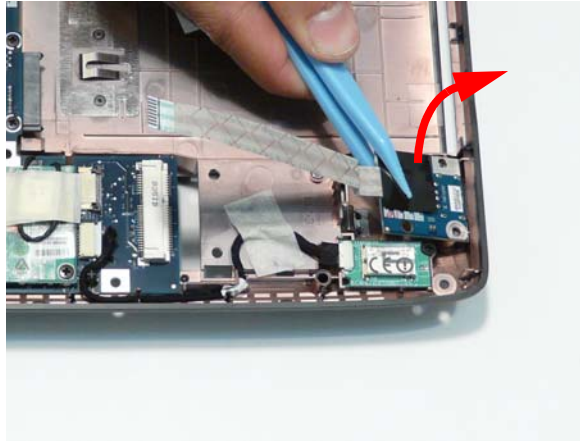

# Removing the Modem Module

- 1. Remove the Upper Base. See “Removing the Upper Base” on page 75.
- 2. Remove the adhesive tape securing the cable to the Modem and remove the two securing screws.

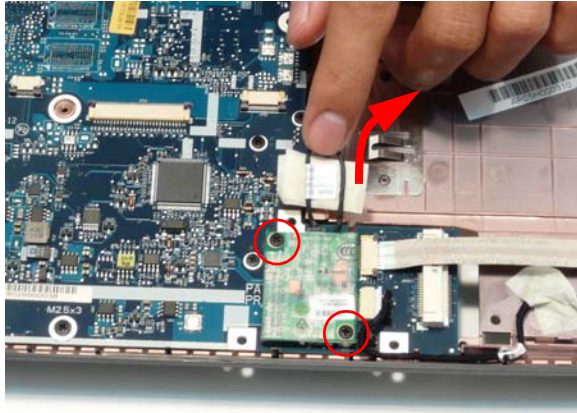

Step	Size	Quantity	Screw Type
Modem Module	M2*3	2	

- 3. Lift the Modem Module clear of the Mainboard as shown.

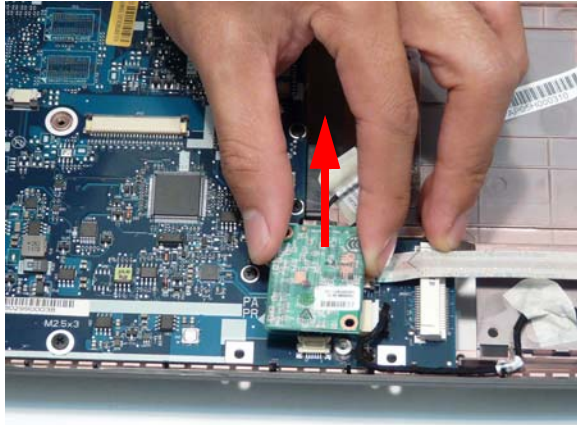

- 4. Turn the module over and disconnect the Modem cable. Remove the module from the casing.

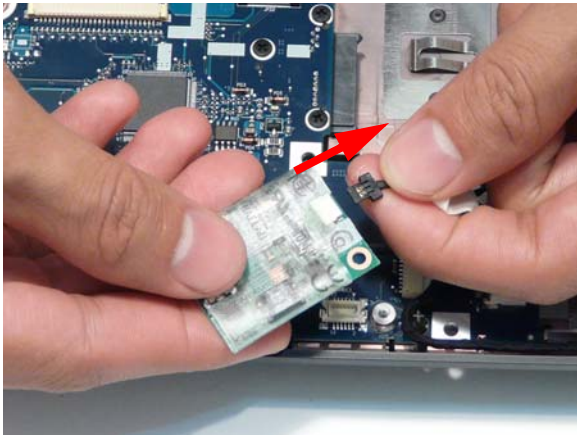



# Removing the Bluetooth Module

1. See "Removing the Upper Base" on page 75.
2. Grasp the cable as shown and pull to disconnect from the Bluetooth module.

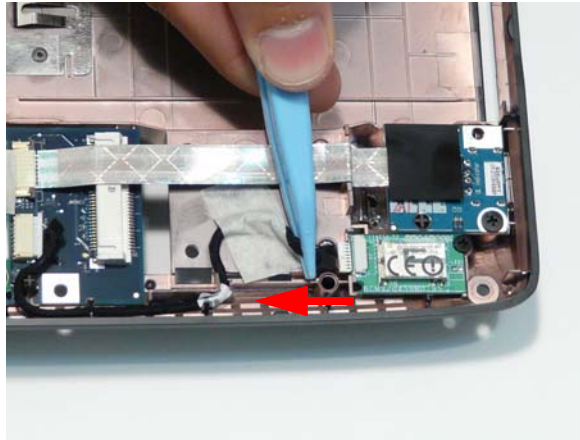

3. Disconnect the cable from the Mainboard and remove the adhesive tape to free the cable.

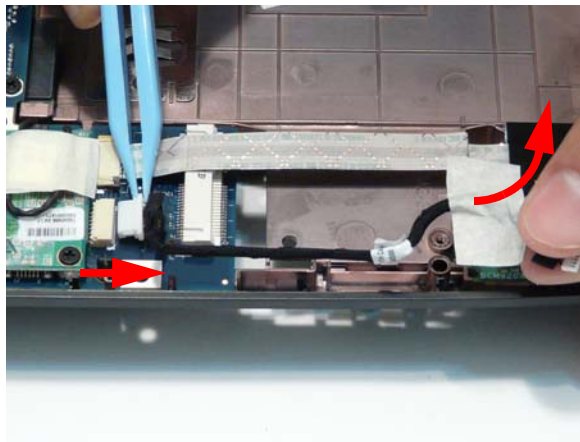

4. Remove the single securing screw and remove the module from the chassis.

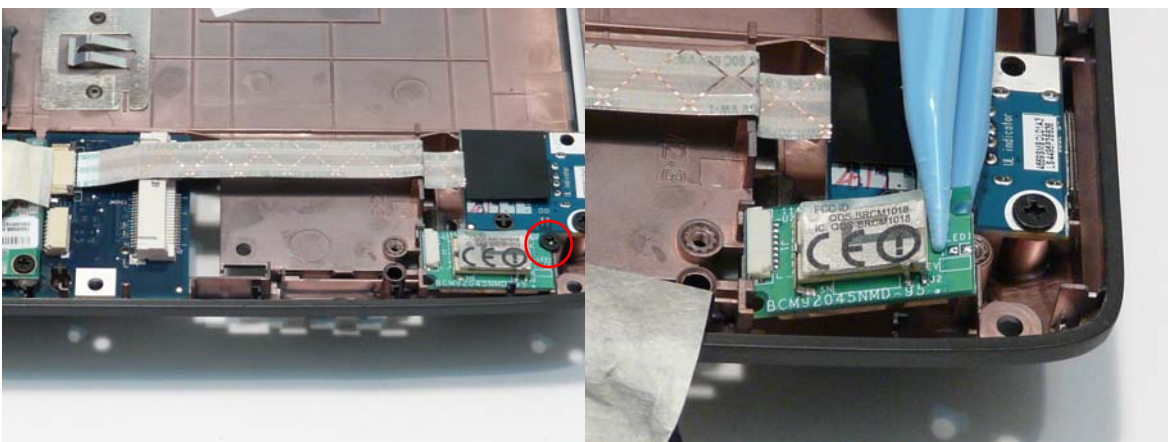

Step	Size	Quantity	Screw Type
Bluetooth Module	M2.5*3	1	

# Removing the Mainboard

1. See "Removing the Upper Base" on page 75.
2. See "Removing the USB Board" on page 84.
3. See "Removing the Modem Module" on page 86.
4. See "Removing the Bluetooth Module" on page 87.
5. Grasp the RJ-11 cable and remove it from the Mainboard as shown.

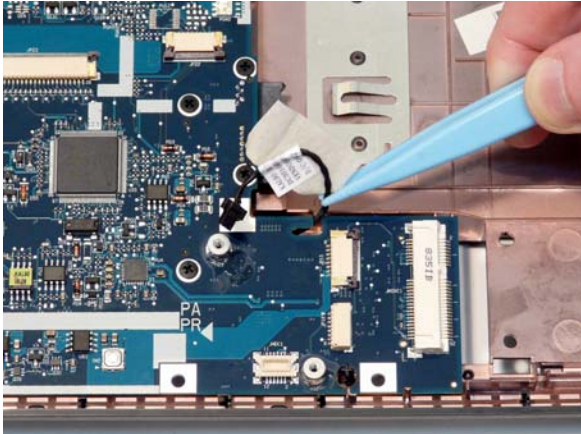

6. Remove the single securing screw.

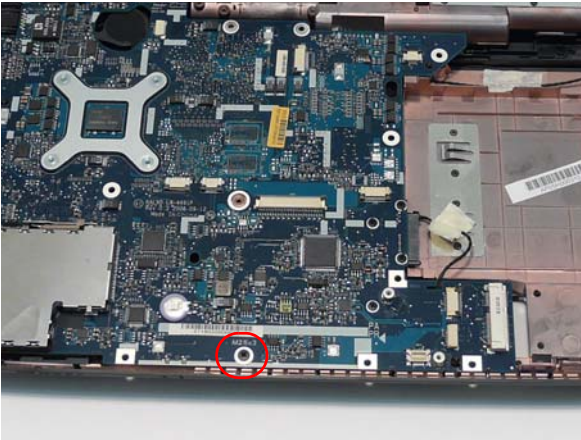

Step	Size	Quantity	Screw Type
Mainboard	M2.5*3	1	

---

7. Lift the mainboard right side first to remove from the base.

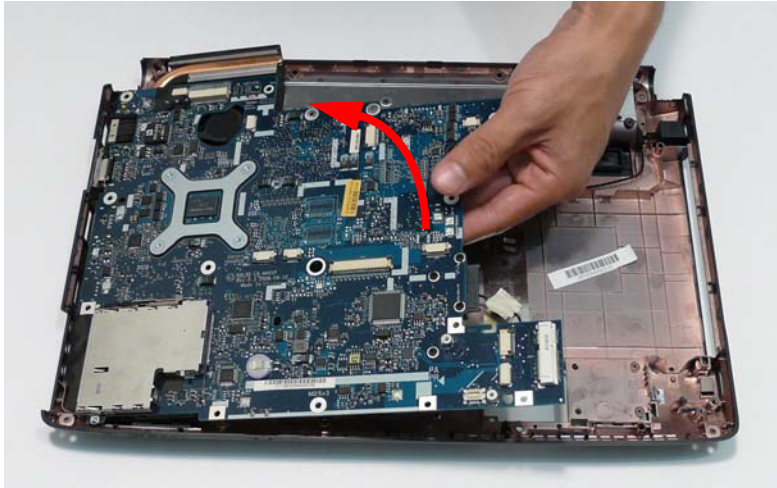

---

## Removing the RJ-11 Port

1. See "Removing the Mainboard" on page 88.
2. Turn the Lower Base over and pull the Modem cable through the casing as shown.

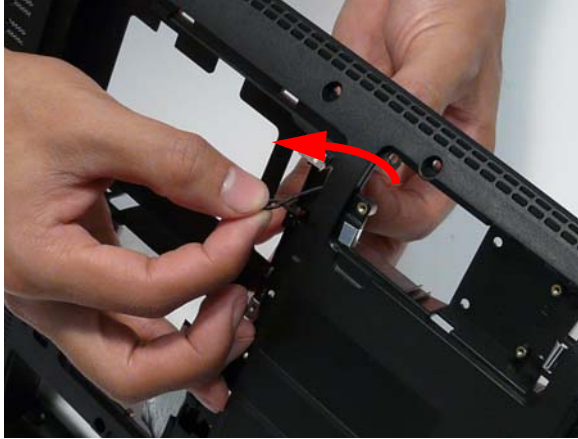

3. Completely remove the Modem cable from the cable channel.

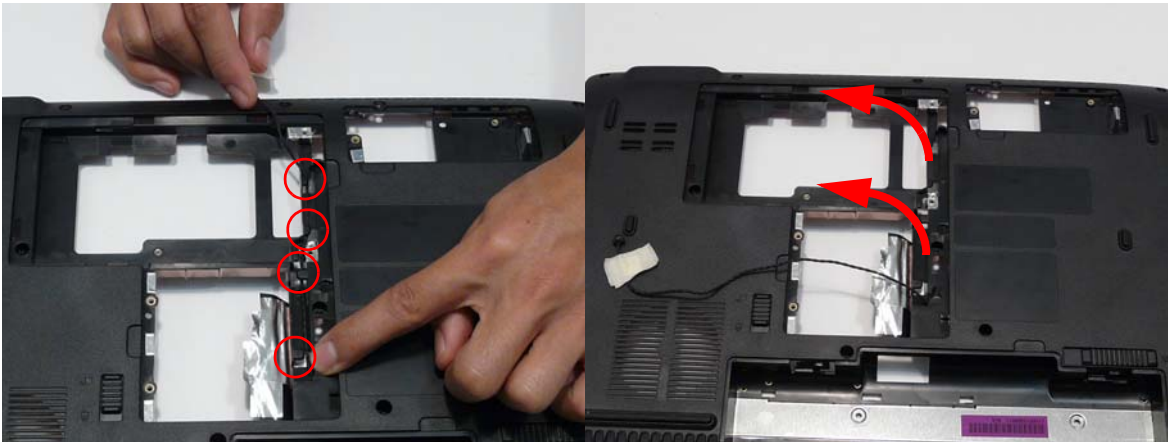

4. Turn the computer over. Pull the Modem cable completely through the casing as shown.

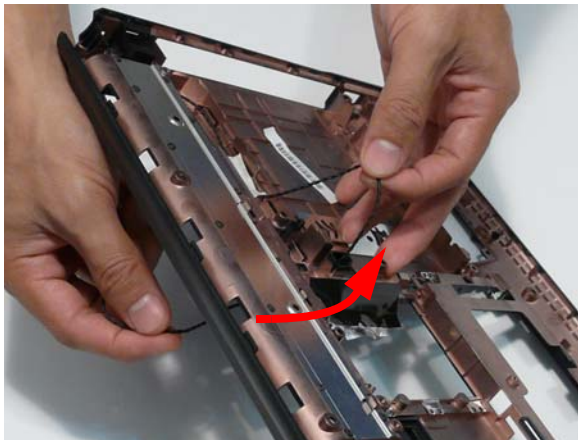

5. Remove the adhesive tape and lift the cable out of the cable channel as shown.

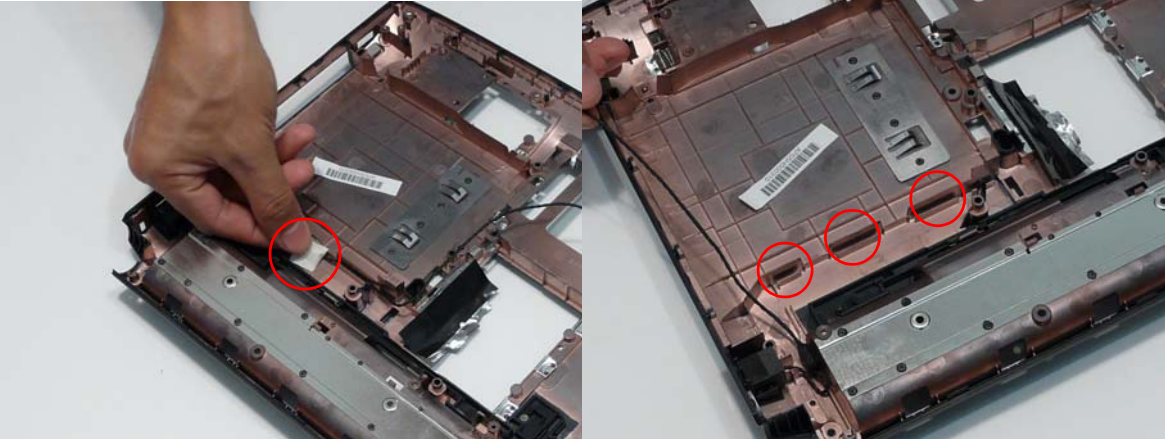

6. Detach the adhesive and lift the cable bundle out of the casing.

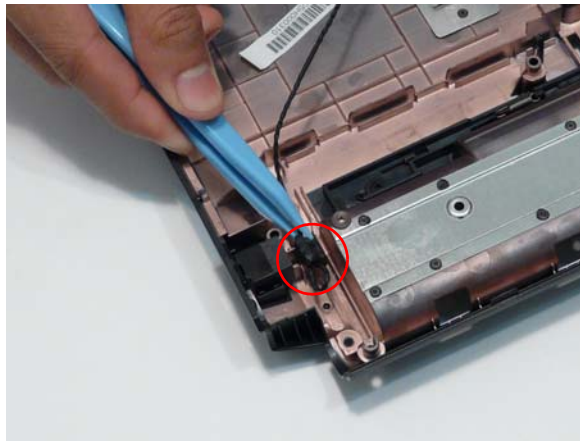

7. Remove the RJ-11 Port from the casing.

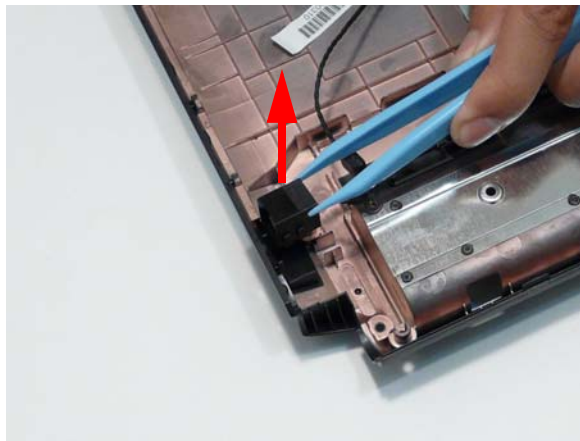

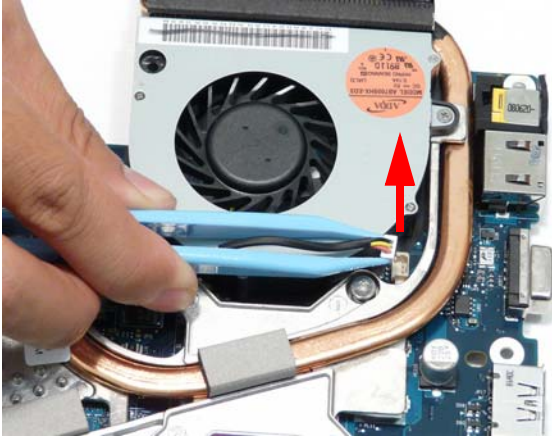

# Removing the Thermal Module

1. See "Removing the Mainboard" on page 88.
2. Turn the Mainboard over and place on a clean surface.
3. Hold the fan cable connector and lift to disconnect from the mainboard.

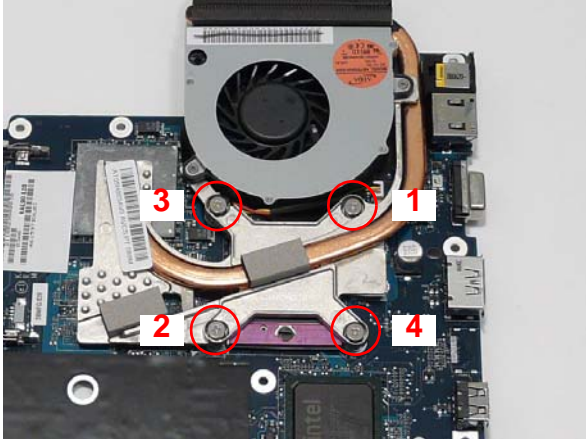

4. Remove the four screws from the Thermal Module numerically, from 4 to 1.



Step	Size	Quantity	Screw Type
CPU Thermal Module	M2.5*5*3.2	4	

---

**WARNING:**To prevent damage to the Thermal Module or the CPU, hold and lift the Thermal Module by lifting both ends up and away at the same time.

5. Hold the module on both sides and lift it clear of the Mainboard.

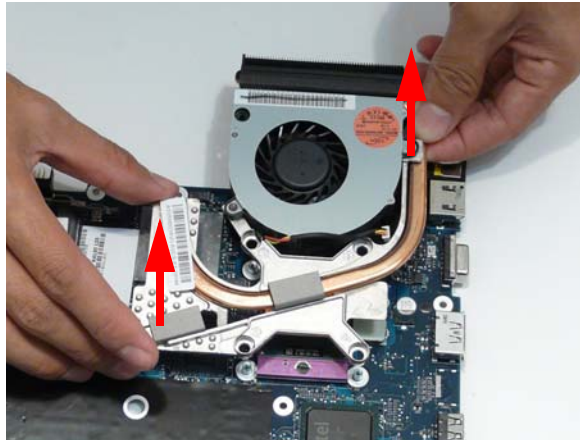

**IMPORTANT:**If the replacement Thermal Module does not include the thermal protection pad shown below, reuse the original thermal protection pad with the new Thermal Module.



---

## Removing the CPU

1. See “Removing the Thermal Module” on page 92.
2. Using a flat screwdriver, turn the CPU socket latch counter-clockwise 180° to release the CPU.

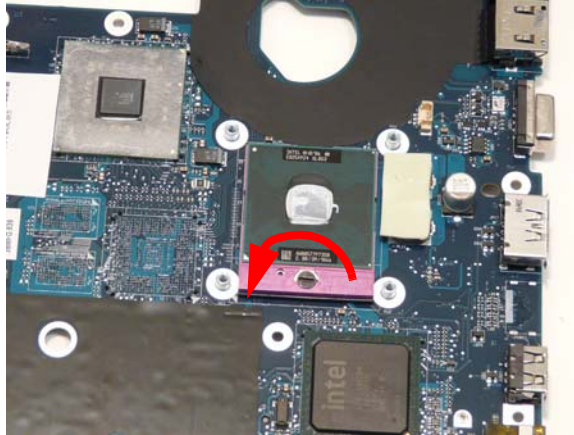

3. Lift the CPU clear of the Mainboard.

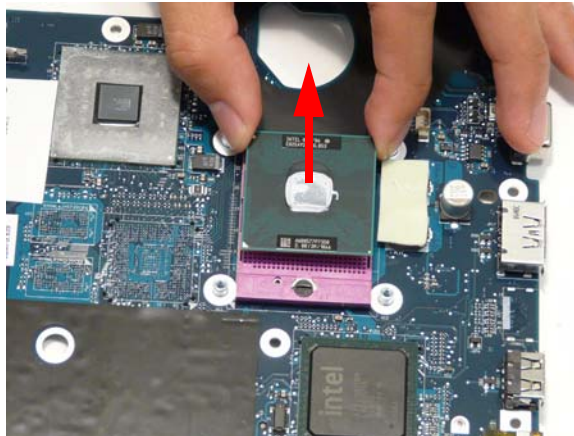



# LCD Module Disassembly Process

## LCD Module Disassembly Flowchart

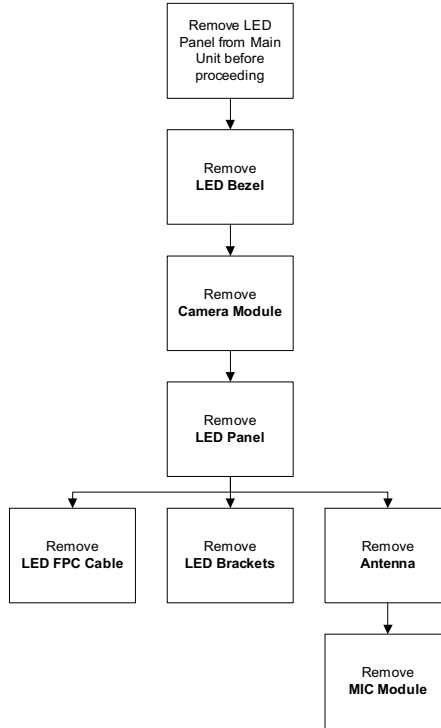

### Screw List

Step	Screw	Quantity	Part No.
LCD Bezel	M2.5*5	6	86.AD302.003
Camera Module	M2.5*3	1	86.AD302.002
LCD Panel	M2.5*5	2	86.AD302.003
	M2.5*3	1	86.AD302.002
LCD Brackets	M2*3	6	86.AD302.001

# Removing the LCD Bezel

- 1. See "Removing the LCD Module" on page 70.
- 2. Remove the six screw caps and screws as shown.



Step	Size	Quantity	Screw Type
LCD Bezel	M2.5*5	6	

- 3. Starting at the centre of the top edge, pry the inside of the bezel away from the screen. Work round the edges to pry the bezel away from the screen as shown.



---

4. Lift the bezel away from the panel.



# Removing the Camera Module

- 1. See "Removing the LCD Bezel" on page 96.
- 2. Remove the single screw from the Camera Bracket as shown.



Step	Size	Quantity	Screw Type
Camera Module	M2.5*3	1	

- 3. Lift the Camera Bracket, right side first, clear of the casing.

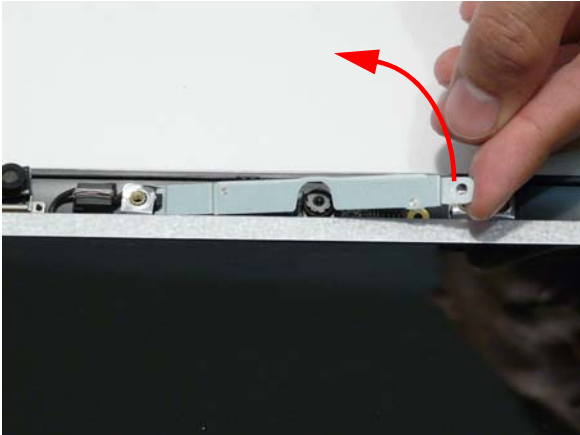

- 4. Lift the Camera Module clear of the casing and disconnect the cable from the Module.

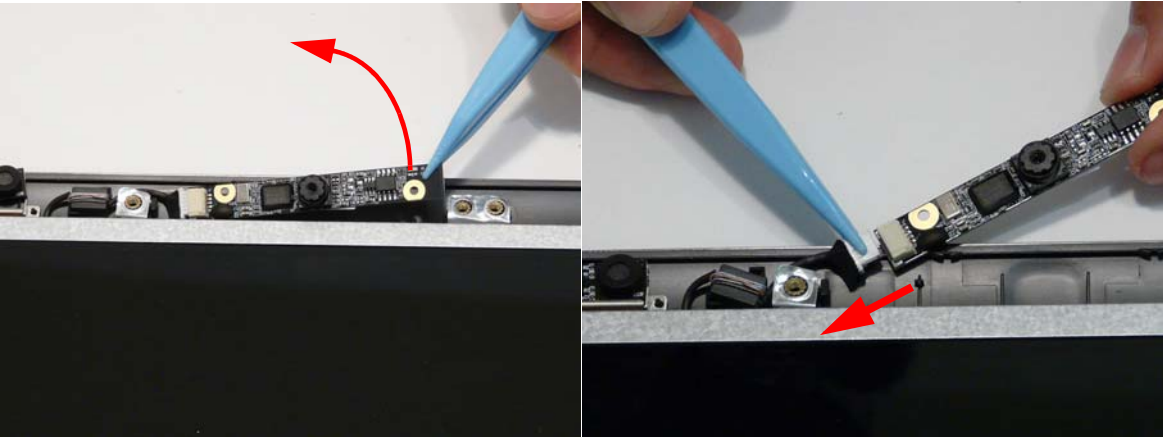



- 5. Remove the Camera Module.

## Removing the LCD Panel

1. See "Removing the Camera Module" on page 98.
2. Remove the two securing screws from the LCD hinges and the single LCD grounding screw.



Step	Size	Quantity	Screw Type
LCD Panel (red callout)	M2.5*5	2	
LCD Panel (green callout)	M2.5*3	1	

3. Remove the Camera cable bundle from the top of the casing as shown.

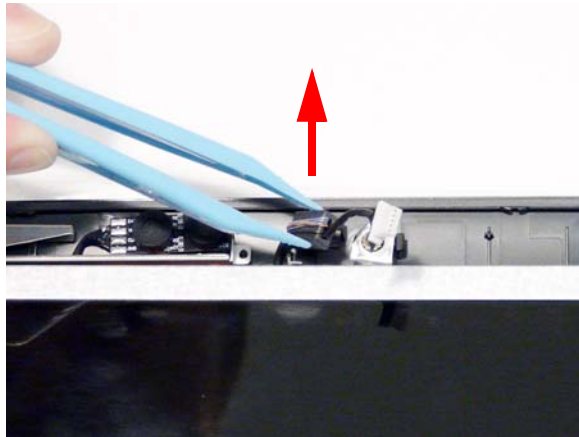

---

4. Lift the LCD Panel out of the casing as shown.



# Removing the LCD Brackets and FPC Cable

1. See "Removing the LCD Panel" on page 99.
2. Turn the LCD Panel over on a clean surface, and lift the cable as shown to detach the adhesive.

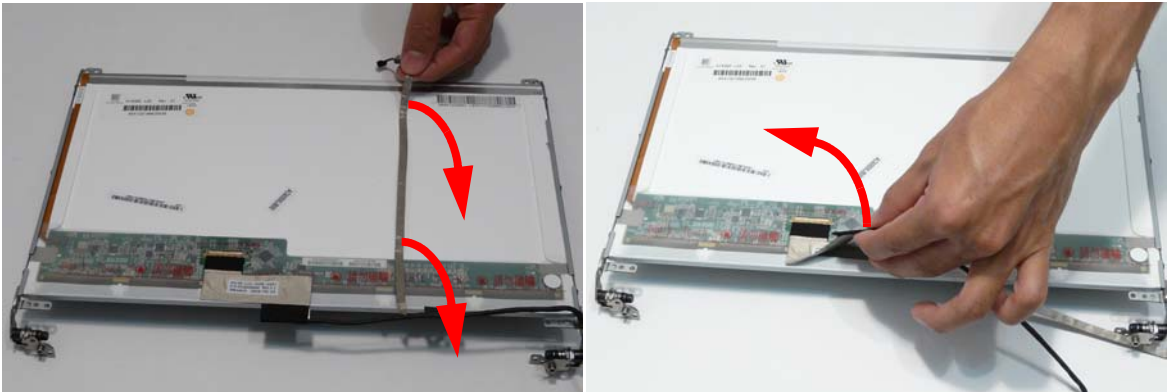

3. Grip the adhesive strip covering the LCD cable connector and pull it back (1).
4. Remove the cable from the panel as shown (2).

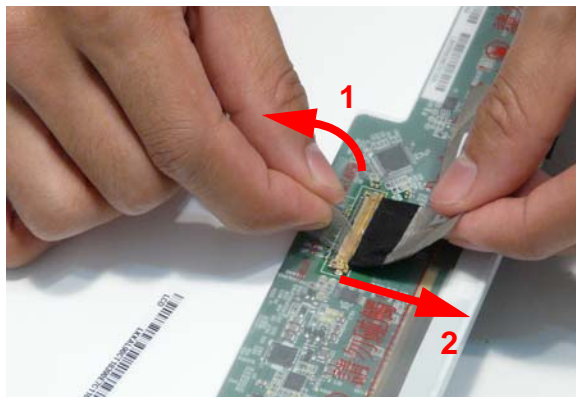

5. Remove the six securing screws (three on each side) from the LCD Panel brackets in numeric order, from 3 to 1.

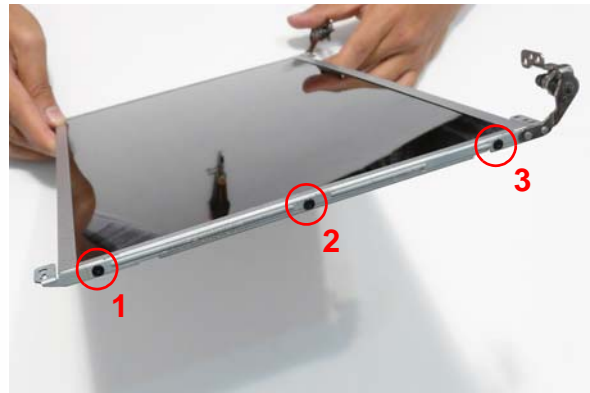

Step	Size	Quantity	Screw Type
LCD Brackets	M2*3	6	

6. Remove the LCD brackets by pulling them away from the LCD Panel.

---

## Removing the Antennas

1. See "Removing the LCD Panel" on page 99.
2. Remove the strips holding the antenna cables in place. Ensure the cables are free from obstructions.



3. Remove the tab securing the left and right antennas to the LCD module and lift the antennas clear.

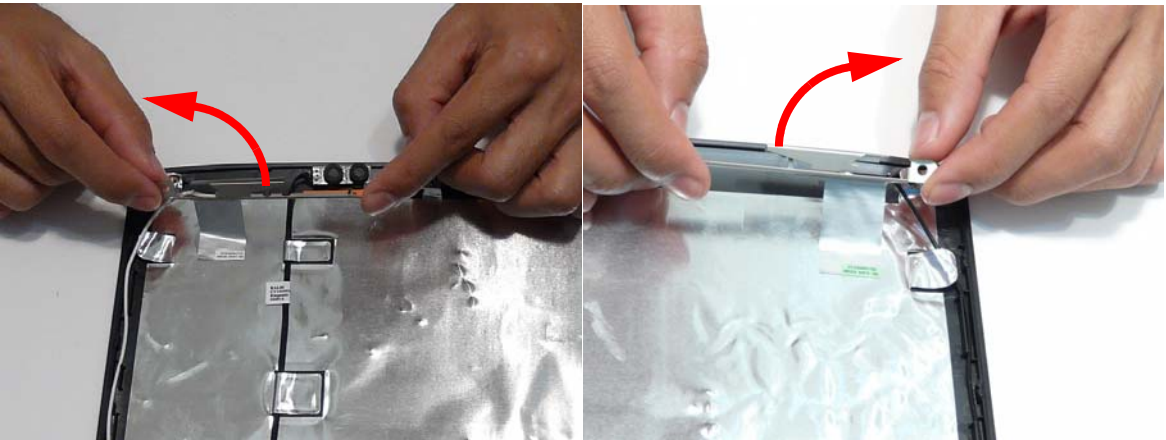

4. Remove the antenna cables and assembly from the LCD module.



---

## Removing the MIC Module

1. See “Removing the Antennas” on page 102.
2. Remove the strips and tape holding the MIC Module cable in place. Ensure the cable is free from obstructions.



3. Remove the MIC cable and Module from the LCD module.

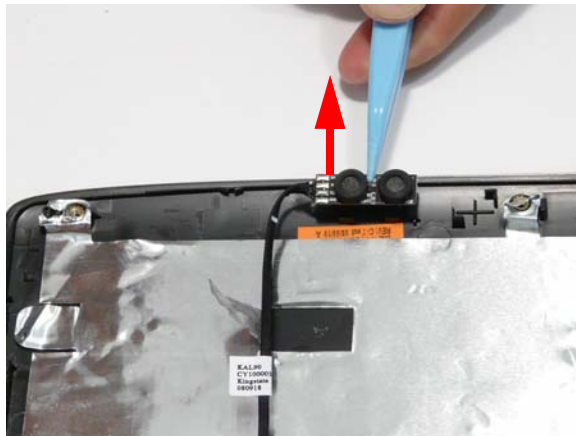

---

# LCD Module Reassembly Procedure

## Replacing the MIC Module

1. Replace the MIC Module in the LCD casing.
2. Run the cable as shown and replace the adhesive strips to hold it in place.

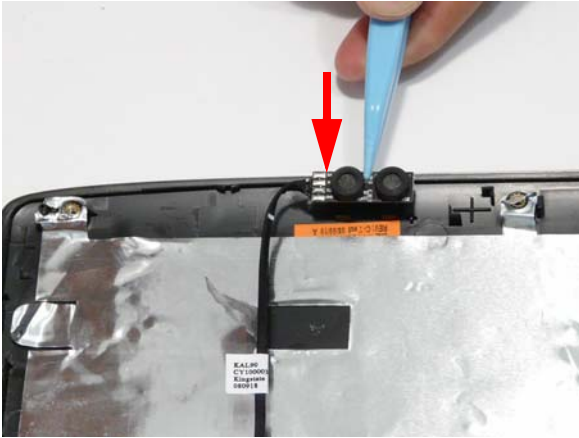

**IMPORTANT:** Ensure that the cable runs as shown in the hinge well area to avoid trapping.



# Replacing the Antennas

1. Run the right side Antenna cable as shown in the hinge well to avoid trapping.
2. Run the cable as shown and replace the adhesive strip.

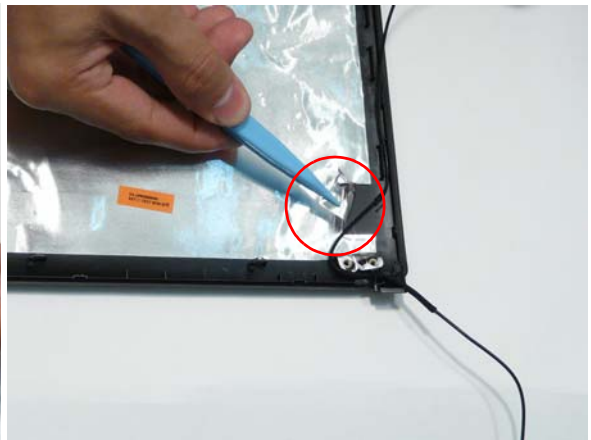

3. Run the cable along the edge of the casing using all available cable clips.
4. Run the cable as shown and replace the adhesive strip.



5. Replace the Antenna in the casing as shown and secure it in place with the tape.
6. Ensure that the securing pin is properly located.



7. Run the left side Antenna cable as shown in the hinge well to avoid trapping.

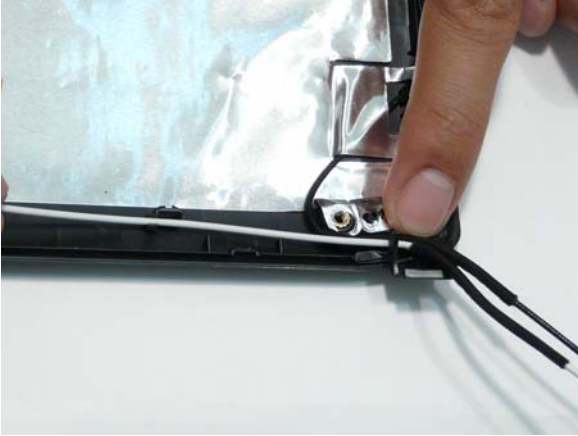

8. Run the cable along the edge of the casing using all available cable clips.

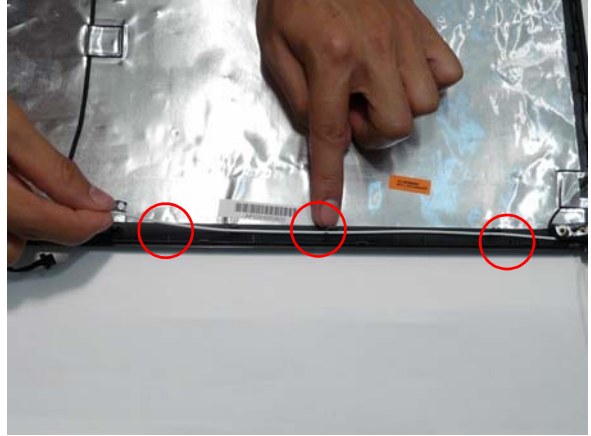

9. Run the cable as shown and replace the adhesive strip.

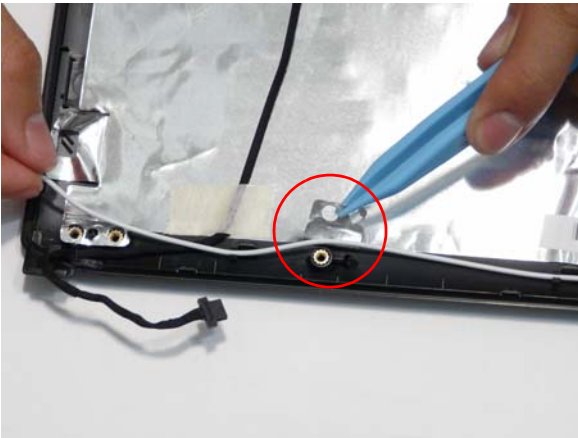

10. Run the cable as shown and replace the adhesive strip.

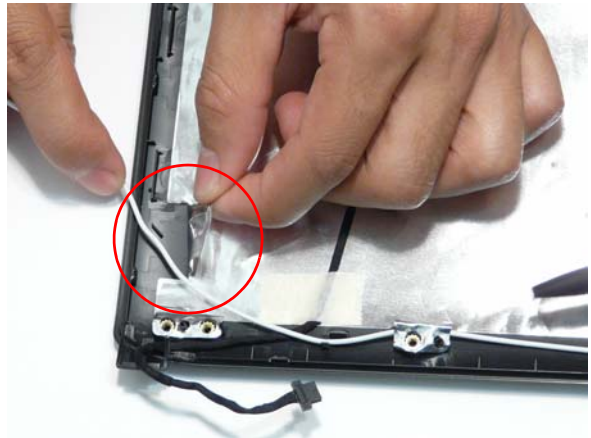

11. Run the cable along the edge of the casing using all available cable clips.

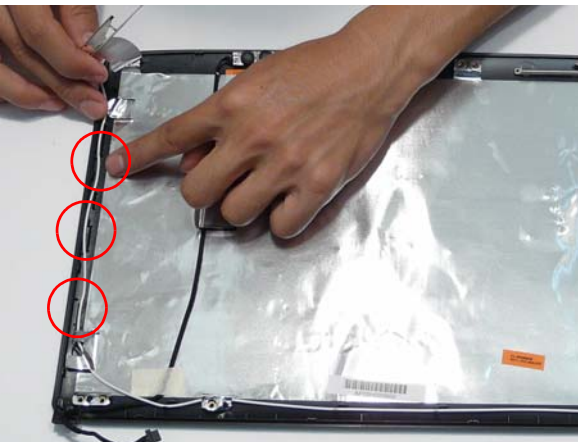

12. Replace the Antenna in the casing as shown and secure it in place with the tape.

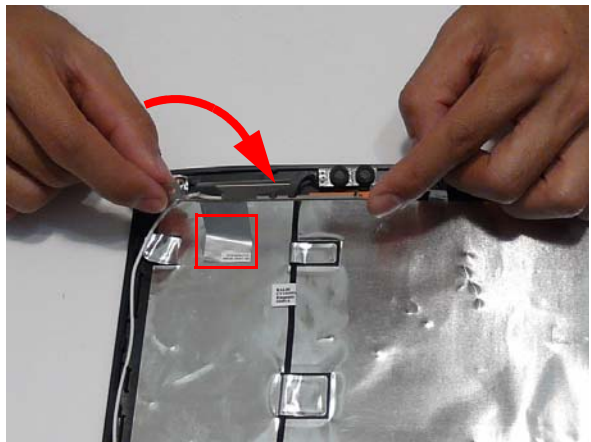

---

13. Ensure that the securing pin is properly located.

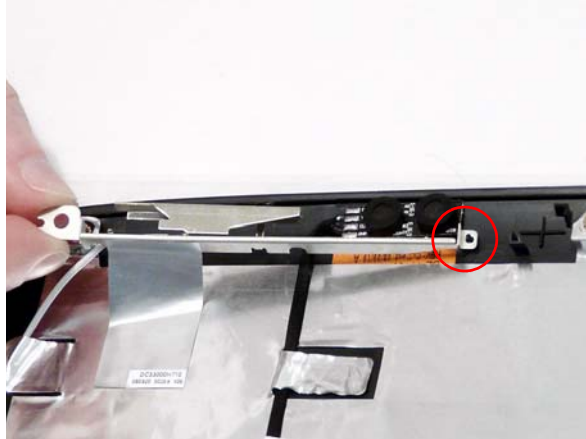

# Replacing the LCD Panel

1. Align the LCD brackets with the six screw holes (three on each side) on the LCD Panel as shown.
2. Replace the six securing screws in numeric order, from 1 to 3.

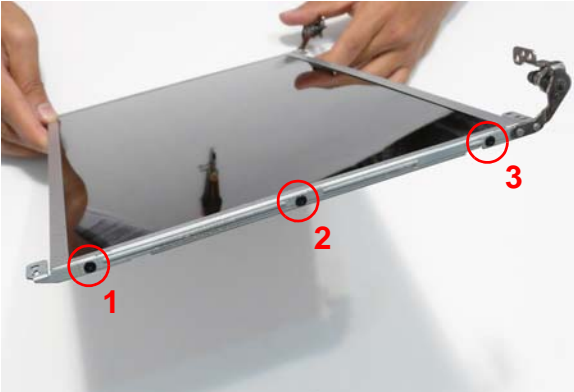

3. Turn the panel over. Insert the LCD Panel cable into the LCD Panel as shown (1). Secure the cable by replacing the securing strip (2).
4. Run the LCD cable as shown and press down along the length of the cable to secure it in place.

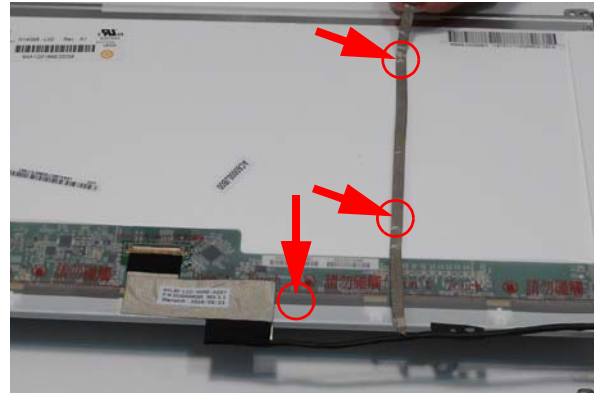
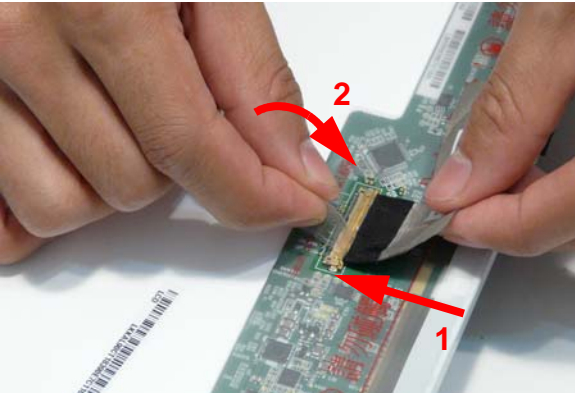

5. Insert the LCD panel into the casing back edge first as shown.
6. Ensure that the four locating pins are properly seated before continuing.



---

7. Replace the Camera Module cable bundle in the casing as shown.

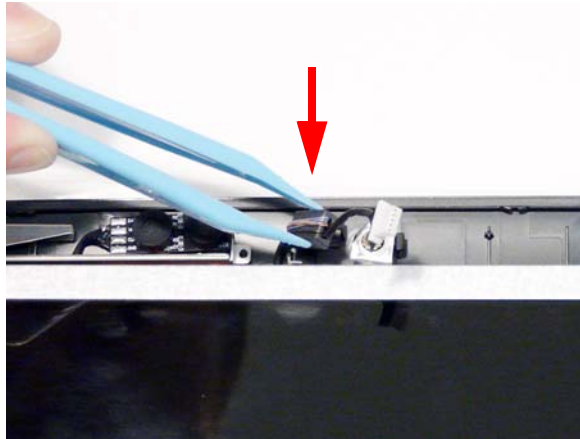

8. Replace the three screws to secure the panel and grounding within the LCD module.

**IMPORTANT:**When replacing the screws in the LCD brackets (red callout) do not use the screw holes marked with 'X'. These slots are reserved for the Bezel securing screws.



# Replacing the Camera Module

1. Reconnect the LCD cable to the Camera Module.
2. Place the Camera Module in the casing as shown.

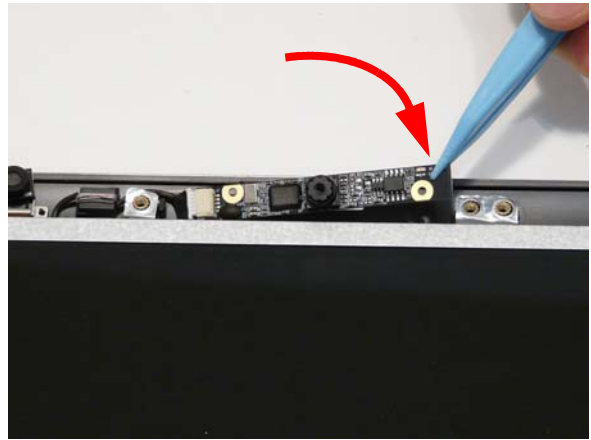
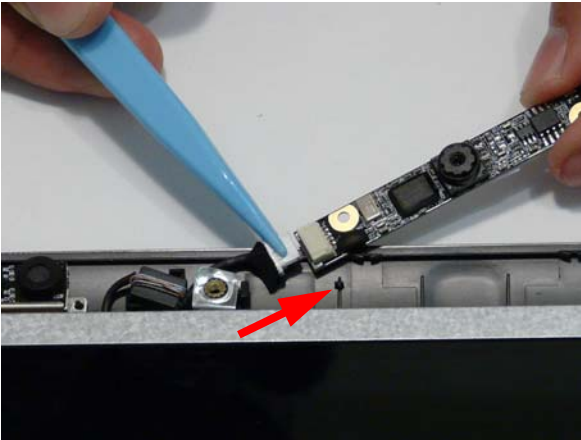

3. Ensure that the locating pins are correctly seated.
4. Insert the Camera Bracket left side first to engage the securing clip.



5. Lower the bracket into place as shown
6. Replace the single securing screw.

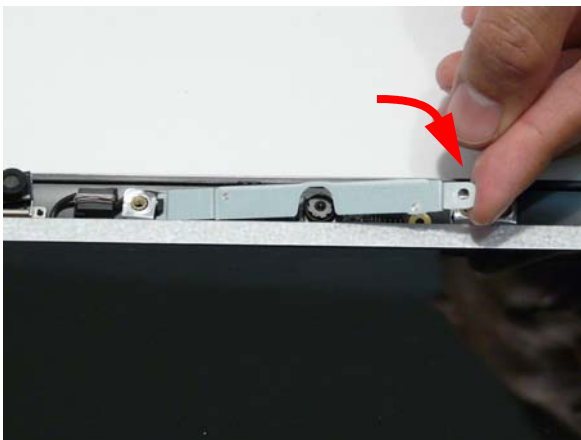



---

## Replacing the LCD Bezel

1. Place the Bezel on the casing bottom edge first and press in the areas marked to snap it into place.
2. Press down the sides of the bezel, working toward the top edge.



3. Press down the top edge to complete the process.

**IMPORTANT:** Ensure there are no gaps between the casing and the Bezel.



4. Replace the six securing screws and screw caps on the LCD bezel.



---

# Main Module Reassembly Procedure

## Replacing the CPU

**IMPORTANT:**The CPU has a Pin1 locator that must be positioned corresponding to the marker on the CPU socket.

1. Place the CPU into the CPU socket as shown, taking note of the Pin1 locator.

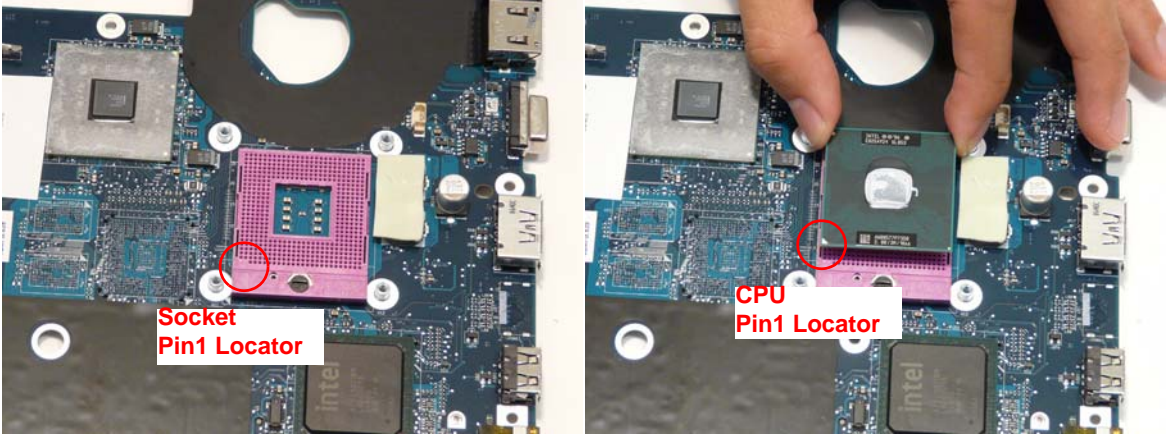

2. Using a flat-bladed screw driver, rotate the CPU locking screw 180° clockwise to secure the CPU in place.

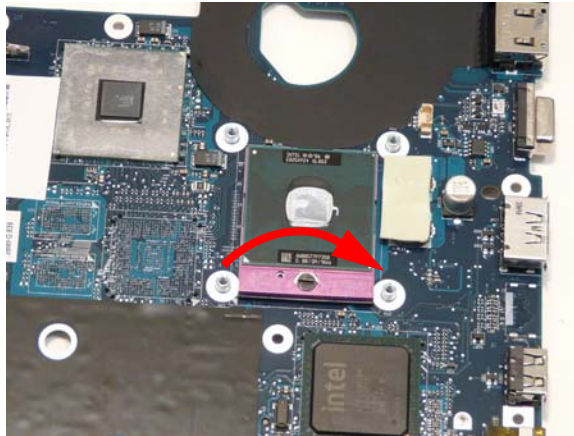

# Replacing the Thermal Module

**WARNING:**To prevent damage to the Thermal Module or the CPU, hold the Thermal Module by both ends at the same time.

**IMPORTANT:**If the replacement Thermal Module does not include the thermal protection pad shown below, reuse the original thermal protection pad with the new Thermal Module.



1. Align and place the Thermal Module in the on the mainboard as shown.
2. Remove the four screws from the Thermal Module numerically, from 1 to 4.

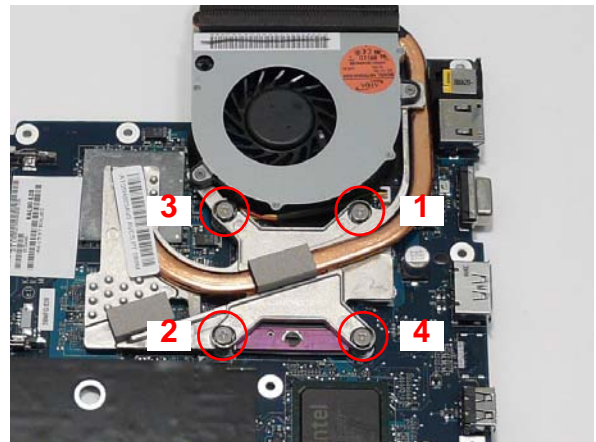
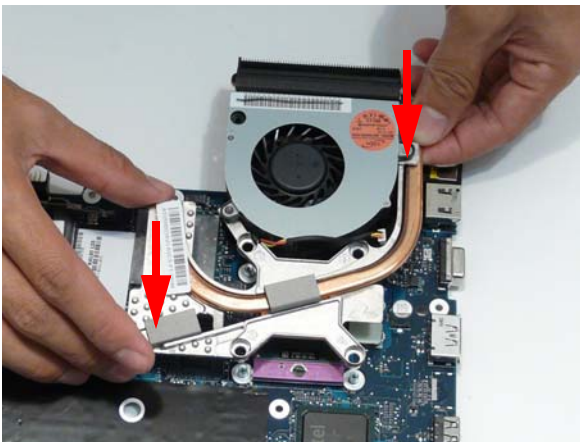

3. Connect fan cable to the mainboard as shown.

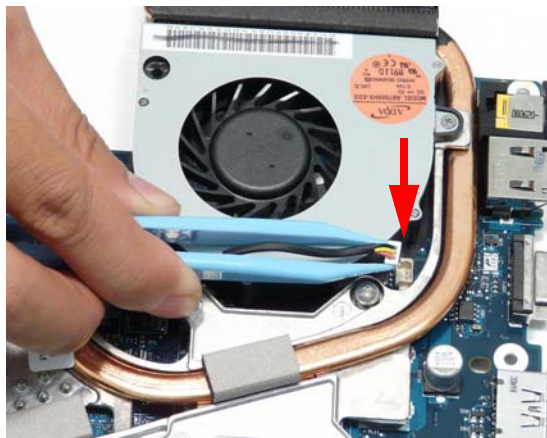

# Replacing the RJ-11 Port

1. Replace the RJ-11 Port in the casing as shown.
2. Place the cable bundle in the casing and apply pressure to secure the adhesive in place.

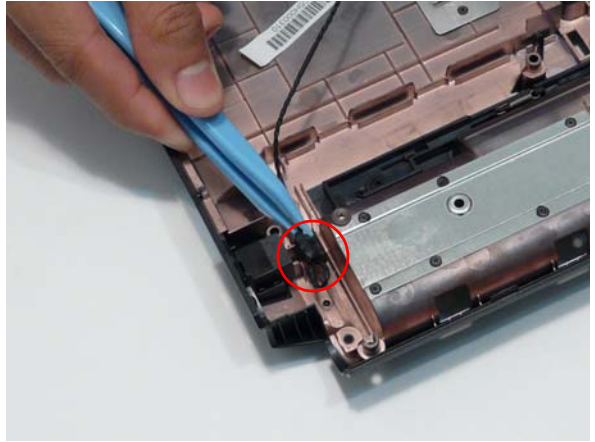
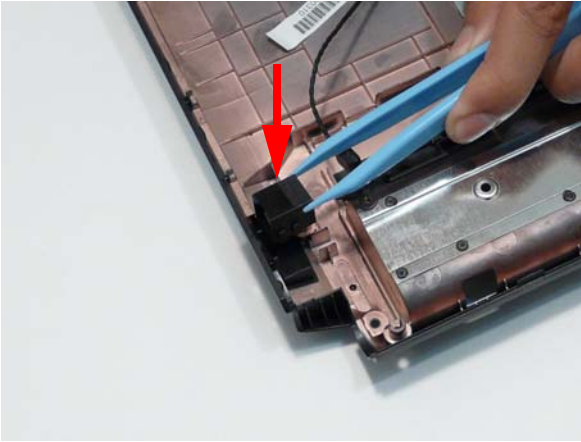

3. Run the cable along the cable channel using all available cable clips.
4. Replace the adhesive tape and insert the cable through the casing as shown.

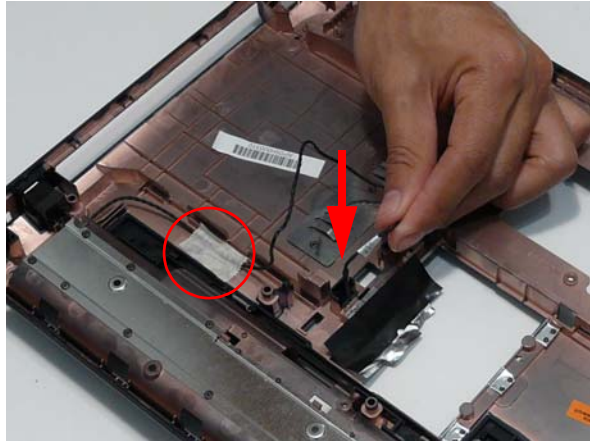
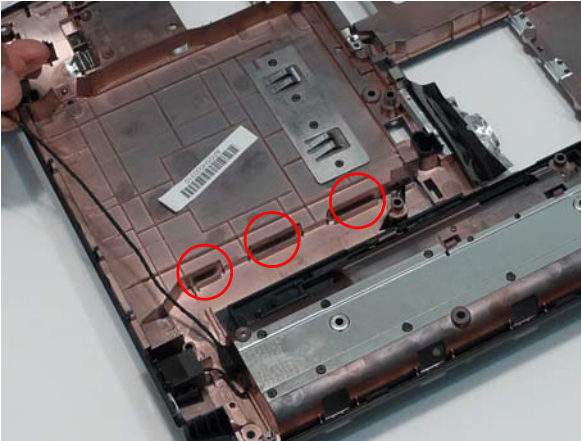

5. Pull the cable through the casing completely.
6. Turn the computer over and run the cable along the cable channel using all available cable clips.

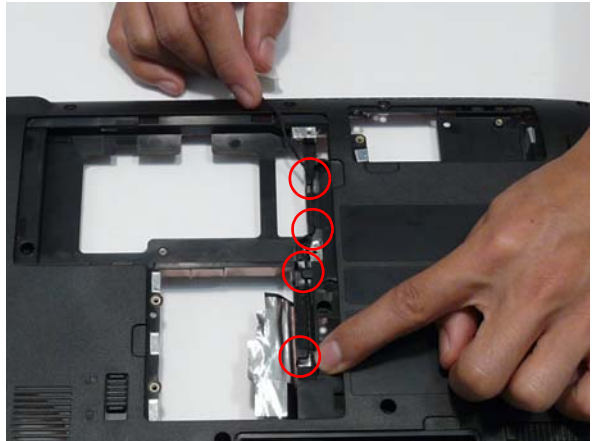
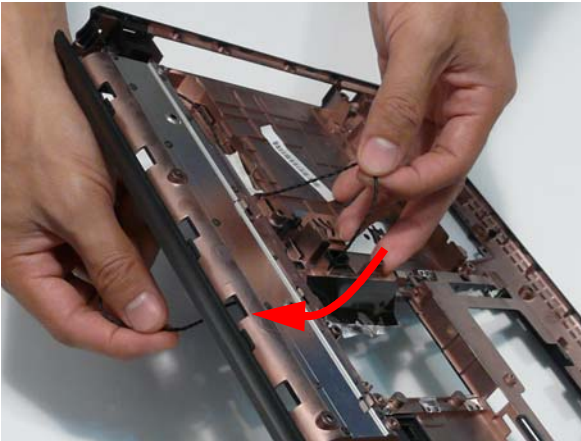

---

7. Insert the cable through the casing to the top side as shown.

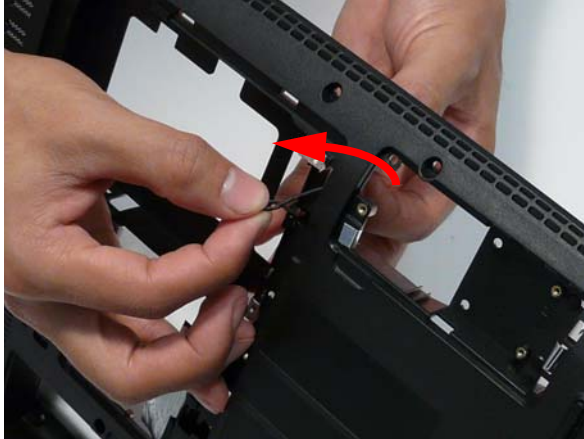

## Replacing the Mainboard

1. Ensure that the Mainboard is face up. Place the Mainboard in the chassis, left hand edge first to allow the I/O Ports through the casing, then lower it into place.

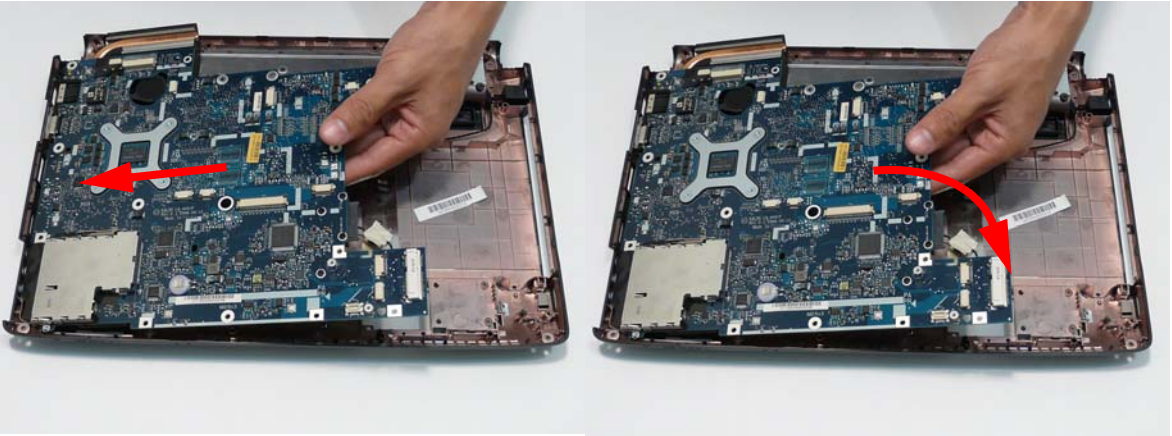

2. Ensure the screw socket is aligned. Replace the single securing screws as shown.

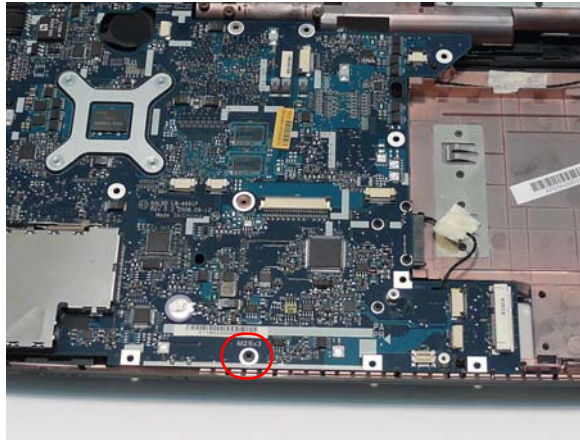

**NOTE:** Make sure the I/O ports are positioned correctly through the lower cover, and the screw sockets are visible through the mainboard.

3. Replace the RJ-11 cable in the retaining clip on the Mainboard.

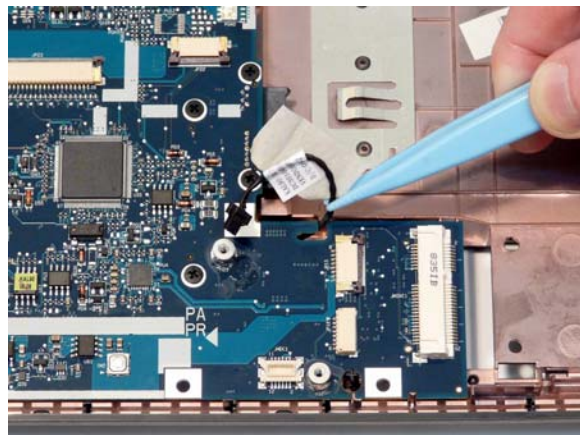

## Replacing the Bluetooth Board

1. Insert the Bluetooth Module left side first and lower it into place.
2. Replace the single securing screw.

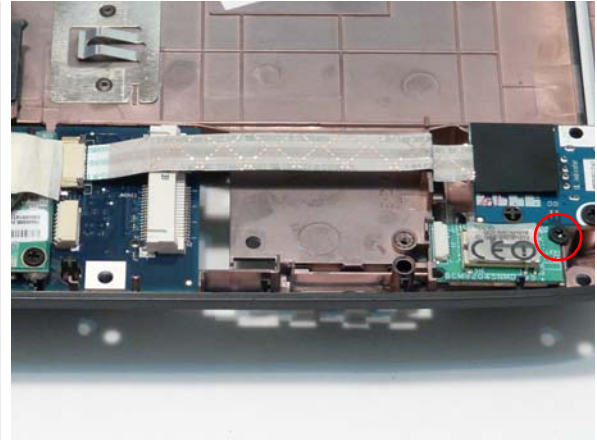
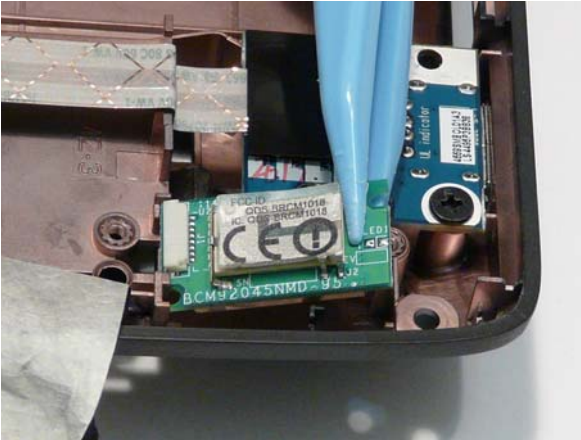

3. Reconnect the Bluetooth cable to the Mainboard and secure the cable in place with the tape.
4. Reconnect the Bluetooth cable to the Bluetooth Module.

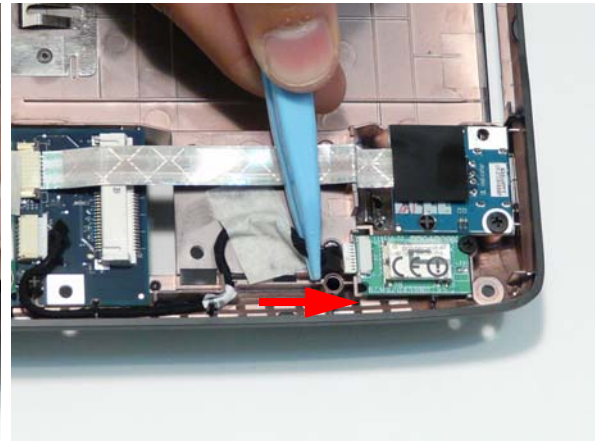
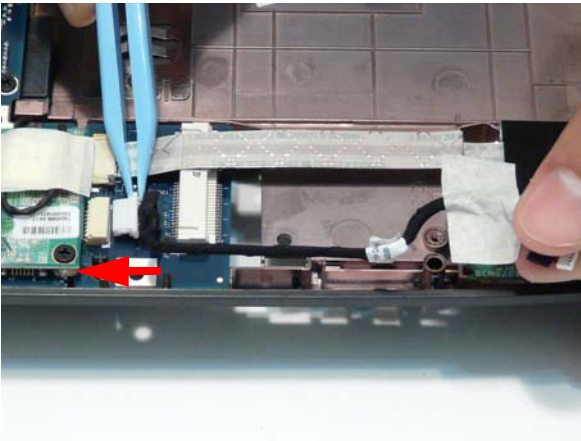

## Replacing the Modem Module

1. Connect the modem cable as shown.
2. Replace the Modem Module on the Mainboard.

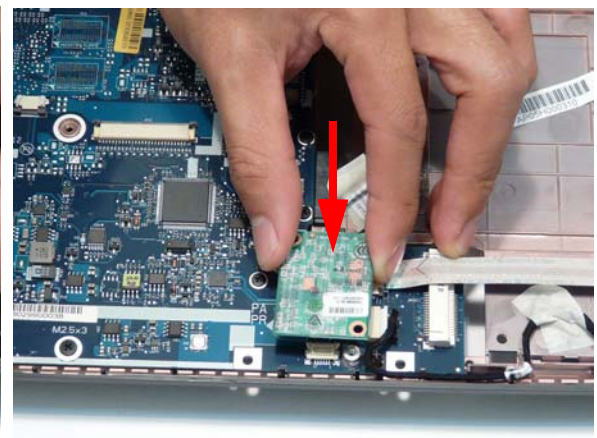
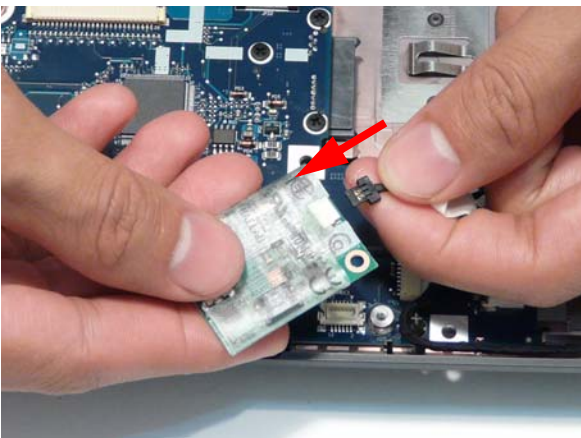

3. Align the screw sockets and replace the two screws.

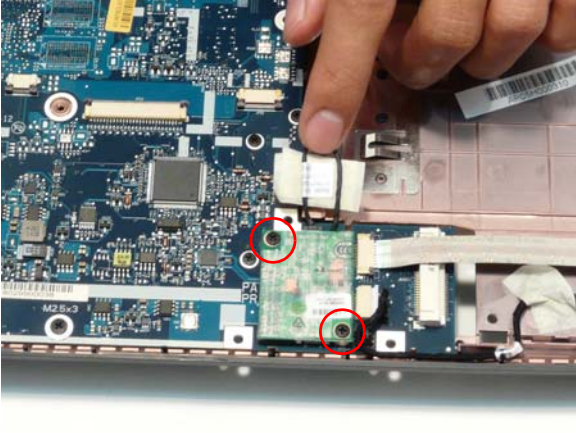

4. Secure the Modem cable in place with the adhesive tape.

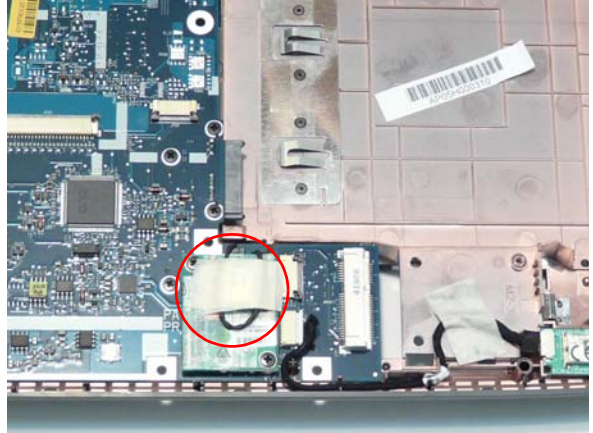

## Replacing the USB Board

1. Insert the USB Board into the casing, ensuring that the USB Port is accessible through the case.
2. Run the cable along the casing and insert it into the FFC connector.

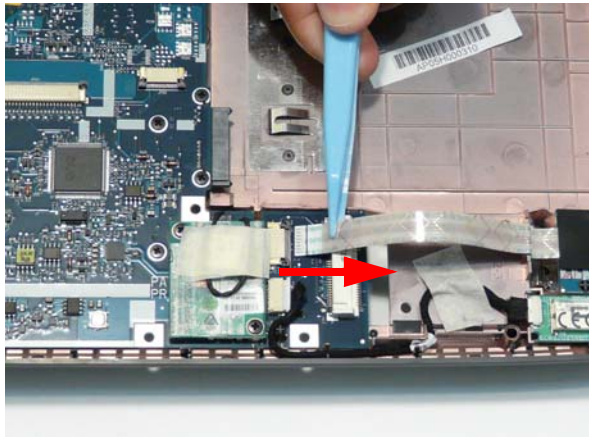
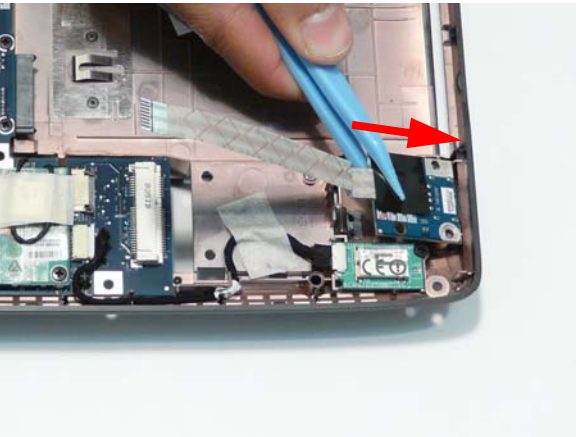

3. Lock the connector and press down on the FFC cable to secure it on the casing.

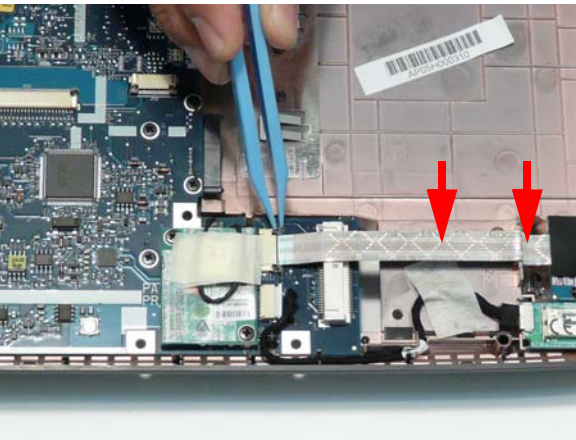

4. Ensure the locating pins is correctly seated and replace the single securing screw.

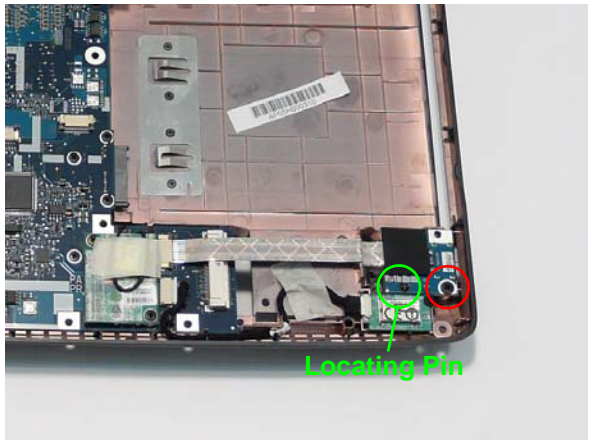



---

## Replacing the Media Board

**WARNING:** Care must be taken when replacing the Media Board Cover to prevent damage or stress to the surface.

1. Place the media board in the upper case.

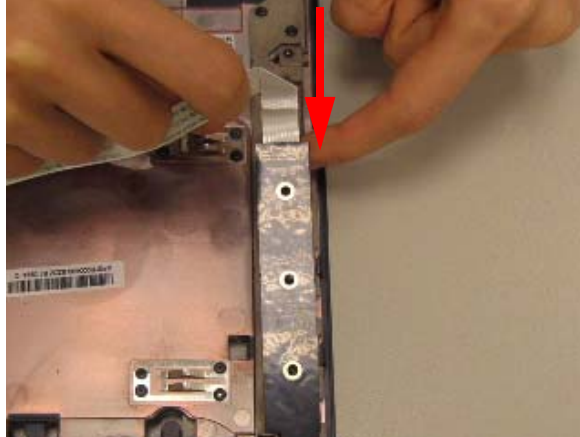

2. Secure the three securing screws as shown.

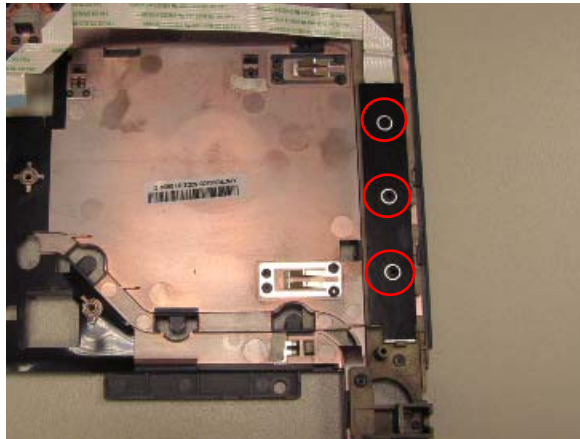

3. Adhere the FFC to the upper case as shown.

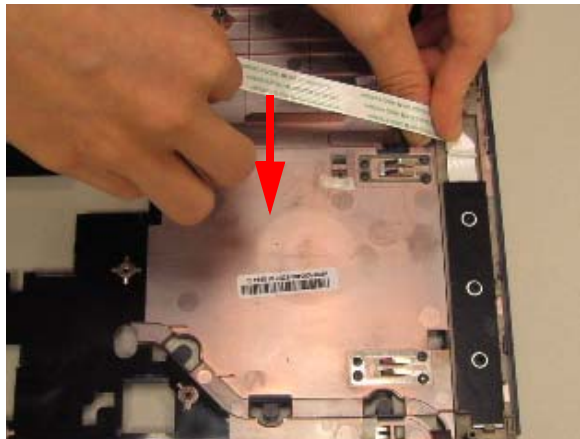

---

Step	Size	Quantity	Screw Type
Media Board	M2.5*3	3	

## Replacing the TouchPad Bracket

1. Place the TouchPad in the casing.

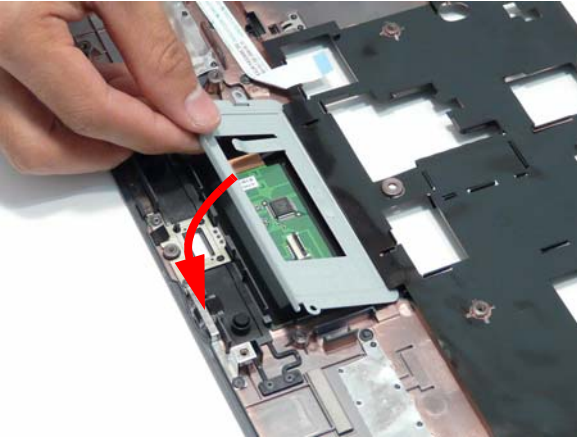

2. Replace the two securing screws.

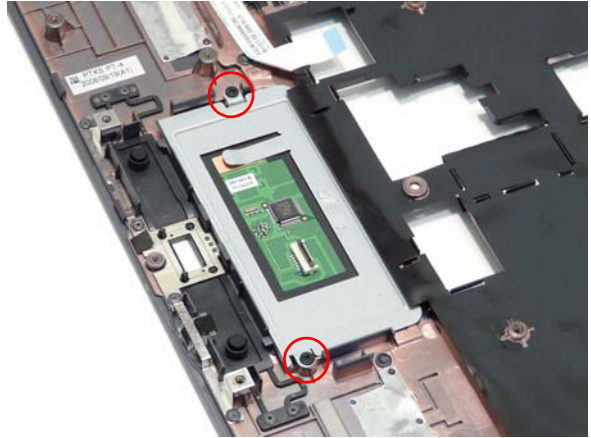

3. Replace the FFC and close the locking latch.

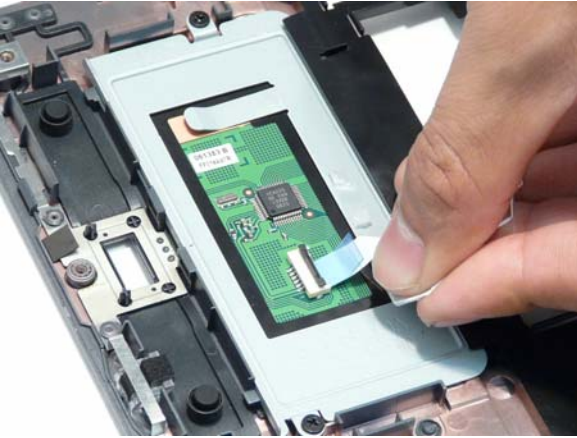

4. Run the cable along the Bracket and press down to secure it in place.



## Replacing the Finger Print Reader

1. Replace the Finger Print Reader in the Upper Cover in the direction of the arrow.

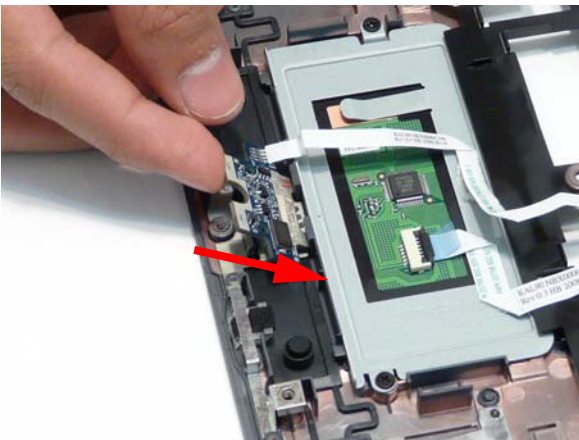

2. Run the FFC along the TouchPad bracket, as shown, and press down to secure it in place.

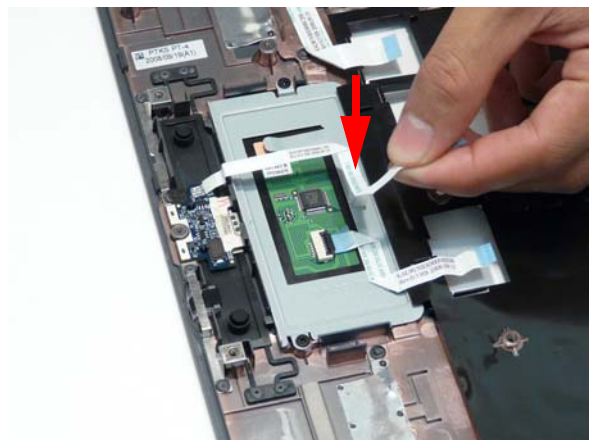

3. Replace the Finger Print Reader Bracket rear edge first and lower it into place.
4. Replace the single securing screw.

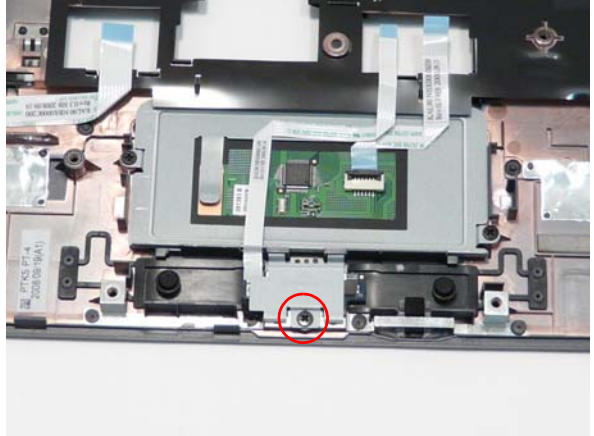
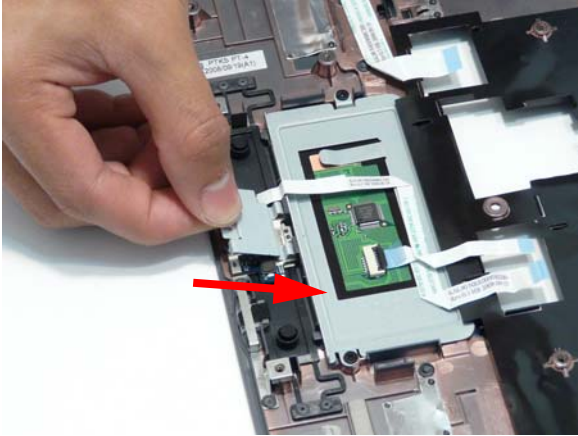

---

## Replacing the Upper Cover

**WARNING:**Care must be taken when replacing the Upper Cover to prevent damage or stress to the surface.

1. Place the Upper Cover on the Lower Cover, front edge first, and lower it into place.



2. Starting with the sides, press down all around the perimeter of the cover to secure it in place.



3. Reconnect the three FFC cables to the mainboard.



Connect and lock connector A as shown.

Connect and lock connector B as shown.

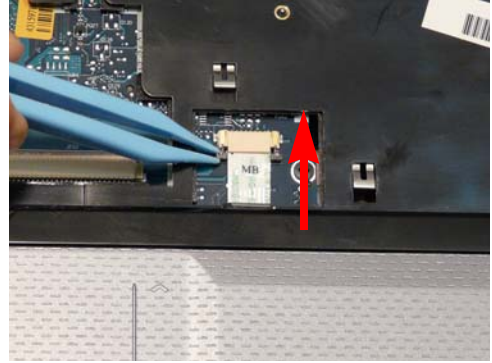
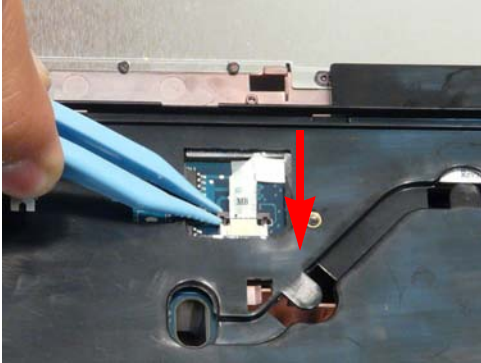

Connect and lock connector C as shown.

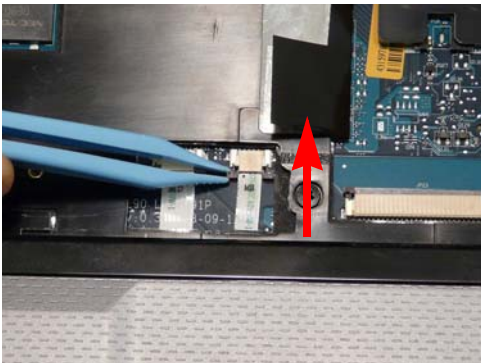

---

4. Replace the two securing screws in the Upper Cover.



5. Turn the computer over. Replace the fifteen screws on the bottom panel.

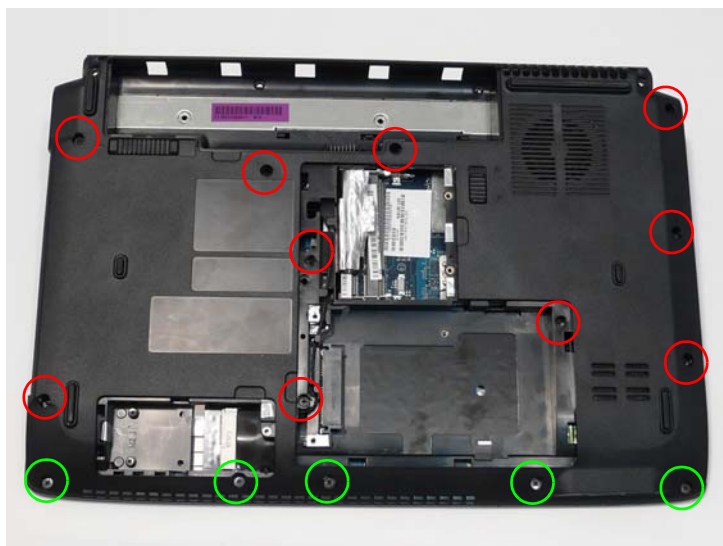

# Replacing the LCD Module

1. Carefully align the LCD module over the hinge sockets and lower the module into the chassis, taking care not to trap the LCD cables.
2. Replace the two securing screws on the right hinge as shown.

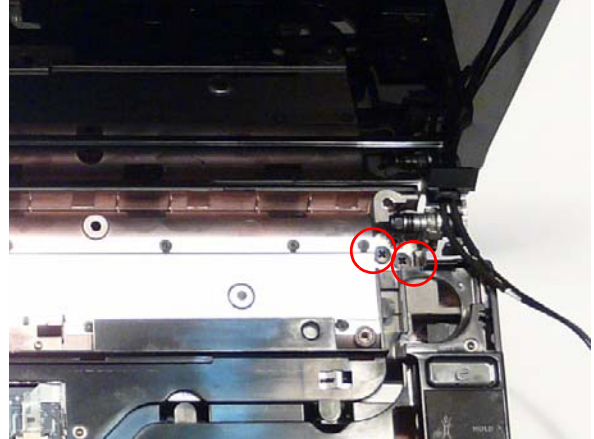
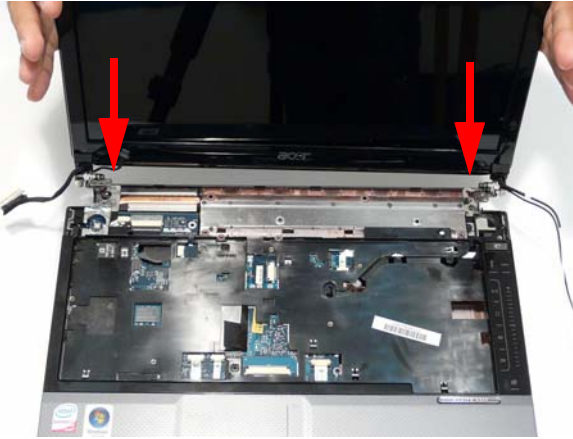

3. Replace the adhesive strip on the left hinge.
4. Replace the two securing screws on the left hinge as shown.

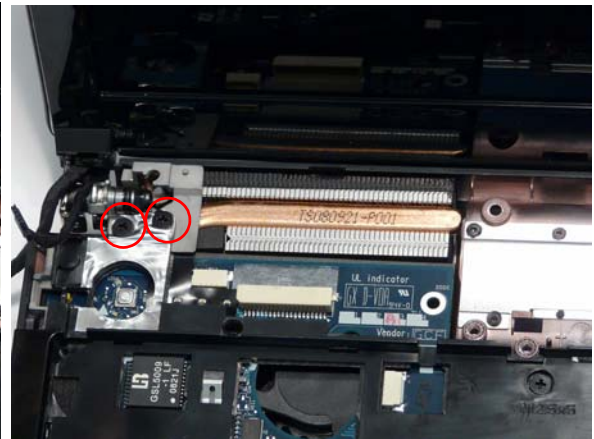
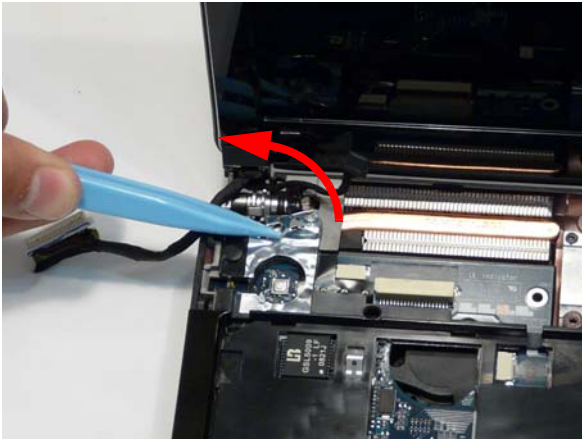

5. Reconnect the LCD cable to the Mainboard.

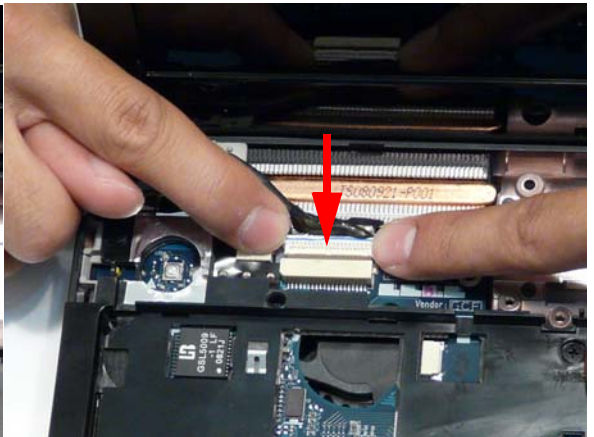
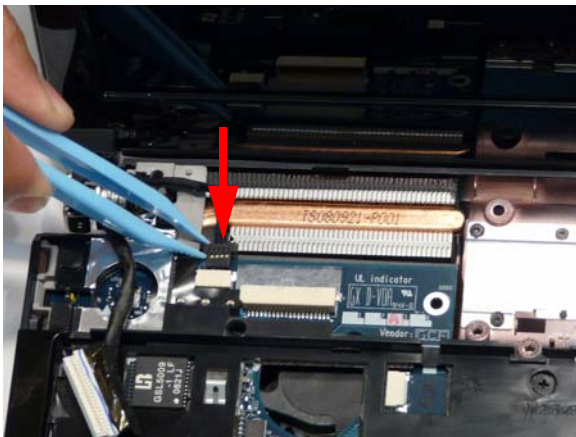



**IMPORTANT:**Run the cables as shown to avoid trapping when the Switch Cover is replaced.



6. Insert the Antenna cables through the casing, as shown, and pull through from the underside.

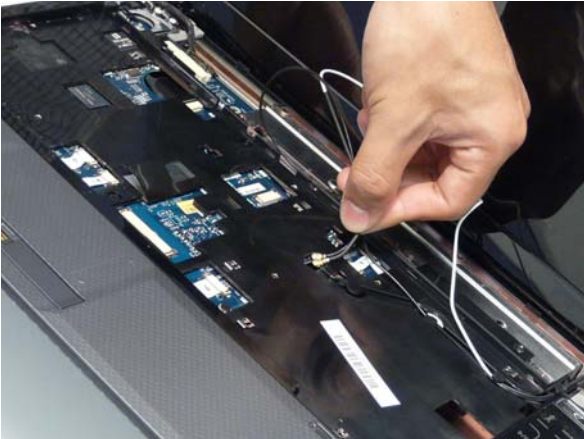

7. Ensure the cable is pulled completely through the casing.

8. Run the Antenna cables along the cable channel as shown, using all available cable clips.

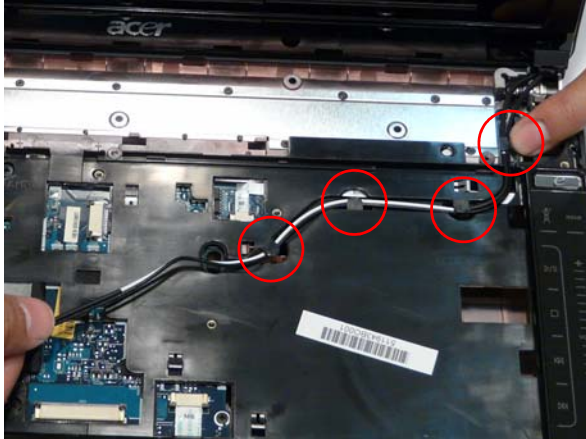
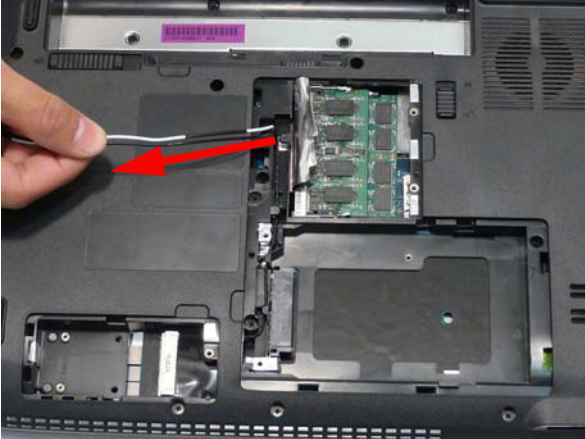

**IMPORTANT:** Run the cables as shown to avoid trapping when the Switch Cover is replaced.

9. Replace the two adhesive strips to secure the cables in place.

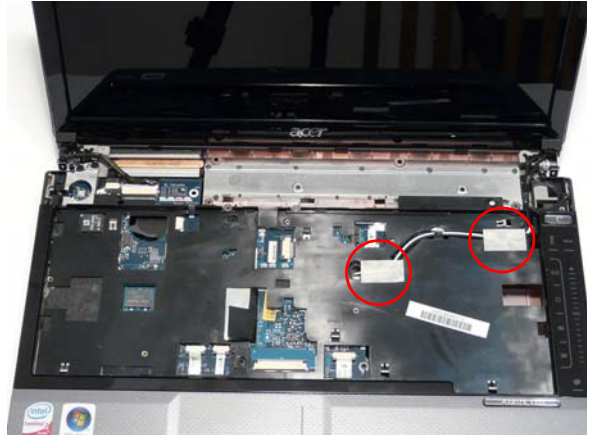

10. Pull the Antenna through the casing into the WLAN bay as shown.

11. Run the Antenna cables along the cable channel as shown, using all the available cable clips.

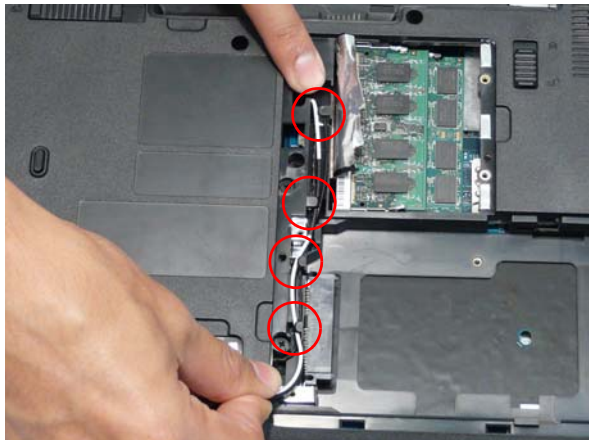
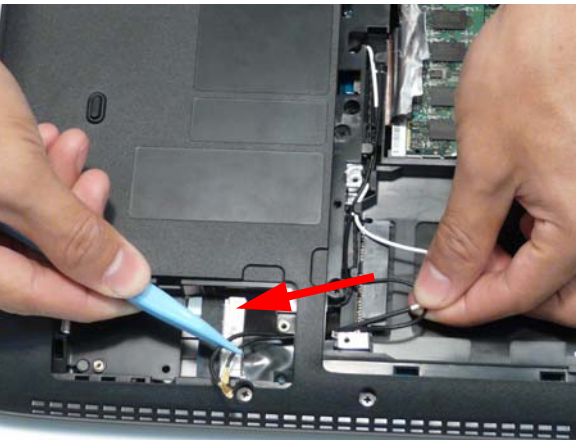

12. Replace the adhesive strip to secure the cables in place.

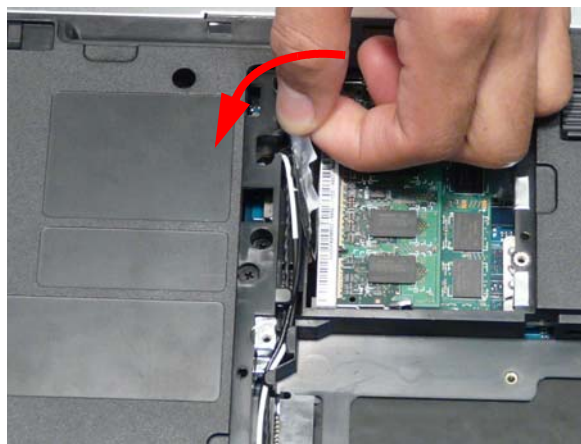

---

13. Replace the two securing screws.



## Replacing the Speaker Module

1. Align and replace the Speaker Module in the lower case.

**IMPORTANT:** Run the LCD cables over the Speaker Module as shown to avoid trapping when the Switch Cover is replaced.

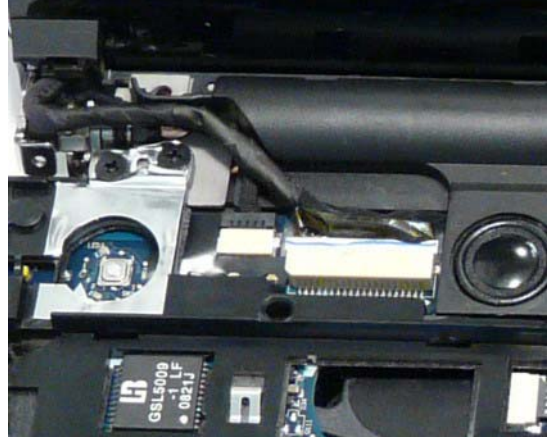
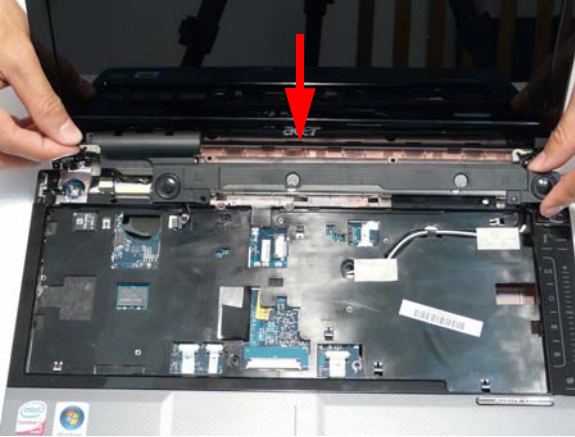

2. Reconnect the Speaker cable.

3. Replace the adhesive tape to secure the LCD cables in place.

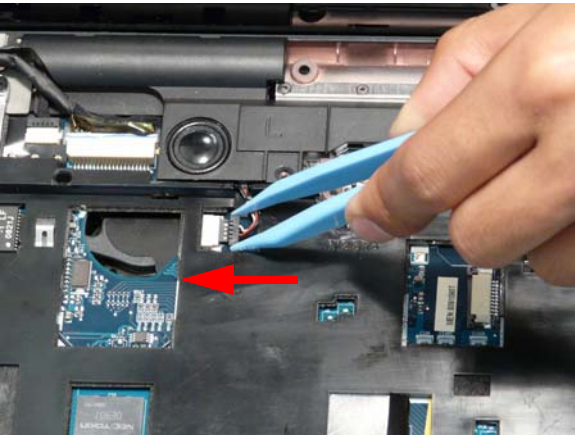

4. Replace the two securing screws as shown.

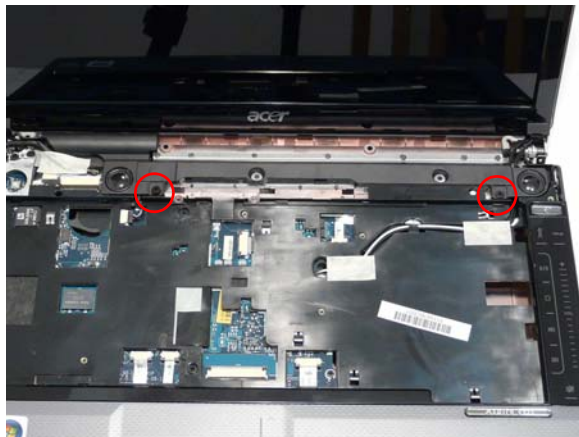

## Replacing the Keyboard

1. Place the Keyboard on the Upper Cover, face up and reconnect the FFC cable to the Mainboard.
2. Insert the Keyboard, front edge first, into the Upper Cover as shown. Ensure that the five tabs are correctly seated.



3. Press down both sides of the keyboard to locate it correctly.



---

## Replacing the Switch Cover

1. Place the Switch Cover on the Upper Case as shown.



2. Press down both sides of the Switch Cover to snap it into place.



3. Continue to press down as shown to correctly seat the Switch Cover on the Upper Cover.



---

4. Turn the computer over and replace the six securing screws as shown.



---

## Replacing the Hinge Covers

**IMPORTANT:** The left and right Hinge Covers are shaped differently and marked **L** and **R** on the inside. Ensure that the correct cover is used during reassembly.

1. Align the Hinge Covers screw hole side up and slide them on to the hinge assemblies.



2. Replace the two securing screws and caps.





# Replacing the ODD Module

1. Align the ODD Bezel as shown and press it into place. Close the ODD drawer.

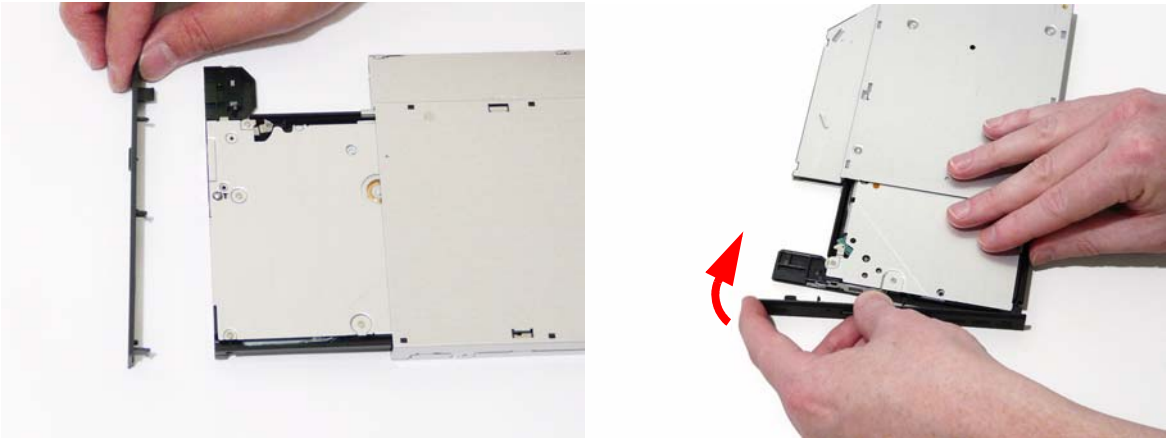

2. Align the ODD Bracket as shown and replace the securing screws.

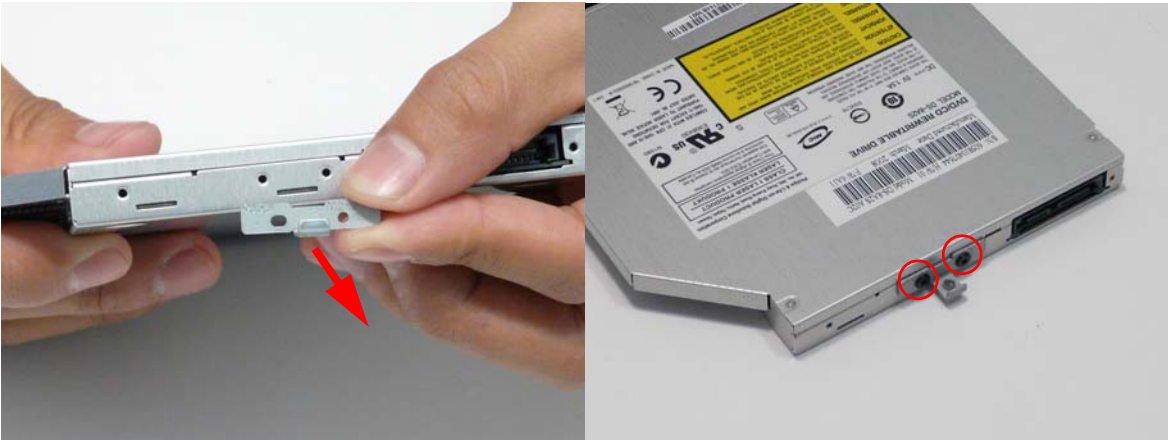

3. Push the ODD Module into the chassis as shown until the bezel is flush with the casing.

4. Replace the securing screw.



# Replacing the Hard Disk Drive Module

- 1. Place the HDD carrier on the HDD.
- 2. Replace the four securing screws (two each side).

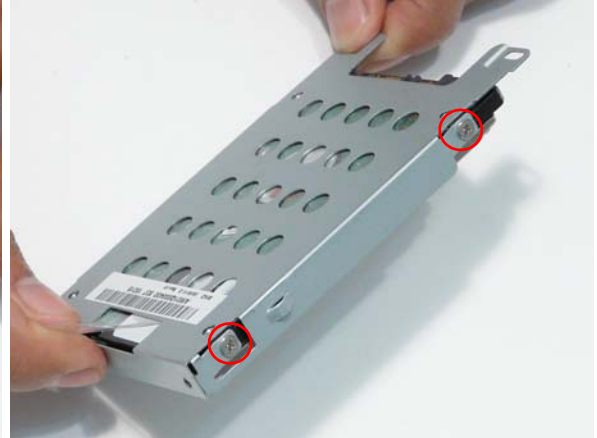

- 3. Place the HDD Module in the HDD bay as shown and slide it in the direction of the arrow to connect the interface.

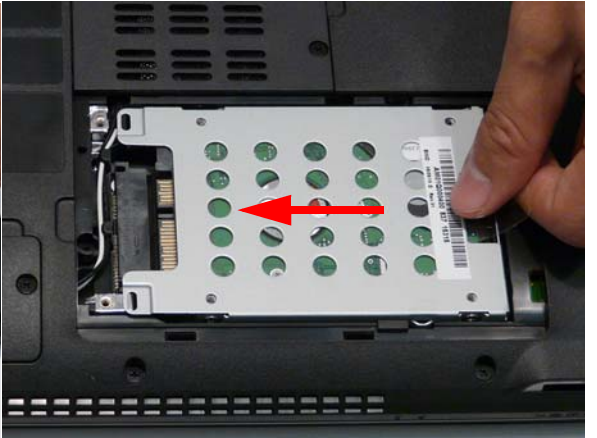
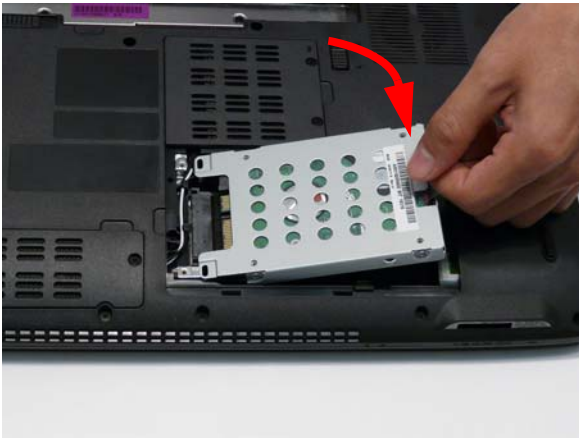

# Replacing the DIMM Modules

**NOTE:** To replace DIMM Module 2, first remove DIMM Module 1. In this procedure, only DIMM Module 1 is shown.

- 1. Insert the DIMM Module flush with the connector and press down to lock in place.

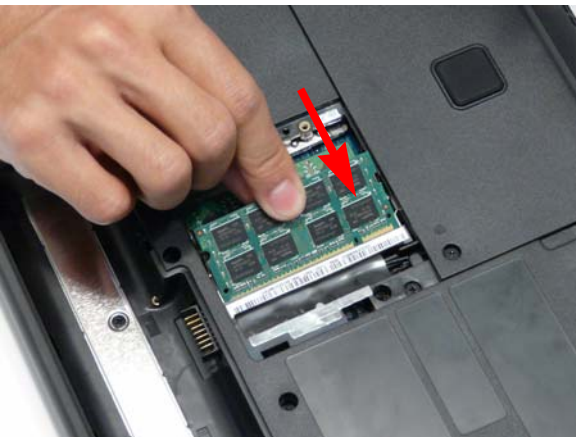

# Replacing the WLAN Module

1. Insert the WLAN board into the WLAN socket.
2. Replace the two screws to secure the module.



3. Connect the two antenna cables to the module.  
**NOTE:** The White cable goes to the upper terminal and the black cable to the lower terminal.

**IMPORTANT:** Ensure that the cabling is replaced as shown to avoid trapping when the covers are replaced.



# Replacing the Lower Covers

1. Replace the Lower Covers and secure the captive screws.

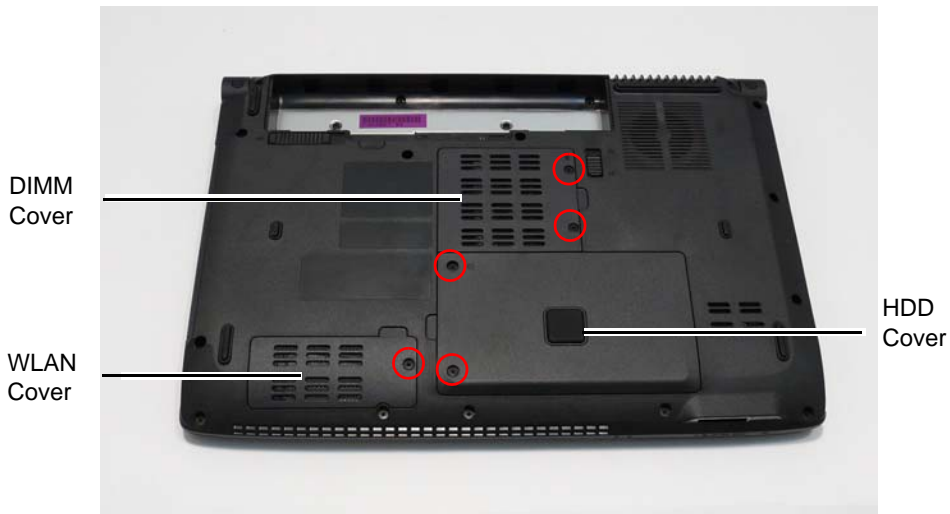

---

## Replacing the SD Card Dummy Trays

1. Insert the SD Card and push into the slot until flush with the chassis cover.



## Replacing the Battery

1. Slide and hold the battery release latch to the release position (1), then insert the battery and press down (2).
2. Slide the battery lock/unlock latch to the lock position.

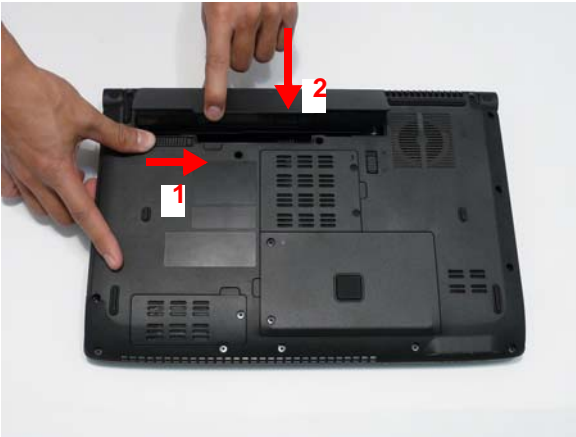

# Troubleshooting

---

## Common Problems

Use the following procedure as a guide for computer problems.

**NOTE:** The diagnostic tests are intended to test only Acer products. Non-Acer products, prototype cards, or modified options can give false errors and invalid system responses.

1. Obtain the failing symptoms in as much detail as possible.
2. Verify the symptoms by attempting to re-create the failure by running the diagnostic test or by repeating the same operation.
3. Use the following table with the verified symptom to determine which page to go to.

Symptoms (Verified)	Go To
Power On Issue	Page 140
No Display Issue	Page 141
LCD Failure	Page 143
Internal Keyboard Failure	Page 143
Touchpad Failure	Page 144
Internal Speaker Failure	Page 144
Internal Microphone Failure	Page 146
ODD Failure	Page 148
Rightside USB Failure	Page 151
Modem Failure	Page 151
WLAN/WiMAX Failure	Page 152
Bluetooth Failure	Page 152
EasyTouch Button Failure	Page 153
Media Board Failure	Page 153
Finger Print Reader Failure	Page 154
Thermal Unit Failure	Page 154
Other Functions Failure	Page 155
Intermittent Failures	Page 156
Undetermined Failures	Page 156

4. If the Issue is still not resolved, see "Online Support Information" on page 183.

---

## Power On Issue

If the system doesn't power on, perform the following actions one at a time to correct the problem. Do not replace a non-defective FRUs:

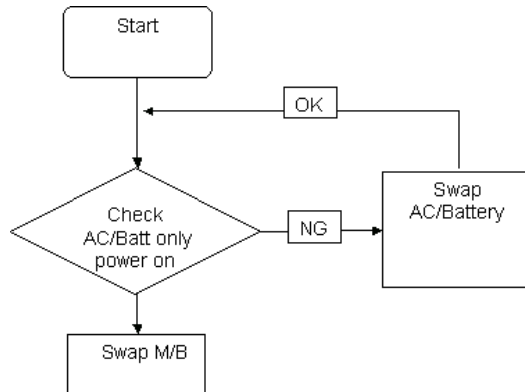

## Computer Shutdown Intermittently

If the system powers off at intervals, perform the following actions one at a time to correct the problem.

1. Check the power cable is properly connected to the computer and the electrical outlet.
2. Remove any extension cables between the computer and the outlet.
3. Remove any surge protectors between the computer and the electrical outlet. Plug the computer directly into a known good electrical outlet.
4. Disconnect the power and open the casing to check the Thermal Unit and fan airways are free of obstructions.
5. Remove all external and non-essential hardware connected to the computer that are not necessary to boot the computer to the failure point.
6. Remove any recently installed software.
7. If the Issue is still not resolved, see "Online Support Information" on page 183.

# No Display Issue

If the **Display** doesn't work, perform the following actions one at a time to correct the problem. Do not replace a non-defective FRUs:

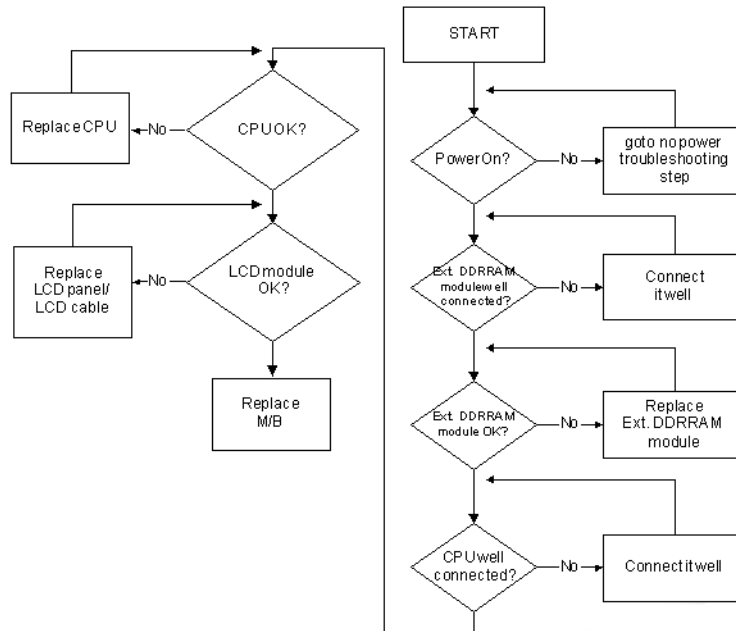

## No POST or Video

If the POST or video doesn't display, perform the following actions one at a time to correct the problem.

1. Make sure that the internal display is selected. On this notebook model, switching between the internal display and the external display is done by pressing **Fn+F5**. Reference Product pages for specific model procedures.
2. Make sure the computer has power by checking at least one of the following occurs:
  - Fans start up
  - Status LEDs light up

If there is no power, see "Power On Issue" on page 140.

3. Drain any stored power by removing the power cable and battery and holding down the power button for 10 seconds. Reconnect the power and reboot the computer.
4. Connect an external monitor to the computer and switch between the internal display and the external display is by pressing **Fn+F5** (on this model).

If the POST or video appears on the external display, see "LCD Failure" on page 143.

5. Disconnect power and all external devices including port replicators or docking stations. Remove any memory cards and CD/DVD discs. Restart the computer.

If the computer boots correctly, add the devices one by one until the failure point is discovered.

6. Reseat the memory modules.
7. Remove the drives (see "Disassembly Process" on page 50).
8. If the Issue is still not resolved, see "Online Support Information" on page 183.

---

## Abnormal Video Display

If video displays abnormally, perform the following actions one at a time to correct the problem.

1. Reboot the computer.
2. If permanent vertical/horizontal lines or dark spots display in the same location, the LCD is faulty and should be replaced. See “Disassembly Process” on page 50.
3. If extensive pixel damage is present (different colored spots in the same locations on the screen), the LCD is faulty and should be replaced. See “Disassembly Process” on page 50.
4. Adjust the brightness to its highest level. See the User Manual for instructions on adjusting settings.  
**NOTE:** Ensure that the computer is not running on battery alone as this may reduce display brightness.  
If the display is too dim at the highest brightness setting, the LCD is faulty and should be replaced. See “Disassembly Process” on page 50.
5. Check the display resolution is correctly configured:
  - a. Minimize or close all Windows.
  - b. If display size is only abnormal in an application, check the view settings and control/mouse wheel zoom feature in the application.
  - c. If desktop display resolution is not normal, right-click on the desktop and select **Personalize**→ **Display Settings**.
  - d. Click and drag the Resolution slider to the desired resolution.
  - e. Click **Apply** and check the display. Readjust if necessary.
6. Roll back the video driver to the previous version if updated.
7. Remove and reinstall the video driver.
8. Check the Device Manager to determine that:
  - The device is properly installed. There are no red Xs or yellow exclamation marks.
  - There are no device conflicts.
  - No hardware is listed under Other Devices.
9. If the Issue is still not resolved, see “Online Support Information” on page 183.
10. Run the Windows Memory Diagnostic from the operating system DVD and follow the onscreen prompts.
11. If the Issue is still not resolved, see “Online Support Information” on page 183.

## Random Loss of BIOS Settings

If the computer is experiencing intermittent loss of BIOS information, perform the following actions one at a time to correct the problem.

1. If the computer is more than one year old, replace the CMOS battery.
2. Run a complete virus scan using up-to-date software to ensure the computer is virus free.
3. If the computer is experiencing HDD or ODD BIOS information loss, disconnect and reconnect the power and data cables between devices.  
If the BIOS settings are still lost, replace the cables.
4. If HDD information is missing from the BIOS, the drive may be defective and should be replaced.
5. Replace the Motherboard.
6. If the Issue is still not resolved, see “Online Support Information” on page 183.



---

## LCD Failure

If the **LCD** fails, perform the following actions one at a time to correct the problem. Do not replace a non-defective FRUs:

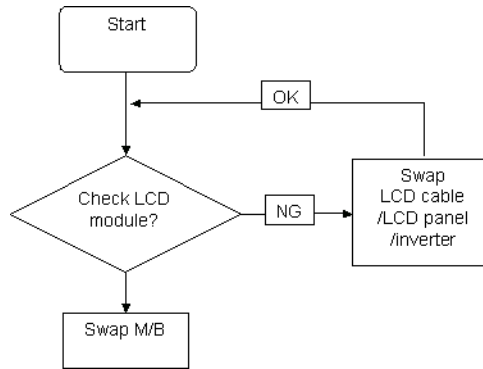

## Built-In Keyboard Failure

If the built-in **Keyboard** fails, perform the following actions one at a time to correct the problem. Do not replace a non-defective FRUs:

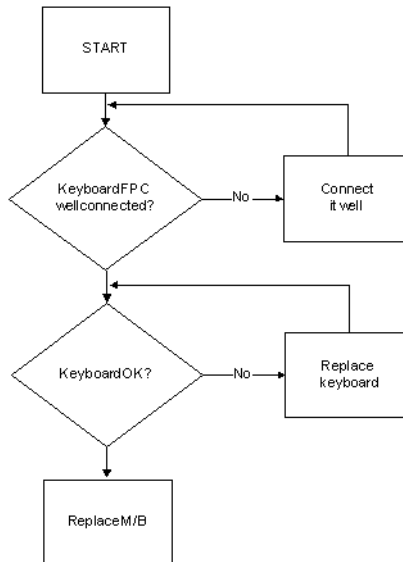

# Touchpad Failure

If the **Touchpad** doesn't work, perform the following actions one at a time to correct the problem. Do not replace a non-defective FRUs:

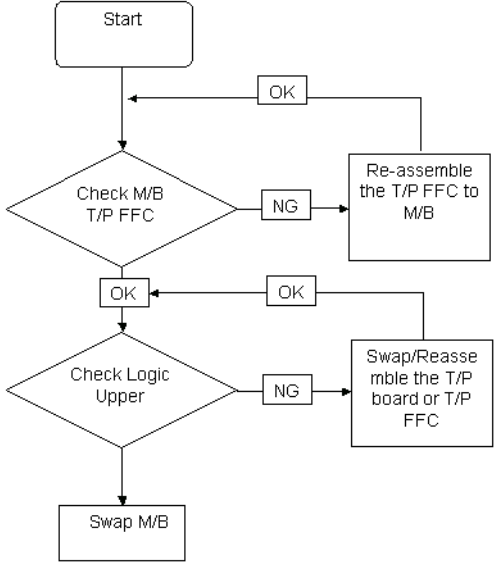

# Internal Speaker Failure

If the internal **Speakers** fail, perform the following actions one at a time to correct the problem. Do not replace a non-defective FRUs:

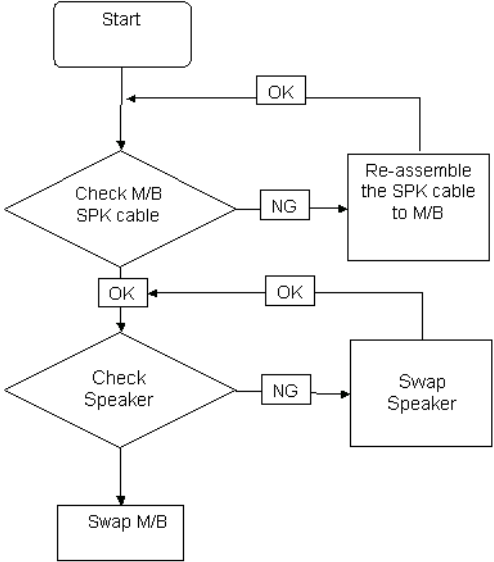

---

## Sound Problems

If sound problems are experienced, perform the following actions one at a time to correct the problem.

1. Reboot the computer.
2. Navigate to **Start** → **Control Panel** → **System and Maintenance** → **System** → **Device Manager**. Check the Device Manager to determine that:
  - The device is properly installed.
  - There are no red Xs or yellow exclamation marks.
  - There are no device conflicts.
  - No hardware is listed under Other Devices.
3. Roll back the audio driver to the previous version, if updated recently.
4. Remove and reinstall the audio driver.
5. Ensure that all volume controls are set mid range:
  - a. Click the volume icon on the taskbar and drag the slider to 50. Ensure that the volume is not muted.
  - b. Click Mixer to verify that other audio applications are set to 50 and not muted.
6. Navigate to **Start** → **Control Panel** → **Hardware and Sound** → **Sound**. Ensure that Speakers are selected as the default audio device (green check mark).

**NOTE:** If Speakers does not show, right-click on the **Playback** tab and select **Show Disabled Devices** (clear by default).
7. Select Speakers and click **Configure** to start **Speaker Setup**. Follow the onscreen prompts to configure the speakers.
8. Remove and recently installed hardware or software.
9. Restore system and file settings from a known good date using **System Restore**.

If the issue is not fixed, repeat the preceding steps and select an earlier time and date.
10. Reinstall the Operating System.
11. If the Issue is still not resolved, see “Online Support Information” on page 183.

---

# Internal Microphone Failure

If the internal **Microphone** fails, perform the following actions one at a time to correct the problem. Do not replace a non-defective FRUs:

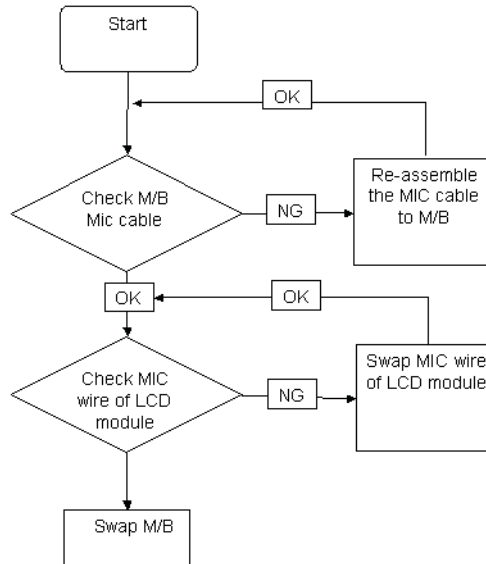

## Microphone Problems

If internal or external **Microphones** do not operate correctly, perform the following actions one at a time to correct the problem.

1. Check that the microphone is enabled. Navigate to **Start** → **Control Panel** → **Hardware and Sound** → **Sound** and select the **Recording** tab.
2. Right-click on the **Recording** tab and select **Show Disabled Devices** (clear by default).
3. The microphone appears on the **Recording** tab.
4. Right-click on the microphone and select **Enable**.
5. Select the microphone then click **Properties**. Select the **Levels** tab.
6. Increase the volume to the maximum setting and click **OK**.
7. Test the microphone hardware:
  - a. Select the microphone and click **Configure**.
  - b. Select **Set up microphone**.
  - c. Select the microphone type from the list and click **Next**.
  - d. Follow the onscreen prompts to complete the test.
8. If the Issue is still not resolved, see "Online Support Information" on page 183.

---

## HDD Not Operating Correctly

If the **HDD** does not operate correctly, perform the following actions one at a time to correct the problem.

1. Disconnect all external devices.
2. Run a complete virus scan using up-to-date software to ensure the computer is virus free.
3. Run the Windows Vista Startup Repair Utility:
  - a. insert the Windows Vista Operating System DVD in the ODD and restart the computer.
  - b. When prompted, press any key to start to the operating system DVD.
  - c. The **Install Windows** screen displays. Click **Next**.
  - d. Select **Repair your computer**.
  - e. The **System Recovery Options** screen displays. Click **Next**.
  - f. Select the appropriate operating system, and click **Next**.

**NOTE:** Click **Load Drivers** if controller drives are required.

- g. Select **Startup Repair**.
- h. Startup Repair attempts to locate and resolve issues with the computer.
- i. When complete, click **Finish**.

If an issue is discovered, follow the onscreen information to resolve the problem.

4. Run the Windows Memory Diagnostic Tool. For more information see Windows Help and Support.
5. Restart the computer and press F2 to enter the BIOS Utility. Check the BIOS settings are correct and that CD/DVD drive is set as the first boot device on the Boot menu.
6. Ensure all cables and jumpers on the HDD and ODD are set correctly.
7. Remove any recently added hardware and associated software.
8. Run the Windows Disk Defragmenter. For more information see Windows Help and Support.
9. Run Windows Check Disk by entering **chkdsk /r** from a command prompt. For more information see Windows Help and Support.
10. Restore system and file settings from a known good date using **System Restore**.

If the issue is not fixed, repeat the preceding steps and select an earlier time and date.

11. Replace the HDD. See "Disassembly Process" on page 50.

---

## ODD Failure

If the **ODD** fails, perform the following actions one at a time to correct the problem. Do not replace a non-defective FRUs:

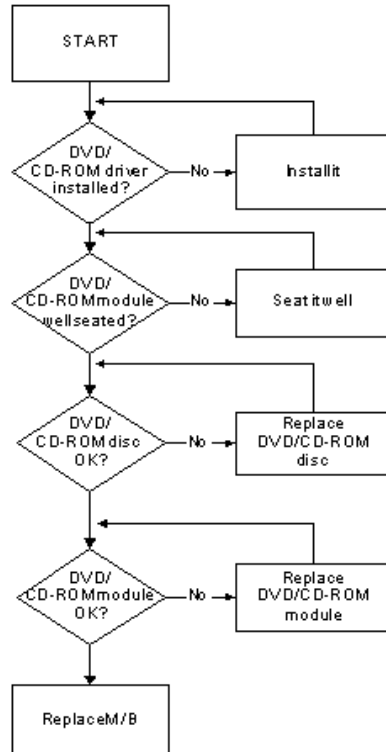

## ODD Not Operating Correctly

If the **ODD** exhibits any of the following symptoms it may be faulty:

- Audio CDs do not play when loaded
- DVDs do not play when loaded
- Blank discs do not burn correctly
- DVD or CD play breaks up or jumps
- Optical drive not found or not active:
  - Not shown in My Computer or the BIOS setup
  - LED does not flash when the computer starts up
  - The tray does not eject
- Access failure screen displays
- The ODD is noisy

Perform the following general solutions one at a time to correct the problem.

1. Reboot the computer and retry the operation.
2. Try an alternate disc.
3. Navigate to **Start** → **Computer**. Check that the ODD device is displayed in the **Devices with Removable Storage** panel.
4. Navigate to **Start** → **Control Panel** → **System and Maintenance** → **System** → **Device Manager**.

- 
- a. Double-click **IDE ATA/ATAPI controllers**. If a device displays a down arrow, right-click on the device and click **Enable**.
  - b. Double-click **DVD/CD-ROM drives**. If the device displays a down arrow, right-click on the device and click **Enable**.
  - c. Check that there are no yellow exclamation marks against the items in **IDE ATA/ATAPI controllers**. If a device has an exclamation mark, right-click on the device and uninstall and reinstall the driver.
  - d. Check that there are no yellow exclamation marks against the items in **DVD/CD-ROM drives**. If a device has an exclamation mark, right-click on the device and uninstall and reinstall the driver.
  - e. If the exclamation marker is not removed from the item in the lists, try removing any recently installed software and retrying the operation.

## Discs Do Not Play

If discs do not play when inserted in the drive, perform the following actions one at a time to correct the problem.

1. Check that the disc is correctly seated in the drive tray and that the label on the disc is visible.
2. Check that the media is clean and scratch free.
3. Try an alternate disc in the drive.
4. Ensure that **AutoPlay** is enabled:
  - a. Navigate to **Start** → **Control Panel** → **Hardware and Sound** → **AutoPlay**.
  - b. Select **Use AutoPlay for all media and devices**.
  - c. In the Audio CD and DVD Movie fields, select the desired player from the drop down menu.
5. Check that the Regional Code is correct for the selected media:

**IMPORTANT:**Region can only be changed a limited number of times. After Changes remaining reaches zero, the region cannot be changed even Windows is reinstalled or the drive is moved to another computer.

- a. Navigate to **Start** → **Control Panel** → **System and Maintenance** → **System** → **Device Manager**.
- b. Double-click **DVD/CD-ROM drives**.
- c. Right-click **DVD drive** and click **Properties**, then click the **DVD Region** tab.
- d. Select the region suitable for the media inserted in the drive.

## Discs Do Not Burn Properly

If discs can not be burned, perform the following actions one at a time to correct the problem.

1. Ensure that the default drive is record enabled:
  - a. Navigate to **Start** → **Computer** and right-click the writable ODD icon. Click **Properties**.
  - b. Select the **Recording** tab. In the **Desktop disc recording** panel, select the writable ODD from the drop down list.
  - c. Click **OK**.
2. Ensure that the software used for burning discs is the factory default. If using different software, refer to the software's user manual.

## Playback is Choppy

If playback is choppy or jumps, perform the following actions one at a time to correct the problem.

1. Check that system resources are not running low:
  - a. Try closing some applications.
  - b. Reboot and try the operation again.
2. Check that the ODD controller transfer mode is set to DMA:
  - a. Navigate to **Start** → **Control Panel** → **System and Maintenance** → **System** → **Device Manager**.

- 
- b. Double-click **IDE ATA/ATAPI controllers**, then right-click ATA Device 0.
  - c. Click **Properties** and select the **Advanced Settings** tab. Ensure that the **Enable DMA** box is checked and click **OK**.
  - d. Repeat for the other ATA Devices shown if applicable.

### Drive Not Detected

If Windows cannot detect the drive, perform the following actions one at a time to correct the problem.

1. Restart the computer and press F2 to enter the BIOS Utility.
2. Check that the drive is detected in the **ATAPI Model Name** field on the Information page.  
**NOTE:** Check that the entry is identical to one of the ODDs specified in “Hardware Specifications and Configurations” on page 18.
3. Turn off the power and remove the cover to inspect the connections to the ODD. See “Disassembly Process” on page 50.
  - a. Check for broken connectors on the drive, motherboard, and cables.
  - b. Check for bent or broken pins on the drive, motherboard, and cable connections.
  - c. Try an alternate cable, if available. If the drive works with the new cable, the original cable should be replaced.
4. Reseat the drive ensuring and all cables are connected correctly.
5. Replace the ODD. See “Disassembly Process” on page 50.

### Drive Read Failure

If discs cannot be read when inserted in the drive, perform the following actions one at a time to correct the problem.

1. Remove and clean the failed disc.
2. Retry reading the CD or DVD.
  - d. Test the drive using other discs.
  - e. Play a DVD movie
  - f. Listen to a music CD

If the ODD works properly with alternate discs, the original disc is probably defective and should be replaced.

3. Turn off the power and remove the cover to inspect the connections to the ODD. See “Disassembly Process” on page 50.
  - a. Check for broken connectors on the drive, motherboard, and cables.
  - b. Check for bent or broken pins on the drive, motherboard, and cable connections.
  - c. Try an alternate cable, if available. If the drive works with the new cable, the original cable should be replaced.
4. Replace the ODD. See “Disassembly Process” on page 50.



# USB Failure (Rightside)

If the rightside **USB** port fails, perform the following actions one at a time to correct the problem. Do not replace a non-defective FRUs:

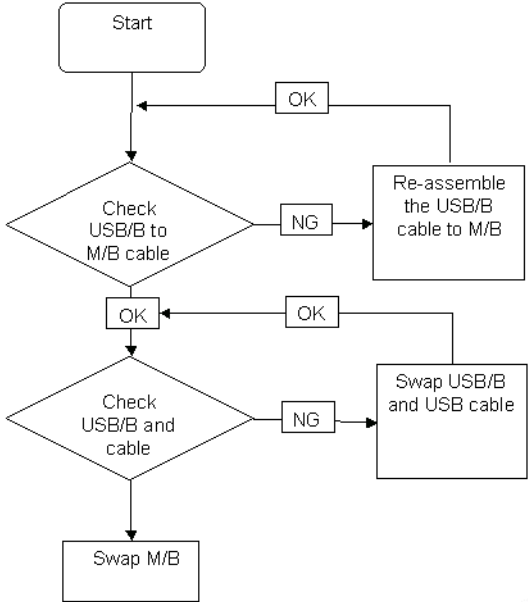

# Modem Function Failure

If the internal **Modem** fails, perform the following actions one at a time to correct the problem. Do not replace a non-defective FRUs:

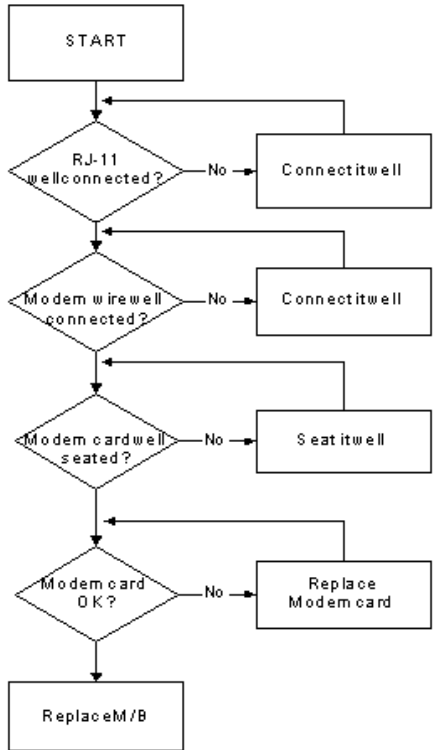

# Wireless Function Failure

If the **WLAN/WiMAX** fails, perform the following actions one at a time to correct the problem. Do not replace a non-defective FRUs:

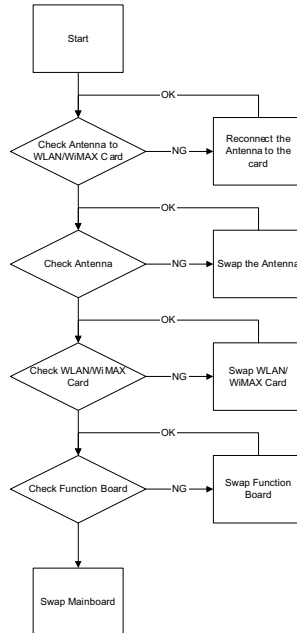

# Bluetooth Function Failure

If the **Bluetooth** fails, perform the following actions one at a time to correct the problem. Do not replace a non-defective FRUs:

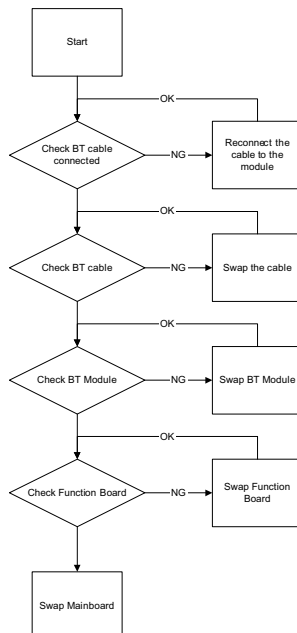

# EasyTouch Button Failure

If the **Acer EasyTouch** buttons fail, perform the following actions one at a time to correct the problem. Do not replace a non-defective FRUs:

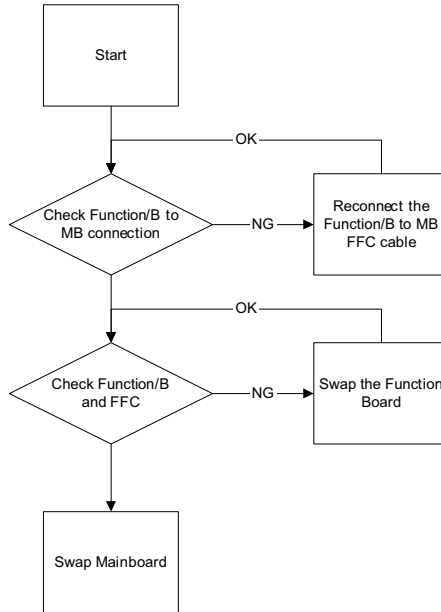

# Media Board Failure

If the **Media Board** fails, perform the following actions one at a time to correct the problem. Do not replace a non-defective FRUs:

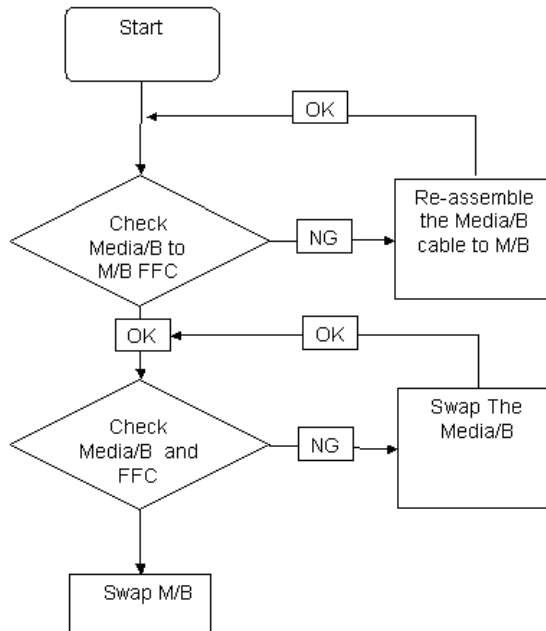

# Fingerprint Reader Failure

If the **Fingerprint Reader** fails, perform the following actions one at a time to correct the problem. Do not replace a non-defective FRUs:

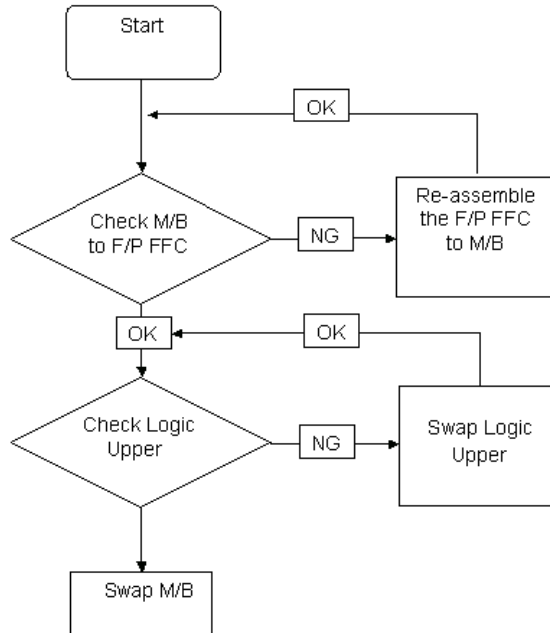

# Thermal Unit Failure

If the **Thermal Unit** fails, perform the following actions one at a time to correct the problem. Do not replace a non-defective FRUs:

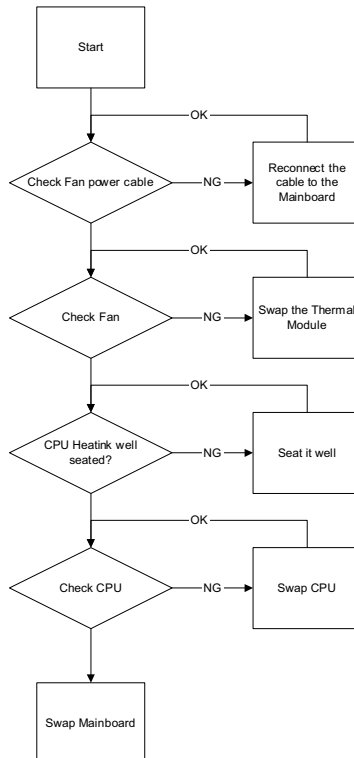

---

## External Mouse Failure

If an external **Mouse** fails, perform the following actions one at a time to correct the problem.

1. Try an alternative mouse.
2. If the mouse uses a wireless connection, insert new batteries and confirm there is a good connection. See the mouse user manual.
3. If the mouse uses a USB connection, try an alternate USB port.
4. Try an alternative program to verify mouse operation. Reinstall the program experiencing mouse failure.
5. Restart the computer.
6. Remove any recently added hardware and associated software.
7. Remove any recently added software and reboot.
8. Restore system and file settings from a known good date using **System Restore**.

If the issue is not fixed, repeat the preceding steps and select an earlier time and date.

9. Run the Event Viewer to check the events log for errors. For more information see Windows Help and Support.
10. Roll back the mouse driver to the previous version if updated recently.
11. Remove and reinstall the mouse driver.
12. Check the Device Manager to determine that:
  - The device is properly installed. There are no red Xs or yellow exclamation marks.
  - There are no device conflicts.
  - No hardware is listed under Other Devices.
13. If the Issue is still not resolved, see "Online Support Information" on page 183.

## Other Failures

If the CRT Switch, Dock, LAN Port, external MIC or Speakers, PCI Express Card, 5-in-1 Card Reader or Volume Wheel fail, perform the following general steps to correct the problem. Do not replace a non-defective FRUs:

1. Check Drive whether is OK.
2. Check Test Fixture is ok.
3. Swap M/B to Try.

---

# Intermittent Problems

Intermittent system hang problems can be caused by a variety of reasons that have nothing to do with a hardware defect, such as: cosmic radiation, electrostatic discharge, or software errors. FRU replacement should be considered only when a recurring problem exists.

When analyzing an intermittent problem, do the following:

1. Run the advanced diagnostic test for the system board in loop mode at least 10 times.
2. If no error is detected, do not replace any FRU.
3. If any error is detected, replace the FRU. Rerun the test to verify that there are no more errors.

# Undetermined Problems

The diagnostic problems does not identify which adapter or device failed, which installed devices are incorrect, whether a short circuit is suspected, or whether the system is inoperative.

Follow these procedures to isolate the failing FRU (do not isolate non-defective FRU).

**NOTE:** Verify that all attached devices are supported by the computer.

**NOTE:** Verify that the power supply being used at the time of the failure is operating correctly. (See “Power On Issue” on page 140.):

1. Power-off the computer.
2. Visually check them for damage. If any problems are found, replace the FRU.
3. Remove or disconnect all of the following devices:
  - Non-Acer devices
  - Printer, mouse, and other external devices
  - Battery pack
  - Hard disk drive
  - DIMM
  - CD-ROM/Diskette drive Module
  - PC Cards
4. Power-on the computer.
5. Determine if the problem has changed.
6. If the problem does not recur, reconnect the removed devices one at a time until you find the failing FRU.
7. If the problem remains, replace the following FRU one at a time. Do not replace a non-defective FRU:
  - System board
  - LCD assembly

---

# POST Codes Tables

These tables describe the POST codes and descriptions during the POST.

## Sec:

NO\_EVICTION\_MODE\_DEBUG EQU 1 (CommonPlatform\sec\ia32\SecCore.inc)

Code	Description
0xC2	MTRR setup
0xC3	Enable cache
0xC4	Establish cache tags
0xC5	Enter NEM, Place the BSP in No Fill mode, set CR0.CD = 1, CR0.NW = 0
0xCF	Cache Init Finished

## Memory:

DEBUG\_BIOS equ 1 (Chipset\Alviso\MemoryInitAsm\IA32\IMEMORY.INC)

Code	Description
0xA0	First memory check point
0x01	Enable MCHBAR
0x02	Check for DRAM initialization interrupt and reset fail
0x03	Verify all DIMMs are DDR3 and unbuffered
0x04	Detect an improper warm reset and handle
0x05	Detect if ECC SO-DIMMs are present in the system
0x06	Verify all DIMMs are single or double sided and not asymmetric
0x07	Verify all DIMMs are x8 or x16 width
0x08	Find a common CAS latency between the DIMMS and the MCH
0x09	Determine the memory frequency and CAS latency to program
0x10	Determine the smallest common TRAS for all DIMMs
0x11	Determine the smallest common TRP for all DIMMs
0x12	Determine the smallest common TRCD for all DIMMs
0x13	Determine the smallest refresh period for all DIMMs
0x14	Verify burst length of 8 is supported by all DIMMs
0x15	Determine the smallest tWR supported by all DIMMs
0x16	Determine DIMM size parameters
0x17	Program the correct system memory frequency
0x18	Determine and set the mode of operation for the memory channels
0x19	Program clock crossing registers
0x20	Disable Fast Dispatch
0x21	Program the DRAM Row Attributes and DRAM Row Boundary registers
0x22	Program the DRAM Bank Architecture register
0x23	Program the DRAM Timing & and DRAM Control registers
0x24	Program ODT
0x25	Perform steps required before memory init
0x26	Program the receive enable reference timing control register Program the DLL Timing Control Registers, RCOMP settings

Code	Description
0x27	Enable DRAM Channel I/O Buffers
0x28	Enable all clocks on populated rows
0x29	Perform JEDEC memory initialization for all memory rows
0x30	Perform steps required after memory init
0x31	Program DRAM throttling and throttling event registers
0x32	Setup DRAM control register for normal operation and enable
0x33	Enable RCOMP
0x34	Clear DRAM initialization bit in the SB
0x35	Initialization Sequence Completed, program graphic clocks
0x43	Program Thermal Throttling

## BDS & Specific action:

Code	Description
0x00	Report the legacy boot is happening
0x12	Wake up the Aps
0x13	Initialize SMM Private Data and relocate BSP SMBASE
0x21	PC init begin at the stage1
0x27	Report every memory range do the hard ware ECC init
0x28	Report status code of every memory range
0x50	Get the root bridge handle
0x51	Notify pci bus driver starts to program the resource
0x58	Reset the host controller
0x5A	IdeBus begin initialization
0x79	Report that the remote terminal is being disabled
0x7A	Report that the remote terminal is being enabled
0x90	Keyboard reset
0x91	USB Keyboard disable
0x92	Keyboard detection
0x93	Report that the usb keyboard is being enabled
0x94	Clear the keyboard buffer
0x95	Init Keyboard
0x98	Mouse reset
0x99	Mouse disable
0x9A	Detect PS2 mouse
0x9B	Report that the mouse is being enabled
0xB8	Peripheral removable media reset (ex: IsaFloppy, USB device)
0xB9	Peripheral removable media disable
0xBB	Peripheral removable media enable
0xE4	Report Status Code here for DXE_ENTRY_POINT once it is available
0xF8	Report that ExitBootServices() has been called
0xF9	Runtime driver set virtual address map



## Each PEIM entry point used in 80\_PORT

Code	Description
0x00	
0x01	PEI_EVENT_LOG
0xA1	PEI_OEM_SERVICE
0xA2	PEI_SIO_INIT
0xA3	PEI_MONO_STATUS_CODE
0xA4	PEI_CPU_IO_PCI_CFG
0x06	PEI_CPU_IO
0x07	PEI_PCI_CFG
0xA5	PEI_CPU_PEIM
0xA6	PEI_PLATFORM_STAGE1
0xA7	PEI_VARIABLE
0xA8	PEI_SB_INIT
0x0C	PEI_CAPSULE
0xAA	PEI_PLATFORM_STAGE2
0xAC	PEI_SB_SMBUS_ARP_DISABLED
0x0F	PEI_HOST_TO_SYSTEM
0x40	PEI_MEMORY_INIT
0x41	PEI_S3_RESUME
0xAD	PEI_CLOCK_GEN
0xAB	PEI_OP_PRESENCE
0xAE	PEI_FIND_FV
0x16	PEI_H2O_DEBUG_IO
0x17	PEI_H2O_DEBUG_COMM
0x16~0x1F	PEI_RESERVED
0x20~0x2E	PEI_OEM_DEFINED
0xAF	PEI_DXE_IPL

## Each Driver entry point used in 80\_PORT

Code	Description
0x30	RESERVED
0xB6	DXE_CRC32_SECTION_EXTRACT
0xB8	SCRIPT_SAVE
0xB9	ACPI_S3_SAVE
0xBA	SMART_TIMER
0xBB	JPEG_DECODER
0xBC	PCX_DECODER
0xBE	HT_CPU / MP_CPU
0xBF	LEGACY_METRONOME
0xC0	FTWLITE
0xC1	RUN_RIME
0xC2	MONOTONIC_COUNTER
0xC3	WATCH_DOG_TIMER

Code	Description
0xC4	SECURITY_STUB
0xC5	DXE_CPU_IO
0xC6	CF9_RESET
0xC7	PC_RTC
0xC8	STATUS_CODE
0xC9	VARIABLE EMU_VARIABLE
0xD9	DXE_CHIPSET_INIT
0x45	DXE_ALERT_FORMAT
0xD6	PCI_HOST_BRIDGE
0xD7	PCI_EXPRESS
0xD5	DXE_SB_INIT
0xDA	IDE_CONTROLLER
0xDB	SATA_CONTROLLER
0xDD	SB_SM_BUS
0xE7	ISA_ACPI_DRIVER
0xE8	ISA_BUS
0xE9	ISA_SERIAL
0xED	BUS_PCI_UNDI
0xEC	PCI_BUS
0xF6	BOOT_PRIORITY
0xF7	FVB_SERVICE
0xF8	ACPI_PLATFORM
0xFB	PCI_HOT_PLUG
0xFC	DXE_PLATFORM
0xFD	PLATFORM_IDE
0x97	SMBIOS
0x98	MEMORY_SUB_CLASS
0x99	MISC_SUB_CLASS
0x82	CON_PLATFORM
0x83	SAVE_MEMORY_CONFIG
0x84	ACPI_SUPPORT
0x85	CON_SPLITTER_UGA_VGA / CON_SPLITTER
0x88	VGA_CLASS
0x89	DATA_HUB
0x60	DISK_IO
0x8B	MEMORY_TEST
0x62	CRISIS_RECOVERY
0x8D	LEGACY_8259
0x8E	LEGACY_REGION
0x8F	LEGACY_INTERRUPT
0x70	BIOS_KEYBOARD
0x71	BIOS_VEDIO

Code	Description
0x72	MONITER_KEY
0x73	LEGACY_BIOS
0x75	LEGACY_BIOS_PLATFORM
0x76	PCI_PLATFORM
0x6C	ISA_FLOOPY
0x6D	PS2_MOUSE
0x6E	USB_BOT
0x6F	USB_CBIO
0x74	USB_MOUSE
0xFA	SETUP_UTILITY
0x90	FW_BLOCK_SERVICE
0x78	SMM_USB_LEGACY
0x86	GRAPHICS_CONSOLE
0x87	TERMINAL
0x8A	DATA_HUB_STD_ERR
0x7C	FAT
0x7D	PARTITION
0x7E	ENGLISH
0x7F	FRENCH
0x9E	HII_DATABASE
0x9F	OEM_SETUP_BROWSER
0x8C	OEM_BADGING_SUPPORT
0xF9	SETUP_MOUSE
0x72	MONITOR_KEY
0xBD	PLATFORM_BDS
0x8D	RESERVED
0x8E	RESERVED
0x8F	RESERVED
0xA0	DXE_H2O_DEBUG_IO
0xB3	DXE_TPM_TCG
0xB4	DXE_TPM_PHYSICAL_PRESENCE
0xB7	DXE_OEM_SERVICE
0x9B	DXE_SECURITY_HDD_PASSWORD_SERVICE
0xA9	DXE_LAN_IDER_CONTROLLER
0x9C	DXE_SECURITY_SYSTEM_PASSWORD_SERVICE
0x9D	DXE_SECURITY_PASSWORD_CONSOLE
0xCB	DXE_DATA_HUB_RECORD_POLICY
0xB5	DXE_TPM_DRIVER
0x11	CHINESE
0xB0	JAPANESE
0xB1	DXE_UNICODE_COLLATION

---

## Each SmmDriver entry point used in 80\_PORT

Code	Description
0xD4	SMM_ACCESS
0xDE	SMM_CONTROL
0xCC	SMM_BASE
0xD2	SMM_RUNTIME
0xDF	SB_SMM_DISPATCH
0xD0	SMM_THUNK
0xCA	SMM_ACPI_SW_CHILD
0xFE	SMM_PLATFORM
0xD8	SMM_GMCH_MBI
0x90	SMM_FW_BLOCK_SERVICE
0x91	SMM_VARIABLE
0x92	SMM_IHISI
0x93	SMM_INT15_MICROCODE
0x94	SMM_PNP
0x95	SMM_INIT_PPM
0xD3	SMM_OEM_SERVICE

# Jumper and Connector Locations

## Top View

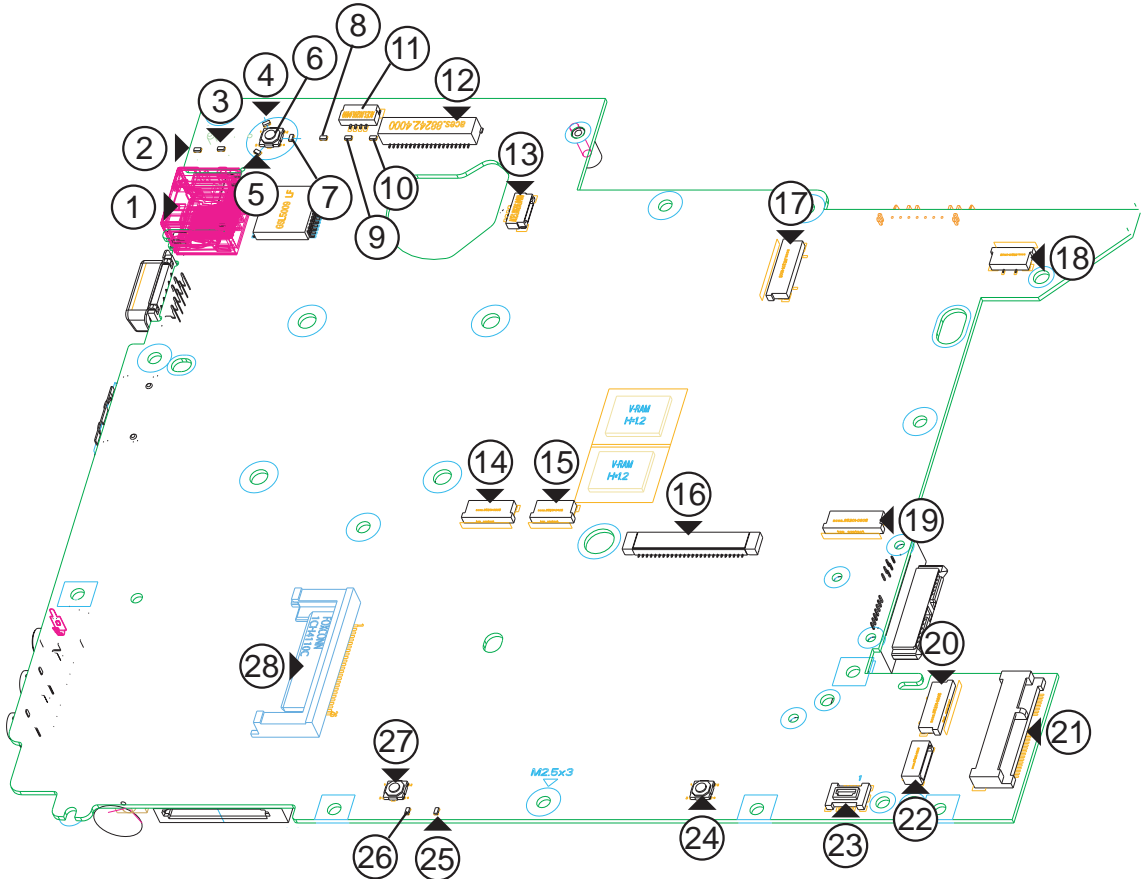

Item	Pin	Description	Item	Pin	Description
1	JPJ1	RJ-45 Connector	15	JP16	FP Board Connector
2	LED5	AC-IN LED	16	JP23	Keyboard Connector
3	LED10	AC-IN-LED	17	JP26	Function Board Connector
4	LED3	ON-OFF LED	18	JP25	e-Key Board Connector
5	LED4	ON-OFF LED	19	JP22	Media Console Connector
6	SW3	Switch	20	JP15	USB Board Connector
7	LED6	ON-OFF LED	21	JMINI1	MiniCard Port
8	LED7	Media LED	22	JP18	Bluetooth Connector
9	LED8	Num LED	23	JMDC1	MDC Connector
10	LED9	Caps LED	24	SW2	Switch
11	JP13	MIC Connector	25	LED2	Battery LED
12	JLVDS1	LVDS Connector	26	LED1	Power LED
13	JP14	Speaker Connector	27	SW1	Switch
14	JP21	TP Board Connector	28	JEXP1	ExpressCard Connector

# Bottom View

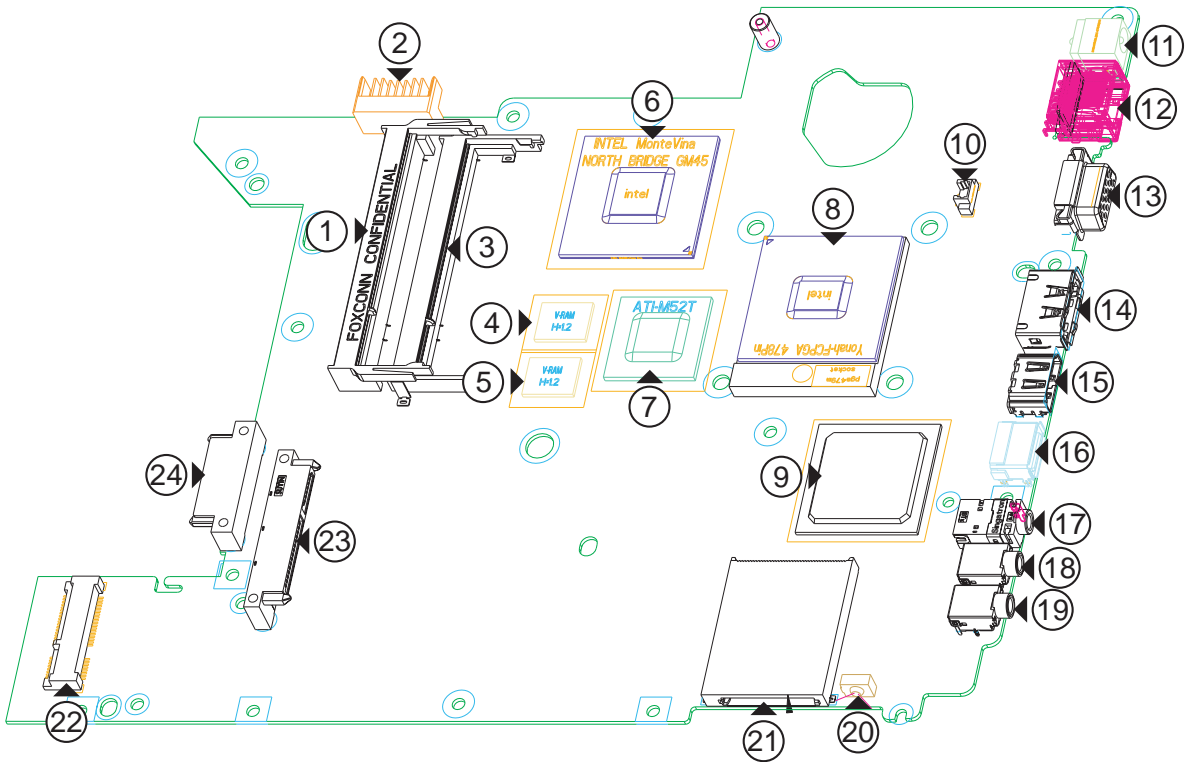

Item	Pin	Description	Item	Pin	Description
1	JDIMM2	DDR3 Socket	13	JCRT1	D-Sub Connector
2	PJP2	Battery Connector	14	JP17	eSATA/USB Port
3	JDIMM1	DDR3 Socket	15	JHDMI1	HDMI Port
4	U11	VRAM Chip	16	JUSB1	USB Port
5	U9	VRAM Chip	17	JHP1	Headphone Jack
6	U2	Northbridge	18	JMIC1	Microphone Jack
7	U17	VGA NB9M	19	JLINE1	Audio-in Jack
8	JCPU1	CPU Socket	20	IR1	Infrared Sensor
9	U23	Southbridge	21	JREAD1	Card Reader
10	JP27	Fan Connector	22	JMINI2	MiniCard Socket
11	PJP3	DC-IN Connector	23	JSATA1	HDD Connector
12	JPJ1	RJ-45 Connector	24	JSATA2	ODD Connector

---

# Clearing Password Check and BIOS Recovery

This section provide you the standard operating procedures of clearing password and BIOS recovery for Aspire 4736G/4736Z Series. Aspire 4736G/4736Z Series provides one Hardware Open Gap on main board for clearing password check, and one Hotkey for enabling BIOS Recovery.

## Clearing Password Check

### Hardware Open Gap Description

Item	Description	Location
R1290	Clear CMOS Jumper	Memory bay



### Steps for Clearing BIOS Password Check

If users set BIOS Password (Supervisor Password and/or User Password) for a security reason, BIOS will ask the password during systems POST or when systems enter to BIOS Setup menu. However, once it is necessary to bypass the password check, users need to short the HW Gap to clear the password by the following steps:

- Power Off a system, and remove HDD, AC and Battery from the machine.
- Open the back cover of the machine, and find out the HW Gap on M/B as picture.
- Use an electric conductivity tool to short the two points of the HW Gap.
- Plug in AC, keep the short condition on the HW Gap, and press Power Button to power on the system till BIOS POST finish. Then remove the tool from the HW Gap.
- Restart system. Press F2 key to enter BIOS Setup menu.
- If there is no Password request, BIOS Password is cleared. Otherwise, please follow the steps and try again.

**NOTE:** The steps are only for clearing BIOS Password (Supervisor Password and User Password).

---

# BIOS Recovery by Crisis Disk

## BIOS Recovery Boot Block:

BIOS Recovery Boot Block is a special block of BIOS. It is used to boot up the system with minimum BIOS initialization. Users can enable this feature to restore the BIOS firmware to a successful one once the previous BIOS flashing process failed.

## BIOS Recovery Hotkey:

The system provides a function hotkey: **Fn+Esc**, for enable BIOS Recovery process when system is powered on during BIOS POST. To use this function, it is strongly recommended to have the AC adapter and Battery present. If this function is enabled, the system will force the BIOS to enter a special BIOS block, called Boot Block.

## Steps for BIOS Recovery by Crisis Disk:

Before doing this, one Crisis Disk should be prepared ready in hand. The Crisis Disk could be made by executing the Crisis Disk program in another system with Windows XP OS.

Follow the steps below:

1. Power Off failed system.
2. Attach a USB floppy drive to the failed system.
3. Insert the Crisis Disk in to the USB floppy drive attached to the BIOS flash failed system.
4. In the power-off state, press and hold **Fn+Esc** then press the Power button.

The system powers on and the Crisis BIOS Recovery process begins.

BIOS Boot Block begins restoring the BIOS code from the Crisis floppy disk to BIOS ROM on the failed systems.

When the Crisis flash process is finished, the system restarts with a workable BIOS.

5. Update to the latest version BIOS for the system using the regular BIOS flashing process.



## FRU (Field Replaceable Unit) List

---

This chapter gives you the FRU (Field Replaceable Unit) listing in global configurations of Aspire 4736G/4736Z Series. Refer to this chapter whenever ordering for parts to repair or for RMA (Return Merchandise Authorization).

Please note that WHEN ORDERING FRU PARTS, you should check the most up-to-date information available on your regional web or channel. For whatever reasons a part number change is made, it will not be noted on the printed Service Guide. For ACER AUTHORIZED SERVICE PROVIDERS, your Acer office may have a DIFFERENT part number code from those given in the FRU list of this printed Service Guide. You MUST use the local FRU list provided by your regional Acer office to order FRU parts for repair and service of customer machines.

**NOTE:** To scrap or to return the defective parts, you should follow the local government ordinance or regulations on how to dispose it properly, or follow the rules set by your regional Acer office on how to return it.

# Aspire 4736G/4736Z Series Exploded Diagrams

## Main Module

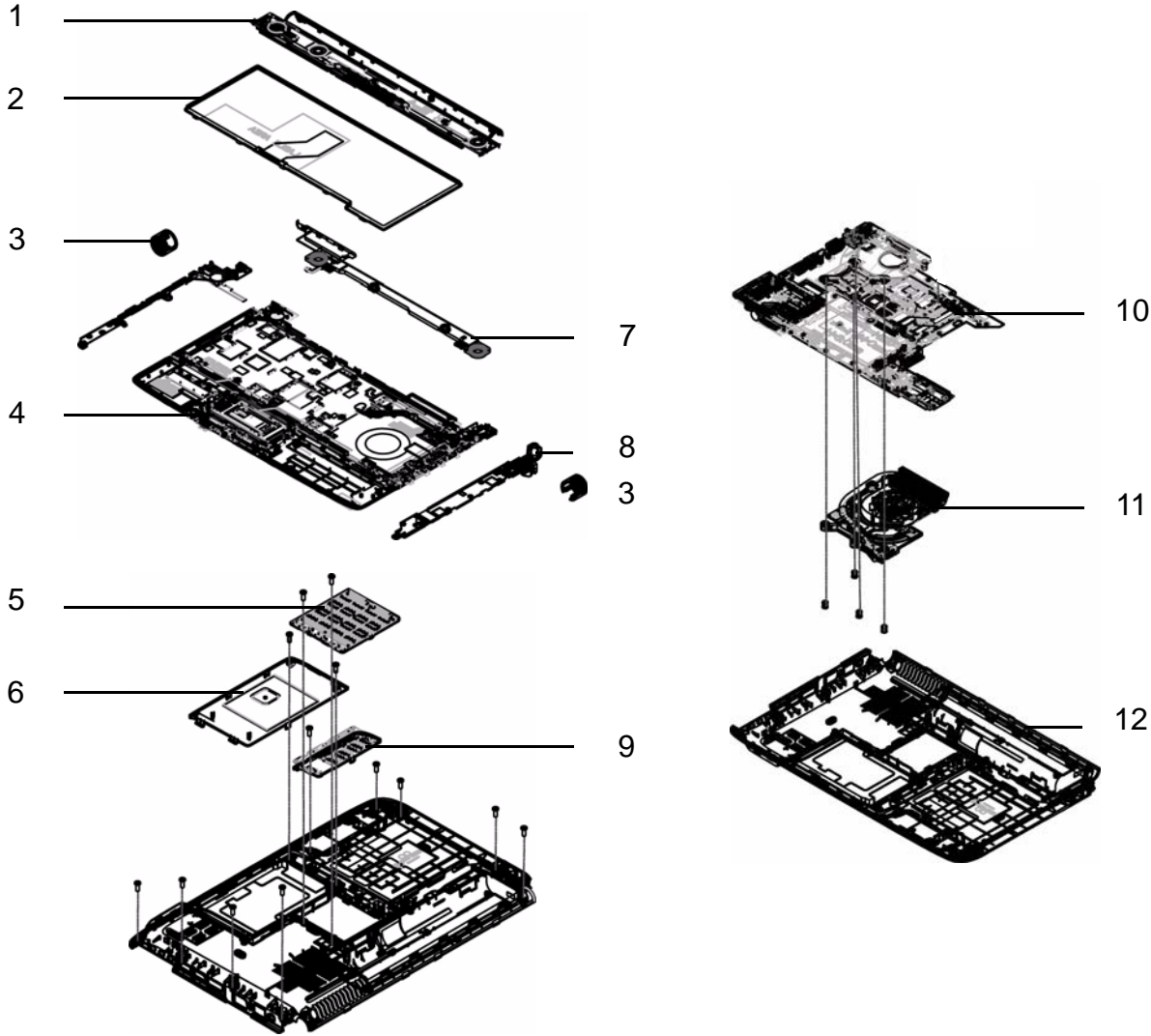

Item	Description	Part No.	Item	Description	Part No.
1	Switch Cover	60.AD302.001	8	Media Board	55.AD302.003
2	Keyboard	KB.INT00.261	9	Mini Door	42.AD302.006
3	Hinge Cover Left and Right	42.AD302.003	10	Mainboard	MB.AD302.001
4	Upper Cover	60.AC602.001	11	Thermal Module	60.AC702.001
5	Memory Door	42.AD302.005	12	Lower Cover	60.AD302.003
6	HDD Door	42.AD302.004			
7	Speaker	23.AD302.001			

# Aspire 4736G/4736Z Series FRU List

Category	Description	Acer P/N
<b>Adapter</b>		
	ADAPTER 65W 3PIN DELTA SADP-65KB DFJ	AP.06501.022
	ADAPTER 65W 3PIN DELTA SADP-65KB BFJG OBL	AP.06501.023
	ADAPTER 65W 3PIN HIPRO AC-OK065B13	AP.0650A.011
	ADAPTER 90W 3PIN DELTA ADP-90SB BBGF	AP.09001.023
	ADAPTER 90W 3PIN DELTA ADP-90SB BBGE OBL	AP.09001.024
	ADAPTER 90W 3PIN HIPRO AC-OL093B13P	AP.0900A.004
<b>Battery</b>		
	BATTERY LI-ION 6CELL 4.4KMAH SANYO SA 3S2P	BT.00603.041
	BATTERY LI-ION 6CELL 4.4KMAH SONY SY SY 3S2P	TBD
	BATTERY LI-ION 6CELL 4.4KMAH PANASONIC PA PA 3S2P	TBD
	BATTERY LI-ION 6CELL 4.4KAH SIMPRO SP LG 3S2P	TBD
	BATTERY LI-ION 6CELL 4.4KAH SIMPLO SP PA 3S2P	TBD
	BATTERY LI-ION 6CELL 4.4KAH SIMPRO SP SM 3S2P	TBD
<b>Board</b>		
	FINGER PRINT BOARD	55.AC602.001
	MEDIA BOARD	55.AD302.003
	USB BOARD	55.AD302.004
	BLUE TOOTH	BT.21100.002
	MODEM	FX.22500.025
	W/L CARD INTEL 1X2 512AN_MMWG SIN/PHI FCC/IC	KI.SPM01.003
	W/L CARD INTEL 1X2 512AN_MMWG 150 FCC/IC	KI.SPM01.003
	W/L CARD INTEL 3X3 533AN_MMWG SIN/PHI FCC/IC	KI.SPM01.001
	W/L CARD INTEL 3X3 533AN_MMWG FCC/IC	KI.SPM01.001
	W/L CARD RT2700E RALINK	NI.23600.031
	W/L CARD XB91 Atheros	NI.23600.030
<b>Cable</b>		

Category	Description	Acer P/N
	BLUETOOTH CABLE	50.AD302.001
	RJ11 CABLE	50.AD302.002
	TP FFC	50.AD302.003
<b>Case/Cover/Bracket Assembly</b>		
	STRIP COVER	60.AD302.001
	UPPER CASE ASSY W/FP	60.AC602.001
	UPPER CASE ASSY W/O FP	60.AD302.002
	LOWER CASE ASSY FOR W/HDMI	60.AD302.003
	MEDIA CONSOLE MYLAR	42.AD302.001
	MEDIA BACK LIGHT	42.AD302.002
	FP BRACKET	33.AD302.001
	TP BRACKET	33.AD302.002





Category	Description	Acer P/N
	HINGE CAP R&L	42.AD302.003
	HDD DOOR	42.AD302.004
	RAM DOOR	42.AD302.005
	MINI DOOR	42.AD302.006
<b>CPU/Processor</b>		
	CPU INTEL P8400 2.26G AW80577SH0513M SLB3R M0	KC.84001.DPP
	CPU INTEL P8600 2.4G AW80577SH0563M SLB3S M0	KC.86001.DPP
	CPU INTEL P9500 2.53G AW80576SH0616M SLB4E C0	KC.95001.DPP
	CPU INTEL P7350 2G AW80577SH0413M SLB53 M0	KC.73501.DPP
	CPU INTEL T9400 2.53G AW80576GH0616M SLB46 C0	KC.94001.DTP
	CPU INTEL T9600 2.8G AW80576GH0726M SLB47 C0	KC.96001.DTP
	CPU INTEL T5900 2.2G LF80537GG049F SLB6D M0	KC.59001.DTP
	CPU INTEL T5800 2.0G LF80537GG041F SLB6E M0	KC.58001.DTP
<b>Combo Drive</b>		
	DVD/CDRW COMBO DRIVE MODULE	6M.AD302.001
	DVD/CDRW COMBO DRIVE TS-L463A TOSHIBA	KO.02401.006
	DVD/CDRW COMBO DRIVE CRX890S SONY	KO.0240E.009
	ODD BEZEL-COMBO	42.AD302.007
	ODD BRACKET	33.AD302.003
<b>Super Multi Drive</b>		

Category	Description	Acer P/N
	DVD SUPER MULTI DRIVE MODULE	6M.AD302.002
	DVD SUPER MULTI DRIVE TS-L633A TSST	KU.00801.021
	DVD SUPER MULTI DRIVE GT10N HLDS	KU.0080D.039
	DVD SUPER MULTI DRIVE DS-8A2S PLDS	KU.0080F.001
	DVD SUPER MULTI DRIVE AD-7580S SONY	KU.0080E.017
	ODD BEZEL-SUPER MULTI	42.AD302.008
	ODD BRACKET	33.AD302.003
<b>Blueray Combo</b>		
	BR-DVD SUPER MULTI DRIVE MODULE	6M.AD302.003
	BR-DVD DRIVE DS-4E1S PLDS	KO.0020F.001
	BR-DVD DRIVE BC-5500S SONY	KO.0020E.002
	BR-DVD DRIVE CT10N HITACHI	KO.0020D.001
	ODD BEZEL-BR DVD	42.AD302.009
	ODD BRACKET	33.AD302.003
<b>HDD</b>		
	HDD SATA 160G 5400RPM HGST HTS543216L9A300	KH.16007.019
	HDD SATA 160G 5400RPM TOSHIBA MK1652GSX	TBD
	HDD SATA 160G 5400RPM SEAGATE ST9160310AS	KH.16001.034
	HDD SATA 160G 5400RPM WD WD1600BEVT-22ZCT0	KH.16008.022
	HDD SATA 250G 5400RPM HGST HTS543225L9A300	KH.25007.013
	HDD SATA 250G 5400RPM TOSHIBA MK2552GSX	KH.25004.002
	HDD SATA 250G 5400RPM WD WD2500BEVT-22ZCT0	KH.25008.021
	HDD SATA 250G 5400RPM SEAGATE ST9250827AS	KH.25001.011
	HDD SATA 320G 5400RPM HGST HTS543232L9A300	KH.32007.004
	HDD SATA 320G 5400RPM TOSHIBA MK3252GSX	KH.32004.001
	HDD SATA 320G 5400RPM SEAGATE ST9320320AS	KH.32001.008
	HDD SATA 320G 5400RPM WD WD3200BEVT-22ZCT0	KH.32008.013

Category	Description	Acer P/N
	HDD BRACKET	33.AD302.004
<b>Keyboard</b>		
	KEYBOARD INTE(UI)	KB.INT00.261
	KEYBOARD (GK) GREEK	KB.INT00.282
	KEYBOARD (ARE) ARABIC ENGLISH	KB.INT00.293
	KEYBOARD (CH) T-CHINESE	KB.INT00.289
	KEYBOARD (KO) KOREAN	KB.INT00.276
	KEYBOARD (RU) RUSSIAN	KB.INT00.271
	KEYBOARD (TI) THAILAND	KB.INT00.265
	KEYBOARD (HB) HEBREW	KB.INT00.262
	KEYBOARD UK	KB.INT00.263
	KEYBOARD (GR) GERMAN	KB.INT00.283
	KEYBOARD (SW) SWITZERLAND	KB.INT00.266
	KEYBOARD (CF) CANADIAN FRENCH	KB.INT00.290
	KEYBOARD (BE) BELGIAN	KB.INT00.292
	KEYBOARD (DM) DENMARK	KB.INT00.287
	KEYBOARD (IT) ITALIAN	KB.INT00.278
	KEYBOARD (FR) FRENCH	KB.INT00.284
	KEYBOARD (HG) HUNGARY	KB.INT00.281
	KEYBOARD (NW) NORWEGIAN	KB.INT00.274
	KEYBOARD (PO) PORTUGUESE	KB.INT00.272
	KEYBOARD (SP) SPANISH	KB.INT00.268
KEYBOARD (TR) TURKISH	KB.INT00.264	
KEYBOARD (SD) SWEDISH	KB.INT00.267	
KEYBOARD (SA/CR) SLOVENIAN	KB.INT00.270	
KEYBOARD (NL) NETHERLANDS	KB.INT00.286	
	KEYBOARD (ND) SCANDINAVIAN	KB.INT00.295
	KEYBOARD (AR/FR) ARABIC/FRENCH	KB.INT00.294
	KEYBOARD (CB) CANADIAN BILINGUAL	KB.INT00.296
	KEYBOARD (SV) SLOVAK	KB.INT00.269
	KEYBOARD (BZ) BRAZILIAN	KB.INT00.291
	KEYBOARD (CZ/SK) CZECH-SLOVAKIAN	KB.I1400.001
	KEYBOARD JA	KB.INT00.277
<b>LCD</b>		

Category	Description	Acer P/N
	ASSY LCD MODULE 14.1 IN. WXGA GLARE W/ ANTENNA CCD	6M.AD302.004
	LED PANEL 14 AUO B140XW01 V0	LK.14005.006
	LED PANEL 14 CMO N140B6-L02	LK.1400D.004
	LED PANEL 14 LPL LP140WH1-TLA1	LK.14008.001
	LED PANEL 14 SEC LTN140AT01-G01	LK.14006.009
	LVDS CABLE	50.AD302.004
	LCD BRACKET R&L	33.AD302.005
	LCD BEZEL	60.AD302.005
	LCD COVER-IMR	60.AD302.006
	ANTENNA R-1X2	50.AD302.005
	ANTENNA R-3X3	50.AD302.006
	ANTENNA L	50.AD302.007
	CAMERA 1.0	57.AD302.001
	CAMERA BRACKET	33.AD302.006
<b>Mainboard</b>		
	MB ASSY W/O CPU/RAM-UMA	MB.AD302.001
	MB ASSY 256MB W/O CPU/RAM-DIS	TBD
	MB ASSY 512MB W/O CPU/RAM-DIS	MB.AC902.001



Category	Description	Acer P/N
<b>Memory</b>		
	RAM 512M DDRII 667 SAMSUNG M470T6464QZ3-CE6	KN.5120B.026
	RAM 512M DDRII 667 HYNIX HYMP164S64CP6-Y5	KN.5120G.024
	RAM 1G DDRII 667 NANYA NT1GT64UH8D0FN-3C	KN.1GB03.026
	RAM 1G DDRII 667 SAMSUNG M470T2864QZ3-CE6	KN.1GB0B.016
	RAM 1G DDRII 667 ELPIDA EBE11UE6ACUA-6E-E	KN.1GB09.008
	RAM 1G DDRII 667 HYNIX HYMP112S64CP6-Y5	KN.1GB0G.012
	RAM 2G DDRII 667 HYNIX HYMP125S64CP8-Y5	KN.2GB0G.004
	RAM 2G DDRII 667 SAMSUNG M470T5663QZ3-CE6	KN.2GB0B.003
	RAM 2G DDRII 667 NANYA NT2GT64U8HD0BN-3C	KN.2GB03.011
	RAM 2G DDRII 667 ELPIDA EBE21UE8ACUA-6E-E	KN.2GB09.001
<b>Heatsink</b>		
	CPU THERMAL MODULE-DIS	60.AC702.001
	CPU THERMAL MODULE-UMA	60.AD302.007
<b>Speaker</b>		
	SPEAKER	23.AD302.001
	DIGITAL MIC	23.AD302.002
<b>Miscellaneous</b>		
	NAME PLATE-AS4935	47.AD302.001

## Screw List

Category	Description	Acer P/N.
<b>Screw</b>		
	SCREW M2.0D 3.0L K4.6D 0.8T ZK	86.AD302.001
	SCREW M 2.5D 3.0L K5.5D 0.8T ZK	86.AD302.002
	SCREW M 2.5D 5L K 5.5D ZK NL	86.AD302.003
	SCREW M2.5D 10.0L K 5.5D 0.8T ZK	86.AD302.004
	SCREW M M 3.0D 3.0L K 4.9D NI+	86.AD302.005
	SCREW M M 2.5D 3.2L K 6D NI+	86.AD302.006

# Model Definition and Configuration

---

## Aspire 4736G/4736Z Series

# Test Compatible Components

---

This computer's compatibility is tested and verified by Acer's internal testing department. All of its system functions are tested under Windows® XP Home, Windows® XP Pro environment.

Refer to the following lists for components, adapter cards, and peripherals which have passed these tests. Regarding configuration, combination and test procedures, please refer to the Aspire 4736G/4736Z Series Compatibility Test Report released by the Acer Mobile System Testing Department.

# Microsoft® Windows® Vista Environment Test

Vendor	Type	Description
<b>Adapter</b>		
10001081 DELTA	65W	Adapter DELTA 65W 19V 1.7x5.5x11 Yellow SADP-65KB DFJ LED LF
10001081 DELTA	65W	Adapter DELTA 65W 19V 1.7x5.5x11 Yellow SADP-65KB BFJG LED LF
60002015 HIPRO	65W	Adapter HIPRO 65W 19V 1.7x5.5x11 Yellow HP-OK065B13 LV4 (for flicker issue) LED LF
10001081 DELTA	90W	Adapter DELTA 90W 19V 1.7x5.5x11 Blue ADP-90SB BBEA LV4 (for flicker issue) LED LF
10001081 DELTA	90W	Adapter DELTA 90W 19V 1.7x5.5x11 Blue ADP-90SB BBEN LV4, for OBL (for flicker issue) LED LF
60002015 HIPRO	90W	Adapter HIPRO 90W 19V 1.7x5.5x11 Blue HP-OL093B13P LV4 (for flicker issue) LED LF
<b>Audio Codec</b>		
9999995 ONE TIME VENDER	ALC268	ALC268
9999995 ONE TIME VENDER	ALC888S	ALC888S
<b>Battery</b>		
10001063 SONY	6CELL2.2	Battery SONY AS-2007A Li-Ion 3S2P SONY 6 cell 4400mAh Main COMMON Normal Type
60001535 PANASONIC	6CELL2.2	Battery PANASONIC AS-2007A Li-Ion 3S2P PANASONIC 6 cell 4400mAh Main COMMON PSS
60002162 SIMPLO	6CELL2.2	Battery SIMPLO AS-2007A Li-Ion 3S2P PANASONIC 6 cell 4400mAh Main COMMON PSS
60002162 SIMPLO	6CELL2.2	Battery SIMPLO AS-2007A Li-Ion 3S2P LGC 6 cell 2150mAh 2nd COMMON
60001921 SANYO	6CELL2.2	Battery SANYO AS-2007A Li-Ion 3S2P SANYO 6 cell 4400mAh Main COMMON Normal Type
60002162 SIMPLO	6CELL2.2	Battery SIMPLO AS-2007A Li-Ion 3S2P SAMSUNG 6 cell 4400mAh Main COMMON SDI 2.2mAh F type
<b>Bluetooth</b>		
9999995 ONE TIME VENDER	BT 2.0	Foxconn FOX_BRM_2.0
<b>Camera</b>		
9999995 ONE TIME VENDER	1.0M DV	Suyin Camera 1.0M DV Tulip
<b>Card Reader</b>		
9999995 ONE TIME VENDER	6 in 1-Build in	6 in 1-Build in MS, MS Pro, SD, SC, XD, SDIO (For all)
<b>CPU</b>		
10001067 INTEL	C2DP9500	CPU Intel Core2Dual P9500 PGA 2.53G 6M 1066 25W

Vendor	Type	Description
10001067 INTEL	C2DT5800	CPU Intel Core2Dual T5800 PGA 2.0G 2M 800 MV, TJ, noVT
10001067 INTEL	C2DT5900	CPU Intel Core2Dual T5900 PGA 2.2G 2M 800 MV, TJ, noVT
10001067 INTEL	C2DP8400	CPU Intel Core2Dual P8400 PGA 2.26G 3M 1066 25W
10001067 INTEL	C2DP8600	CPU Intel Core2Dual P8600 PGA 2.4G 1066 25W 3M
10001067 INTEL	C2DT9400	CPU Intel Core2Dual T9400 PGA 2.53G 6M 1066 35W
10001067 INTEL	C2DT9600	CPU Intel Core2Dual T9600 PGA 2.8G 6M 1066 35W
10001067 INTEL	C2DP7350	CPU Intel Core2Dual P7350 PGA 2.0G 3M 1066 25W
10001067 INTEL	C2DP7450	CPU Intel Core2Dual P7450 PGA 2.13G 3M 1066 TJ, noVT
10001067 INTEL	C2DT9550	CPU Intel Core2Dual T9550 PGA 2.66G 6M 1066 35W E-0
10001067 INTEL	C2DT6400	CPU Intel Core2Dual T6400 PGA 2.0G 3M 800 35W R-0
10001067 INTEL	C2DT6600	CPU Intel Core2Dual T6600 PGA 2.2G 2M 800 35W R-0
10001067 INTEL	C2DP8700	CPU Intel Core2Dual P8700 PGA 2.53G 3M 1066 25W R-0
10001067 INTEL	C2DP8600	CPU Intel Core2Dual P8600 PGA 2.4G 3M 1066 25W R-0
10001067 INTEL	C2DP8400	CPU Intel Core2Dual P8400 PGA 2.26G 3M 1066 25W R-0
<b>Finger Print Reader</b>		
9999995 ONE TIME VENDER	AES1610	Authentec AES1610
<b>HDD</b>		
60002036 SEAGATE	N160GB5.4KS	HDD SEAGATE 2.5" 5400rpm 160GB ST9160310AS Crockett SATA LF F/W:0303
60001922 TOSHIBA DIGI	N160GB5.4KS	HDD TOSHIBA 2.5" 5400rpm 160GB MK1652GSX Virgo - BS SATA LF F/W:LV010J
60002005 HGST SG	N160GB5.4KS	HDD HGST 2.5" 5400rpm 160GB HTS543216L9A300 Falcon-B SATA LF F/W:C40C
60001994 WD	N160GB5.4KS	HDD WD 2.5" 5400rpm 160GB WD1600BEVT-22ZCTO ML160 SATA LF F/W:11.01A11
60002036 SEAGATE	N250GB5.4KS	HDD SEAGATE 2.5" 5400rpm 250GB ST9250827AS Corsair SATA LF F/W:3.AAA
60001922 TOSHIBA DIGI	N250GB5.4KS	HDD TOSHIBA 2.5" 5400rpm 250GB MK2552GSX Virgo BS SATA LF F/W:LV010J
60002005 HGST SG	N250GB5.4KS	HDD HGST 2.5" 5400rpm 250GB HTS543225L9A300 Falcon-B SATA LF F/W:C40C

Vendor	Type	Description
60001994 WD	N250GB5.4KS	HDD WD 2.5" 5400rpm 250GB WD2500BEVT-22ZCT0 ML160 SATA LF F/W:11.01A11
60002036 SEAGATE	N320GB5.4KS	HDD SEAGATE 2.5" 5400rpm 320GB ST9320320AS Crockett SATA LF F/W:0303
60001922 TOSHIBA DIGI	N320GB5.4KS	HDD TOSHIBA 2.5" 5400rpm 320GB MK3252GSX Virgo BS SATA LF F/W:LV010J
60002005 HGST SG	N320GB5.4KS	HDD HGST 2.5" 5400rpm 320GB HTS543232L9A300 Falcon-B SATA LF F/W:C40C
60001994 WD	N320GB5.4KS	HDD WD 2.5" 5400rpm 320GB WD3200BEVT-22ZCT0 ML160 SATA LF F/W:11.01A11
60002036 SEAGATE	N500GB5.4KS	HDD SEAGATE 2.5" 5400rpm 500GB ST9500325AS Wyatt SATA LF F/W:0001SDM1
60001994 WD	N500GB5.4KS	HDD WD 2.5" 5400rpm 500GB WD5000BEVT-22ZAT0 ML250 SATA LF F/W:01.01A01
<b>Keyboard</b>		
820123 DARFON	15_16KB-FV1	Keyboard 15_16KB-FV1 Kilimanjaro Standard Black (Glossy)
<b>LAN</b>		
9999995 ONE TIME VENDER	AR8121	Atheros Lan AR8121
<b>LCD</b>		
60003316 AUO	NLED14WXGAG	LED LCD AUO 14" WXGA Glare B140XW01 V0 0A LF 220nit 8ms 500:1
60002215 SAMSUNG	NLED14WXGAG	LED LCD SAMSUNG 14" WXGA Glare LTN140AT01-G01 LF 220nit 8ms 500:1
60003089 LG	NLED14WXGAG	LED LCD LPL 14" WXGA Glare LP140WH1-TLA1 LF 220nit 8ms 500:1
10001038 CMO	NLED14WXGAG	LED LCD CMO 14" WXGA Glare N140B6-L02 LF 220nit 8ms 400:1
<b>Memory</b>		
60001993 NANYA	SO1GBII6	Memory NANYA SO-DIMM DDRII 667 1GB NT1GT64UH8DOFN-3C LF 64*16 0.07um
60002214 ELPIDA	SO1GBII6	Memory ELPIDA SO-DIMM DDRII 667 1GB EBE11UE6ACUA-6E-E LF 64*16 0.065um
60002215 SAMSUNG	SO1GBII6	Memory SAMSUNG SO-DIMM DDRII 667 1GB M470T2864QZ3-CE6 LF
60002045 HYNIX	SO1GBII6	Memory HYNIX SO-DIMM DDRII 667 1GB HYMP112S64CP6-Y5 LF
60001993 NANYA	SO2GBII6	Memory NANYA SO-DIMM DDRII 667 2GB NT2GT64U8HD0BN-3C LF 128*8 0.07um
60002214 ELPIDA	SO2GBII6	Memory ELPIDA SO-DIMM DDRII 667 2GB EBE21UE8ACUA-6E-E LF 128*8 0.07um
60002215 SAMSUNG	SO2GBII6	Memory SAMSUNG SO-DIMM DDRII 667 2GB M470T5663QZ3-CE6 LF
60002045 HYNIX	SO2GBII6	Memory HYNIX SO-DIMM DDRII 667 2GB HYMP125S64CP8-Y5 LF

Vendor	Type	Description
<b>Modem</b>		
23707801 FOXCONN TW	Fox+Con MC4Z 1.5_3.3V Aus	Foxconn Conexant -Unizion 1.5_3.3v AUS T60M955.0x
<b>Norhtbridge</b>		
10001067 INTEL	PM45	NB Chipset Intel CS PM45NB
10001067 INTEL	GM45	NB Chipset Intel CS GM45NB
<b>ODD</b>		
610105 HLDS	NBDCB2XS	ODD HLDS BD COMBO 12.7mm Tray DL 2X CT10N LF W/ O bezel SATA
10001063 SONY	NBDCB2XS	ODD SONY BD COMBO 12.7mm Tray DL 2X BC-5500S LF W/O bezel SATA
10001070 PHILIPS	NBDCB2XS	ODD PLDS BD COMBO 12.7mm Tray DL 2X DS-4E1S LF W/O bezel SATA
60001922 TOSHIBA DIGI	NSM8XS	ODD TOSHIBA Super-Multi DRIVE 12.7mm Tray DL 8X TS- L633A LF W/O bezel SATA
610105 HLDS	NSM8XS	ODD HLDS Super-Multi DRIVE 12.7mm Tray DL 8X GT10N LF W/O bezel SATA
10001063 SONY	NSM8XS	ODD SONY Super-Multi DRIVE 12.7mm Tray DL 8X AD- 7580S LF W/O bezel SATA
10001070 PHILIPS	NSM8XS	ODD PLDS Super-Multi DRIVE 12.7mm Tray DL 8X DS- 8A2S LF W/O bezel SATA
<b>Remote Control</b>		
10001074 FORMOSA	RC804V-B	Formosa21 Remote Controller RC804V-B EN
9999995 ONE TIME VENDER	RC803V	Fomosa21 RC803V For Vista
10001074 FORMOSA	RC804V-B	Fomosa21 Remote Controller RC804V-B EU
10001074 FORMOSA	RC804V-B	Formosa21 Remote Controller RC804V-B TC
10001074 FORMOSA	RC804V-B	Formosa21 Remote Controller RC804V-B SC
<b>Southbridge</b>		
10001067 INTEL	ICH9M	SB Chipset Intel CS ICH9M
<b>Software</b>		
10000981 MISC	McAfee	Antivirus application McAfee
<b>VGA Chip</b>		
60001915 NVIDIA	10MGE1HM	NVIDIA 10MGE1HM w/ HDCP
<b>VoIP Phone</b>		
10000286 WISTRON	BT VoIP Xpress	Wistron Acer Xpress Card Phone Kit Rev 2.0

Vendor	Type	Description
<b>VRAM</b>		
10000981 MISC	256M-GD2	ODM 256M-GD2 256M GDDR3
10000981 MISC	256M-DDR3 (32*16*4)	256M-DDR3 32*16*4
10000981 MISC	512M-DDR3 (64*16*4)	512M-DDR3 64*16*4
<b>WLAN</b>		
10001067 INTEL	SP3x3MMW	Lan Intel WLAN 533AN_MMWG Shirley Peak MM#895362
10001067 INTEL	SP1x2MMW	Lan Intel WLAN 512AN_MMWG Shirley Peak 5100 MM#895361
10001067 INTEL	SP1x2MMW	Lan Intel WLAN 512AN_MMWG Shirley Peak 5100 non- FCC/IC
10001067 INTEL	SP3x3MMW	Lan Intel WLAN 533AN_MMWG Shirley Peak 5300 non- FCC/IC
9999995 ONE TIME VENDER	3rd WiFi 1x2 BGN	Foxconn Wireless LAN Atheros AR5B91 1x2 BGN
9999995 ONE TIME VENDER	3rd WiFi 1x2 BGN	Foxconn Wireless LAN Wireless LAN Ralink RT2700E 1x2 BGN



# Online Support Information

---

This section describes online technical support services available to help you repair your Acer Systems.

If you are a distributor, dealer, ASP or TPM, please refer your technical queries to your local Acer branch office. Acer Branch Offices and Regional Business Units may access our website. However some information sources will require a user i.d. and password. These can be obtained directly from Acer CSD Taiwan.

Acer's Website offers you convenient and valuable support resources whenever you need them.

In the Technical Information section you can download information on all of Acer's Notebook, Desktop and Server models including:

- Service guides for all models
- User's manuals
- Training materials
- Bios updates
- Software utilities
- Spare parts lists
- TABs (Technical Announcement Bulletin)

For these purposes, we have included an Acrobat File to facilitate the problem-free downloading of our technical material.

Also contained on this website are:

- Detailed information on Acer's International Traveler's Warranty (ITW)
- Returned material authorization procedures
- An overview of all the support services we offer, accompanied by a list of telephone, fax and email contacts for all your technical queries.

We are always looking for ways to optimize and improve our services, so if you have any suggestions or comments, please do not hesitate to communicate these to us.



**A**

Antennas 102

**B**

Battery Pack 52

BIOS Utility 29–39

    Advanced 32

    Boot 37

    Exit 38

    Navigating 29

    Power 35

    Save and Exit 38

    Security 32

    System Security 38

Bluetooth module 87

Board Layout

    Top View 163

brightness

    hotkeys 14

**C**

Camera Module 98

caps lock

    on indicator 10

Common Problems 140

computer

    on indicator 10

CPU 94

**D**

DIMM Module 57

Display 4

display

    hotkeys 14

**E**

EasyTouch Failure 153

Euro 15

External Module Disassembly

    Flowchart 51

**F**

Features 1

Fingerprint Reader Failure 154

FLASH Utility 39

Flash Utility 39

FPC Cable 101

FRU (Field Replaceable Unit) List 167

**H**

Hard Disk Drive Module 58

Hibernation mode

    hotkey 14

Hinge Covers 64

Hot Keys 12

**I**

Indicators 10

Intermittent Problems 156

Internal Microphone Failure 146

Internal Speaker Failure 144

**J**

Jumper and Connector Locations 163

    Top View 163

**K**

Keyboard 67

Keyboard Failure 143

**L**

LCD Bezel 96

LCD Brackets 101

LCD Failure 143

LCD Module Disassembly

    Flowchart 95

LCD Panel 99

lower cover 54

**M**

Main Unit Disassembly

    Flowchart 62

---

Mainboard 88  
media access  
    on indicator 10  
MediaTouch Button Failure 153  
Memory Check 140  
MIC Module 103  
Model Definition 176  
Modem Module 86

## **N**

No Display Issue 141  
Notebook Manager  
    hotkey 14  
num lock  
    on indicator 10

## **O**

Online Support Information 183  
optical drive module 60

## **P**

Panel 5  
    Bottom 9  
    left 5  
PC Card 10  
Power On Failure 140

## **S**

speakers  
    hotkey 14  
System  
    Block Diagram 4

## **T**

Test Compatible Components 177  
Thermal Unit Failure 154  
Top 163  
touchpad  
    hotkey 14  
Touchpad Failure 144  
Troubleshooting  
    Built-in KB Failure 143  
    EasyTouch Buttons 153  
    Fingerprint Reader 154

Internal Microphone 146  
Internal Speakers 144  
LCD Failure 143  
MediTouch Buttons 153  
No Display 141  
Other Failures 155  
Power On 140  
Thermal Unit 154  
Touchpad 144  
USB 151  
WLAN 152

## **U**

Undetermined Problems 156  
USB Failure (Rightside) 151  
utility  
    BIOS 29–39

## **W**

Windows 2000 Environment Test 178  
Wireless Function Failure 152